

September 2023 PEM update

Robert Schofield, Anamaria Effler, Sheila Dwyer, Jane Glanzer, Adrian Helmling-Cornell, Georgia Mansell, Filiberto Clara, Richard McCarthy, Benjamin Mannix

Photograph lit by scattered main beam light during high-sensitivity operation **LIGO-G2301888**

- 1) 03-04 vibration coupling reduction projects successful**
- 2) Does vibration coupling tend to increase with main laser power?**
- 3) PEM injections successfully completed before 04 run at LLO, and at LHO at 75W – redo's after LHO power drop to 60W almost complete.**
- 4) Low vibration coupling at LHO and LLO Filter Cavity End Stations.**
- 5) New electronic grounding noise injection technique reveals grounding problems.**
- 6) There is a non-zero TM bias that minimizes electronic ground noise coupling.**
- 7) Arm Cavity Baffle identified as scattering source at LLO, hanging problems corrected.**
- 8) HVAC shutdown, LHO, increases range by about 10Mpc, HVAC coupling likely due to: A) coupling at EX cryobaffle, B) PSL (jitter), and C) unknown source of vibration coupling in LVEA.**

1) 03-04 coupling reduction projects

A) HAM5-6 septum window removal greatly reduced coupling, LHO, LLO

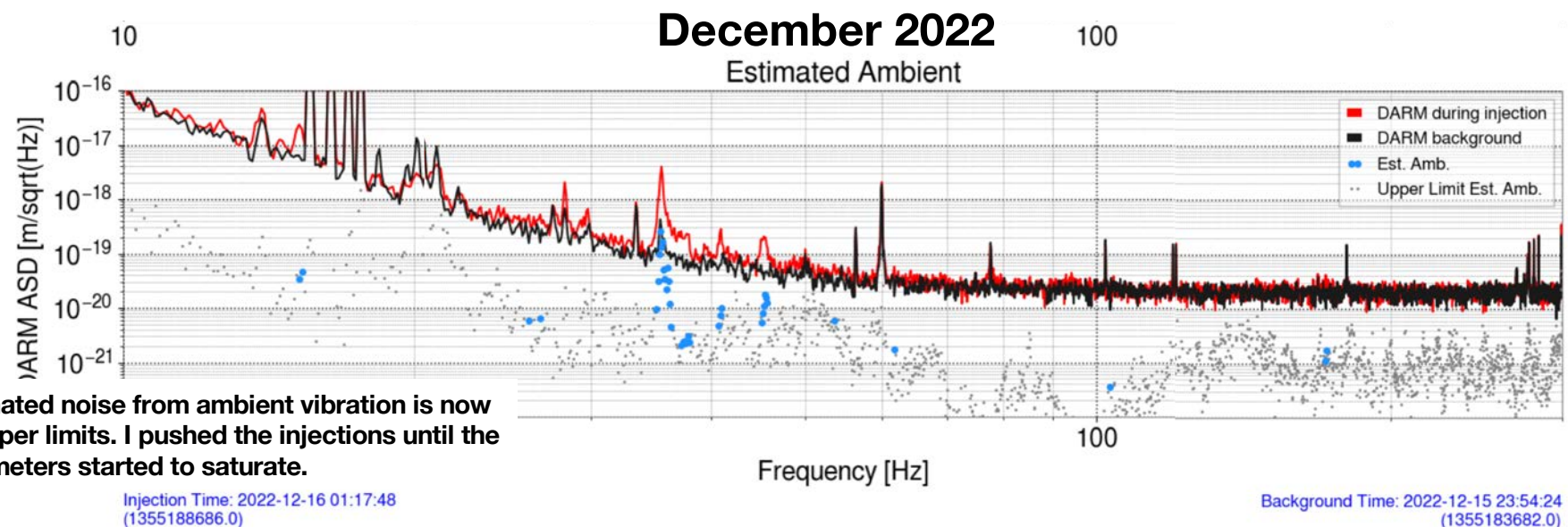
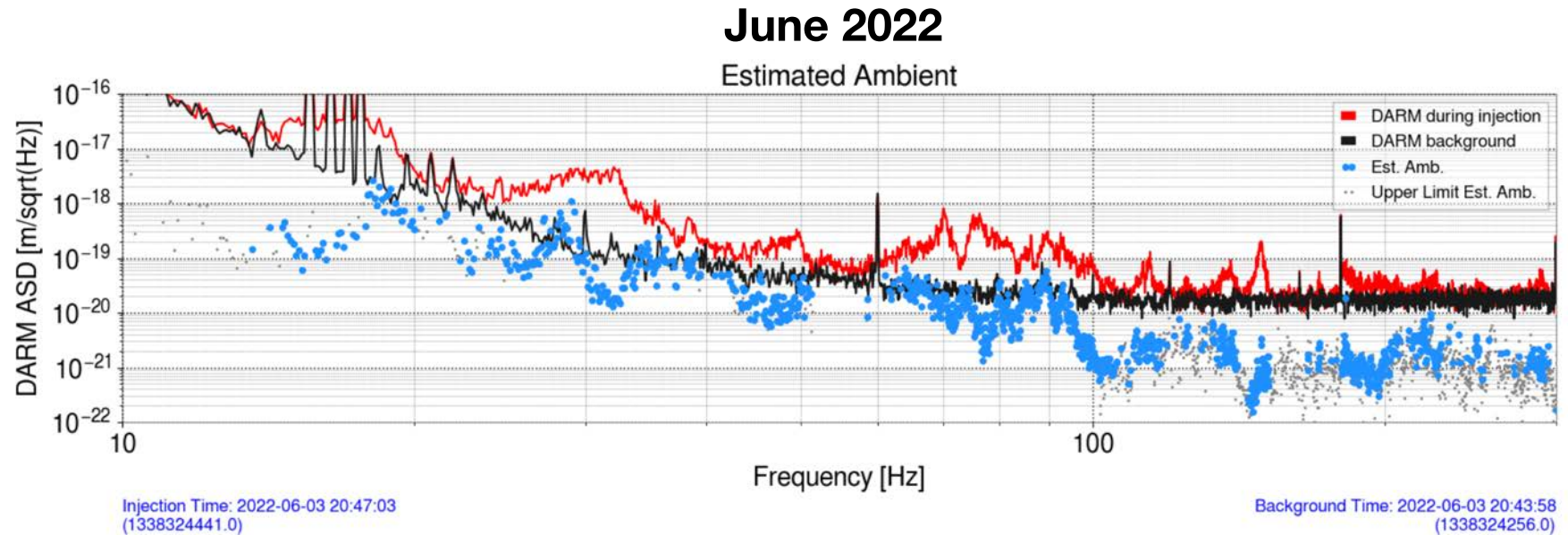

The estimated noise from ambient vibration is now mainly upper limits. I pushed the injections until the accelerometers started to saturate.

1) 03-04 coupling reduction projects

B) ETMY, ITMY Cryobaffle scattering noise reduced by damping; ETMX baffle not yet damped, LHO, LLO

Before ITMY Cryobaffle Damping

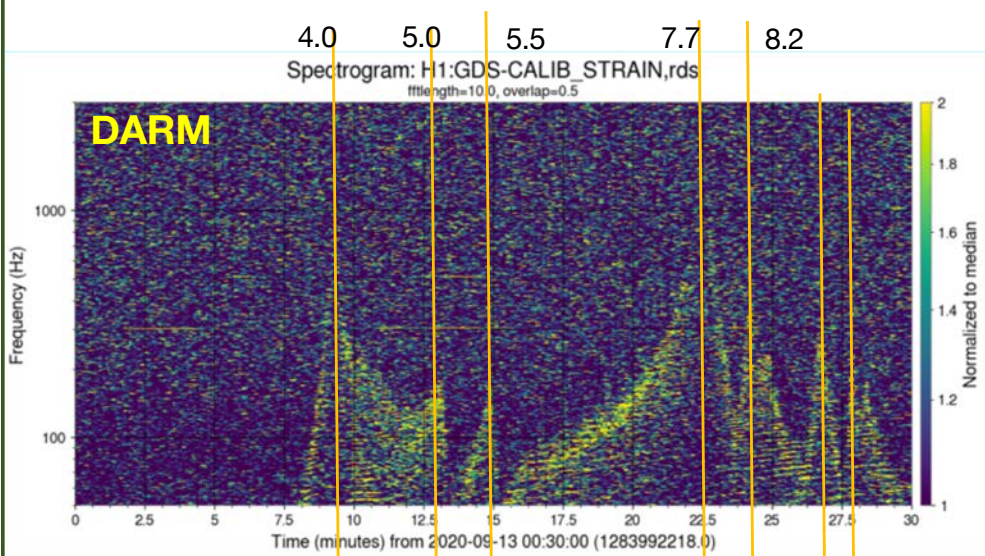

After ITMY Cryobaffle Damping

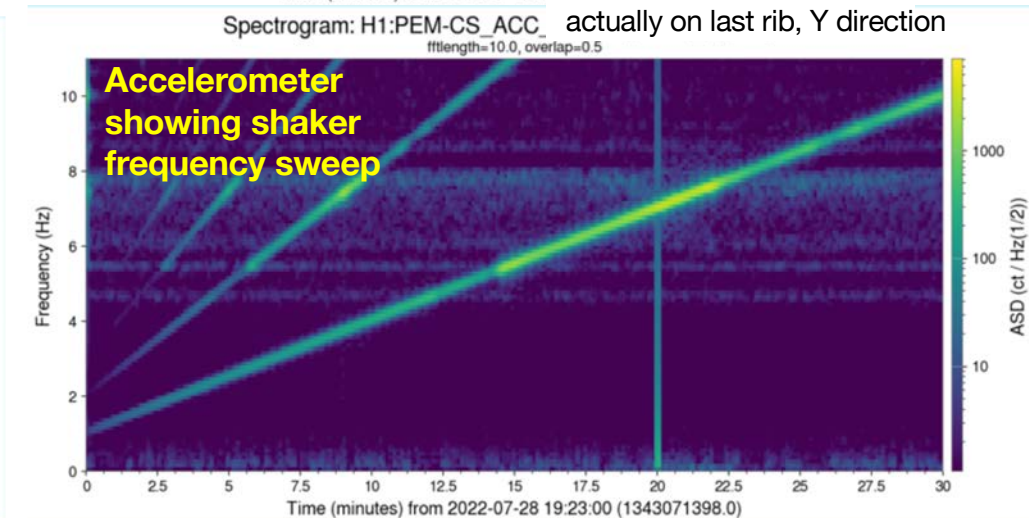
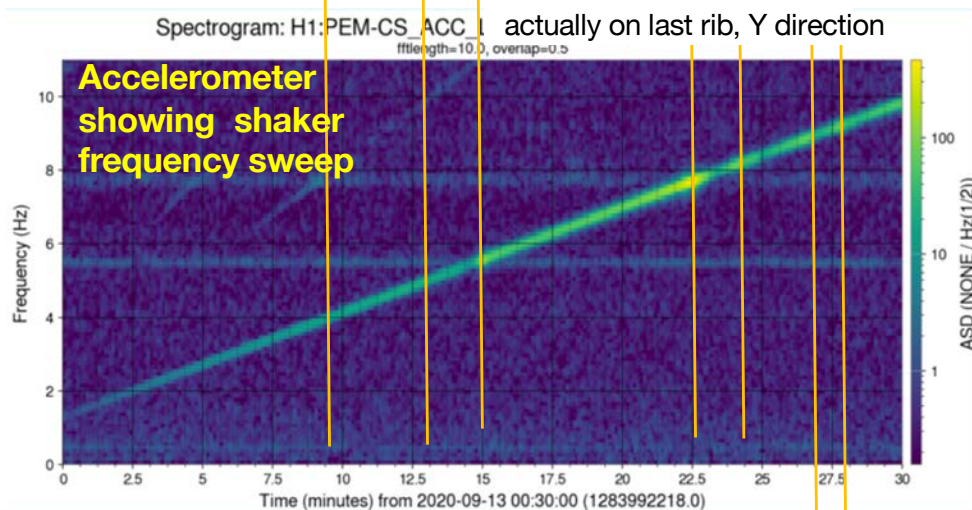
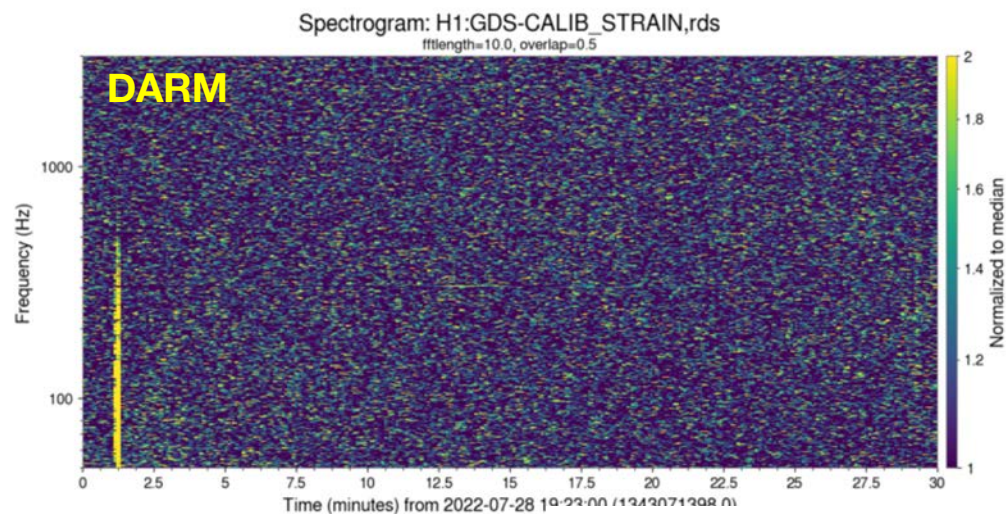

1) 03-04 coupling reduction projects

C) ITMY replacement reduced PSL jitter noise by almost 10, LHO

Right after ITMY replacement

Worst jitter peak at about 500 Hz no longer appears in ambient DARM spectrum and is down by about ten

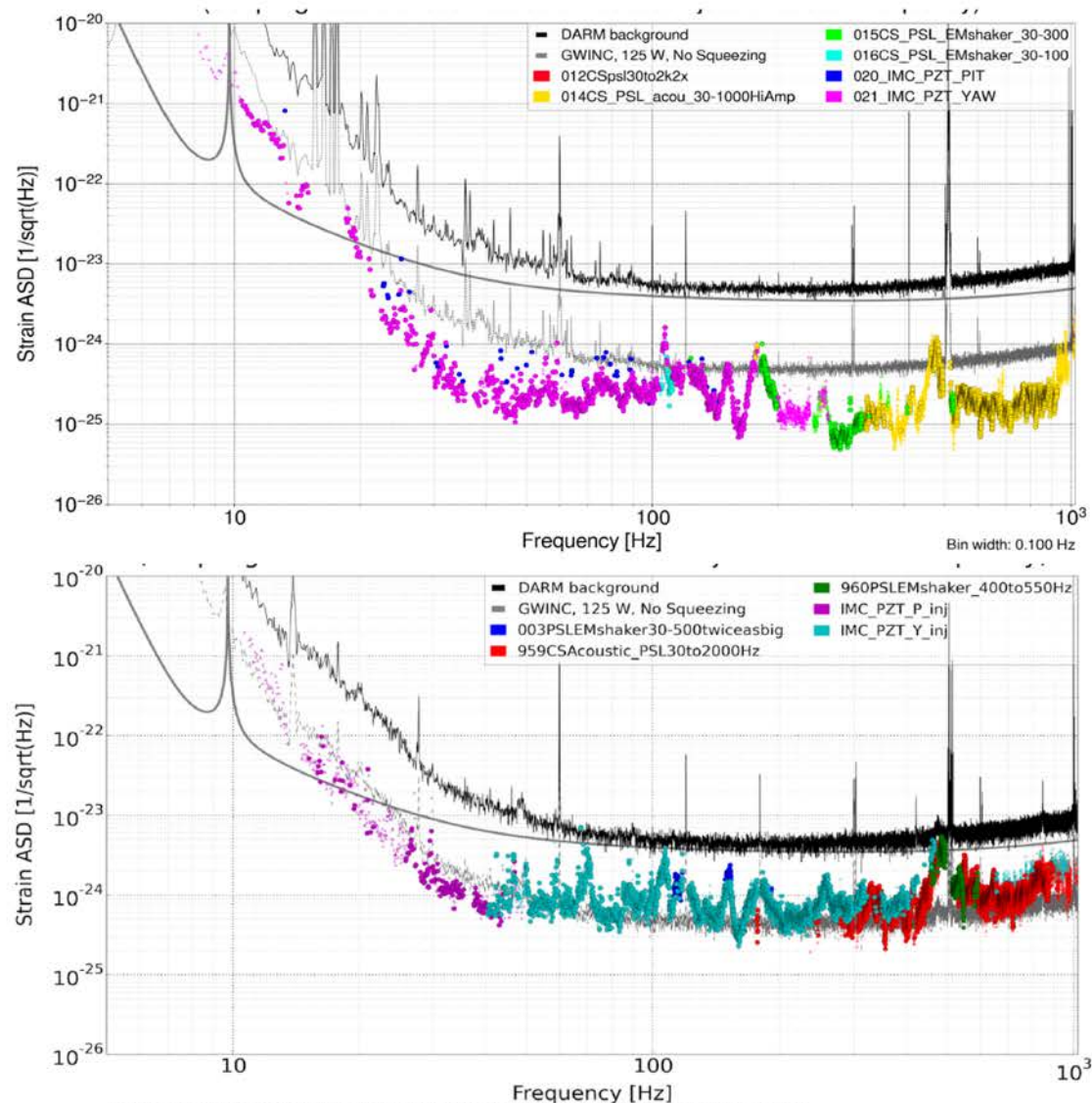

Ambient estimates are made by multiplying coupling factors by injection-free sensor levels. CIRCLES indicate estimates from measured coupling factors, i.e. where the injection signal was seen in the sensor and in DARM. TRIANGLES represent upper limit coupling factors, i.e. where a signal was not seen in DARM.

Before, May 2019

<https://alog.ligo-wa.caltech.edu/aLOG/index.php?callRep=49521>

2) Does vibration coupling increase with laser power?

A) Input jitter coupling up by roughly 5 between 46W and 60W;

46W right after ITMY replacement May 12, 2021

60W March 15, 2023

Input jitter, Yaw,
Black: nominal
Red: injection on
H1:IMC-
PZT_YAW_EXC

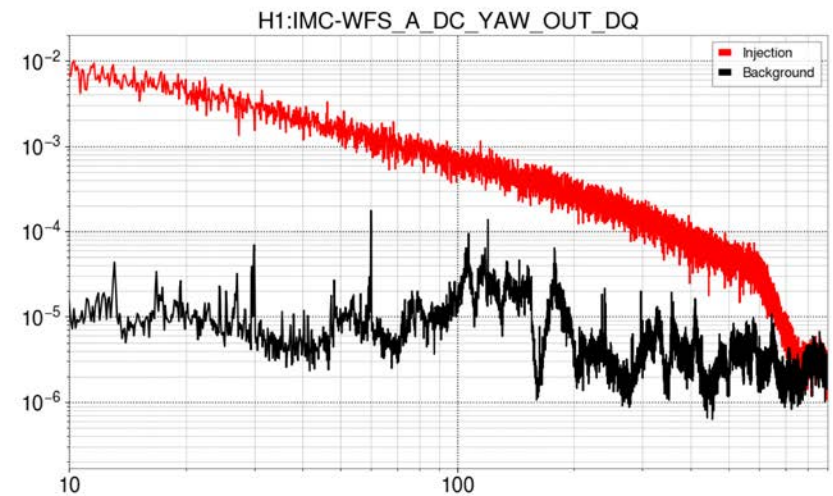
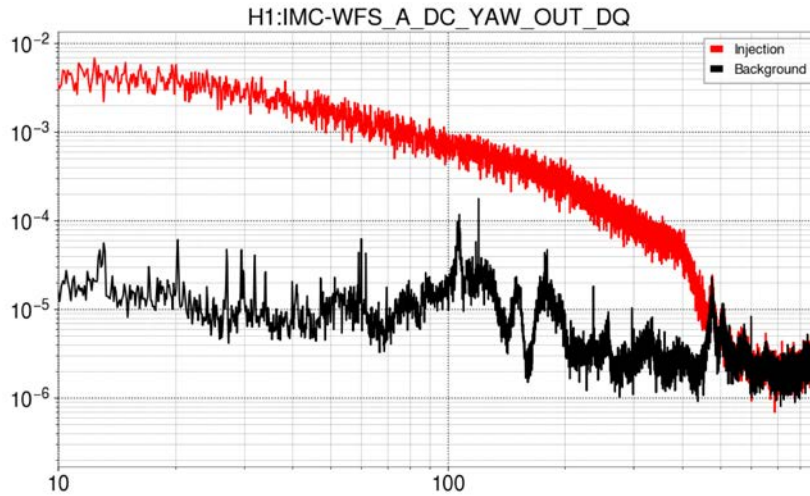

Strain

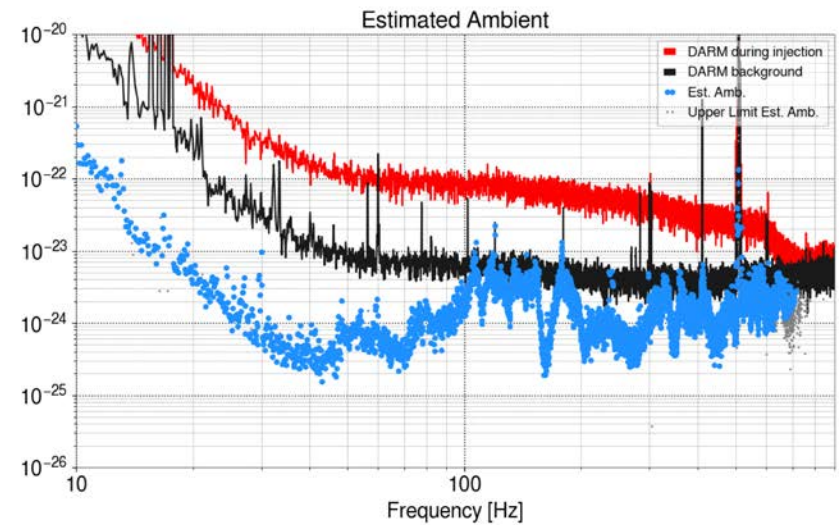
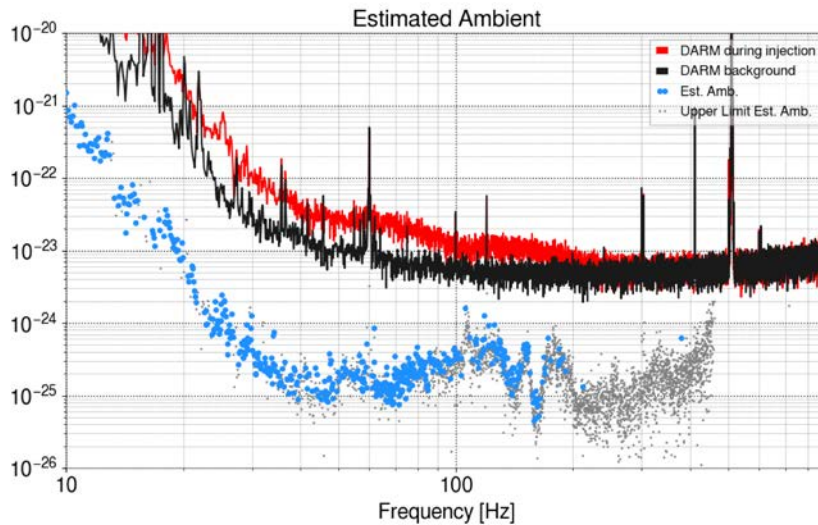

Injection Time: 2021-05-12 17:48:54
(1304876952.0)

Background Time: 2021-05-12 05:00:00
(1304830818.0)

Injection Time: 2023-03-15 01:32:15
(1362879153.0)

Background Time: 2023-03-15 07:48:00
(1362901698.0)

2) Does vibration coupling increase with laser power?

B) scattering noise increased by ~10 from the EX cryobaffles at LHO from 38W to 75W, also at LLO

38W, Sept. 2020 showing noise resonance of ETMX cryo-baffle at 4.1 Hz (LHO alog 56857)

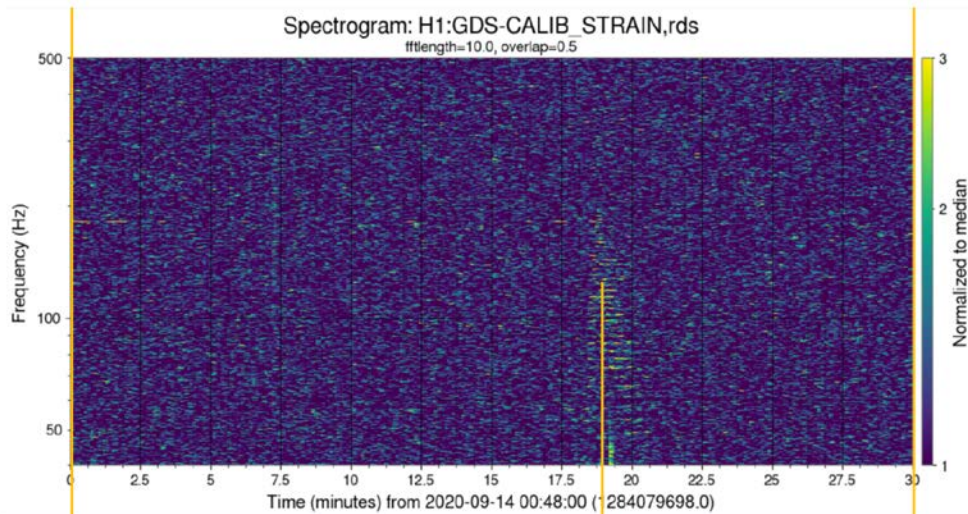

75W May 2023 repeat of shaking showing that noise is generated at about the same frequency and Q, but with much greater amplitude relative to the background.

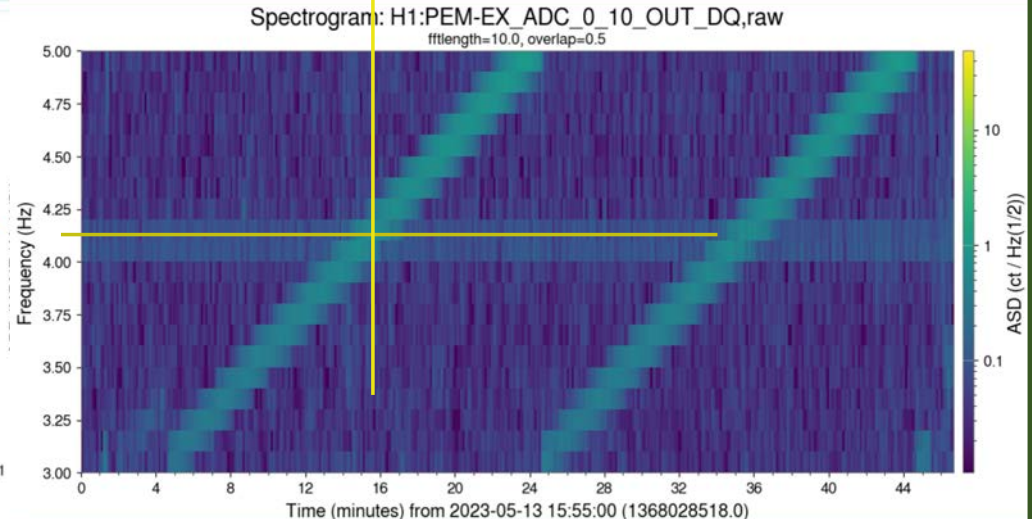
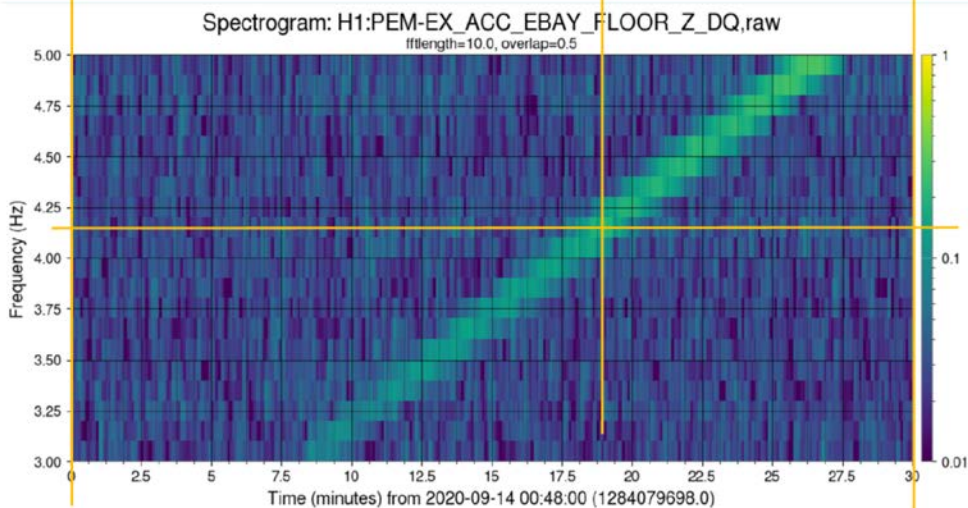
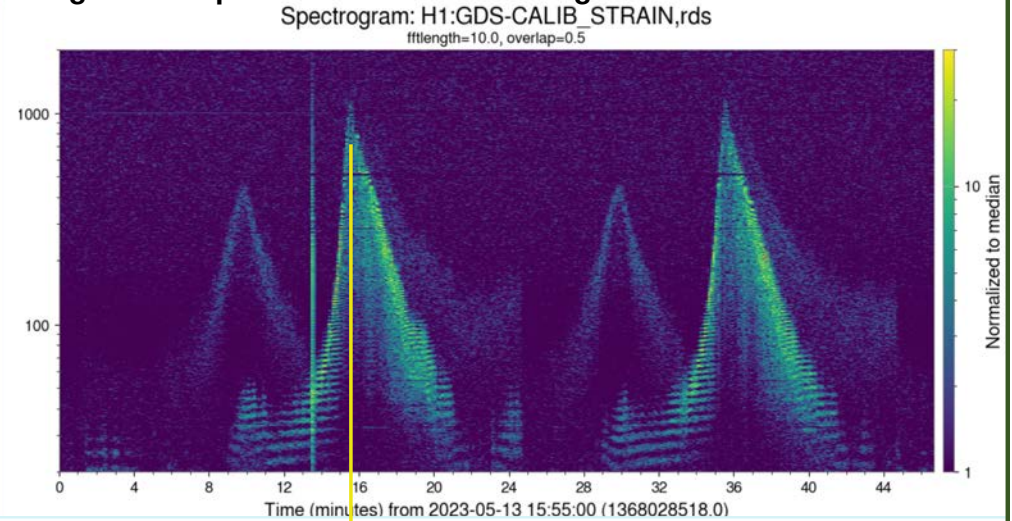

2) Does vibration coupling increase with laser power?

C) What happened when we decreased power from 75W to 60W? PSL jitter coupling dropped by roughly two.

100-1000 Hz speaker injection

75W

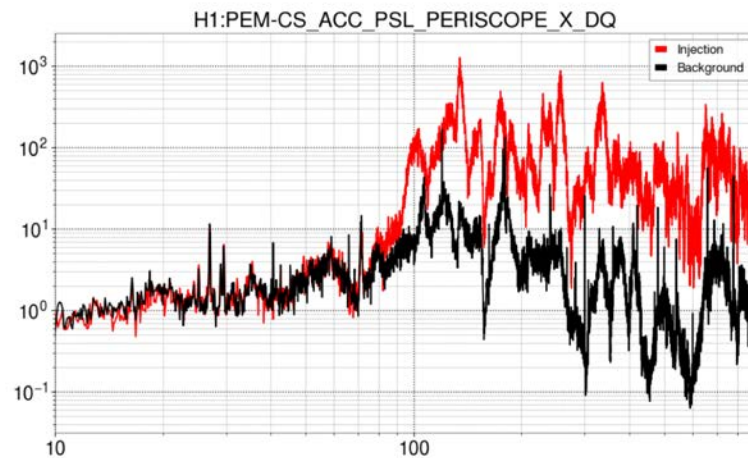

60W

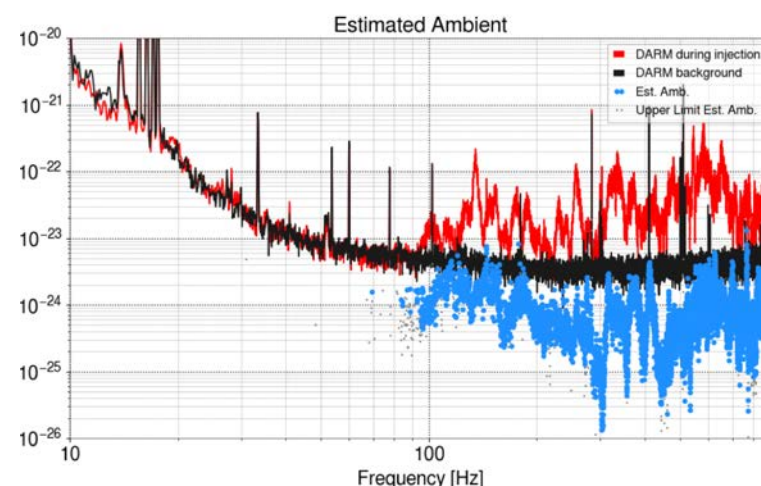
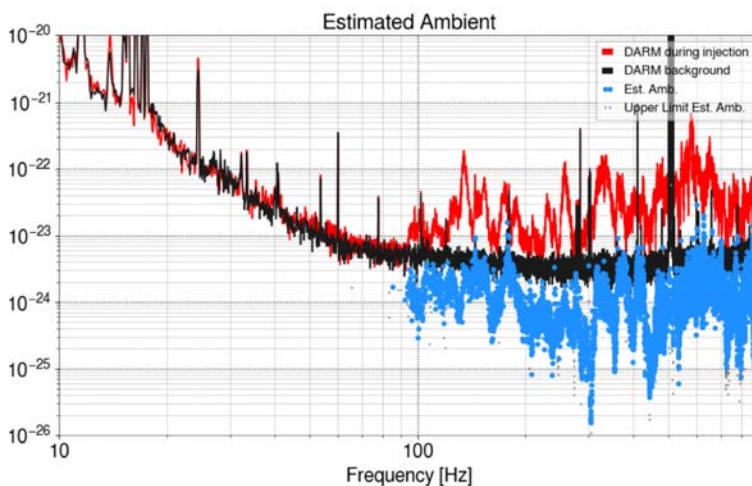
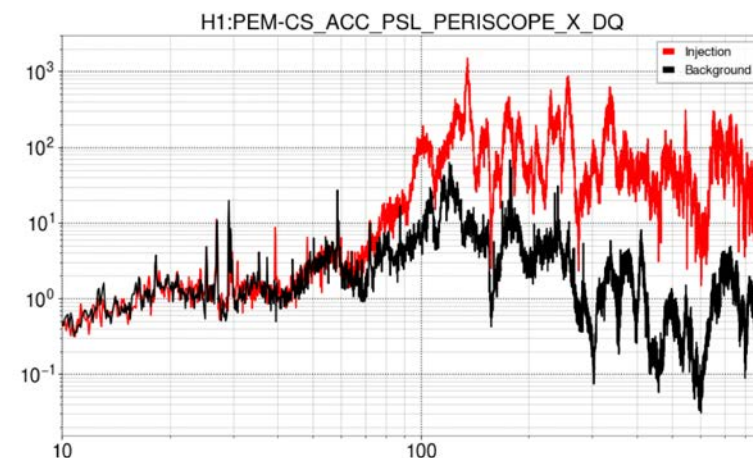

2) Does vibration coupling increase with laser power?

**C) What happened when we decreased power from 75W to 60W?
Scattering noise at EX dropped by three.**

Peak comparison for similar velocities suggests that the scattered light amplitude is, at 60W, about 1/3 of the level at 75W

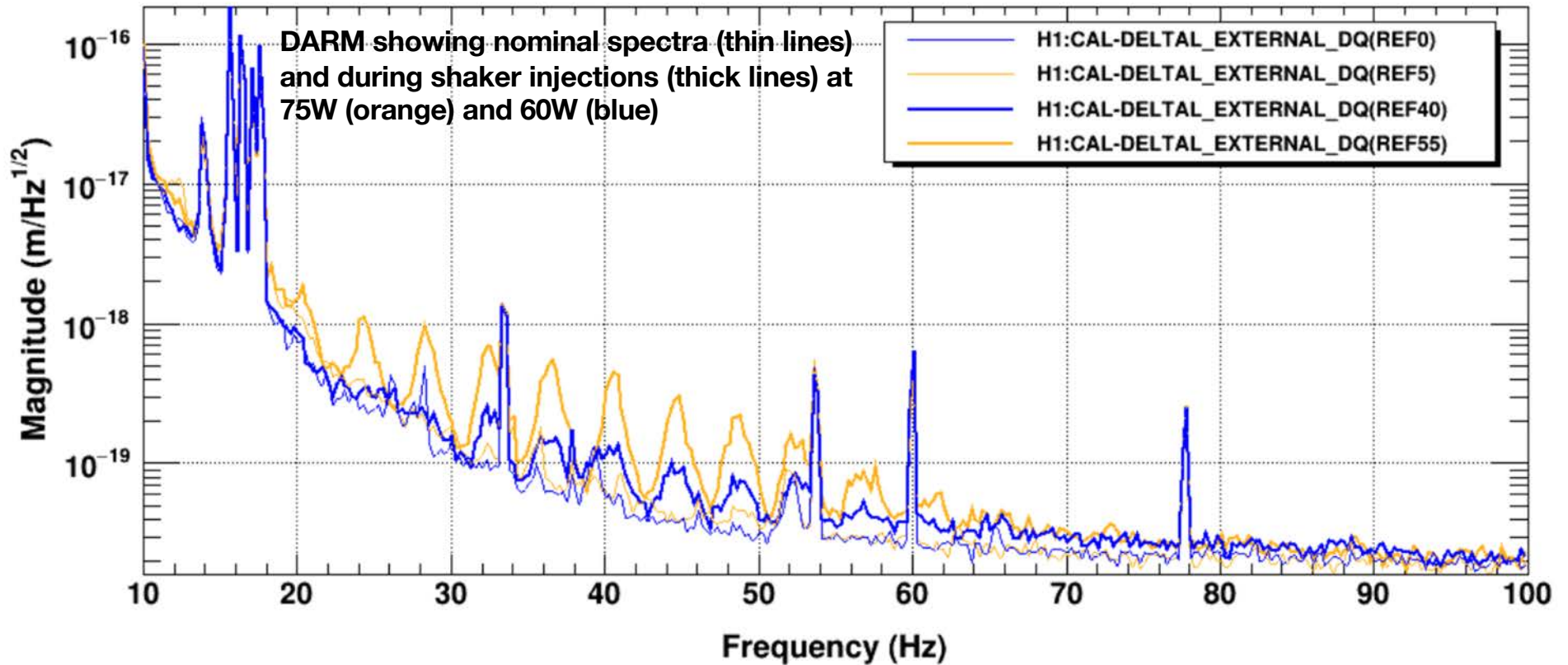

*T0=23/06/2023 19:23:10

Avg=30/Bin=2

BW=0.1875

2) Does vibration coupling increase with laser power?

Any indication of extra light at ETMX?

75W 2023

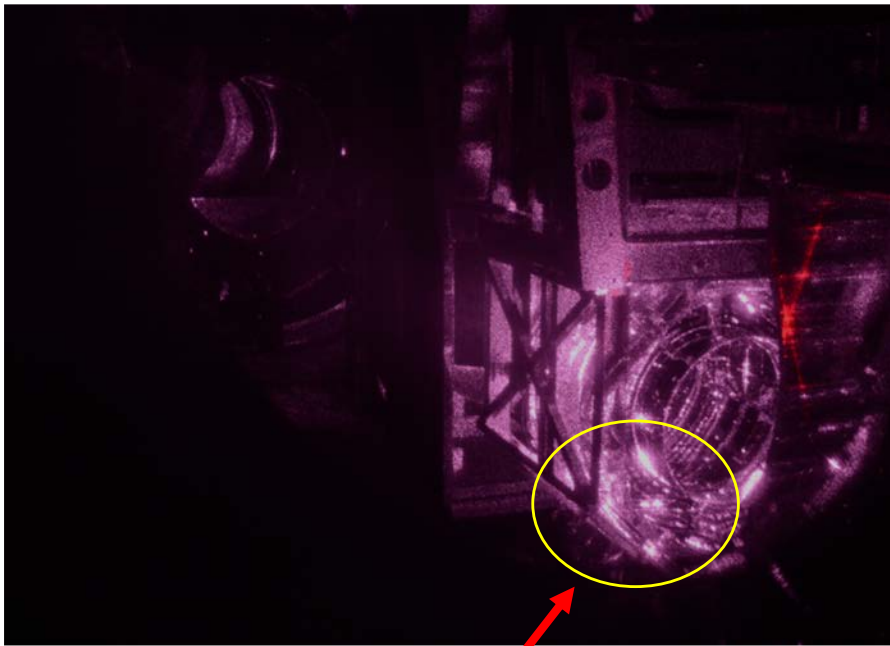

38W 2019

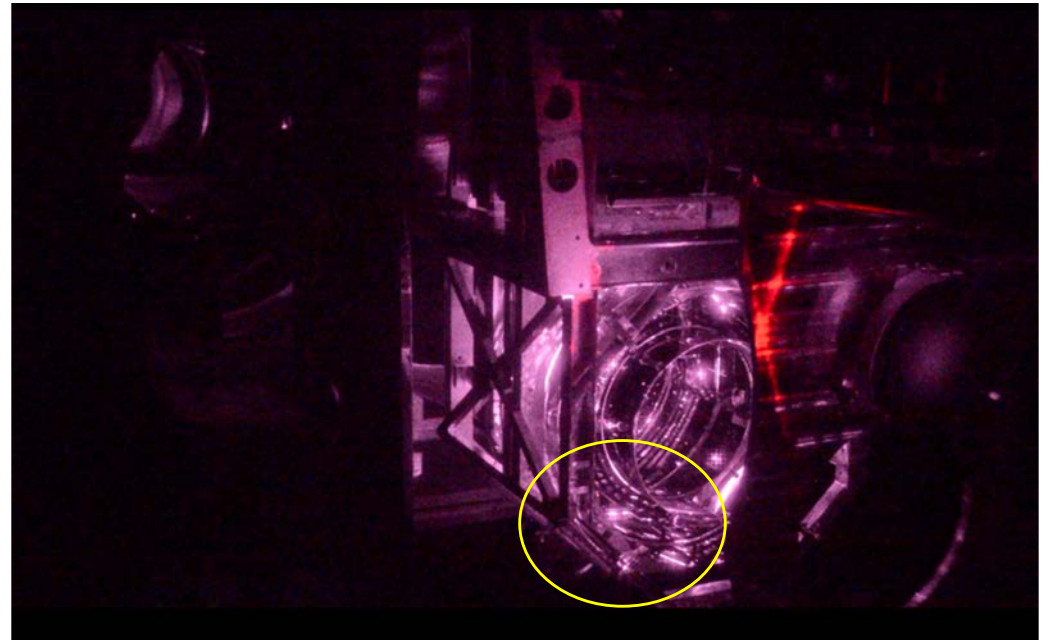

I tried to normalize the photos because they were taken with a factor of two power difference. I noticed no difference except perhaps in this region; if not a photographic artifact, it suggests that there is relatively more light that is outside of the beam, consistent with greater scattering.

2) Does vibration coupling increase with laser power?

Comparison of ACB photodiodes suggests that there is a moderate fractional increase in the small angle scattering detected by these diodes between 60W and 75W

wenxuan.jia@LIGO.ORG - 12:34, Tuesday 27 June 2023 (70868)

[Link](#)

Peter, Wen

We took a look at the arm cavity baffle PD before/after powering down. These PD are registering low-angle scatter, which includes higher-order spatial modes of the beam scattered from possible thermal deformation of the test mass. The power measured on the baffle PD (after IFO thermalized) depends on the arm power, beam spatial position relative to each baffle, and distance between beam spot center and point absorber if there are any. The measured PD power (dark offset subtracted) are summarized in the table below.

Variable	Measured value @ 75W [a.u.]	Measured value @ 60W [a.u.]	Normalized PD power @ 75 W / Normalized power @ 60 W
Input power on PRM	71.2	57.3	
PRG	47.1	50.4	
ITMX PD1	2.47	1.77	1.20
ITMX PD2	0.033	0.027	1.05
ITMX PD3	0.061	0.052	1.00
ITMX PD4	Saturated	0.080	N/A
ETMX PD1	Saturated	Saturated	N/A
ETMX PD2	0.068	0.055	1.06
ETMX PD3	0.034	0.026	1.12
ETMX PD4	0.645	0.346	1.60
ITMY PD1	0.96	0.66	1.24
ITMY PD2	0.070	0.055	1.09
ITMY PD3	Dead	Dead	N/A
ITMY PD4	0.26	0.21	1.06
ETMY PD1	Saturated	0.85	N/A
ETMY PD2	0.016	0.014	0.98
ETMY PD3	0.044	0.041	0.92
ETMY PD4	0.95	0.80	1.02

2) Do we have to worry about vibration coupling increasing with arm power?

D) Possible mechanism: greater surface distortion from greater heating of coating defects may increase scattering and arm asymmetry

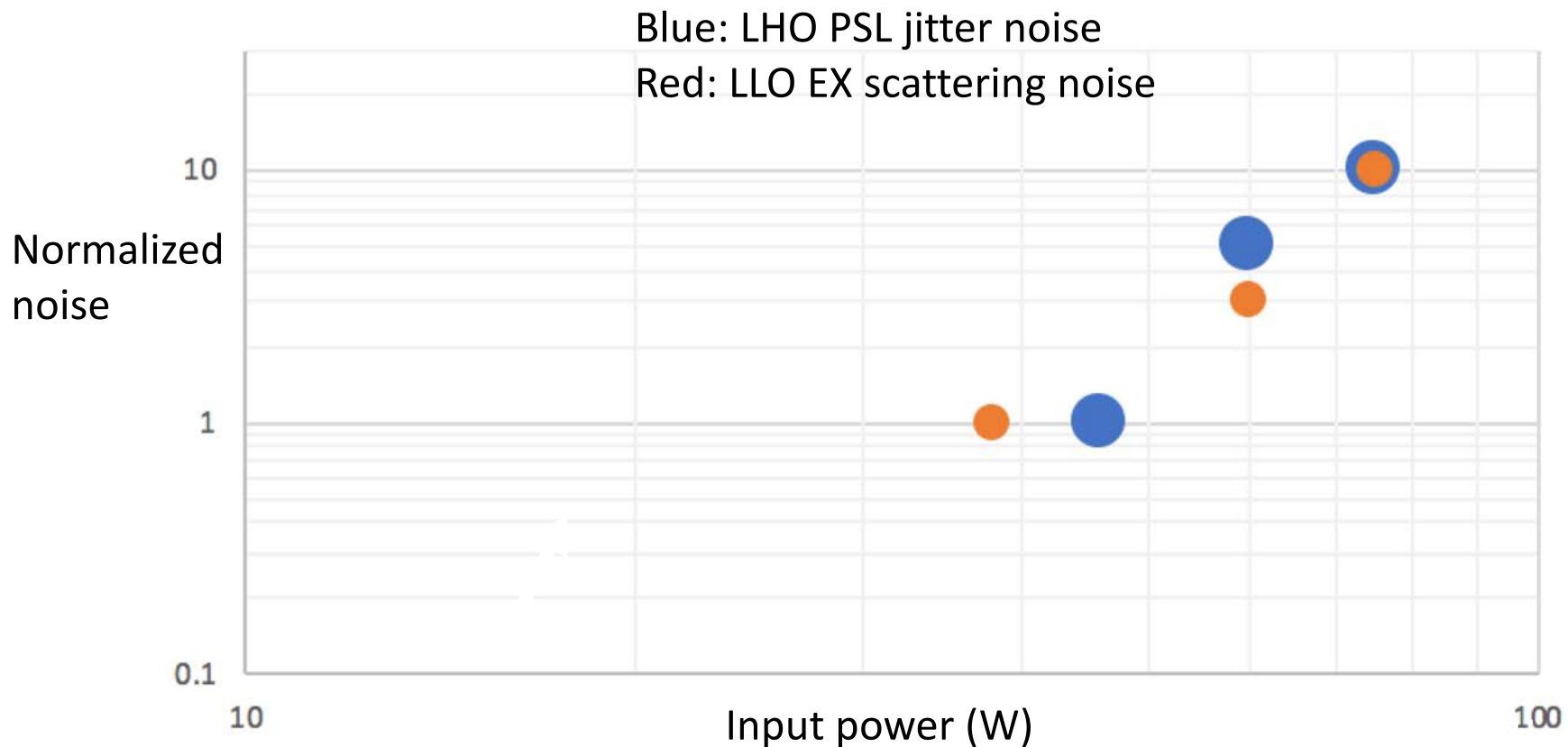

3) PEM injections completed before 04 run at LLO, and LHO at 75W – redo's after LHO dropped to 60W almost complete

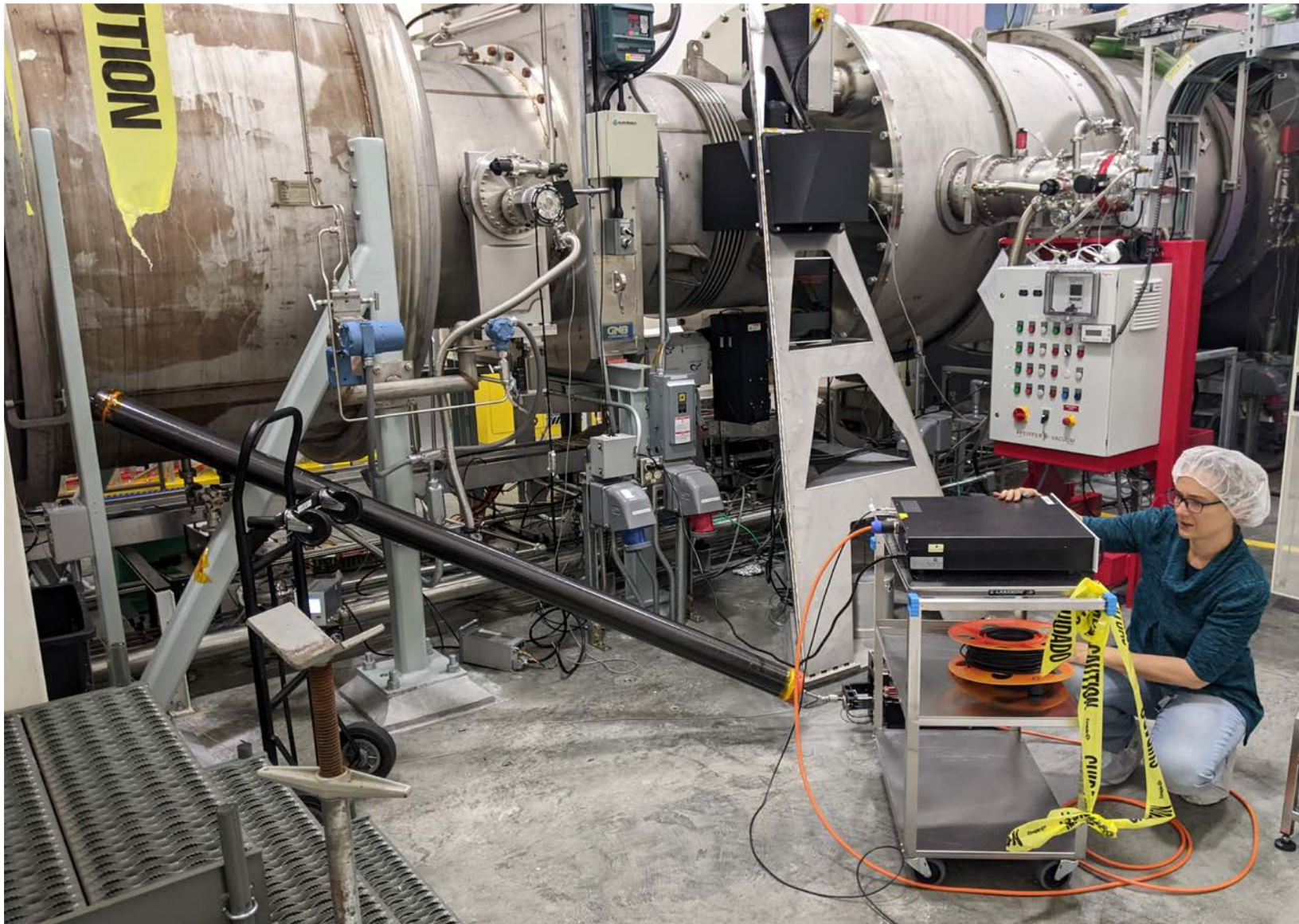

4) Low vibration coupling at LHO and LLO Filter Cavity End Stations

DARM

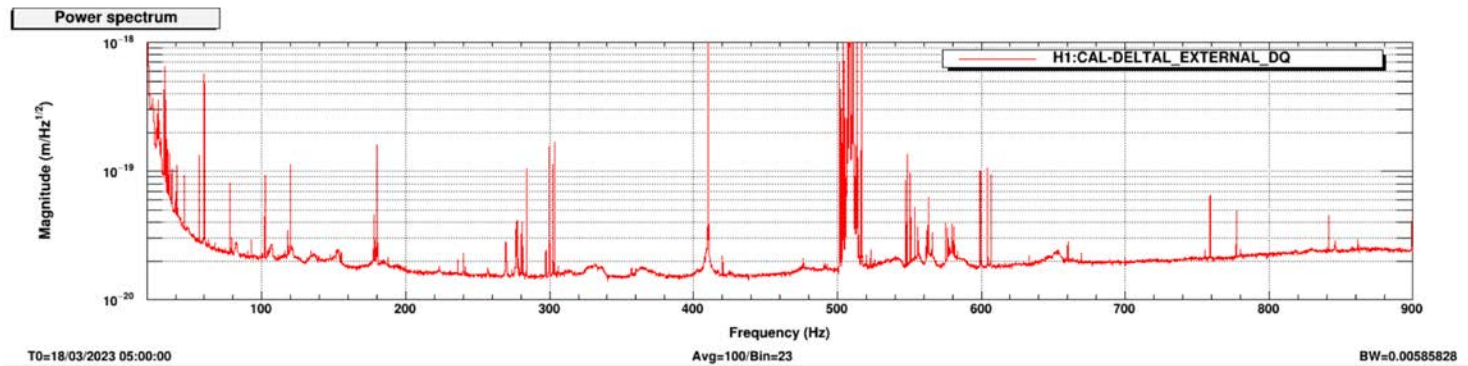

Coherence

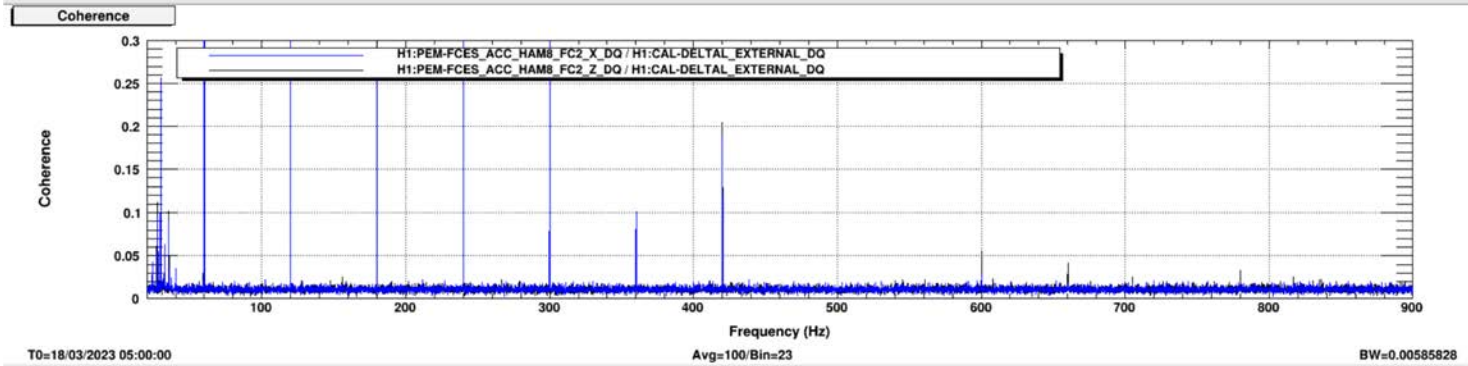

FCES accelerometers during acoustic injection of 5 Hz comb

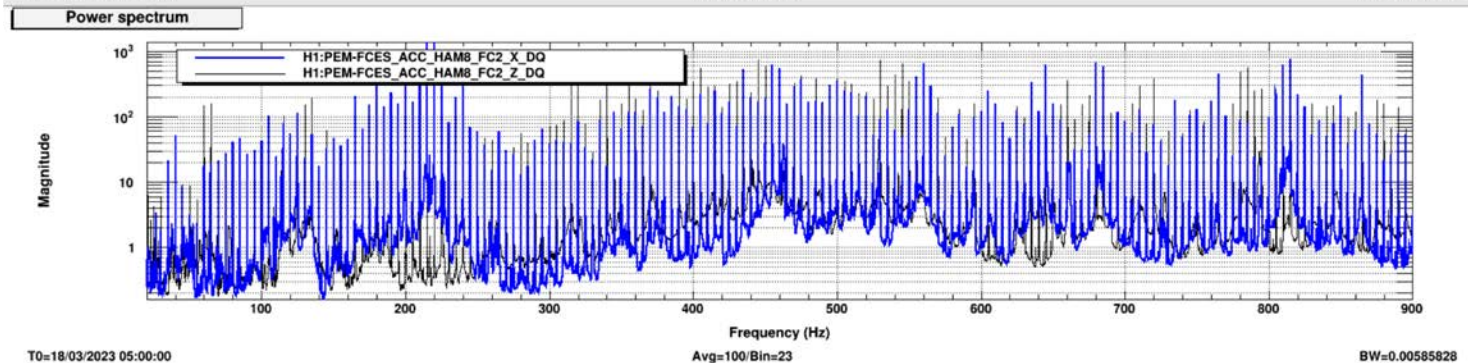

5) New electronic ground injection and monitoring techniques reveal grounding problems

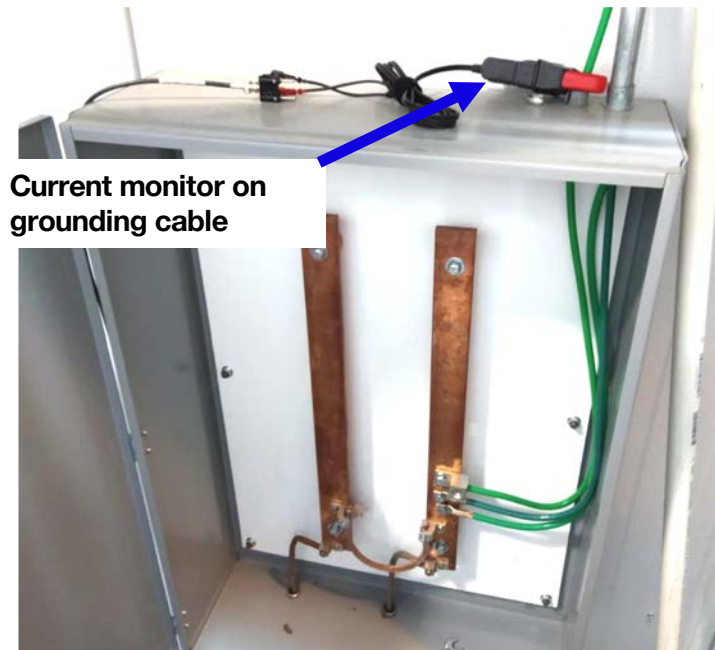

Ground current monitor channels

EX: H1:PEM-EX_ADC_0_09_OUT_DQ

EY: H1:PEM-EY_ADC_0_14_OUT_DQ

CS: H1:PEM-CS_ADC_5_26_2K_OUT_DQ

To set the scale:

For my ground injection at 22 Hz, I get about 0.3mV/m sqrt(Hz) at the EFM, and, about 12 mV/sqrt(Hz) of fluctuation of the building ground, determined from my measurement of 2 ohms between building "ground" and earth, and the current measured by the current clamp on a grounding cable, and, about 1.53 mV/sqrt(Hz) of drive fluctuation, as indicated by H1:SUS-ETMX_L3_DRIVEALIGN_L_OUT_DQ

Injections of 11 Hz comb at EX onto ISC Common chassis with return from cable tray. The $1/f^3$ slope in DARM is consistent with the $1/f$ slope in the current clamp monitor on the grounding cable.

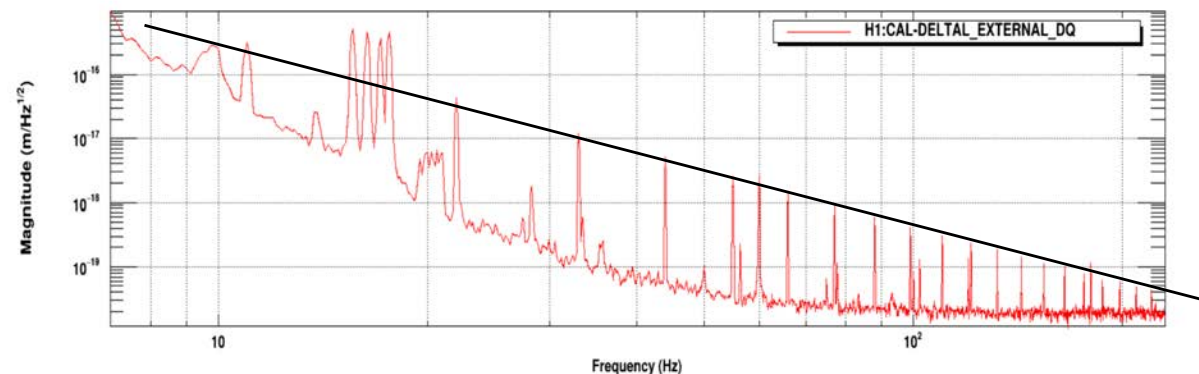

5) New electronic ground injection and monitoring techniques reveal grounding problems

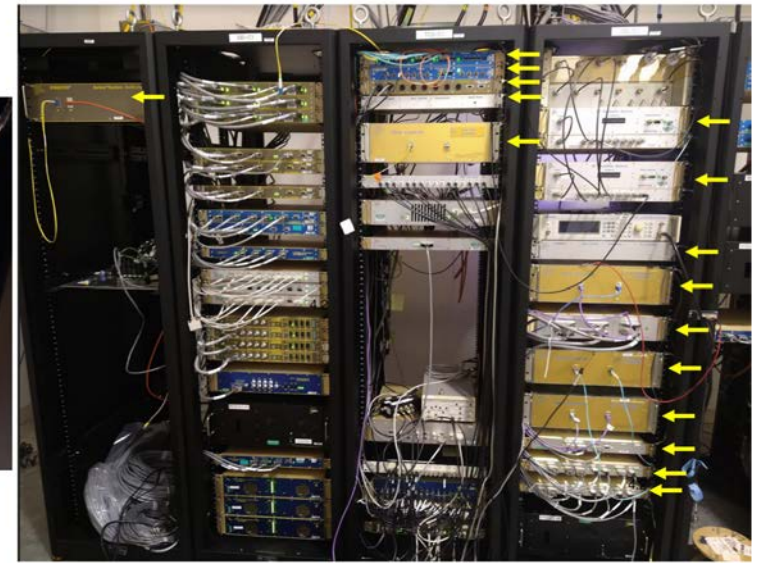

Blue: before, Red: after chassis grounding improvements at EX

DARM

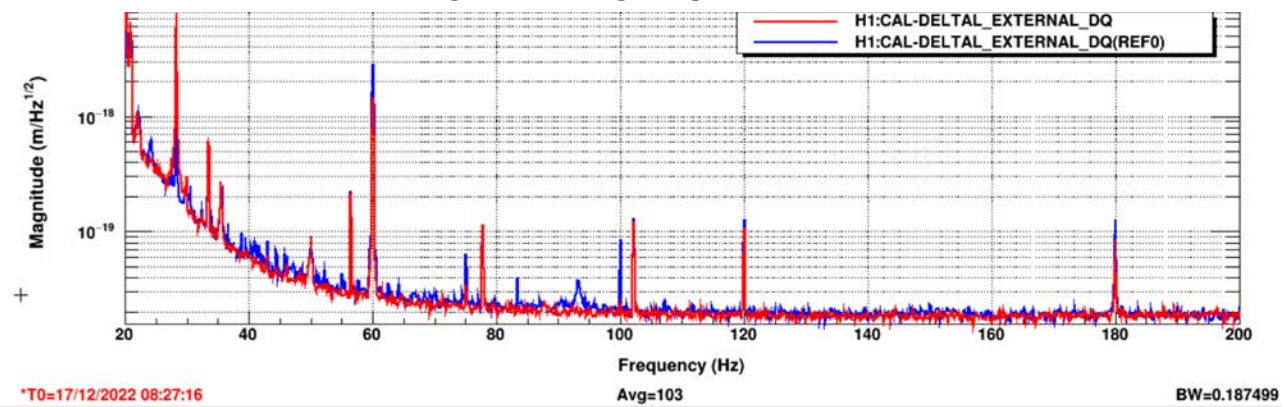

Coherence between DARM and current clamp on building grounding cable

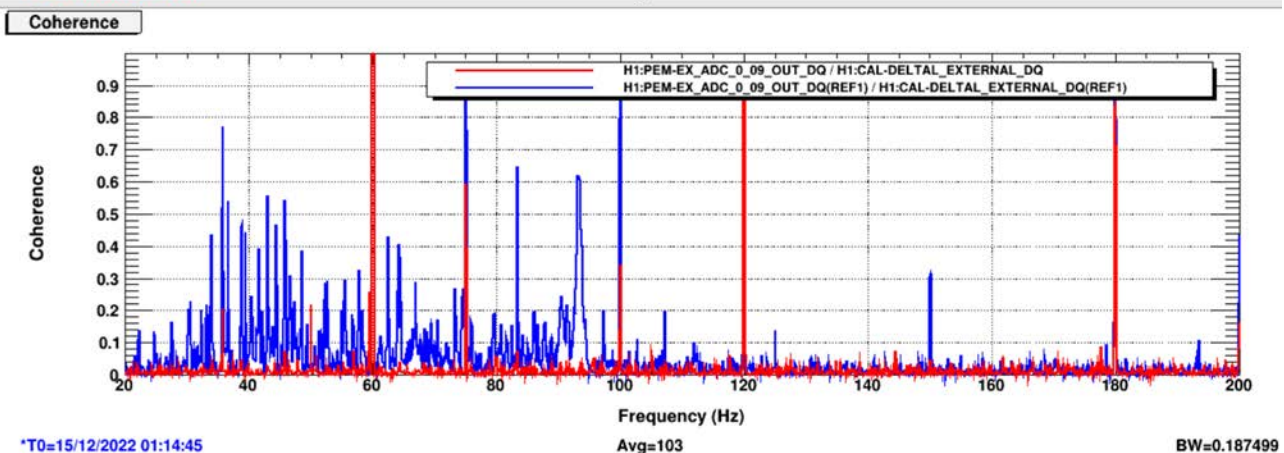

6) There is a non-zero test mass bias that minimizes grounding noise coupling.

Time series of amplitude of 66 Hz peak in DARM from ground injection at EX as ESD bias is swept

EX

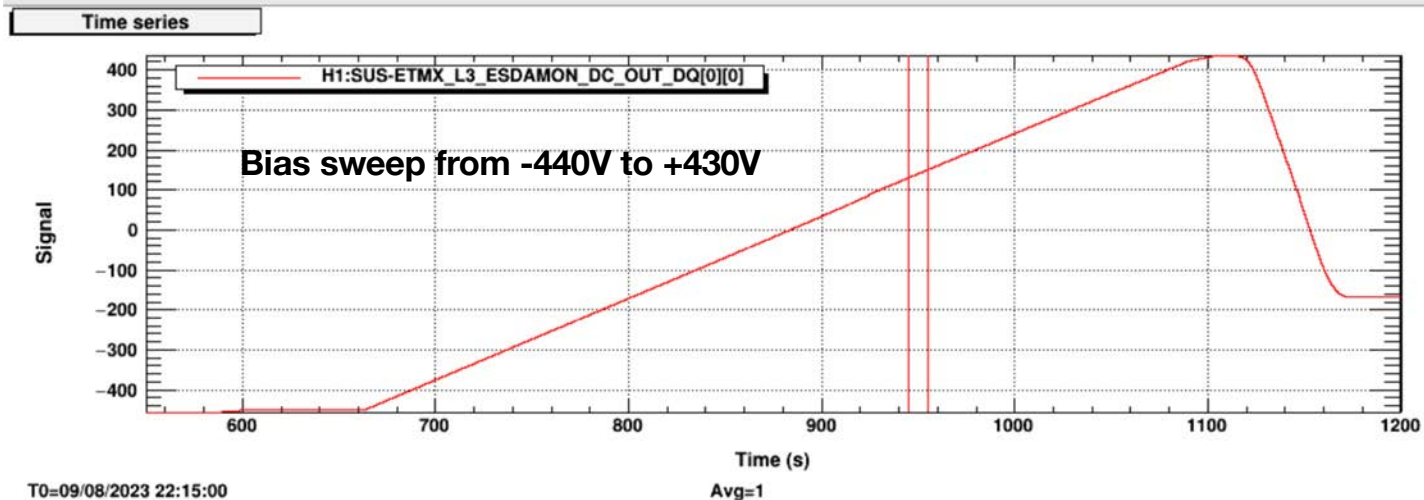
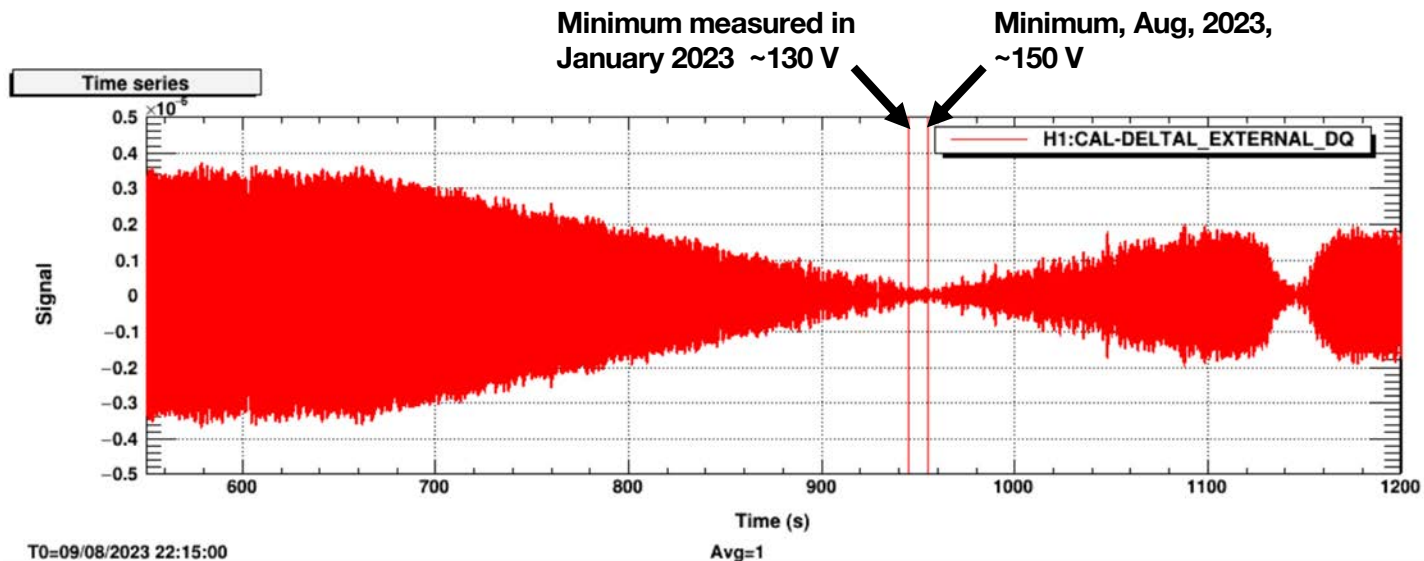

6) There is a non-zero TM bias that minimizes grounding noise coupling.

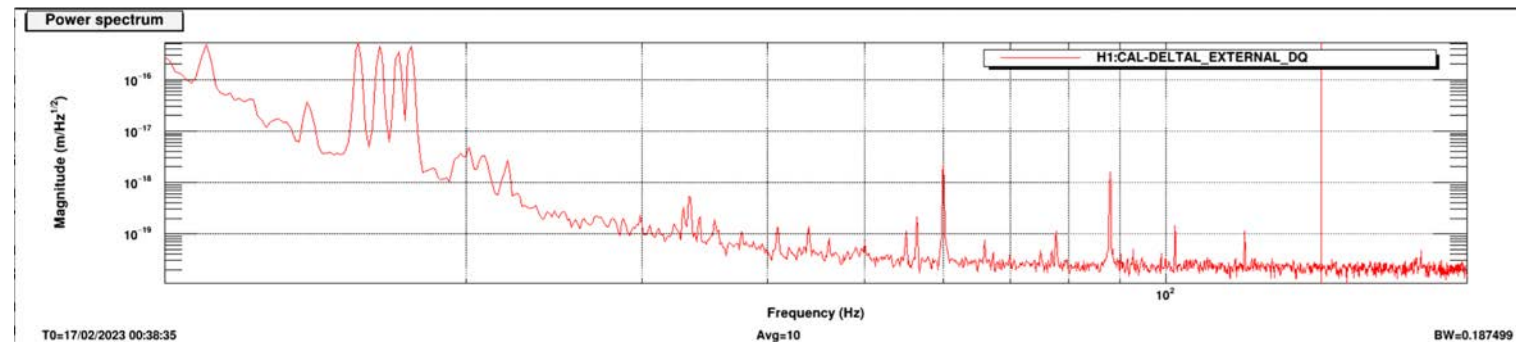
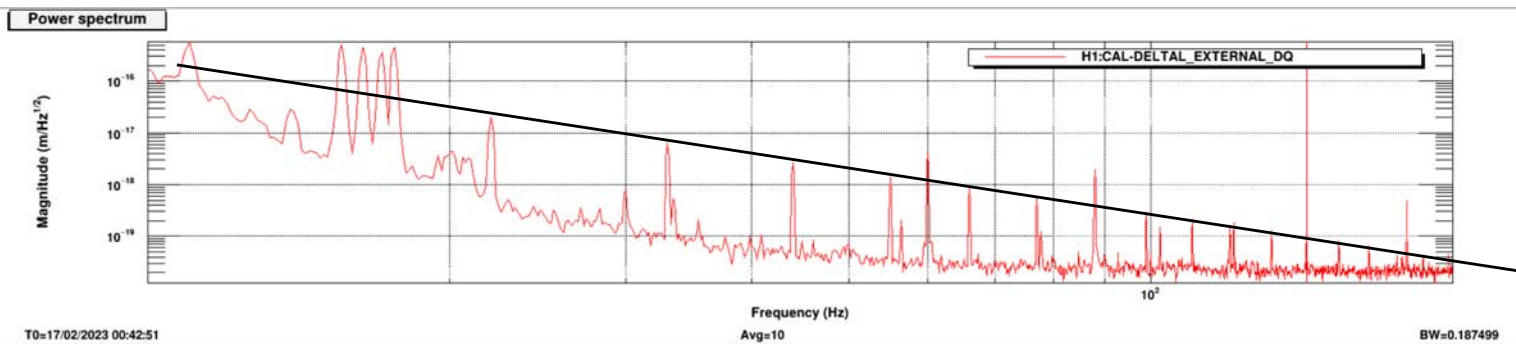
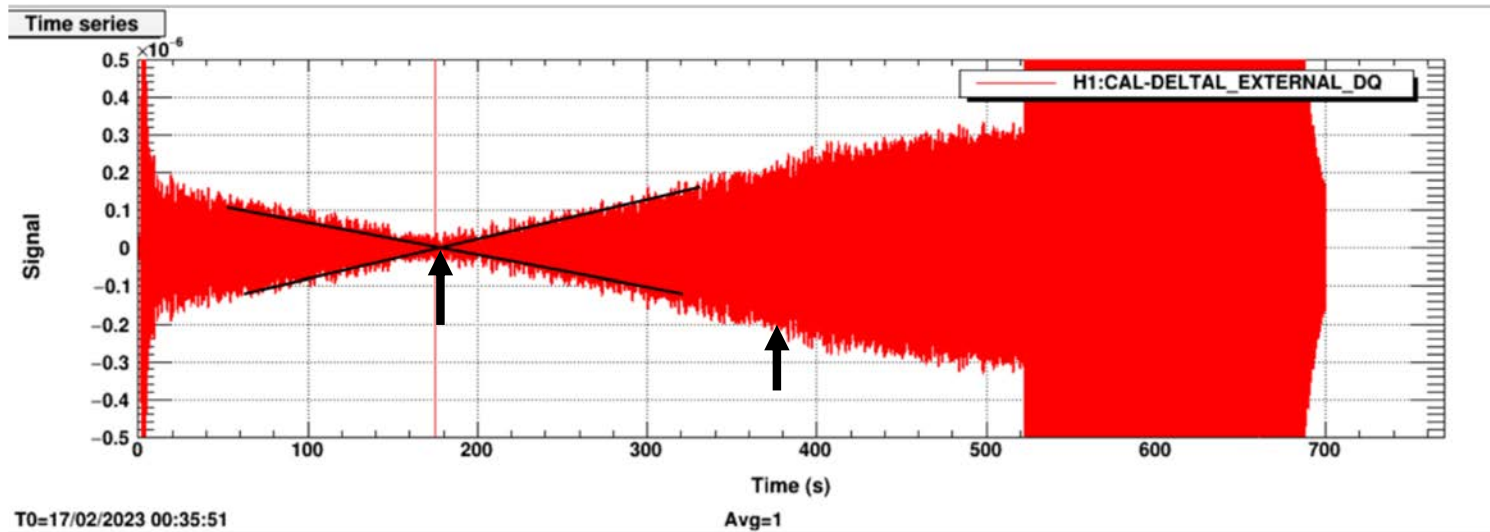

6) There is a non-zero TM bias that minimizes grounding noise coupling.

Minimizing lines from electronic ground injections also reduced other electronic lines

Current bias settings: ITMX -428V, ITMY -428V

Proposed bias settings: ITMX 0V, ITMY 60V

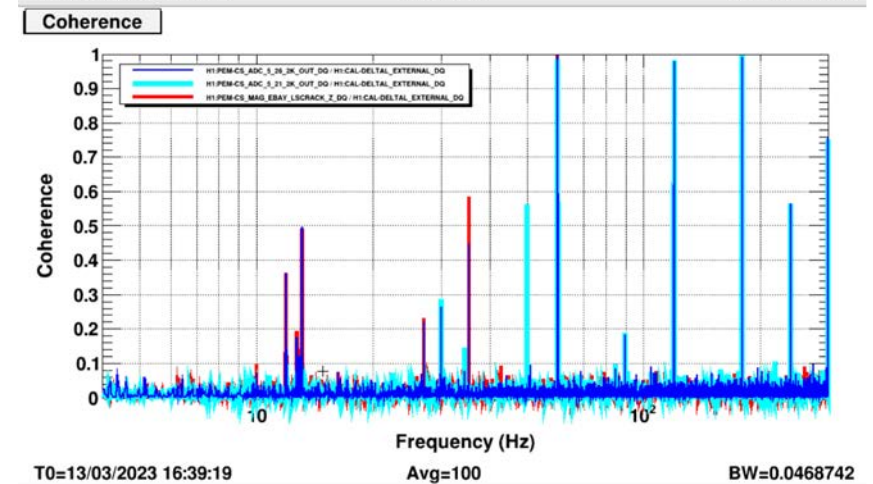
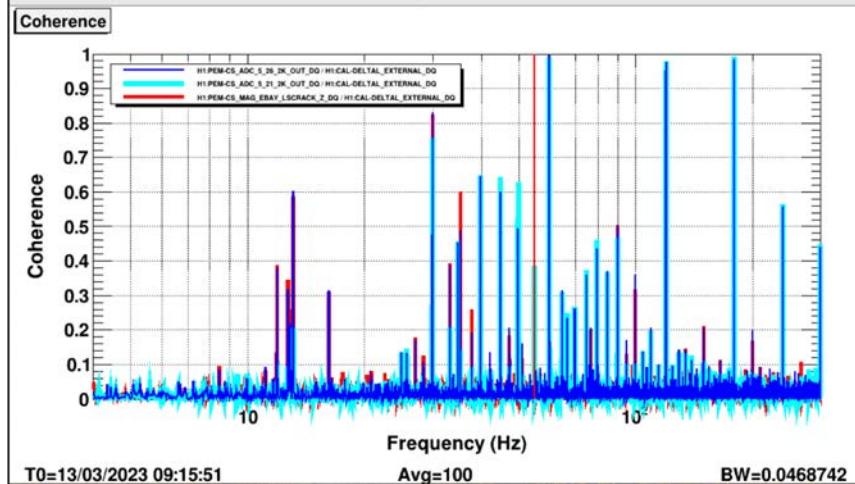
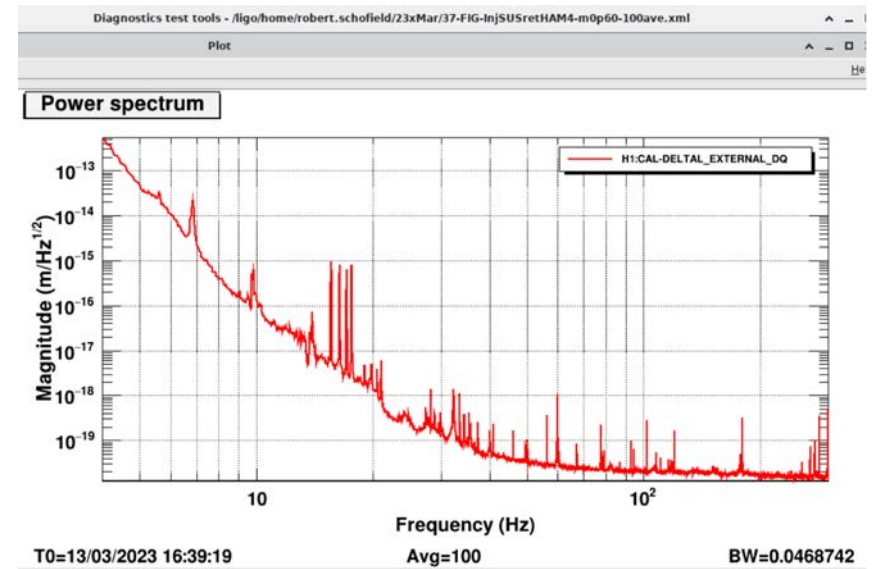
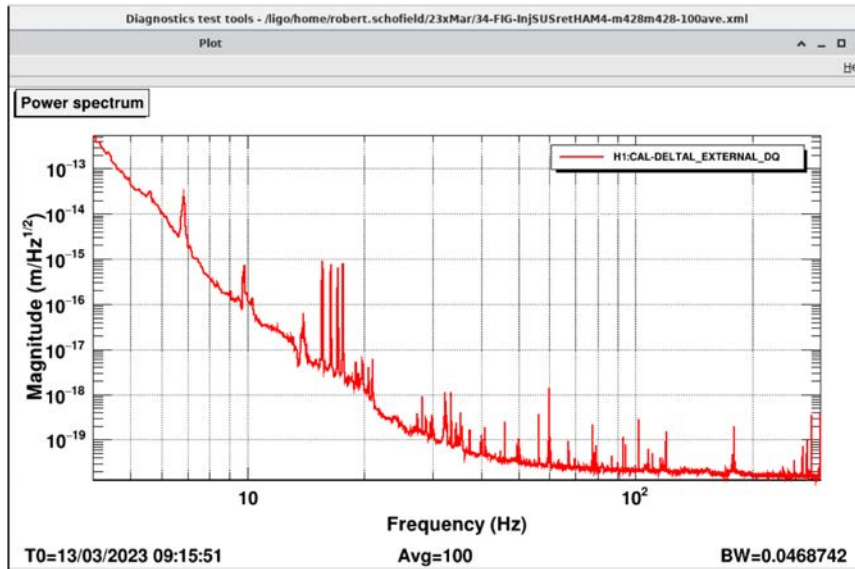

Dark Blue: clamp on grounding cable, Light Blue: magnetometer attached to BSC3, Red: rack magnetometer

6) There is a non-zero TM bias that minimizes grounding noise coupling.

Possible mechanism: test mass is charged and bias is set so that force on charge cancels force on bias-polarized molecules

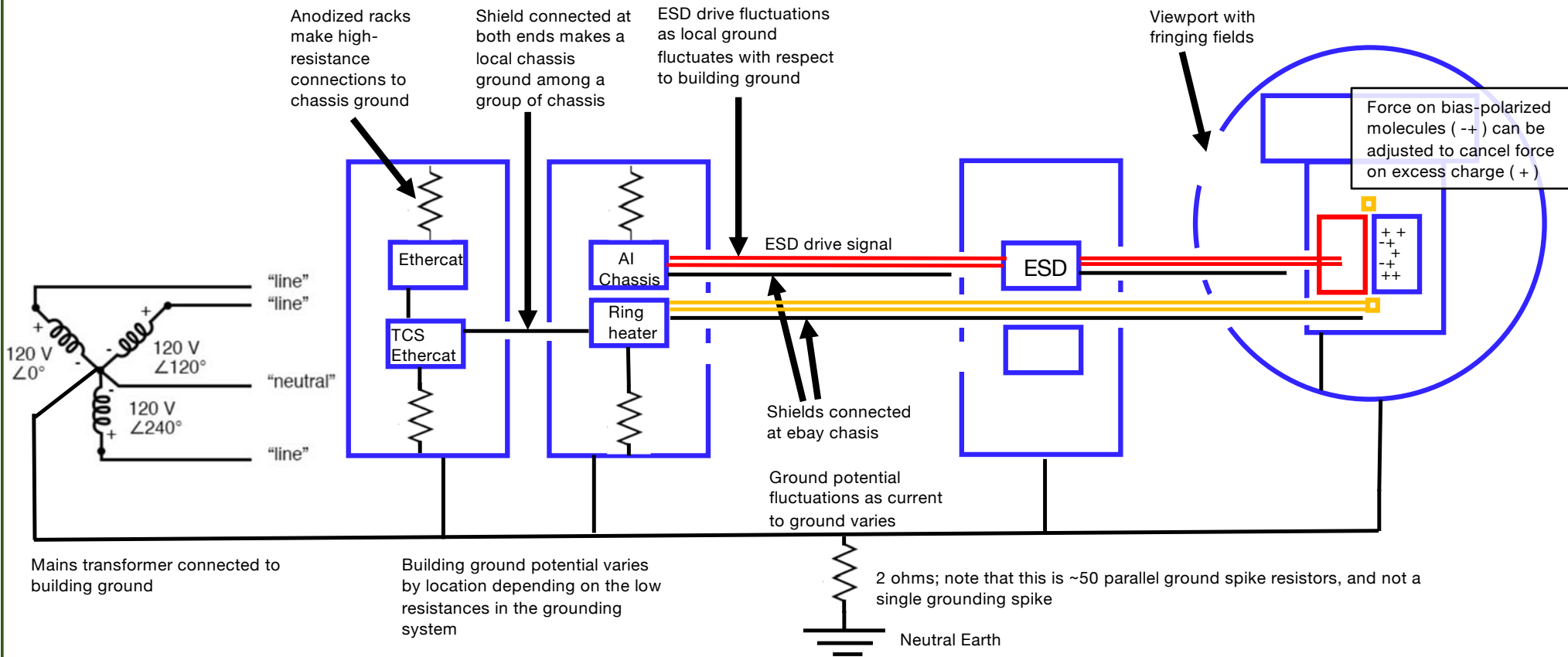

7) Arm Cavity Baffle identified as scattering source at LLO and hanging problems corrected



8) LHO HVAC shutdown increases range ~10Mpc

HVAC coupling likely due to:

- A) coupling at EX cryobaffle,
- B) PSL (jitter), and
- C) unknown source of vibration coupling in LVEA

Spectral differences during shutdown of LVEA fans only

Red: before and after
Blue: during the
shutdown of
SF1-6

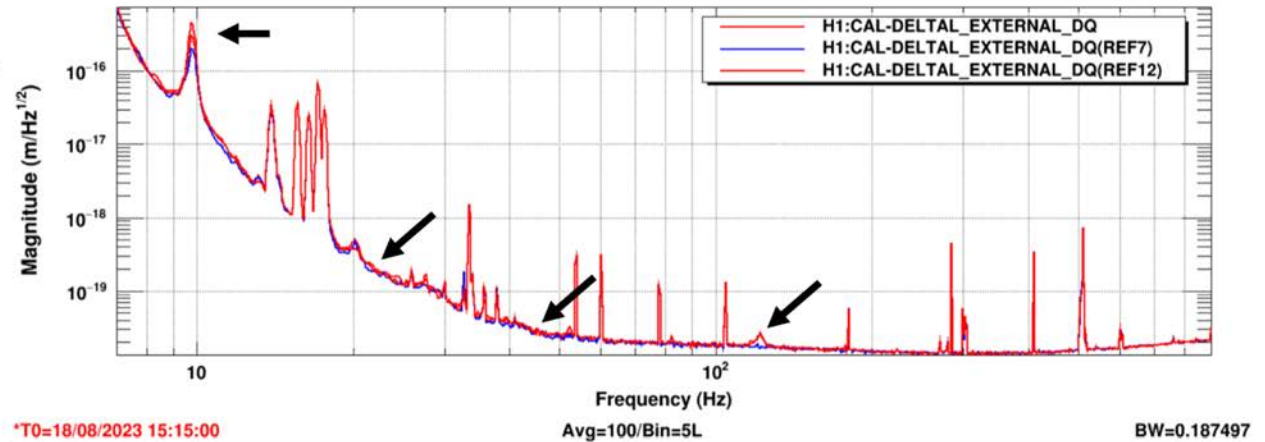

Coherence between
DARM and PSL
periscope
accelerometer to
highlight jitter
coupling. Blue: during
shutdown

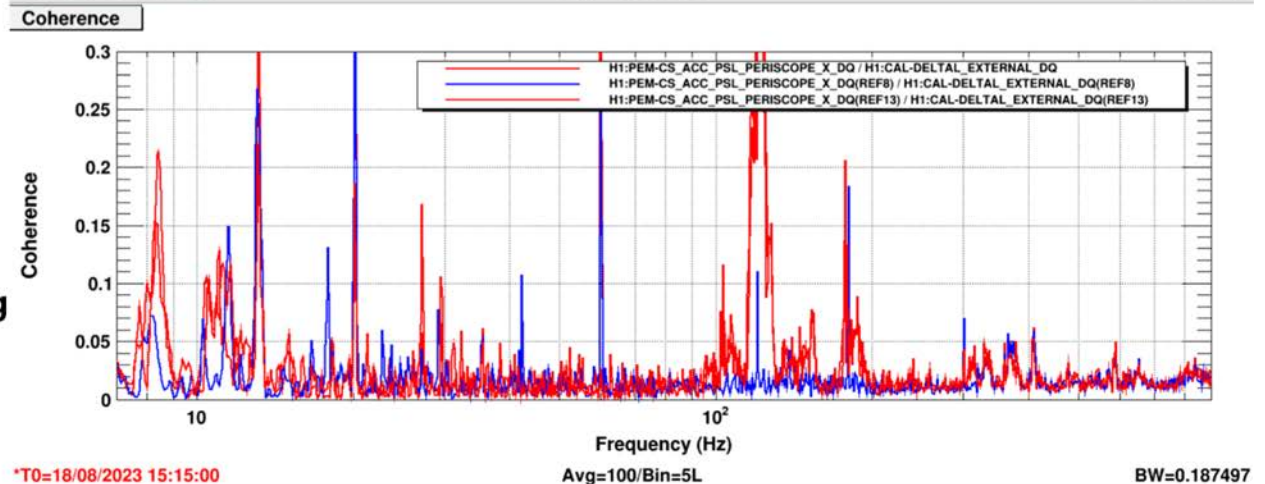

- 1) 03-04 vibration coupling reduction projects successful**
- 2) Does vibration coupling tend to increase with main laser power?**
- 3) PEM injections successfully completed before 04 run at LLO, and at LHO at 75W – redo's after LHO power drop to 60W almost complete.**
- 4) Low vibration coupling at LHO and LLO Filter Cavity End Stations.**
- 5) New electronic grounding noise injection technique reveals grounding problems.**
- 6) There is a non-zero TM bias that minimizes electronic ground noise coupling.**
- 7) Arm Cavity Baffle identified as scattering source at LLO, hanging problems corrected.**
- 8) HVAC shutdown, LHO, increases range by about 10Mpc, HVAC coupling likely due to: A) coupling at EX cryobaffle, B) PSL (jitter), and C) unknown source of vibration coupling in LVEA:**

Line for data on next slide

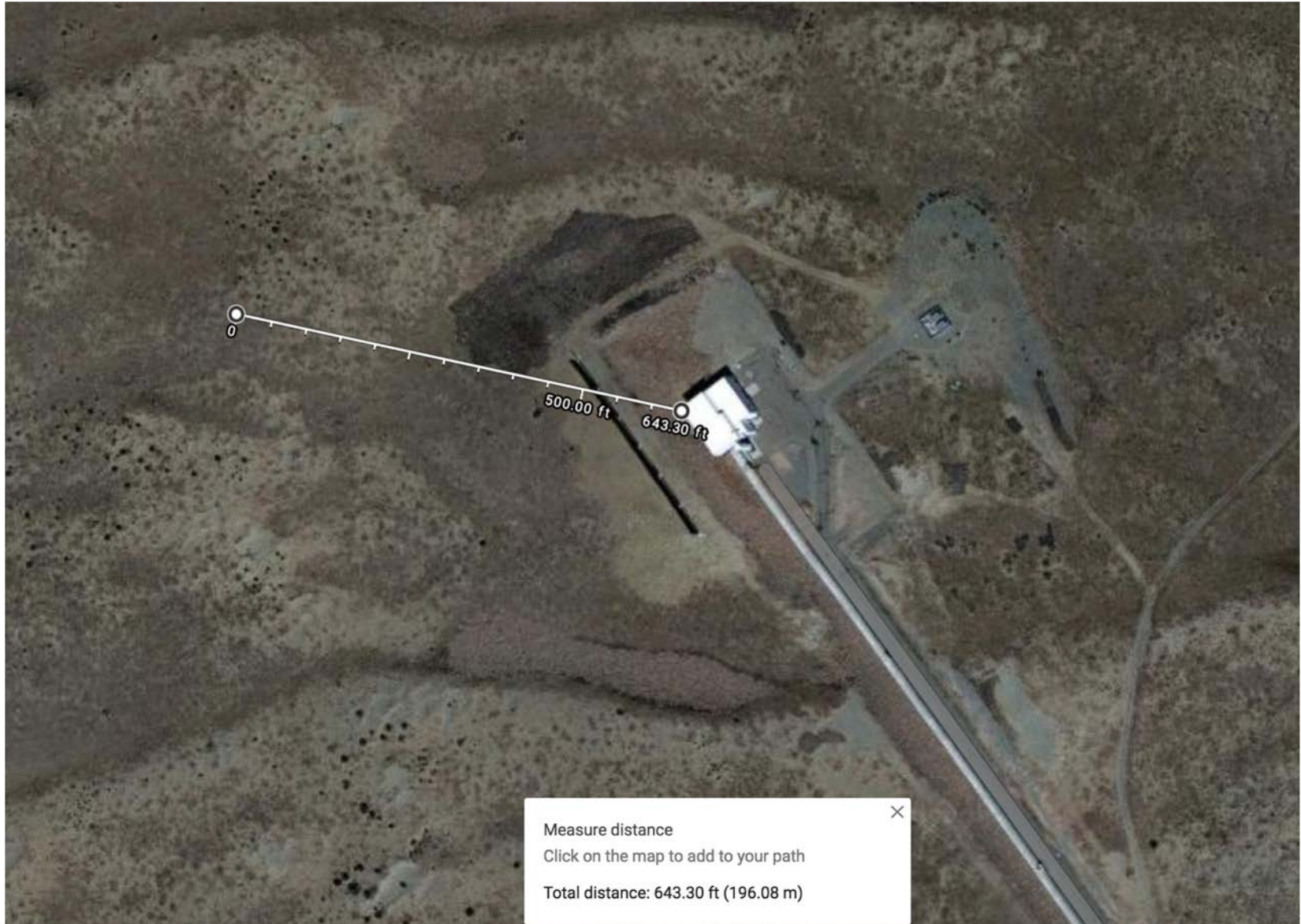

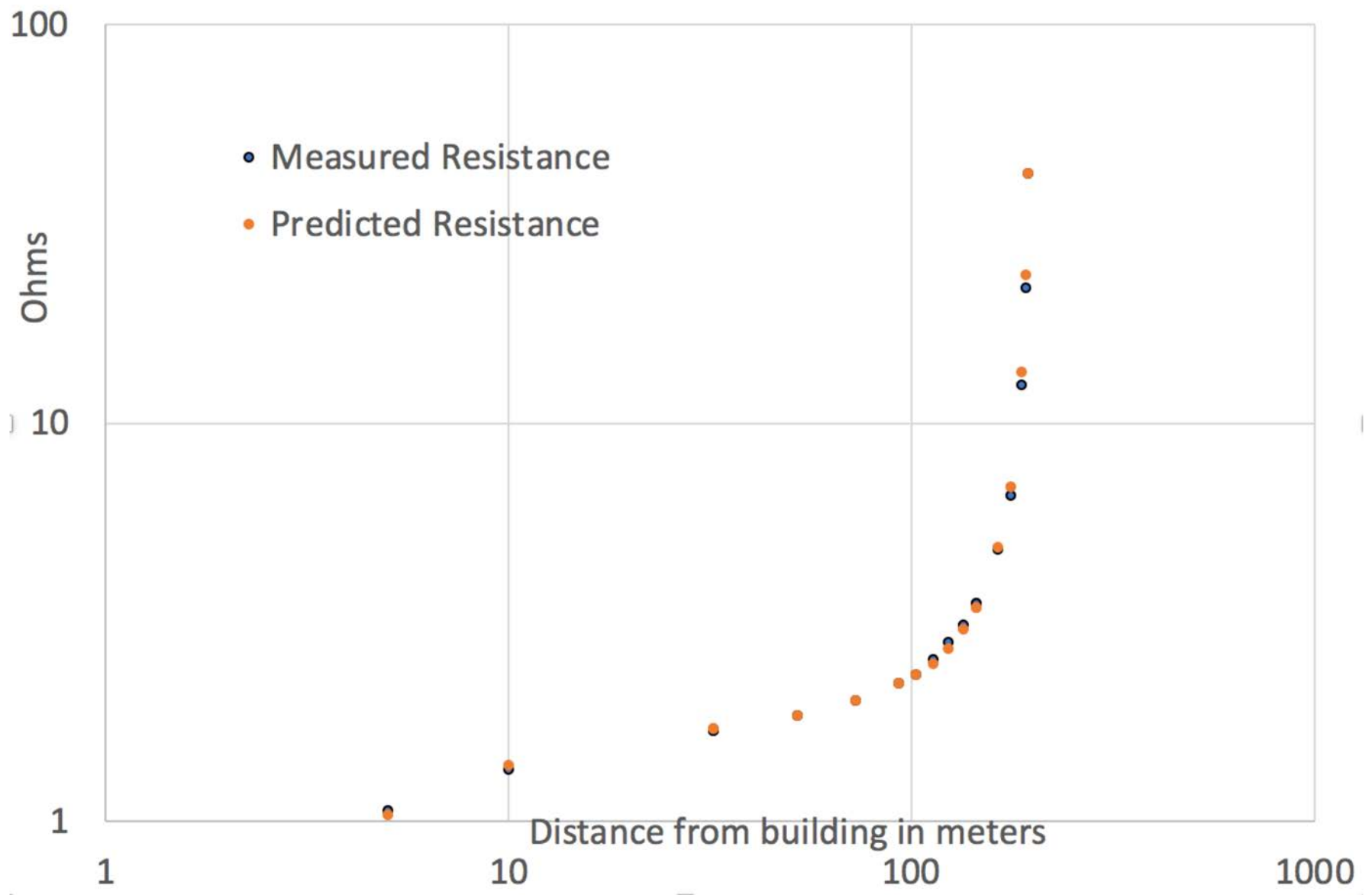



Manifold/Cryopump Baffle: "Cryo-baffle"

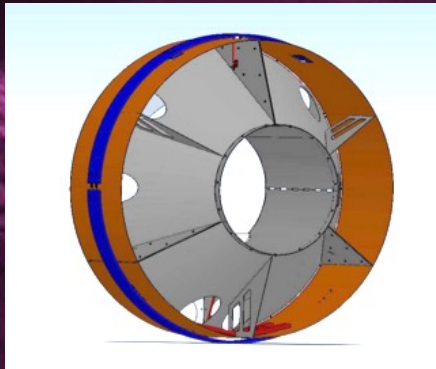

Photographed while at full sensitivity, lit by scattered infrared beam.

cryo-baffle

transmission monitor (TMS)

p-cal periscope

arm cavity baffle (ACB)

ETMY test mass

annular reaction mass with electrostatic drive traces (concentric lines)