

# Seismic measurements with optical sensors

A Seismic Platform Interferometer in the aLIGO infrastructure?

Sina Maria Köhlenbeck and Brian Lantz

# Why do we want more sensors?

- Seismic noise is very well attenuated in DARM
- But: Auxiliary control loops contaminate gravitational wave band
- Stray light
- Excess noise below 30 Hz

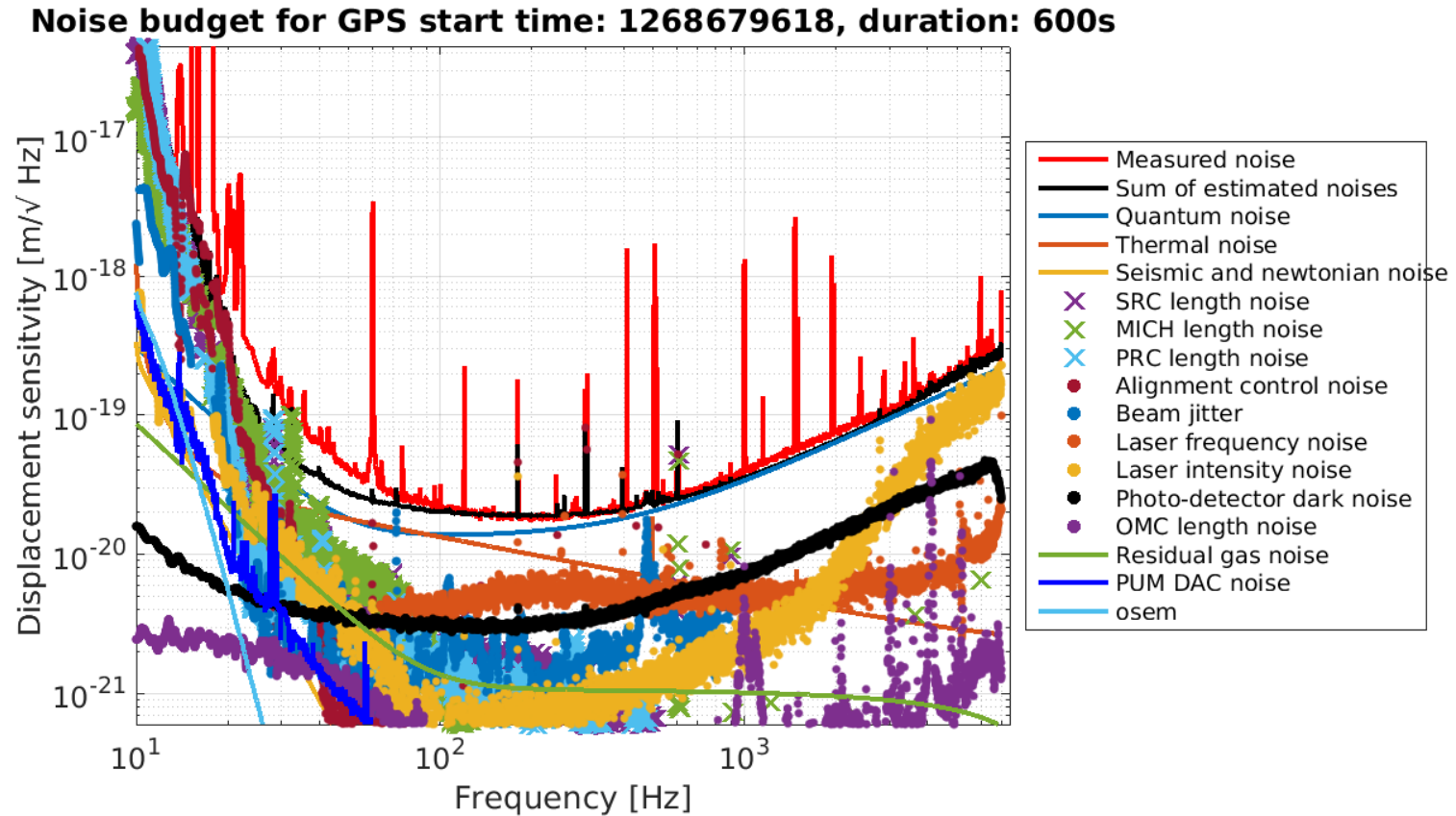

# Why can more seismic isolation help?

Input noise reduction allows change in auxiliary control loop bandwidth:

- Noise out-side control bandwidth from sensor
- Bandwidth set by residual rms motion
- Filter cannot be more aggressive
- Solution: Reduce input motion

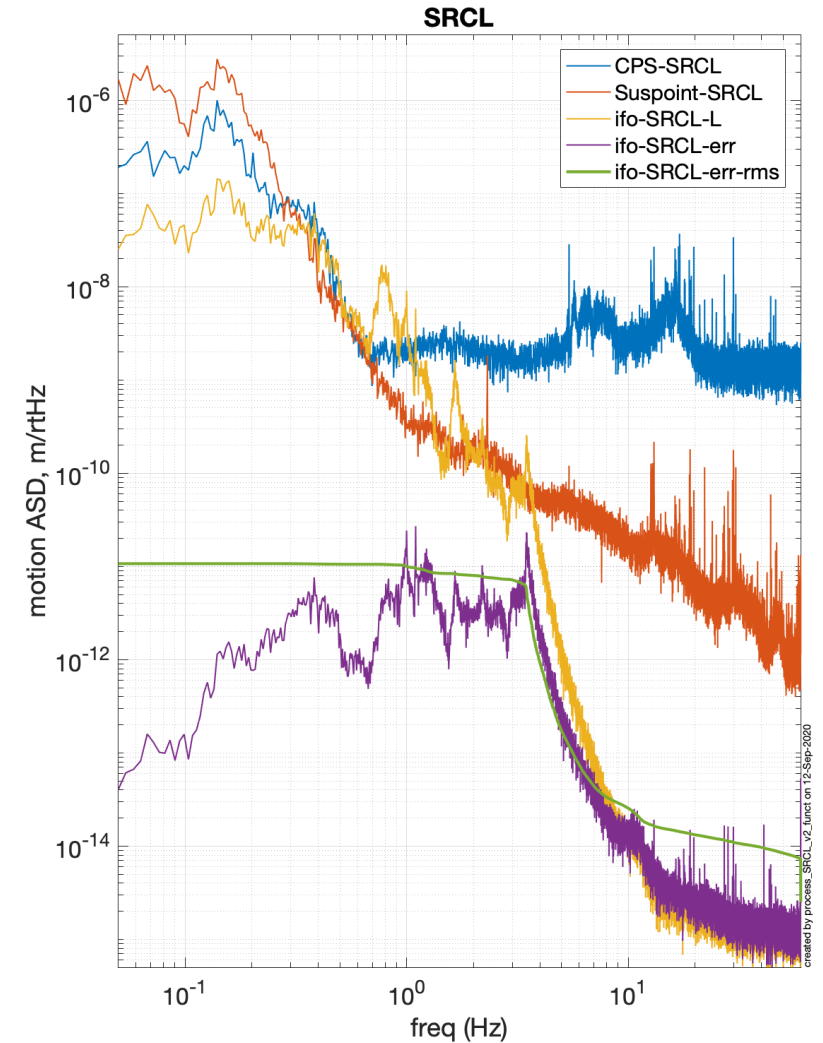

# Why not more inertial isolation?

- We would if we could
- Feedback cavity length to ISI?
- Okay, but only when at operation point
- Mirror suspension allows feedback only below suspension resonances

## SEI Sensors and Their Noise

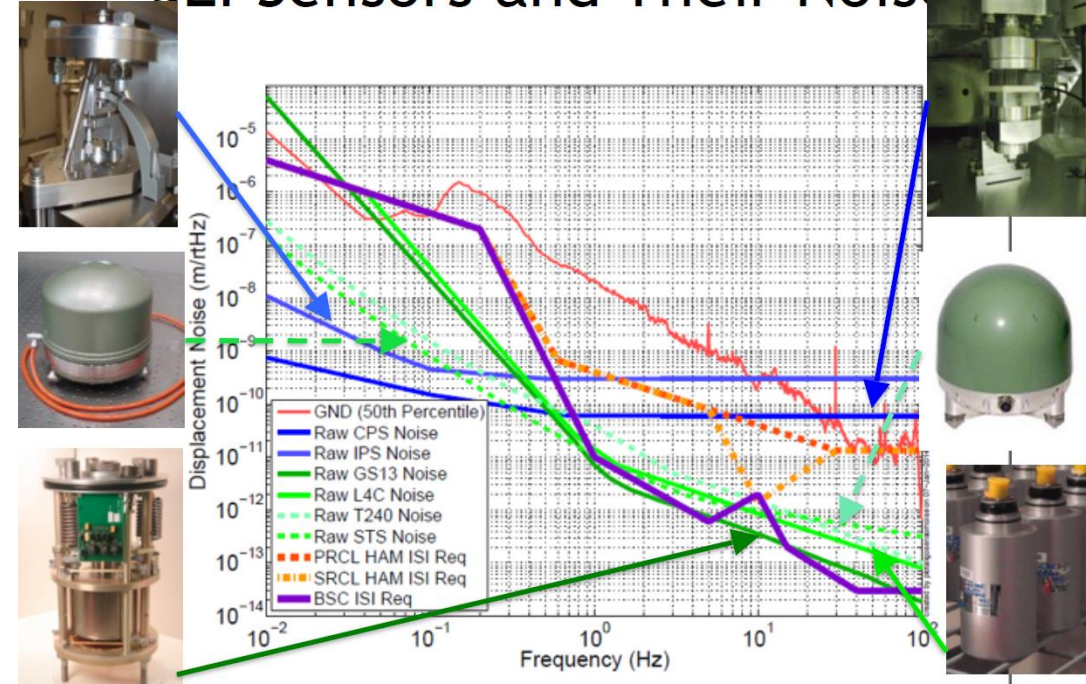

# Why not use the best tool at our hand?

- Interferometer!
- Auxiliary interferometer to measure relative seismic platform displacement.

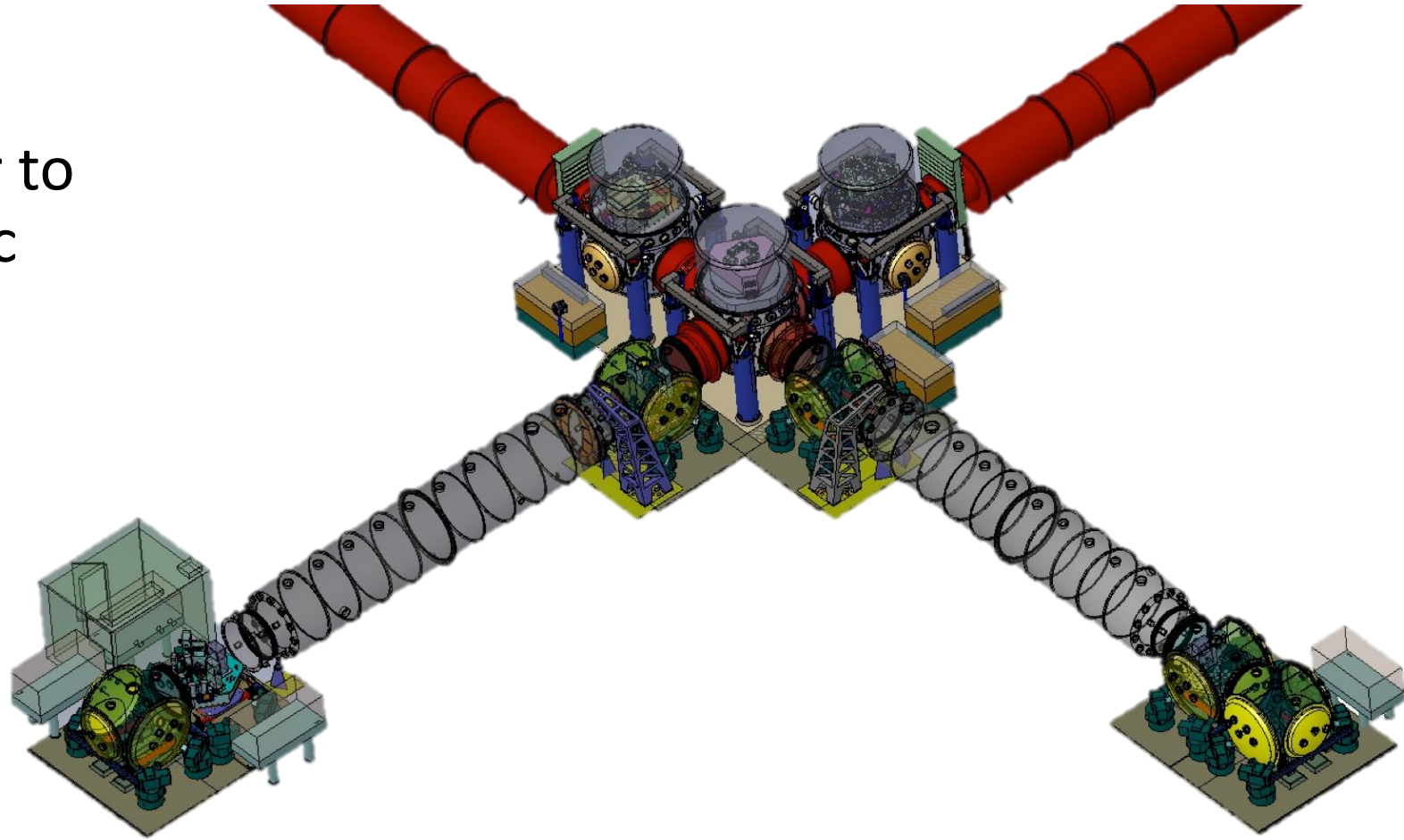

# Where could we put it?

- Table tops are crowded but sides are blank

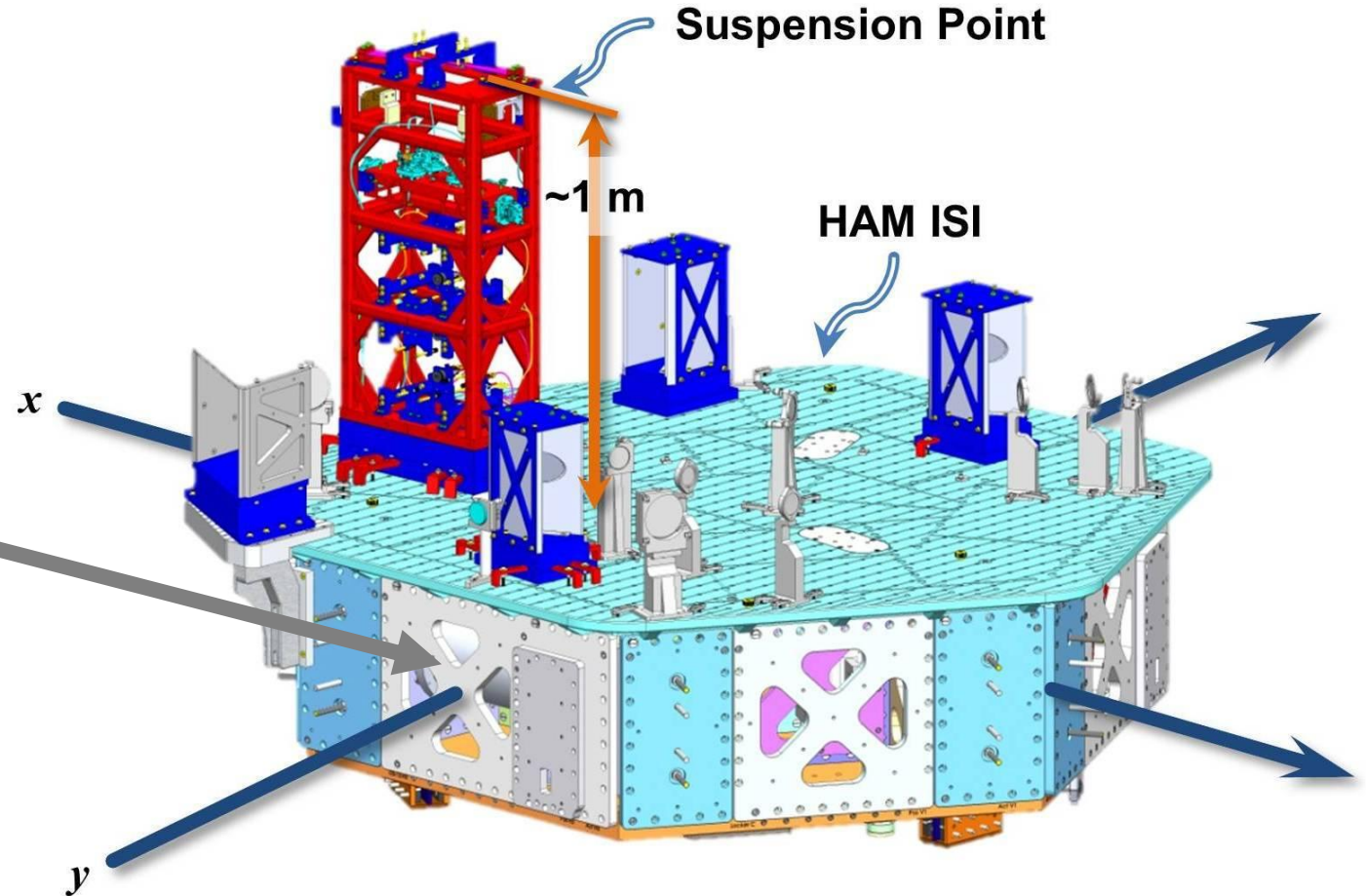
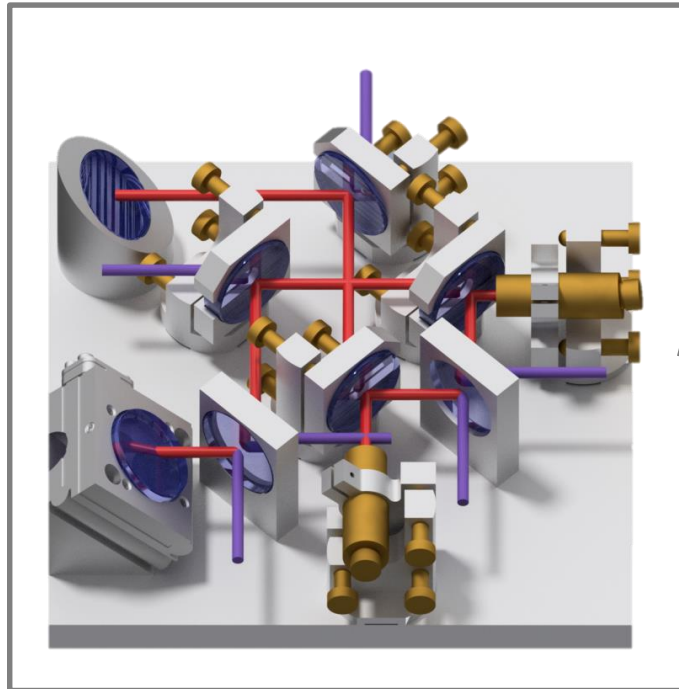

# What kind of interferometry?

- Multi-fringe readout for out of loop characterization
- Heterodyne interferometry
  - Well known
  - Tested at the AEI 10m-Prototype
- Inherent large arm-length difference

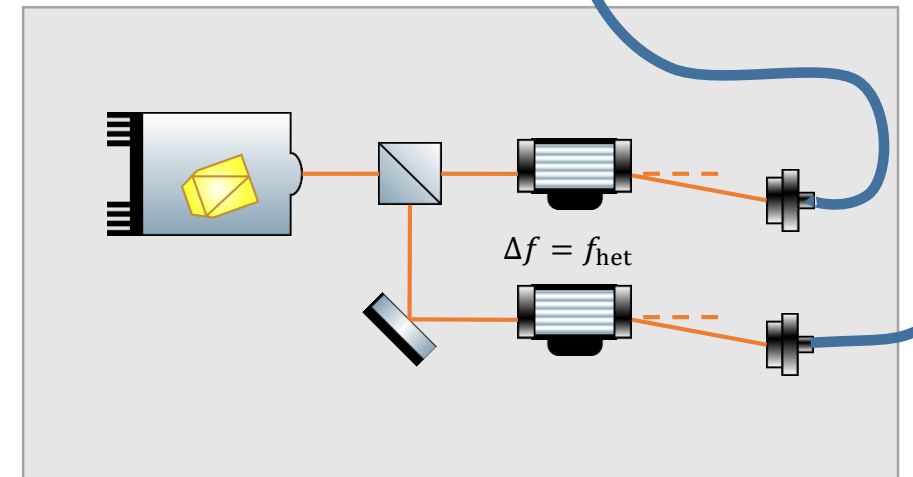
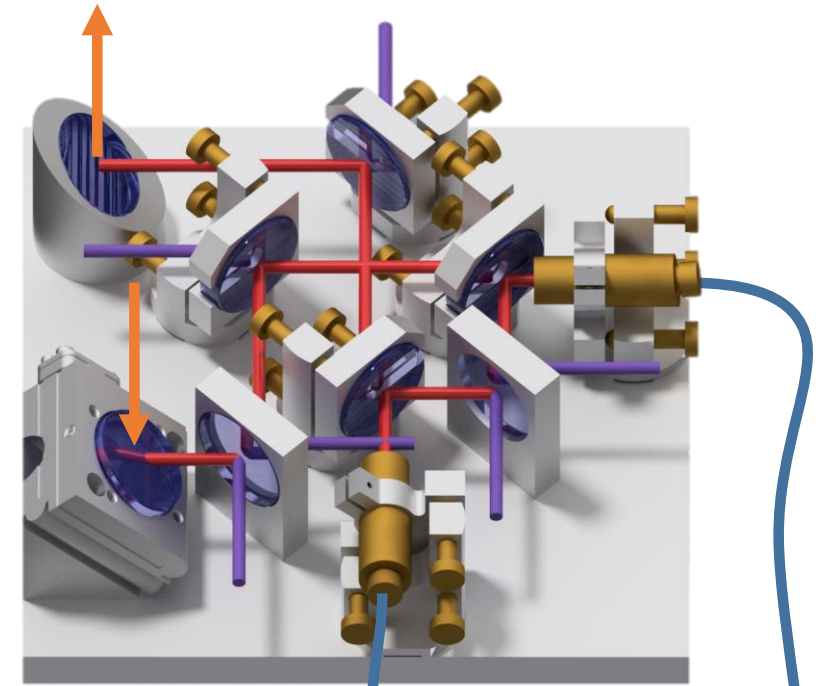

# Laser frequency noise

- Main laser should have low frequency noise
- Offset by defined frequency
  - AOM
  - Auxiliary laser lock
- External reference
  - Molecular reference system
  - Self-made interferometric reference

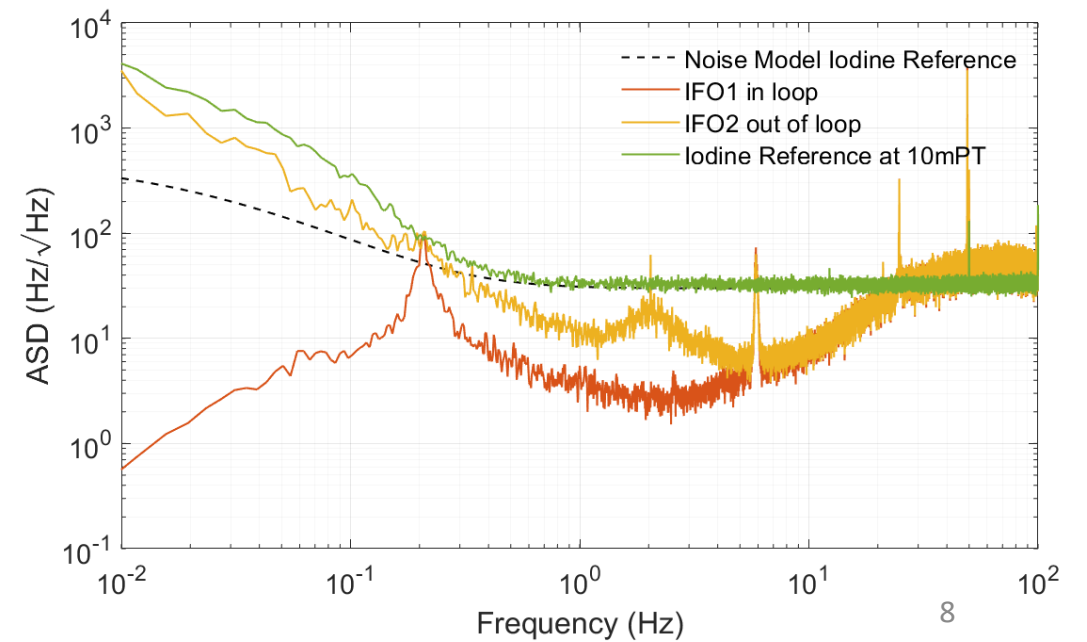
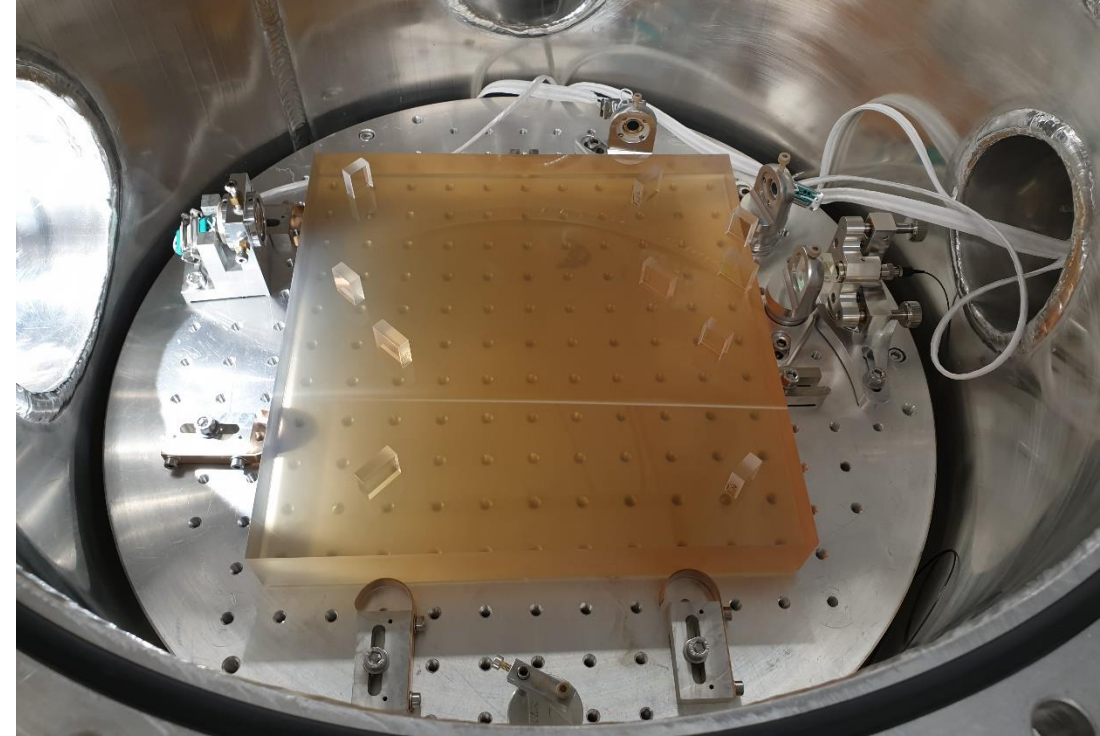



# Phase read out

- Compute interferometer length from IQ demodulation at specific heterodyne frequency
- Utilize existing hardware
- CDS based phasemeter

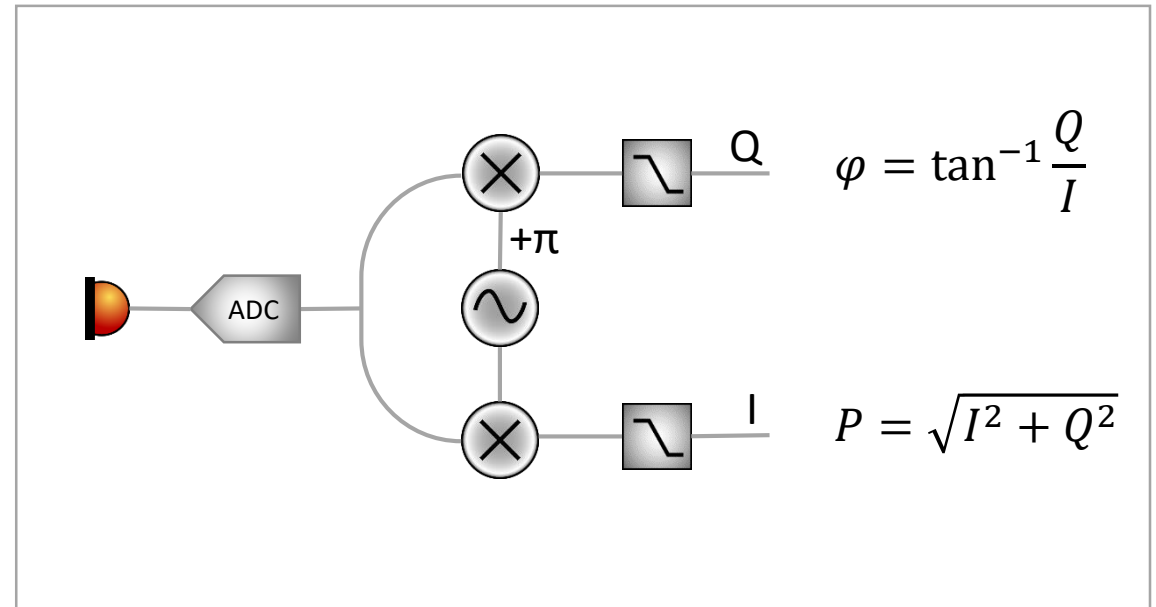

# Testing the CDS Readout

- Real signal from photodetector
- Heterodyne Interferometer
- Two AOM for kHz frequency offset

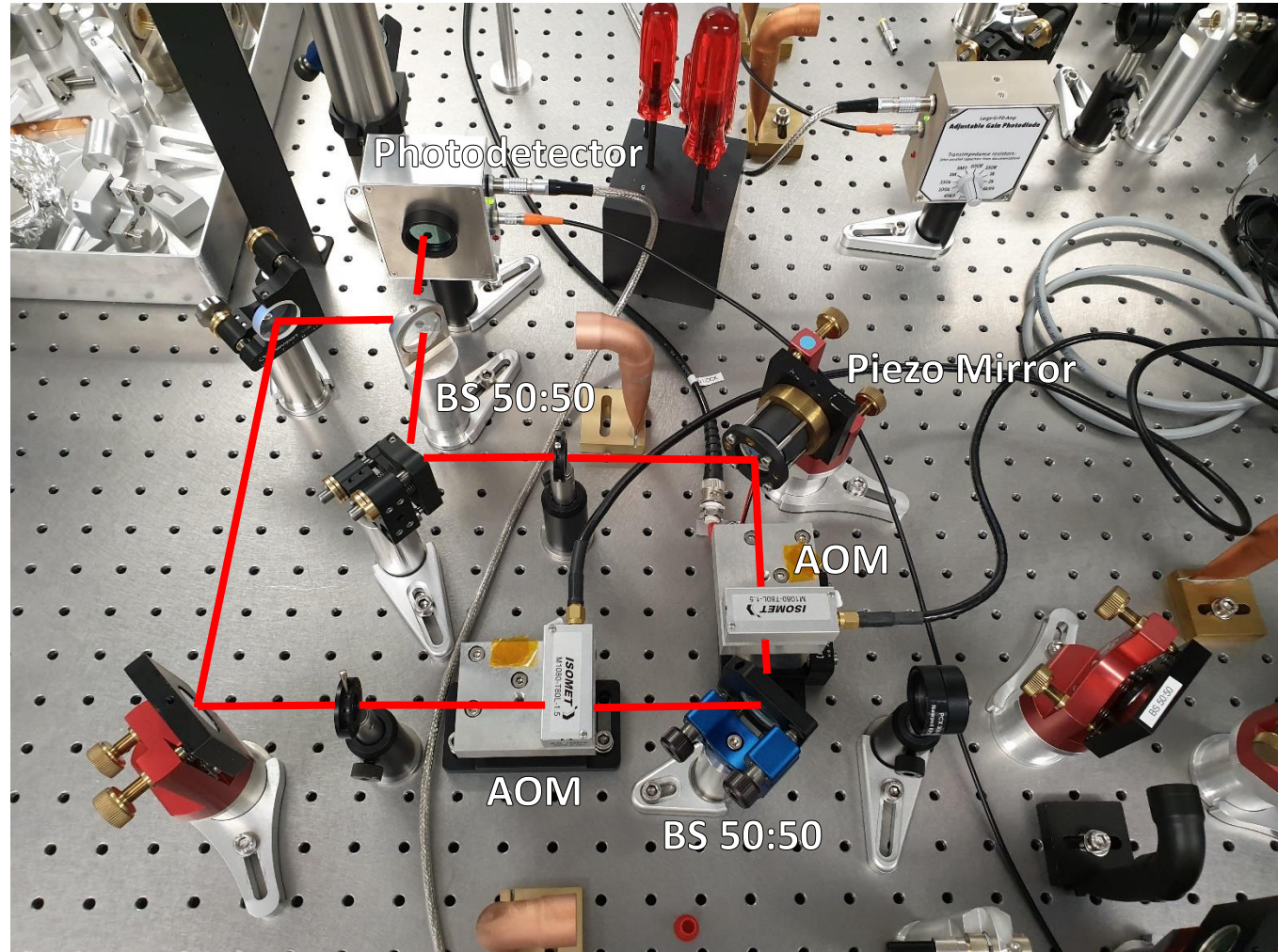

# Testing the CDS Readout

- Interferometer with piezo actuator in one arm
- Simulate seismic displacement
- Drive piezo element with HV amplifier to create large displacements

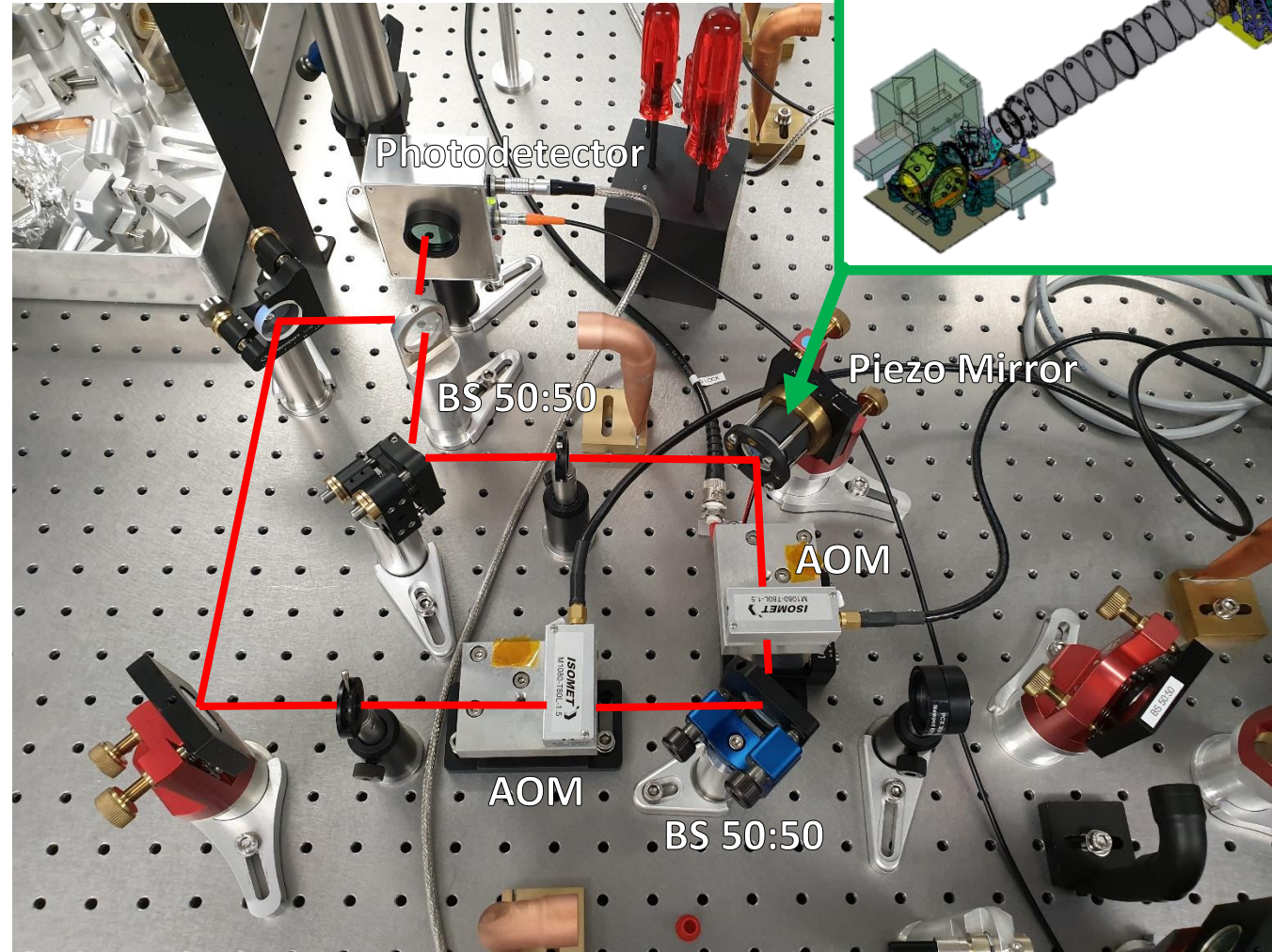

# Testing the CDS Readout

- Apply filtered Gaussian noise to piezo
- Measure interferometer output with a photodiode
- Photodetector signal digitized by CDS

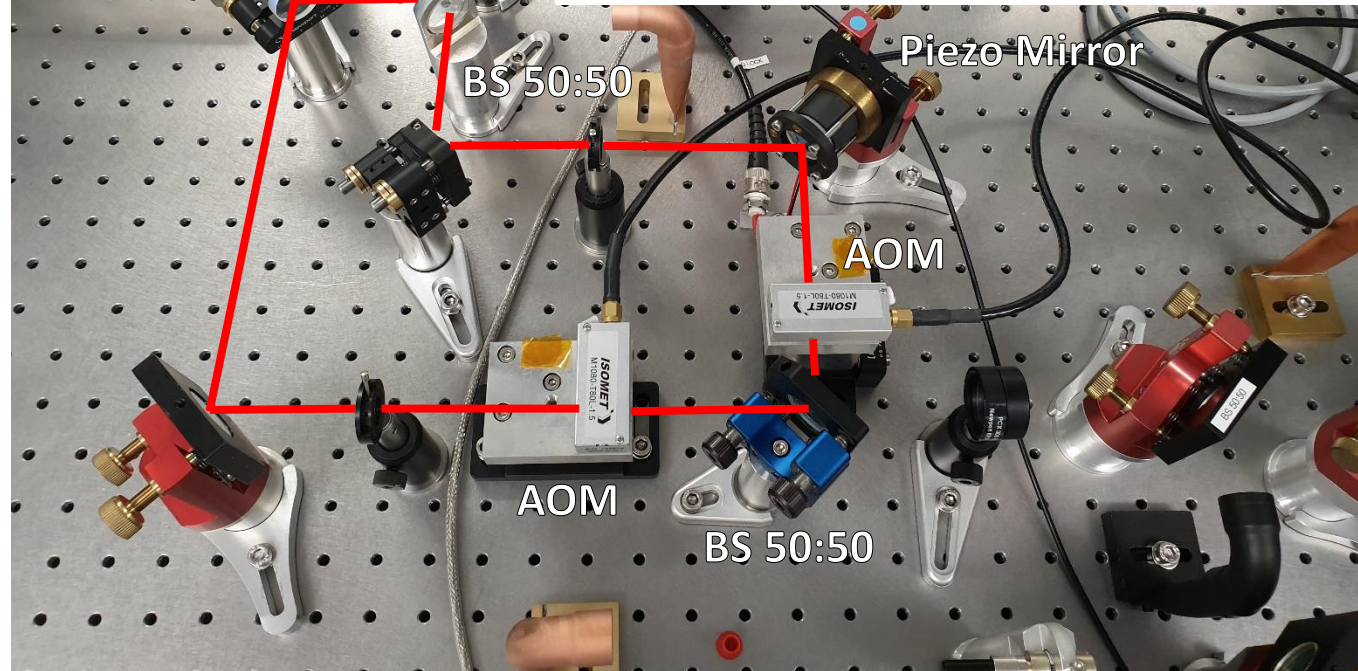
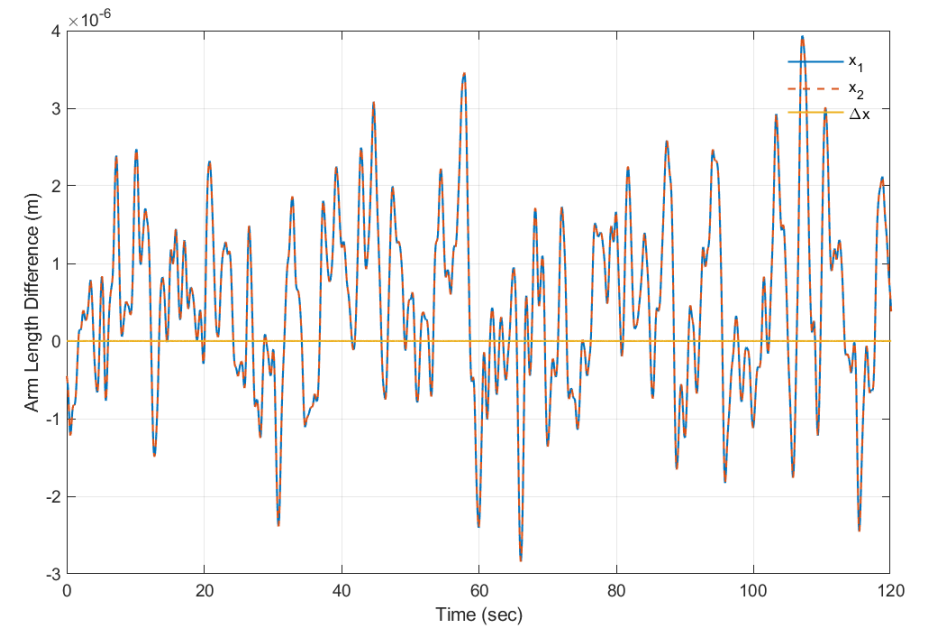

# Testing the phasemeter readout

Split signal test:

- Split the photodetector signal in two parts
- Two individual phasemeters
- Subtract signal to determine noise floor

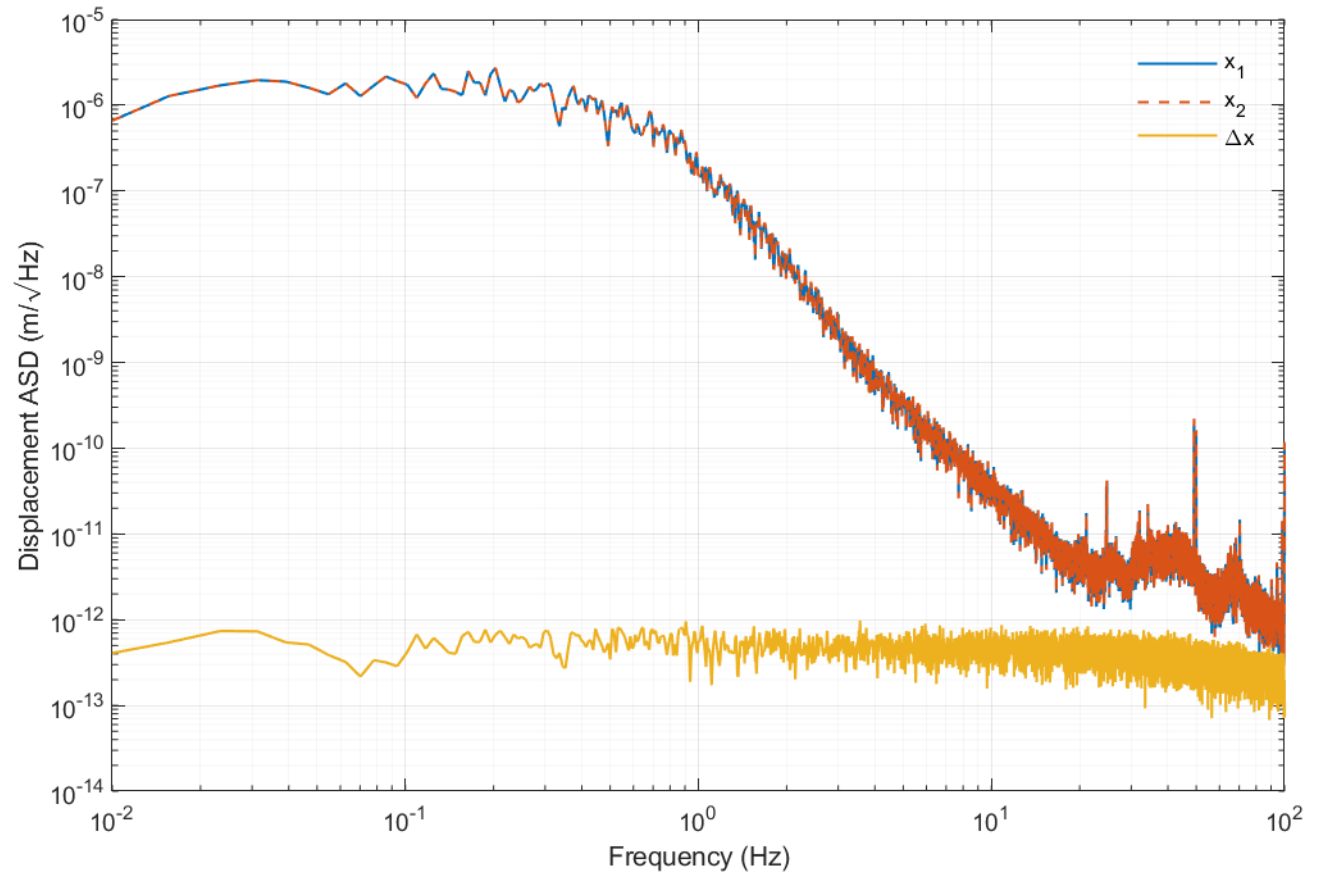

# What now?

The platform motion is not the suspension point motion!

Luckily only three degrees of freedom are of importance:

- Differential length
- Pitch
- Yaw

Multiple interferometers or optical levers

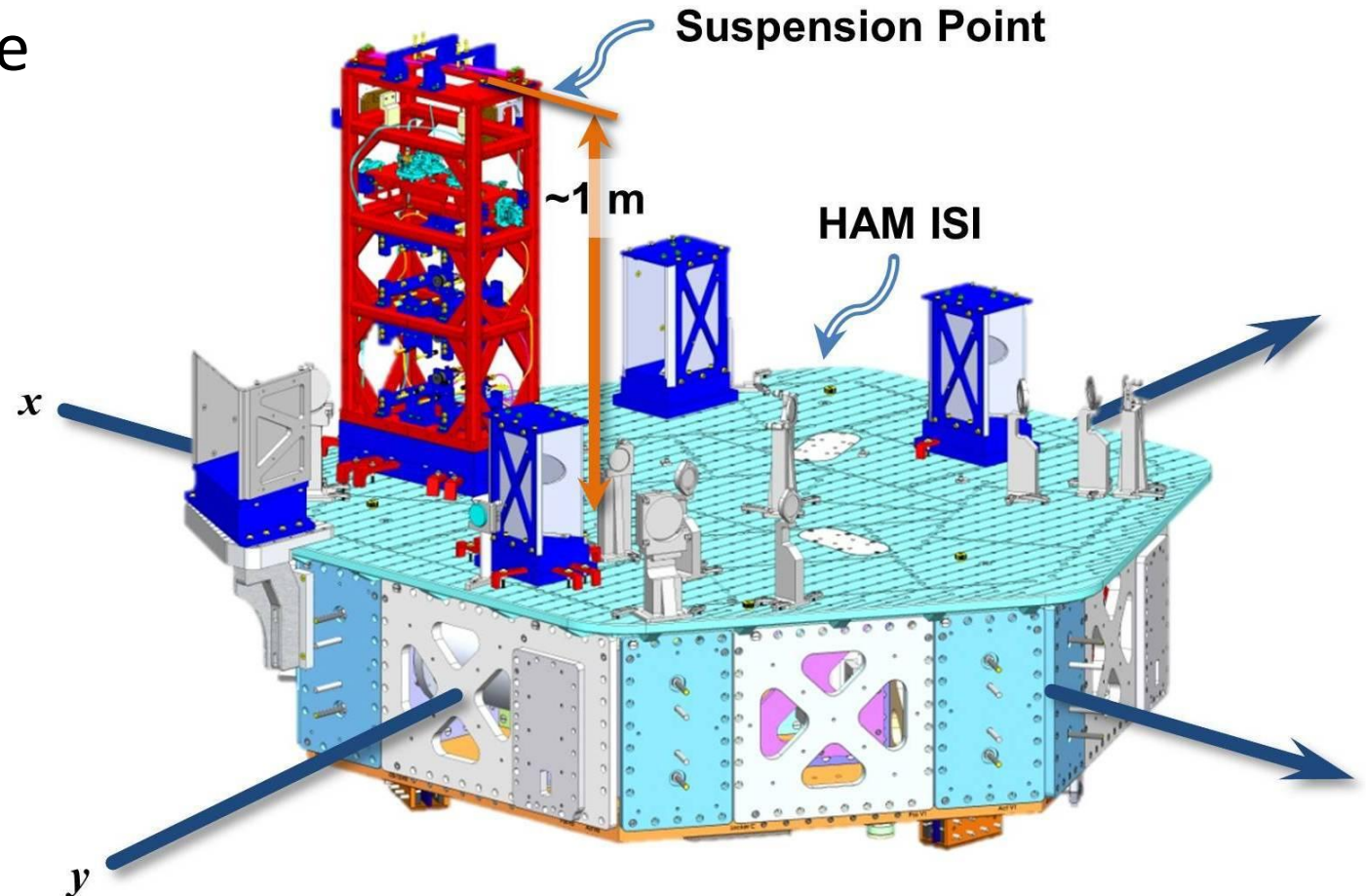

# What geometry could we choose?

## Three point interferometer

- High signal-to-noise ratio
- Coupling of length to angle
- Differential rotation

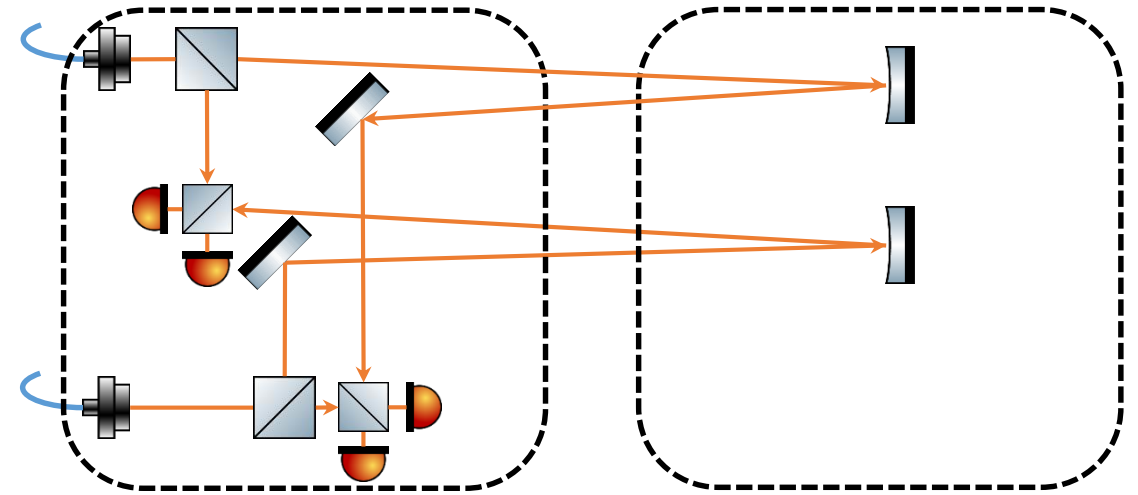

# What geometry could we choose?

## Three point interferometer

- High signal-to-noise ratio
- Coupling of length to angle
- Differential rotation

## Optical lever with sending and detection on the same isolation system

- Decoupled from translations
- Coupling of the rotations of the two isolation systems

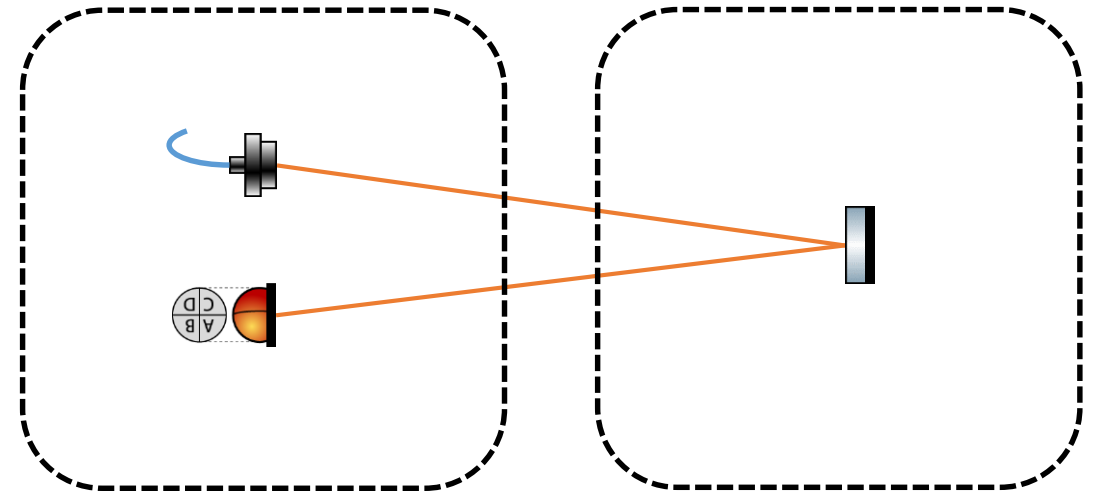



# What geometry could we choose?

## Three point interferometer

- High signal-to-noise ratio
- Coupling of length to angle
- Differential rotation

## Optical lever with sending and detection on the same isolation system

- Decoupled from translations
- Coupling of three rotations of the two isolation systems

## Optical lever with sending on one and detection on the other isolation system

- Rotation sensing for individual isolation systems
- Coupling to translation degrees of freedom

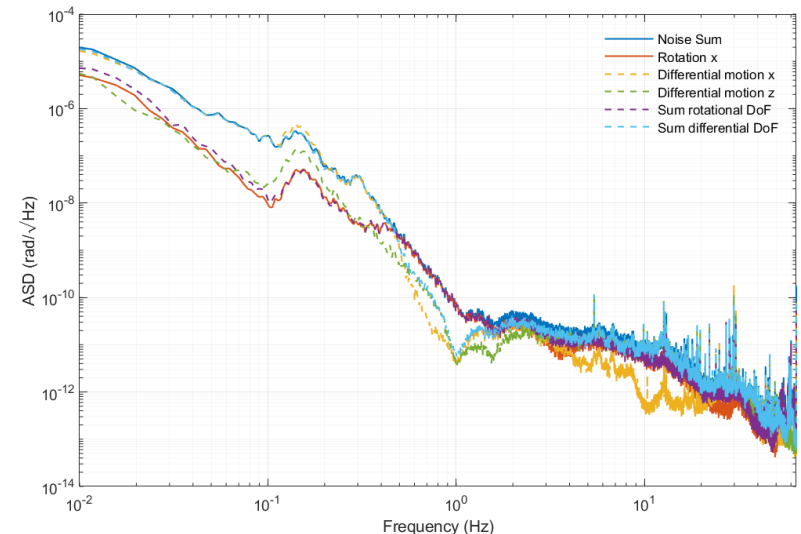
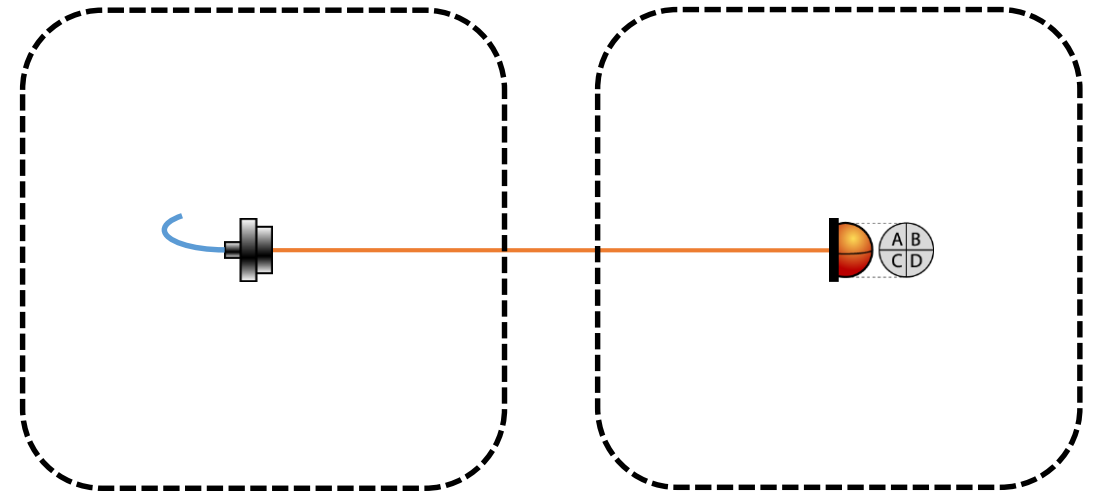

# What geometry could we choose?

## Three point interferometer

- High signal-to-noise ratio
- Coupling of length to angle
- Differential rotation

## Optical lever with sending and detection on the same isolation system

- Decoupled from translations
- Coupling of thee rotations of the two isolation systems

## Optical lever with sending on one and detection on the other isolation system

- Rotation sensing for individual isolation systems
- Coupling to translation degrees of freedom

Let's meet at the low frequency workshop!

