

# Gravitational wave detection with laser interferometers

Koji Arai – LIGO Laboratory / Caltech

# Gravity = Spacetime curvature



## Albert Einstein: General Relativity

$$G_{\mu\nu} = \frac{8\pi G}{c^4} T_{\mu\nu}$$

spacetime  
curvature

energy density  
(e.g. mass)

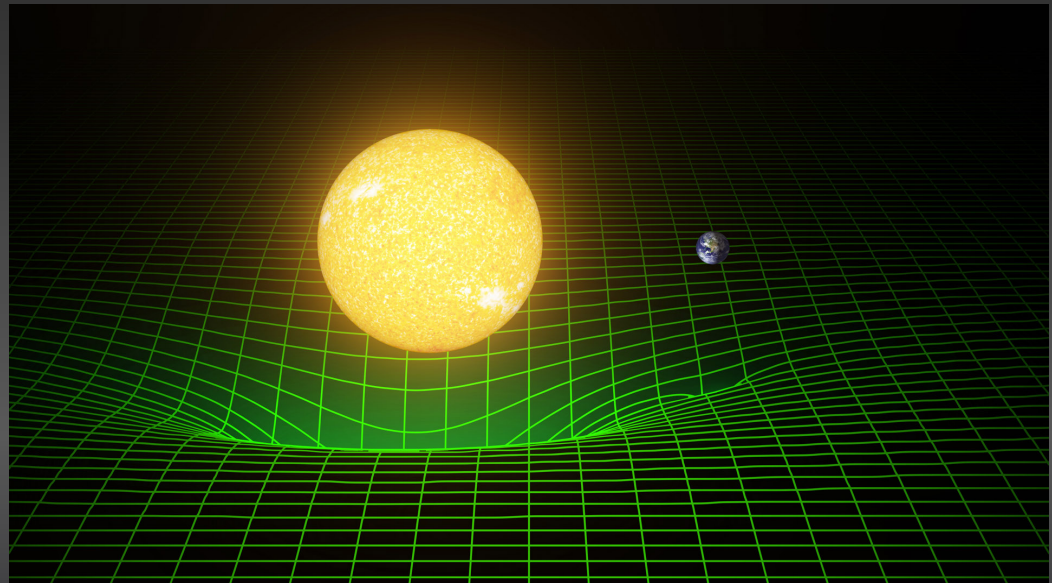

Credit: Caltech/MIT/LIGO Lab

# Gravitational waves



Small perturbation of the spacetime

$$g_{\mu\nu} = \eta_{\mu\nu} + h_{\mu\nu}$$

spacetime metric      flat spacetime      perturbation

→  $\square h_{\mu\nu} = 0$  wave equation

Ripples  
in spacetime

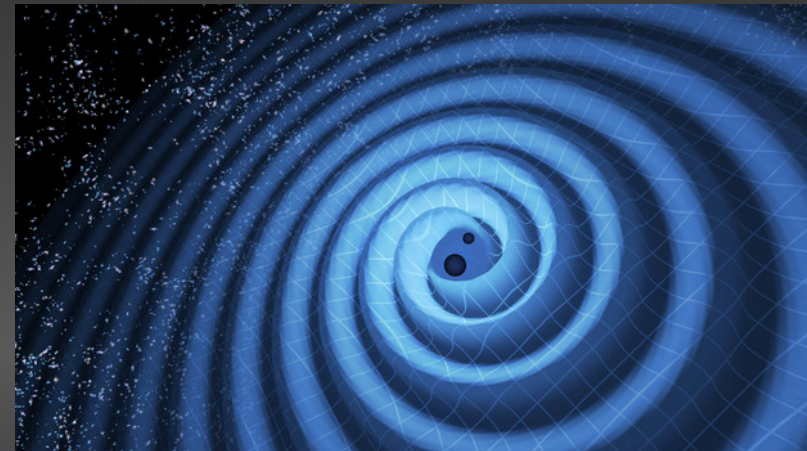
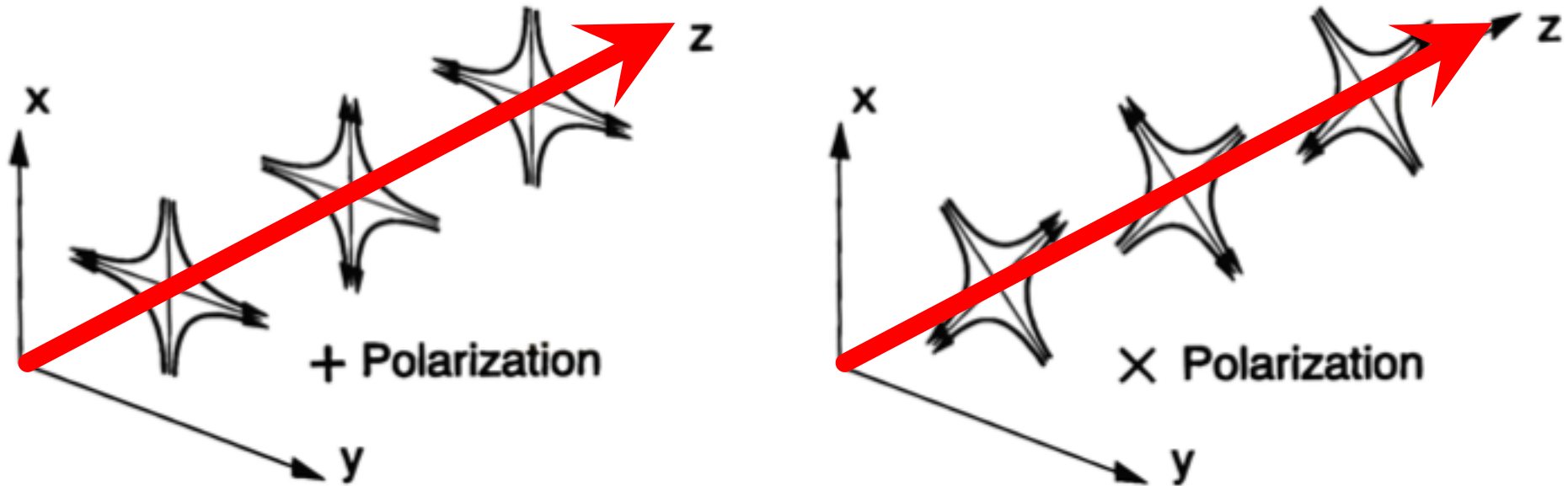

Image credit: LIGO/T. Pyle

# Two modes of gravitational waves



Quadrupole strain pattern

# GW Detection

- Two free-falling masses

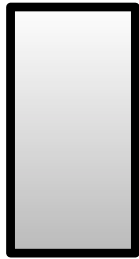

- Free fall? Free mass?

=> Equivalence principle



# GW Detection

- Optically measure strain between free masses

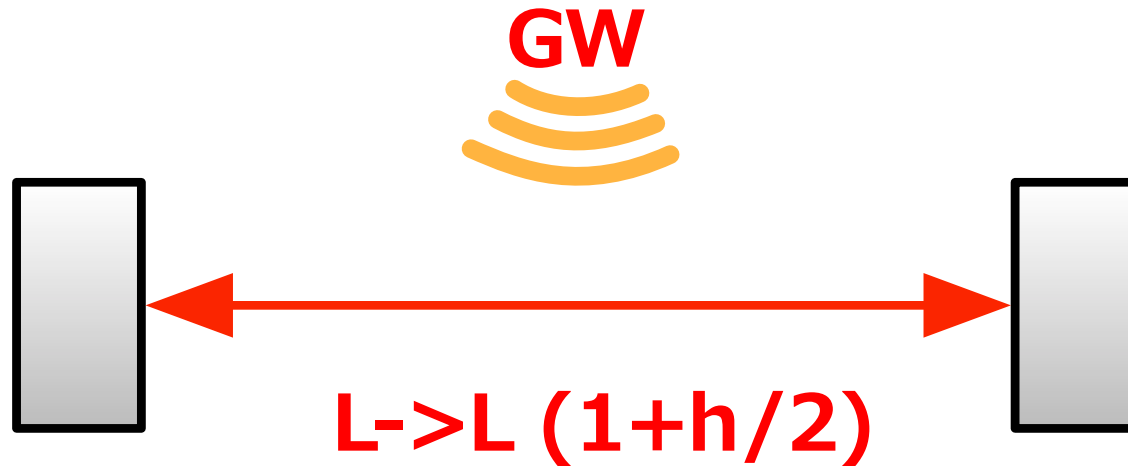

- GWs do not appear in the local motions
- The effect appears in the optical distance between the masses

# GW Detection

- Measure strain between free masses

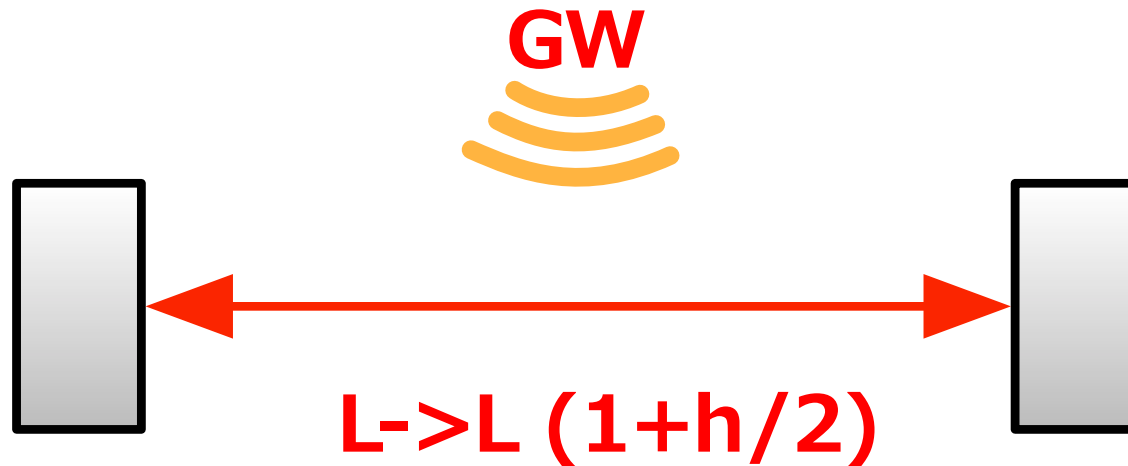

- GW does not appear in the local motion
  - Changes optical distance between the masses
- Longer the baseline, the bigger change
    - (displacement  $dx$ ) = (Strain  $h$ ) x (baseline  $L$ )

# GW Detection



- **Q: What happens if**
  - The mirrors are not free-falling
  - The distance is measured with a tape measure with infinite precision



# GW detection with a laser interferometer

- **Michelson-type interferometer**
  - With suspended mirrors

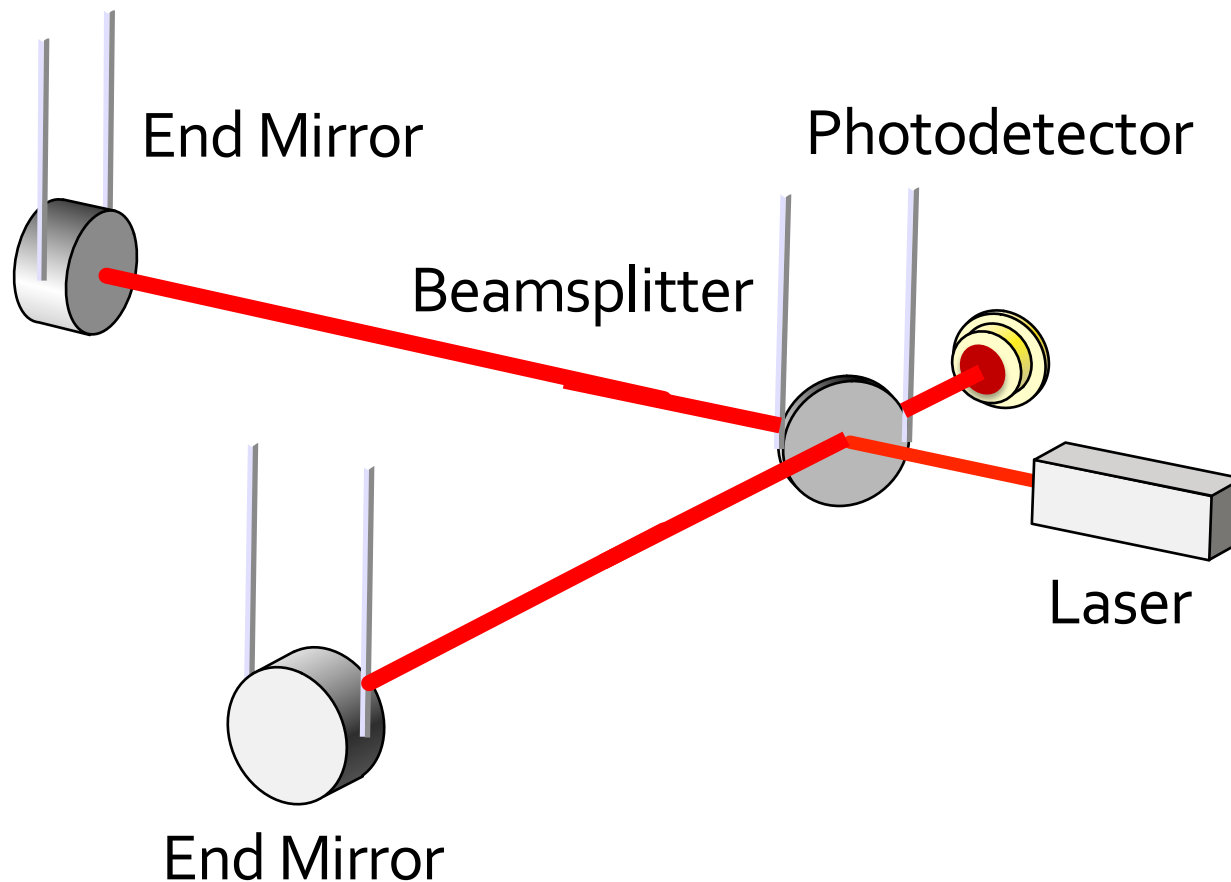

# GW detection with a laser interferometer

- Q: Why is the Michelson interferometer suitable for GW detection?

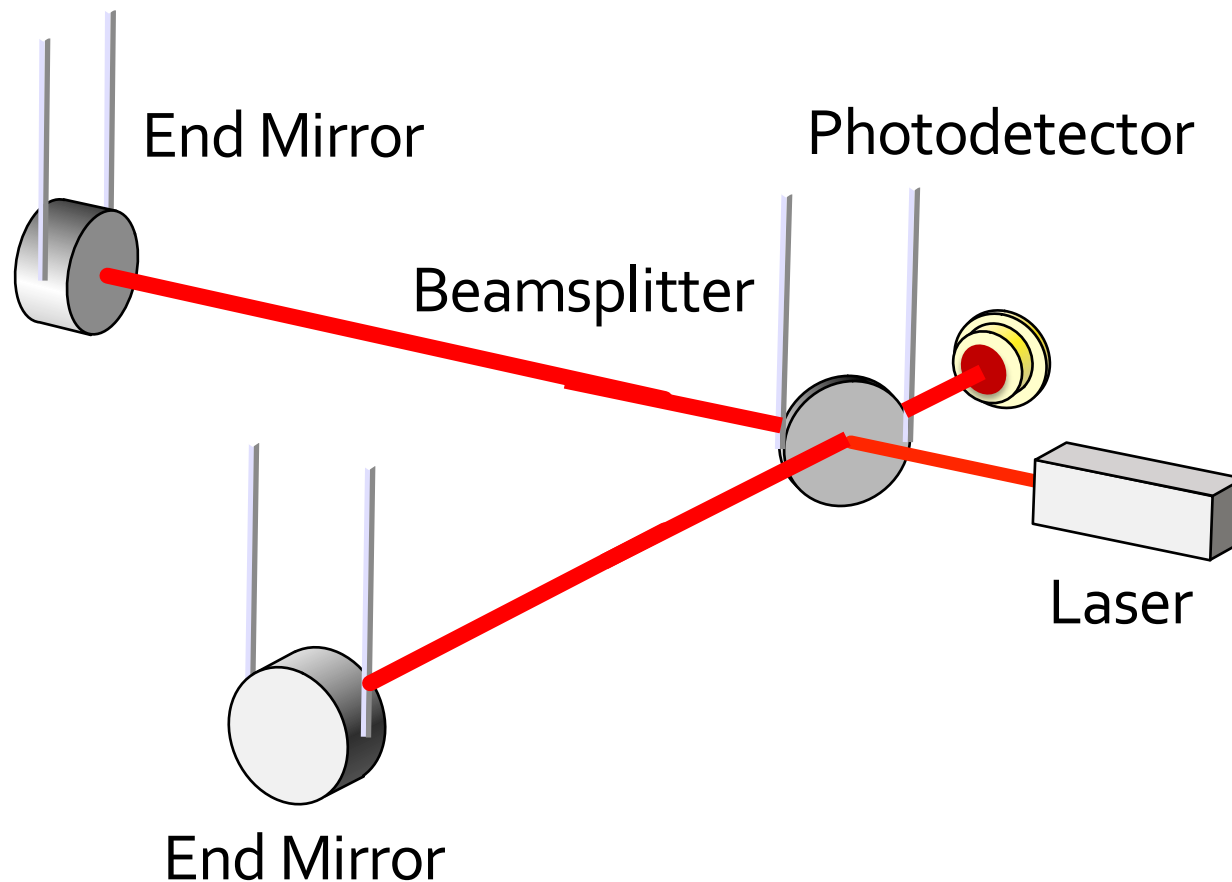

# GW detection with a laser interferometer

- **Michelson interferometer =**
  - Optical phase meter**
  - sensitive to differential arm displacement**
- The effect of GWs have the nature of differential strain
- Insensitive to the wavelength (=frequency) change of the laser
- Laser interferometry allows us to read the phase of the light
- Laser beams can be propagated long distance without power loss

# GW detection with a laser interferometer

- **Michelson-type interferometer**
  - With suspended mirrors
- **Differential path length change**
  - Intensity change at the output

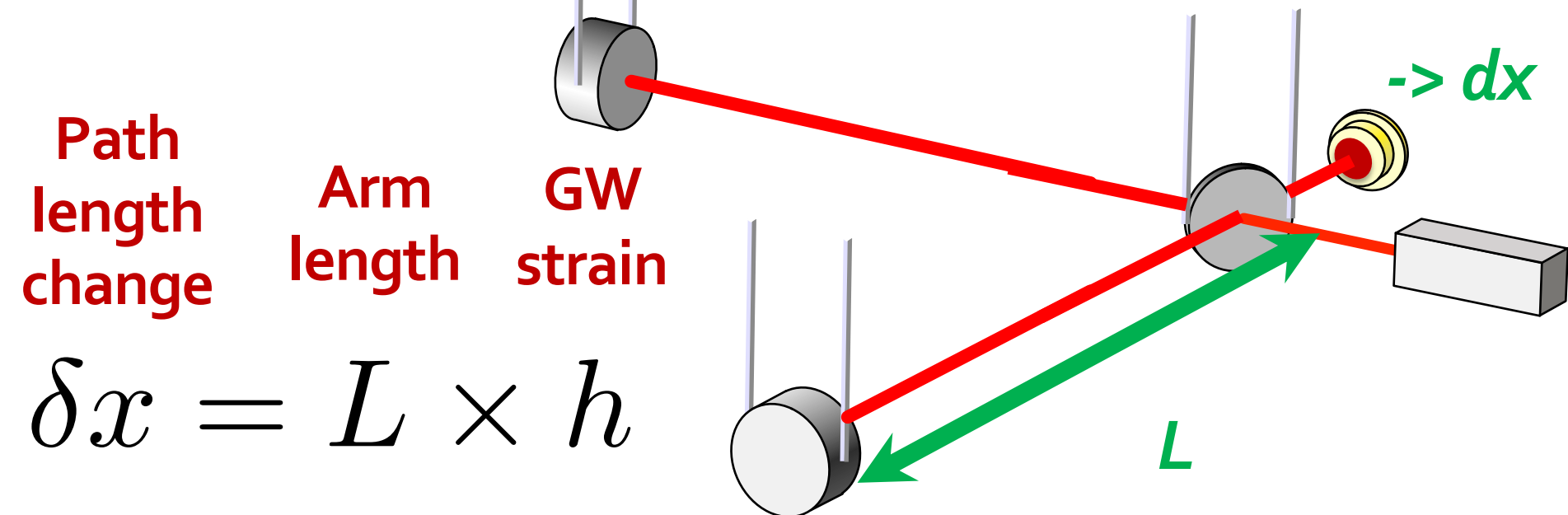
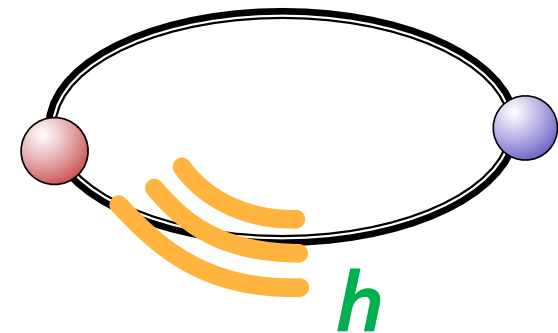

- **The longer the arms, the better!**

# GW detection with a laser interferometer

- Q: Why are the mirrors suspended?

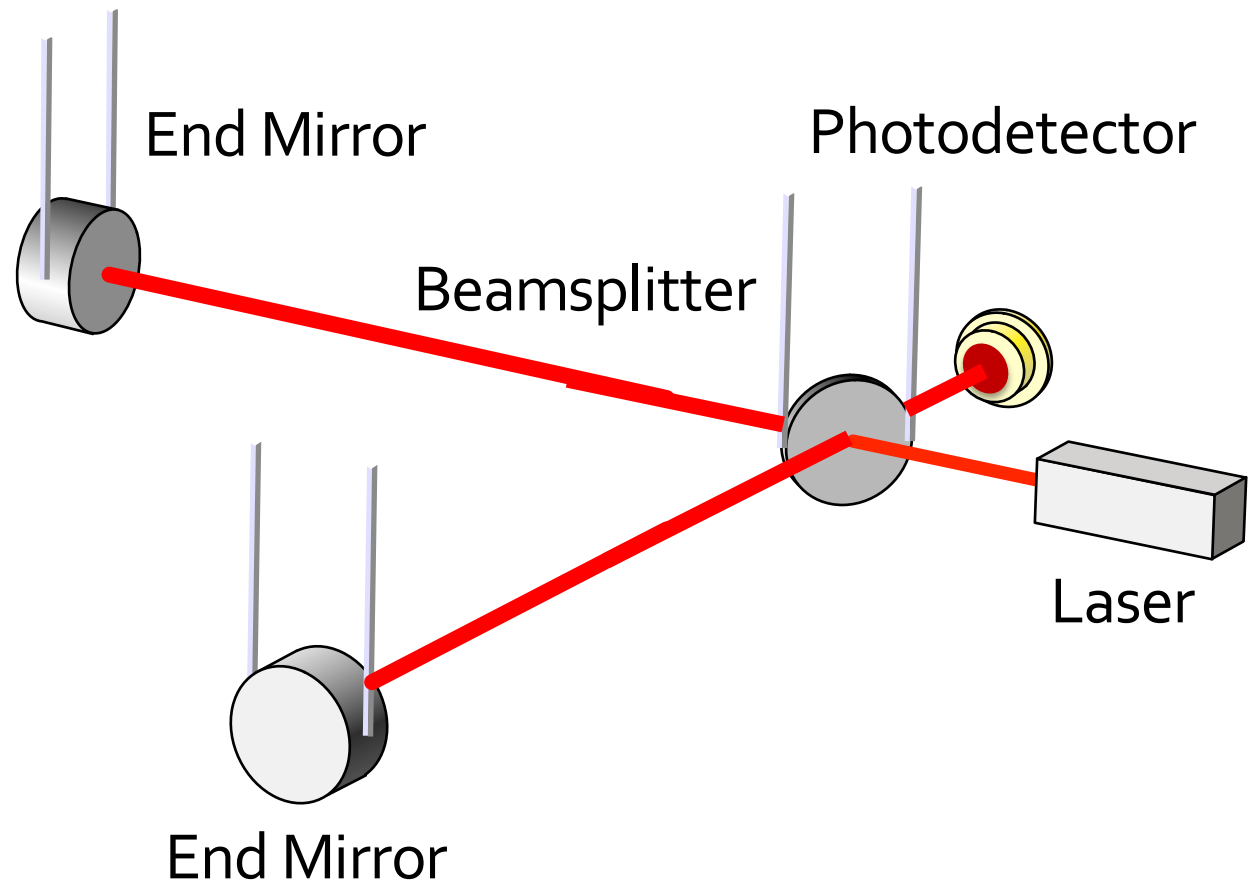

# GW detection with a laser interferometer

- Why are the mirrors suspended?

$$m\ddot{x} = -\frac{mg}{l}x + F_{\text{ext}}$$

$$\text{(F.T.)} \Rightarrow -\omega^2 \tilde{x} = -\omega_0^2 \tilde{x} + \tilde{F}_{\text{ext}}/m$$

$$(\omega_0 = \sqrt{g/l})$$

$$\Rightarrow \frac{\tilde{x}}{\tilde{F}_{\text{ext}}} = \frac{1}{m(\omega_0^2 - \omega^2)}$$

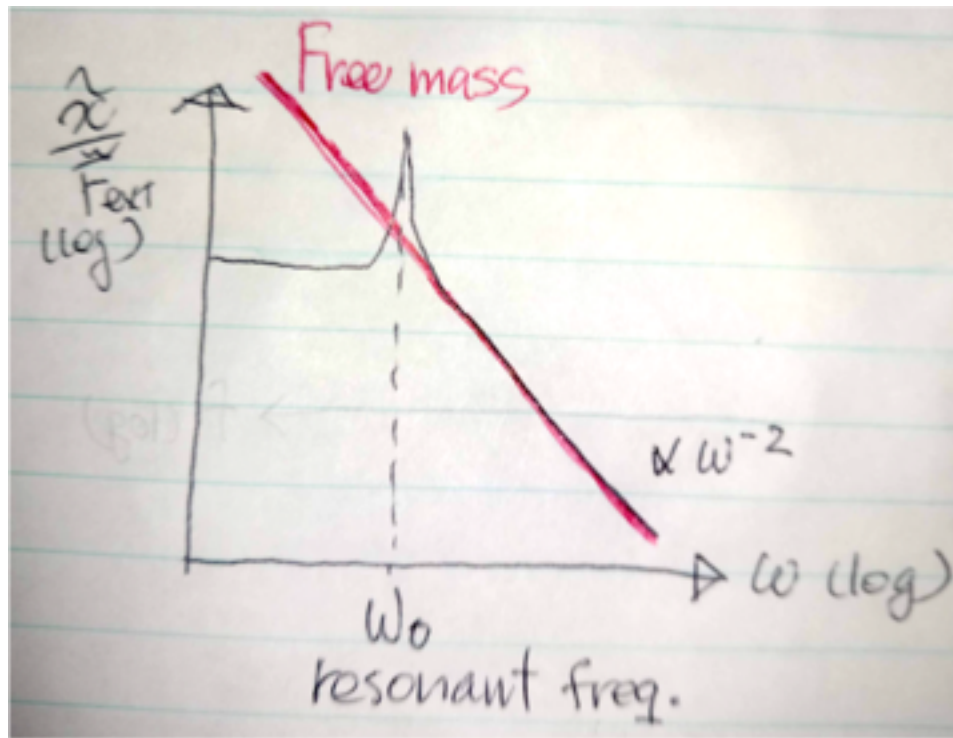

**Above the resonant (pendulum) frequency, a suspended mirror behaves as a free mass  
At least in horizontal directions.**

# GW detection with a laser interferometer

- **Plane light wave & propagation**
  - In a scalar model, the light field of a laser beam can be assumed as plane waves.

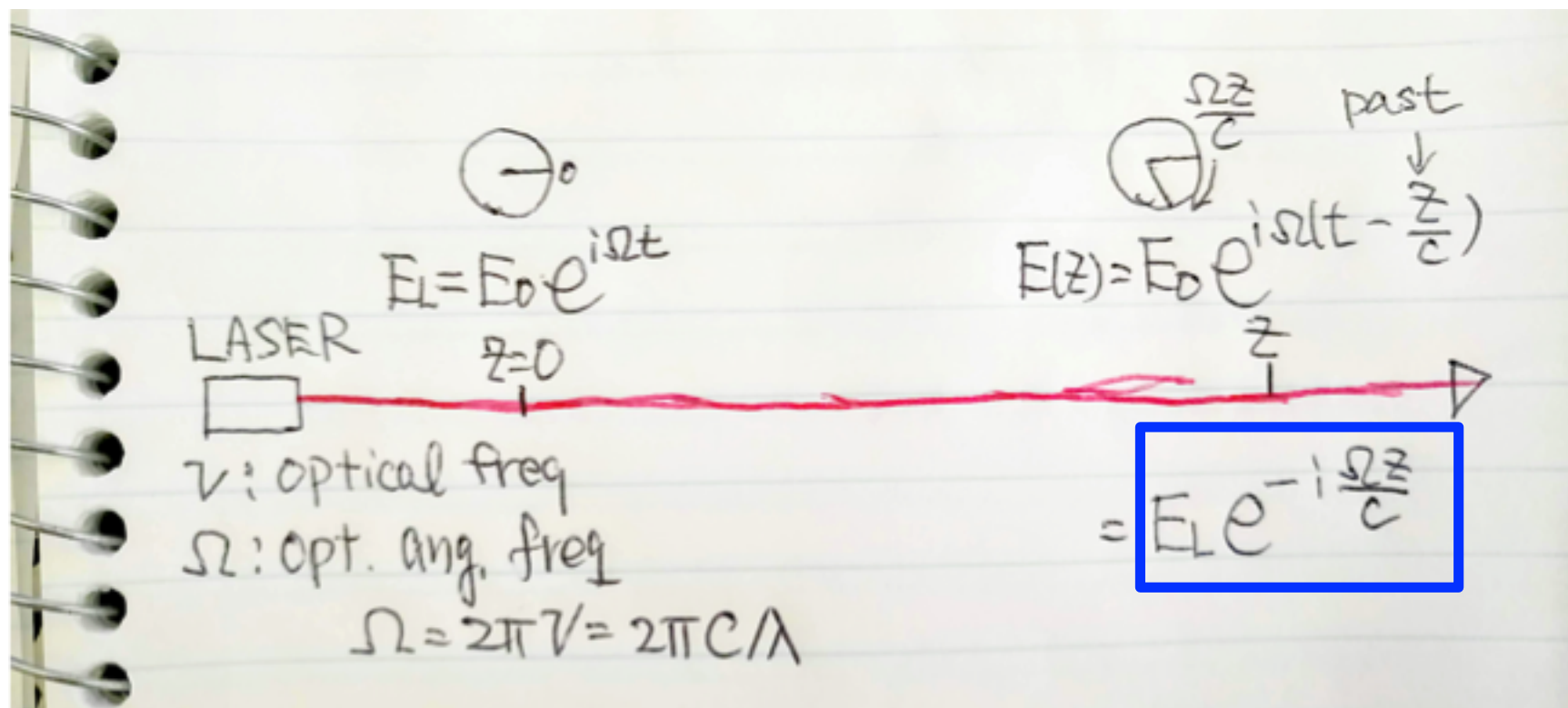

# Michelson interferometer

- Electric field in a Michelson interferometer

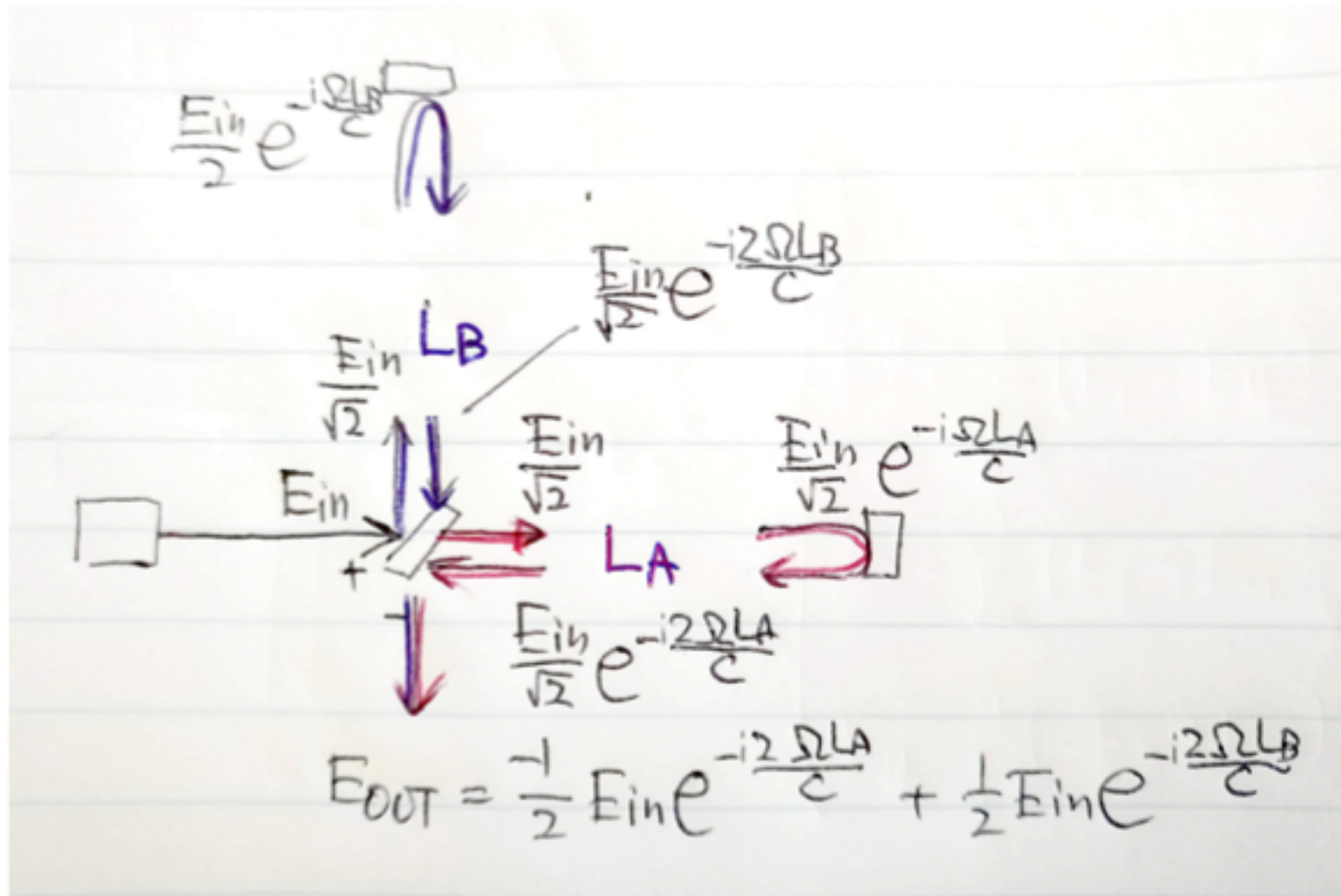



# Michelson interferometer

- Light intensity at the output port
  - Difference of the electric fields from the arms

$$E_{\text{out}} = \frac{1}{2} (e^{-i\phi_B} - e^{-i\phi_A}) E_{\text{in}}$$

(Roundtrip phase:  $\phi_x = 4\pi\nu L_x/c$ )

$$E_{\text{out}} = \left[ i e^{-i(\phi_A + \phi_B)/2} \sin \frac{\phi_A - \phi_B}{2} \right] E_{\text{in}}$$

$$P_{\text{out}} = E_{\text{out}} E_{\text{out}}^* = \left( \sin^2 \frac{\phi_A - \phi_B}{2} \right) E_{\text{in}} E_{\text{in}}^*$$

$$= [1 - \cos(\phi_A - \phi_B)] \frac{P_{\text{in}}}{2}$$

**Output intensity is sensitive to the differential phase**

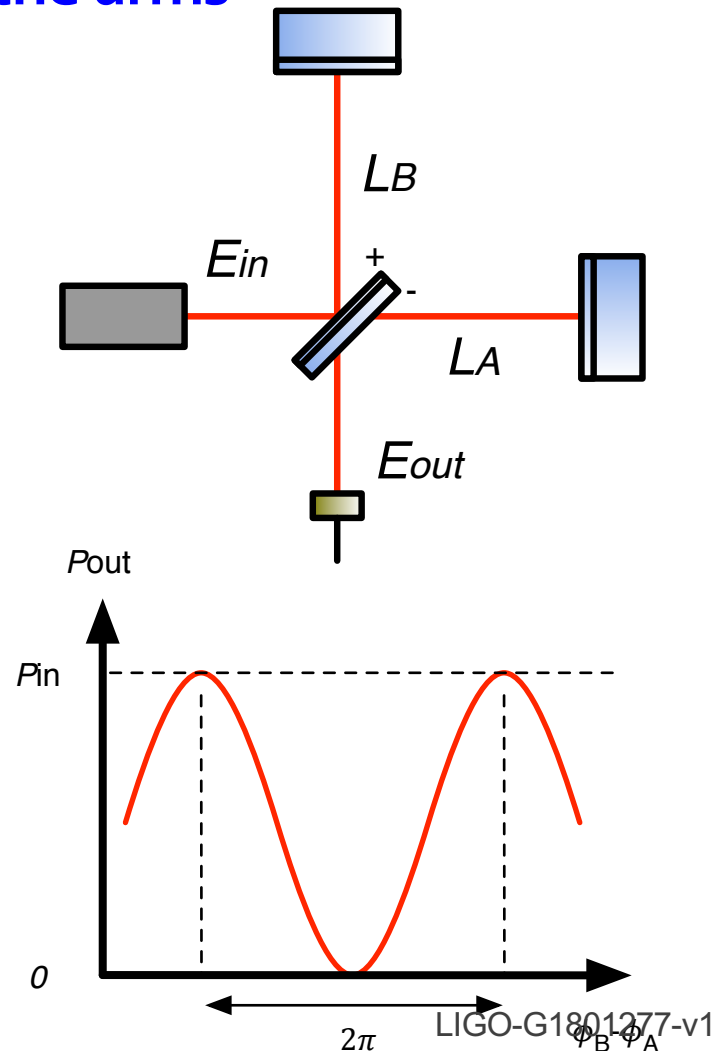

# Michelson interferometer

- Frequency response of the Michelson to GWs

$$\begin{aligned}\phi_A - \phi_B &= \int_{t-2L/c}^t \Omega \left[ 1 + \frac{1}{2}h(t) \right] dt - \int_{t-2L/c}^t \Omega \left[ 1 - \frac{1}{2}h(t) \right] dt \\ &= \int_{t-2L/c}^t \Omega h(t) dt\end{aligned}$$

$$h(t) = h_0 e^{i\omega t}$$

Frequency response  
of the Michelson interferometer

$$\begin{aligned}\phi_A - \phi_B &= \frac{2L\Omega}{c} e^{-iL\omega/c} \frac{\sin(L\omega/c)}{L\omega/c} \cdot h_0 e^{i\omega t} \\ &= \frac{4\pi L}{\lambda_{\text{opt}}} e^{-i2\pi L/\lambda_{\text{GW}}} \frac{\sin(2\pi L/\lambda_{\text{GW}})}{2\pi L/\lambda_{\text{GW}}} \cdot h_0 e^{i\omega t}\end{aligned}$$

$\Omega$ : optical angular frequency,  $\lambda_{\text{OPT}}$  laser wavelength  
 $\omega$ : angular frequency of GW,  $\lambda_{\text{GW}}$  wavelength of GW

# Michelson interferometer

- Frequency response of the Michelson to GWs

$$\Delta\phi = \frac{2L\Omega}{c} e^{-iL\omega/c} \frac{\sin(L\omega/c)}{L\omega/c} \cdot h_0 e^{i\omega t}$$

DC Response  
longer ->  
larger

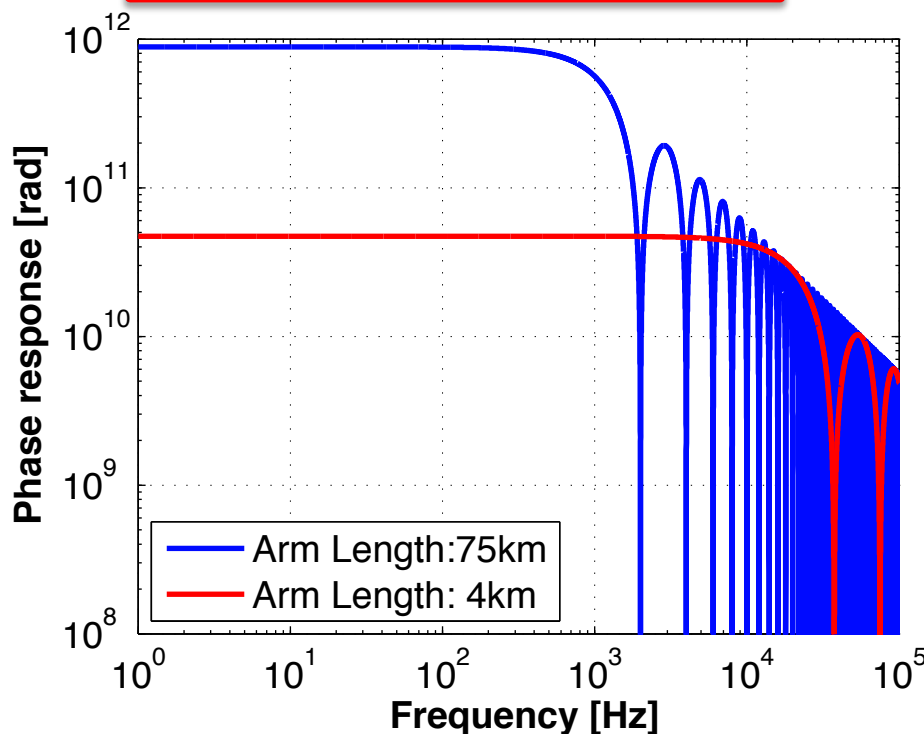

Cut off freq  
longer -> lower

Notch freq  
 $f = n c / (2 L)$

Michelson arm length optimized for 1kHz GW  
-> 75km, too long! => Fabry-Perot cavity

# Comparison:

G1801277 20

# Michelson sensitivity and GW amplitudes

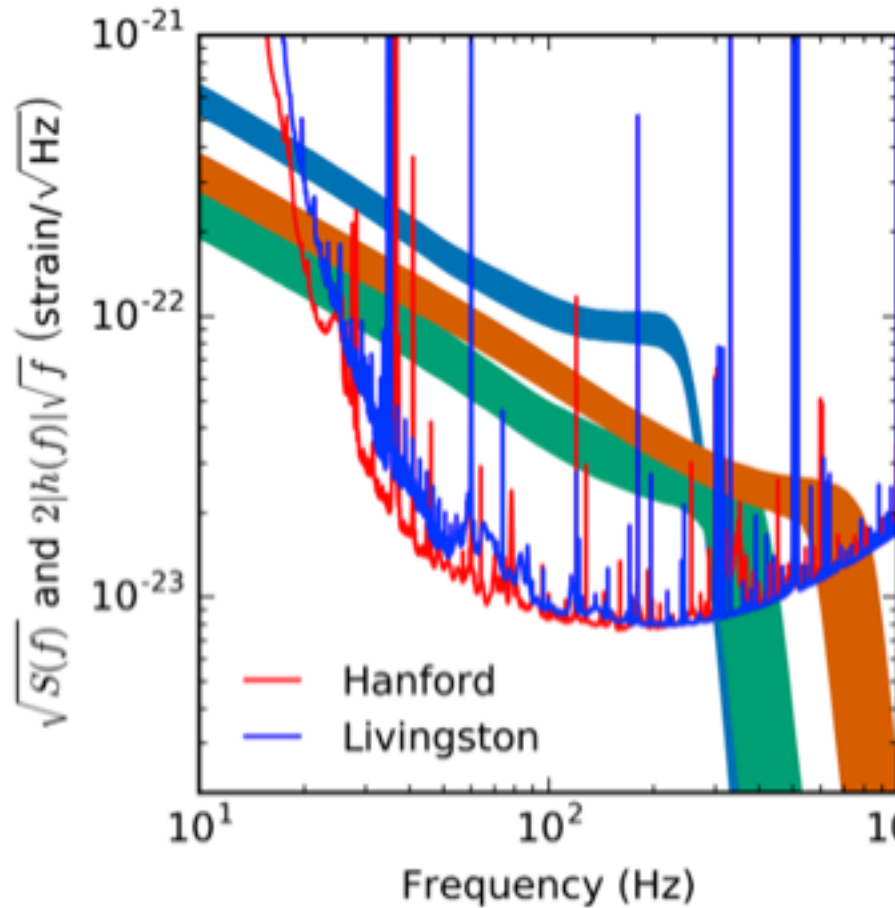

From Phys. Rev. X **6**, 041015

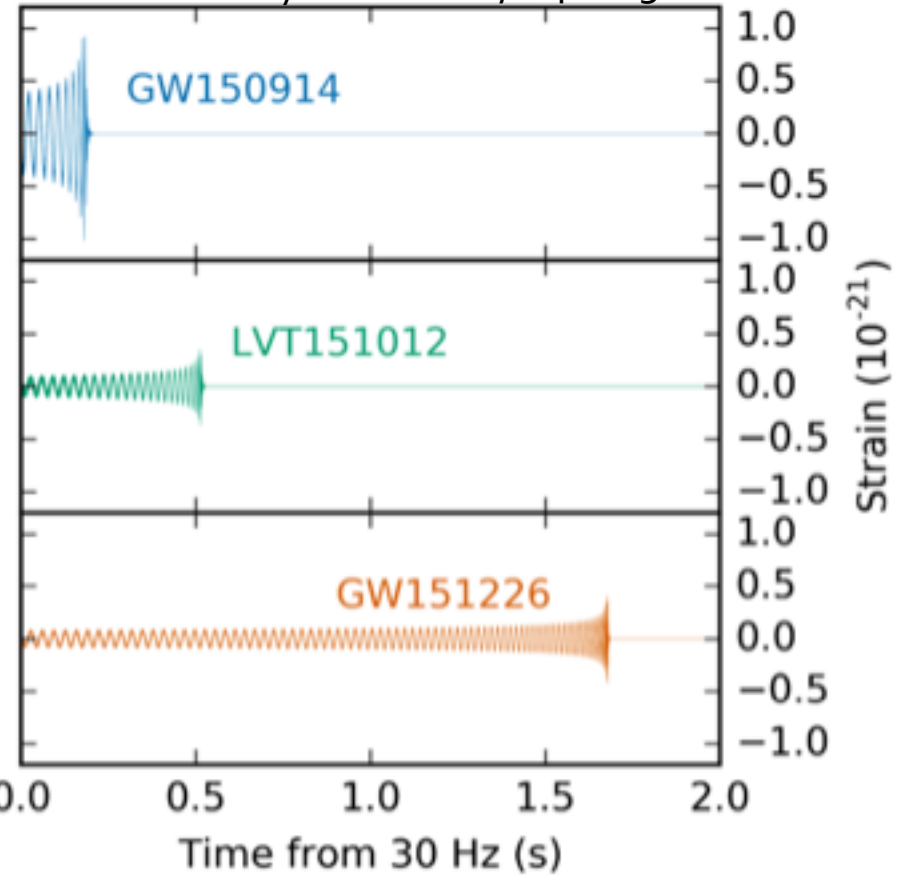

Michelson sensitivity (4km 1W ):  $h \approx 1.3 \times 10^{-20} / \sqrt{\text{Hz}}$

Not enough at all!! What to do? (talk about it later)

# Antenna pattern of a Michelson interferometer

- Q: How does a Michelson interferometer reacts to GWs coming from various directions?

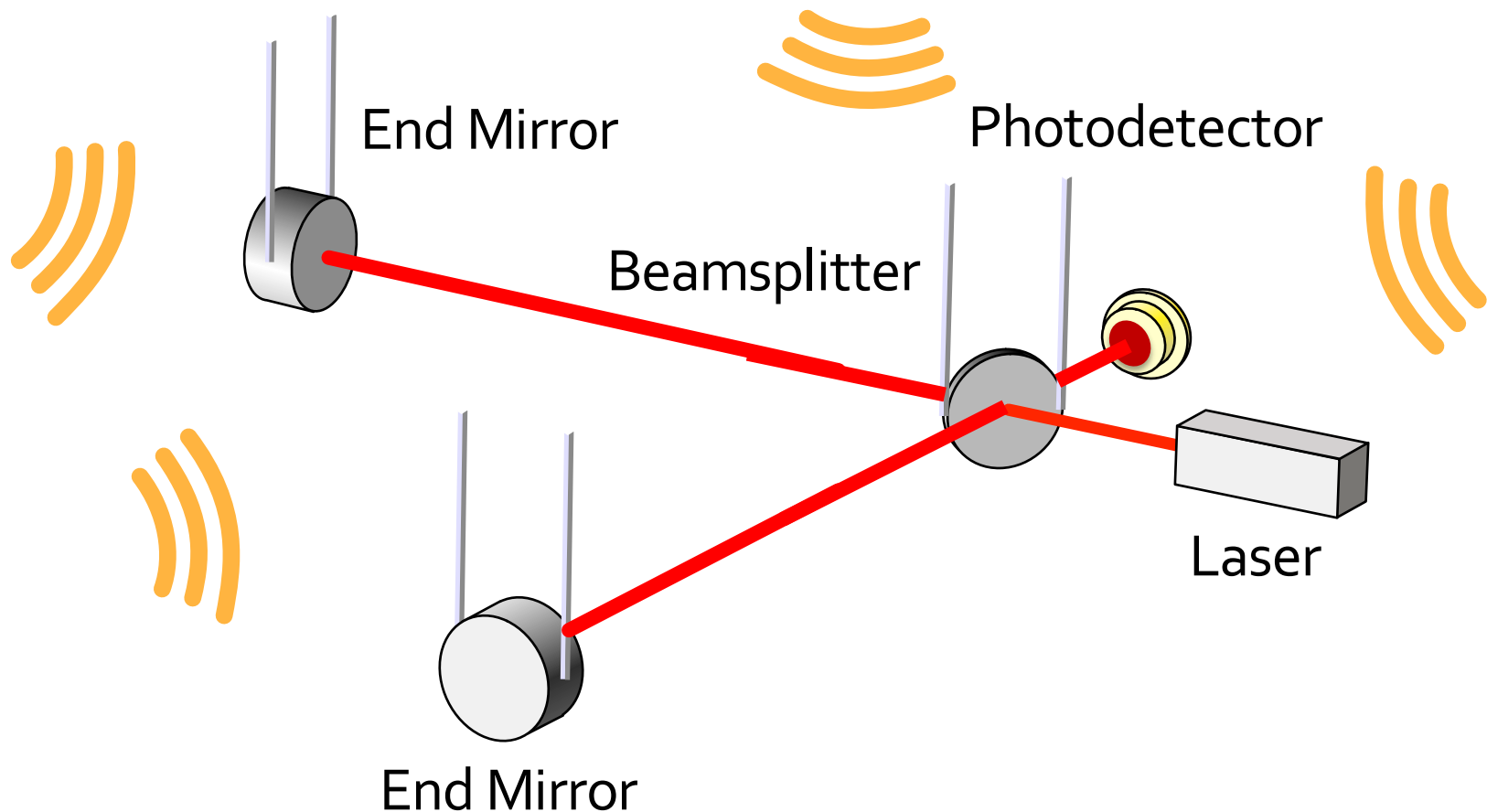

# Antenna pattern of a Michelson interferometer

■ Q: How does a Michelson interferometer reacts to GWs coming from various directions?

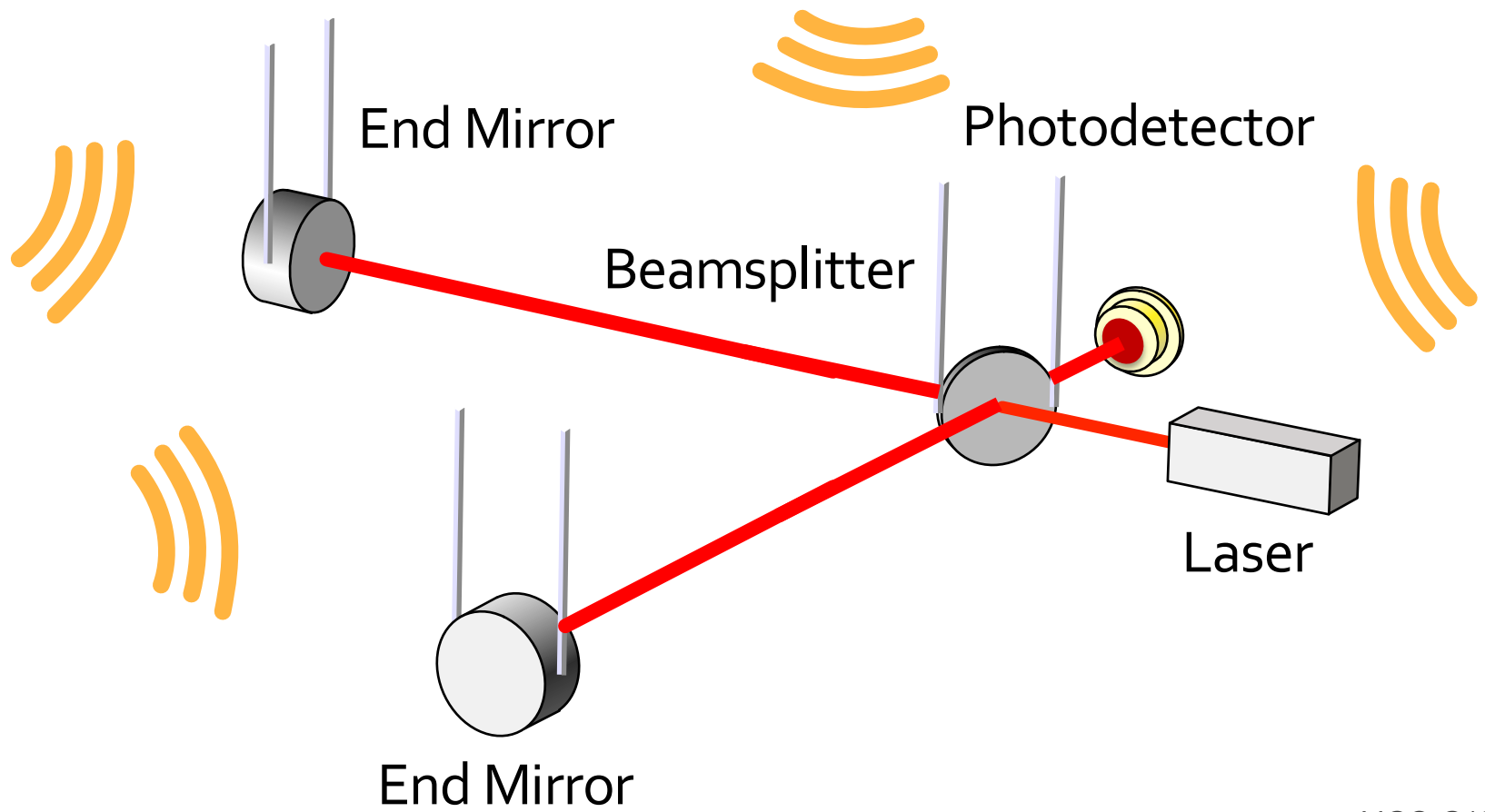

# Antenna pattern of a Michelson interferometer

G1801277 23

- **Response of the interferometer to GWs with + and x polarizations from various directions**

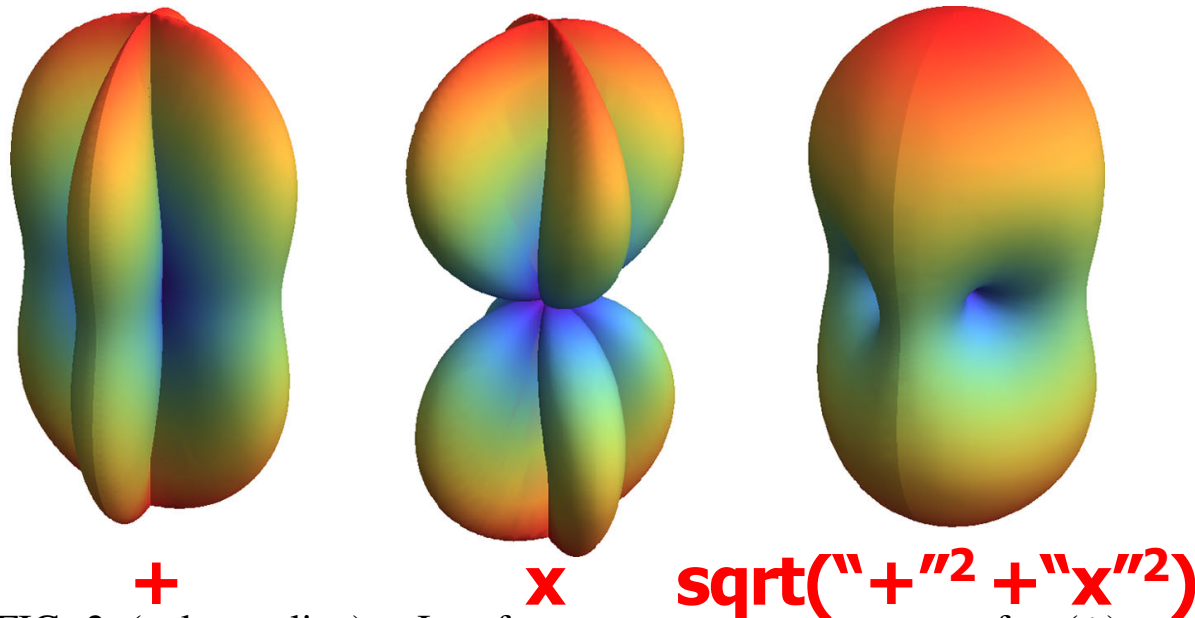

FIG. 2 (color online). Interferometer antenna response for (+) polarization (left), (x) polarization (middle), and unpolarized waves (right).

- **Directivity is very mild**  
➔ **Need multiple detectors for source identification**

# Antenna pattern of a Michelson interferometer

G1801277 24

- **Source identification with multiple detectors**

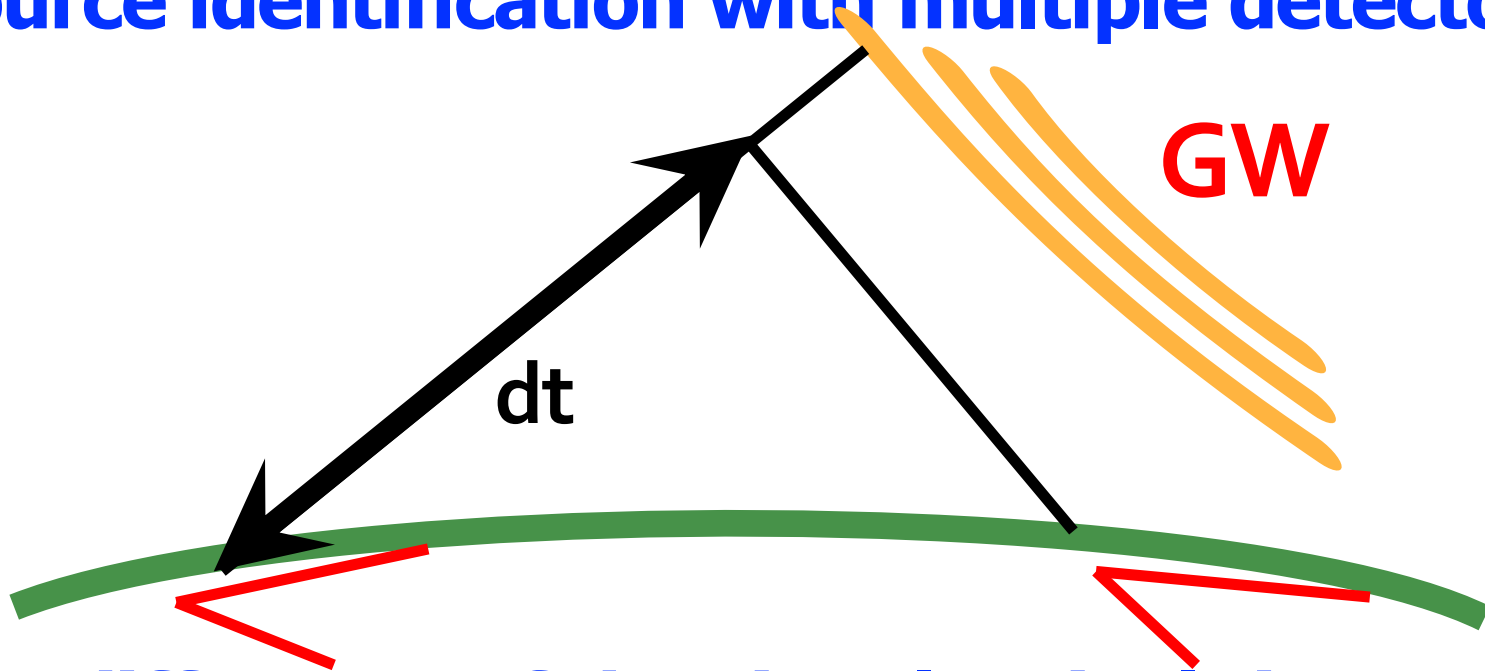

- **Use difference of the signal arrival time to triangulate the source direction**
- **Two detectors are not enough  
Need three or more.**



# Advanced topics

- Angular & frequency response of an arbitrary optical path
  - Draw an arbitrary optical path.  
What is the angular and frequency response of such a path?
  - Can we use numerical “optimization” for certain criteria?  
e.g.  
better sky coverage, directive beaming, for certain source frequency, etc...

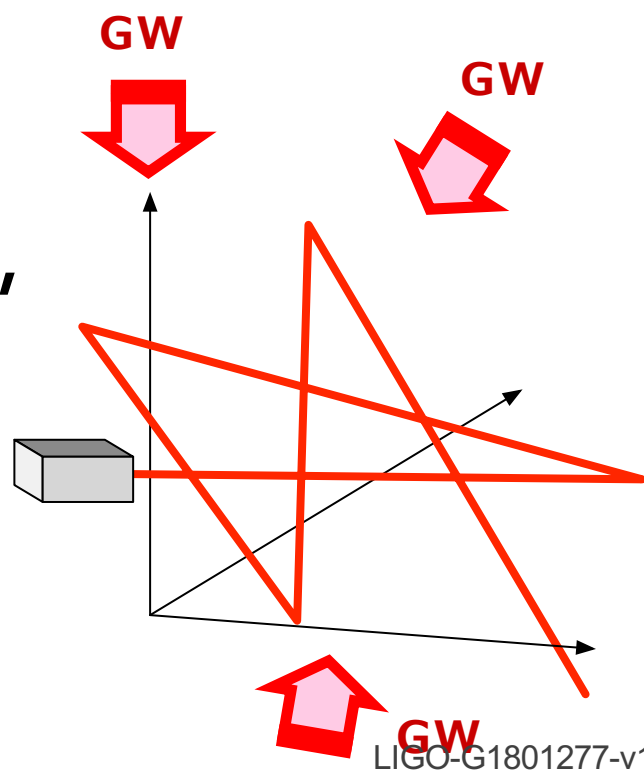

# Advanced topics

- Angular and frequency response of LISA
  - R. Schilling, *Class. Quantum Grav.* 14 (1997) 1513-1519

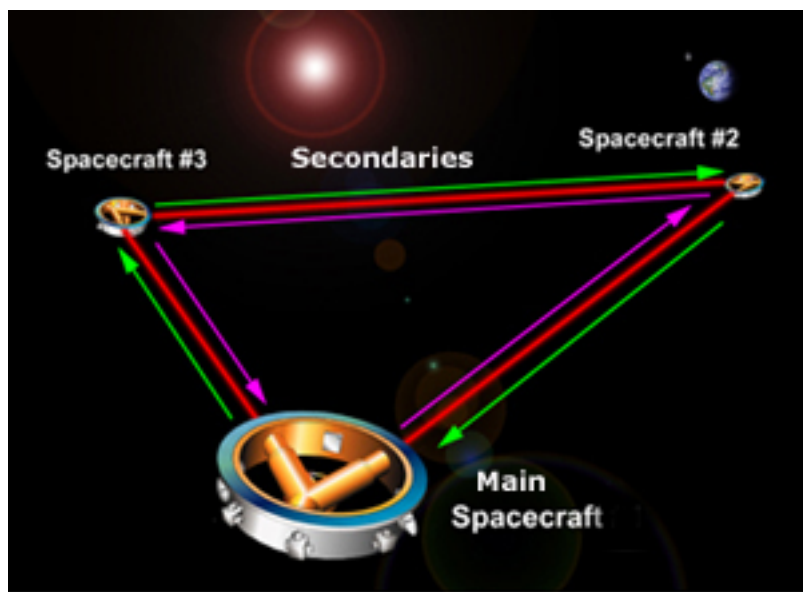

Arm length 2.5Gm

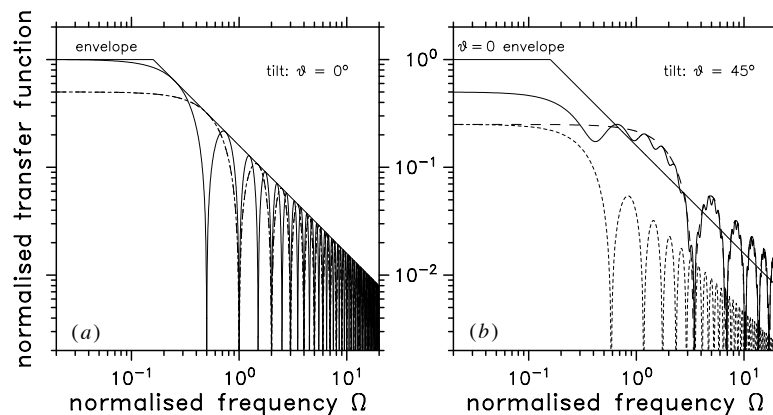

**Figure 1.** Magnitude of the normalized transfer function for a single round trip in a single arm and a tilt of (a)  $0^\circ$  and (b)  $45^\circ$ . Full curve, round trip; long broken curve, forward pass; short broken curve, return pass.

# Fabry-Perot Michelson Interferometer

- Arms are too short
- Use Fabry-Perot cavities in the arms to store the light longer

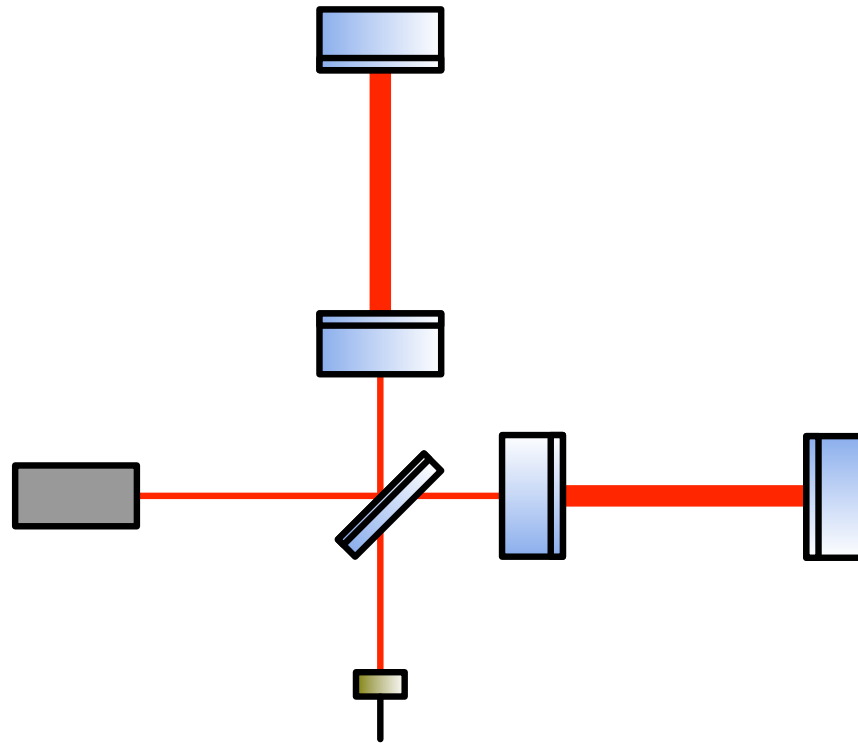

**Basic form of the modern interferometer GW detector**

# Fabry-Perot Michelson Interferometer

- In the past, a delay line arm was considered (easier to understand)
- A FP arm is similar but use a single optical path

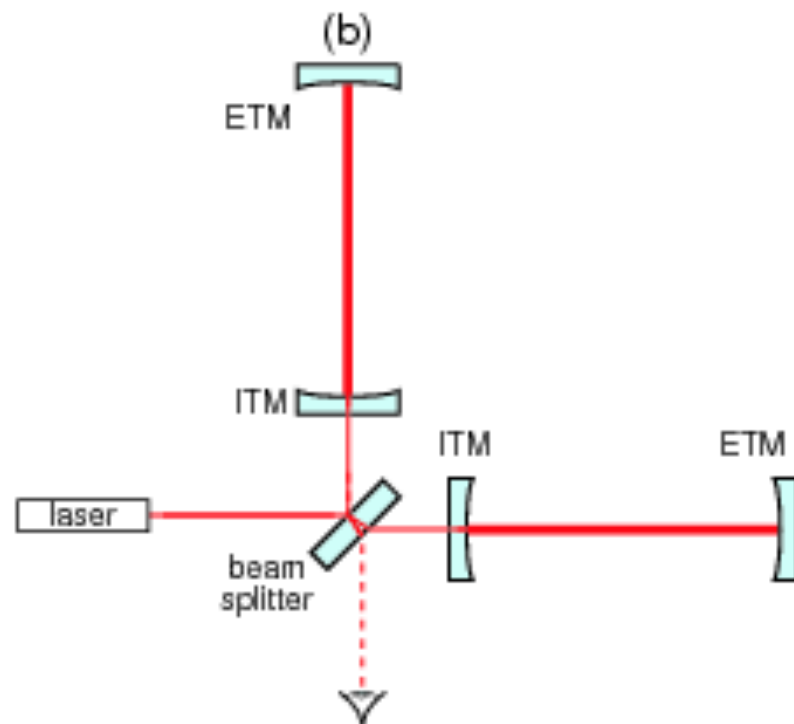
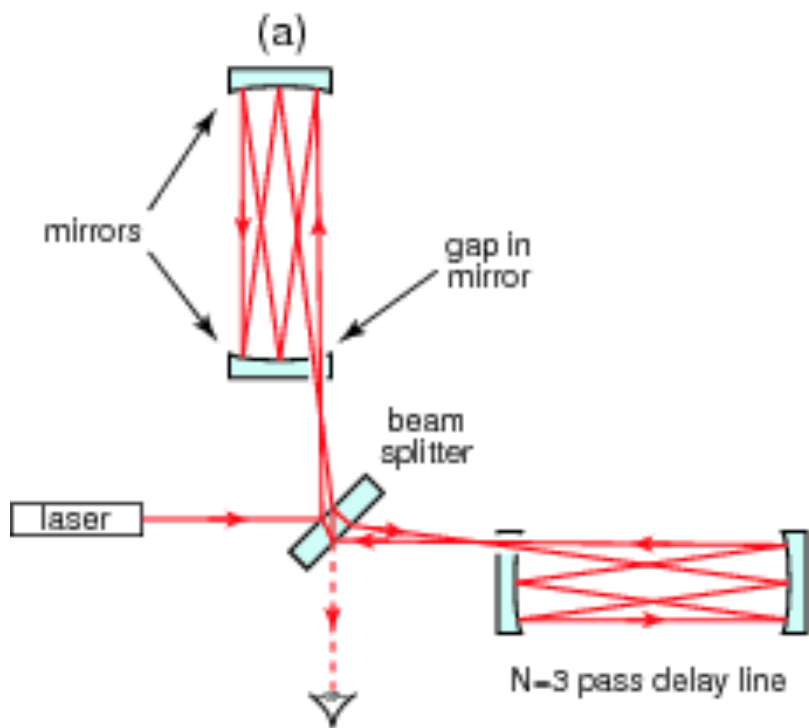

# Fabry-Perot optical resonator

- Storing light in an optical cavity  $t_1, r_1$

- Field equations

$$E_{\text{cav}} = t_1 E_{\text{in}} + r_2 e^{-i\phi} E_{\text{cav}}$$

$$E_t = t_2 e^{-i\phi/2} E_{\text{cav}}$$

$$E_r = -r_1 + t_1 r_2 e^{-i\phi} E_{\text{cav}}$$

$$\frac{E_{\text{cav}}}{E_{\text{in}}} = \frac{t_1}{1 - r_1 r_2 e^{-i\phi}}$$

$$\frac{E_r}{E_{\text{in}}} = -r_1 + \frac{t_1^2 r_2 e^{-i\phi}}{1 - r_1 r_2 e^{-i\phi}}$$

$$\frac{E_t}{E_{\text{in}}} = \frac{t_1 t_2 e^{-i\phi/2}}{1 - r_1 r_2 e^{-i\phi}}$$

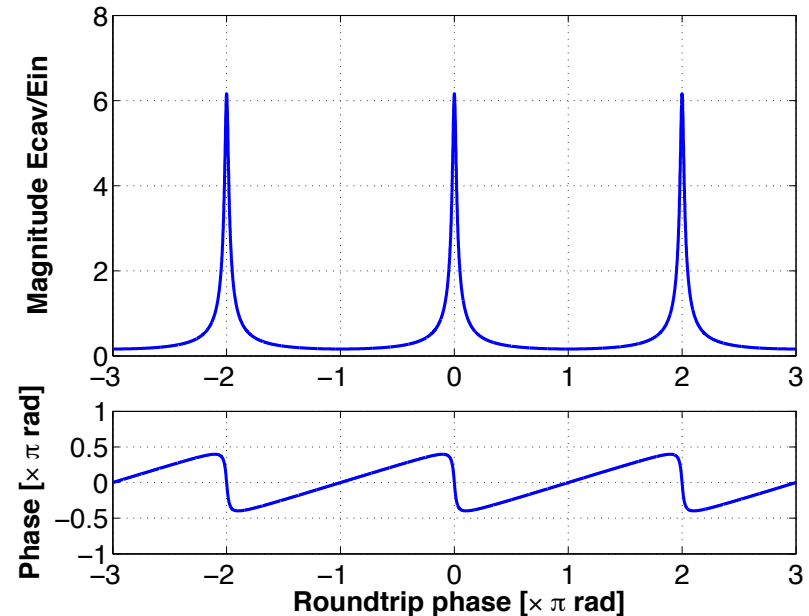
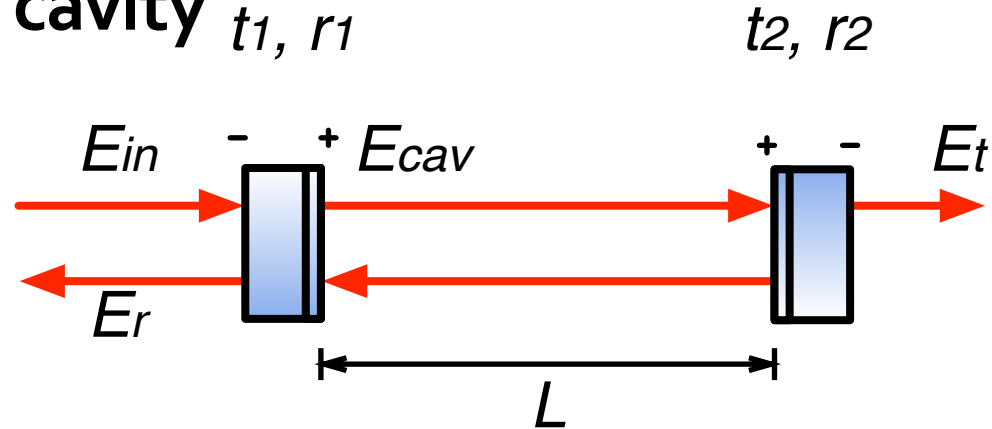

Very fast phase response

# Fabry-Perot optical resonator

## ■ Storing light in an optical cavity

DC Response amplification  
 $N = 2\mathcal{F}/\pi$

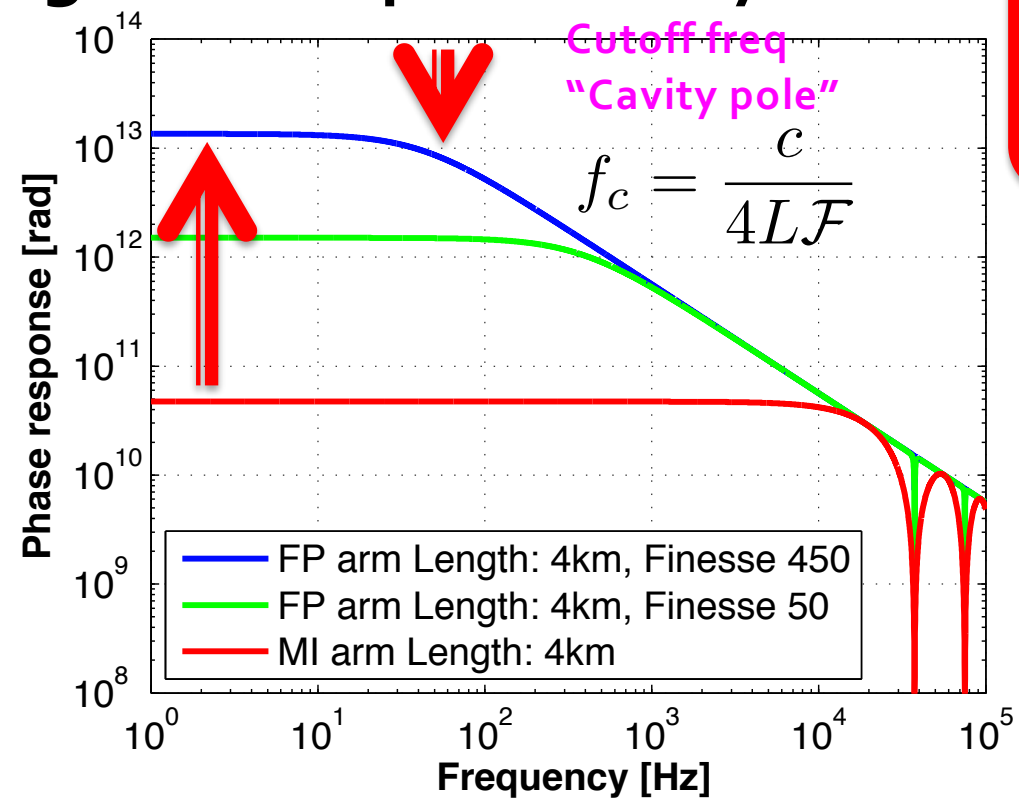

Finesse

$$\mathcal{F} = \frac{\pi \sqrt{r_1 r_2}}{1 - r_1 r_2}$$

1. FP increases stored power in the arm
2. FP increases accumulation time of the signal

=> Above the roll-off, increasing F does not improve the response

# Dual recycling

- Even more mirrors for more light and signals

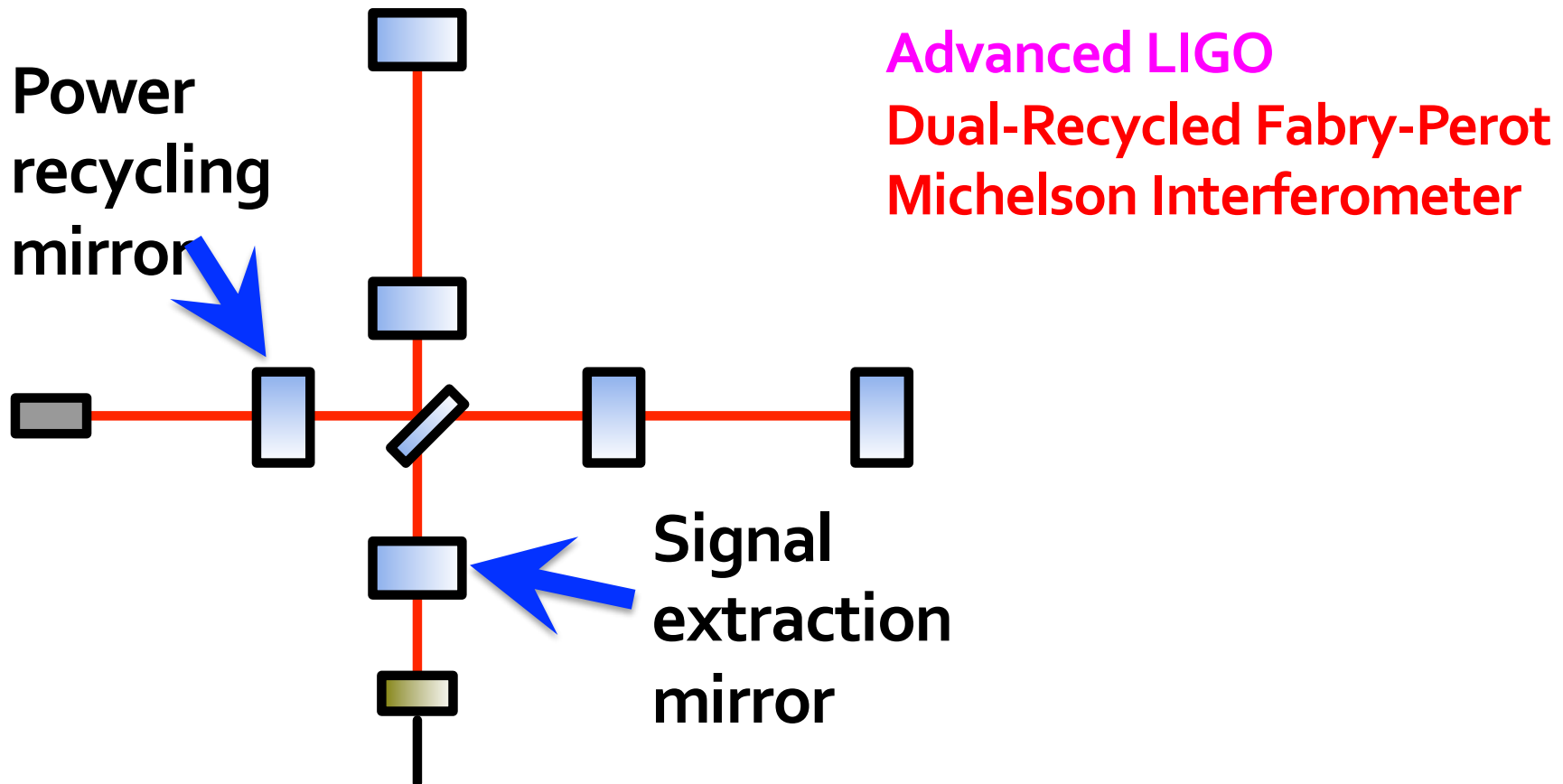

These recycling mirrors allows us to control the power increase in the arm and the signal storage time independently

- A continuous signal stream from an interferometer

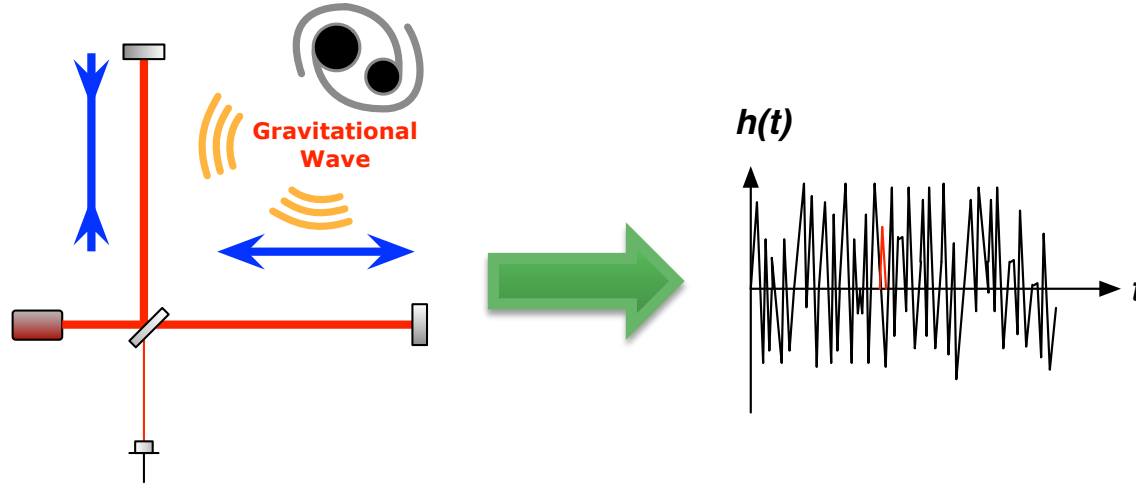

- Find GW signals in the sea of noise
  - Detector noises produce **fake** detections
- **Reduce noises!**
  - Obs. distance is inv-proportional to noise level
  - x10 better => x10 farther => **x1000 more galaxies**



# GW telescope?

## Noises & the signal

Binary coalescence search

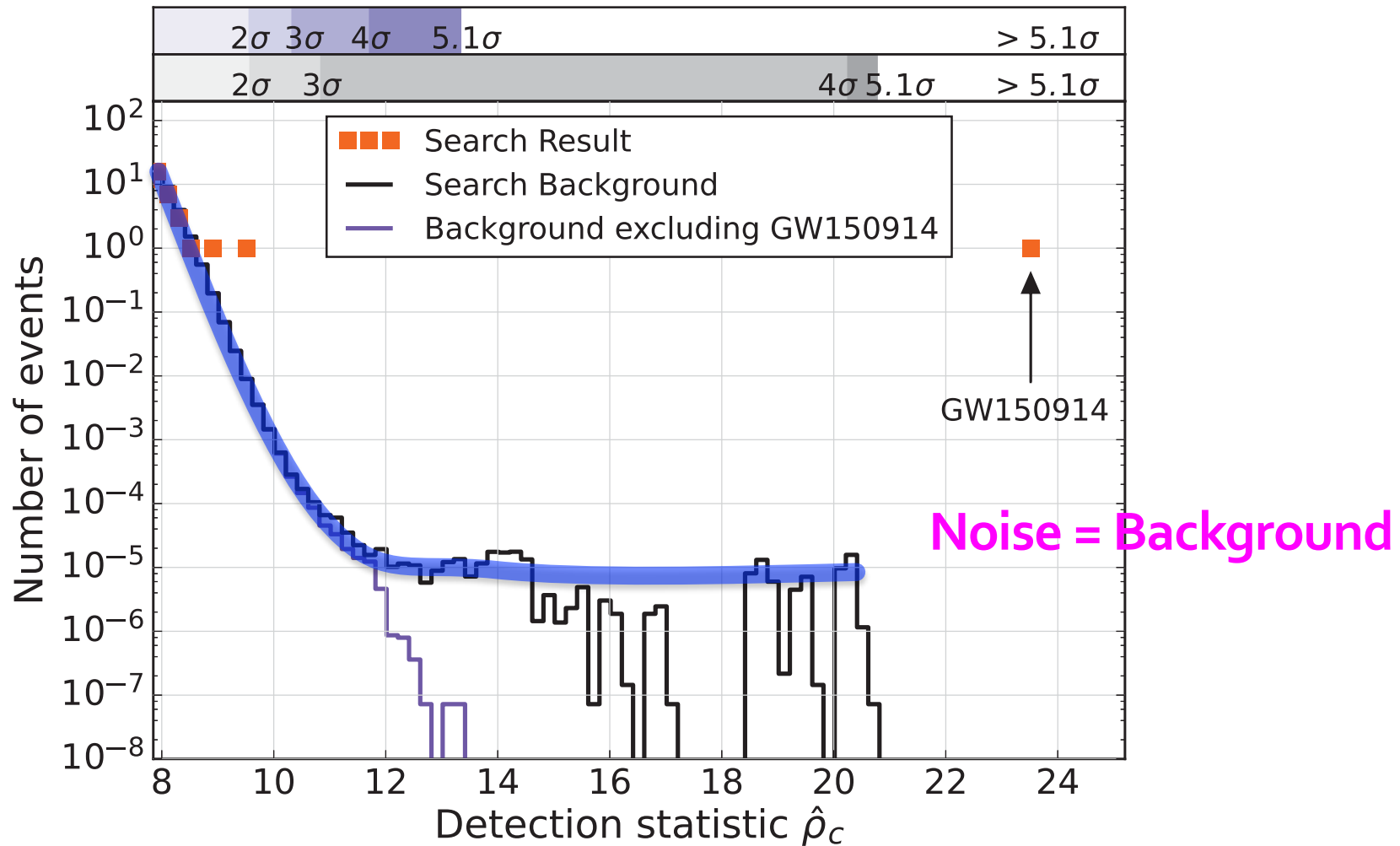

# Actual GW detector

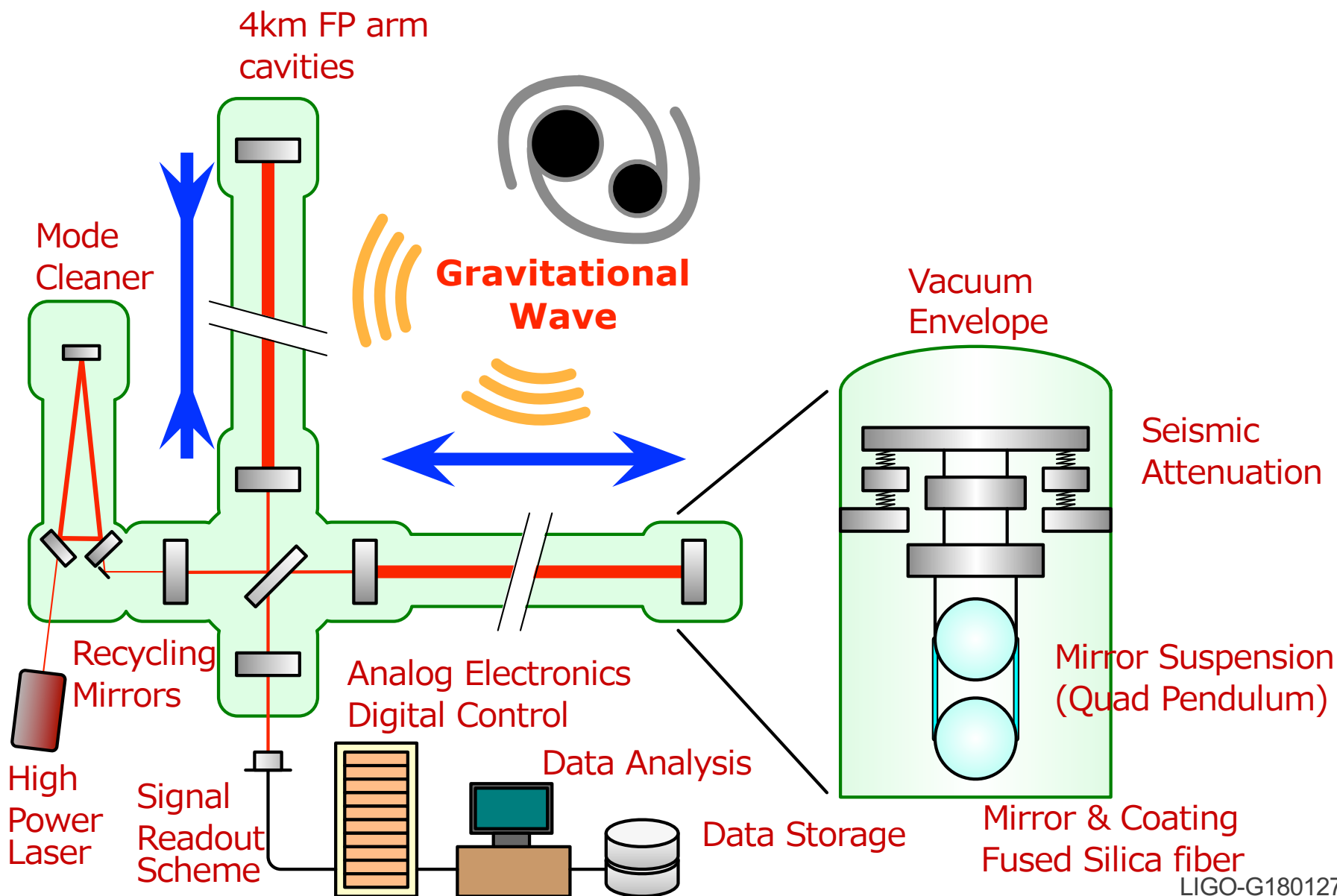

# Technologies of the GW detectors

- 3 elements of a laser GW detector
  - Mechanics
  - Optics
  - Electronics

# Technologies of the GW detectors

■ 3

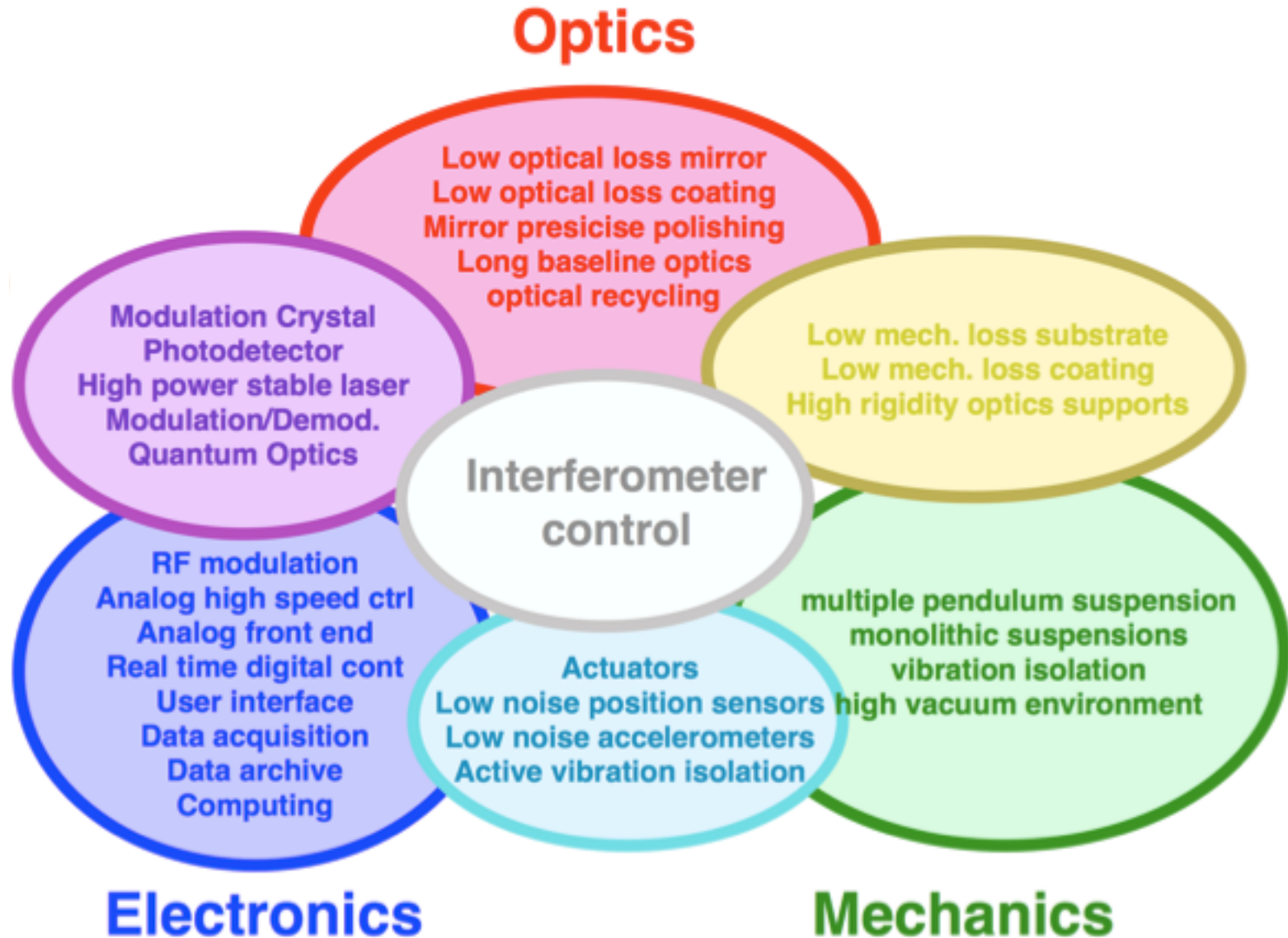

# Sensitivity and noise

- Sensitivity (=noise level) of Advanced LIGO
- Design

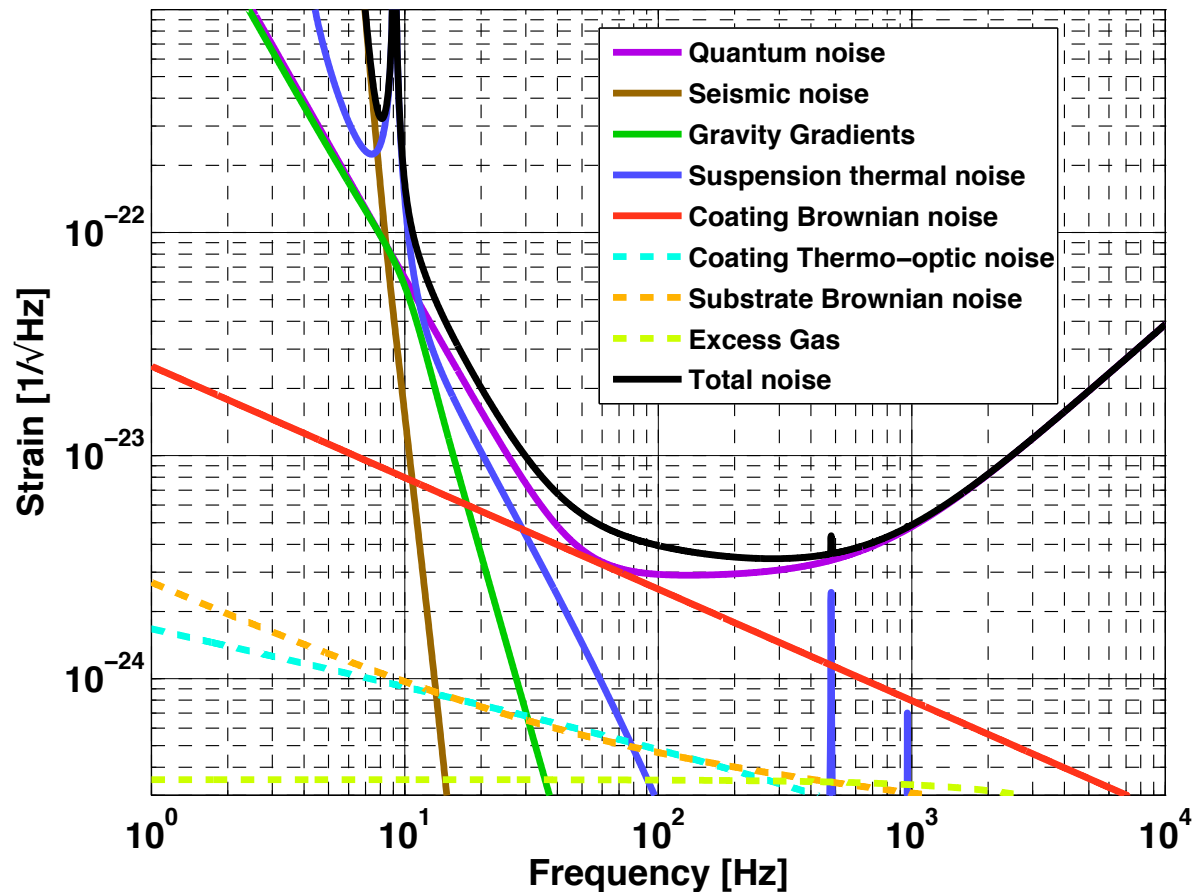

# Sensitivity and noise

- Sensitivity (=noise level) of Advanced LIGO
- Current sensitivity

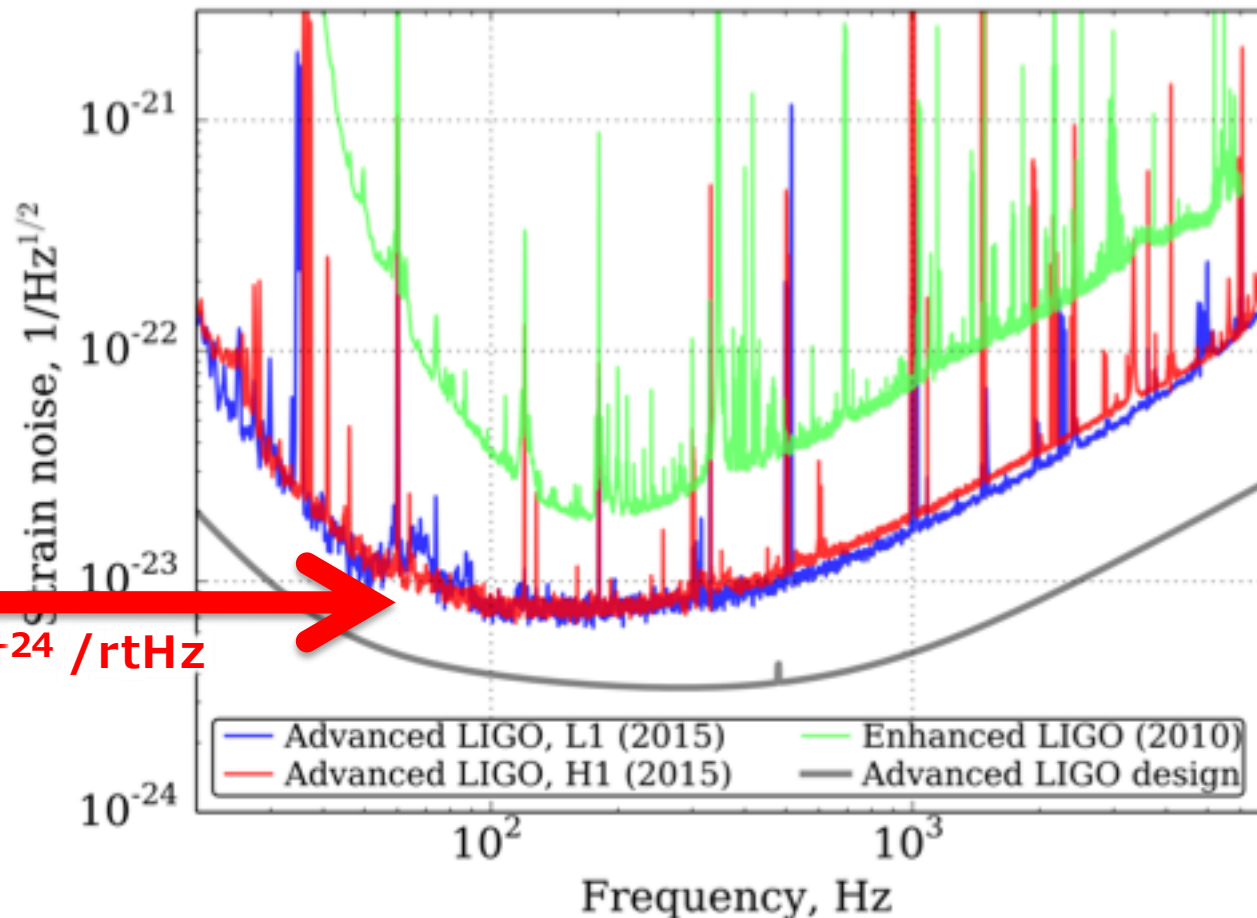

$h = 8 \times 10^{-24} / \text{rtHz}$

# Sensitivity and noise

- Sensitivity (=noise level) of Advanced LIGO
- Noise budget

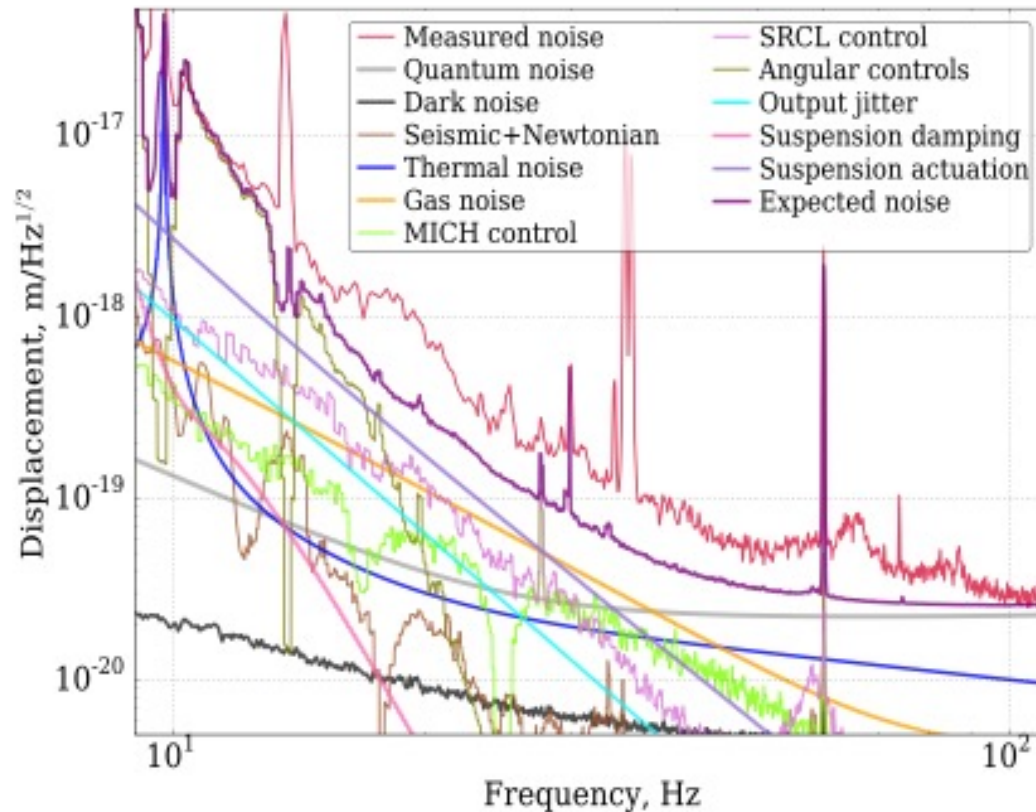

(a) LIGO Livingston Observatory

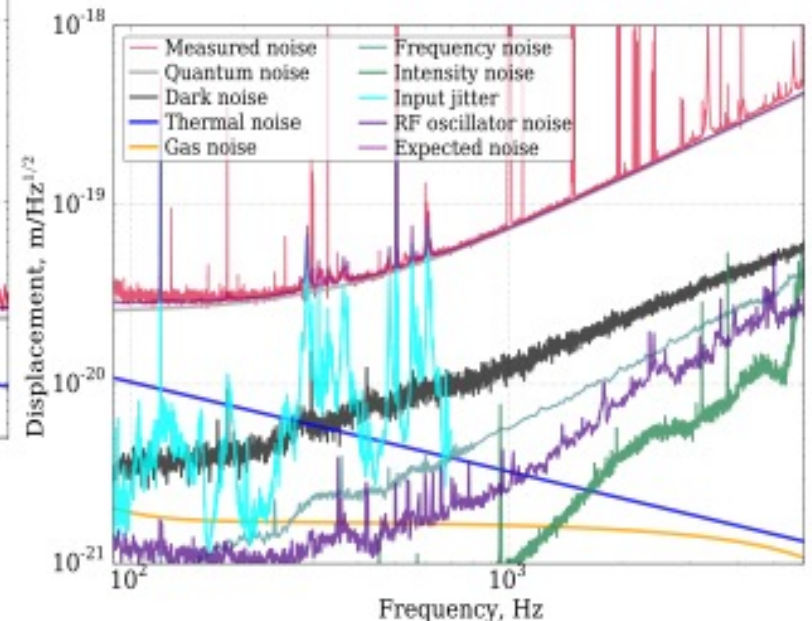

(b) LIGO Hanford Observatory

# Summary

- **Interferometric GW detector**
  - **GWs: Spacetime strain** with quadrupole patterns
  - **Laser interferometry: Michelson** type interferometer
  - **Multiple detectors: Triangulation** for source identification
  - **Optical resonators: Fabry-Perot cavity** and recycling
  - **Technologies: All for noise reduction**