

H1 EtherCat Corner 1

H1EcatC1 Target: 10.40.10.1.1.1
 Site: H1
 BasePath: C:\SlowControls\TwinCAT3\Source\Interferometer
 Directory: H1EcatC1\Configure
 SaveToProject: True
 Auto Priority: True
 Enable C++ debugger: False
 MaxCPUs: 4
 IsolatedCPUs: 2

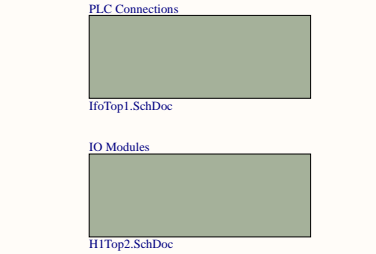

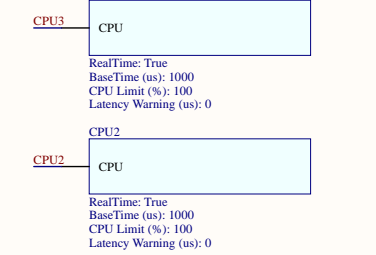
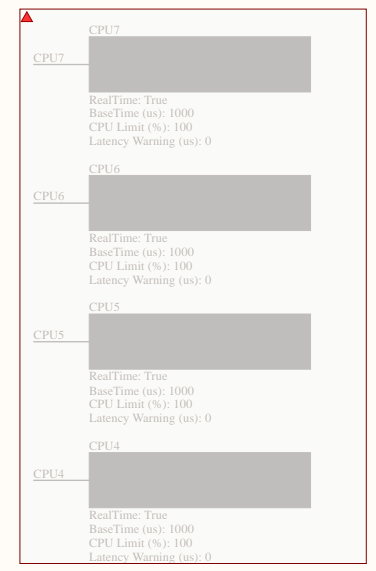
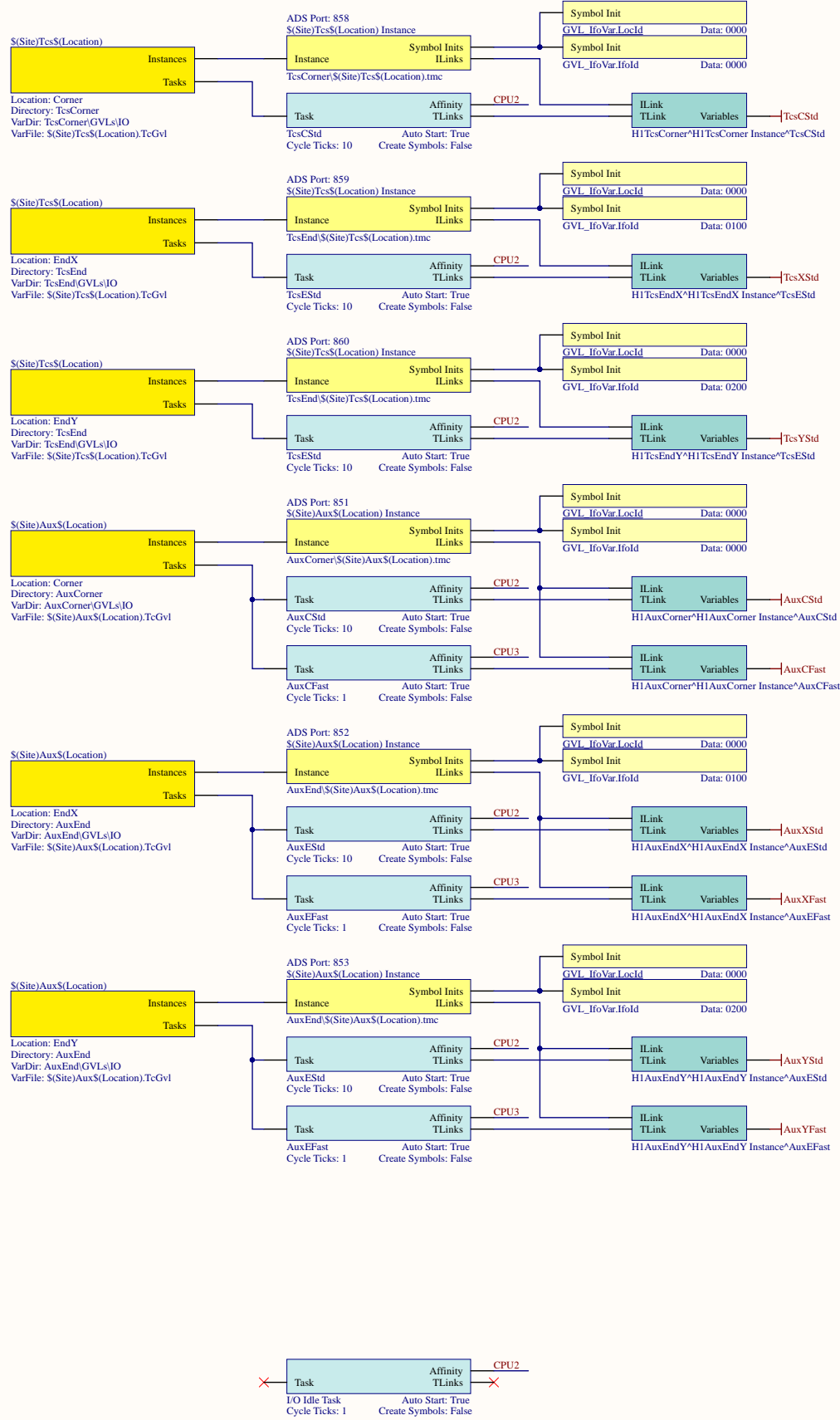
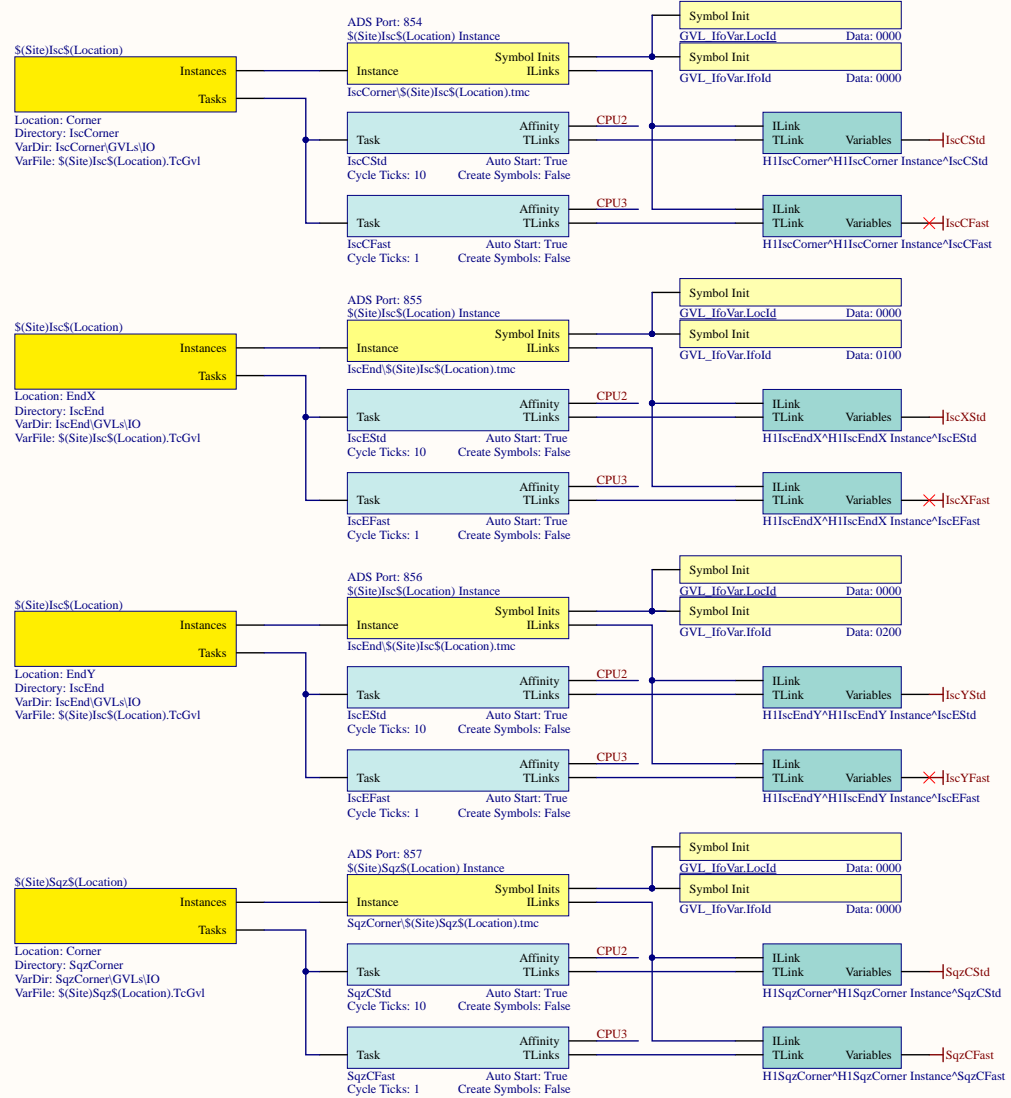
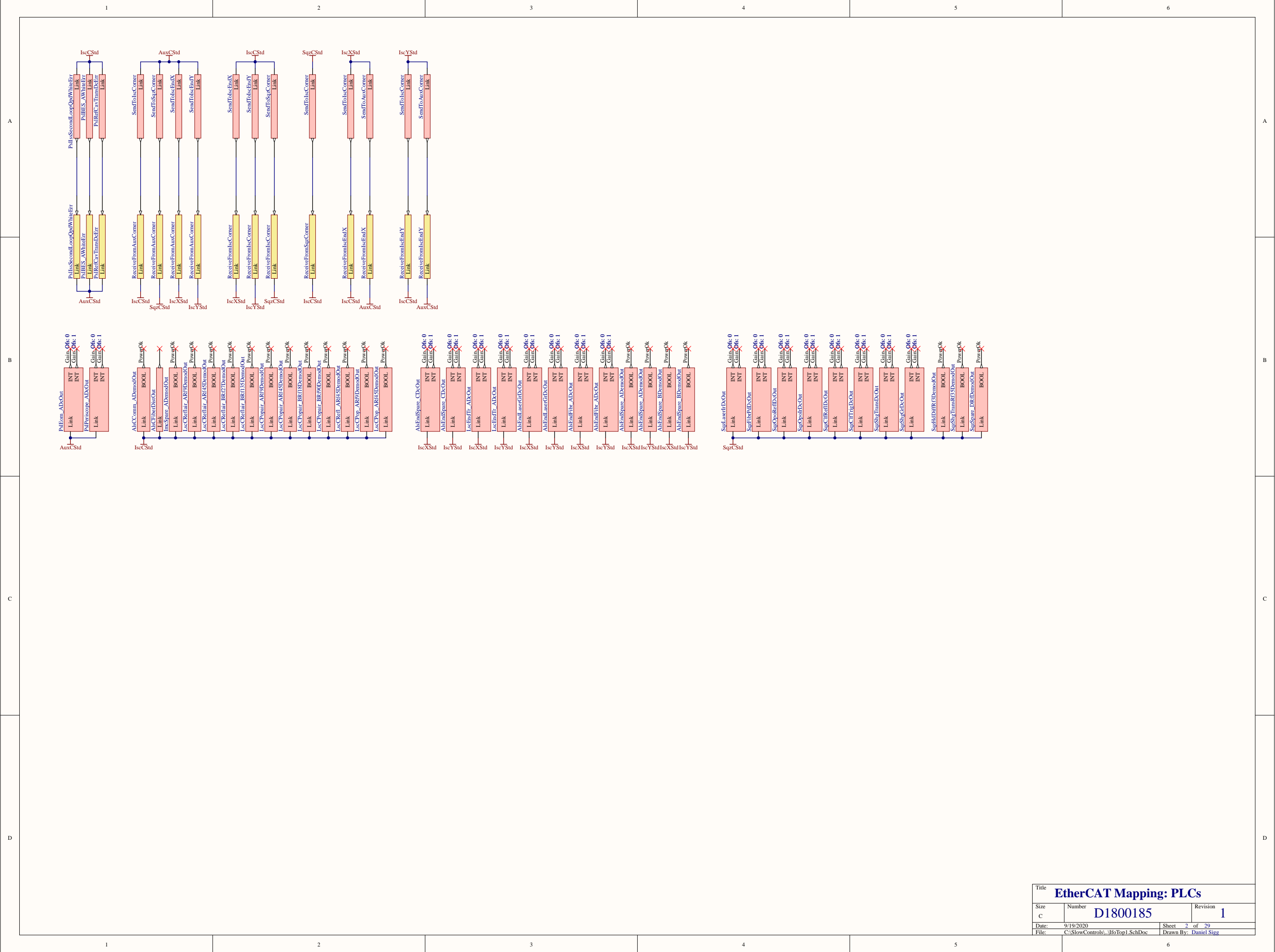

Title EtherCAT Mapping: PLCs		
Size c	Number D1800185	Revision 1
Date:	9/19/2020	Sheet 2 of 29
File:	C:\SlowControls\...lfoTop1.SchDoc	Drawn By: Daniel Sig

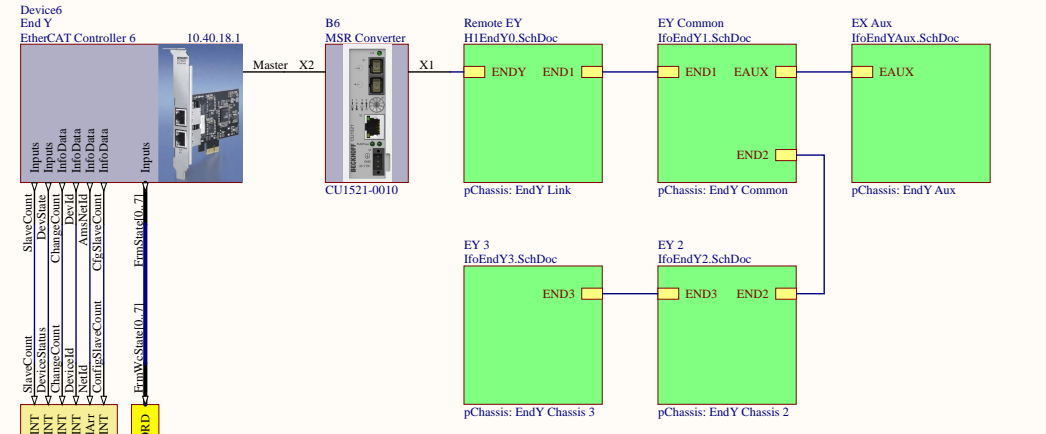
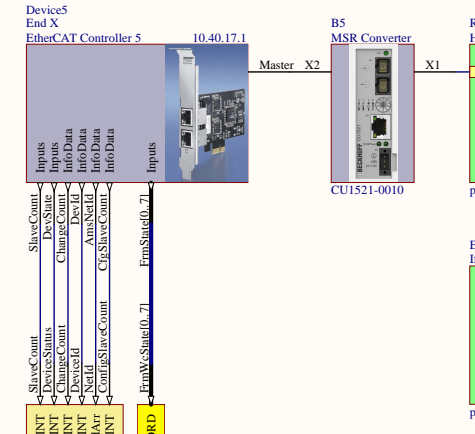
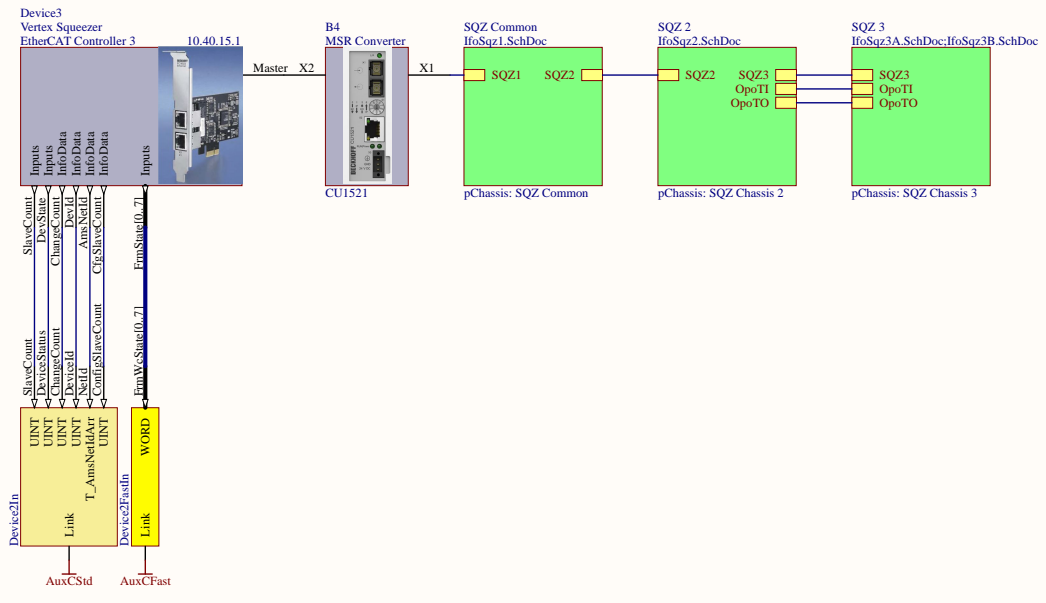
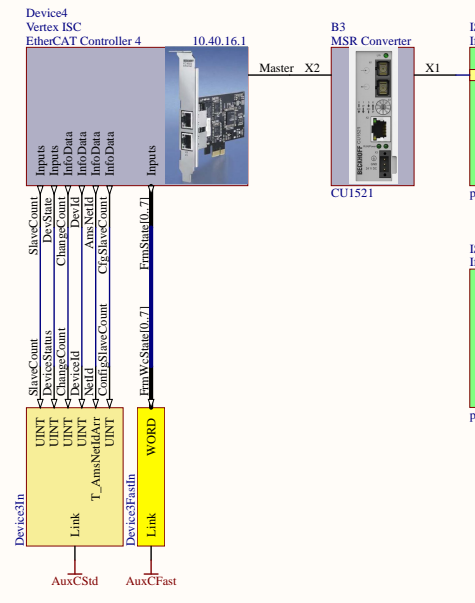
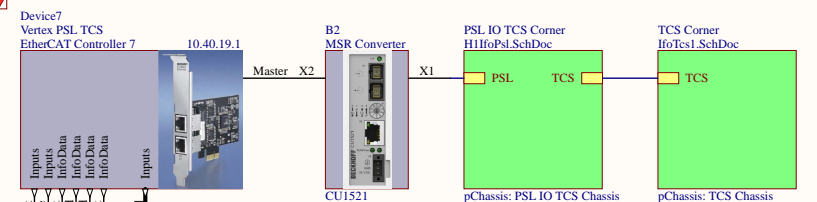
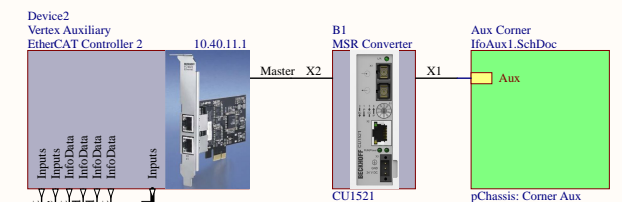
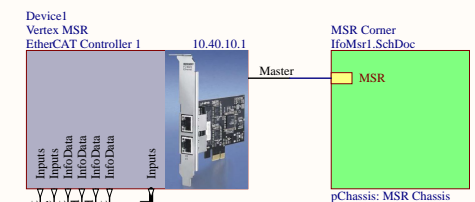

Title		
EtherCAT Mapping: Devices		
Size	Number	Revision
c	D1800185	1
Date:	9/19/2020	Sheet 3 of 29
File:	C:\SlowControls\...H1Top2.SchDoc	Drawn By: Daniel Sig

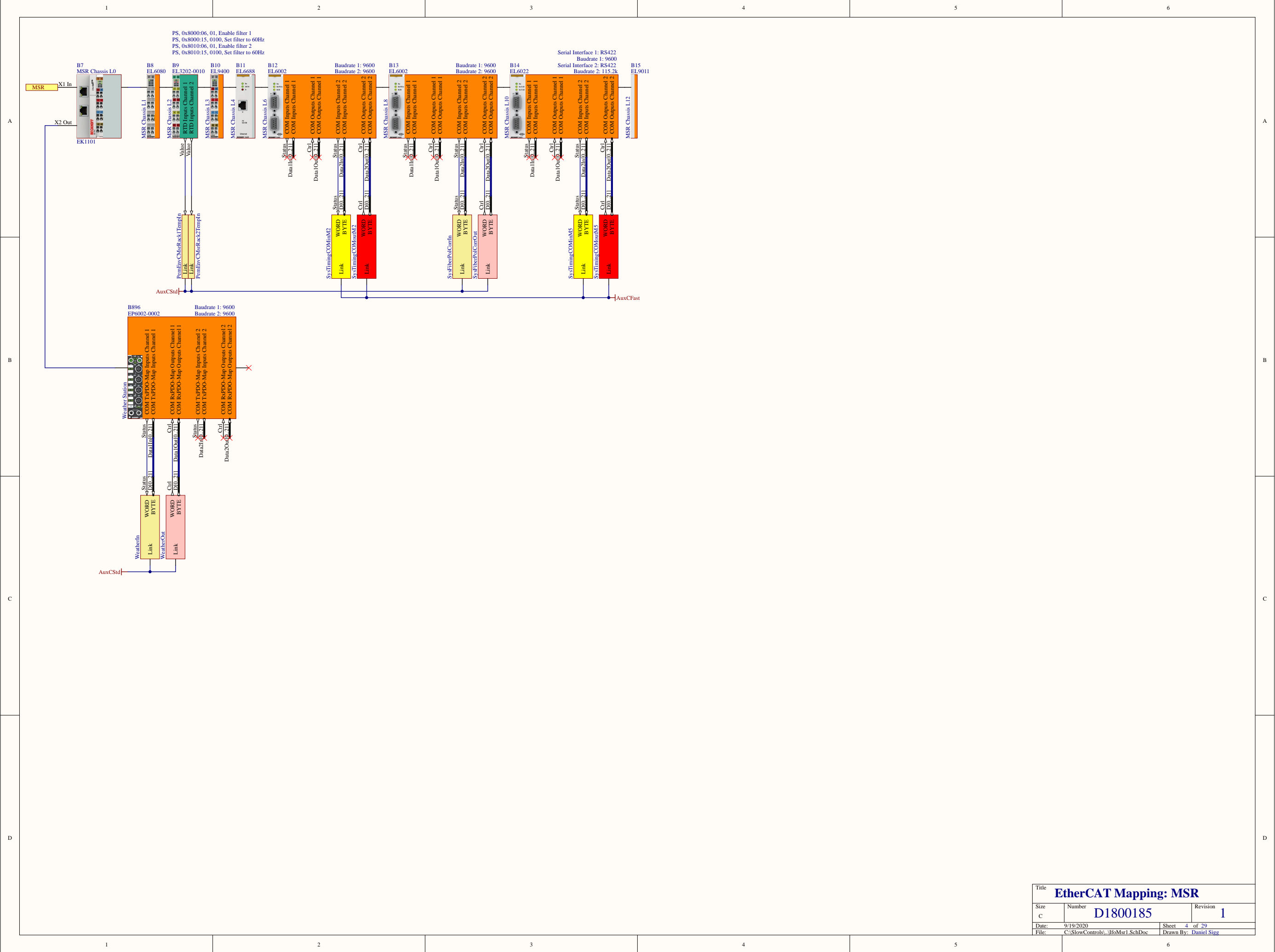

Title EtherCAT Mapping: MSR		
Size c	Number D1800185	Revision 1
Date:	9/19/2020	Sheet 4 of 29
File:	C:\SlowControls\...lfoMsr1.SchDoc	Drawn By: Daniel Sig

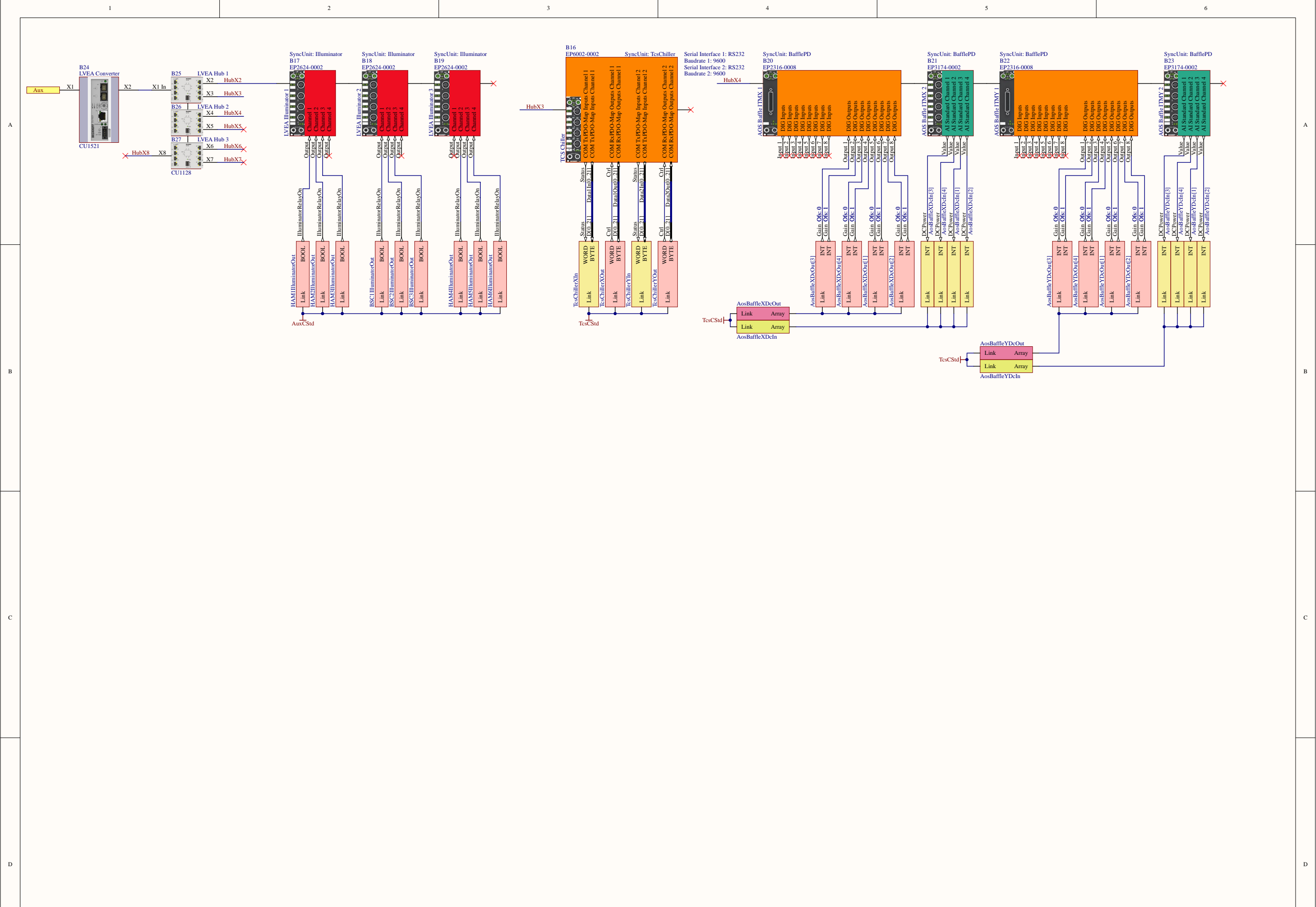

Title EtherCAT Mapping: LVEA		
Size	Number	Revision
c	D1800185	1
Date:	9/19/2020	Sheet 5 of 29
File:	C:\SlowControls\...lfoAux1.SchDoc	Drawn By: Daniel Sig

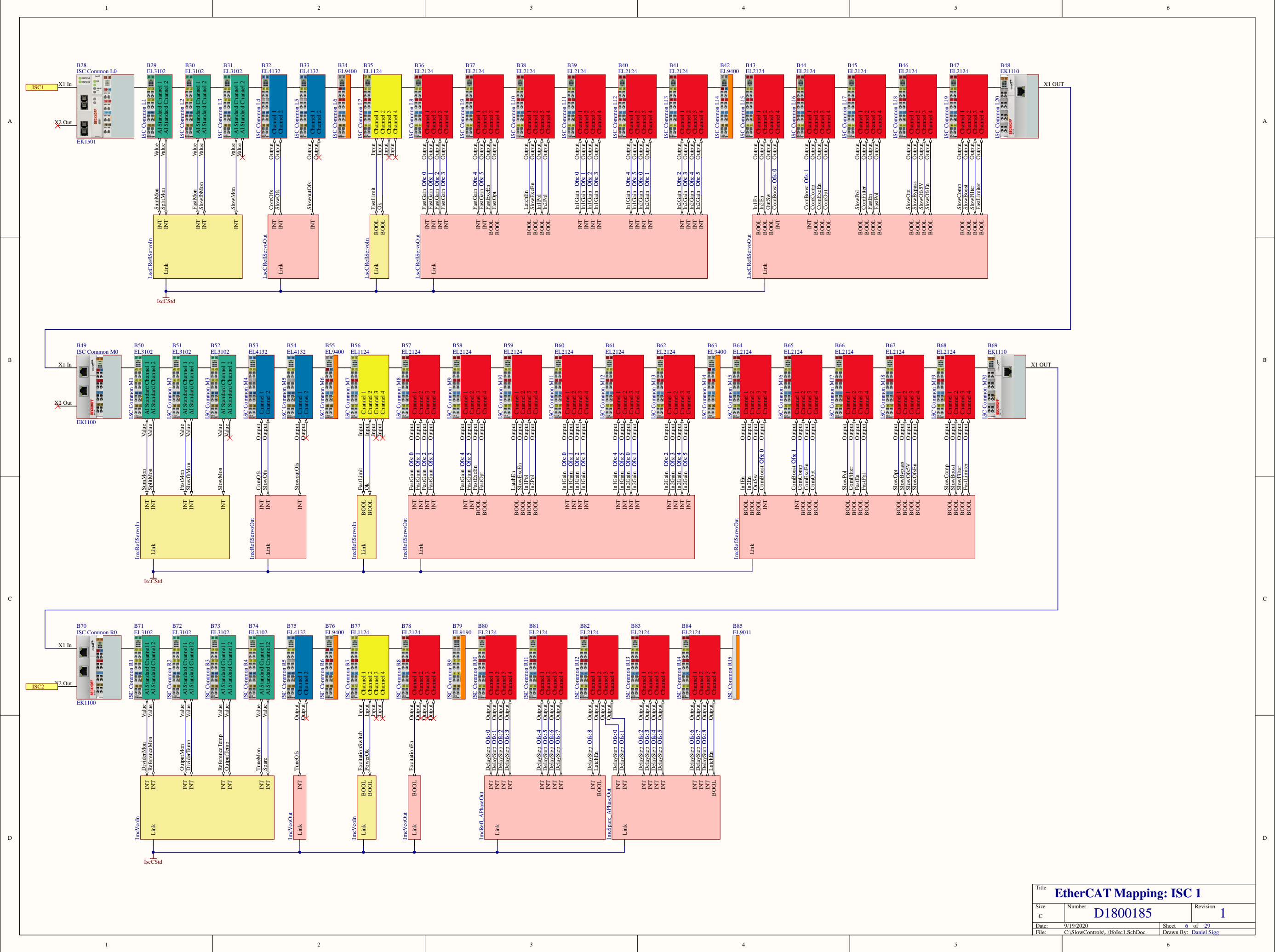

Title EtherCAT Mapping: ISC 1		
Size	Number	Revision
c	D1800185	1
Date:	9/19/2020	Sheet 6 of 29
File:	C:\SlowControls\...lfolsc1.SchDoc	
	Drawn By:	Daniel Sig

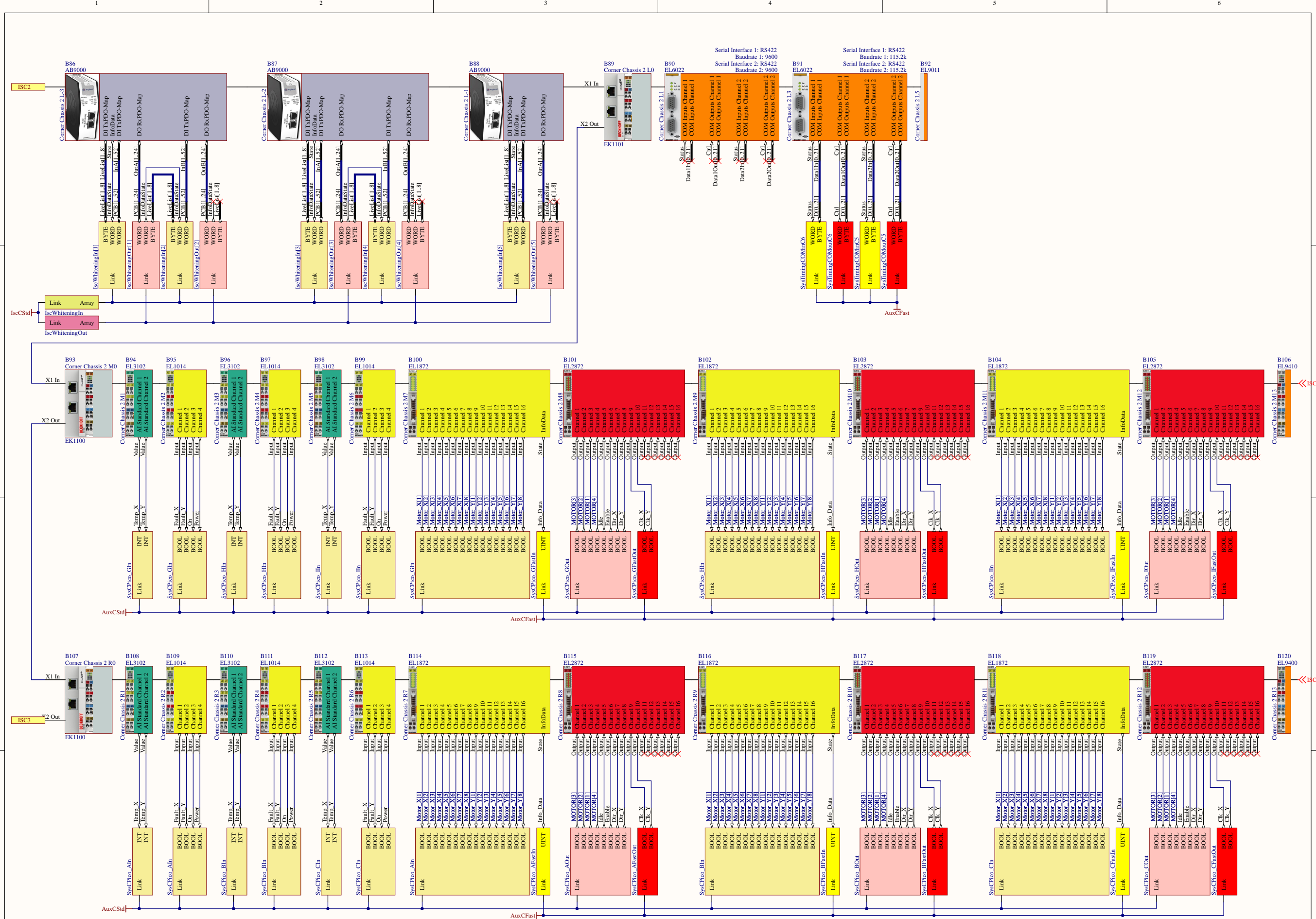

Title EtherCAT Mapping: ISC 2A		
Size c	Number D1800185	Revision 1
Date: 9/19/2020	Sheet 7 of 29	Drawn By: Daniel Sig
File: C:\SlowControls\...ifolsc2A.SchDoc	Sheet 7 of 29	



Title EtherCAT Mapping: ISC 4		
Size	Number	Revision
c	D1800185	1
Date:	9/19/2020	Sheet 10 of 29
File:	C:\SlowControls\...lfolsc4.SchDoc	Drawn By: Daniel Sig

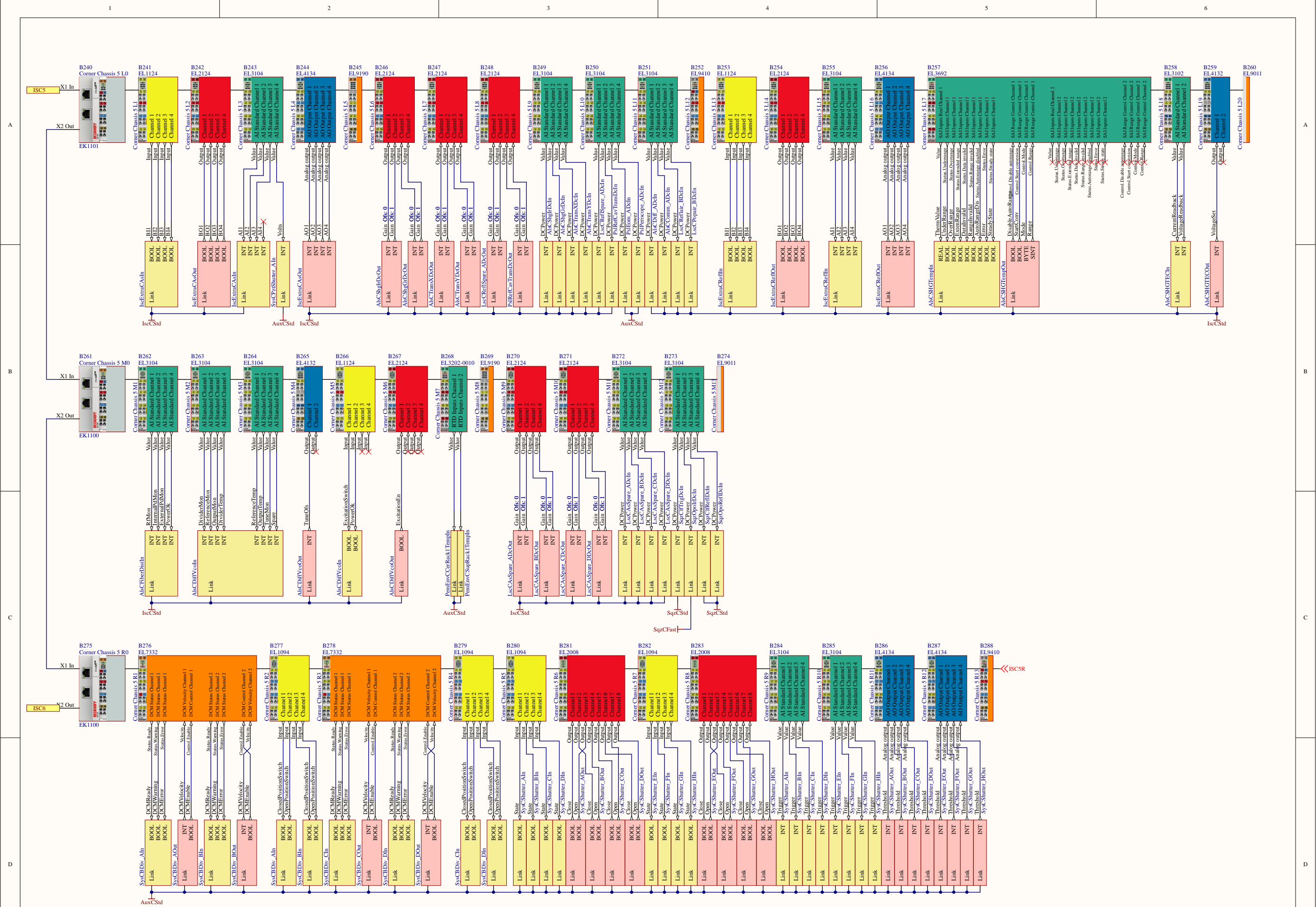

Title EtherCAT Mapping: ISC 5A		
Size c	Number D1800185	Revision 1
Date: 9/19/2020	Sheet 11 of 29	
File: C:\SlowControls\...lfolisc5A.SchDoc	Drawn By: Daniel Sig	

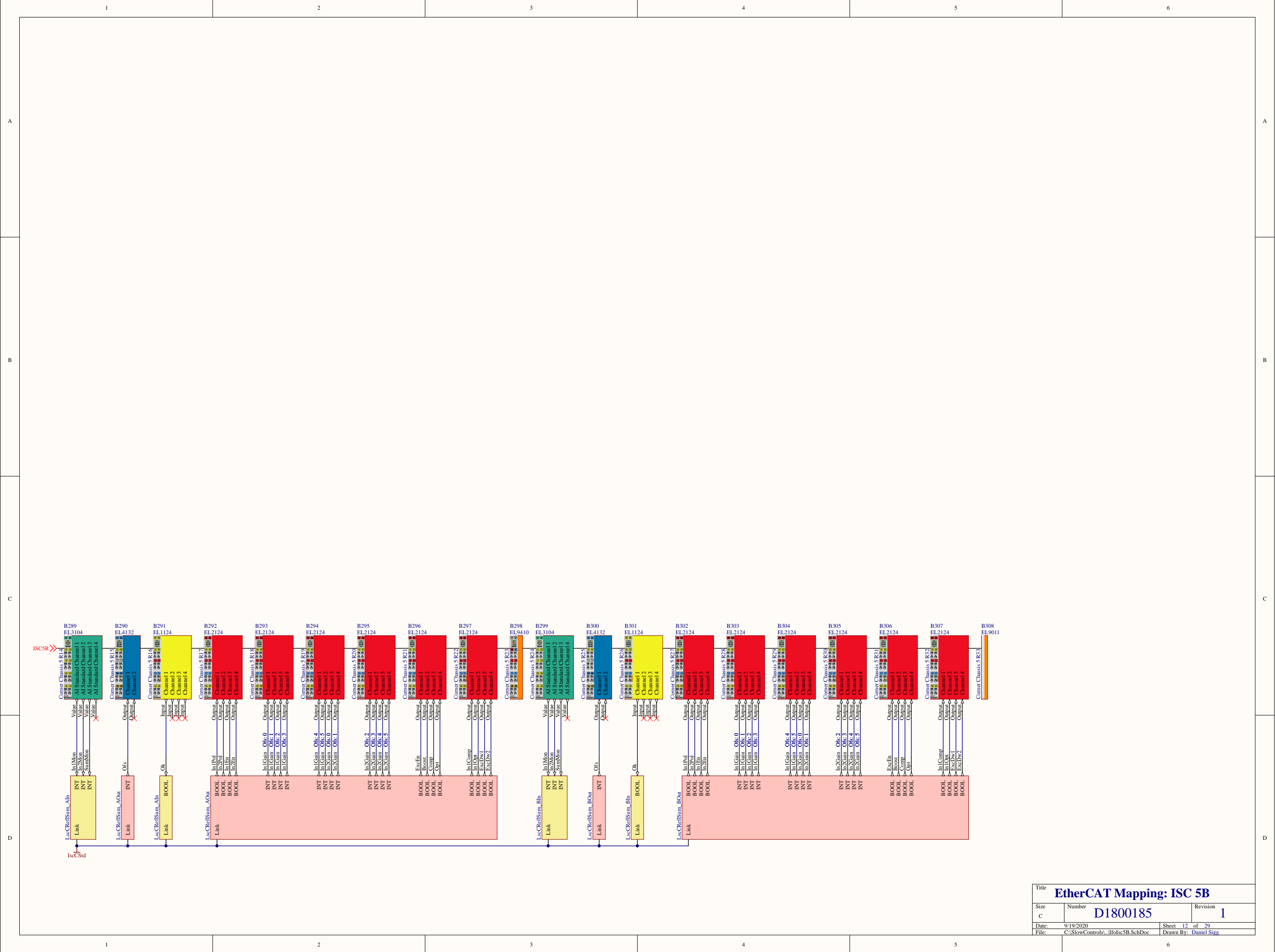

Title EtherCAT Mapping: ISC 5B		
Size	Number	Revision
c	D1800185	1
Date:	9/19/2020	Sheet 12 of 29
File:	C:\SlowControls\...lfolsc5B.SchDoc	Drawn By: Daniel Sig

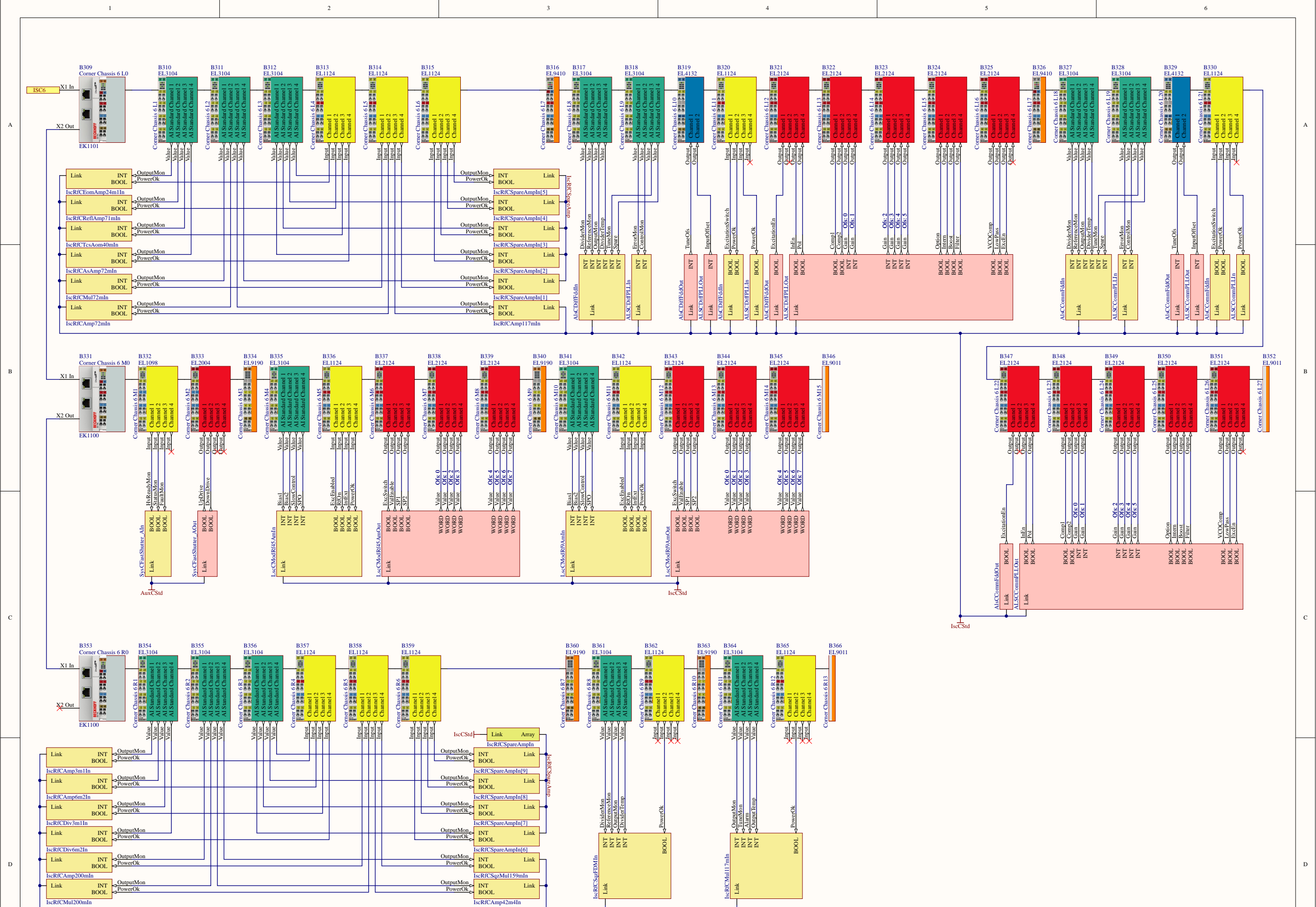

Title EtherCAT Mapping: ISC 6		
Size c	Number D1800185	Revision 1
Date: 9/19/2020	Sheet 13 of 29	
File: C:\SlowControls\...lfolisc6.SchDoc	Drawn By: Daniel Sig	

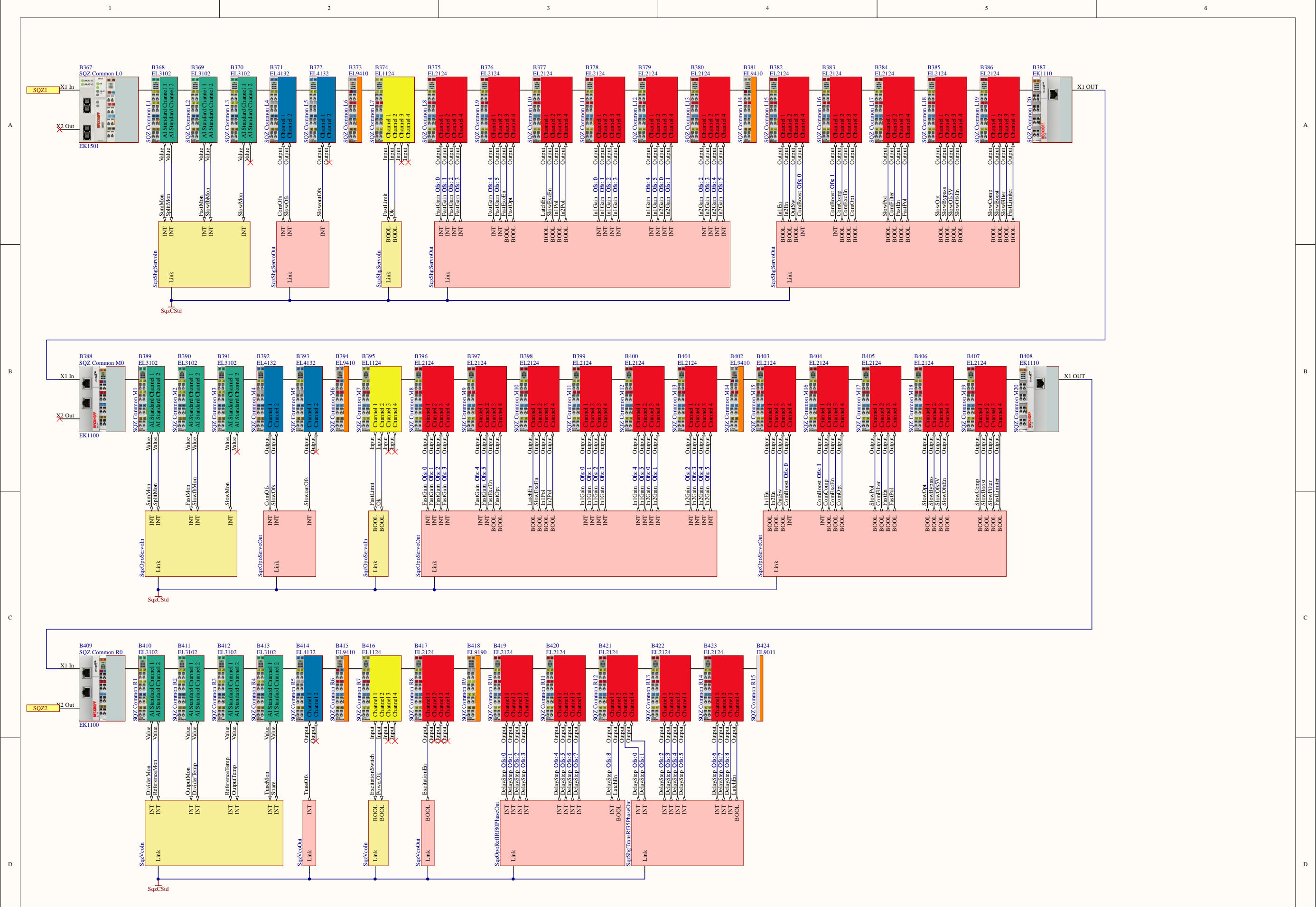

Title EtherCAT Mapping: SQZ 1		
Size	Number	Revision
c	D1800185	1
Date:	9/19/2020	Sheet 14 of 29
File:	C:\SlowControls\...lfoSqr1.SchDoc	Drawn By: Daniel Sig

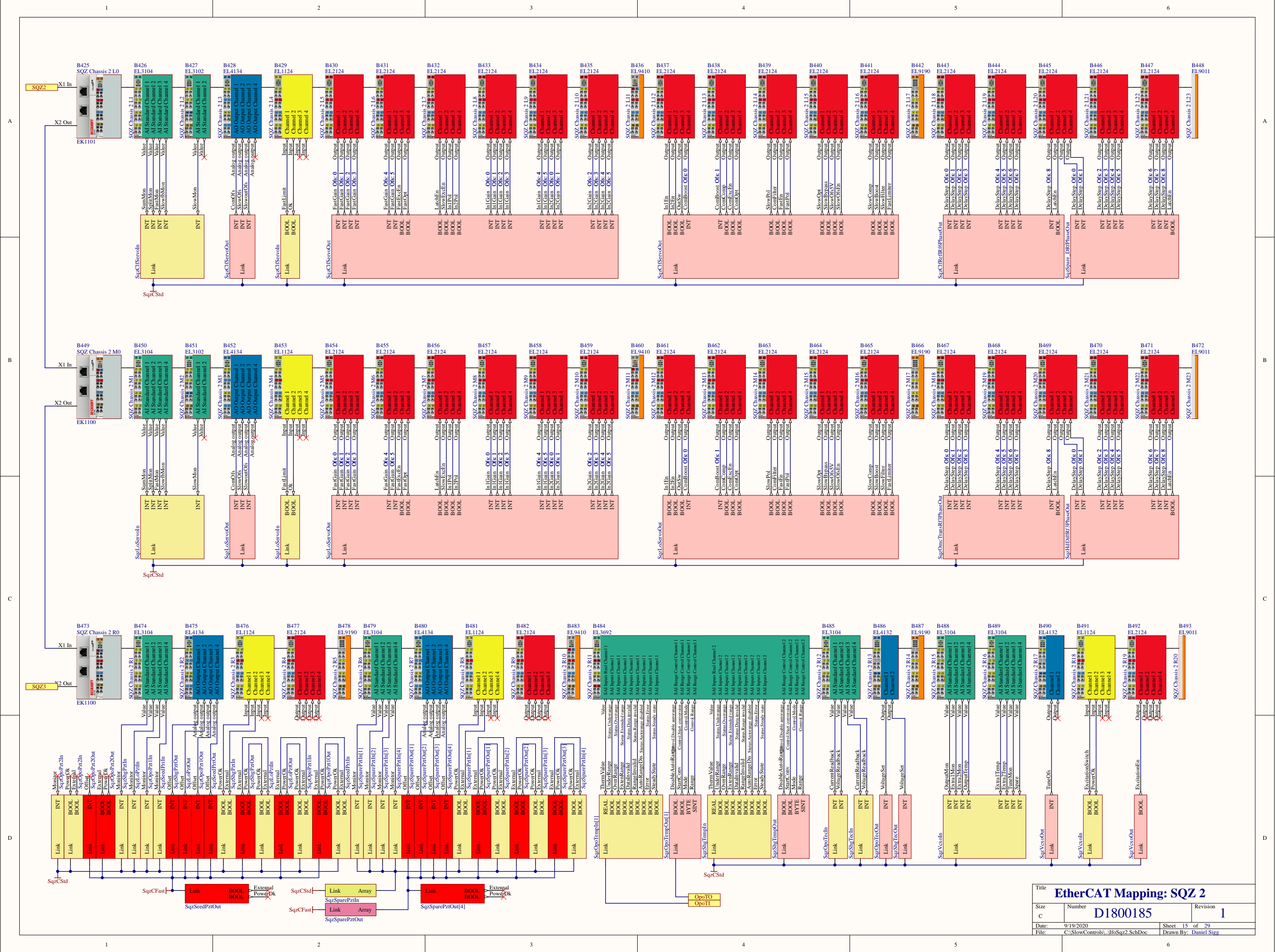

Title		
EtherCAT Mapping: SQZ 2		
Size	Number	Revision
c	D1800185	1
Date:	9/19/2020	Sheet 15 of 29
File:	C:\SlowControls\...lfSqz2.SchDoc	Drawn By: Daniel Sig

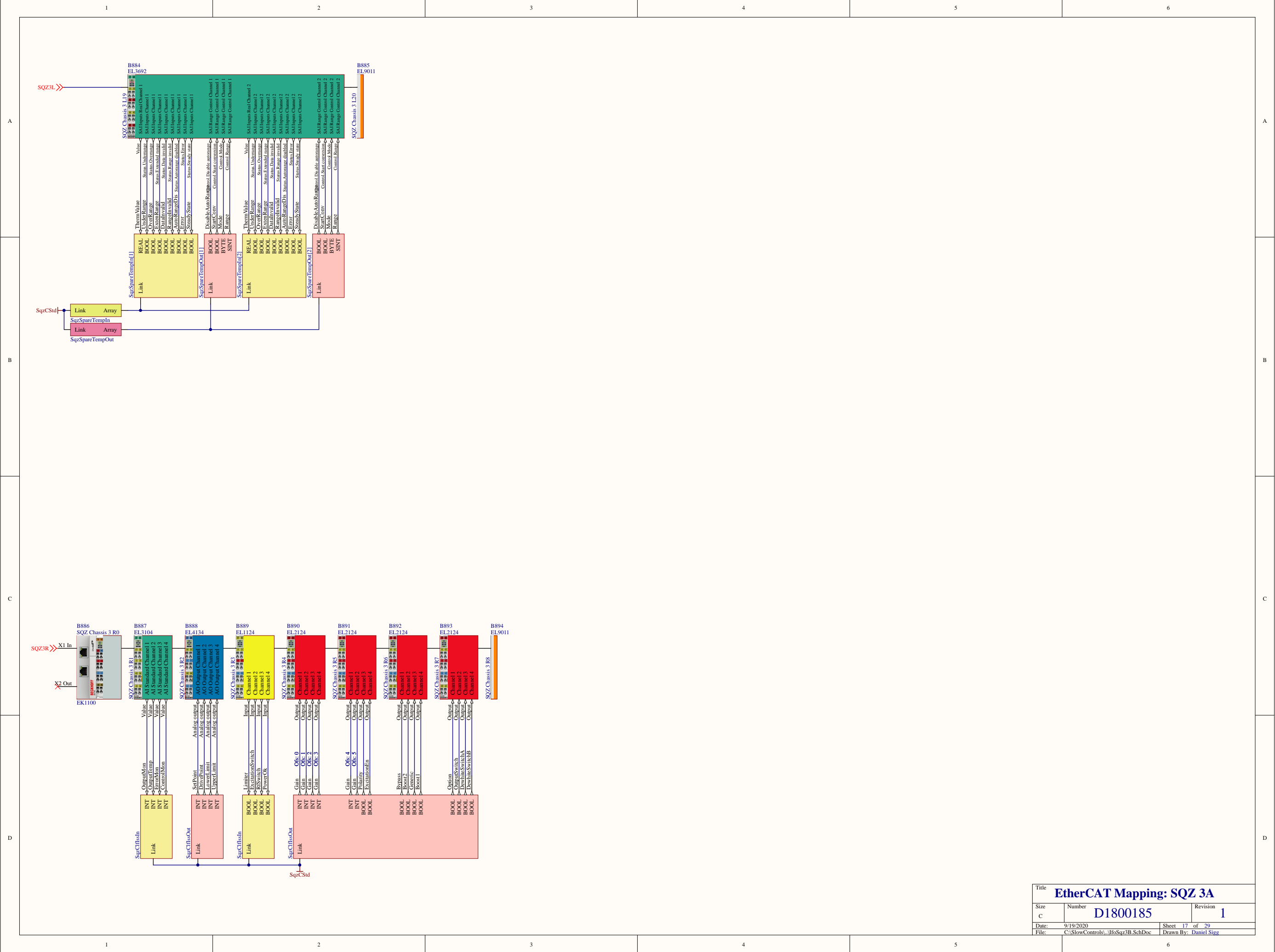

Title EtherCAT Mapping: SQZ 3A		
Size c	Number D1800185	Revision 1
Date: 9/19/2020	Sheet 17 of 29	
File: C:\SlowControls\...lfoSqr3B.SchDoc	Drawn By: Daniel Sig	

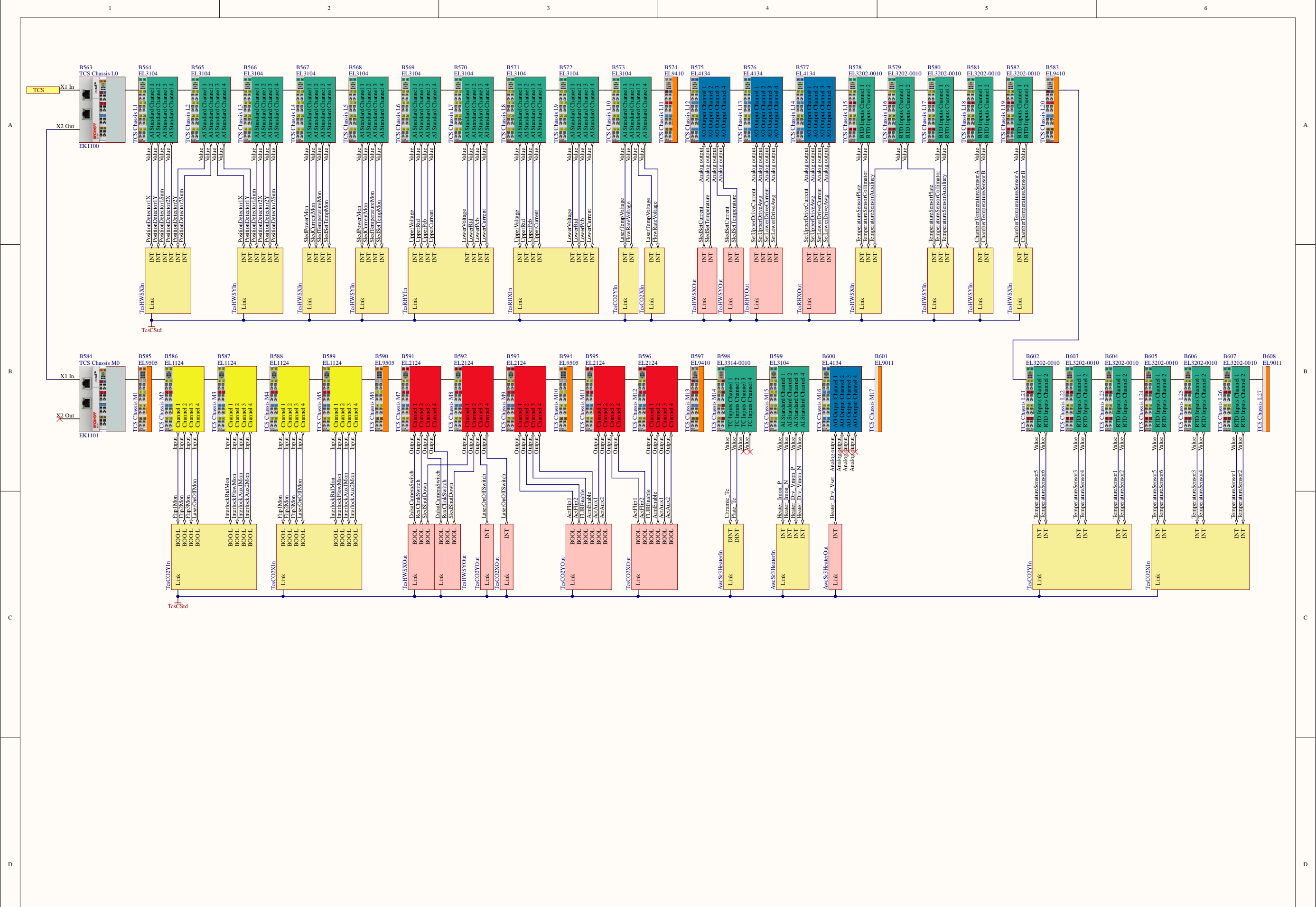

Title EtherCAT Mapping: TCS		
Size c	Number D1800185	Revision 1
Date: 9/19/2020	Sheet 19 of 29	
File: C:\SlowControls\...lfoTcs1.SchDoc	Drawn By: Daniel Sig	

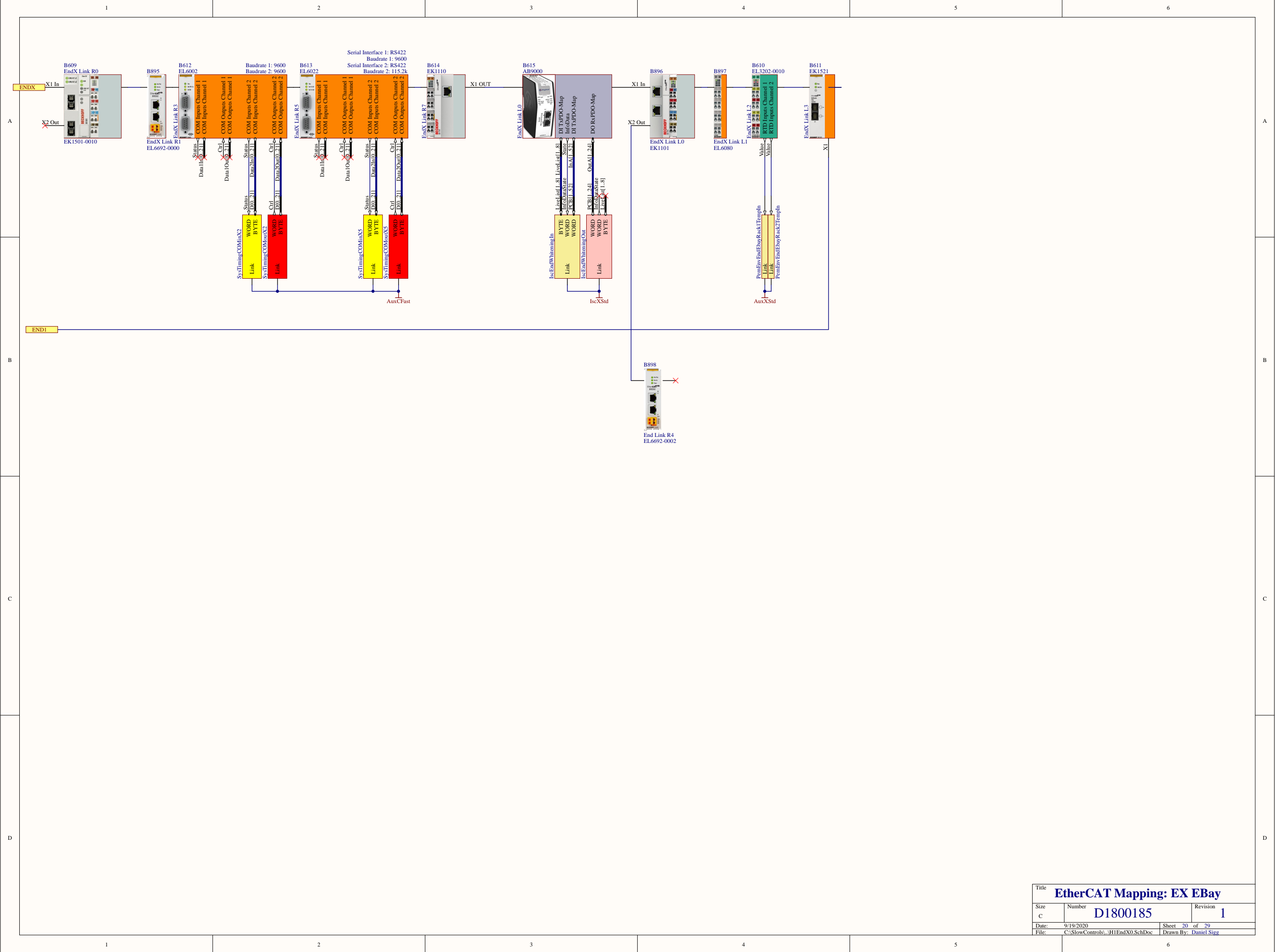

Title EtherCAT Mapping: EX EBay		
Size c	Number D1800185	Revision 1
Date:	9/19/2020	Sheet 20 of 29
File:	C:\SlowControls\...H1EndX0.SchDoc	Drawn By: Daniel Sig

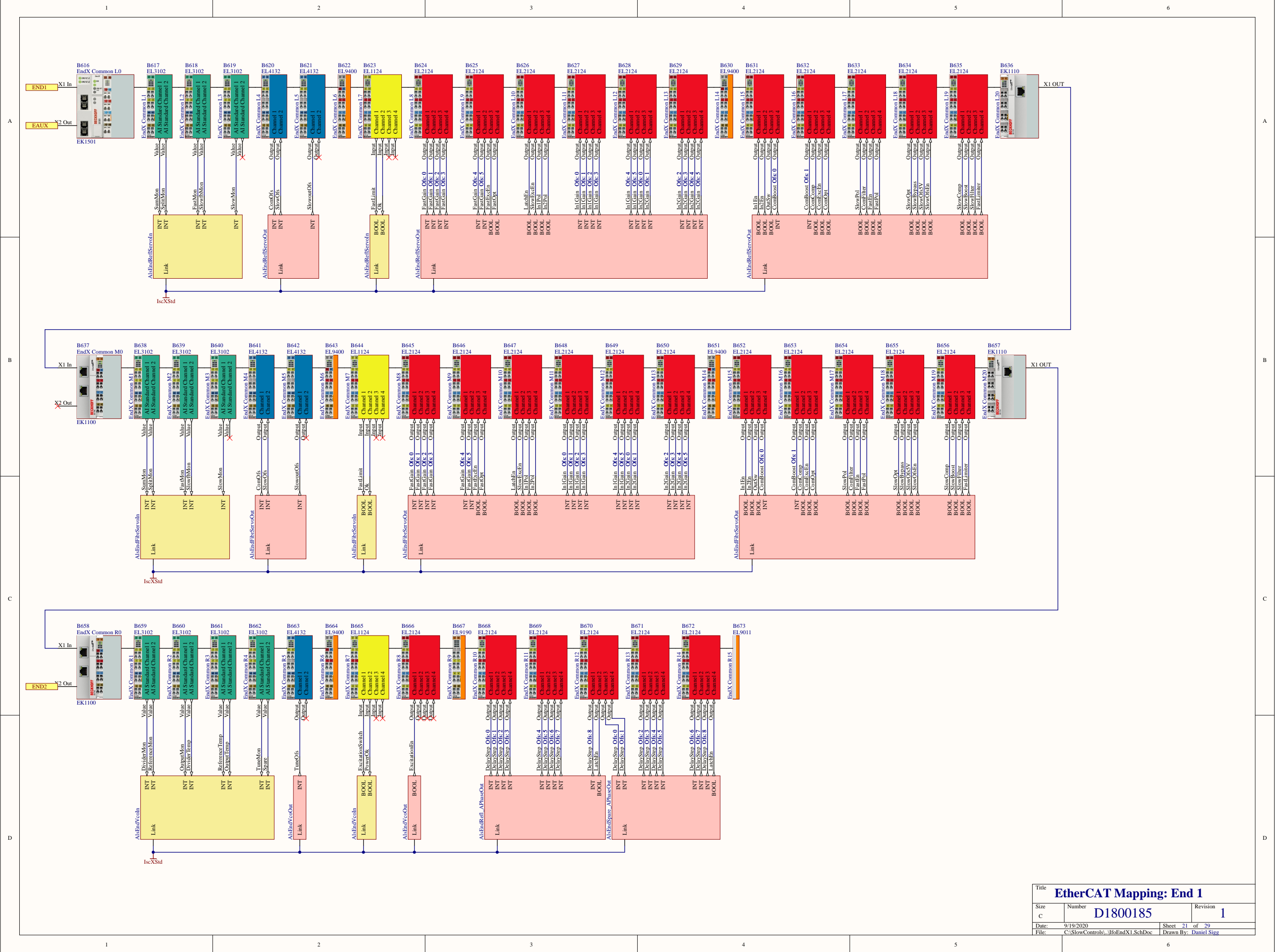

Title EtherCAT Mapping: End 1		
Size	Number	Revision
c	D1800185	1
Date:	9/19/2020	Sheet 21 of 29
File:	C:\SlowControls\...ifoEndX1.SchDoc Drawn By: Daniel Sig	

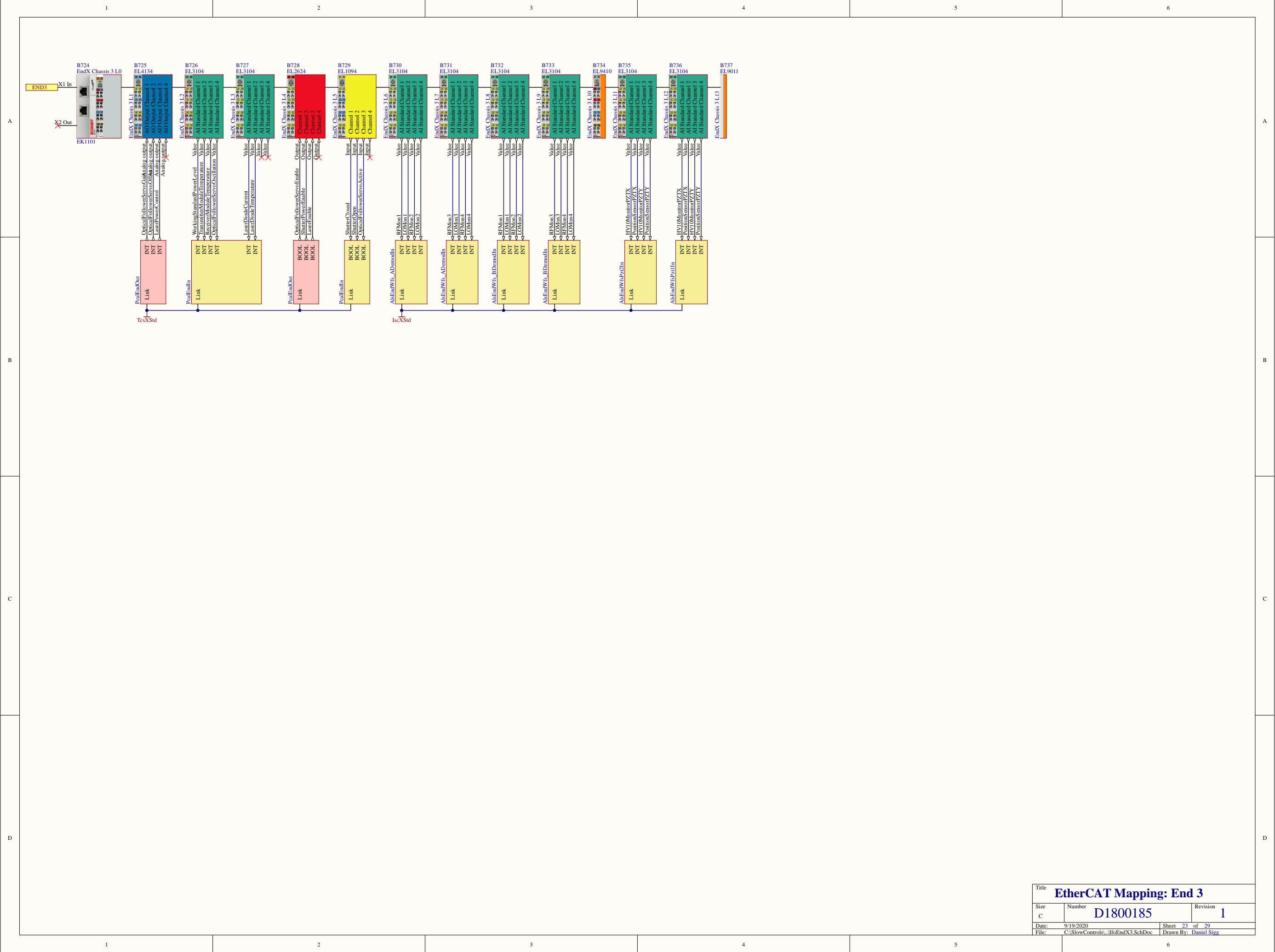

Title		
EtherCAT Mapping: End 3		
Size	Number	Revision
c	D1800185	1
Date:	9/19/2020	Sheet 23 of 29
File:	C:\SlowControls\...ifo\EndX3.SchDoc	Drawn By: Daniel Sigga

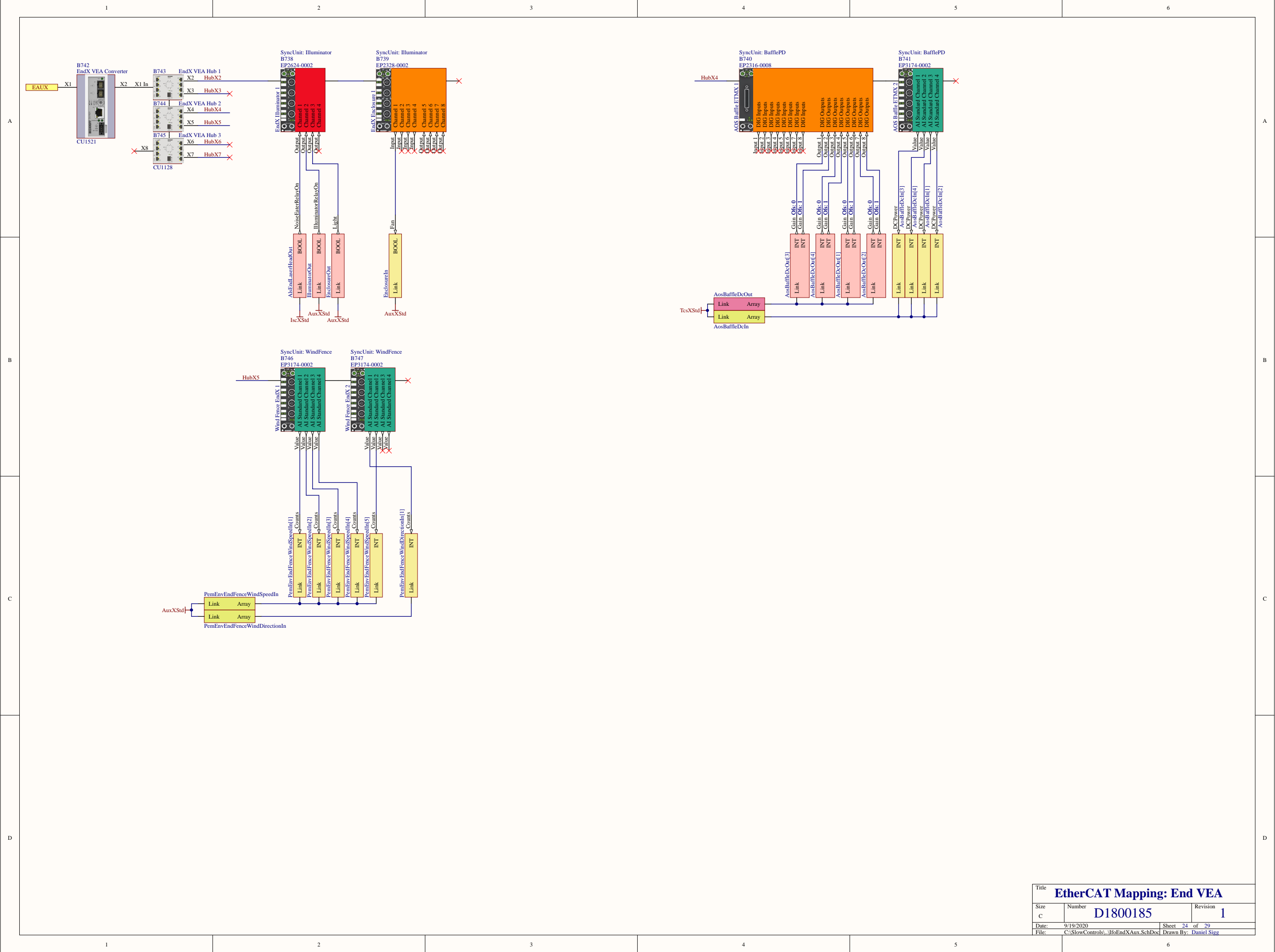

Title			EtherCAT Mapping: End VEA		
Size	Number	Revision		1	
Date:			9/19/2020		
File:			C:\SlowControls\...ifoEndXAux.SchDoc		

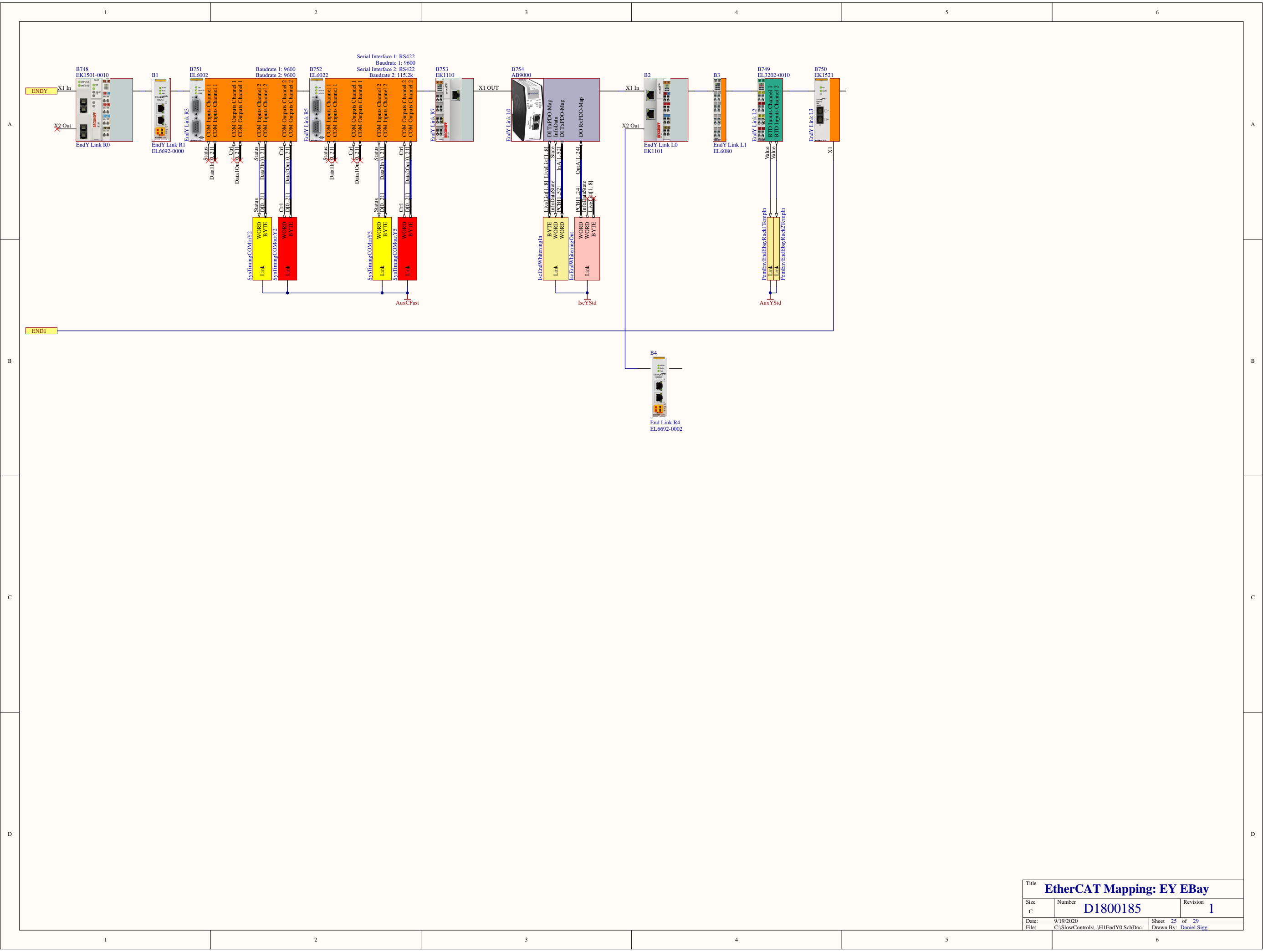

Title EtherCAT Mapping: EY EBay		
Size c	Number D1800185	Revision 1
Date:	9/19/2020	Sheet 25 of 29
File:	C:\SlowControls\...H1EndY0.SchDoc	Drawn By: Daniel Sigg

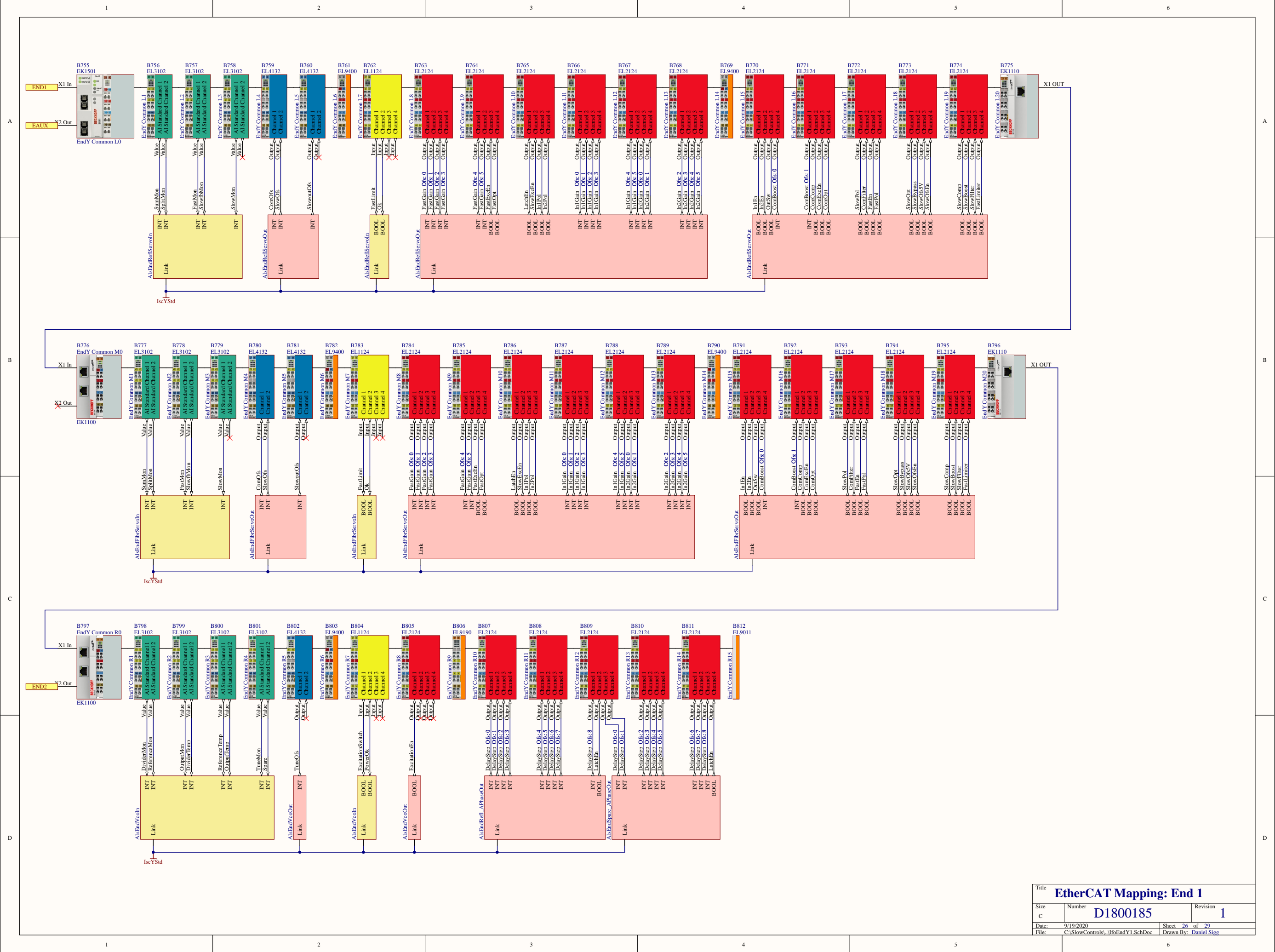

Title		
EtherCAT Mapping: End 1		
Size	Number	Revision
c	D1800185	1
Date:	9/19/2020	Sheet 26 of 29
File:	C:\SlowControls\...lfoEndY1.SchDoc	Drawn By: Daniel Sig

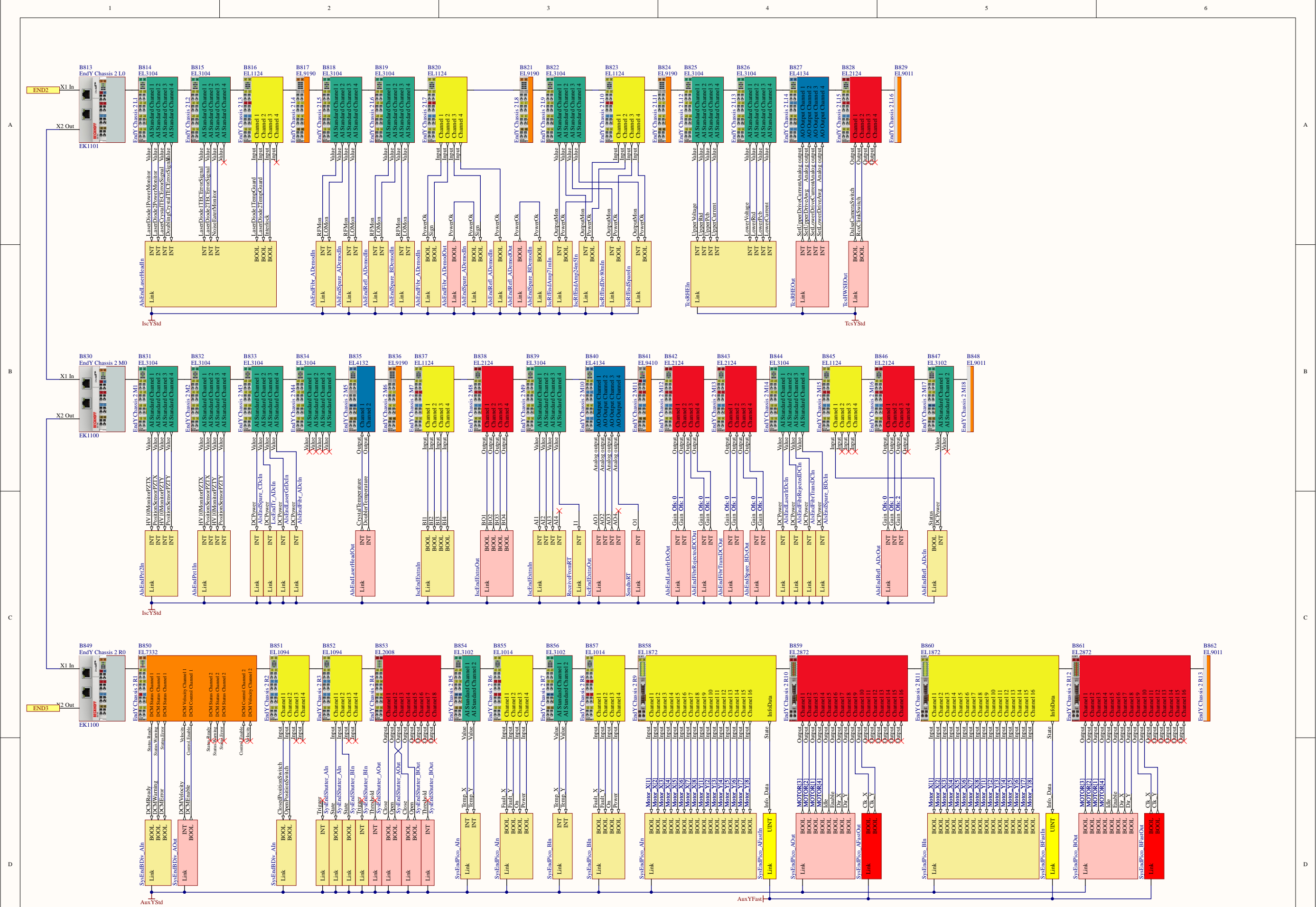

Title EtherCAT Mapping: End 2		
Size	Number	Revision
c	D1800185	1
Date:	9/19/2020	Sheet 27 of 29
File:	C:\SlowControls\...InfoEndY2.SchDoc	Drawn By: Daniel Sig

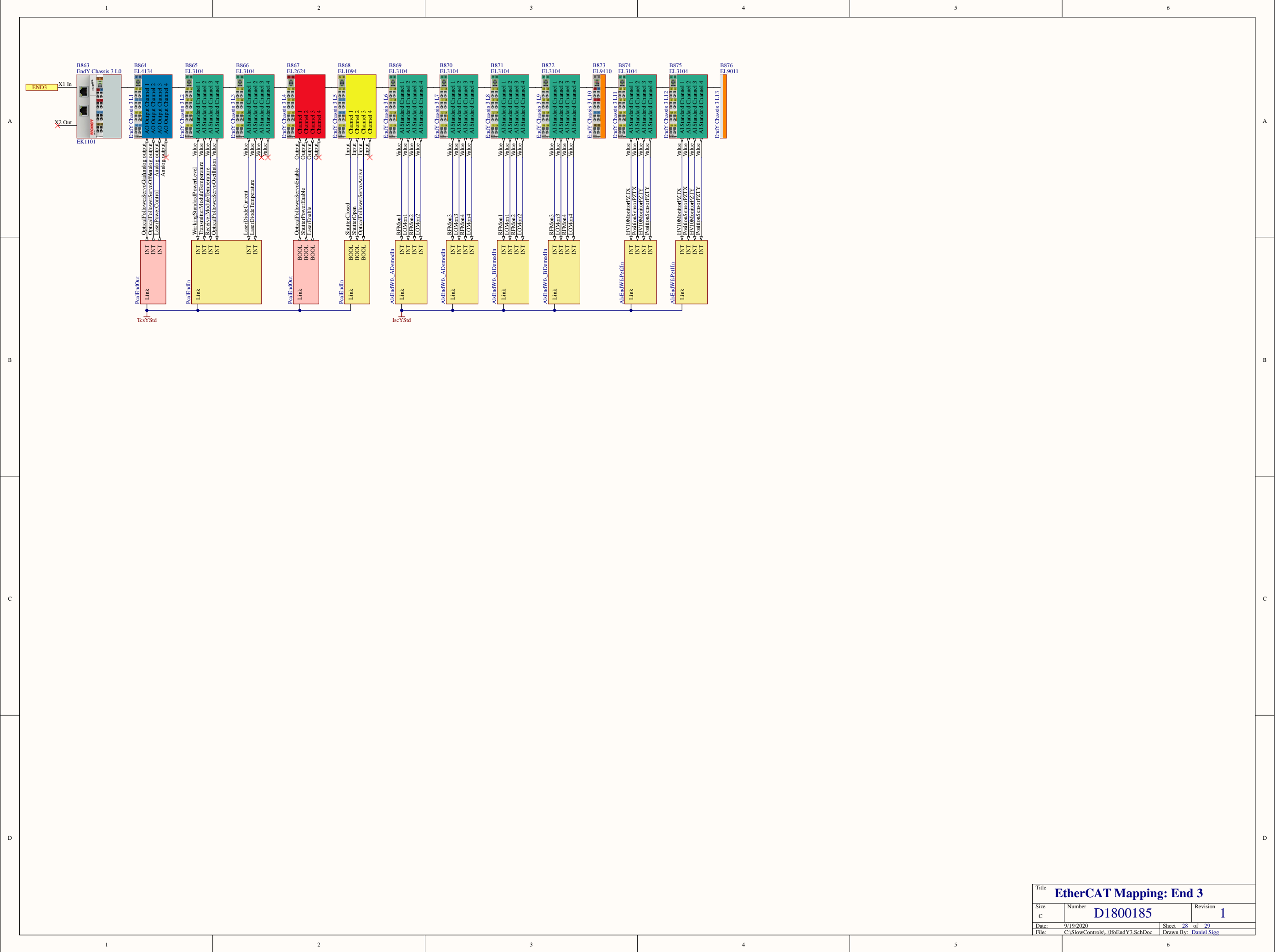

Title EtherCAT Mapping: End 3		
Size c	Number D1800185	Revision 1
Date:	9/19/2020	Sheet 28 of 29
File:	C:\SlowControls\...ifoEndY3.SchDoc	Drawn By: Daniel Sig

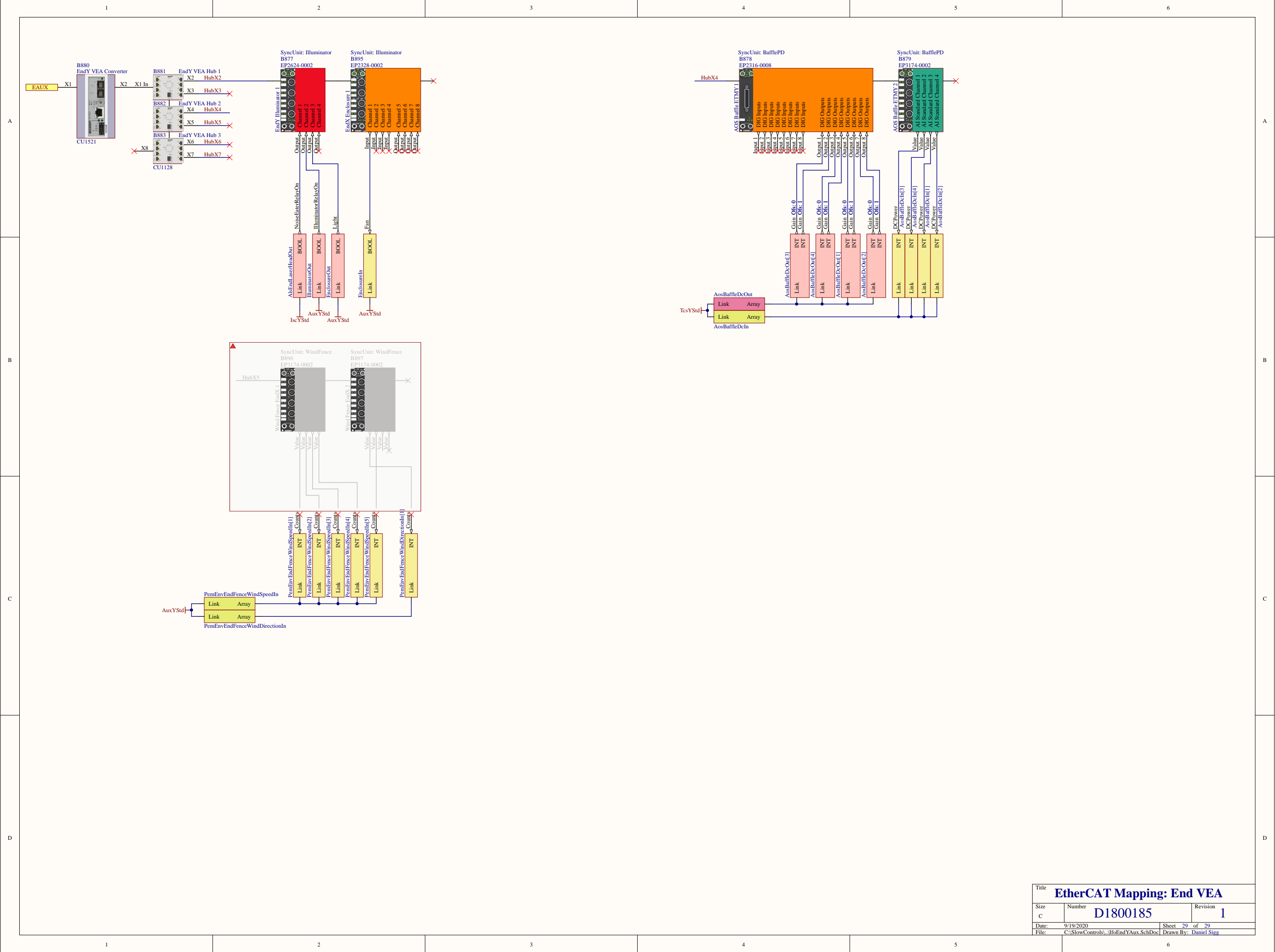

Title			EtherCAT Mapping: End VEA
Size	Number	Revision	
c	D1800185	1	
Date:	9/19/2020	Sheet	29 of 29
File:	C:\SlowControls\...ifoEndYAux.SchDoc	Drawn By:	Daniel Sigga