



Gravitational Waves Detected: The physics behind the detection, The physics we observed

Séminaire Poincaré
3 December 2016

David Shoemaker
For the LIGO and Virgo Scientific Collaborations

Credits

Measurement results: LIGO/Virgo Collaborations,
PRL 116, 061102 (2016); <http://arxiv.org/abs/1606.04856>

Simulations: SXS Collaboration; LIGO Laboratory

Localization: S. Fairhurst arXiv:1205.6611v1

Photographs: LIGO Laboratory; MIT; Caltech

Virgo and LIGO

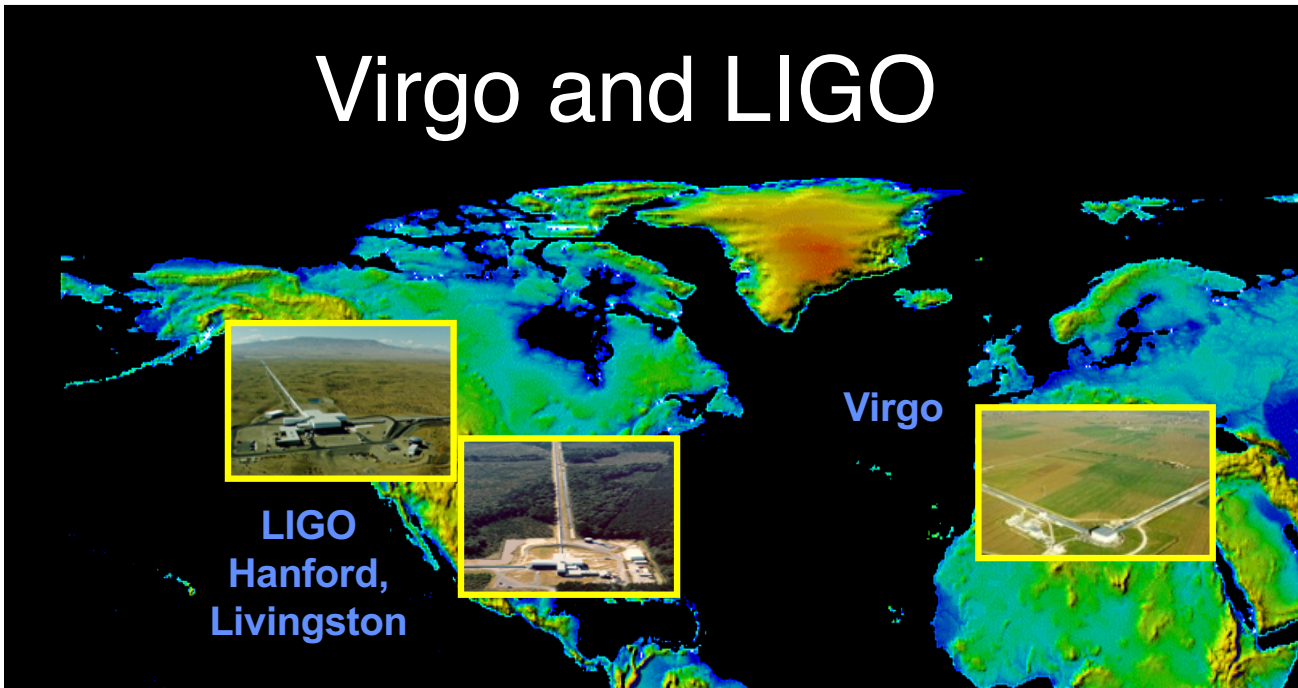

Virgo and LIGO built
new observatories in
the 90's

...and Observed with the initial detectors
2005-2011,
and saw **no signals**

(and some interesting non-detections)

Advanced Detectors: *a qualitative difference*

- While observing with initial detectors, parallel R&D led to better concepts
- Design for 10x better sensitivity

- We measure amplitude, so signal falls as $1/r$
- **1000x more candidates**



M. Evans

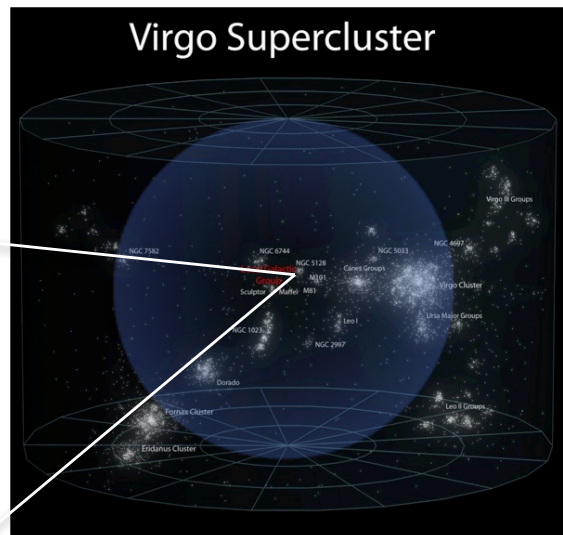

Initial Reach

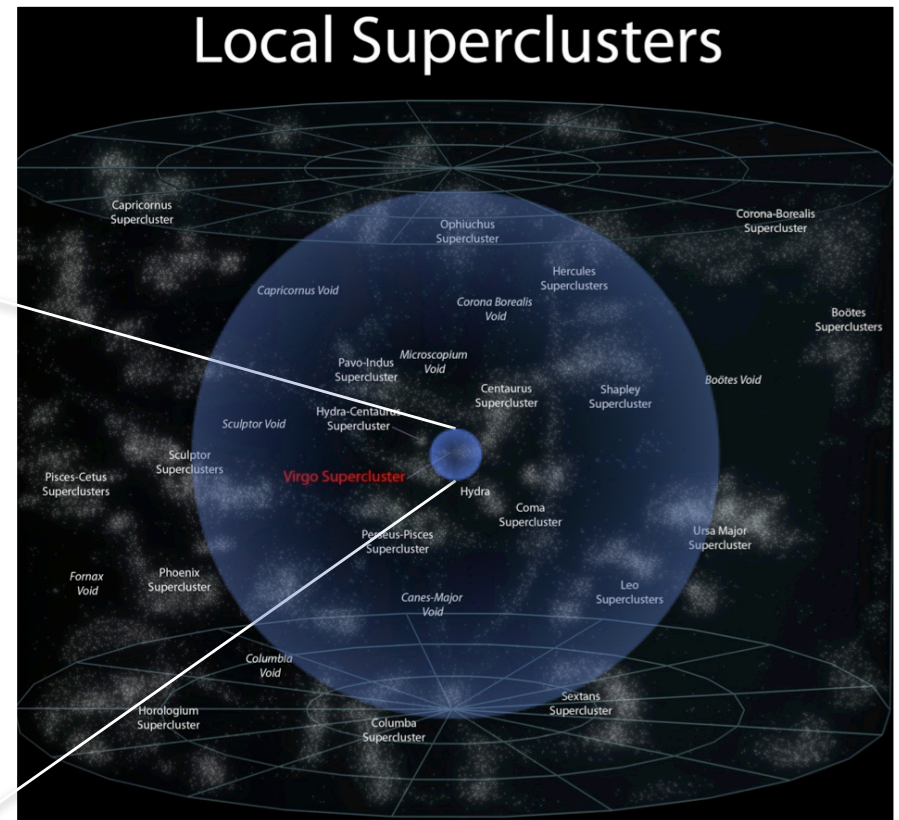

Advanced Reach

What is our measurement technique?

- Enhanced **Michelson interferometers**
 - » LIGO, Virgo, and GEO600 use variations
- Passing GWs modulate the distance between the end test mass and the beam splitter
- The interferometer acts as a transducer, turning GWs into photocurrent proportional to the strain amplitude
- **Arms are short compared to our GW wavelengths, so longer arms make bigger signals**
→ multi-km installations
- Arm length limited by taxpayer noise....

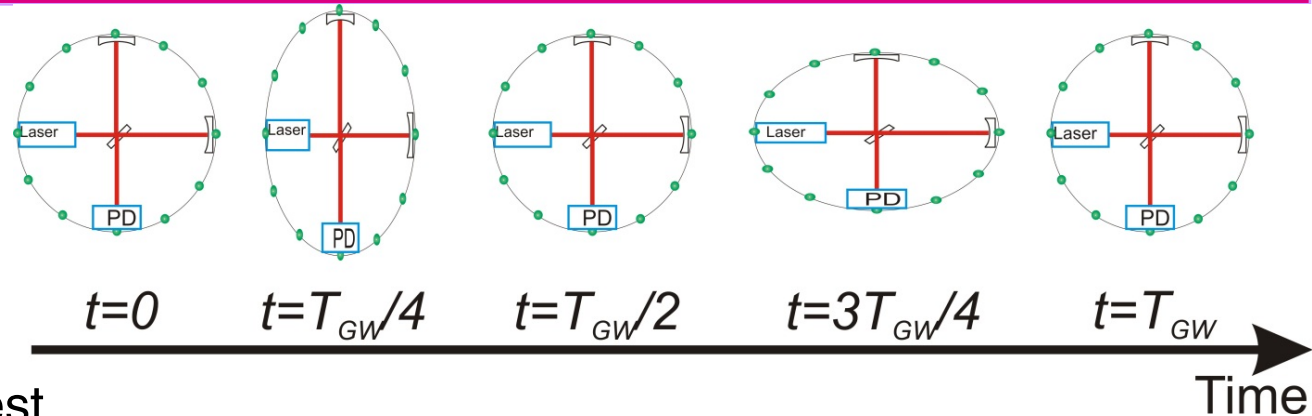

$$h \approx \frac{\Delta L}{L}$$

Magnitude of h at Earth:
 Largest signals $h \sim 10^{-21}$
 (1 hair / Alpha Centauri)
 For $L = 1 \text{ m}$, $\Delta L = 10^{-21} \text{ m}$
 For $L = 4\text{km}$, $\Delta L = 4 \times 10^{-18} \text{ m}$

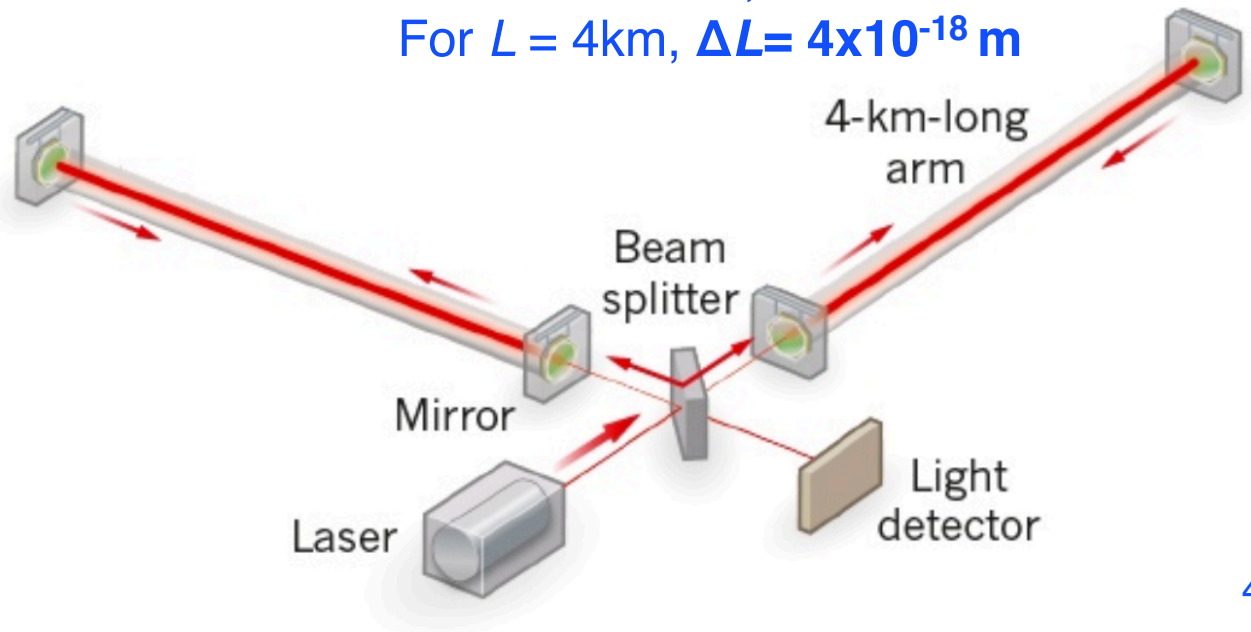



Measuring $\Delta L = 4 \times 10^{-18}$ m Readout

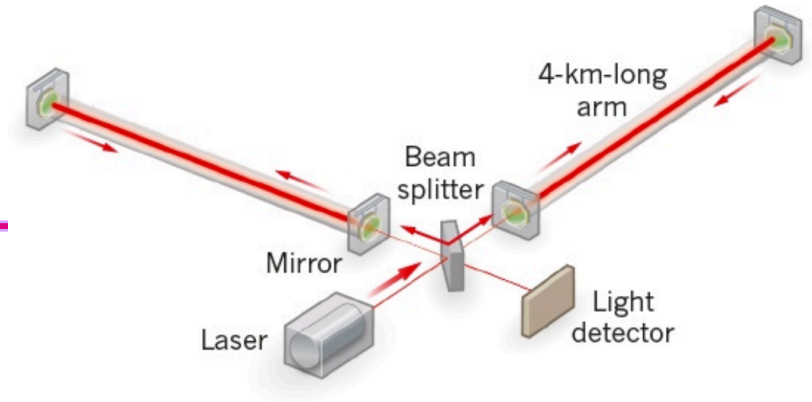

- **Shot noise** – ability to resolve a fringe shift due to a GW (counting statistics)
- *Zum gegenwärtigen Stand des Strahlungsproblems, A. Einstein, 1909*
- Fringe Resolution at high frequencies improves as as (laser power)^{1/2}

$$h_{\text{sn}}(f) = \frac{1}{L} \sqrt{\frac{\hbar c \lambda}{2\pi P}}$$

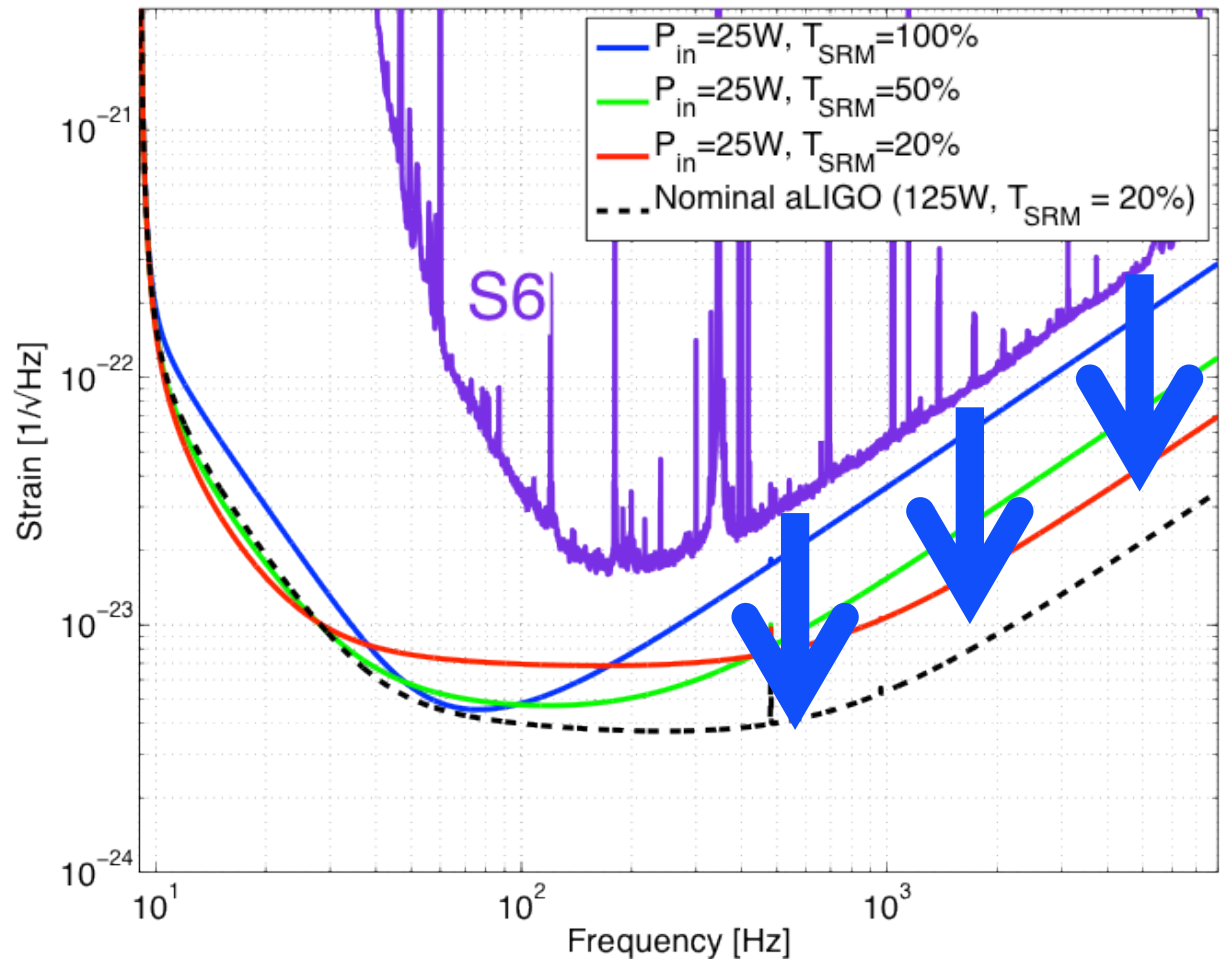



Measuring $\Delta L = 4 \times 10^{-18}$ m Readout

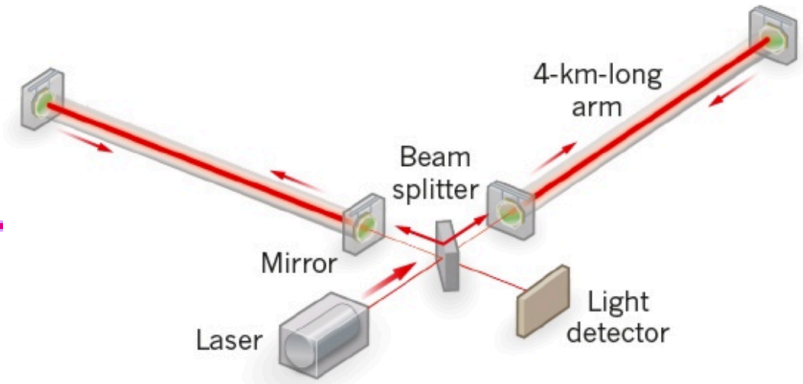

- Shot noise – ability to resolve a fringe shift due to a GW (counting statistics)

$$h_{\text{sn}}(f) = \frac{1}{L} \sqrt{\frac{\hbar c \lambda}{2\pi P}}$$

- **Radiation Pressure noise** – Point of diminishing returns when buffeting of test mass by photons increases low-frequency noise – use heavy test masses!

$$h_{\text{rp}}(f) = \frac{1}{m f^2 L} \sqrt{\frac{\hbar P}{2\pi^3 c \lambda}}$$

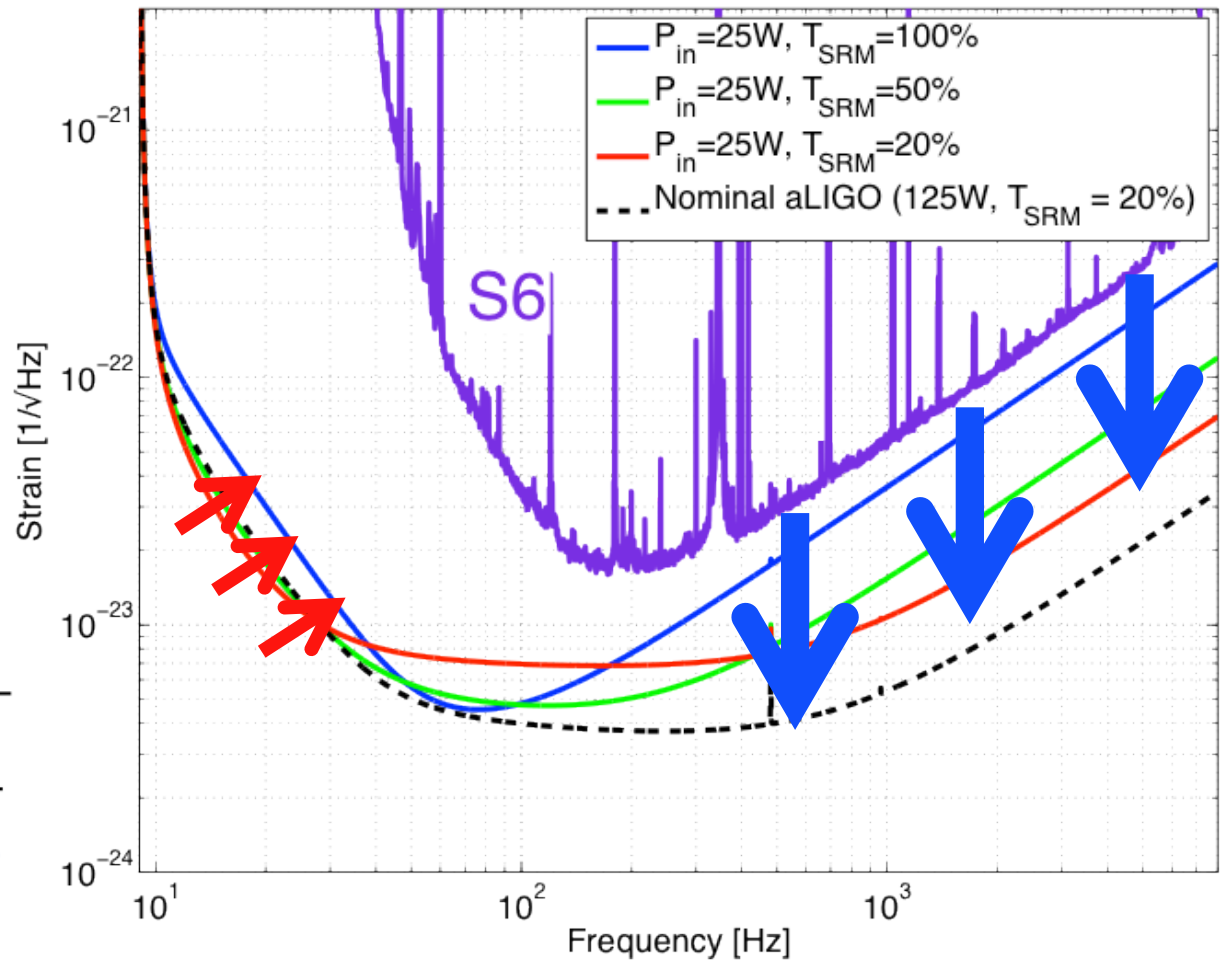

Standard Quantum Limit

- For a simple model of the instrument, one can choose the frequency of the best compromise between the two effects

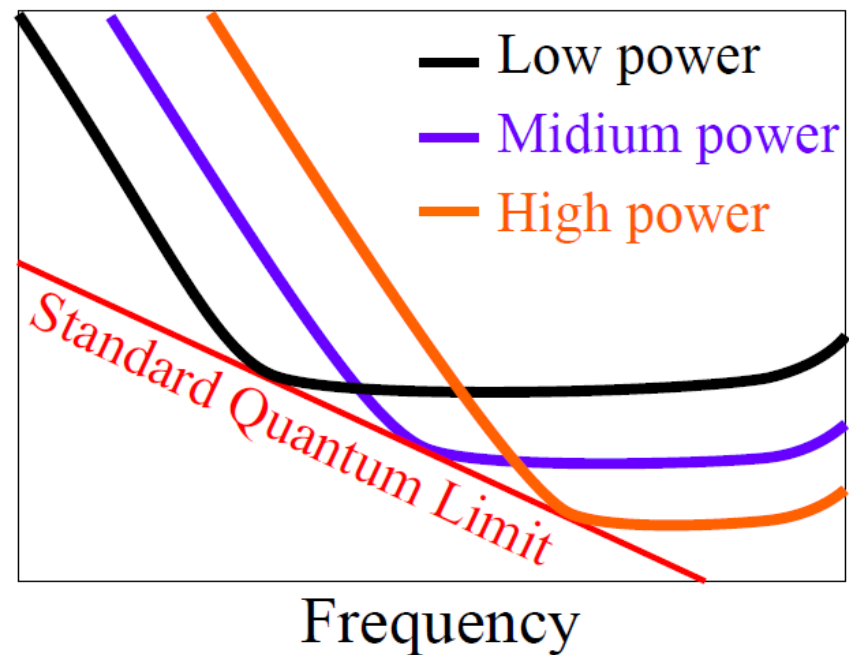
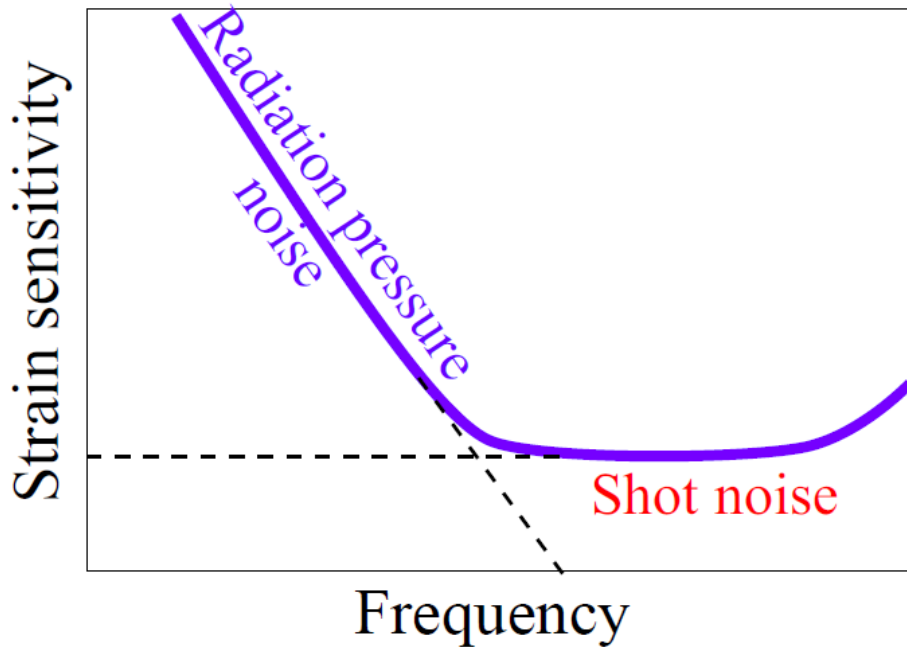

Detuned signal recycling (SR)

- In fact, in Advanced LIGO the signal recycling mirror couples phase and amplitude, and there is pondermotive squeezing of the light

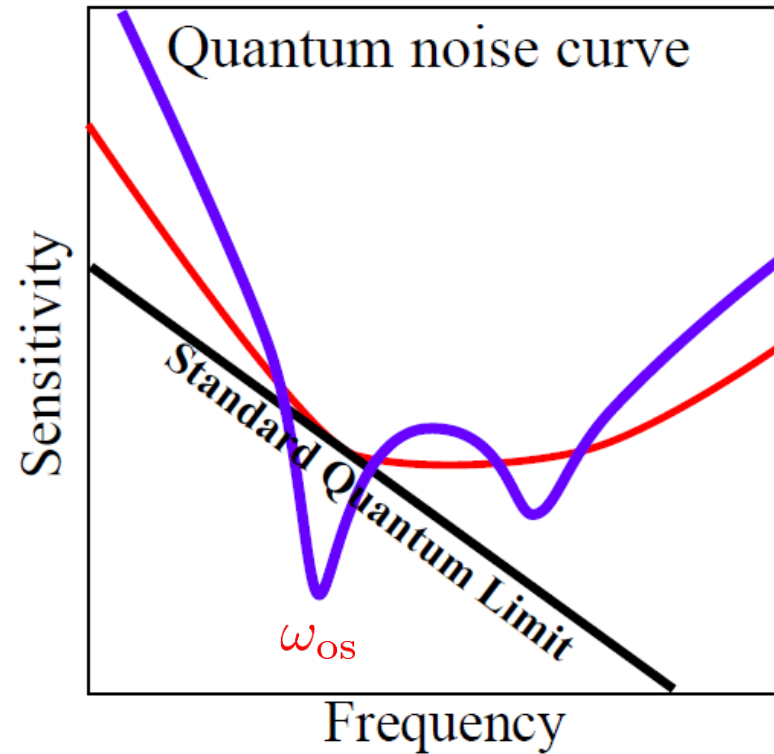
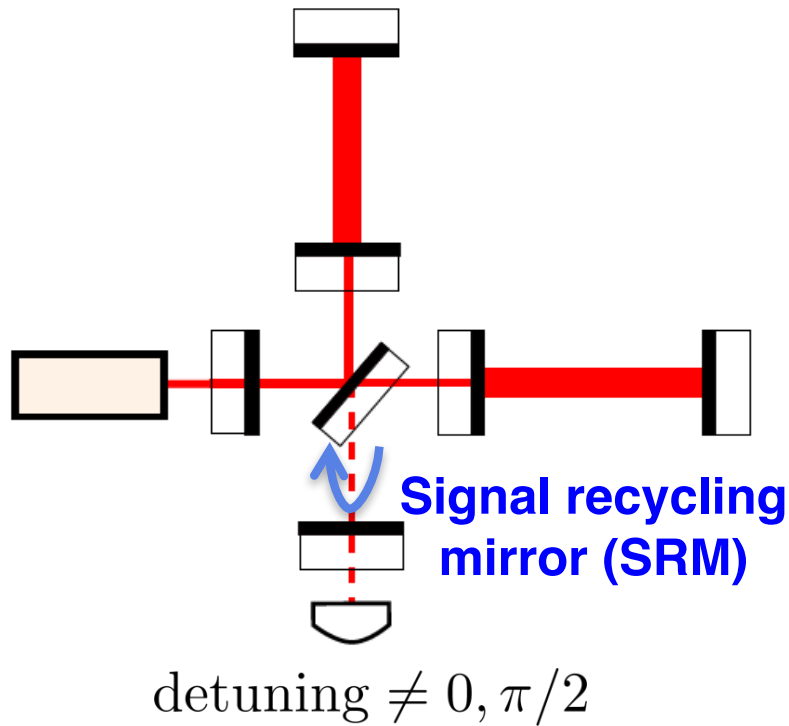

One interpretation: optical spring effect

$$M\ddot{x}(t) = F_{\text{GW}}(t) \quad \Rightarrow \quad M\ddot{x}(t) = -M\omega_{\text{os}}^2 x(t) + F_{\text{GW}}(t)$$

[1] A. Buonanno and Y. Chen. *Signal recycled laser-interferometer gravitational-wave detectors as optical springs*,



Measuring $\Delta L = 4 \times 10^{-18}$ m Readout

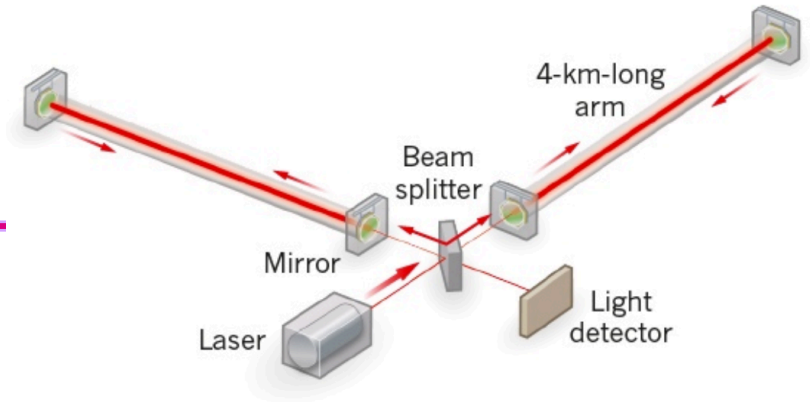

- Advanced LIGO is expected to operate in this pondermotive regime with its **200W laser, 40 kg test masses**
- ...not yet, though (only see shot noise to date)

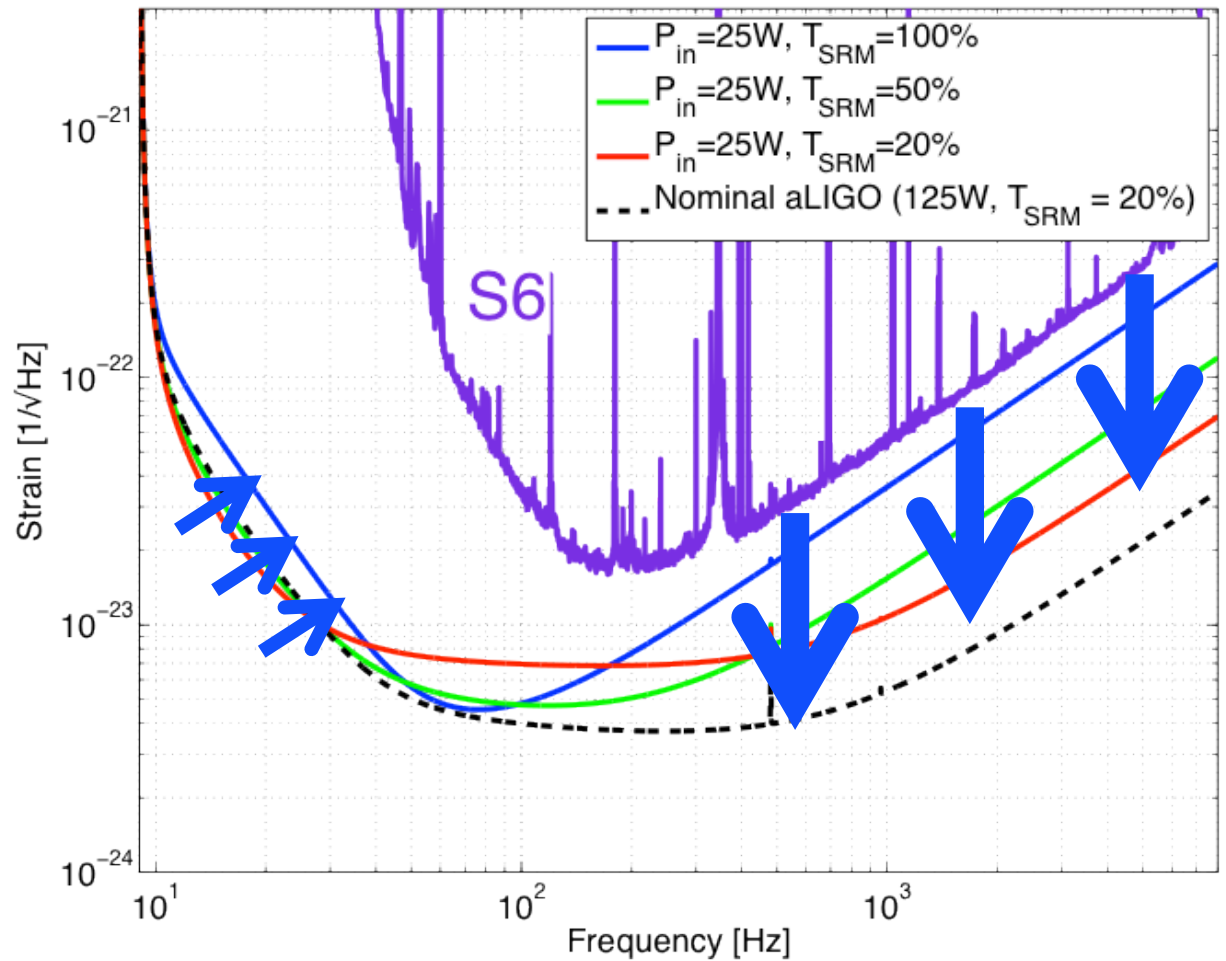

Measuring $\Delta L = 4 \times 10^{-18}$ m

Internal motion

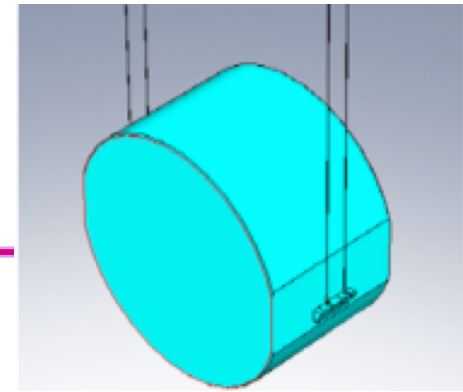

- **Thermal noise** – kT of energy per mechanical mode
- *Über die von der molekularkinetischen Theorie der Wärmegeforderte Bewegung von in ruhenden Flüssigkeiten suspendierten Teilchen,*
A. Einstein, 1905
- Simple Harmonic Oscillator:

$$x_{rms} = \sqrt{\langle (\delta x)^2 \rangle} = \sqrt{k_B T / k_{spring}}$$

- Distributed in frequency according to real part of impedance $\Re(Z(f))$

$$\tilde{x}(f) = \frac{1}{\pi f} \sqrt{\frac{k_B T}{\Re(Z(f))}}$$

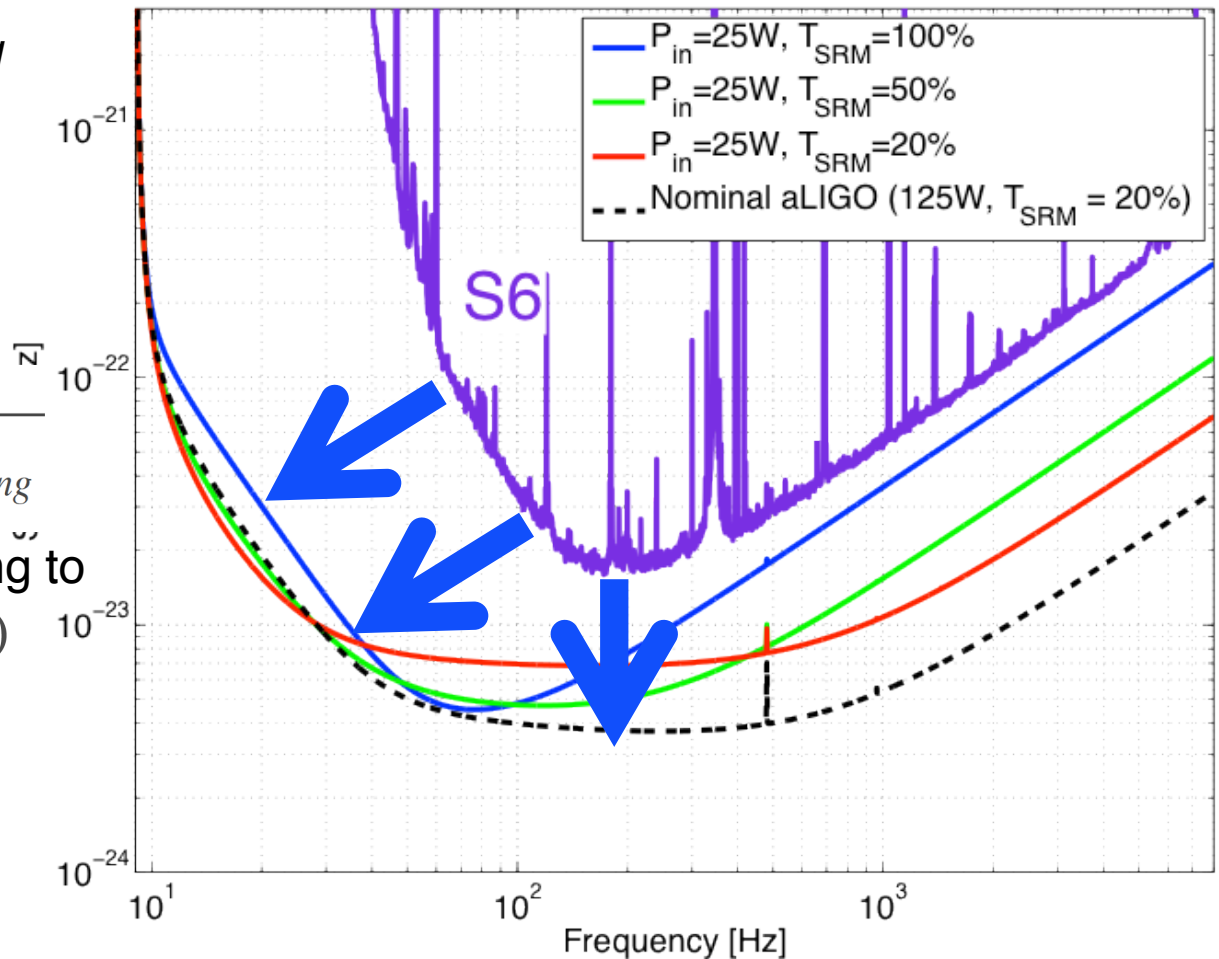

Measuring $\Delta L = 4 \times 10^{-18}$ m

Internal motion

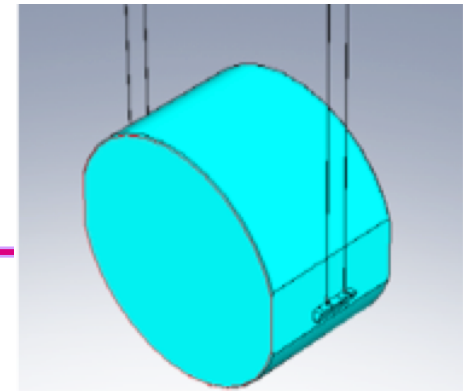

- **Thermal noise** – kT of energy per mechanical mode
 - » This is the integral under the curve of motion...
- Fluctuation-dissipation theorem gives motion as a function of frequency
- Low mechanical loss materials gather this motion into a narrow peak at resonant frequencies
 - » Lower noise above and below the peak

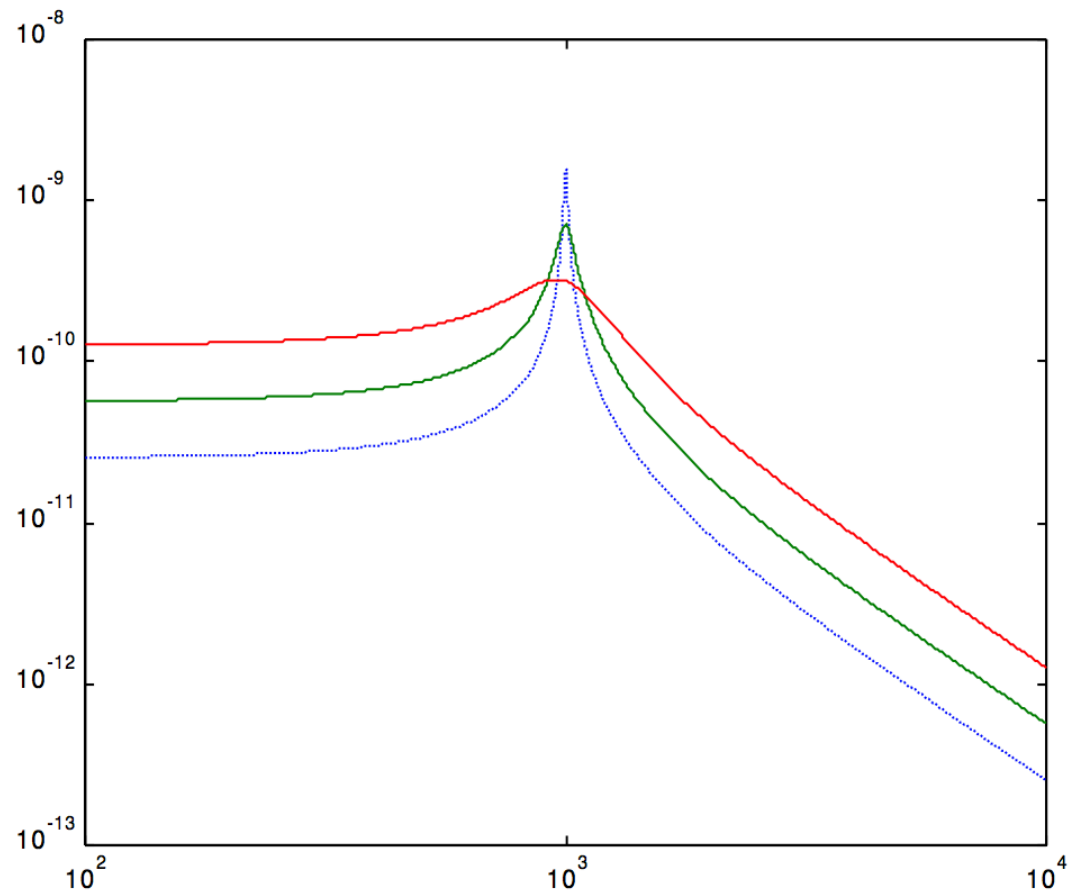

Measuring $\Delta L = 4 \times 10^{-18}$ m

Internal motion

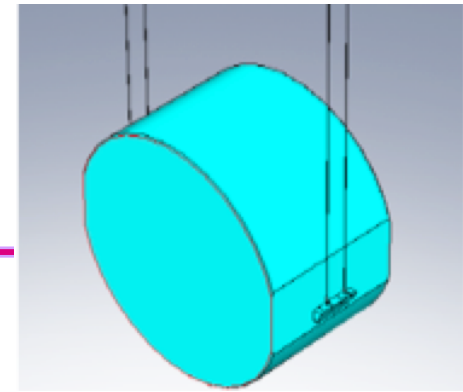

- In Advanced LIGO, the optical coating is the dominant loss
 - » $\sim 100\mu\text{m}$ thick
- Fused silica components have losses of order $10^{-6} - 10^{-8}$
- Sputtered optical coatings have losses of order 10^{-4}
- **And** the lossy coating is the interface to the laser beam
- **This is the dominant limit in the critical 10-200 Hz band**
- A focus of research!

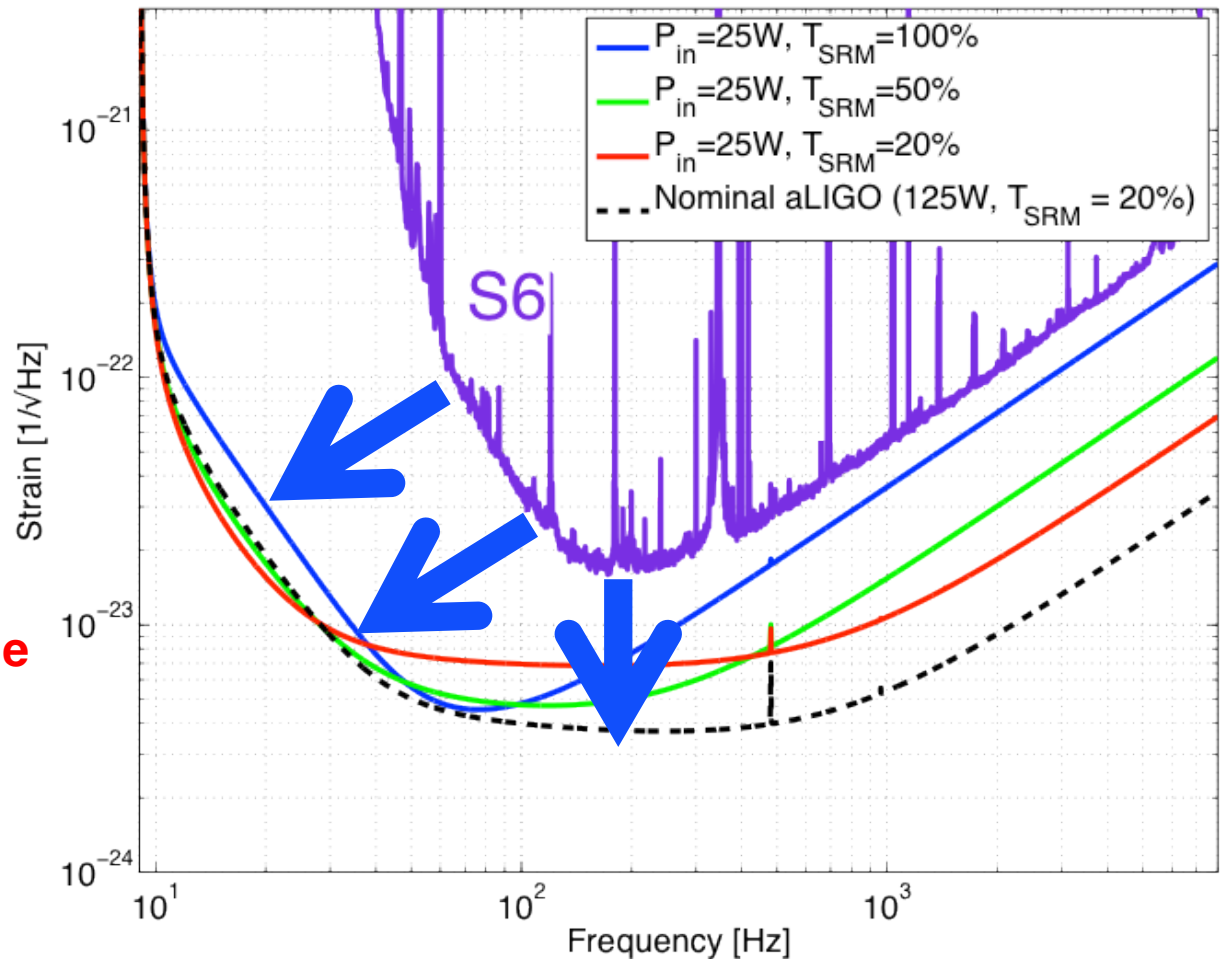

Measuring $\Delta L = 4 \times 10^{-18}$ m

Forces on test mass

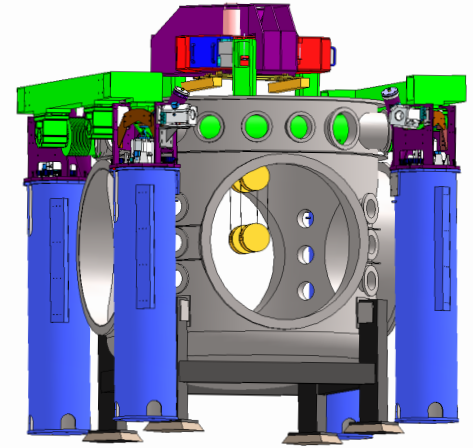

- **Seismic noise** – must prevent masking of GWs, enable practical control systems
- *(did Einstein work on seismic motion...?)*
- Motion from waves on coasts...and people moving around
- GW band: 10 Hz and above – direct effect of masking
- Control Band: below 10 Hz – forces needed to hold optics on resonance and aligned
- aLIGO uses **active servo-controlled platforms, multiple pendulums**

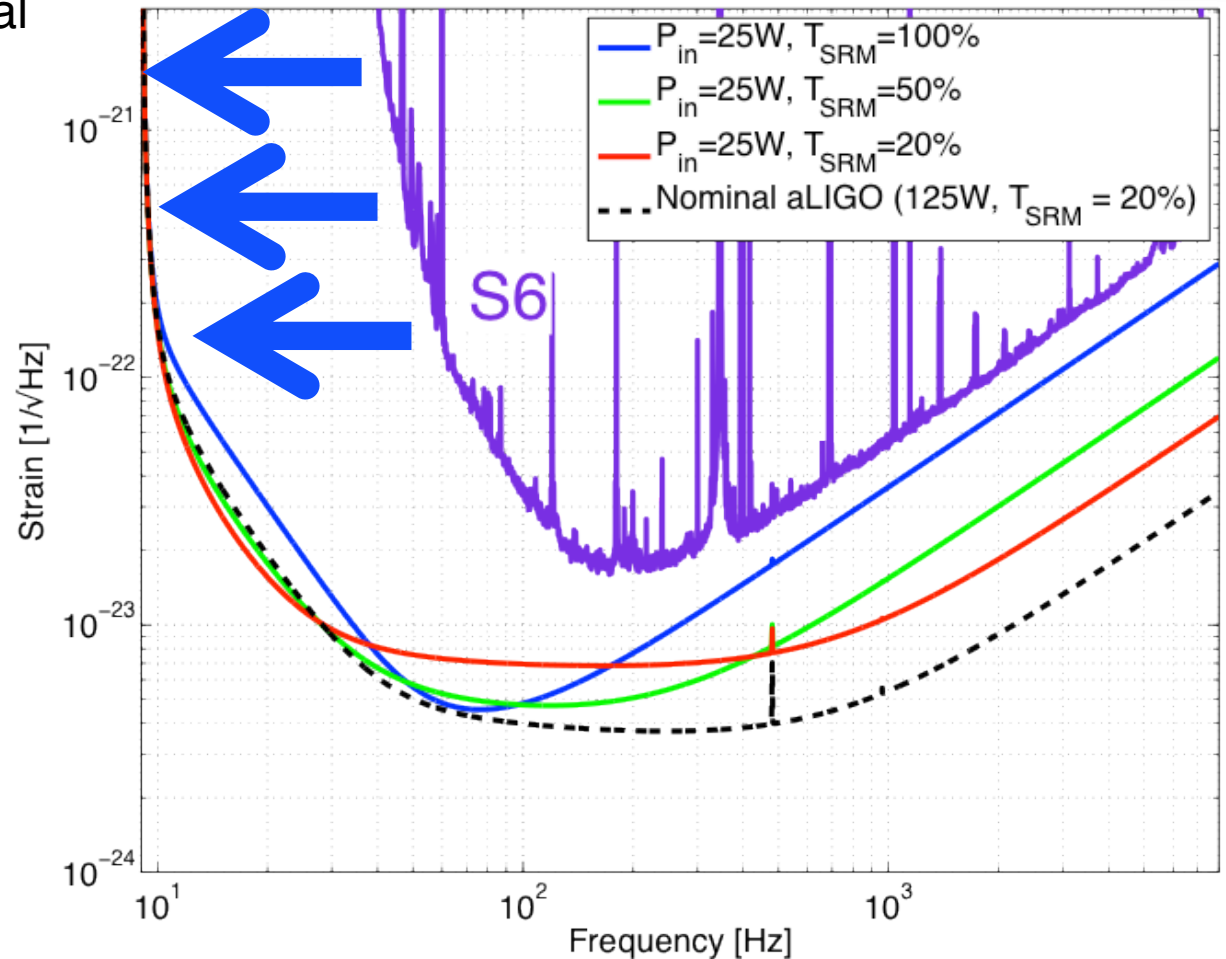



Measuring $\Delta L = 4 \times 10^{-18}$ m

Forces on test mass

- Ultimate limit on the lowest frequency detectors on- or under-ground:
- Newtonian background – wandering net gravity vector; a limit in the 10-20 Hz band

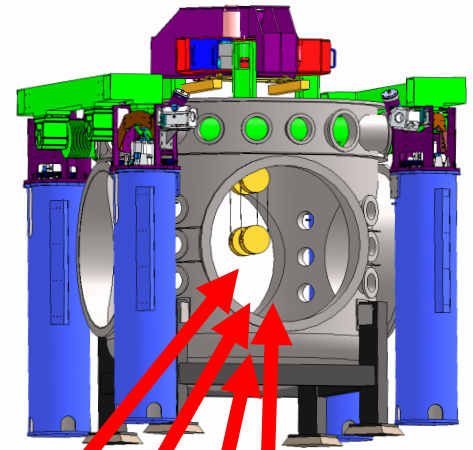

Body waves

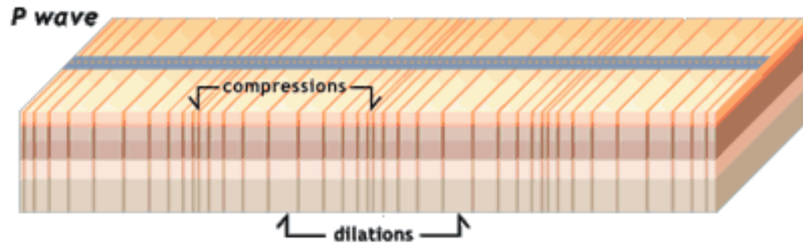

Rayleigh waves

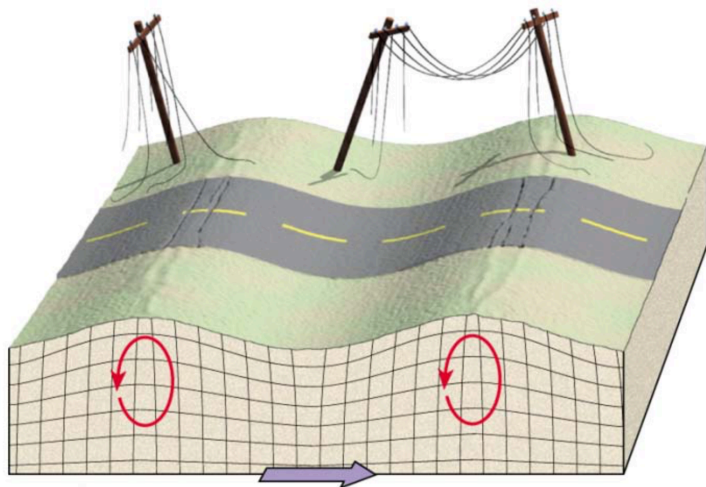

LIGO-G1602326-v2

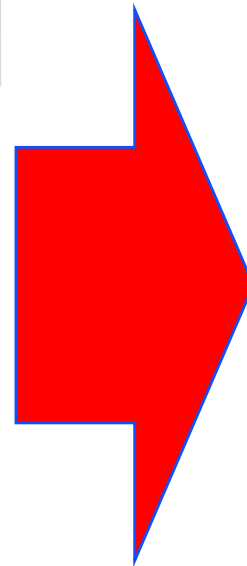

Density perturbation

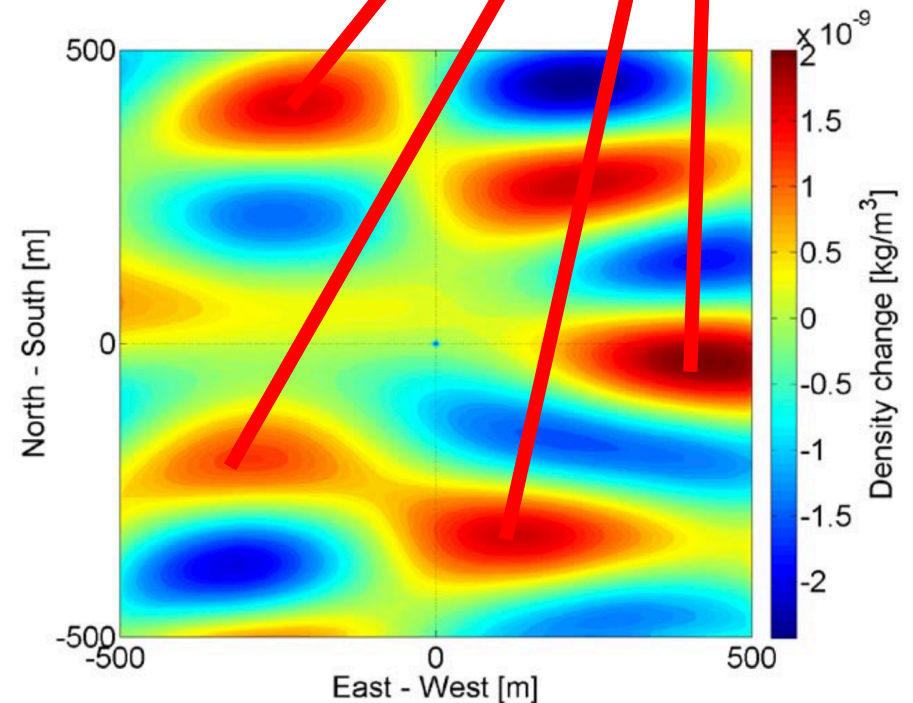

Density perturbations cause gravity perturbations.

Images: J. Harms

Measuring $\Delta L = 4 \times 10^{-18}$ m

Forces on test mass

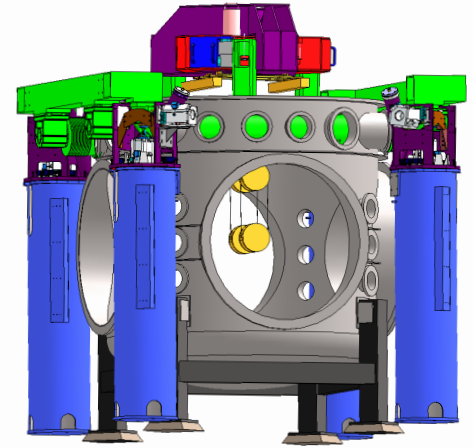

- Advanced LIGO (and Virgo) expect to be limited by this noise source –
 - » After all technical noise sources beaten down
 - » At low optical power (no radiation pressure noise)
 - » In the 10-30 Hz range
- We would *love* to be limited only by this noise source!

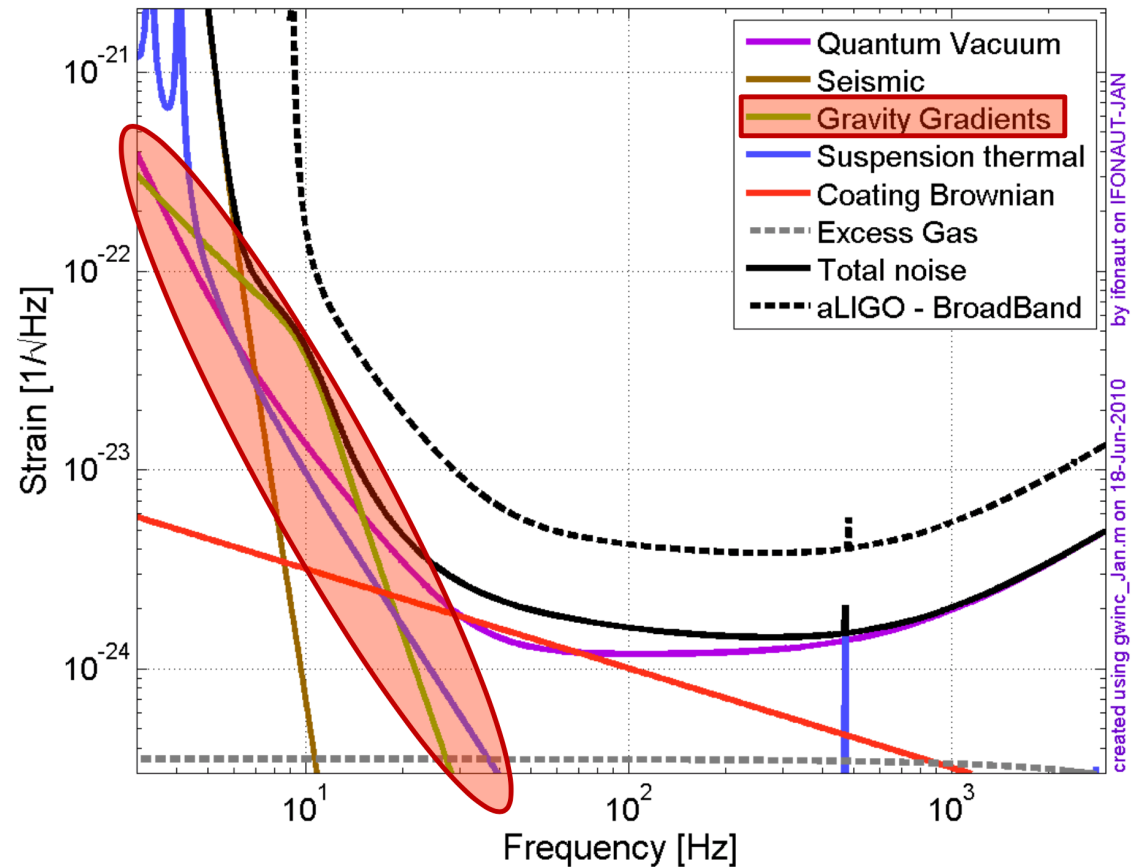

Then there are the technical noise sources....

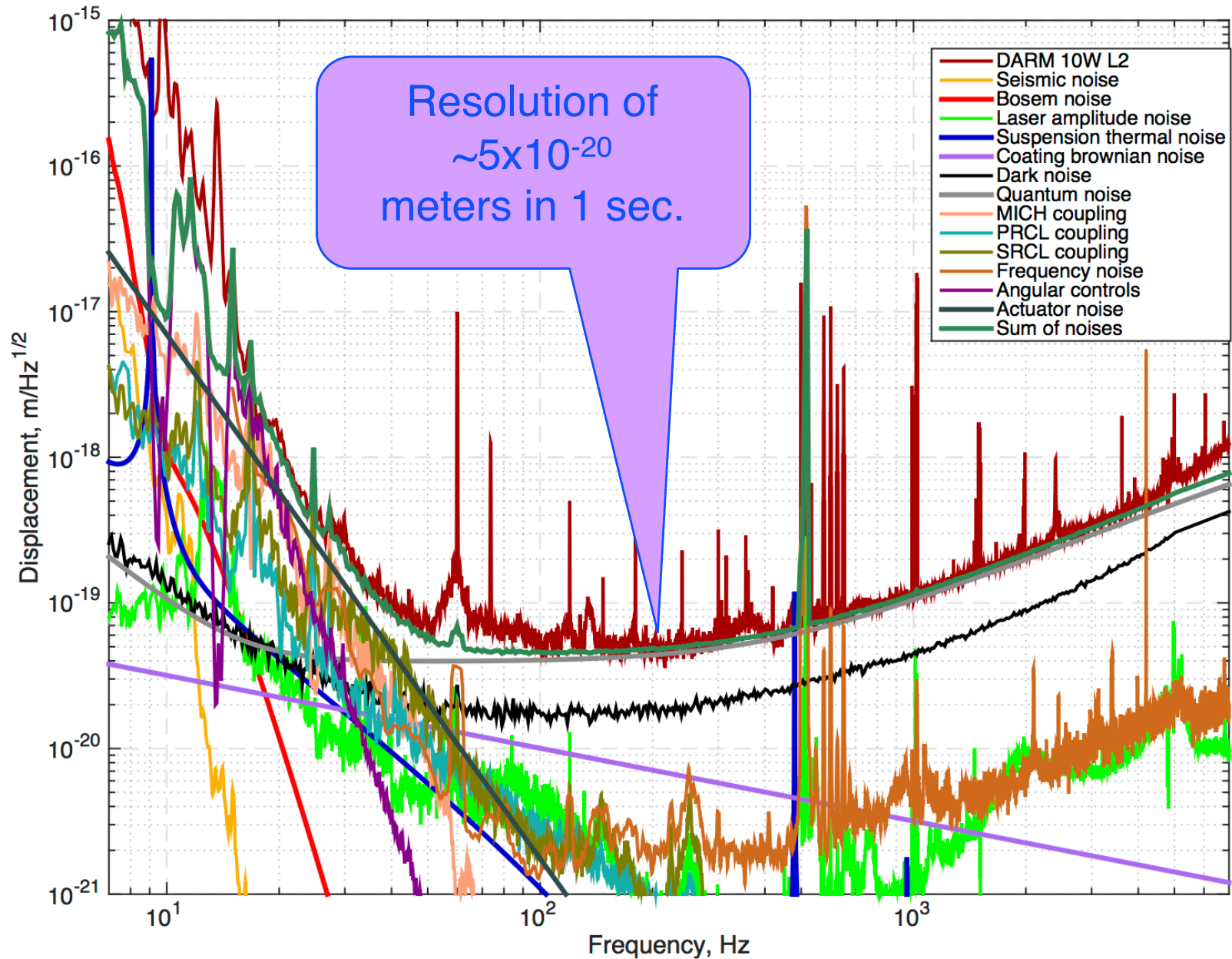



Sensitivity for first Observing run

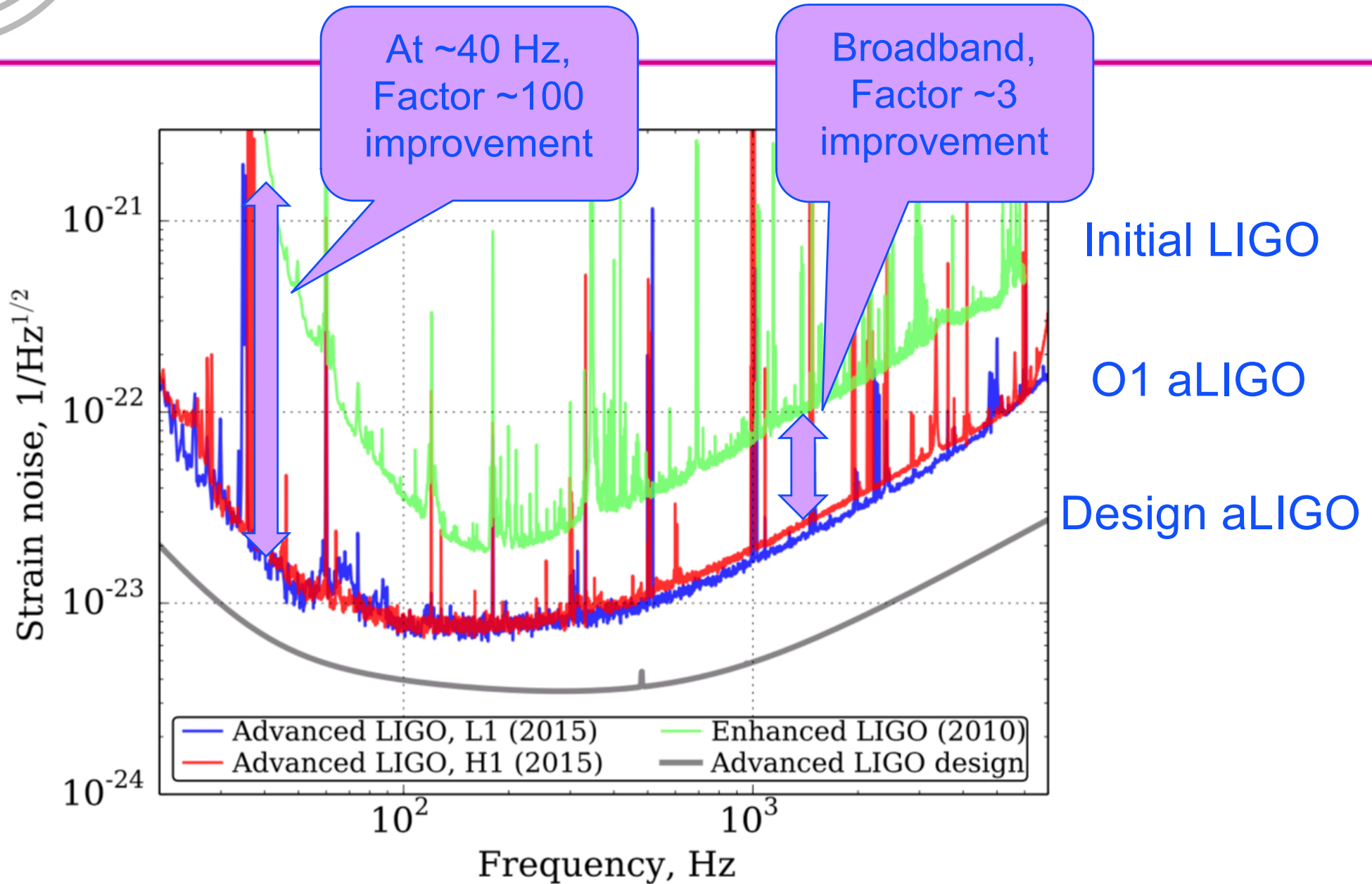

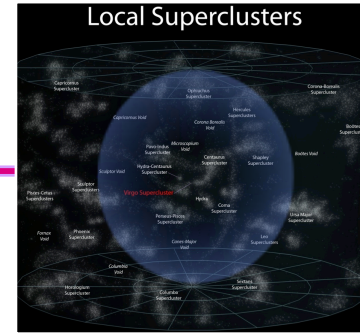
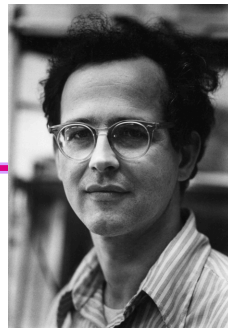
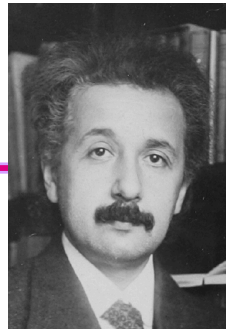
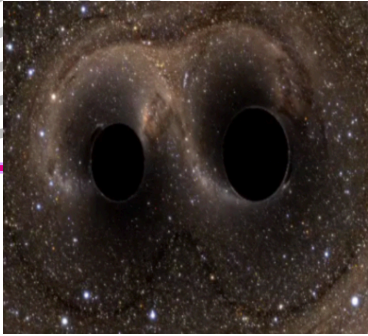

1.3 Billion years after the Black Holes merged..
(and multicellular life started on earth...)

100 years after Einstein predicted gravitational waves...

50 years after Rai Weiss invented the detectors...

20 years after the NSF, MIT, and Caltech Founded LIGO...

10 years after Advanced LIGO got the ok...

6 months after starting detector tuning...

Two days after we started observing...

The first signal

On September 14, 2015 at 09:50:45 UTC the two detectors of the Laser Interferometer Gravitational-Wave Observatory observed a transient gravitational-wave signal

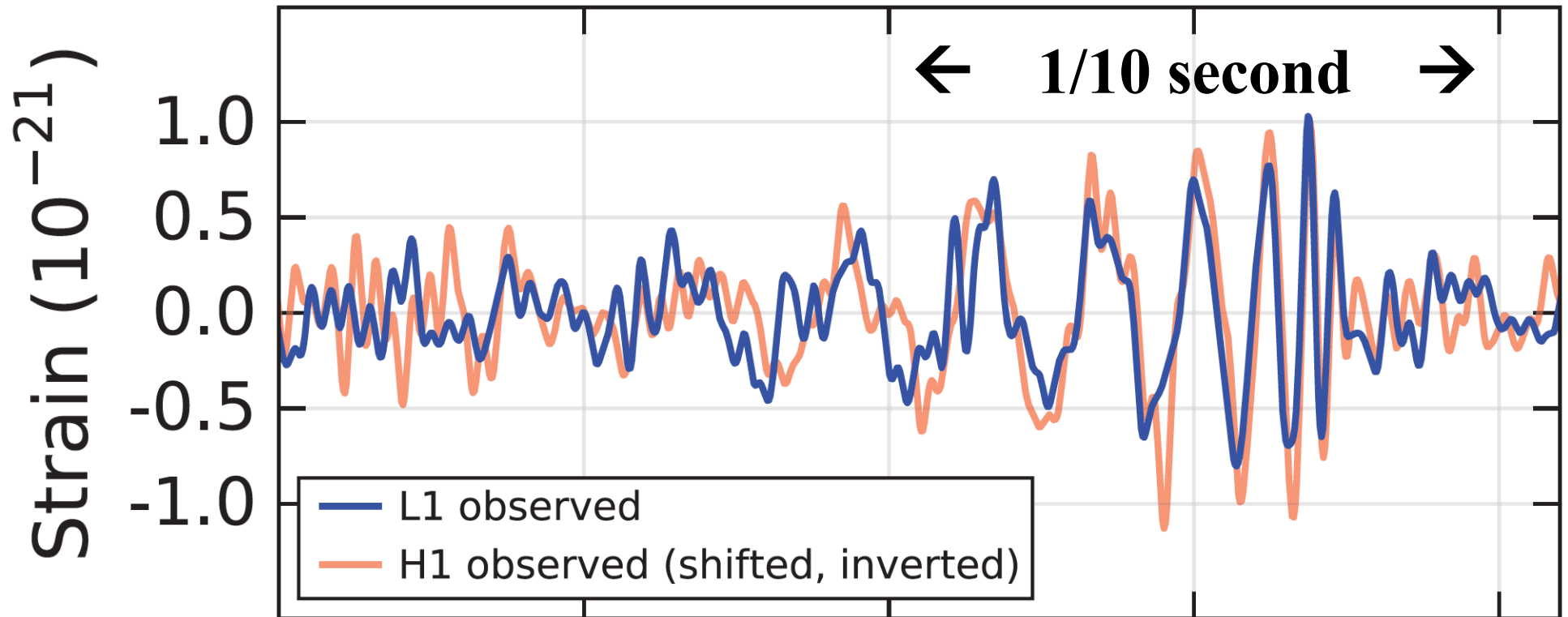

We measure $h(t)$ – think ‘strip chart recorder’

- The output of the detector is the (signed) strain as a function of time
- Earlier measurements of the pulsar period decay (Taylor/Hulse/Weisberg) measured energy loss from the binary system – a beautiful experiment
 - » radiation of gravitational waves confirmed to *remarkable* precision for 0th post-Newtonian
- **LIGO can actually measure the change in distance between our own test masses, due to a passing space-time ripple**
 - » Instantaneous amplitude rather than time-averaged power
 - » Much richer information!

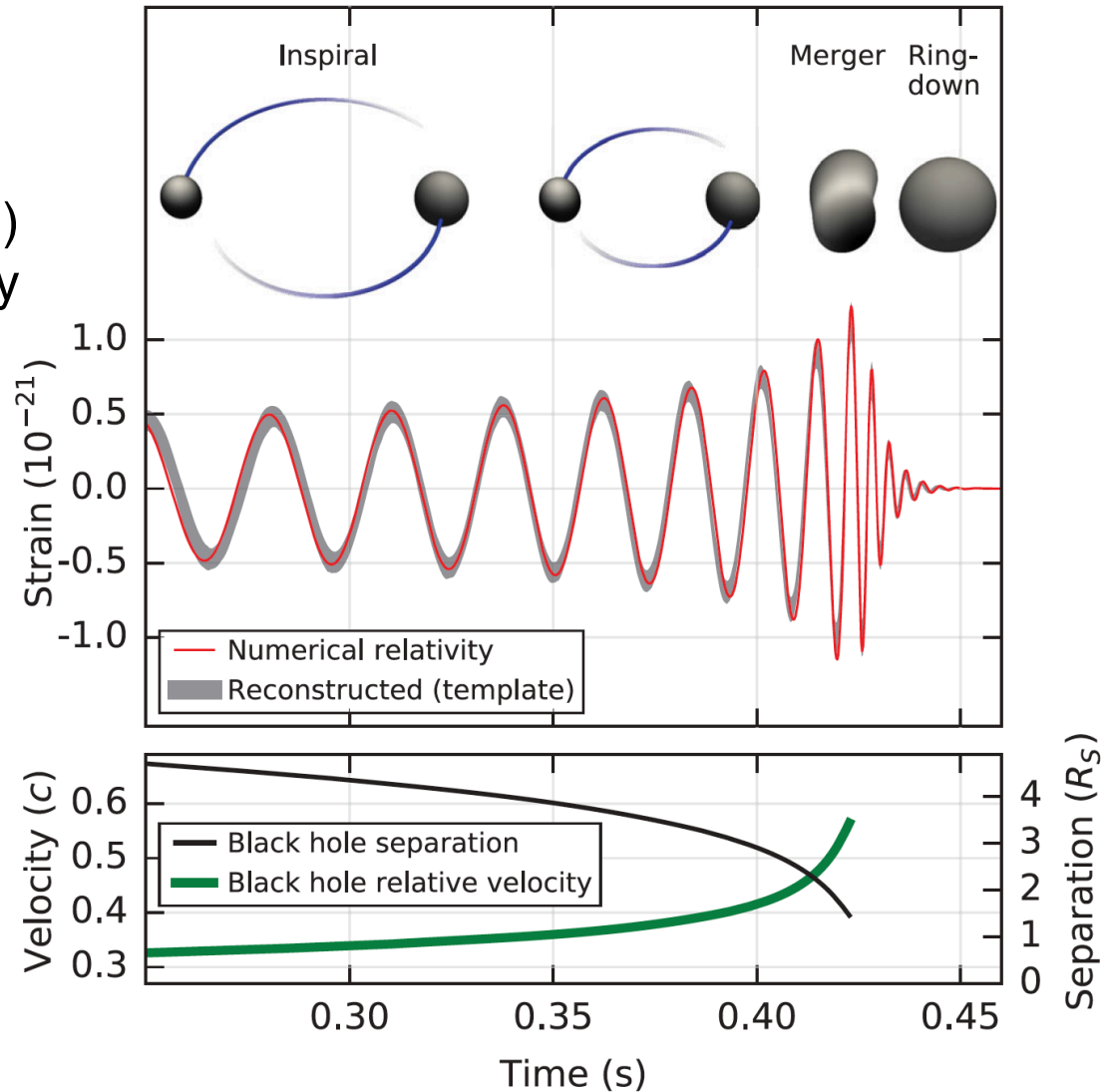

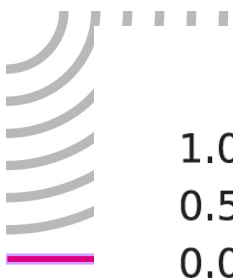

Hanford, Washington (H1)

Livingston, Louisiana (L1)

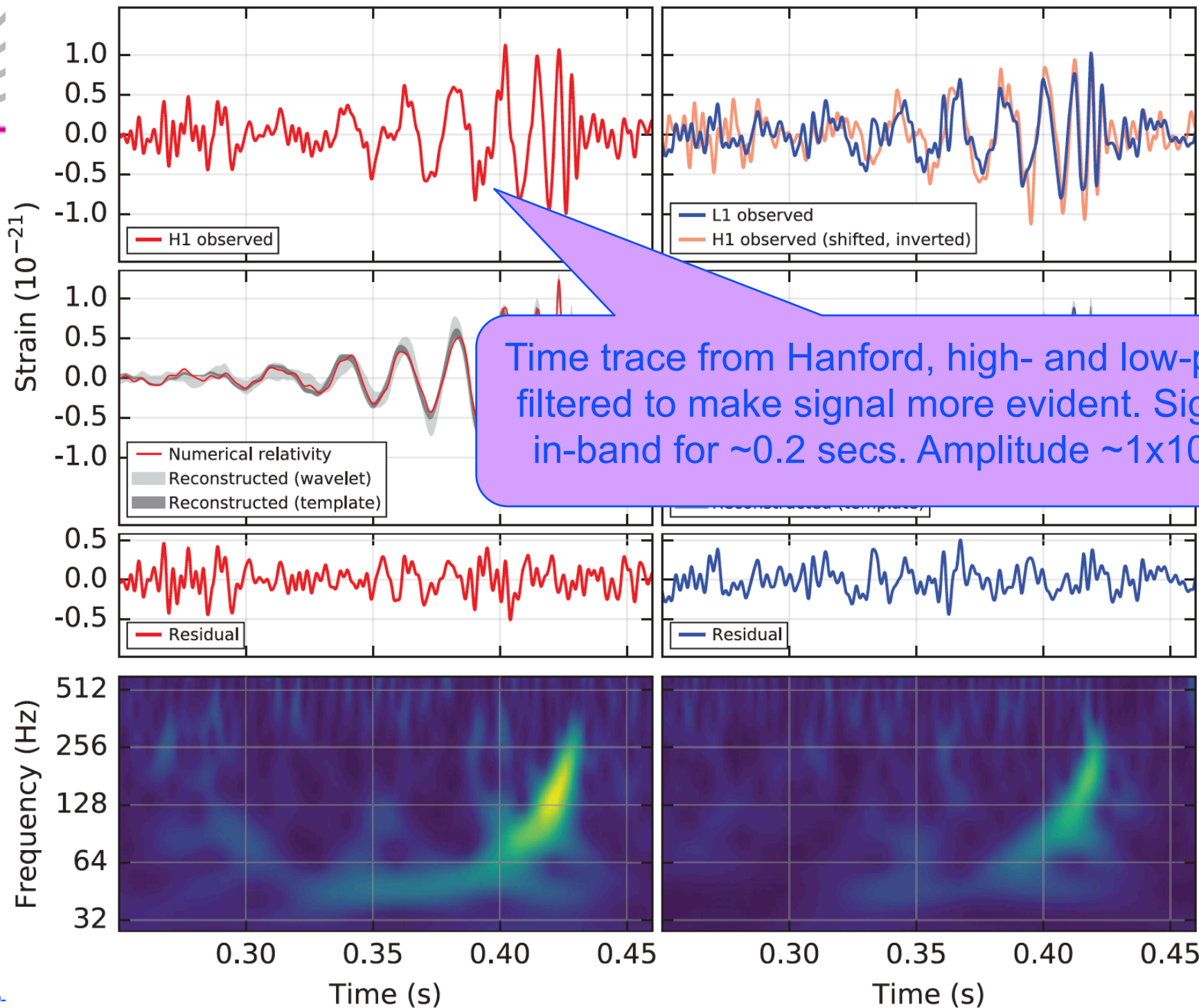

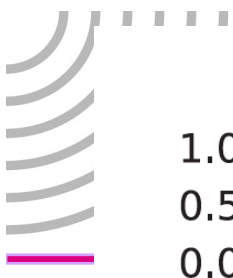

Hanford, Washington (H1)

Livingston, Louisiana (L1)

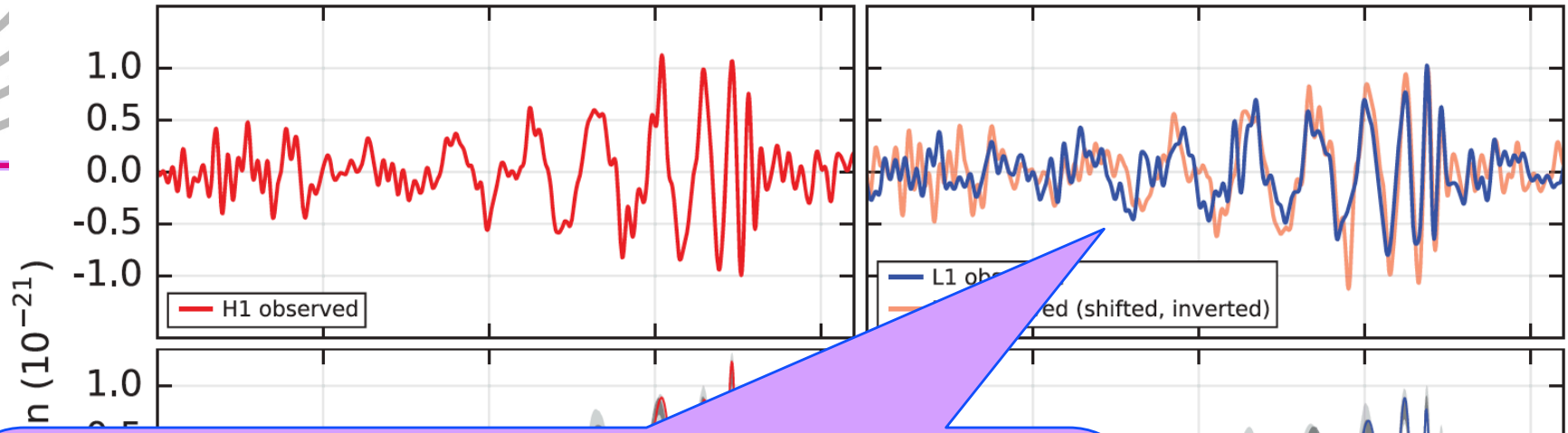

Time trace from Hanford and Livingston; Hanford inverted (observatory orientation is 180), and shifted by 7.1 msec (the observatories are separated by 10 msec time of flight). Source is in an annulus in the Southern hemisphere.

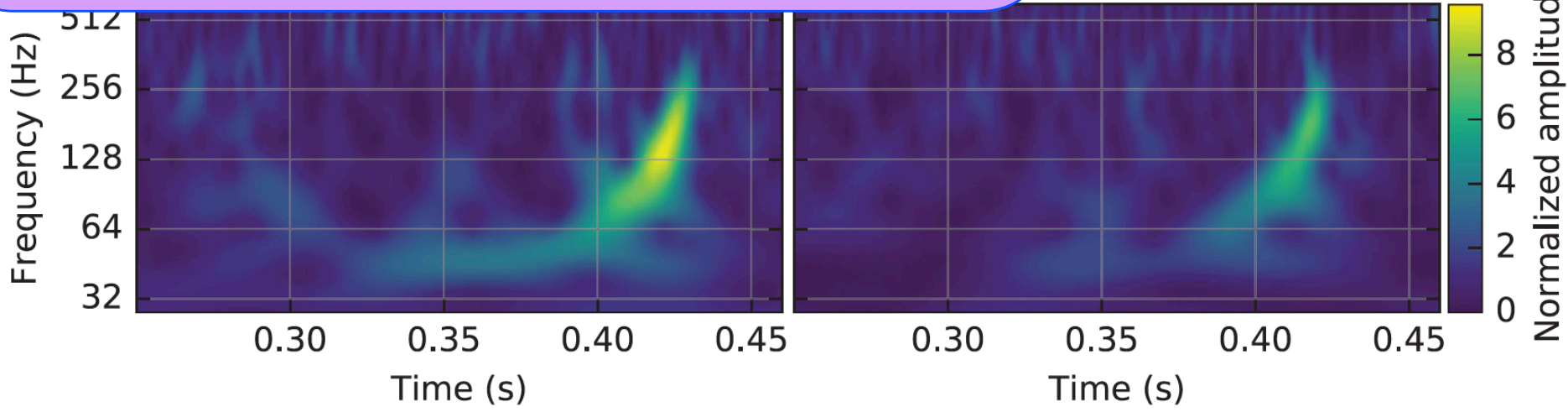
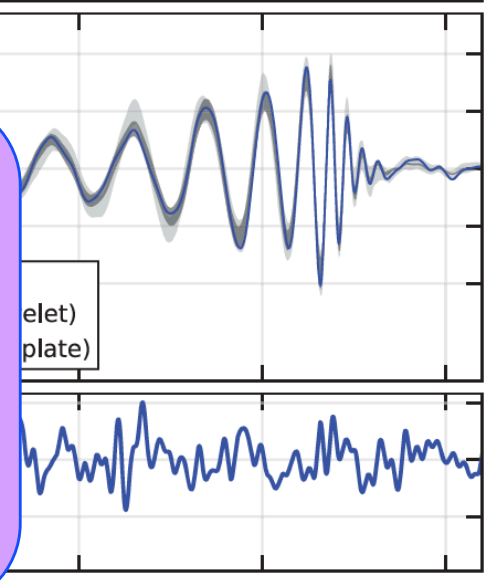

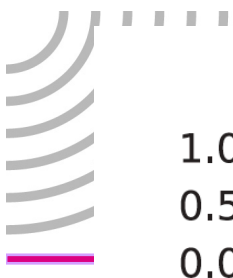

Hanford, Washington (H1)

Livingston, Louisiana (L1)

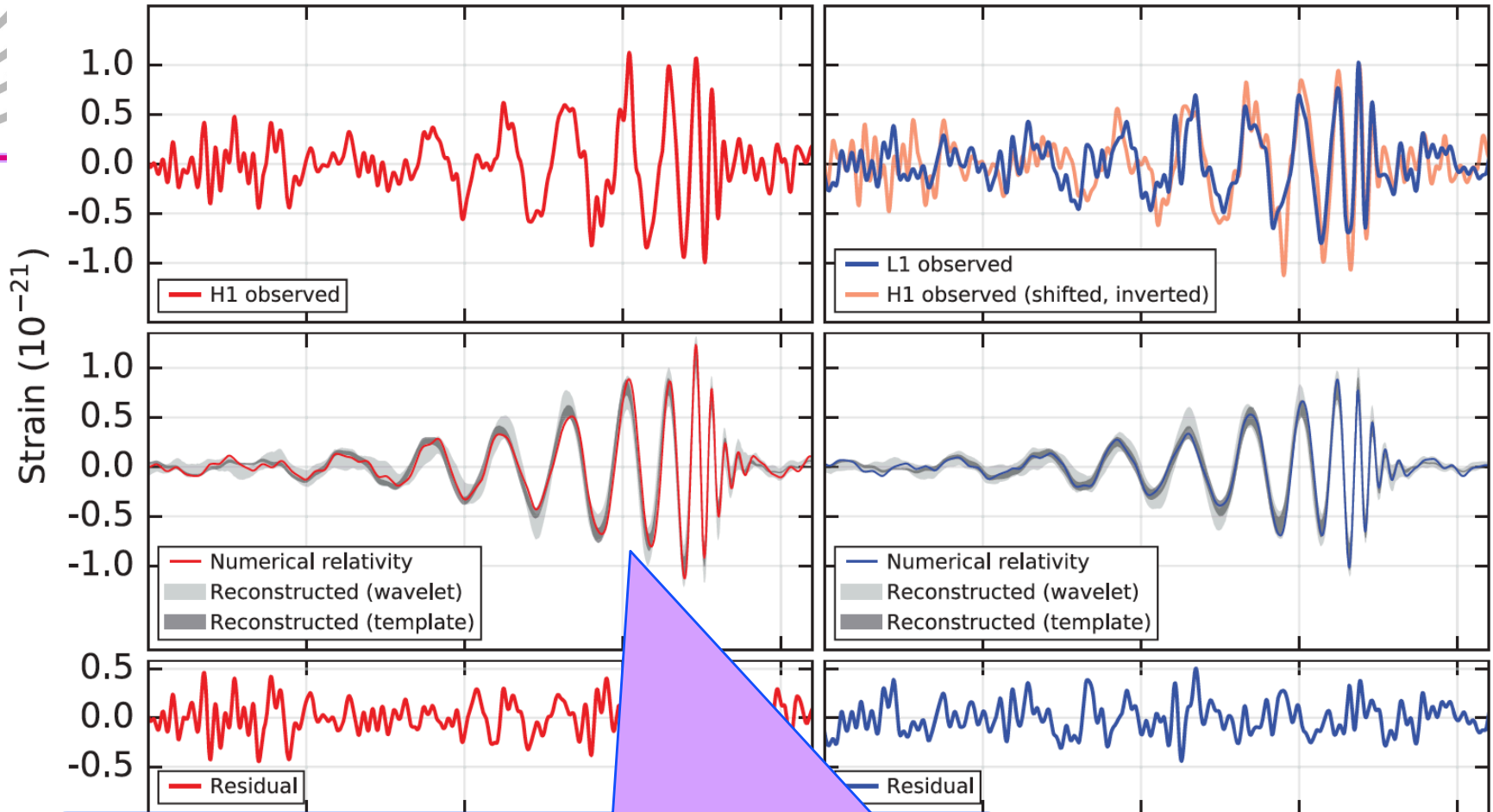

Best fit waveform, assuming Einstein's GR, using numerical relativity calculations, and putting in the same high/low pass filtering (so no long sinusoidal precursor). Same fit matches both observatories.

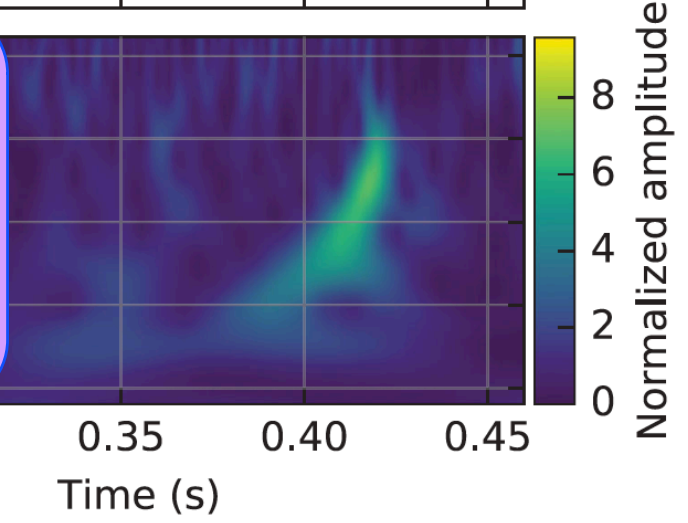

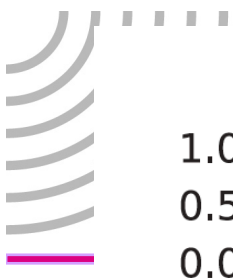

Hanford, Washington (H1)

Livingston, Louisiana (L1)

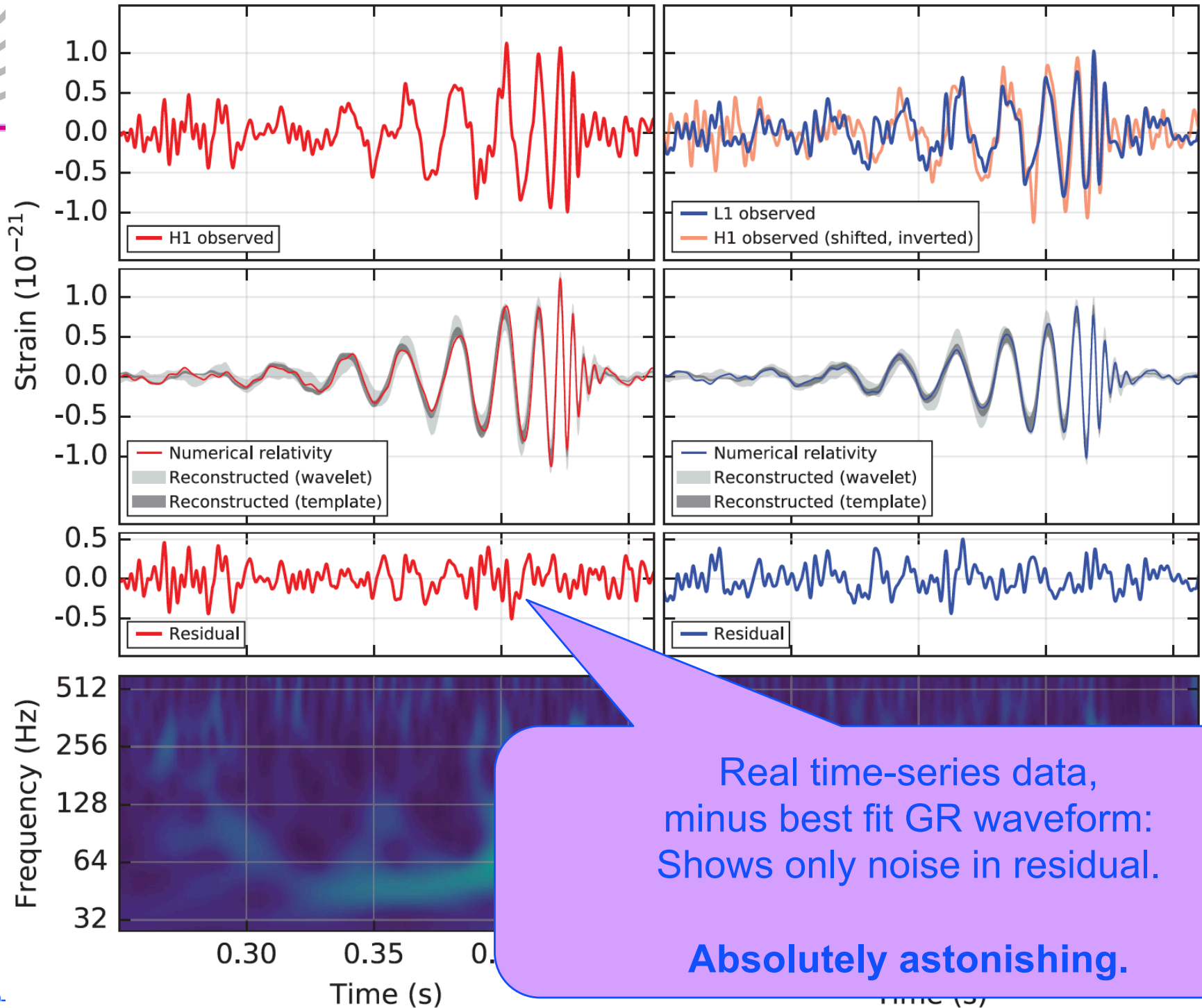

Real time-series data, minus best fit GR waveform: Shows only noise in residual.

Absolutely astonishing.

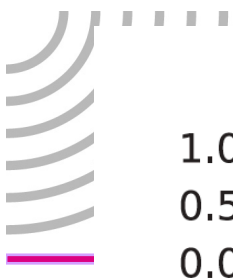

Hanford, Washington (H1)

Livingston, Louisiana (L1)

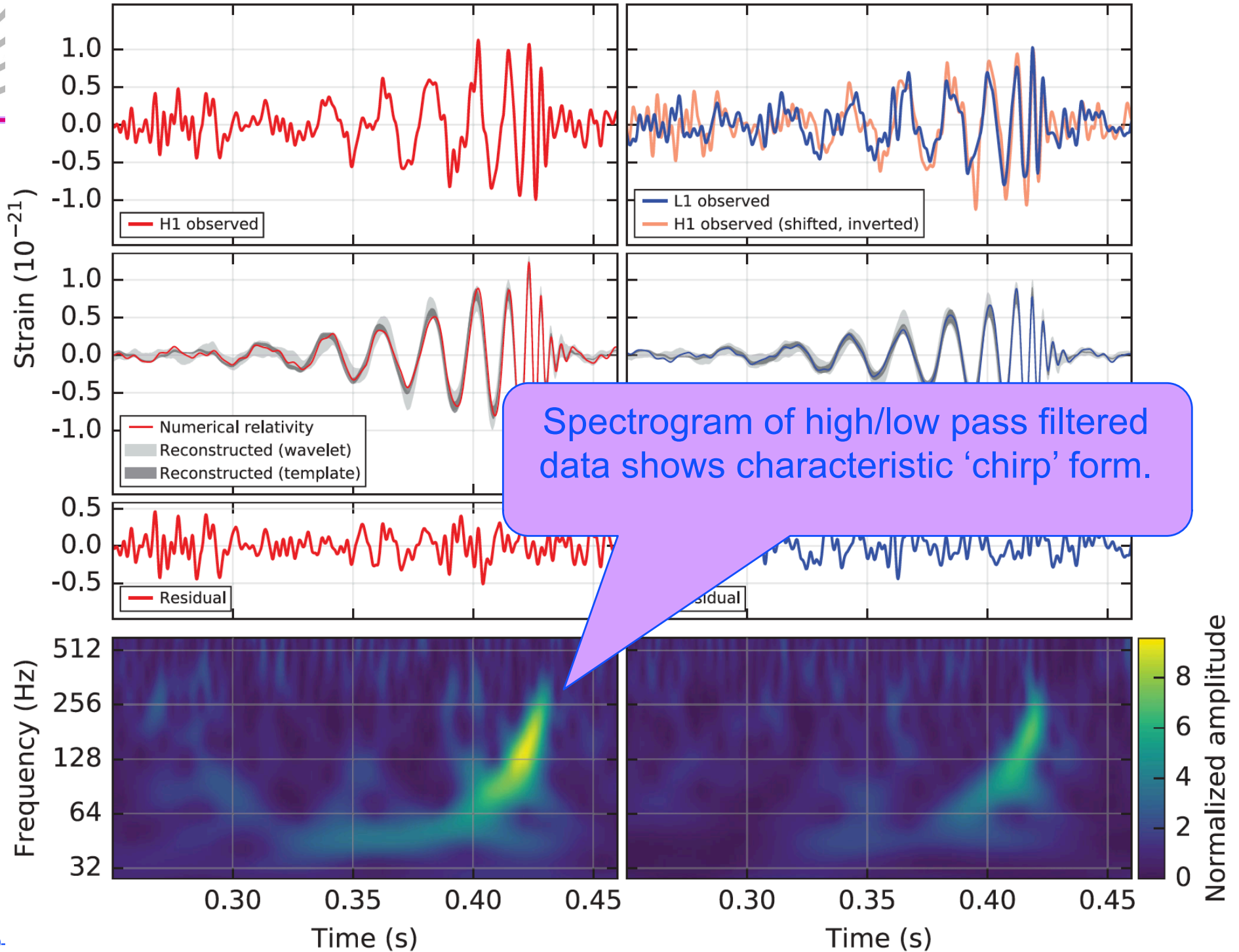

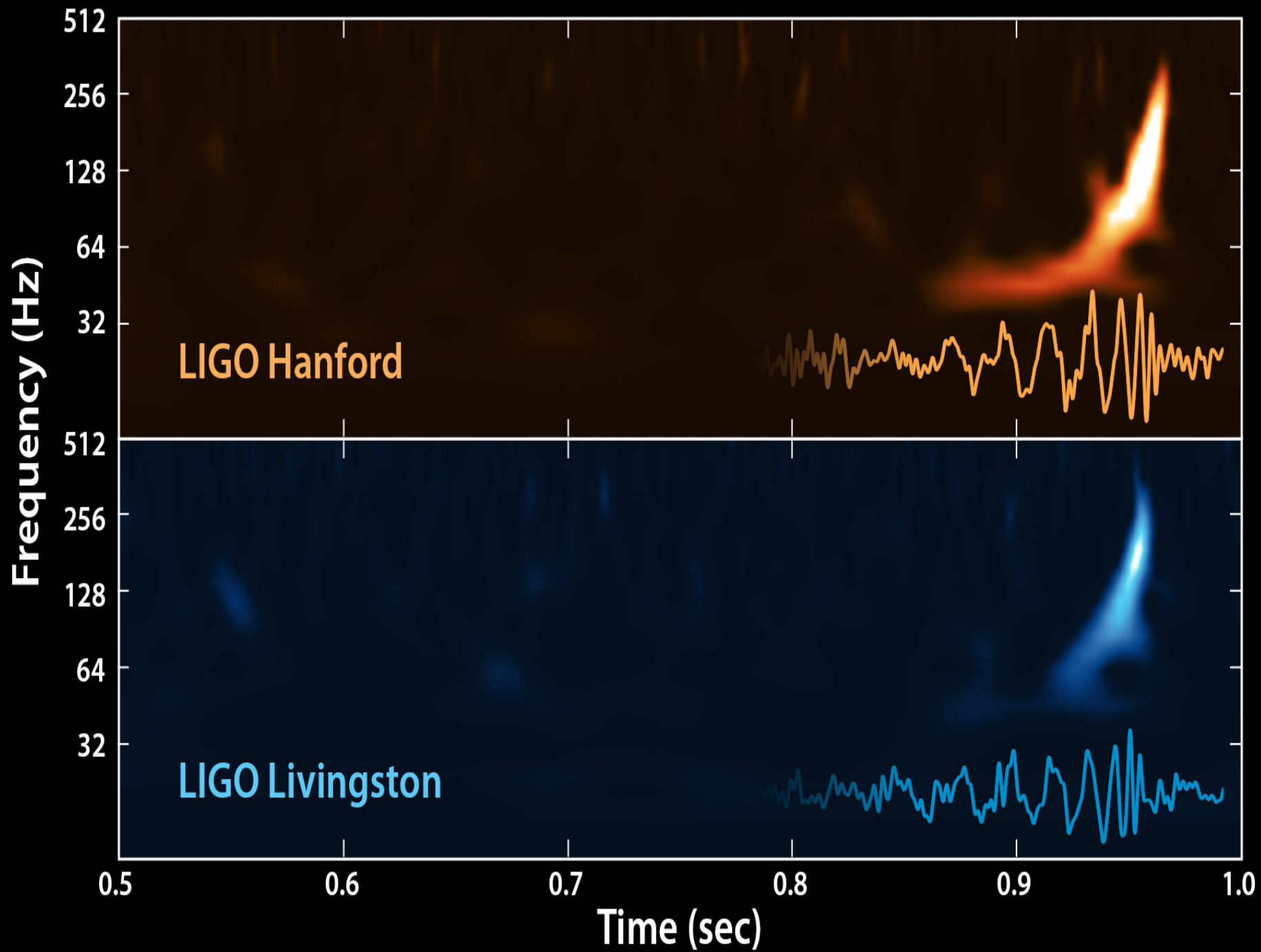

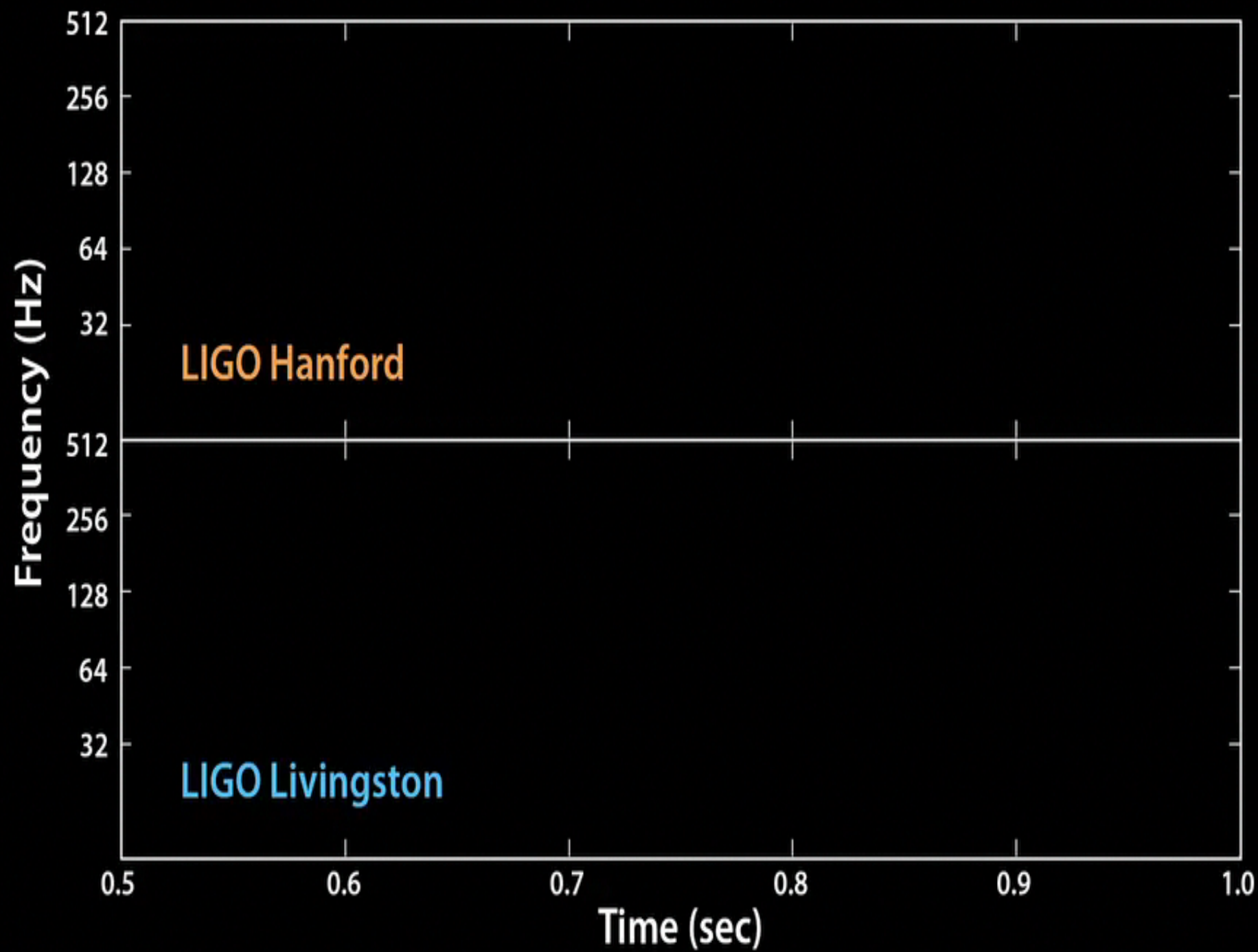

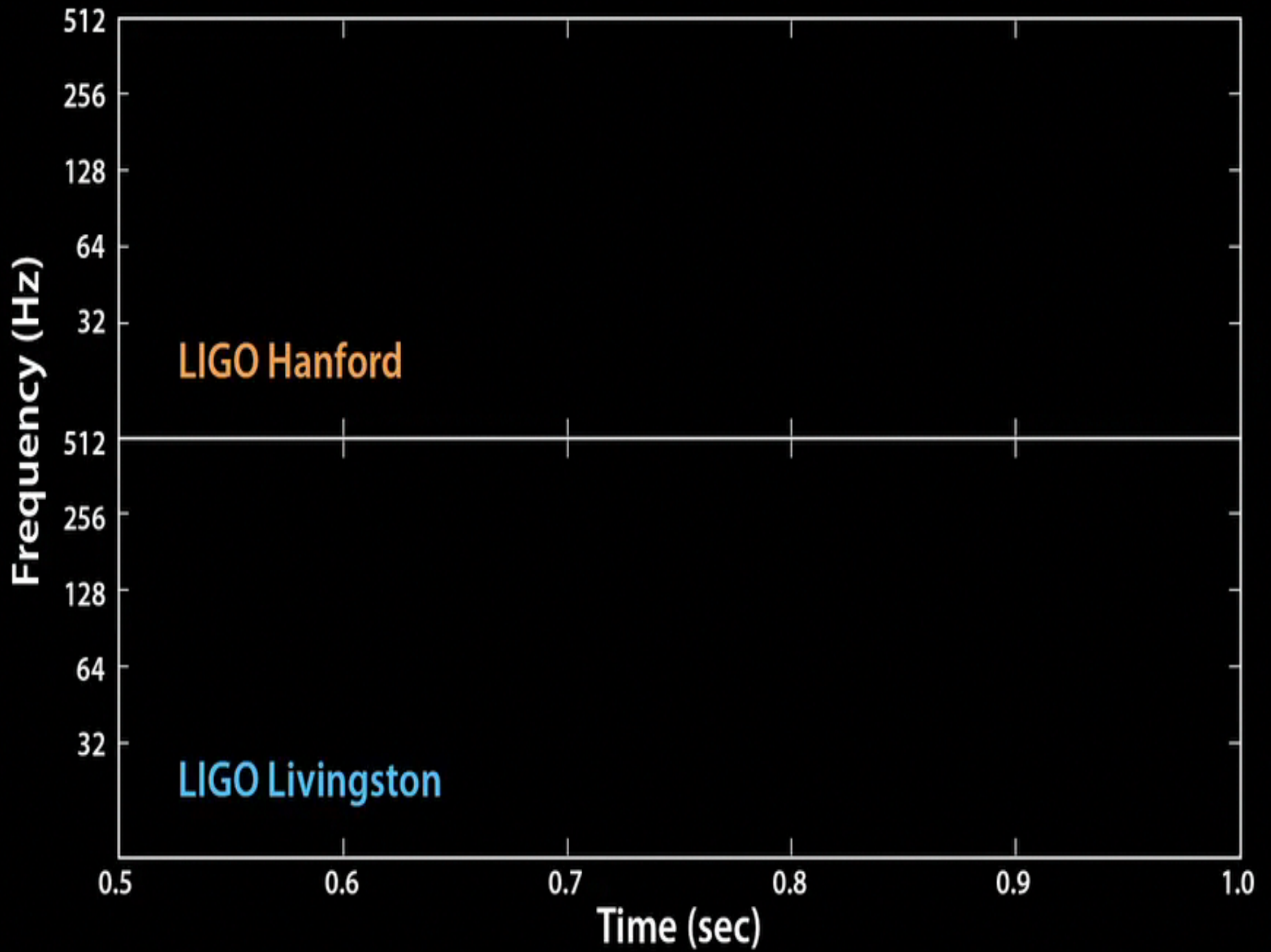

One event...was it real?



Our second signal, 26 December 2015 –
the SNR we *thought* we would be working with

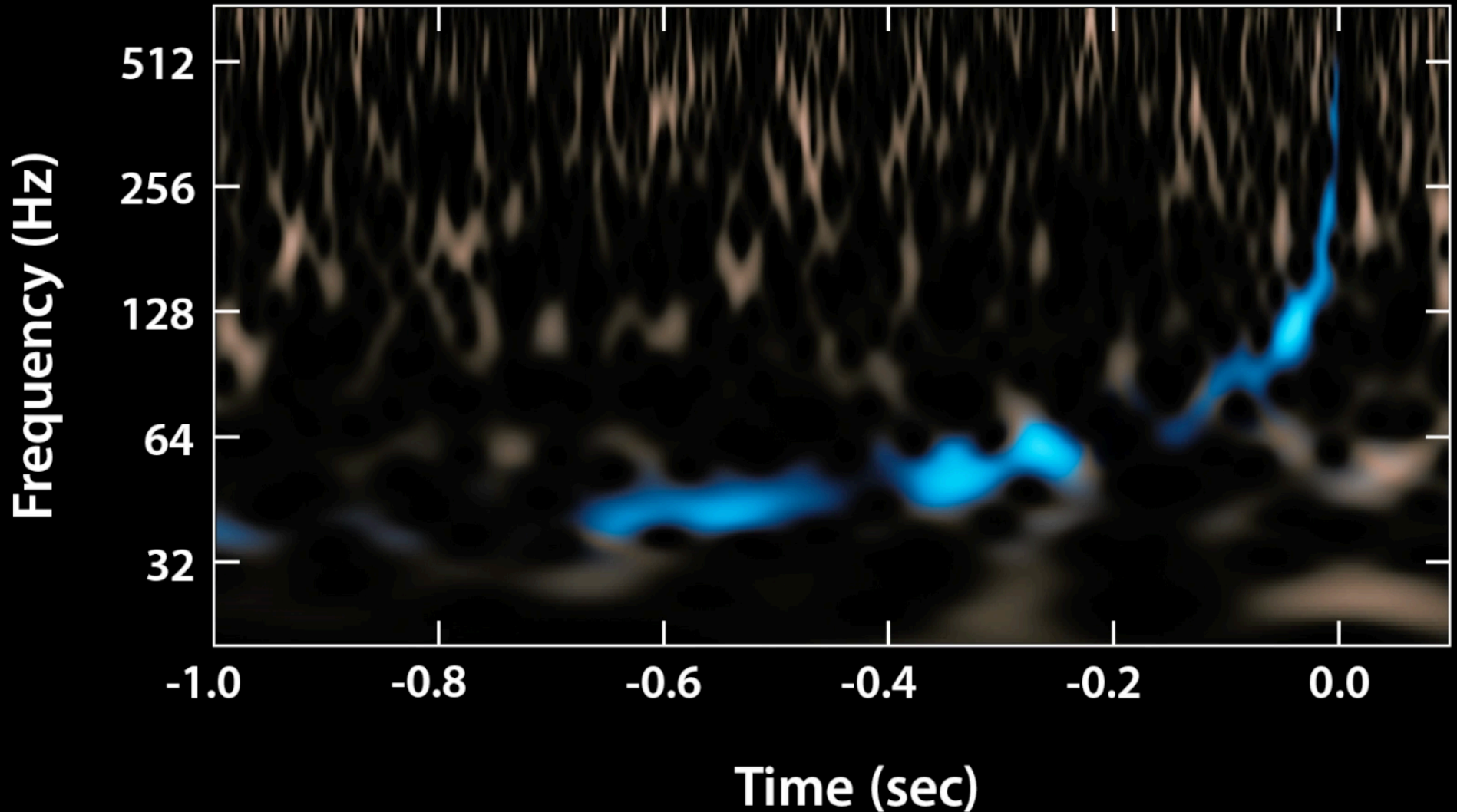

Our 2+1 signals to date

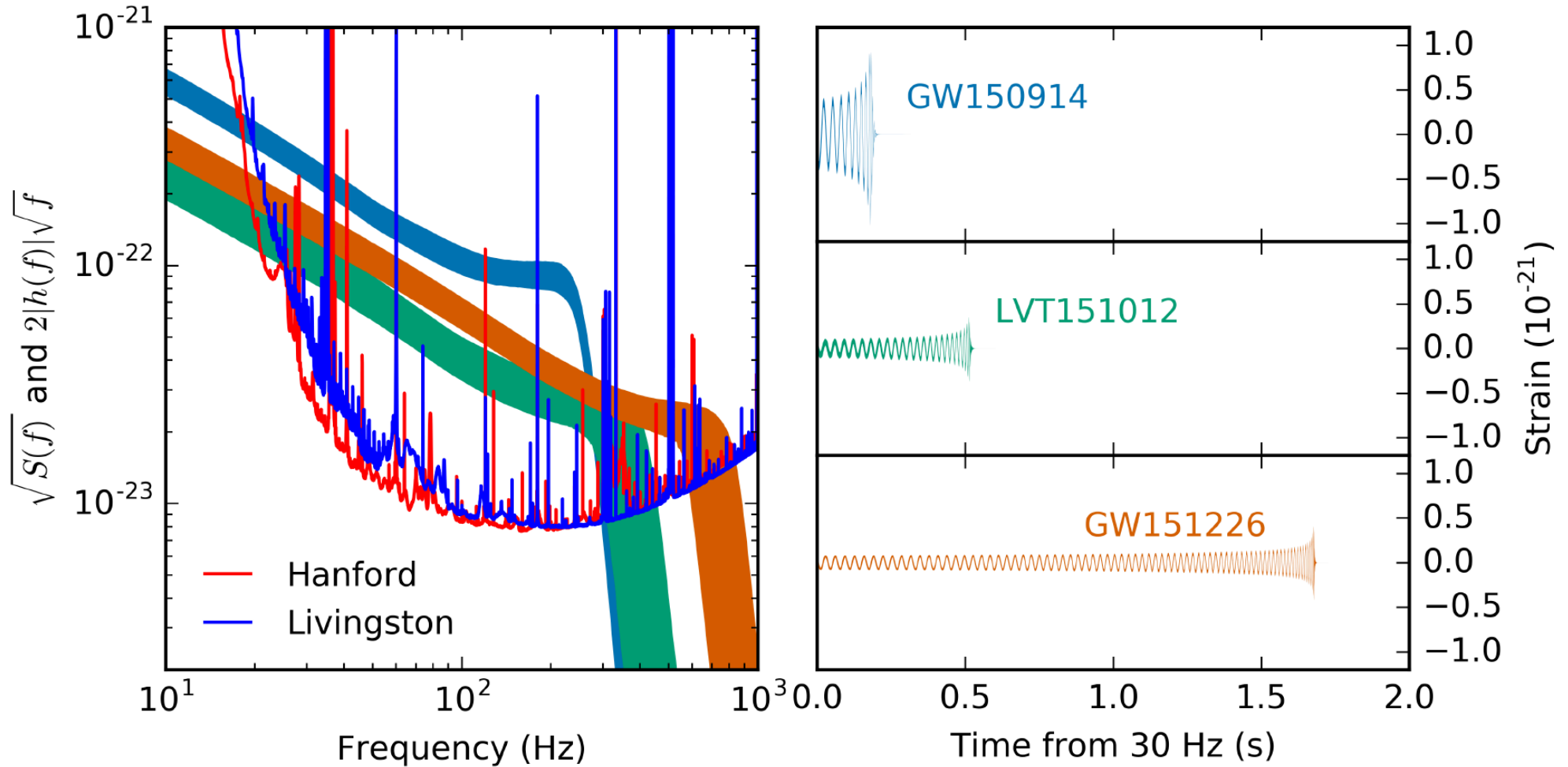

Black holes seen to date

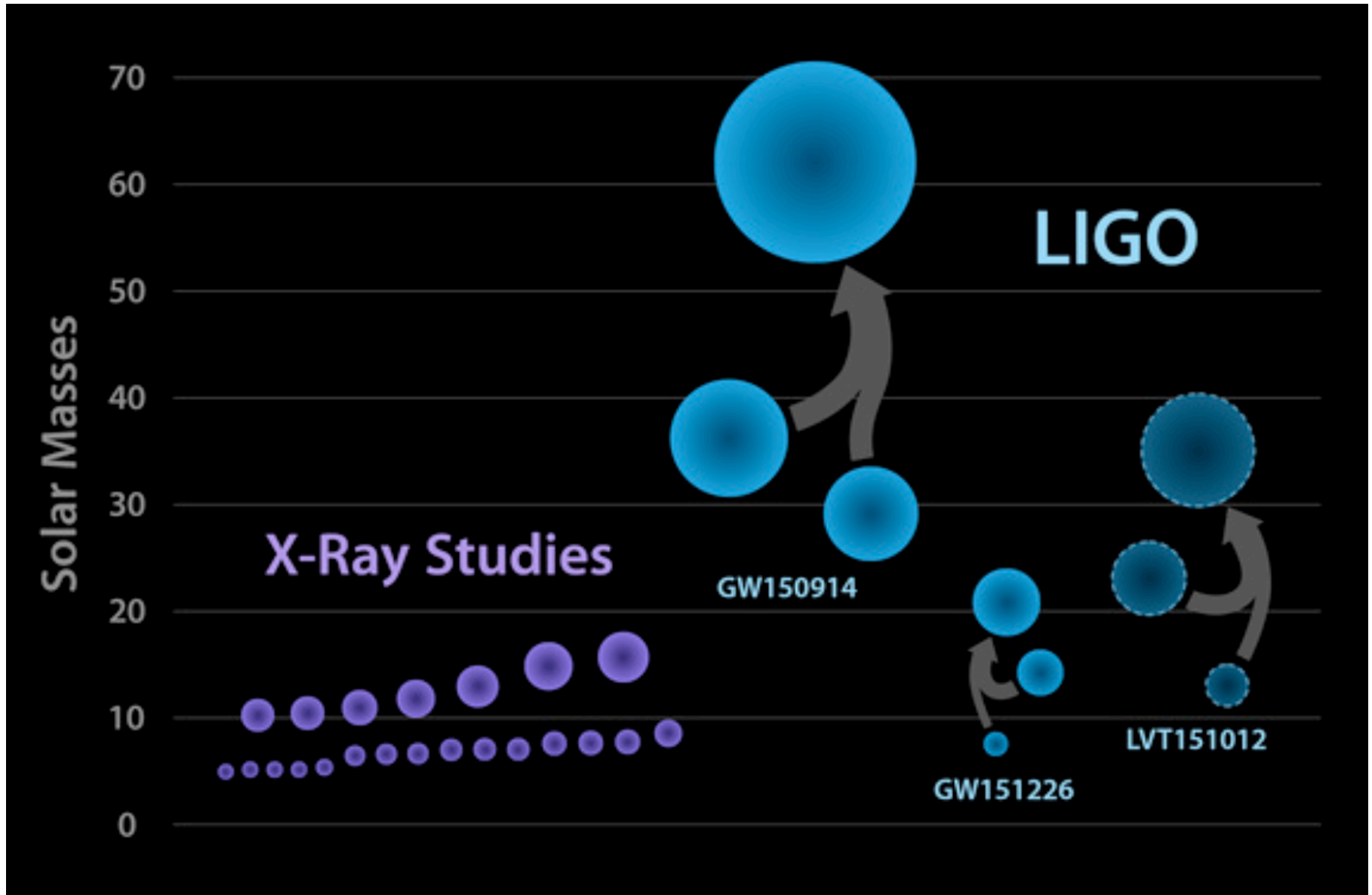

Gravitational-wave astrophysics

Event	GW150914	GW151226	LVT151012
Signal-to-noise ratio ρ	23.7	13.0	9.7
False alarm rate FAR/yr ⁻¹	$< 6.0 \times 10^{-7}$	$< 6.0 \times 10^{-7}$	0.37
p-value	7.5×10^{-8}	7.5×10^{-8}	0.045
Significance	$> 5.3\sigma$	$> 5.3\sigma$	1.7σ
Primary mass $m_1^{\text{source}}/M_\odot$	$36.2_{-3.8}^{+5.2}$	$14.2_{-3.7}^{+8.3}$	23_{-6}^{+18}
Secondary mass $m_2^{\text{source}}/M_\odot$	$29.1_{-4.4}^{+3.7}$	$7.5_{-2.3}^{+2.3}$	13_{-5}^{+4}
Chirp mass $\mathcal{M}^{\text{source}}/M_\odot$	$28.1_{-1.5}^{+1.8}$	$8.9_{-0.3}^{+0.3}$	$15.1_{-1.1}^{+1.4}$
Total mass $M^{\text{source}}/M_\odot$	$65.3_{-3.4}^{+4.1}$	$21.8_{-1.7}^{+5.9}$	37_{-4}^{+13}
Effective inspiral spin χ_{eff}	$-0.06_{-0.14}^{+0.14}$	$0.21_{-0.10}^{+0.20}$	$0.0_{-0.2}^{+0.3}$
Final mass $M_f^{\text{source}}/M_\odot$	$62.3_{-3.1}^{+3.7}$	$20.8_{-1.7}^{+6.1}$	35_{-4}^{+14}
Final spin a_f	$0.68_{-0.06}^{+0.05}$	$0.74_{-0.06}^{+0.06}$	$0.66_{-0.10}^{+0.09}$
Radiated energy $E_{\text{rad}}/(M_\odot c^2)$	$3.0_{-0.4}^{+0.5}$	$1.0_{-0.2}^{+0.1}$	$1.5_{-0.4}^{+0.3}$
Peak luminosity $\ell_{\text{peak}}/(\text{erg s}^{-1})$	$3.6_{-0.4}^{+0.5} \times 10^{56}$	$3.3_{-1.6}^{+0.8} \times 10^{56}$	$3.1_{-1.8}^{+0.8} \times 10^{56}$
Luminosity distance D_L/Mpc	420_{-180}^{+150}	440_{-190}^{+180}	1000_{-500}^{+500}
Source redshift z	$0.09_{-0.04}^{+0.03}$	$0.09_{-0.04}^{+0.03}$	$0.20_{-0.09}^{+0.09}$
Sky localization $\Delta\Omega/\text{deg}^2$	230	850	1600

Spins of component BH

- Would like to make inferences about origins based on spin
- For all but one component BH, no statistical deviation from zero spin (face-on, so not a good measure)
- For one component of GW151226, spin of 0.2 – so probably not the result of a merger (→ primordial BH?)

- Plot of probability distribution of spin, BH#1 left, BH#2 right

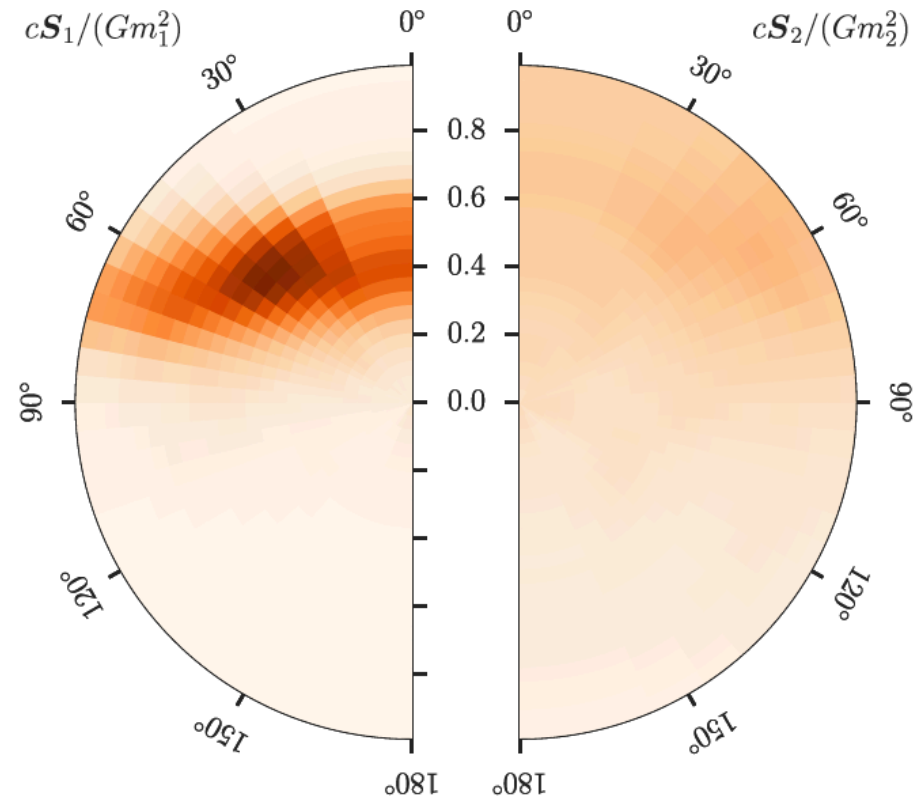

LIGO

The advanced GW detector network

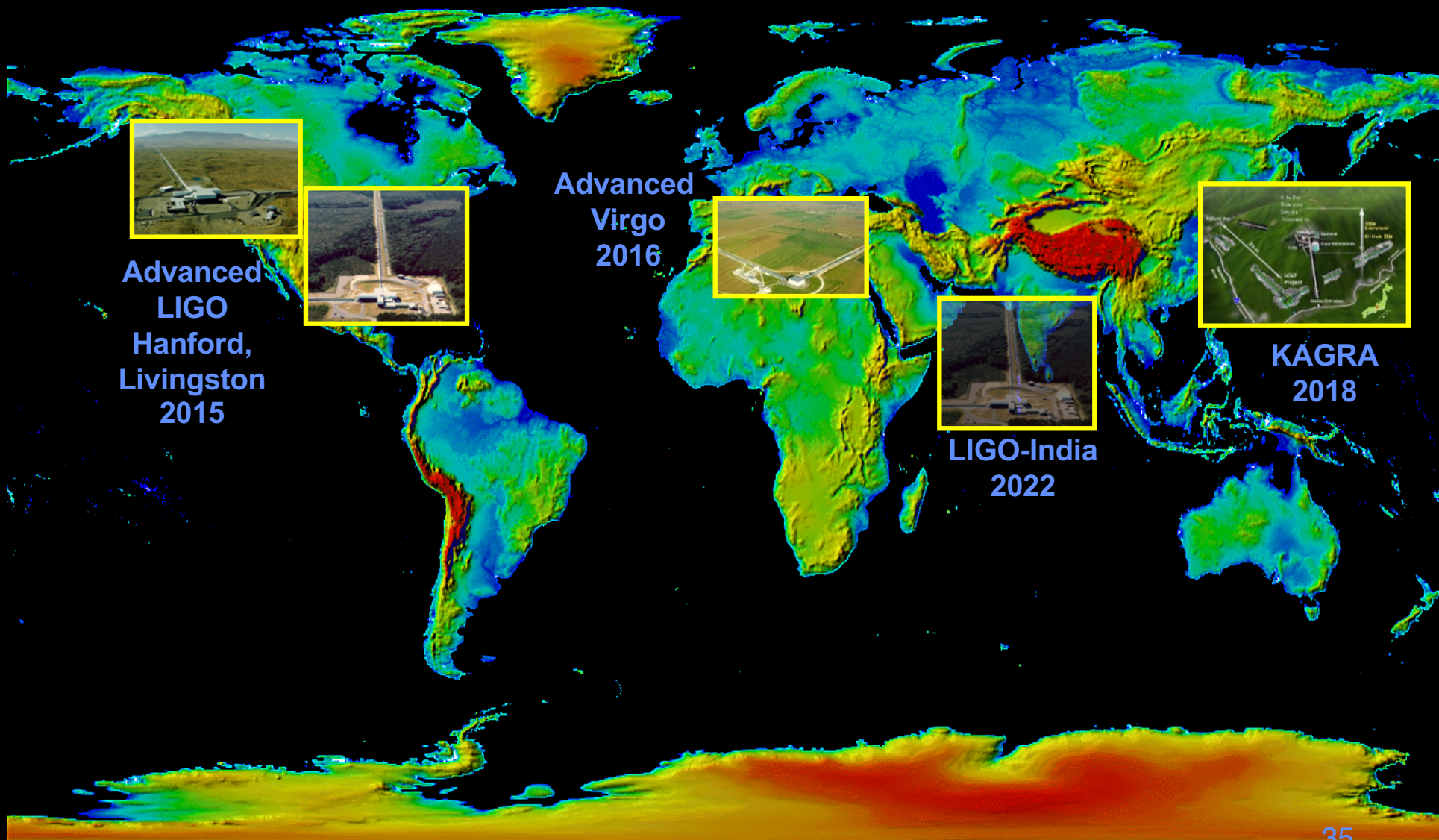

What does the future hold?



LIGO First Detection Sensitivity/configuration:

2 detectors, 1/3 goal sensitivity
~3 signals in 4 months of observation

GW150914
GW151226
LVT151012

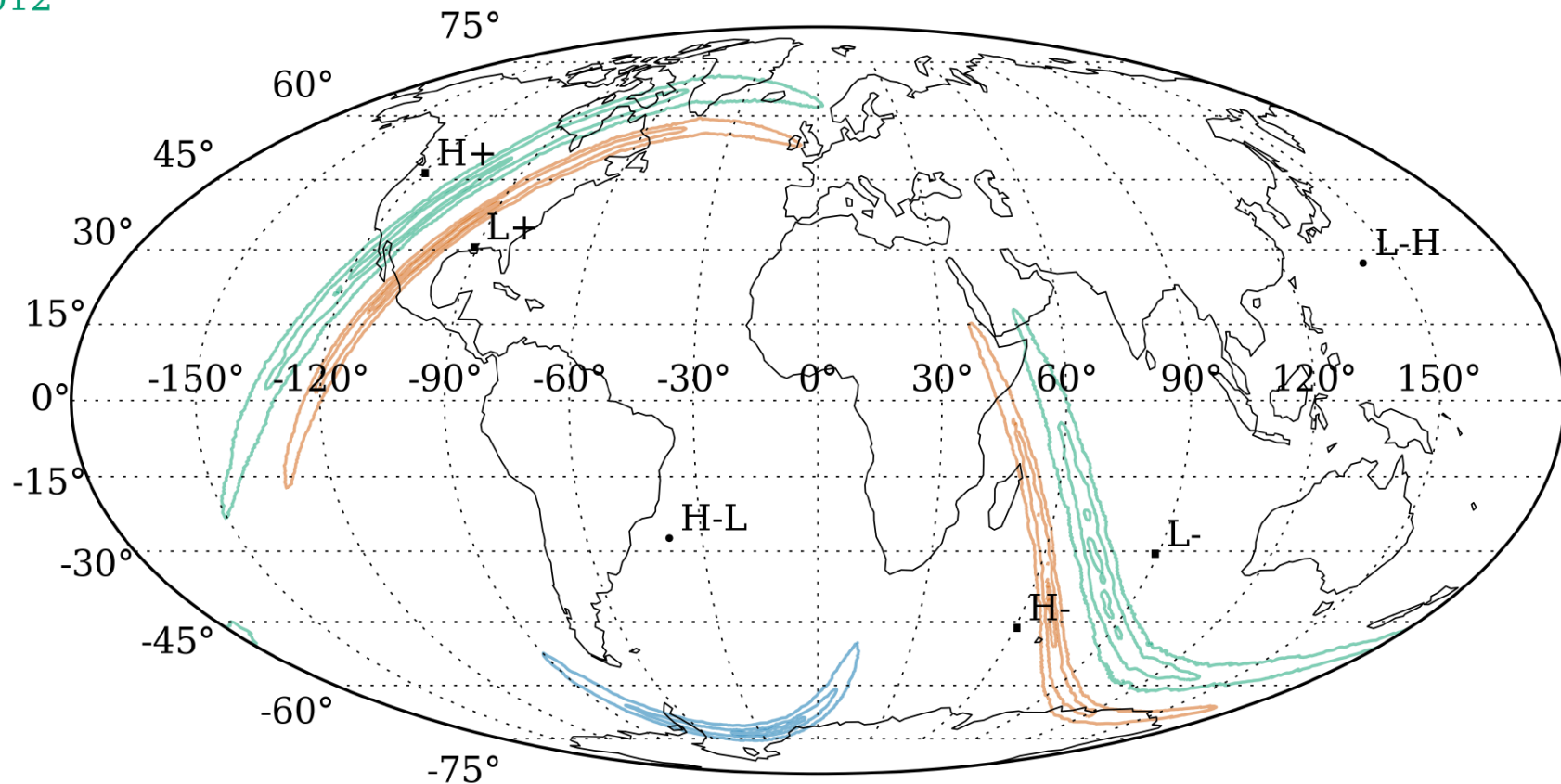



2017 Sensitivity/configuration:

3 detectors (add Virgo),
~1-2 signals per month of observation

<10% in 20 sq deg

HLV 2016-2017

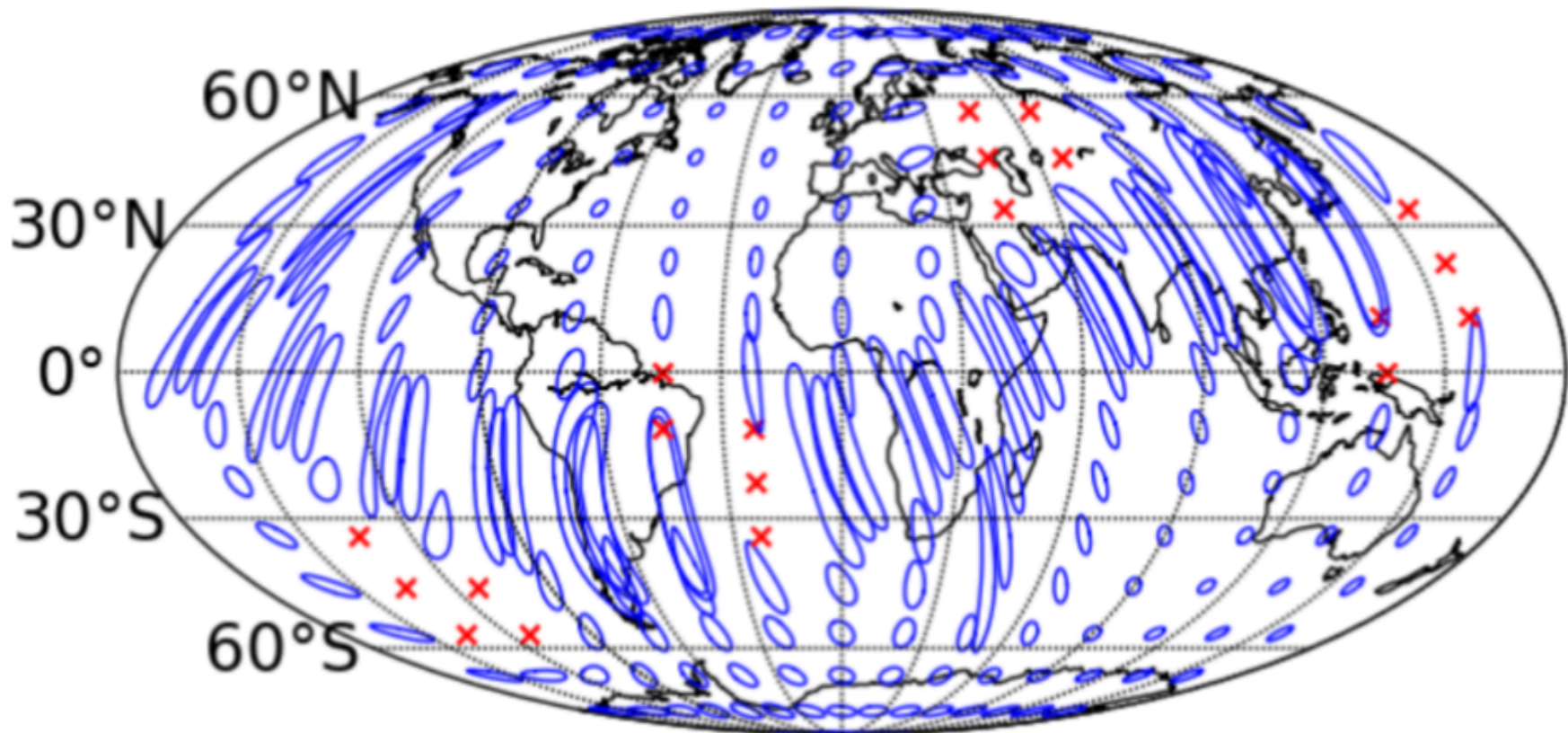



2018-19 Sensitivity/configuration:

3 detectors, **full goal sensitivity**

~1 signal per day

~20% in 20 sq deg

HLV 2019

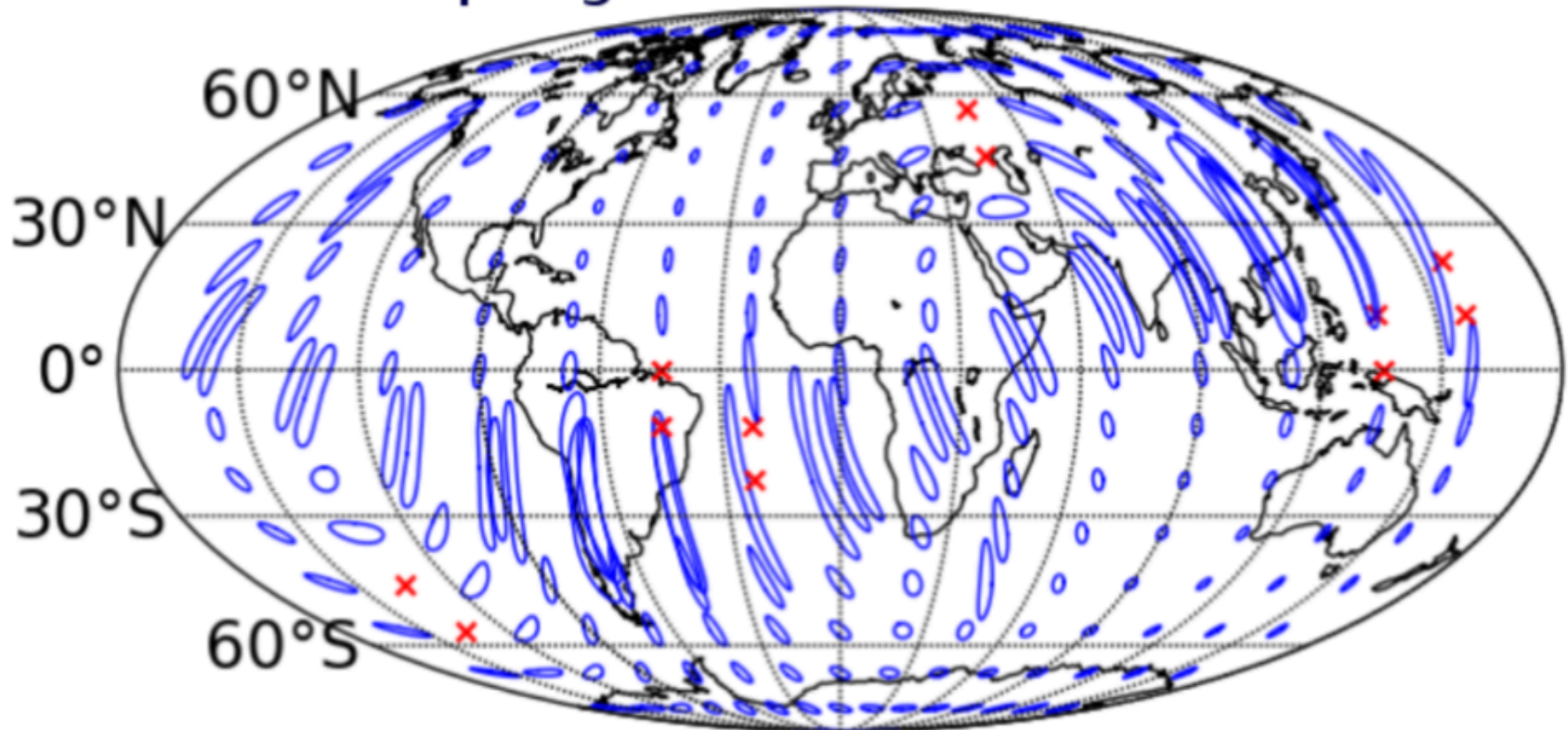

5 detectors (add India and Japan)
far improved source localization

~60% in 10 sq deg

HIKLV

2022

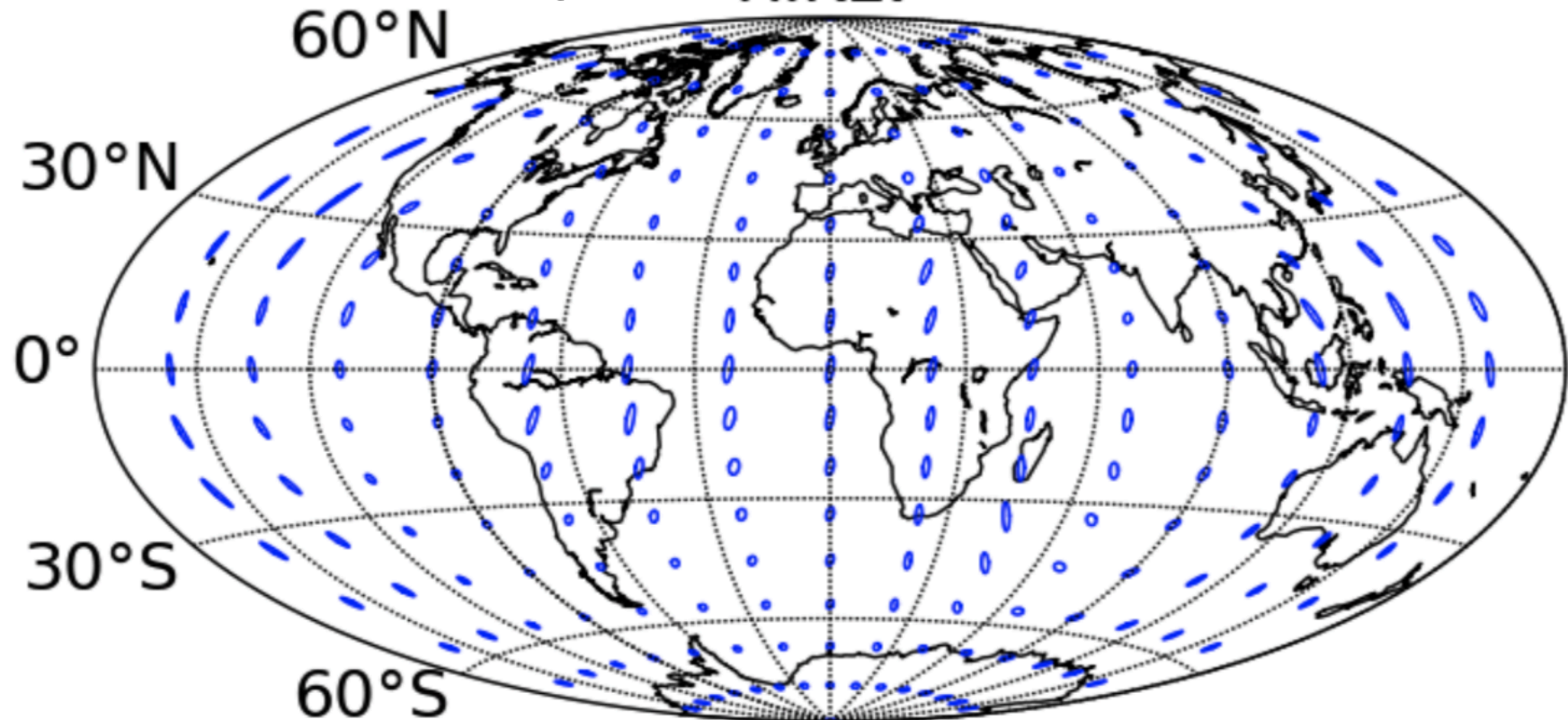

aLIGO operating at full power

Planned for 2018-19

aLIGO Noise Curve: $P_{in} = 125.0$ W

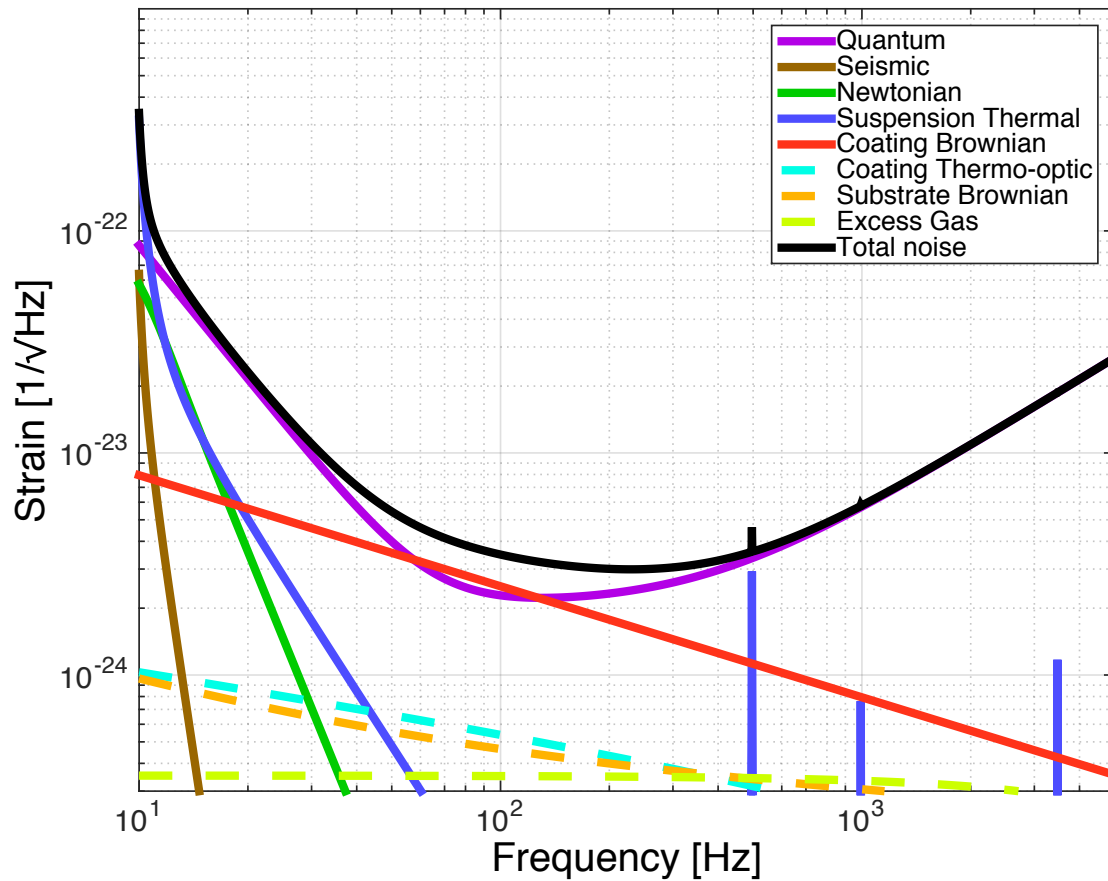

BNS reach: 191 Mpc

BBH reach: 1366 Mpc

QNM SNR ~ 21
(for an event like
GW150914)

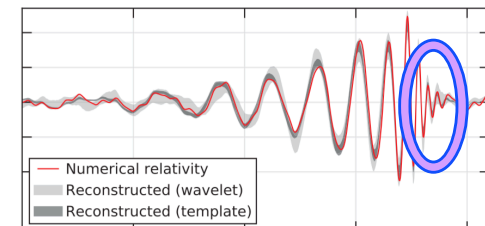

ZUCKER



aLIGO with the addition of frequency-dependent squeezing and lowered optical coating thermal noise

Could be operating mid-2022

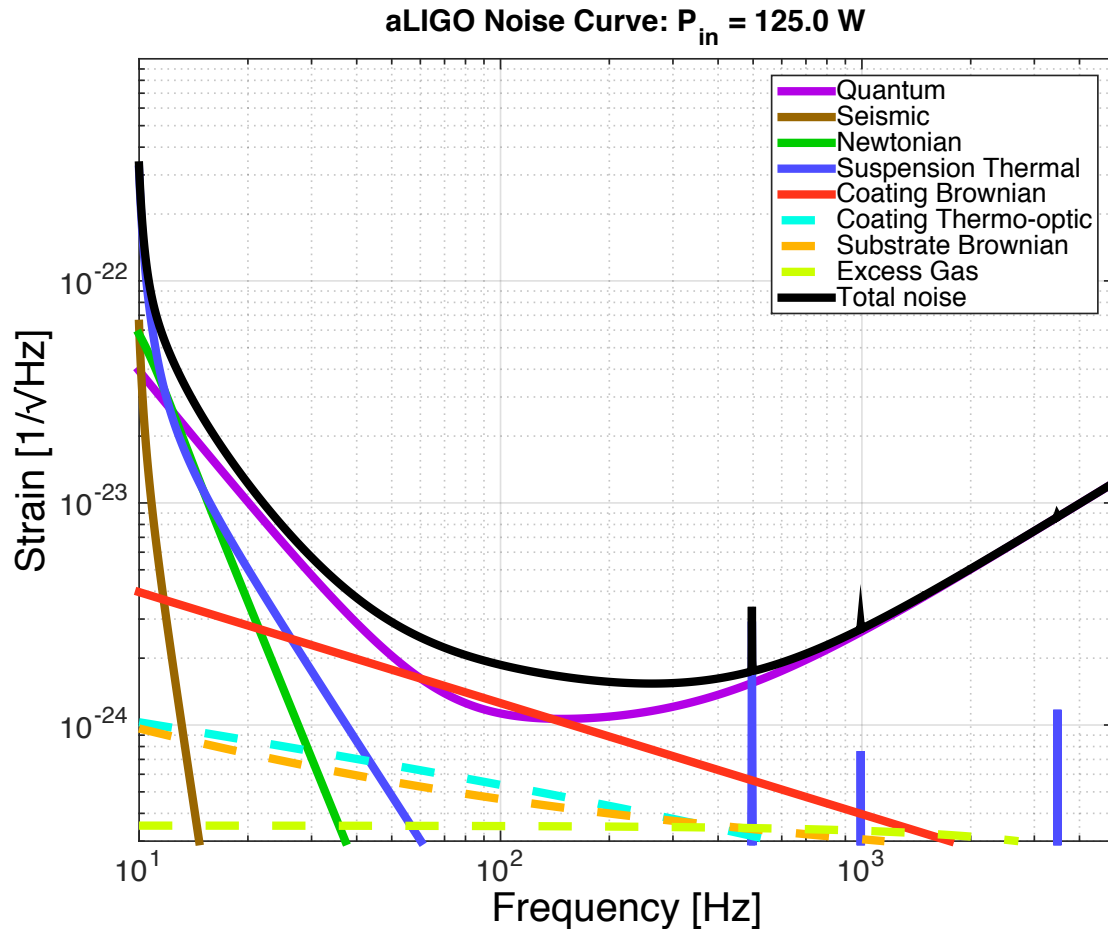

A+

BNS reach: 510 Mpc

BBH reach: 3700 Mpc
($z = 1.1$)

QNM SNR ~ 35
(for an event like
GW150914)

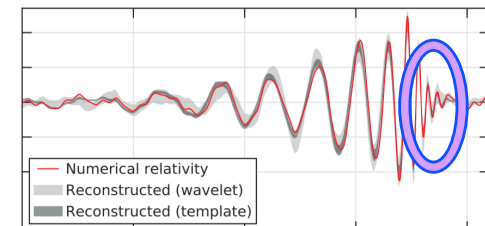

ZUCKER



aLIGO with: Si optics, > 100 kg; Si or AlGaAs coatings; 'mildly' Cryogenic; $\lambda \sim 2 \mu\text{m}$, 300 W

Could be operating late 2020's

Voyager Noise Curve: $P_{\text{in}} = 300.0 \text{ W}$

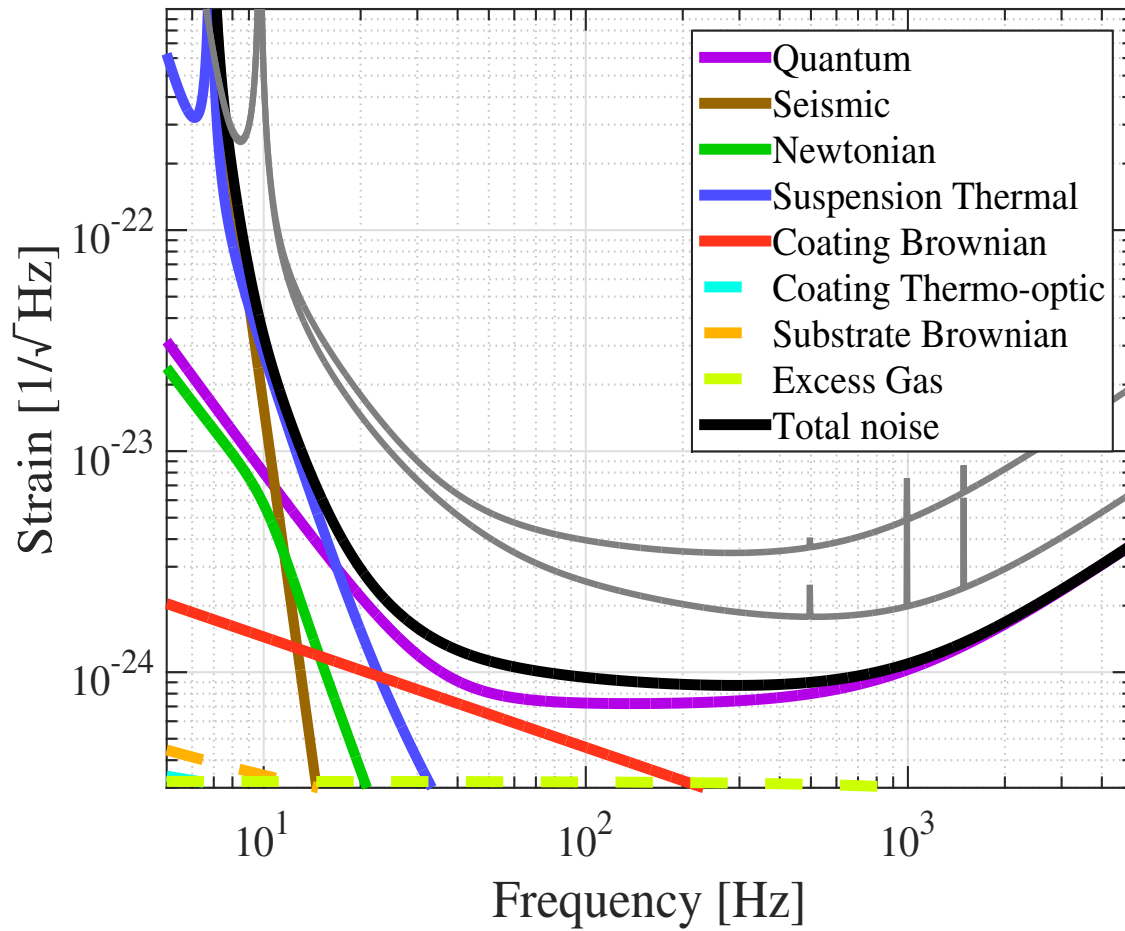

Voyager

BNS reach: 800 Mpc

BBH reach: $z \sim 5$

QNM SNR ~ 80
(for an event like GW150914)

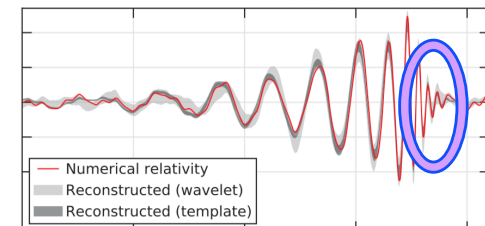

ZUCKER

Further Future Improvements: The 3rd generation

- European Concept: Einstein Telescope
 - Significant design study undertaken for both Facility and Instruments
 - Underground construction proposed to reduce Newtonian Background
 - » (and be compatible with densely-populated Europe)
- Triangle – LISA-like –
with 10km arms
- Multiple instruments in a
'Xylophone' configuration
 - » Allows technical challenges
for low- and high-frequency
to be separated
- Designed to accommodate a
range of detector topologies and
mechanical realizations
 - » Including squeezing and
cryogenics

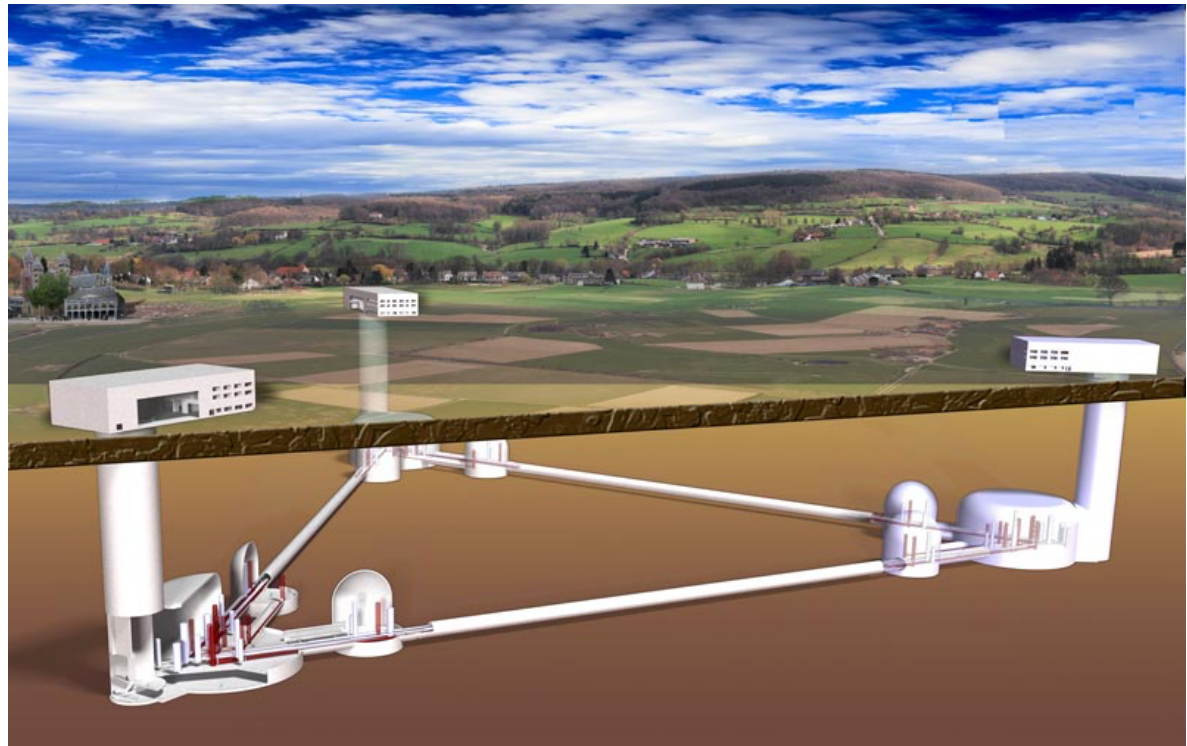



US Concept: Make Advanced LIGO 10x longer, 10x more sensitive

Signal grows with length – **not** most noise sources

- Thermal noise, radiation pressure, seismic, Newtonian unchanged
- Coating thermal noise improves faster than linearly with length
- 40km surface Observatory ‘toy’ baseline
 - can still find sites, earthmoving feasible; costs another limit...
- Concept offers sensitivity without new measurement challenges; could start at room temperature, modest laser power, etc.

	Adv. LIGO	40 km LIGO
Arm length	4 km	40 km
Beam radius	6.2 cm	11.6 cm
Measured squeezing	none	5 dB
Filter cavity length	none	1 km
Suspension length	0.6 m	1 m
Signal recycling mirror trans.	20%	10%
Arm cavity circulating power	775 kW	
Arm cavity finesse	446	
Total light storage time	200 ms	2 s

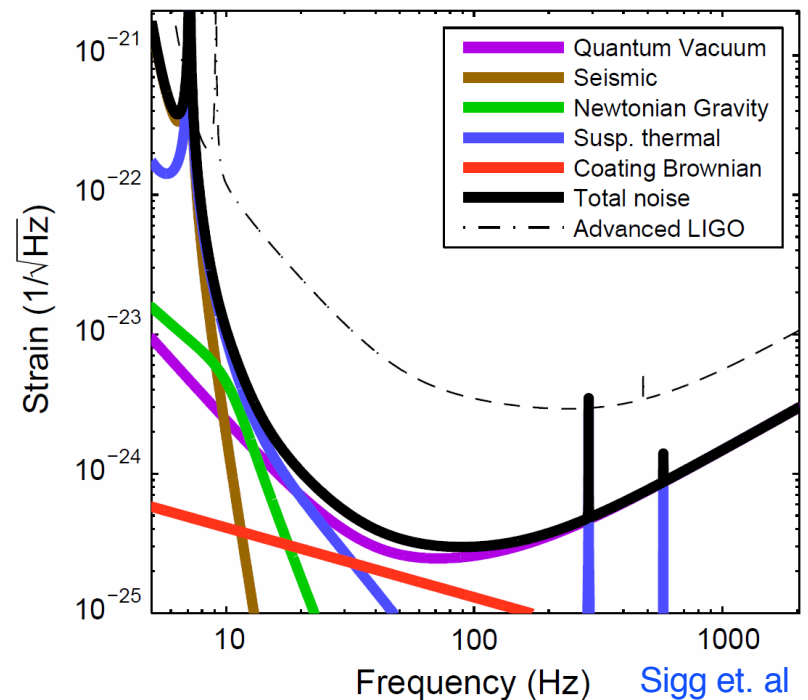



Einstein Telescope, Cosmic Explorer

'Green field' multi-generation Observatories ~G\$/G€

Horizon and 10, 50 and 75 % confidence levels

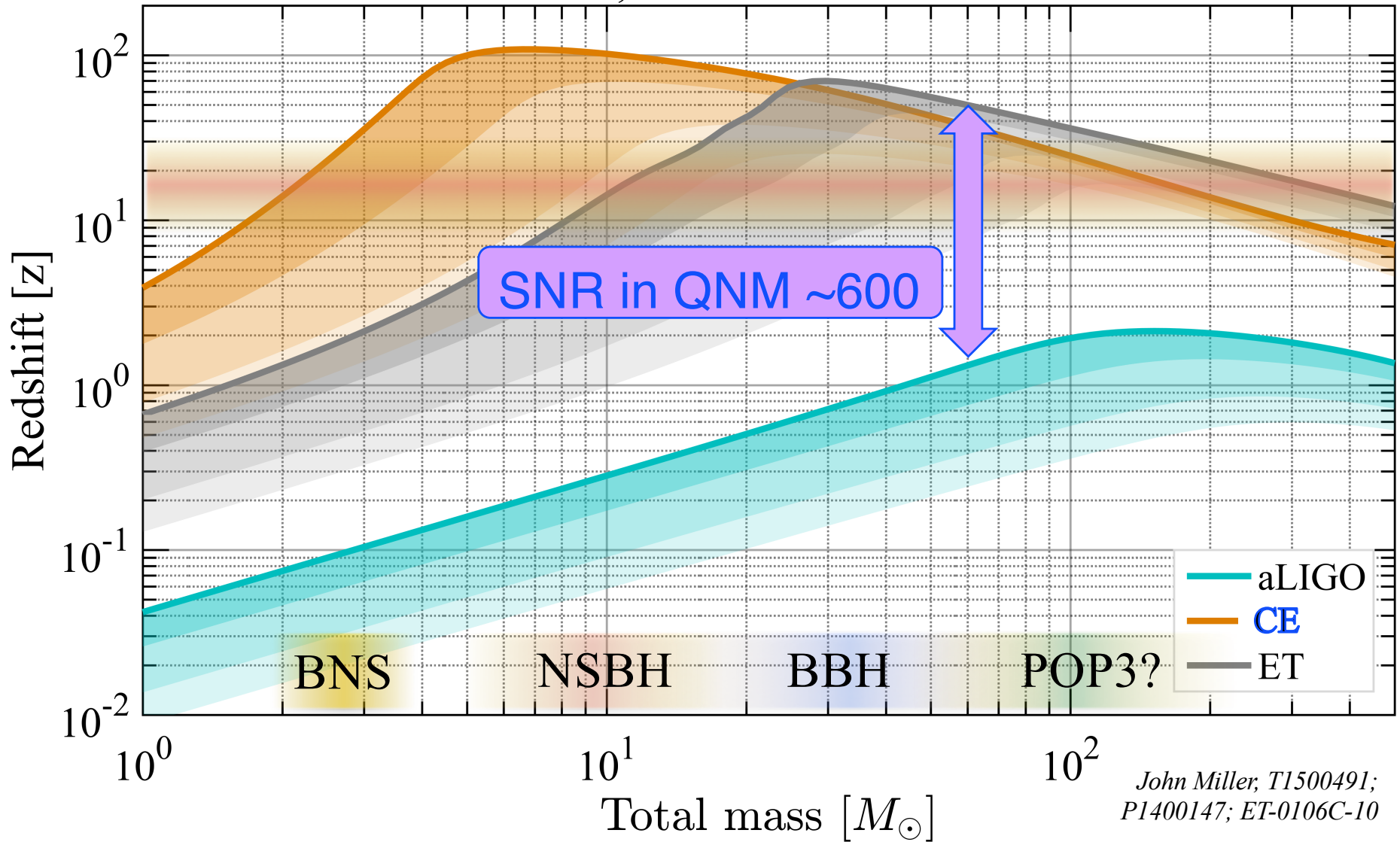

John Miller, T1500491;
P1400147; ET-0106C-10

ZUCKER Sigg et. al

- When could this new wave of ground instruments come into play?
- Appears 15 years from $t=0$ is a feasible baseline
 - » Initial LIGO: 1989 proposal, and at design sensitivity 2005
 - » Advanced LIGO: 1999 White Paper, GW150914 in 2015
- Modulo funding, could envision...
 - » **Einstein Telescope in the early 2030's**
 - » **Cosmic Explorer in the mid-2030s**
- Should hope – and strive and plan – to have great instruments ready to ‘catch’ the end phase of binaries seen in LISA (ref. Sesana)
- **Crucial for all these endeavors: to expand the scientific community planning on exploiting these instruments far beyond the GR/GW enclave**
 - » Costs are like TMT/GMT/ELT – needs a comparable audience



- Once you are there, vacuum is inexpensive – make *very* long arms
 - » Very high signal-to-noise – precision tests of gravitation
- Can observe much larger masses
 - » Galaxies with black holes of a million solar masses coalescing
- Analogous to adding Radio Astronomy to Optical Astronomy



LISA

- Notion of a space-based interferometric detector dates from 1974
 - » Rai Weiss and Peter Bender
- Basically a timing measurement between test masses in space
- Take advantage of vacuum in space: make very long arms
 - » $h = \Delta L/L$; L can be $\sim 10^9$ m, making $\Delta L \sim 10^{-12}$ m (not LIGO's 10^{-19})
 - » Also moves best sensitivity to milliHz region – explores much more massive objects
- Triangular configuration
- Sums and differences around the triangle
 - » Allows both polarizations of the gravitational waves to be measured
 - » Provides signals to remove laser frequency noise
- Earth-trailing orbit provides scan of the sky, provides sky localization

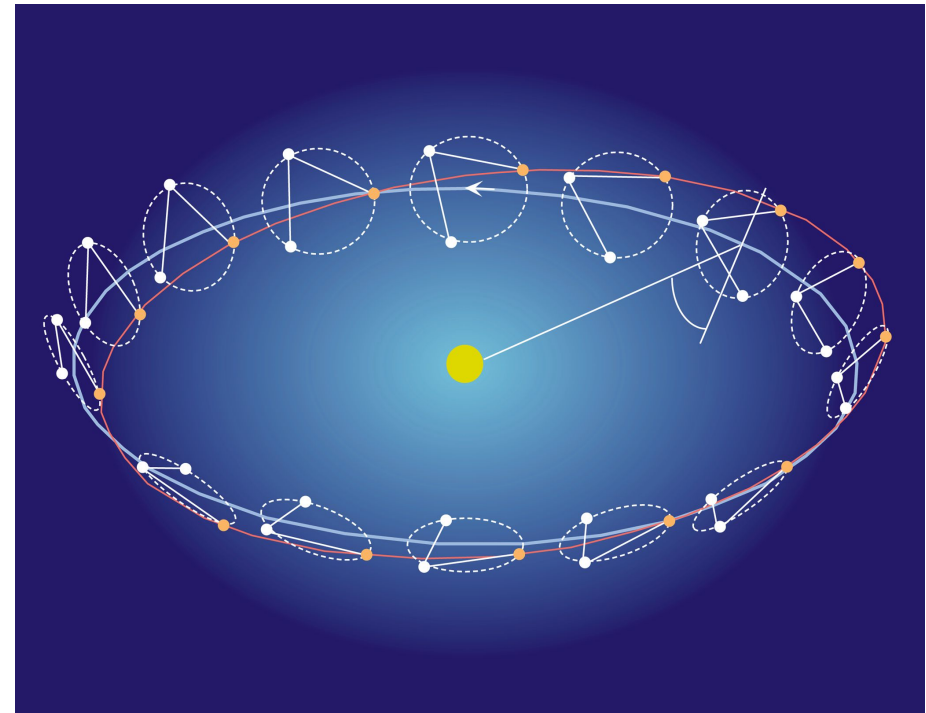
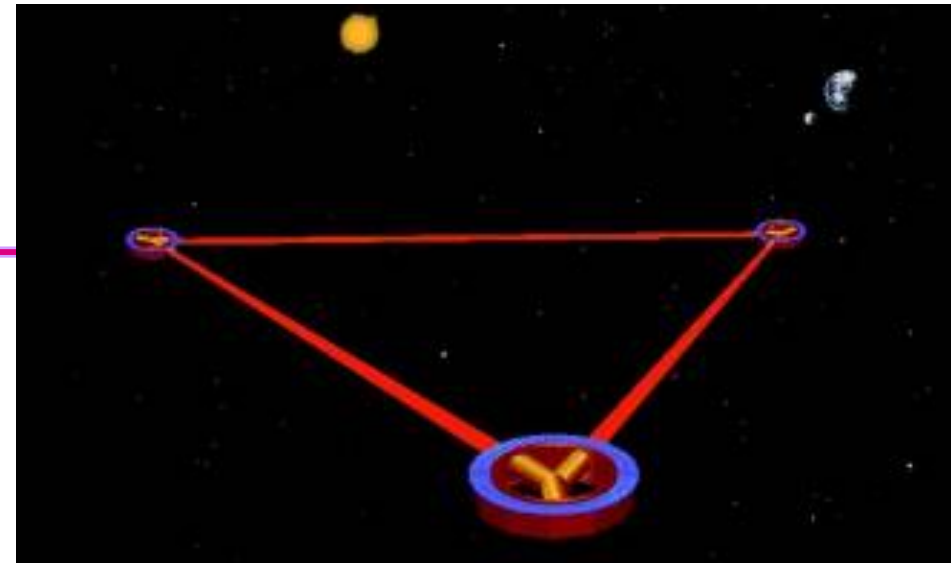

LISA Pathfinder test mission, now underway: interferometry between two LISA test masses

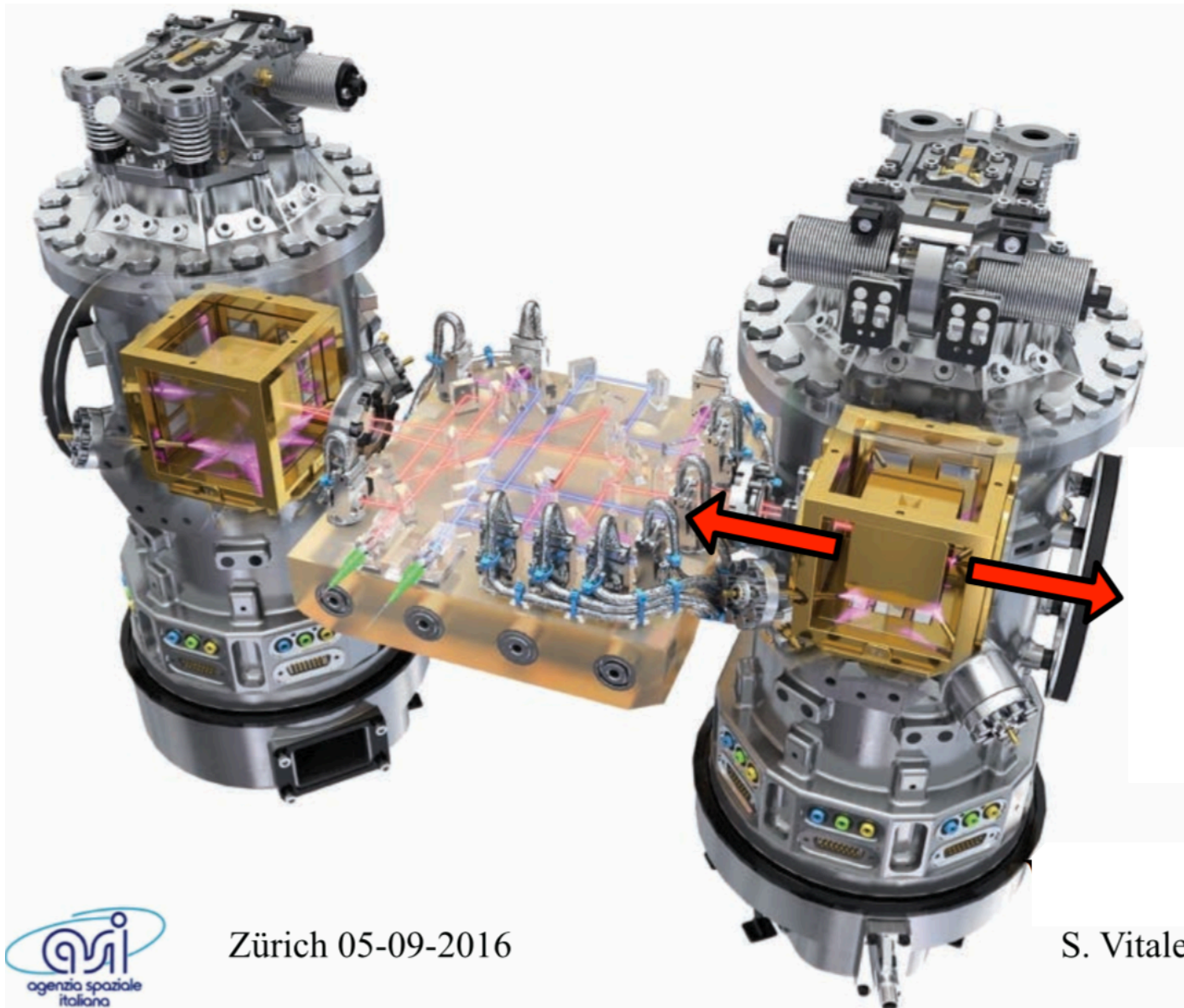



LISA Sensitivity, with current Pathfinder Performance

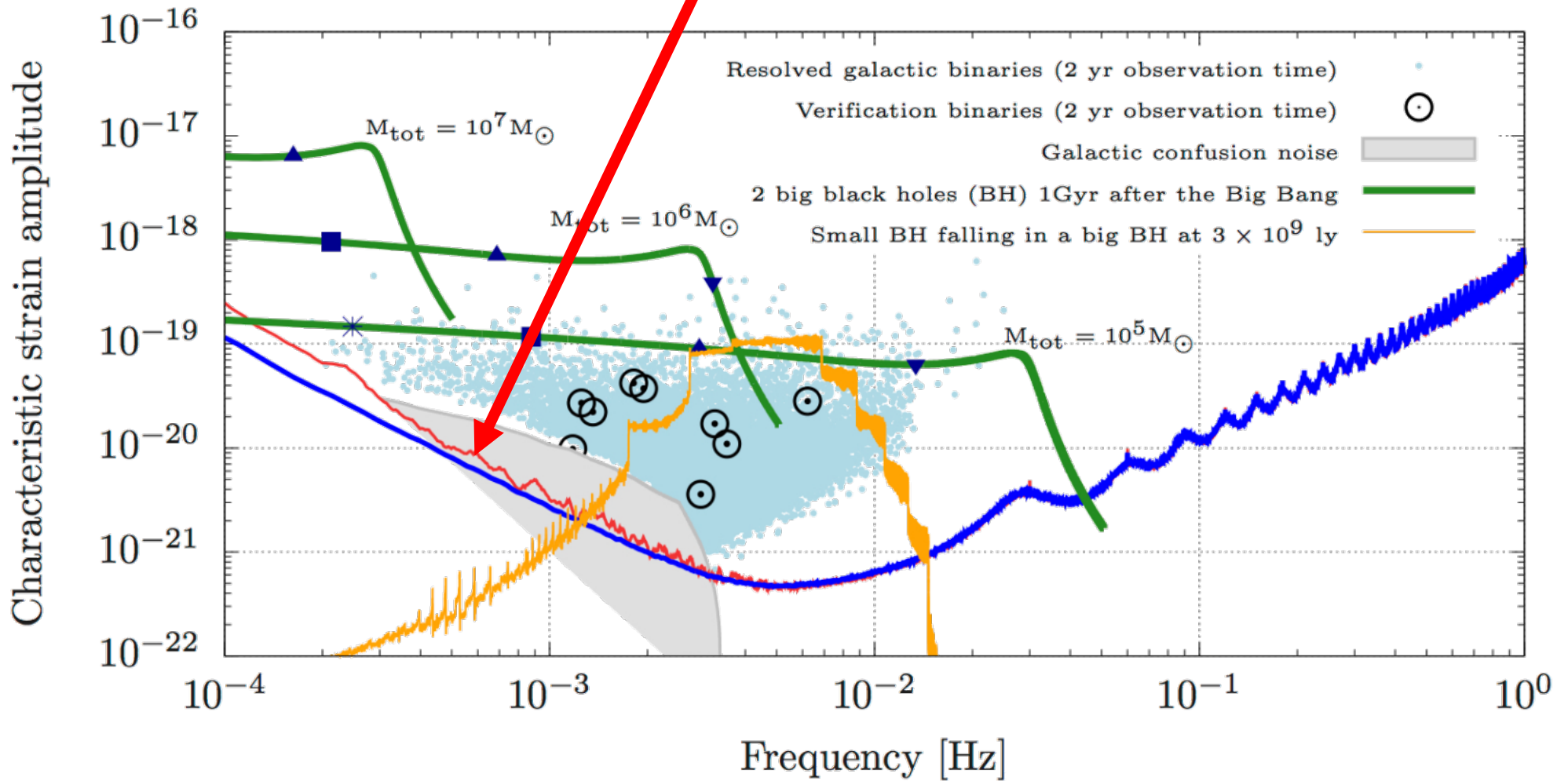

- ESA-led mission; NASA minority partner
- ESA-NASA discussions on program elements
- EU-US community (re-)forming joint collaboration
- Phase A imminent; mission adoption possible in 2020
- **Launch date nominally 2034; may bring in to ~2030**
- ...and then *great science*

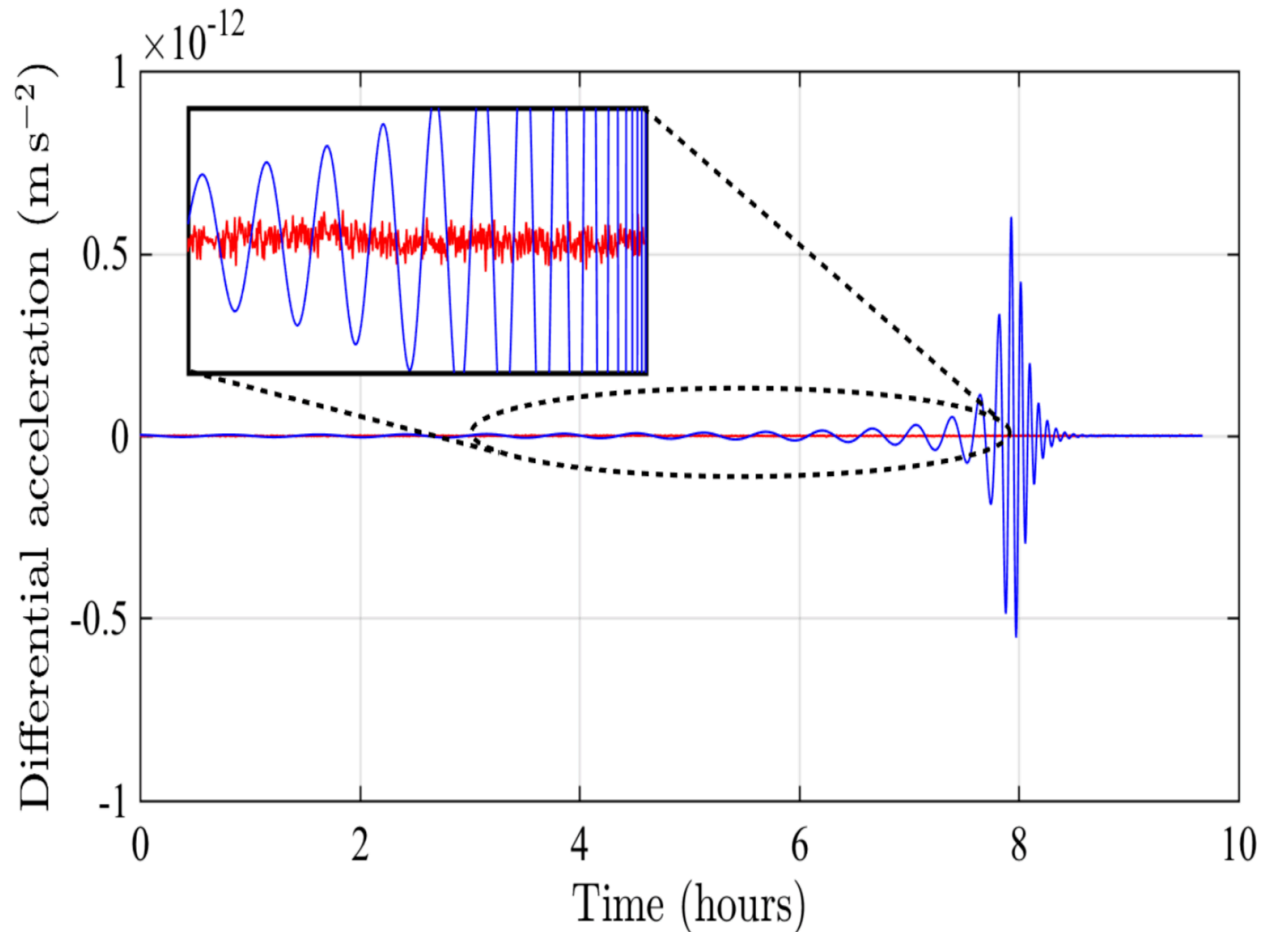

Zürich 05-09-2016

S. Vitale

Blue: Simulated signal for inspiral of two 5×10^5 Black Holes inspiraling at $z=5$
Red: LISA Pathfinder interferometer performance

