



***Interferometer sensing
and control in advanced LIGO***

Kiwamu Izumi (LIGO Hanford)

LIGO India: the Road Ahead at IUCAA, India (17/Aug/2016)

Interferometer control

- ✓ Interferometer control \approx commissioning.
- ✓ Important for getting the interferometer ready.

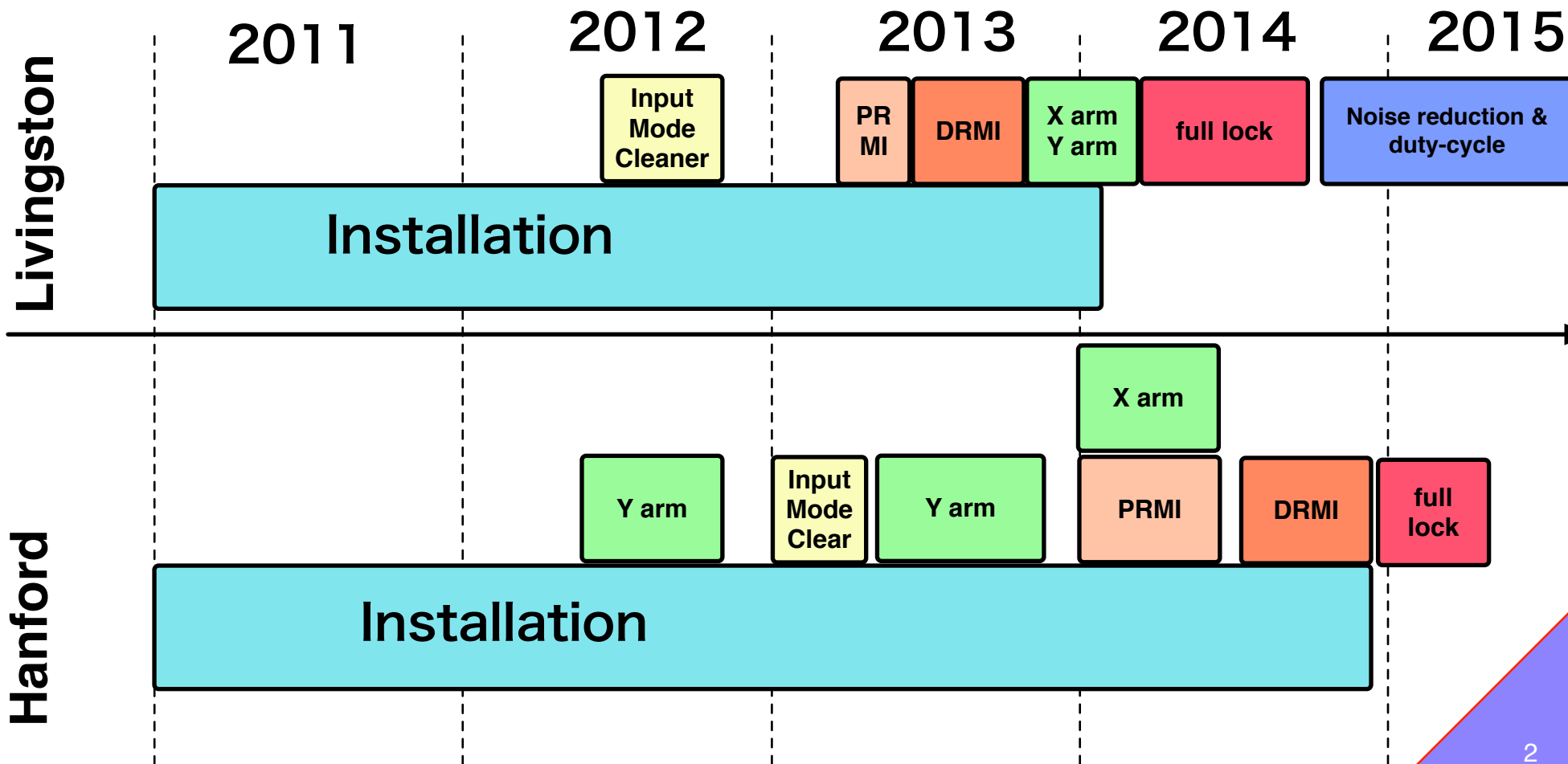

Interferometer control

- ✓ Interferometer control \approx commissioning.
- ✓ Important for getting the interferometer ready.

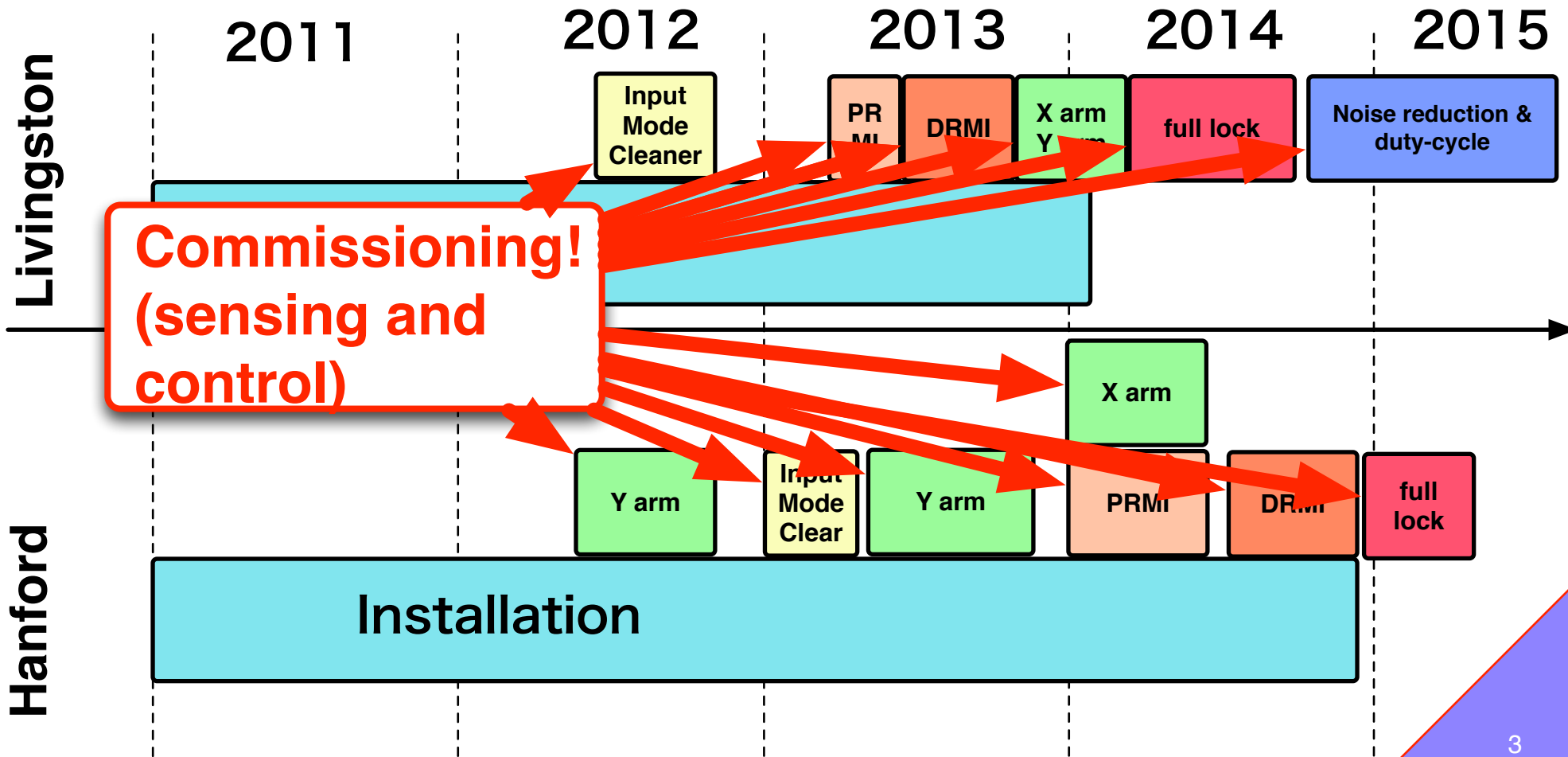

Why control?

We often choose nonlinear devices for high sensitivity (e.g. Interferometer, TES, etc.)

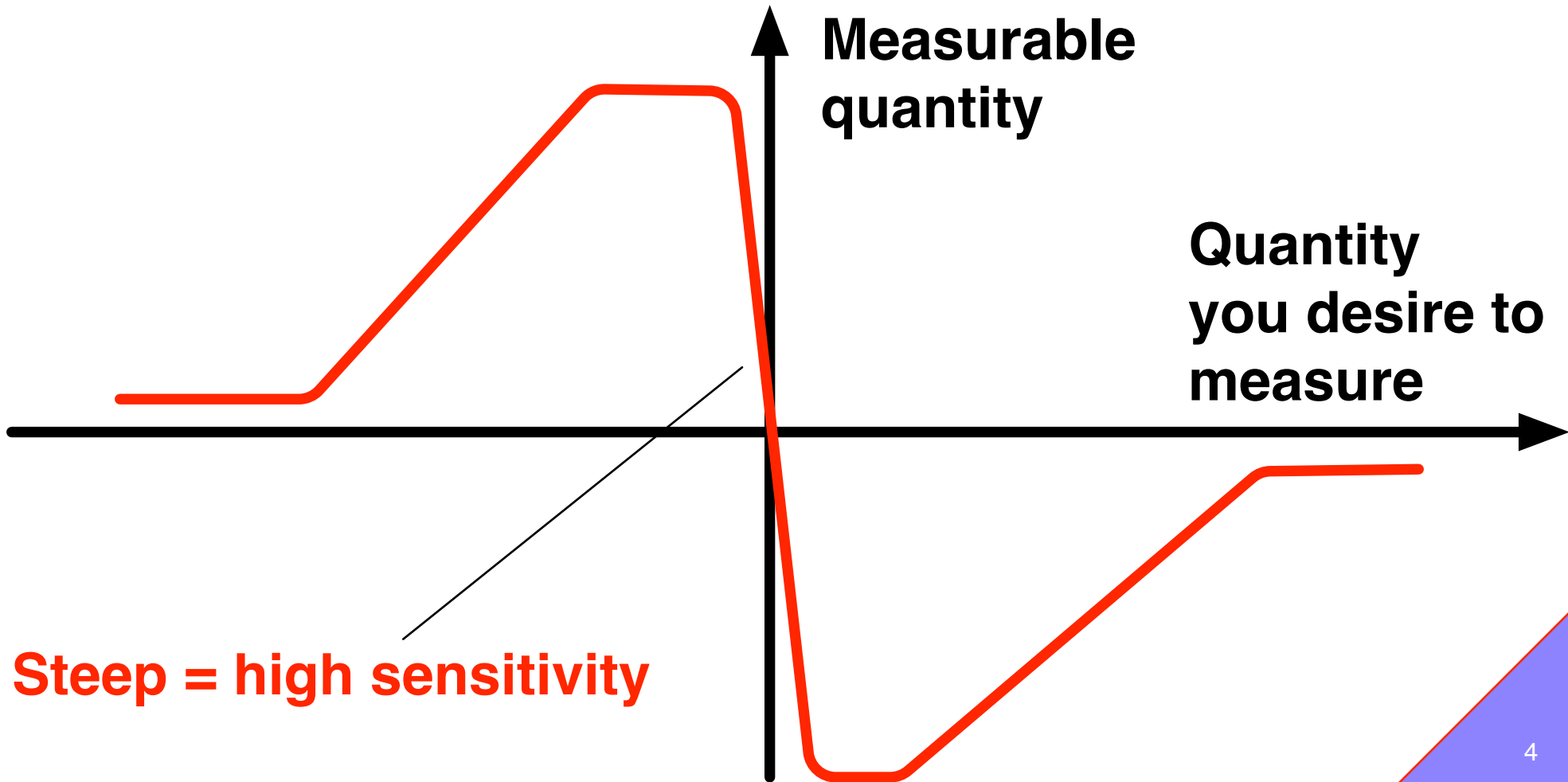

Why control?

The range is on the order of 1 nm for lengths. whereas seismic noise can be ~ 1000 nm.

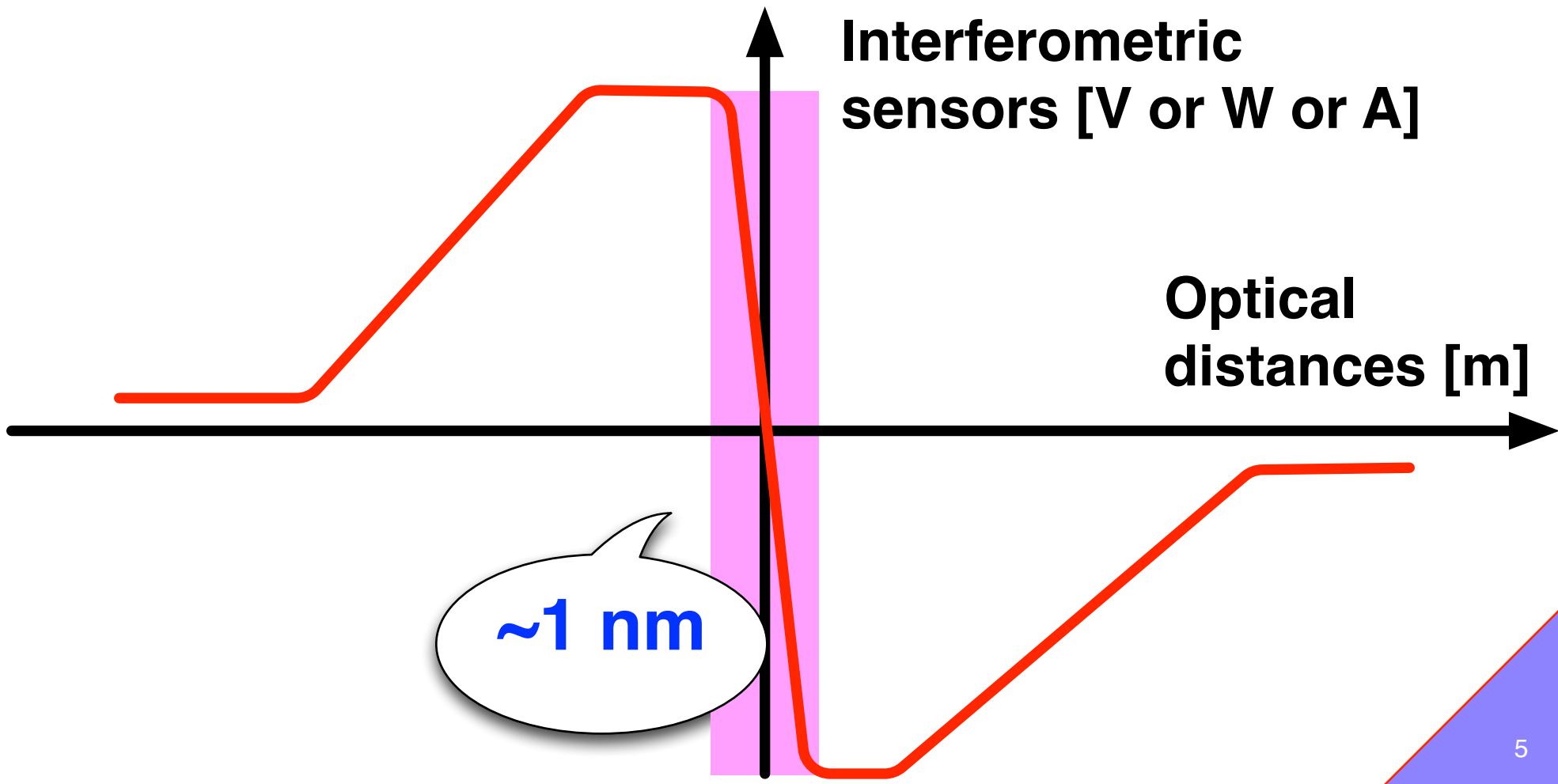

Control is essential

To stay within the sensitive region.

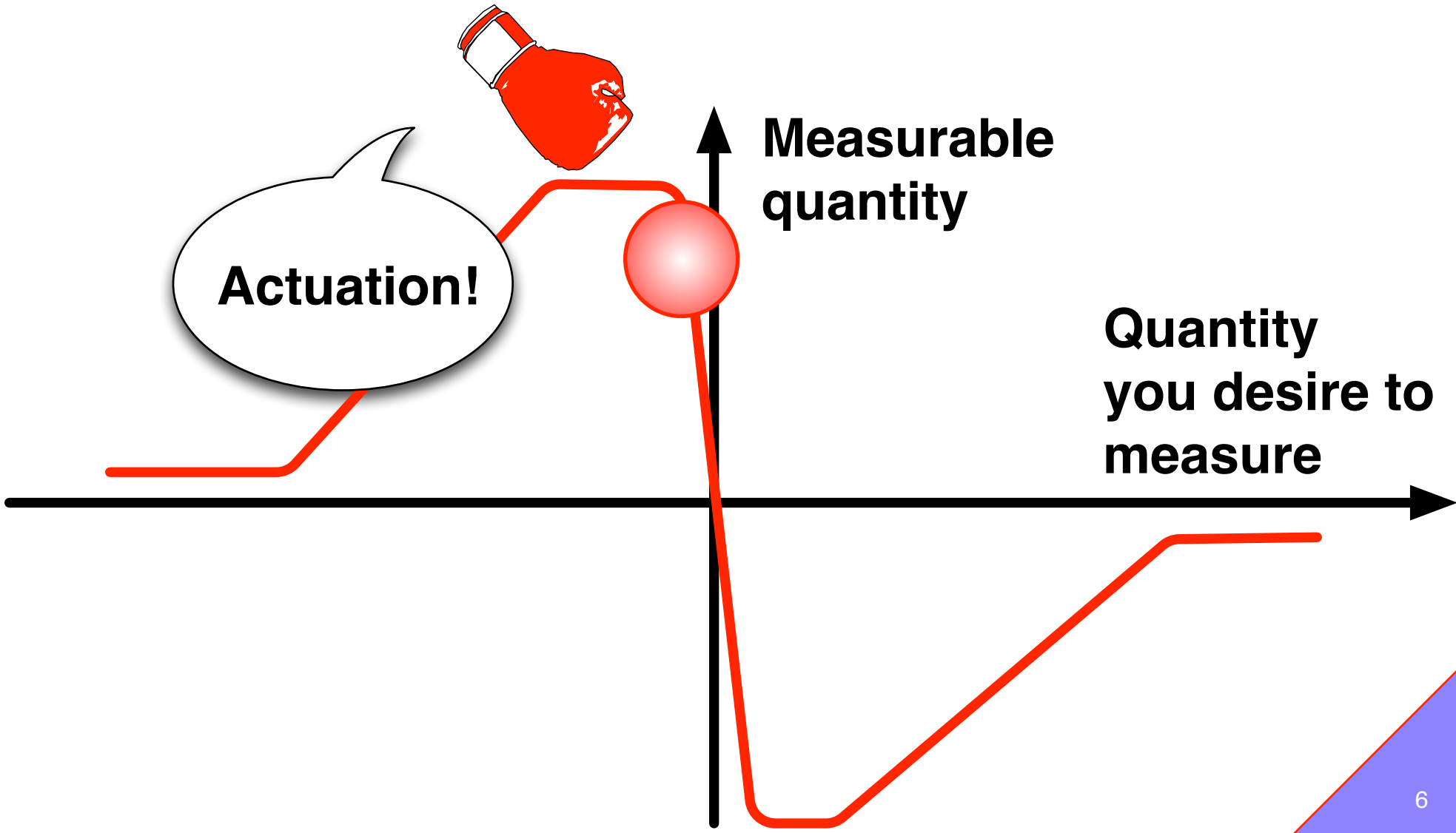

Lock Acquisition

brings the system to the linear range.

But I am NOT going to talk about this today.

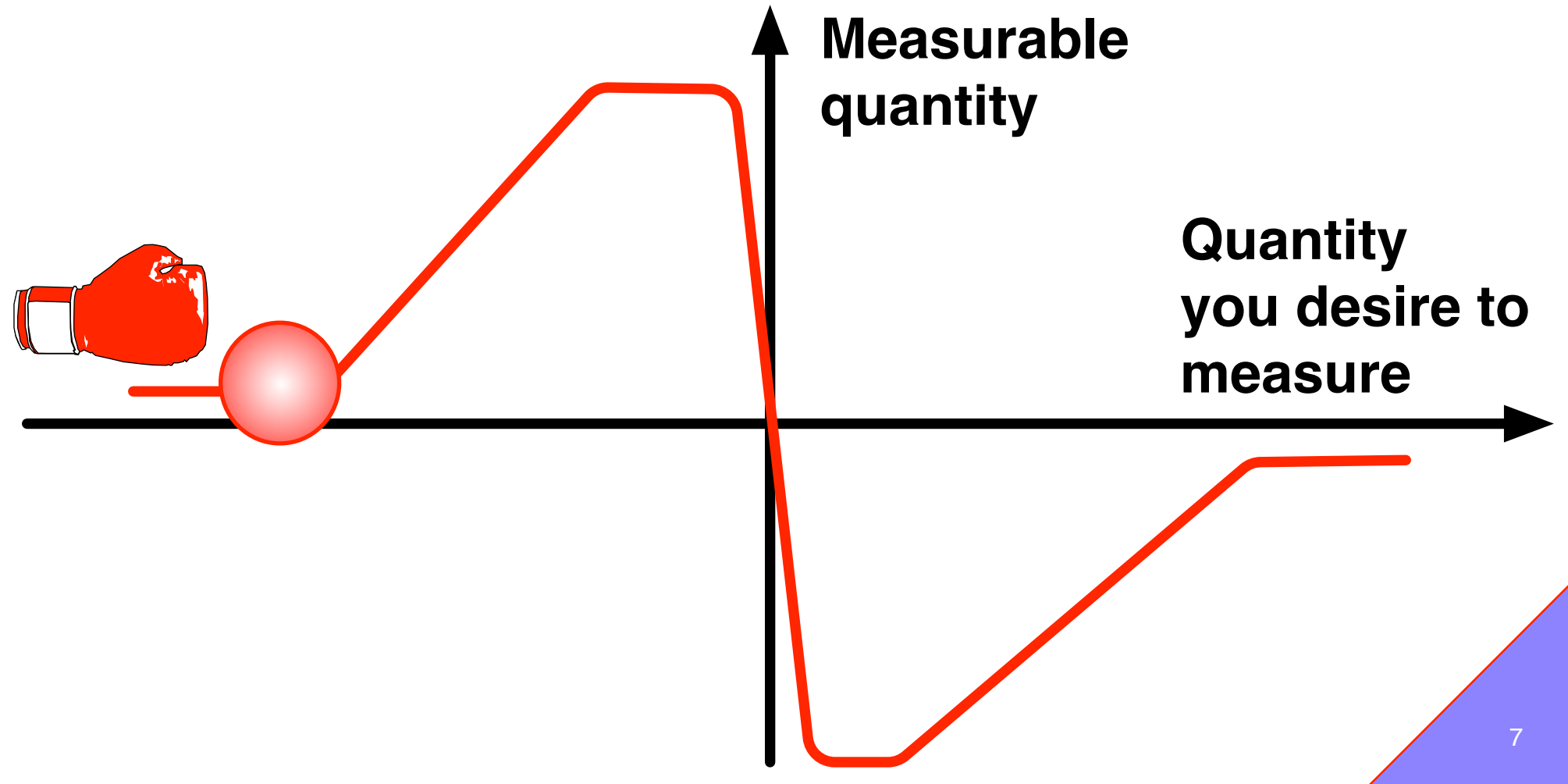

Experimental Challenges

ROBUSTNESS!

- ▣ Lock acquisition
- ▣ Long run
- ▣ Automation
- ▣ Alignment control
- ▣ Tidal effect
- ▣ Thermal lensing
- ▣ Opto-mechanical instab.
- ▣ etc



High duty cycle

LOW-NOISE!

- ▣ Control noise
- ▣ Cross couplings
- ▣ Nonlinear noise
- ▣ Electronics noise
- ▣ Scattering noise
- ▣ etc



High binary range

ISC is exciting

**ISC is the integration of (almost)
all the subsystems**

Optics
(Lasers, interferometry)

Mechanics
(Suspension, Seismic)

**Interferometer
control**

Electronics
(Digital, analog, RF/Audio)

My talk plan

**Part 1:
Review of the aLIGO ISC scheme**

**Part 2:
Some difficulties / subtleties**

My talk plan

Part 1:
Review of the aLIGO ISC scheme.

Part 2:
Some difficulties / subtleties

the (simplified) interferometer

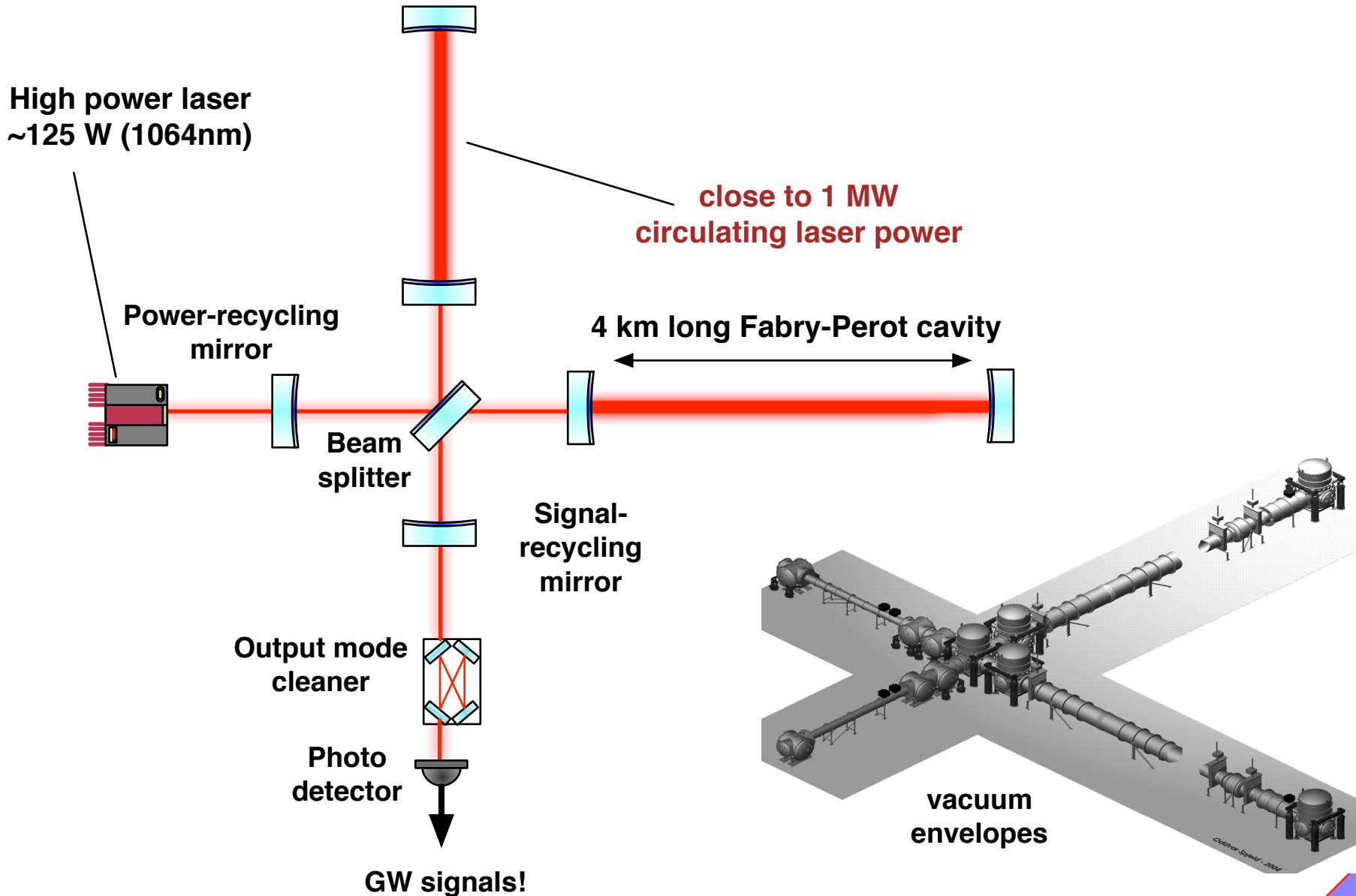

Resonant conditions

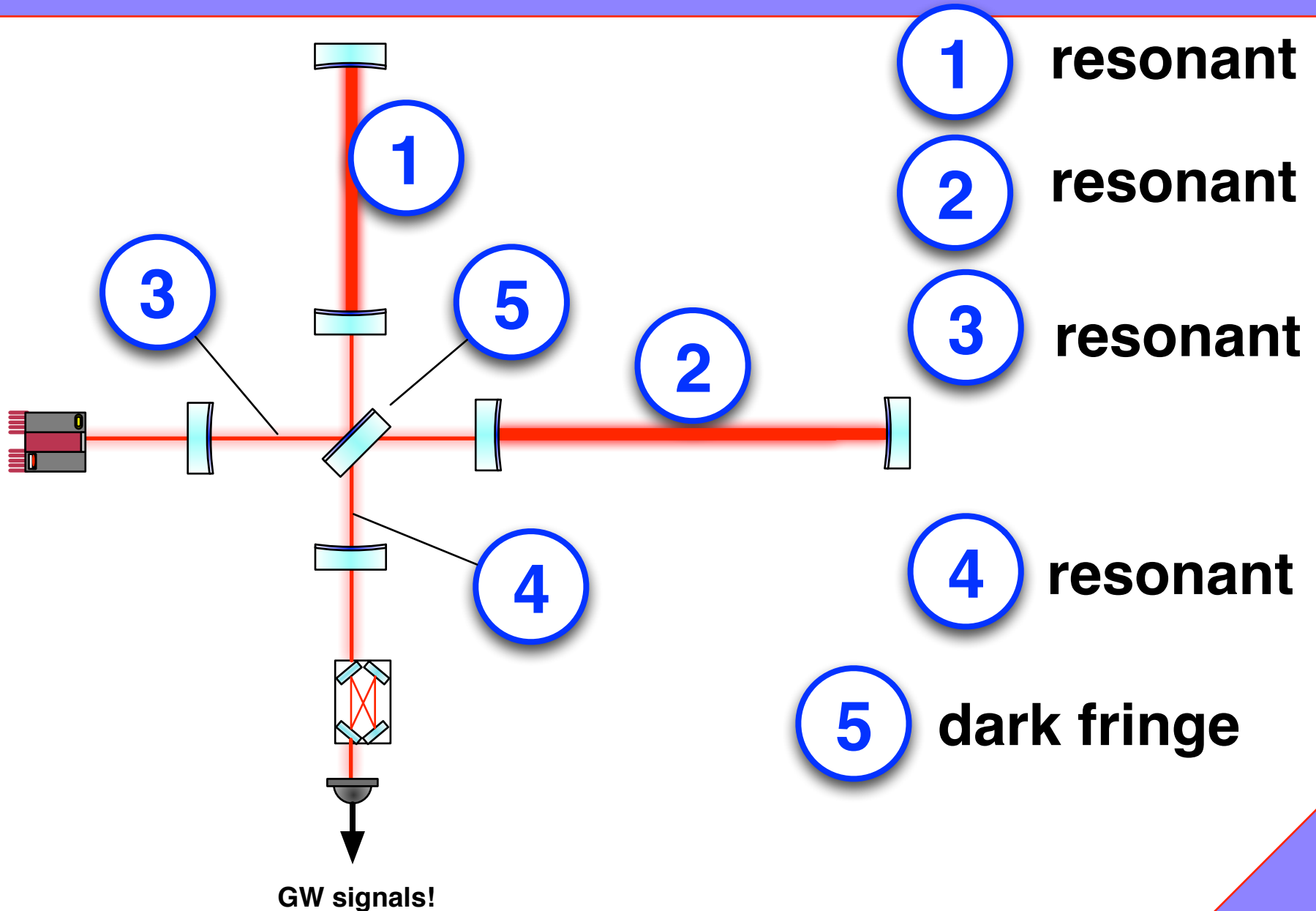

5 degrees of freedom

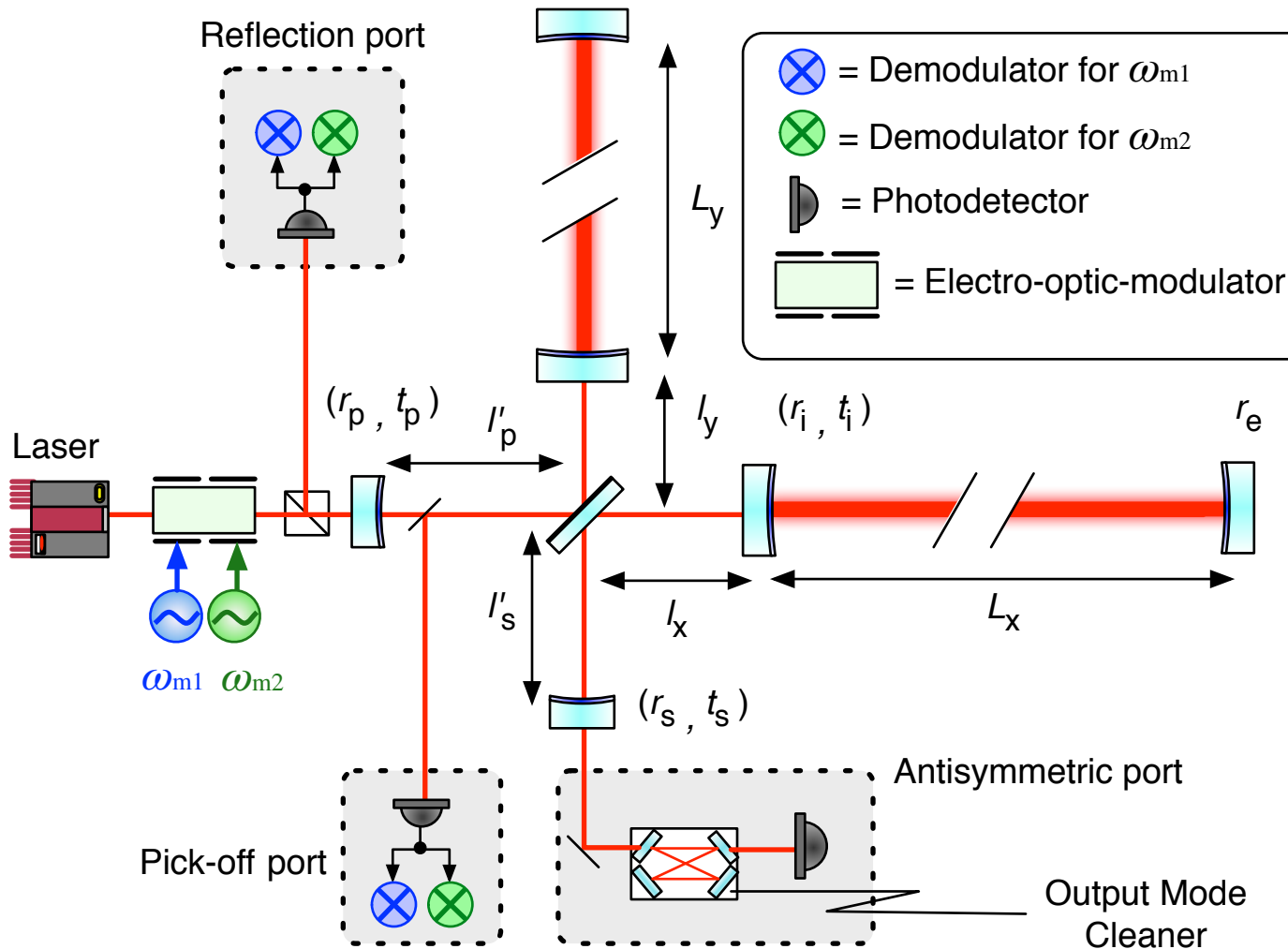

DARM = $(L_x - L_y)/2$
CARM = $(L_x + L_y)/2$
MICH = $(l_x - l_y)/2$
PRCL = l'_p
+ $(l_x + l_y)/2$
SRCL = l'_s
+ $(l_x + l_y)/2$

Pound-Drever-Hall

- ▣ Basic for sensing the length degrees of freedom
- ▣ A heterodyne scheme
- ▣ Phase modulation creates **RF sidebands**
- ▣ RF sidebands behave differently than the carrier light does [1]
- ▣ One serves as **local oscillator field**.
the other serves as **probe field** [2]

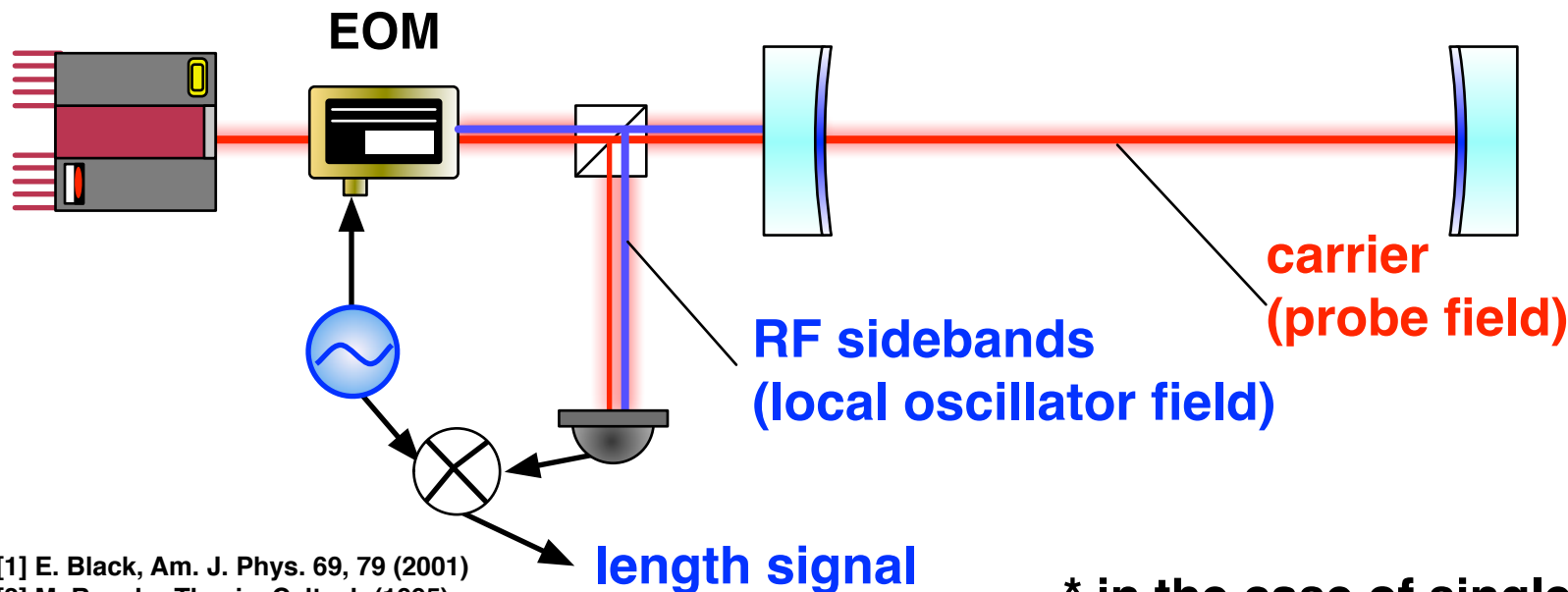

[1] E. Black, Am. J. Phys. 69, 79 (2001)
[2] M. Regehr, Thesis, Caltech (1995)

* in the case of single arm

Sensing the length

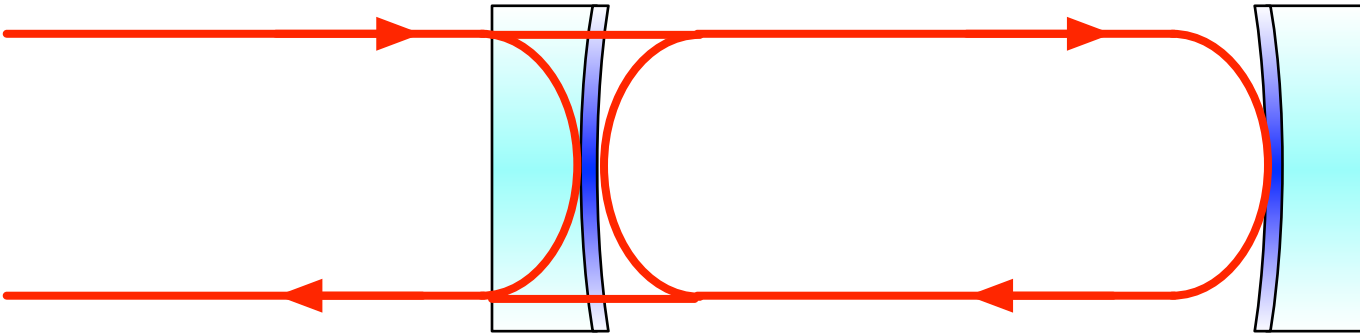

Sensing the length

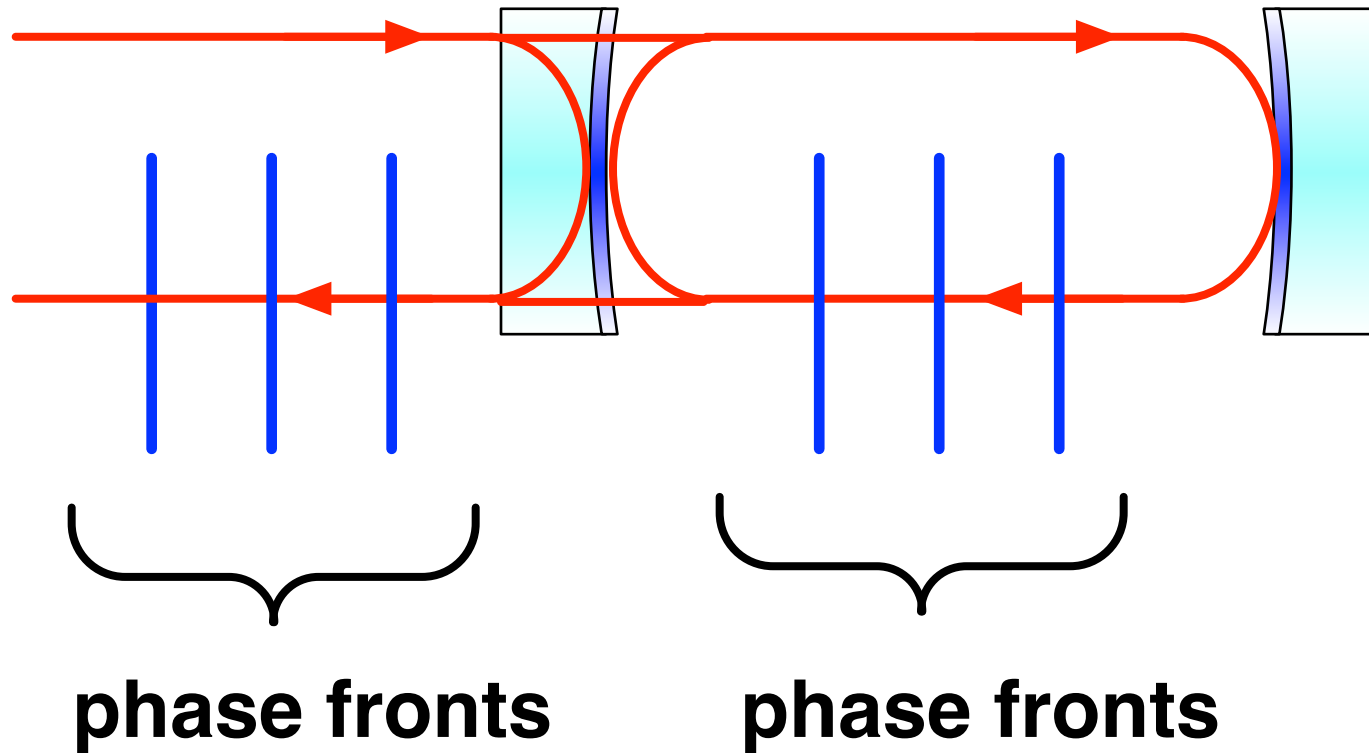

Sensing the length

It is the phase shift that carries the length information

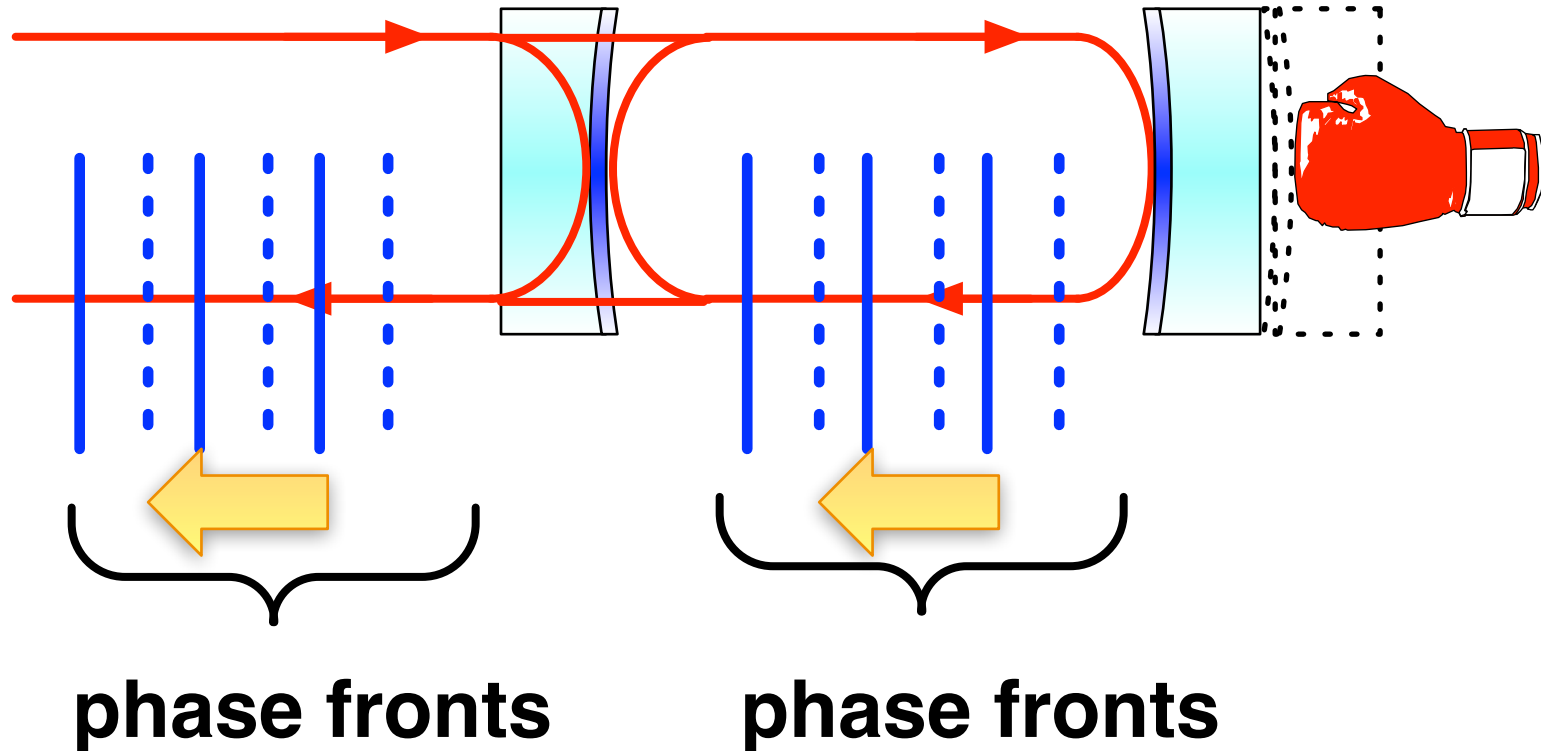

$$\Delta\phi \propto (\text{finesse})^2 \Delta x$$

Sensing the length

Now, phase shift with respect to what?
Here comes RF sidebands.

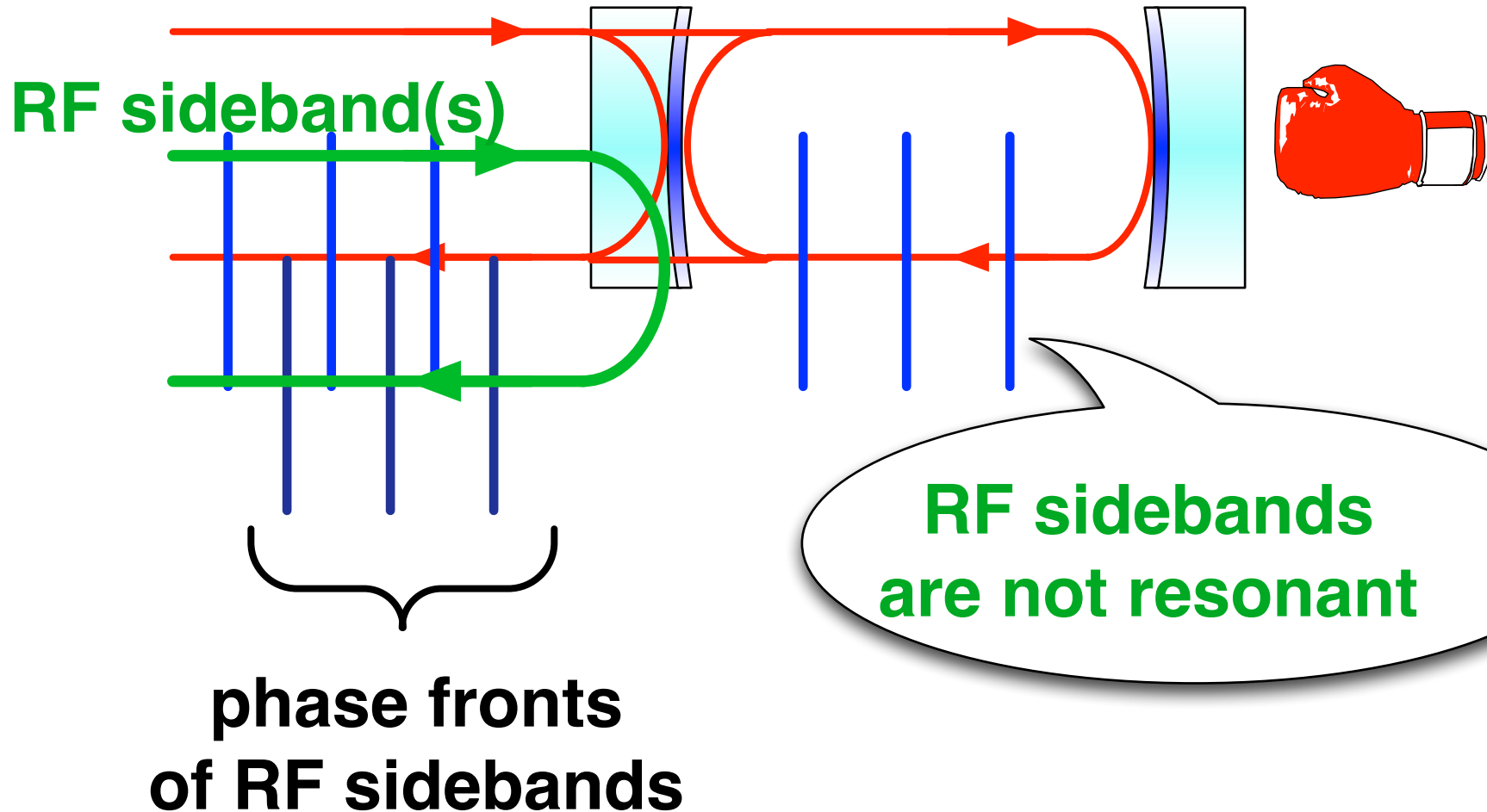

It is just a heterodyne

Input field

$$E = E_0 e^{i(\omega t + m \cos \omega_m t)}$$
$$\approx E_0 e^{i\omega t} \left(1 + i \frac{m}{2} e^{+i\omega_m t} + i \frac{m}{2} e^{-i\omega_m t} \right)$$

carrier RF sidebands

Reflected field

$$E_{\text{refl}} \approx E_0 e^{i\omega t} \left(r(\omega, \Delta x) + i \frac{m}{2} e^{+i\omega_m t} + i \frac{m}{2} e^{-i\omega_m t} \right)$$

reflected carrier RF sidebands are off resonance

Observed intensity

$$P = |E_{\text{refl}}|^2$$
$$= 2|E_0|^2 \underbrace{\Im [r(\omega, \Delta x)]}_{\text{optical phase (length)}} \cos \omega_m t$$

Actuators

Quad suspension

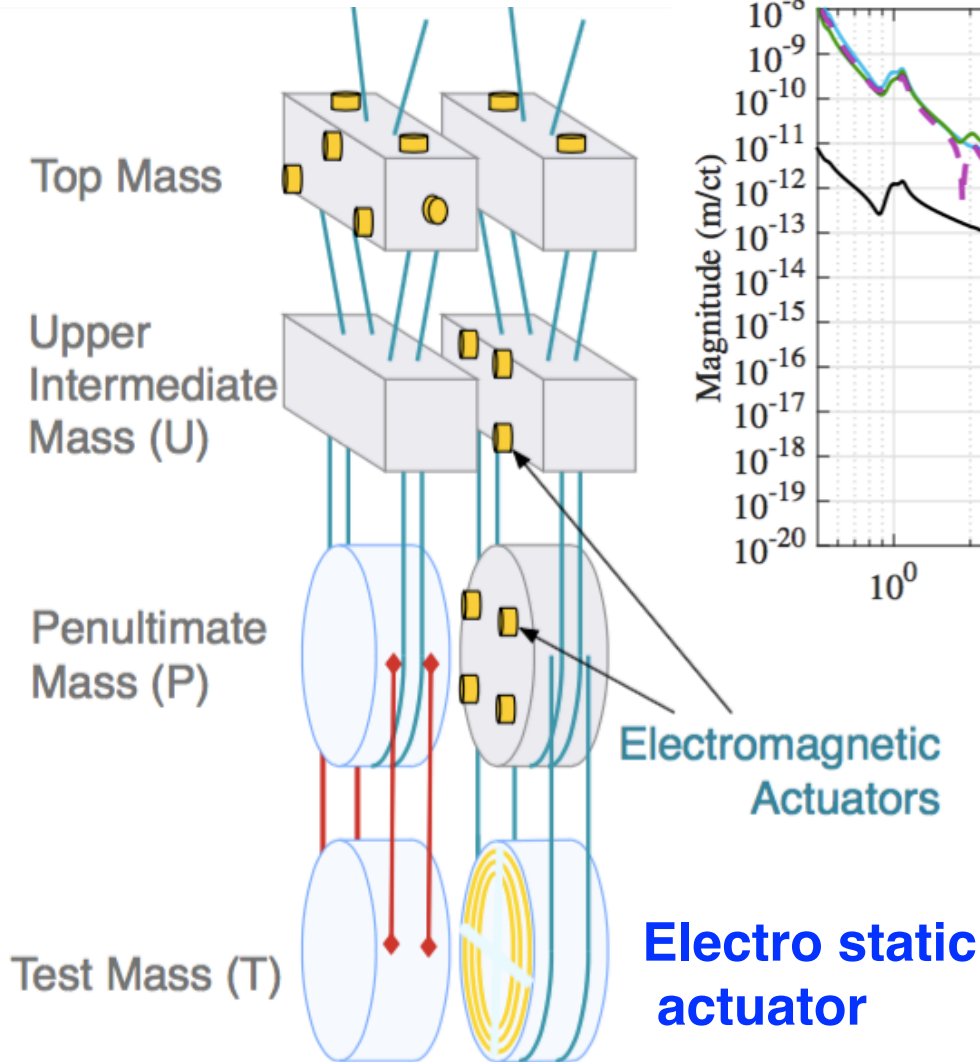

Actuator transfer function

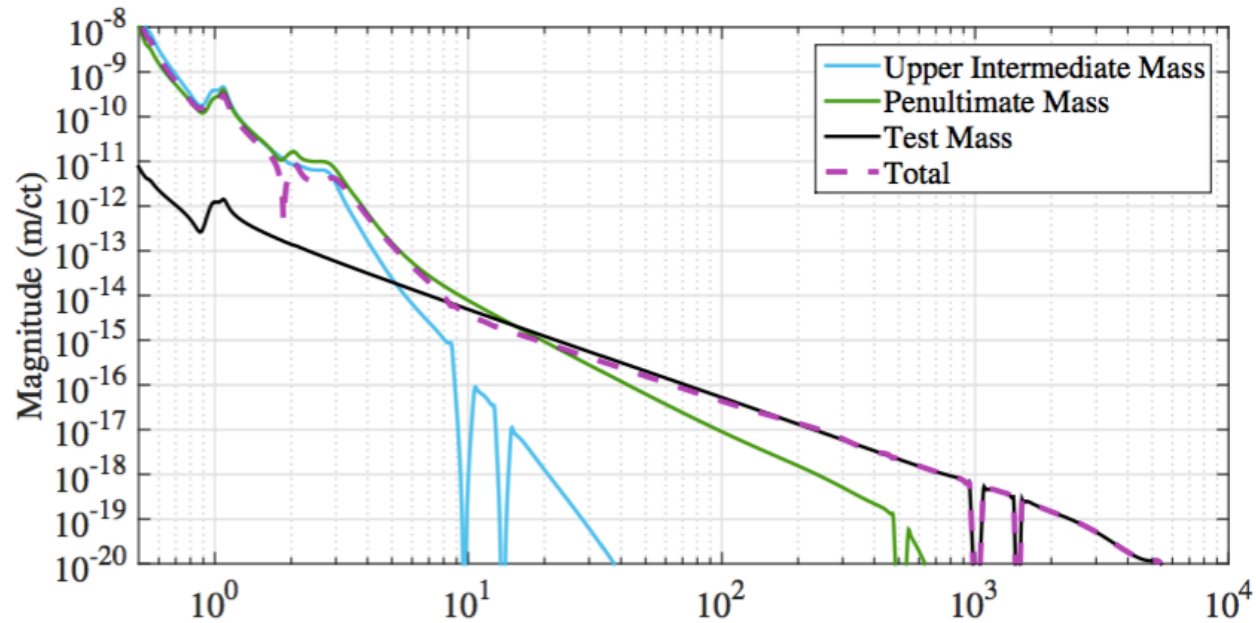

topology

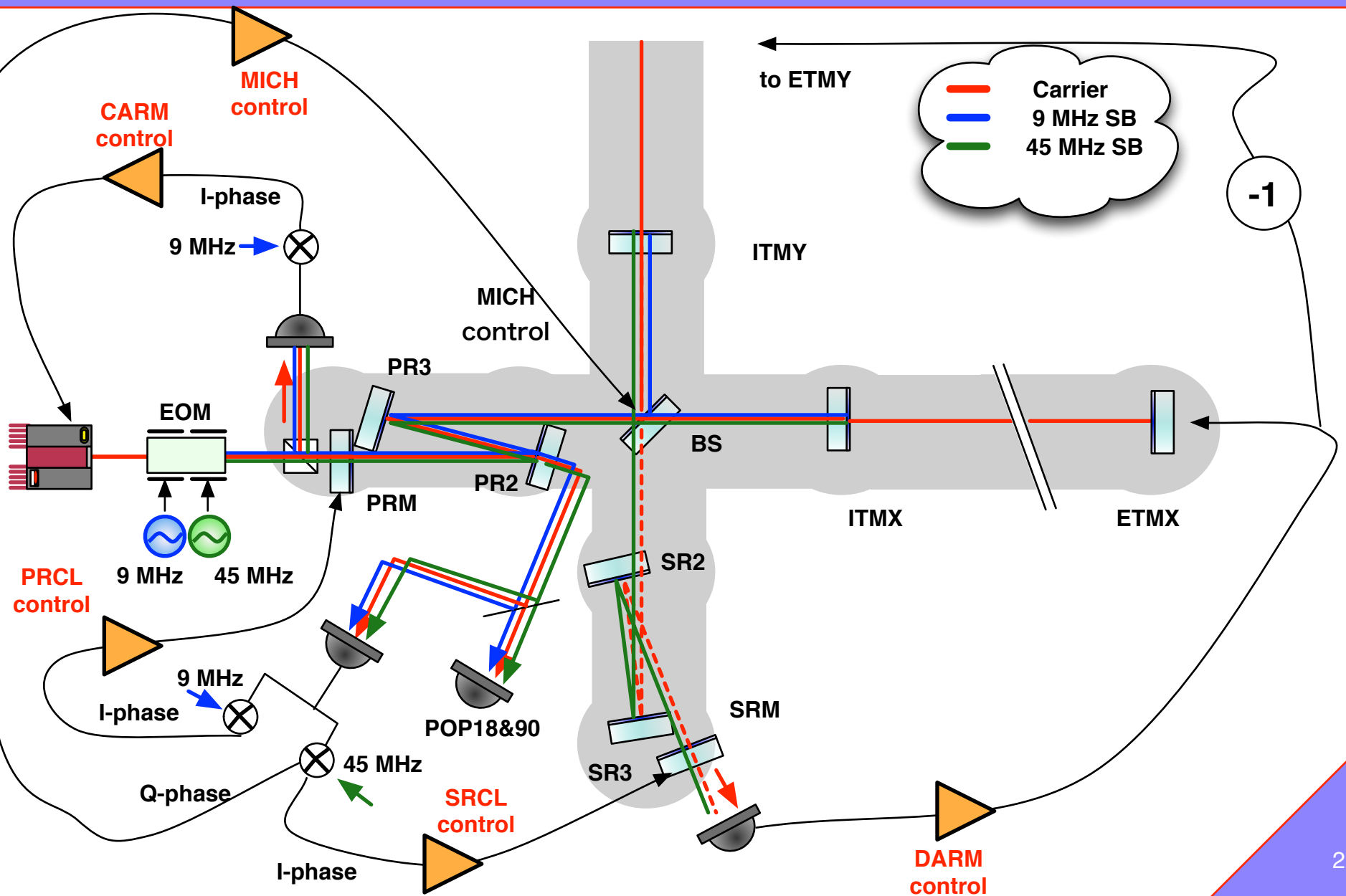

LSC signals are made of

Length DOF (sensor)	local oscillator field	probe field
DARM (OMC)	carrier	carrier
CARM (REFL9I)	9MHz SB	carrier
PRCL (POP9I)	carrier	9MHz SB
SRCL (POP45I)	carrier	45MHz SB
MICH (POP45Q)	carrier	45MHz SB

Digital system

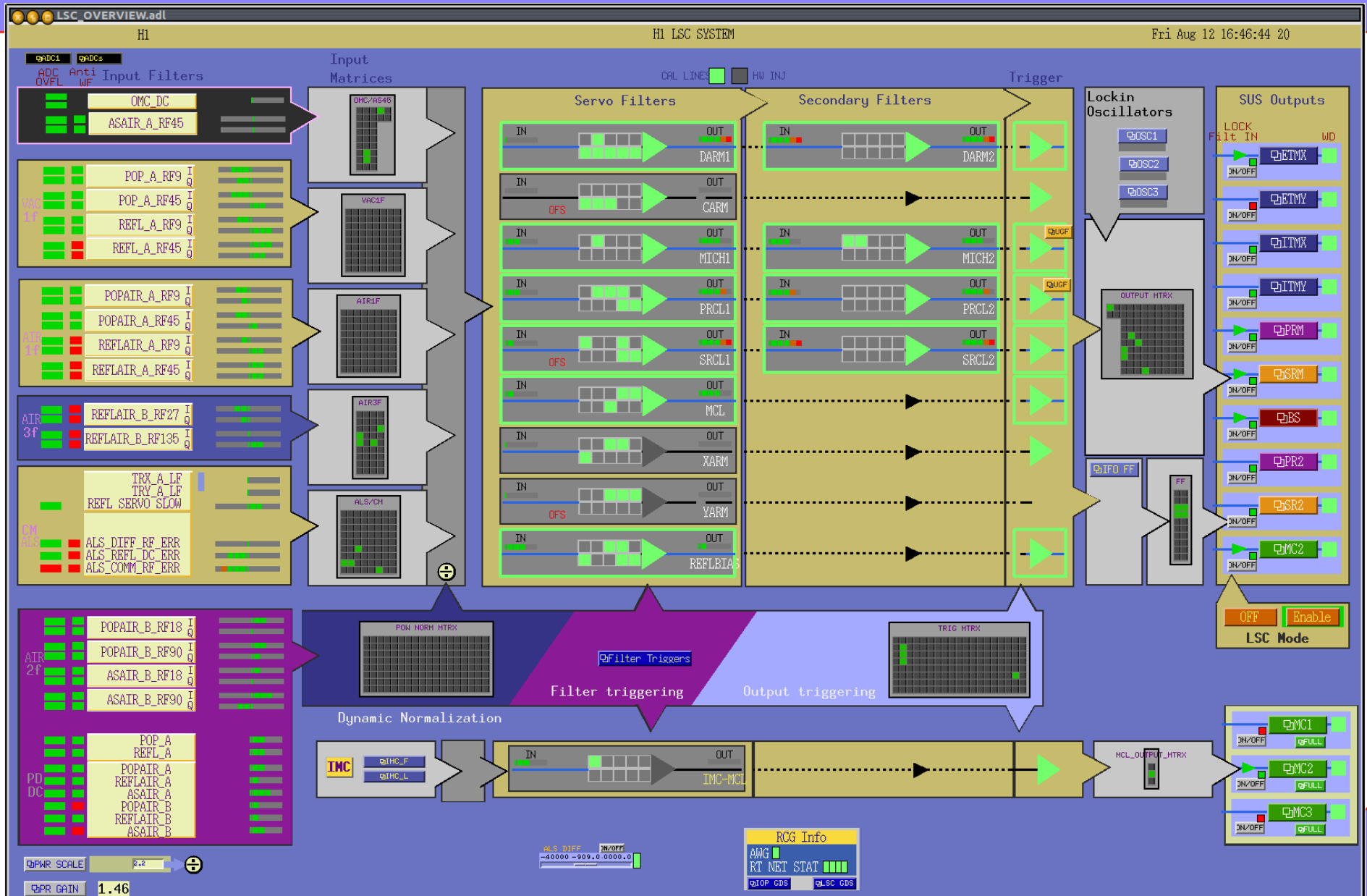

Digital system

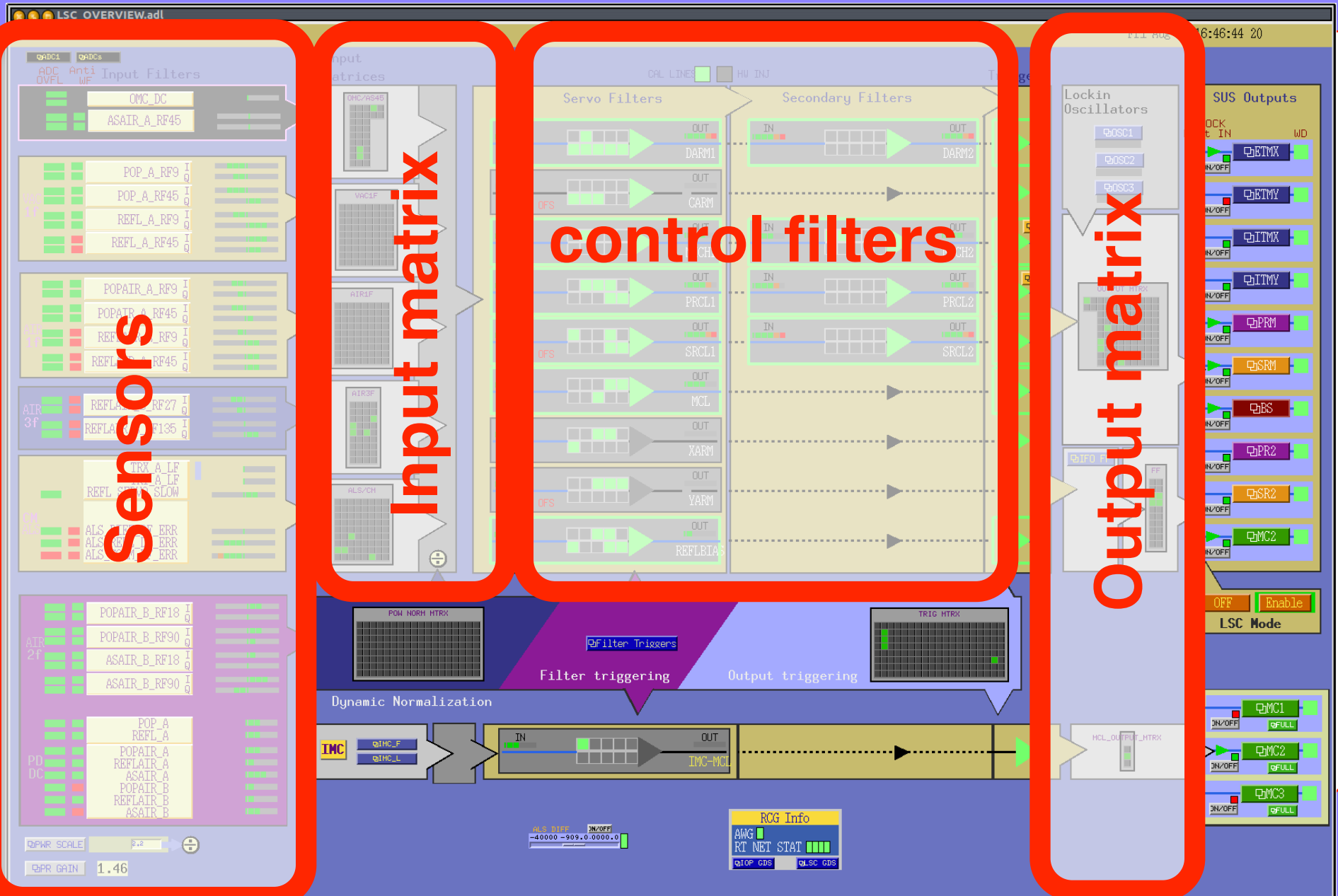

Angular control

Has two main purposes.

**1. maintain high cavity power
=> wave front sensors**

**2. maintain a pointing
=> DC quadrant photo detectors (QPDs)**

Wave front sensing

- ▣ Similarly to LSC, a heterodyne readout is used.
- ▣ Shares the same RF sidebands with length sensing
- ▣ Senses the wavefront tilt (not translation)
 - ⇒ Multi-pixel Pound-Drever-Hall technique.
- ▣ Careful choice of Gouy phase is a key to sense all the degrees of freedom.

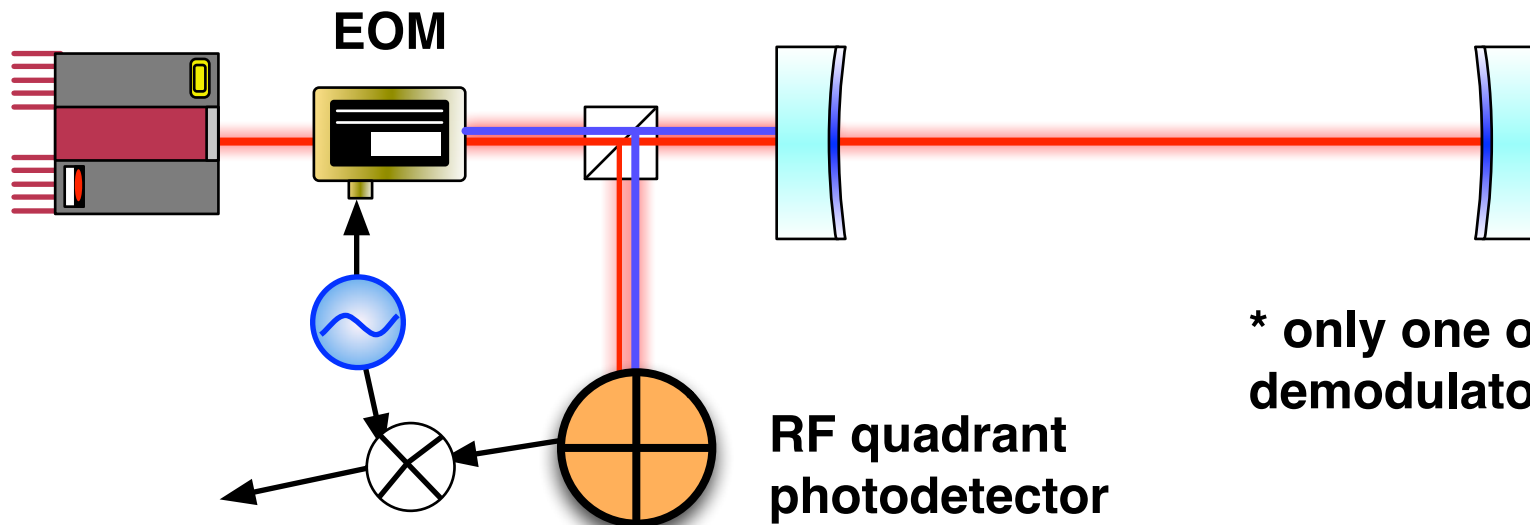

Wave front sensing

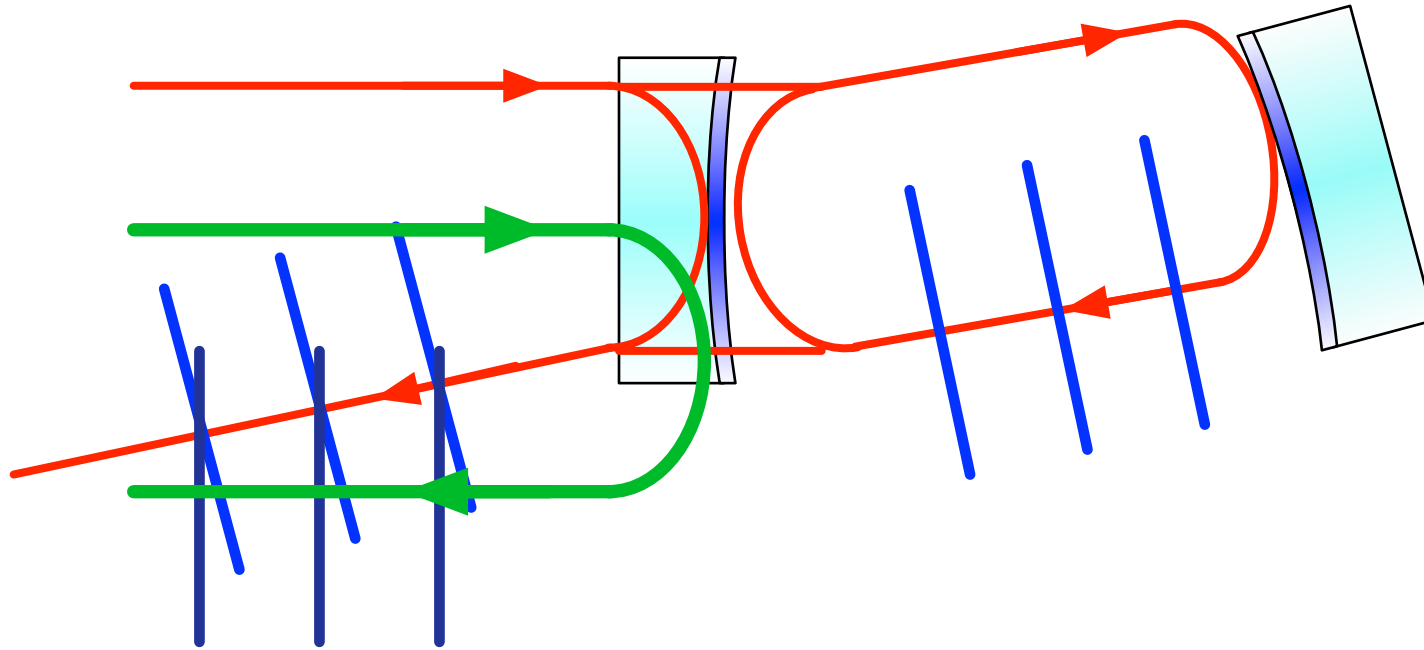

Wave front sensing

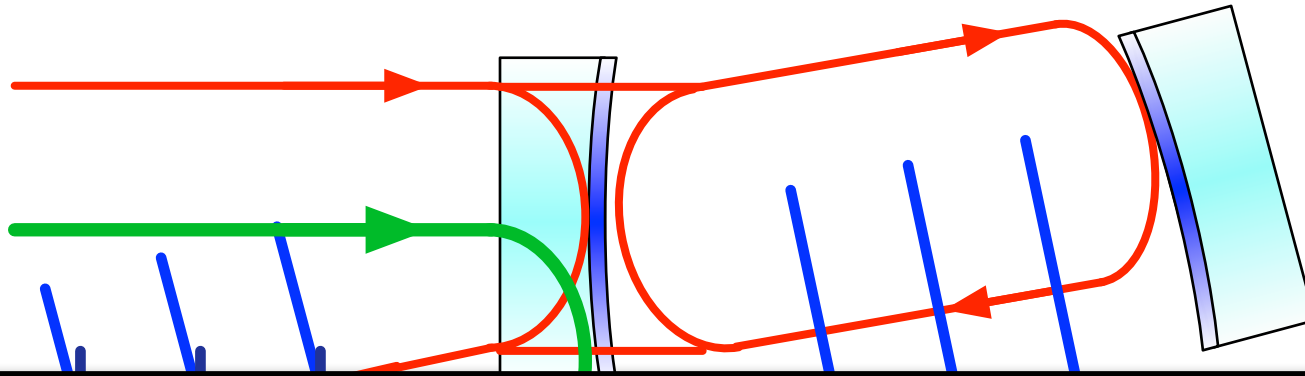

**RF quadrant
photodetector**

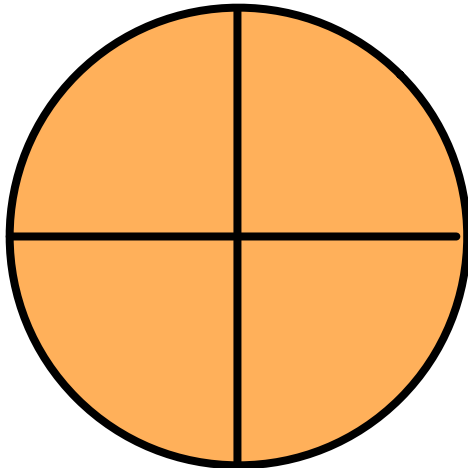

phase advance

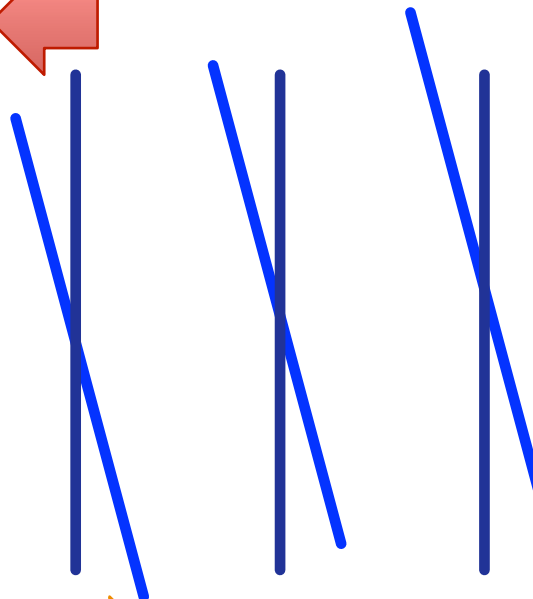

phase retardation

Mathematical treatment

Expansion by the Hermite-Gaussian modes

Reflected field (over simplified)

$$E_{\text{refl}} = E_c + E_{\text{sb}}$$

carrier **RF sidebands** **wave front tilt**

$$E_c = HG_{00}(x, y) + iHG_{01}(x, y)$$

$$E_{\text{sb}} = HG_{00}(x, y)e^{i\omega_{\text{mt}}} + HG_{00}(x, y)e^{-i\omega_{\text{mt}}}$$

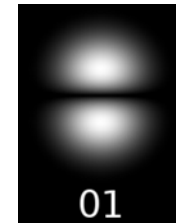
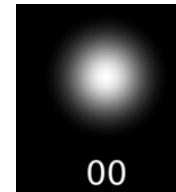

Observed intensity

$$S_j = \int_{\text{j-th segment}} |E_{\text{refl}}|^2 dx dy$$

Extraction of wave front tilt

$$(\text{vertical misalignment}) = S_1 + S_2 - (S_3 + S_4)$$

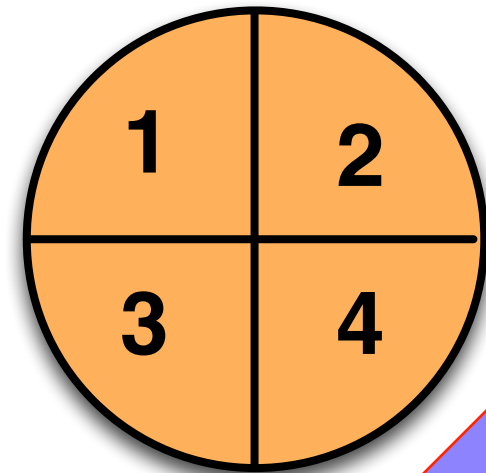

WFS location

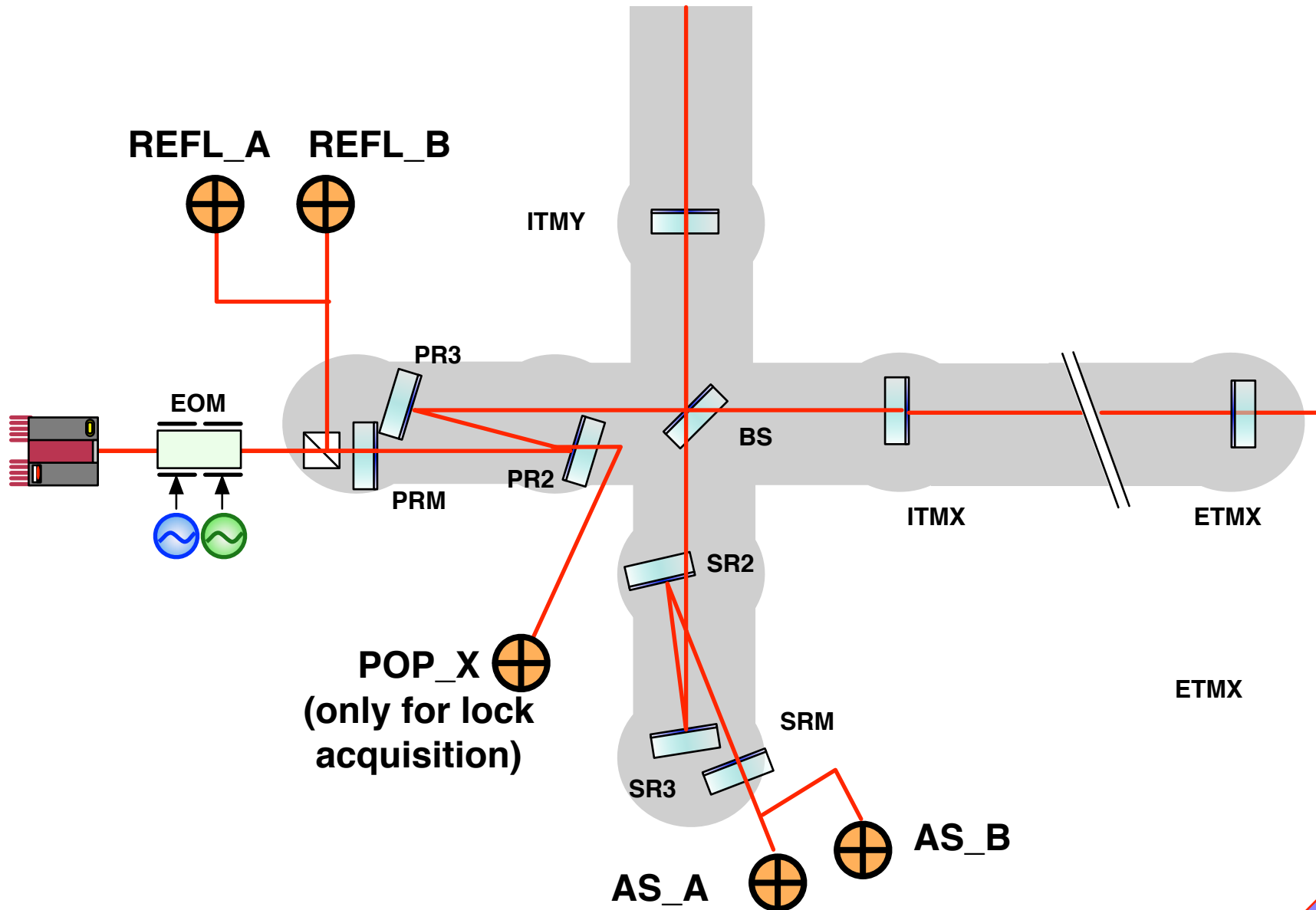

topology (ASC)

- ▣ **ASC signal decomposition is done by linear combination of the WFSs.**
- ▣ **Below is an example from LHO (not up-to-date)**
- ▣ **$\text{REFL_A9I} + \text{REFL_9BI} \Rightarrow \text{IM4}$ (input mirror)**
- ▣ **$0.5 \text{ REFL_A9I} + 0.5 \text{ REFL_9BI}$
 $0.8 \text{ REFL_A45I} + 0.8 \text{ REFL_B45I} \Rightarrow \text{PR3}$ (power recycling cavity)**
- ▣ **$\text{REFL_A9I} + \text{REFL_9BI} \Rightarrow$ common hard (arm cavities)**
- ▣ **$\text{AS_A45Q} \Rightarrow$ differential hard (arm cavities)**
- ▣ **$\text{AS36_AQ} + \text{AS36_BI} \Rightarrow \text{SRM}$ (signal recycling cavity)**
- ▣ **$\text{AS36_BQ} \Rightarrow$ beam splitter**

Beam pointing

Beam pointing (or spot positions) is the other degrees of freedom that can be controlled.

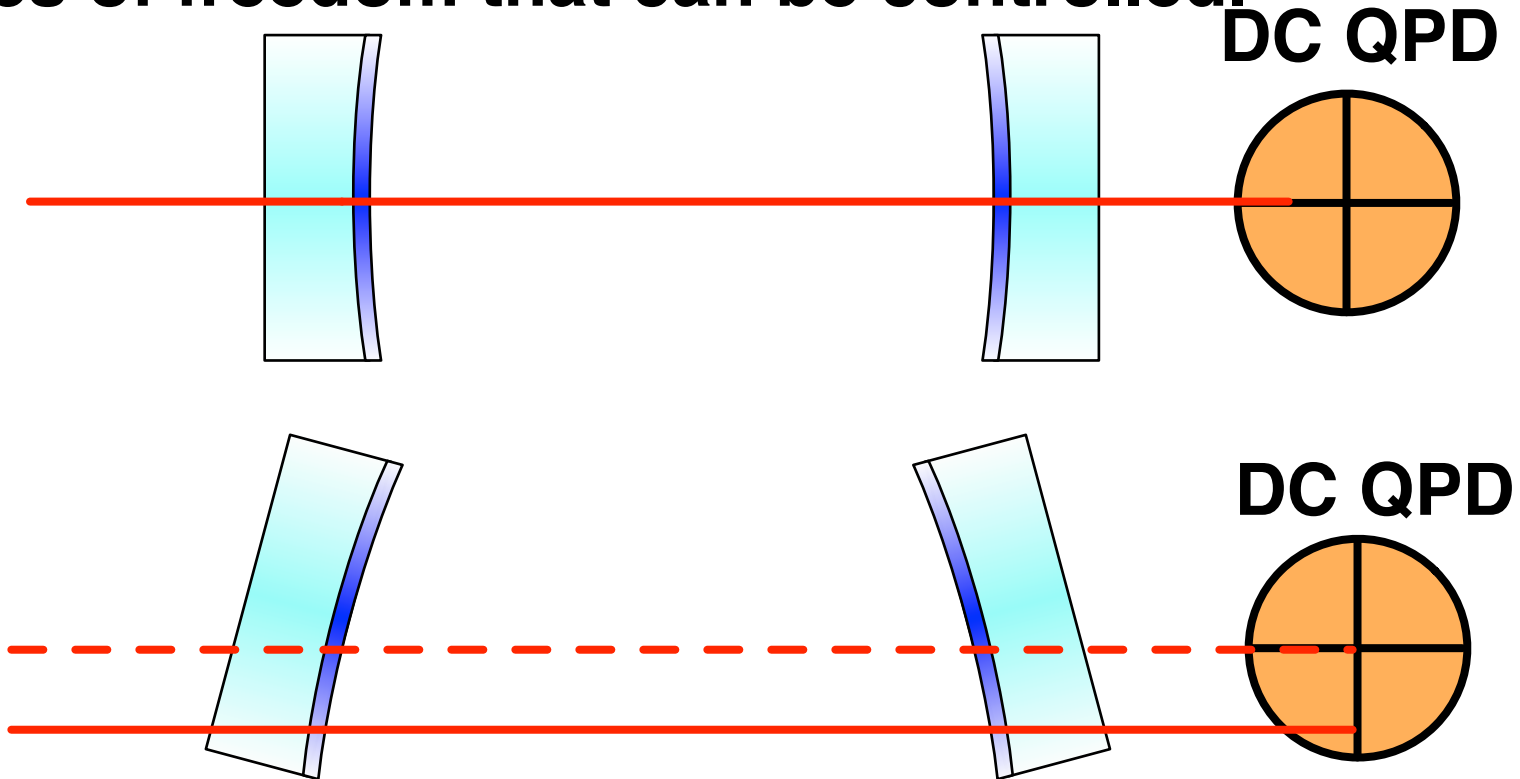

**Different spot positions \Rightarrow different cavity losses
We use DC QPDs and not RF QPDs.**

Pointing control

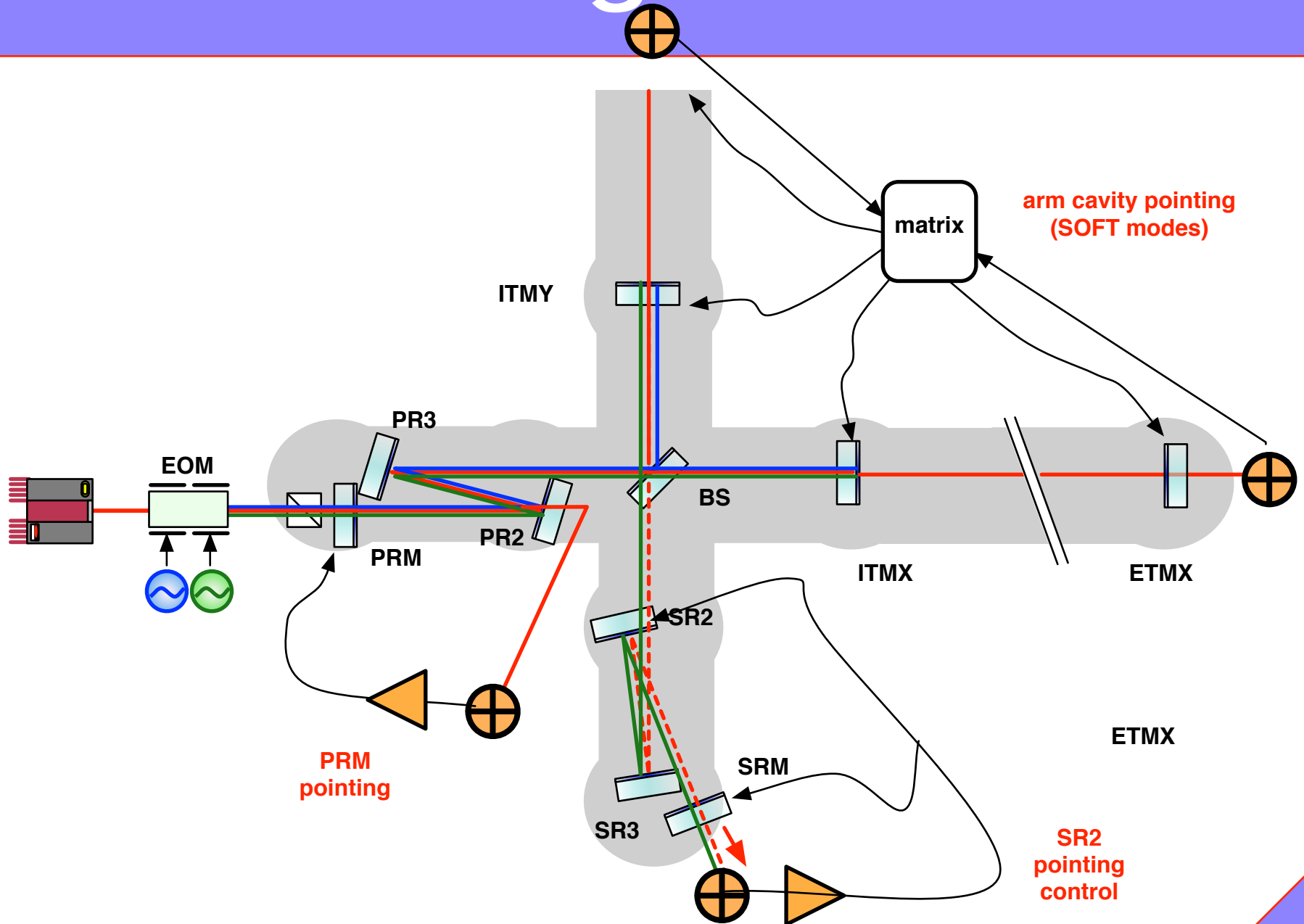

Mode matching control

- The second order HOMs = mode mismatch.
- TCS (Thermal compensation system) is used to compensate for the thermal lensing.

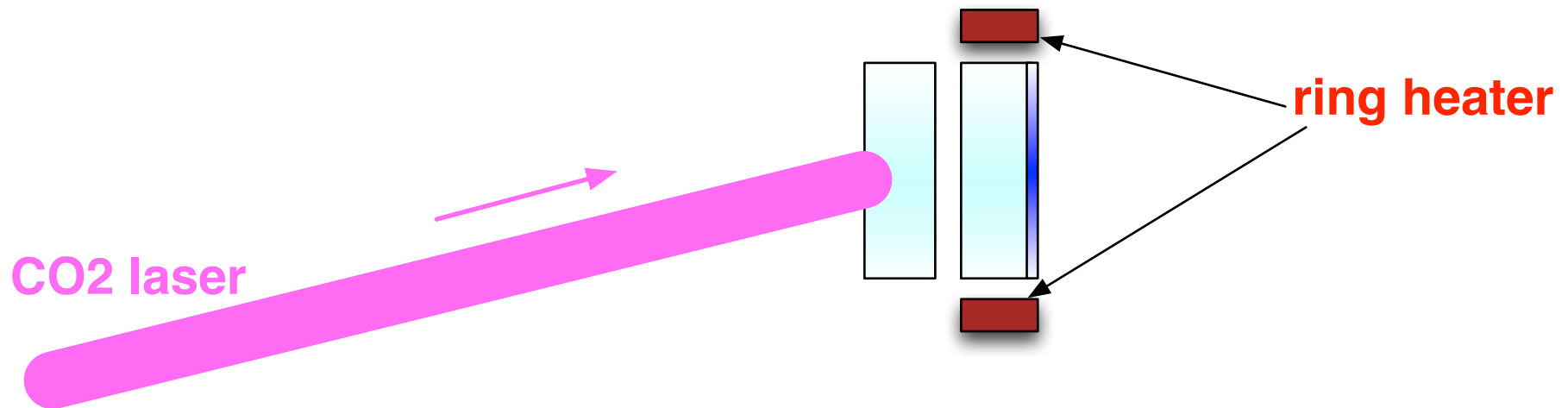

- No feedback system is employed as of now.
- LHO is attempting a feedforward control, based on the laser power we send in.

The talk plan

Part 1:

Review of the aLIGO ISC scheme.

Part 2:

Some difficulties / subtleties

Dark side of ISC

One would think control of LIGO is well established. **Not really!**

There are some subtleties that need further investigations

1. Alignment sensing and control
2. Opto-mechanical instabilities
 - * parametric instabilities.
 - * angular instabilities.
3. SRC mode hop.

Alignment is not easy

❑ **Multiple input and multiple output system.**

* gain hierarchy,

* cross talks,

❑ **Mechanical responses change as function of the circulating laser power due to radiation pressure torque.**

⇒ **Every time changing the laser power, ASC has to be revised and re-tuned.**

❑ **Diagnostic is tedious due to slow bandwidth.**

❑ **Power recycling gain changes as a function of beam pointing.**

Radiation pressure torque

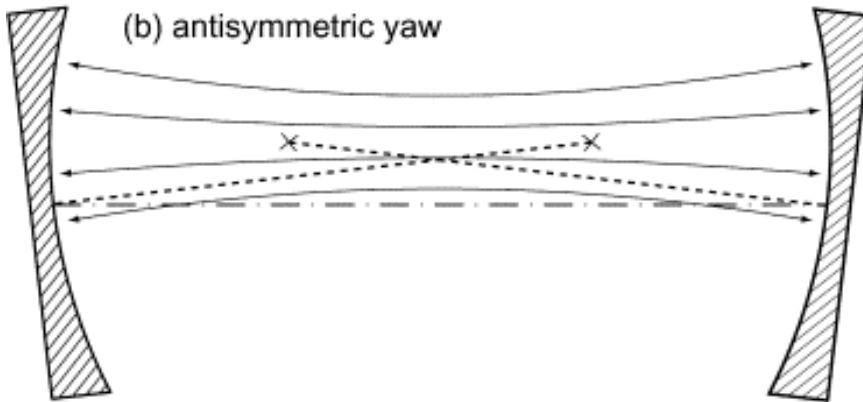
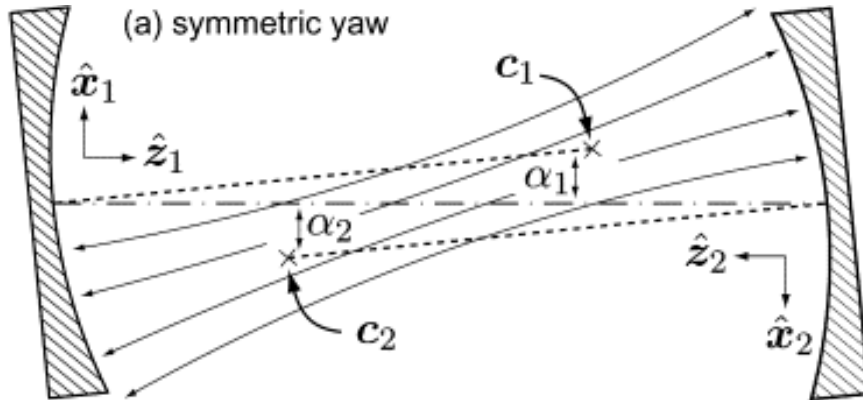

■ Radiation pressure links two test masses (mirrors)

■ The mechanical response gets modified.

■ This complicates the control loop designs.

Radiation pressure torque

Optical torque

$$\begin{bmatrix} \tau_{rp,1} \\ \tau_{rp,2} \end{bmatrix} = \frac{2PL}{c(1-g_1g_2)} \begin{bmatrix} g_2 & 1 \\ 1 & g_1 \end{bmatrix} \begin{bmatrix} \theta_1 \\ \theta_2 \end{bmatrix}$$

g: g-factor, **L**: length.
P: circulating power

Eq. of motion for mirror angle

$$I\ddot{\vec{\theta}} + \gamma\dot{\vec{\theta}} + \kappa_p\vec{\theta} - \underbrace{\frac{2PL}{c(1-g_1g_2)} \begin{bmatrix} g_2 & 1 \\ 1 & g_1 \end{bmatrix}}_{\text{optical torque}} \vec{\theta} = \vec{\tau}_{ext}$$

This causes a normal mode split.

One mode stiffens the mechanical torque (HARD), while the other diminishes it (SOFT).

Alignment control

■ One of the HARD modes (Differential HARD) as an example.

open loop transfer function

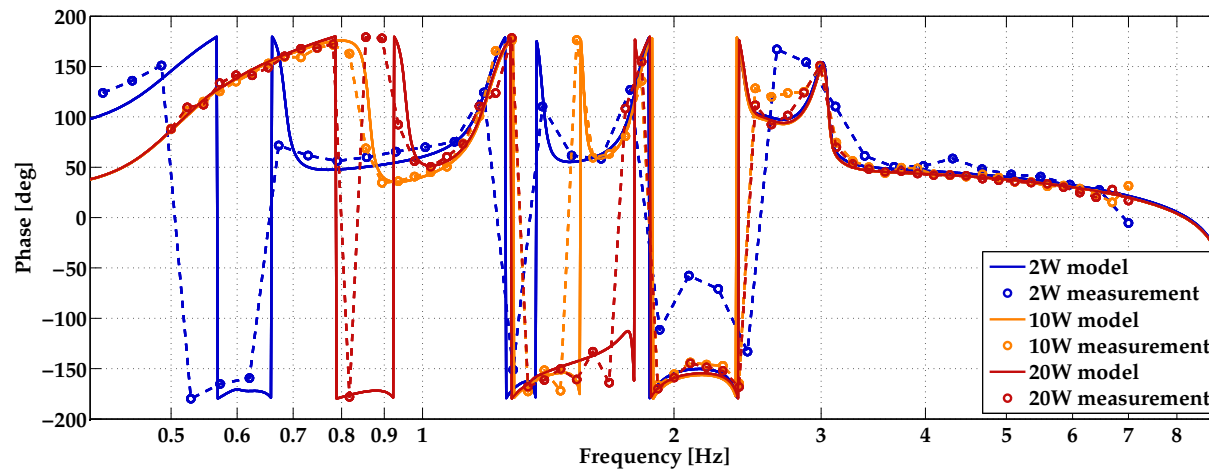
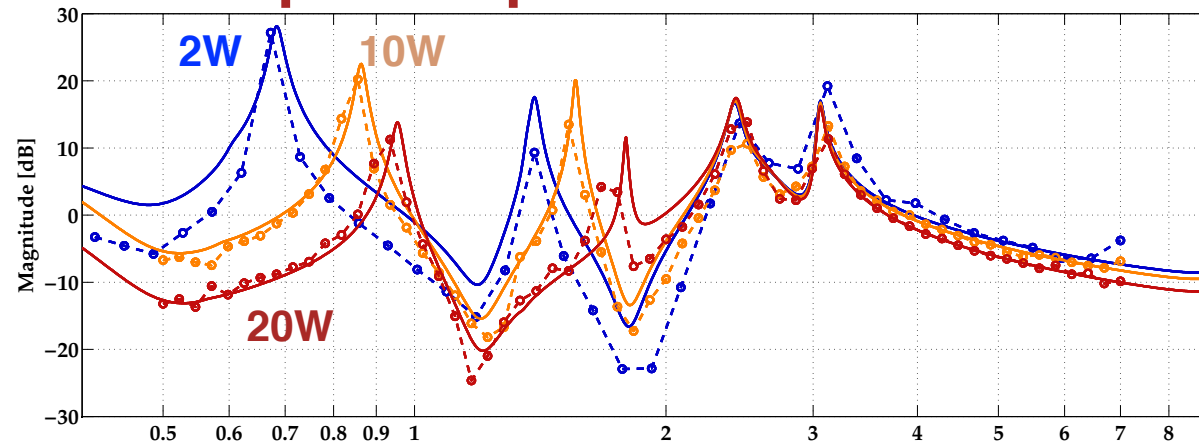

Power recycling gain

- Power recycling gain decreases for unknown reason as we increase the laser power (2 -> 50 W).
- It recovers by changing the beam spot positions. Under investigation.

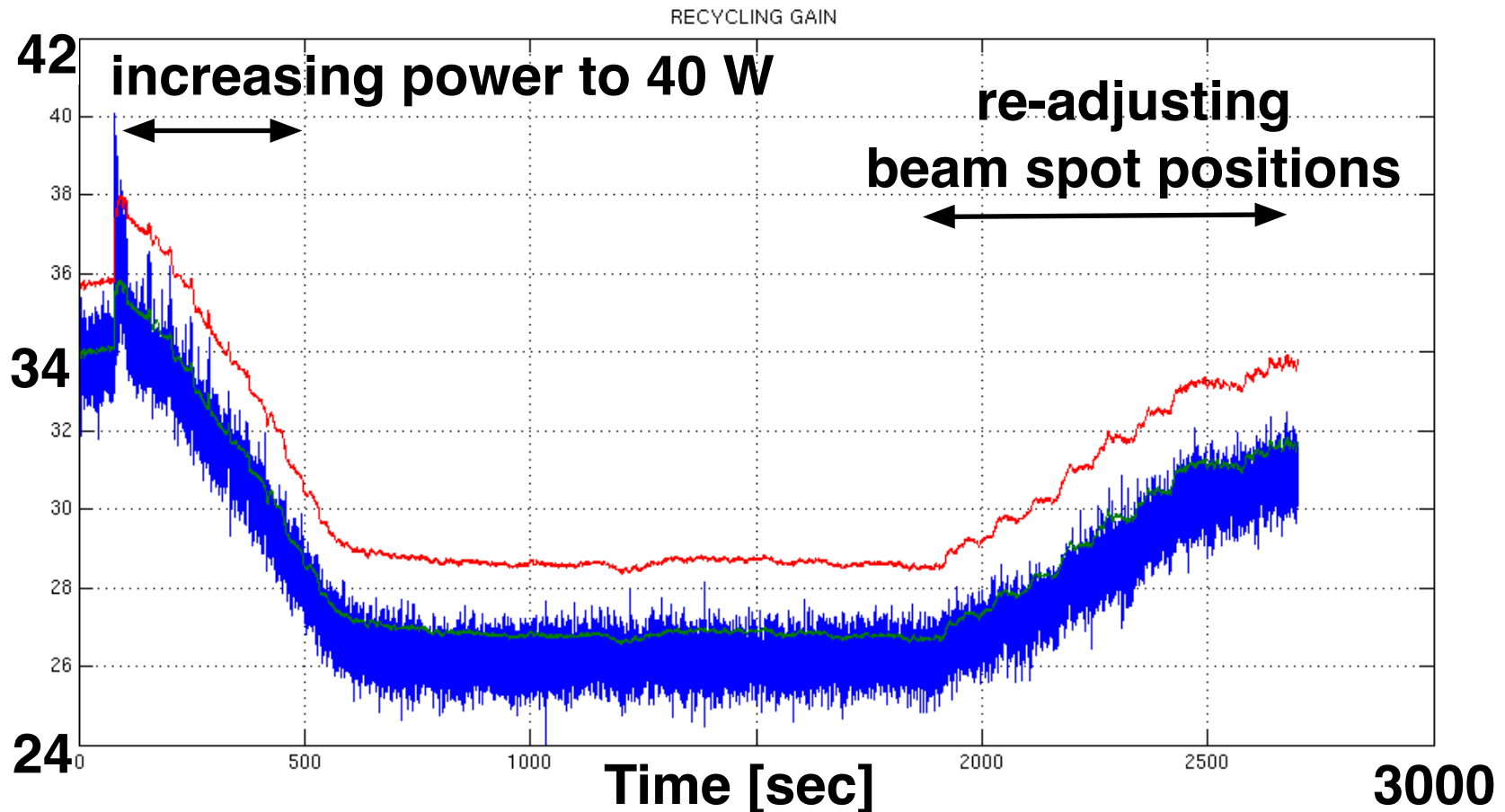

Opto-Mechanical instabilities

Parametric Instabilities

- ▣ Mechanical modes of the test masses couple to particular spatial mode of the laser field [1]
- ▣ Some modes can be unstable (it grows forever)
- ▣ LLO first saw an unstable mode at 25 W [2] and then LHO as well.

▣ An active damping is being commissioned.

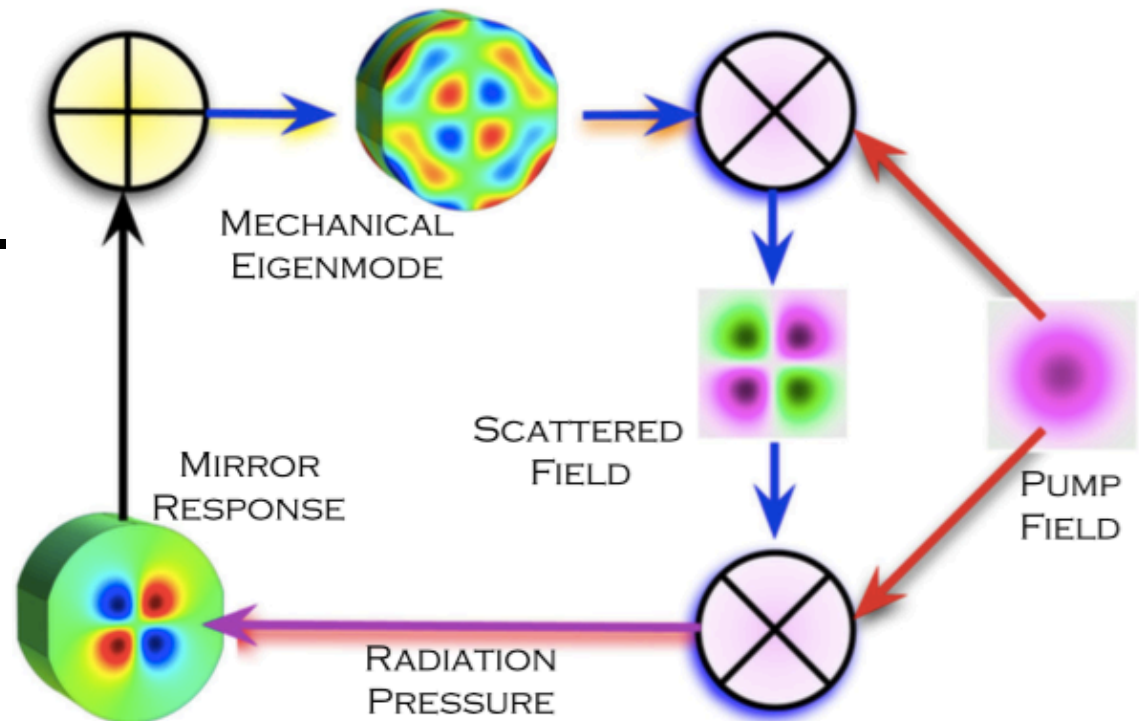

- [1] M.Evans et al., Phys.Letters A, 374 665 (2010)
- [2] M.Evans et al., arXiv:1502.06058 (2015)
- [3] J.Miller et al., Phys.Letters A, 375 3 788 (2010)

R.X.Adhikari, Rev Mod Phys 86(1) 121 (2014)

How many modes to expect?

32 modes in the worst case.

What is the best strategy?

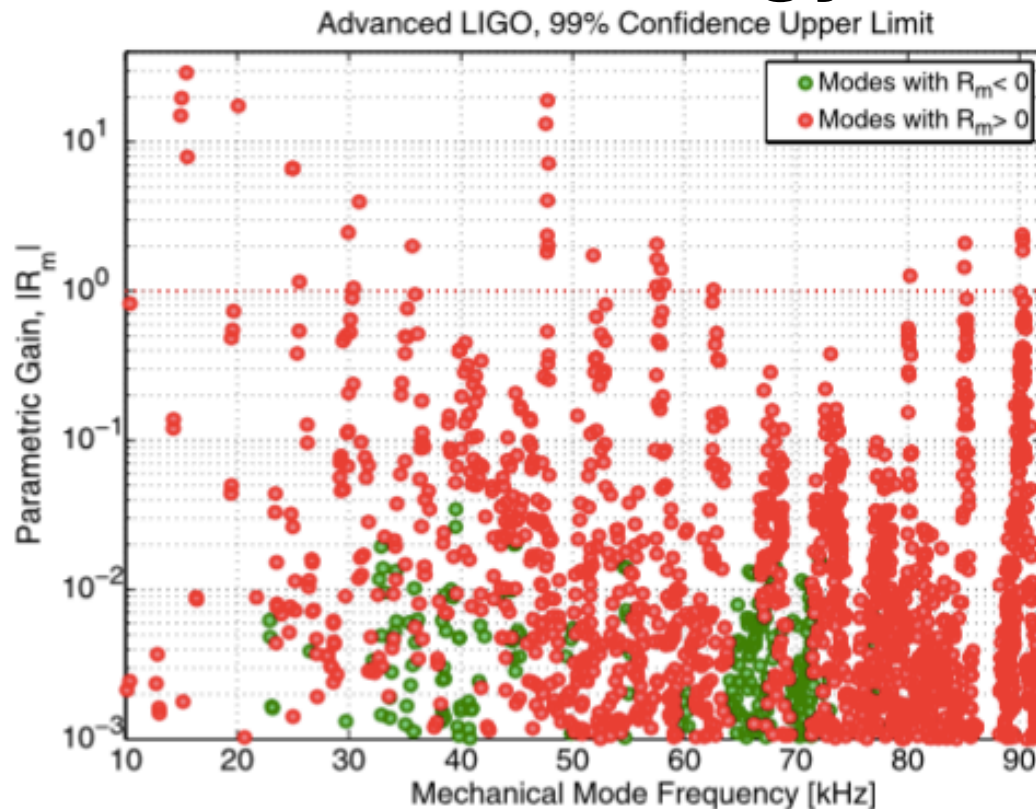
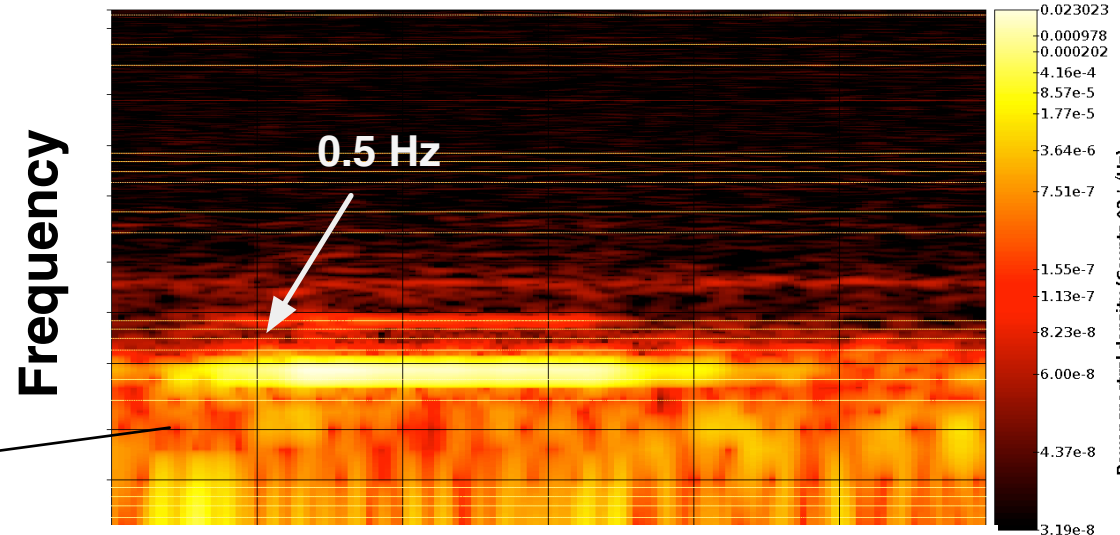
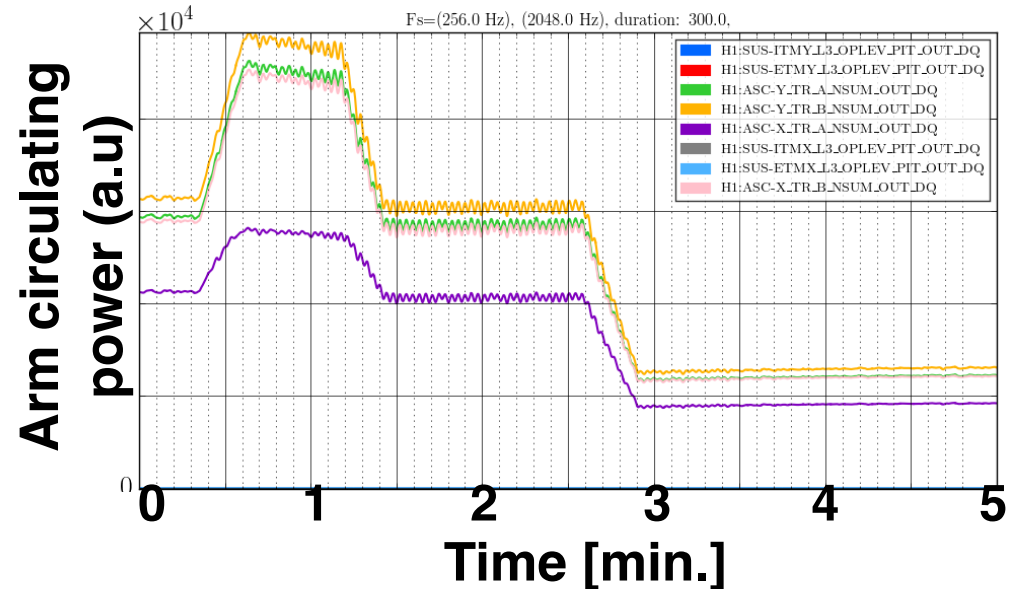

Fig. 9. Worst case parametric gain for all modes of an Advanced LIGO test-mass between 10 kHz and 90 kHz. There are 32 potentially unstable modes, and more than 200 modes with $\mathcal{R}_m > 0.1$.

Angular instability

- Hanford has seen an instability driven by radiation pressure.
- The instability caused lockless many times.
- Being addressed by a new arm power stabilization control.



Spectrogram of angle of a test mass (ITMY)

Instability in Cartoon

angle to
cavity power
coupling

$$\frac{\partial P}{\partial \theta}$$

radiation
pressure
force

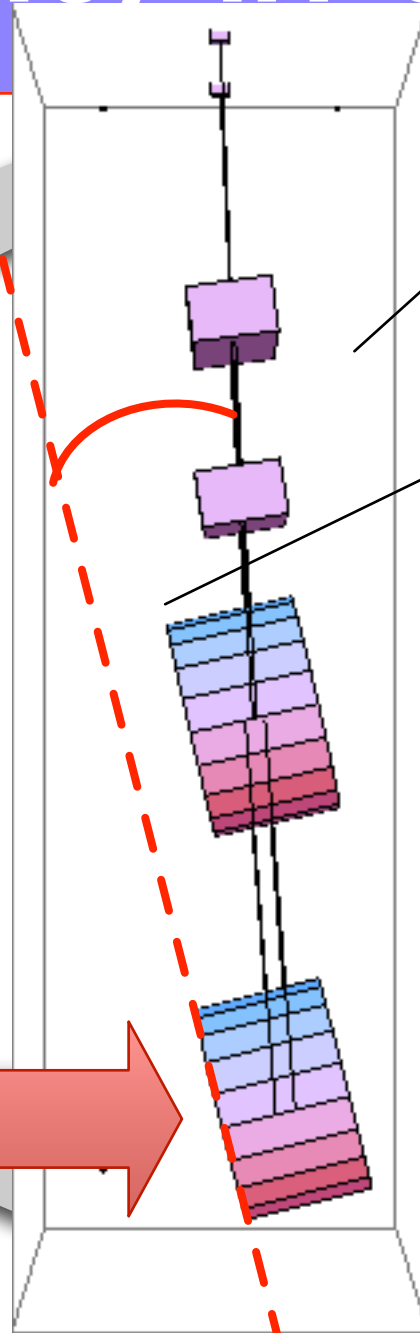

Quad. sus.

θ

$$\frac{\partial \theta}{\partial F}$$

force
to angle
coupling

Possible mitigations

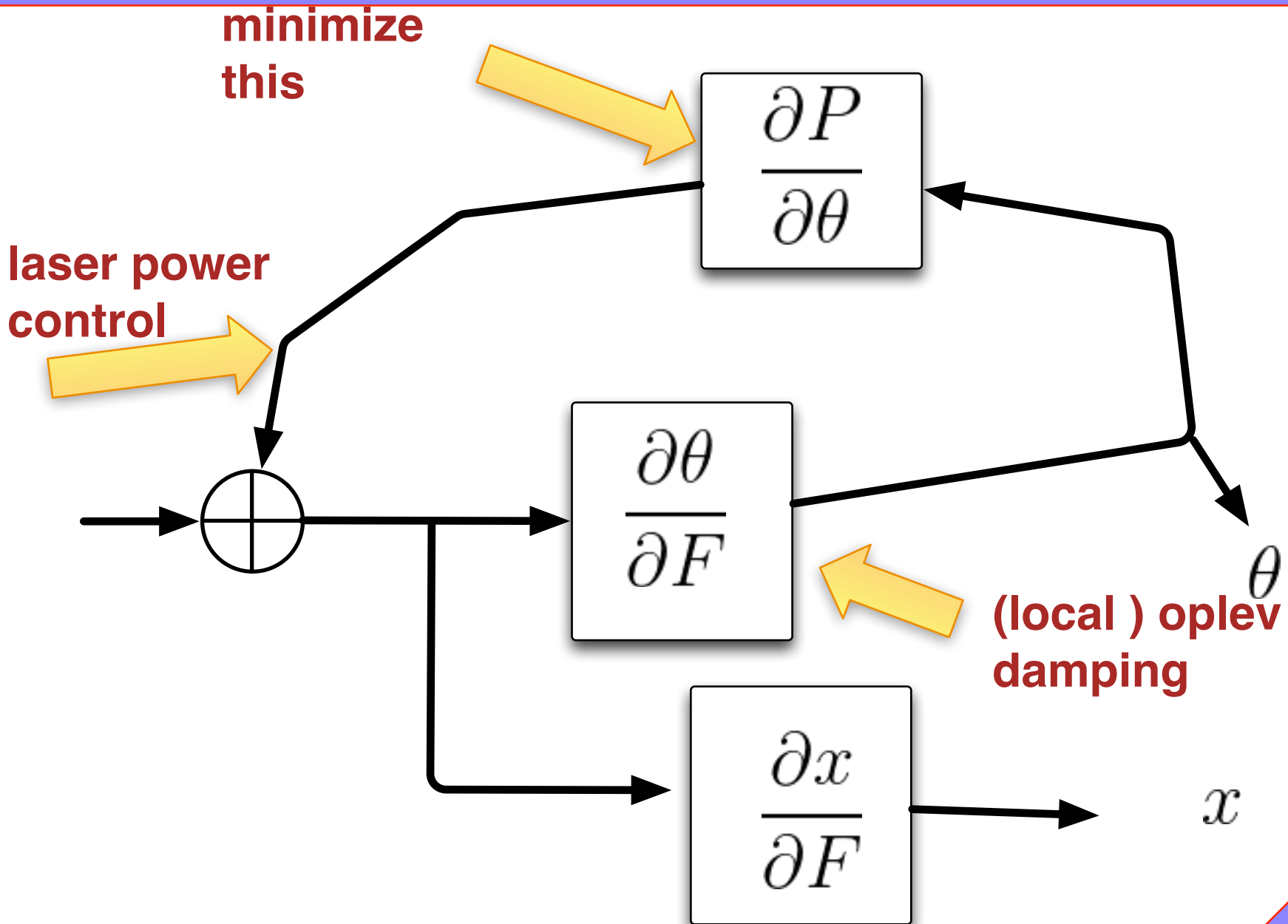

Mode hop

https://alog.ligo-wa.caltech.edu/aLOG/uploads/14508_20141017190858_AS_hopping.avi

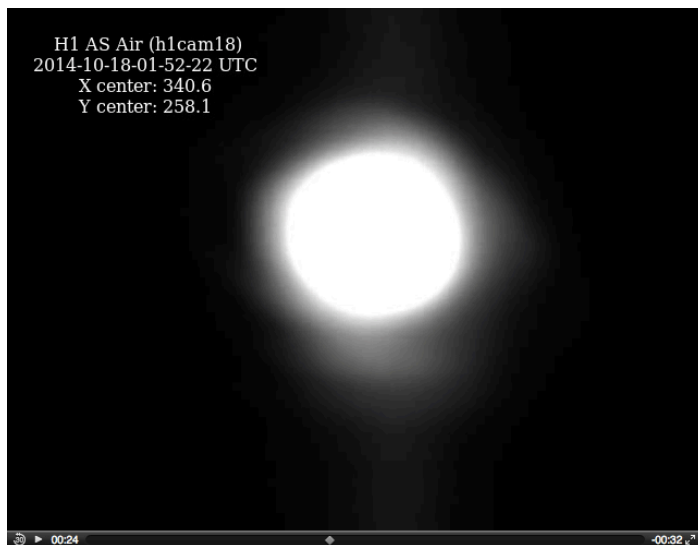

ideal mode

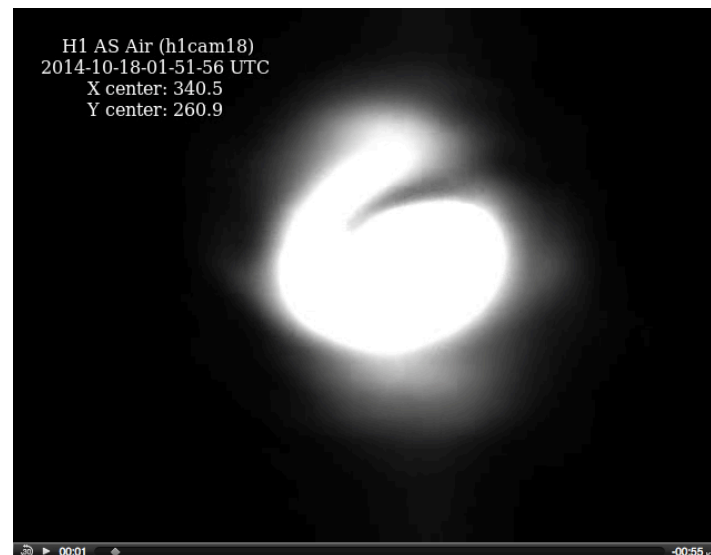
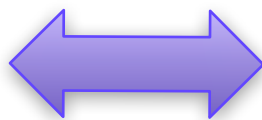

wrong mode

Simulation

REFL 45 I [W-ish]

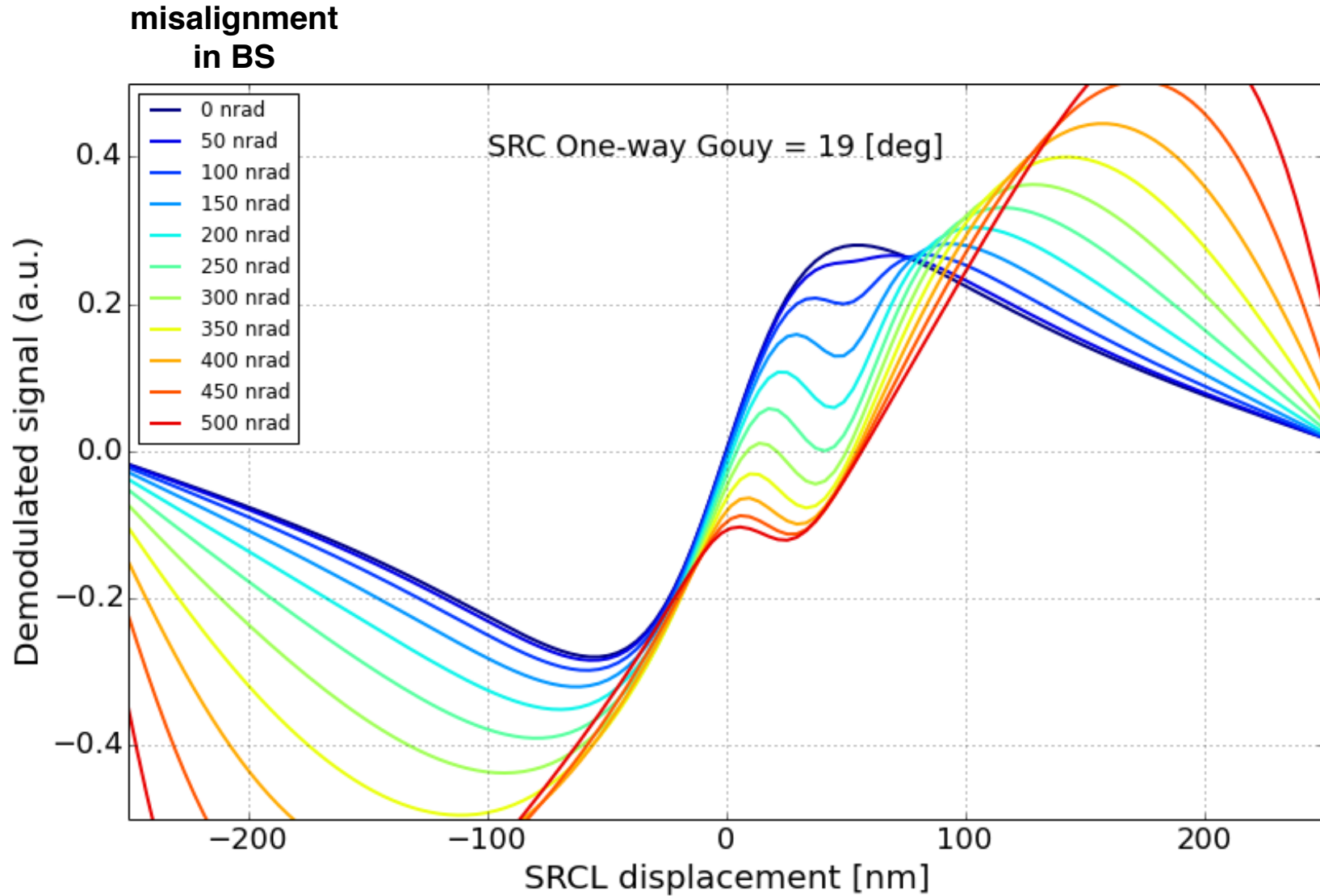

Some notes

★ **A mitigation**

Addition of an artificial offset to error point.

= > It pushes the operating point further away from the secondary zero crossing.

★ **A long standing mystery**

This has been seen only at LHO.

=> recently LLO started seeing a similar effect.

=> indication of curvature difference?

★ **Should we redesign SRC Gouy-phase?**

To make the SRCL less sensitive to alignment?

some comments on LIGO-India ISC

Some (random) thoughts

- **Hardware are identical.**
- **Simulations, measurement tools (scripts) need some more man power.**
- **Control scheme/topology is established.**
No need to explore?
- **Some instabilities are already known and addressed.**
- **But be prepared -- ISC is often an iterative process.**

It is users

- ▣ **Hardware and software require knowledgeable users.**
- ▣ **It is the users (commissioners) who pushes the commissioning activities and not hardware or software.**
- ▣ **Getting some students/postdocs trained at the LIGO sites is always a good idea.**
- ▣ **Also, a prototype interferometer in India may be a good training place, if made somewhat similar to LIGO.**

Summary

- **Interferometer control is essential to keep the high sensitivity.**
 - **Length and angular control are important for maintaining resonance.**
 - **Opto-mechanical instabilities need some attention as we go higher power.**
 - **No show-stopper so far.**
- Some site-specific problems might happen.**

Control topology (common)

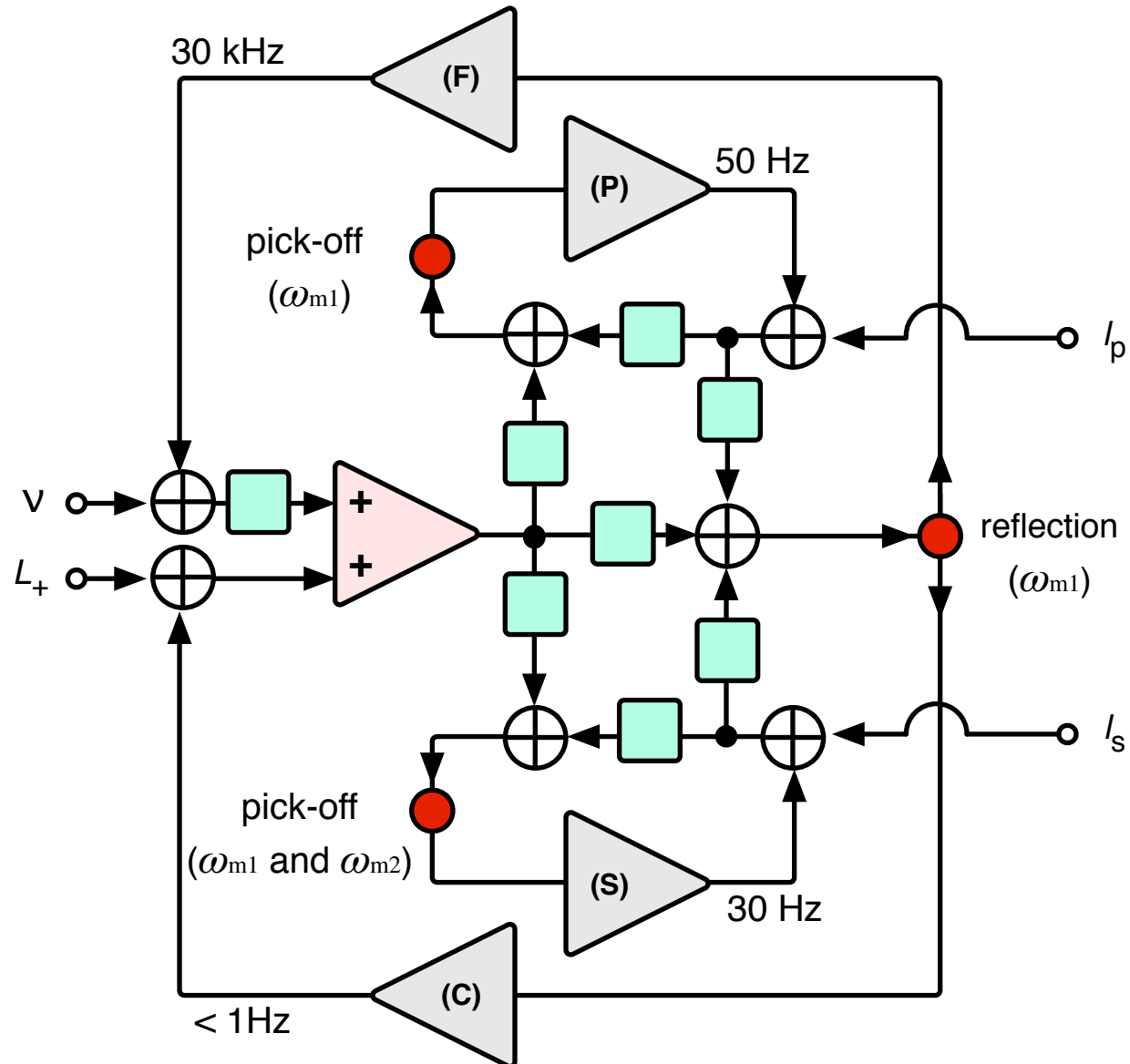

Control topology (diff.)

