

# LIGO/VIRGO Earthquake studies and controls configuration

## GWADW 2015 – Controls Workshop

G1500652

May 20, 2015

Sebastien Biscans, Michael Coughlin, Paolo Ruggi, Jan Harms,  
Fabrice Matichard, Richard Mittleman

- MAX
- MEAN
- MIN

Trend from 15-05-02-06-59-44 to 15-05-11-17-24-44

Ch 3: H1:ISI-ETMX\_ST1\_WD\_MON\_STATE\_IN1\_DQ

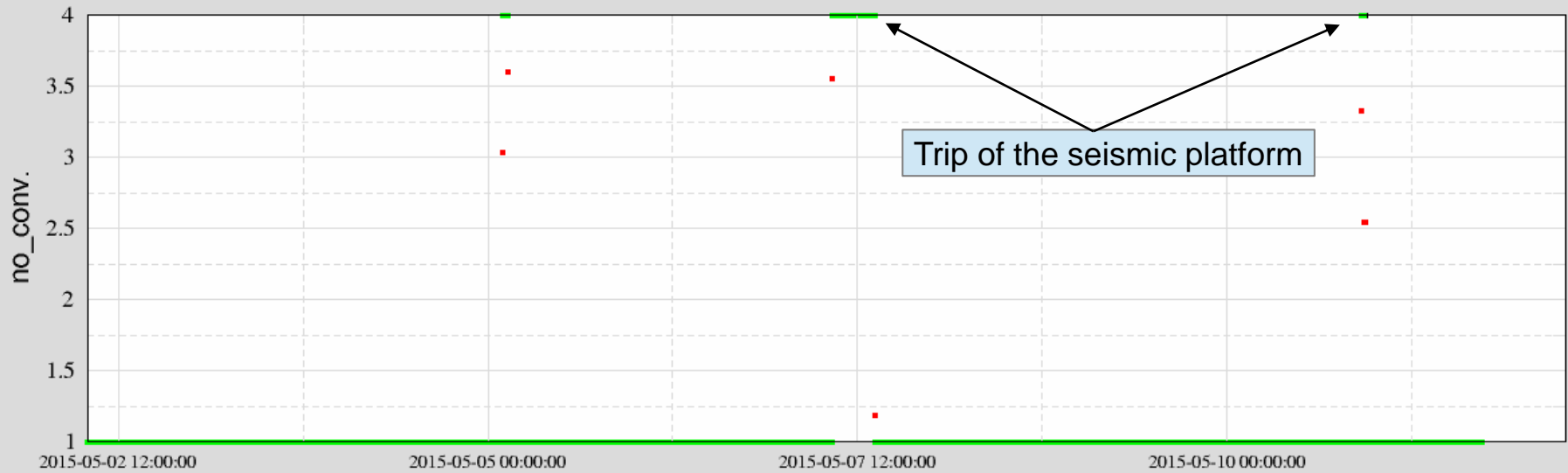

Ch 1: H1:PEM-EX\_SEIS\_VEA\_FLOOR\_X\_BLRMS\_30MHZ100

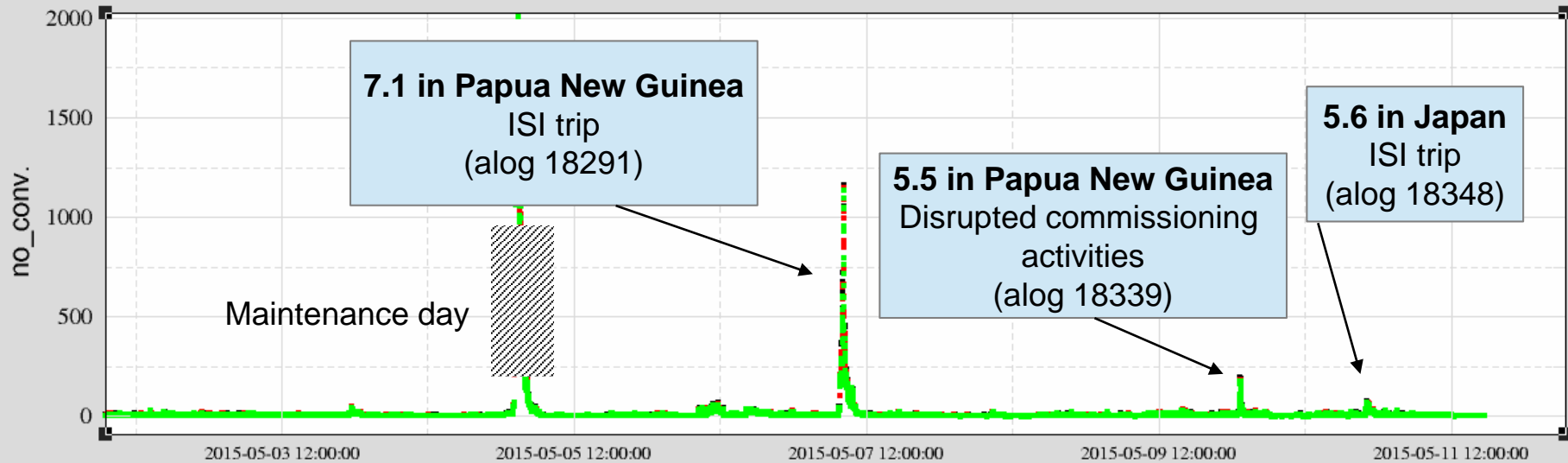

- LIGO → 3 earthquakes related issues in 10 random days.
  - VIRGO → “Couples of unlocks per week” according to commissioners.
  - Earthquakes change the ground motion behavior, disrupt commissioning activities
- **it is an issue**

#### I. Earthquake characterization

- a) Tonga Earthquake (June 2014)
- b) Tilt or no tilt? (Nicaragua, October 2014)

#### II. Seismic platform behavior during earthquakes

#### III. Strategy

- a) Earthquake monitor
- b) Possible controls configurations

#### IV. Future/Conclusion

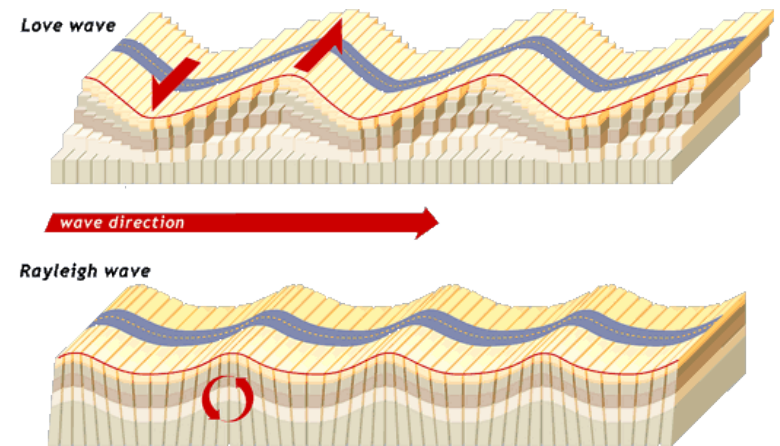
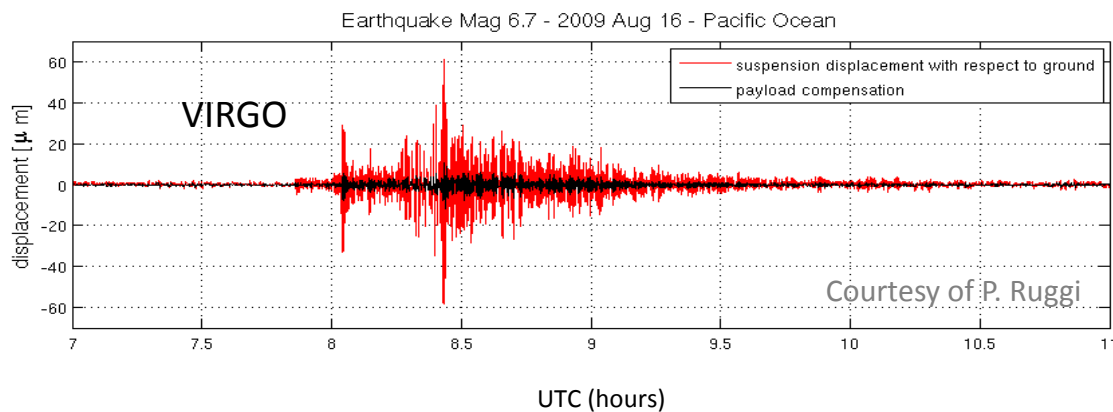
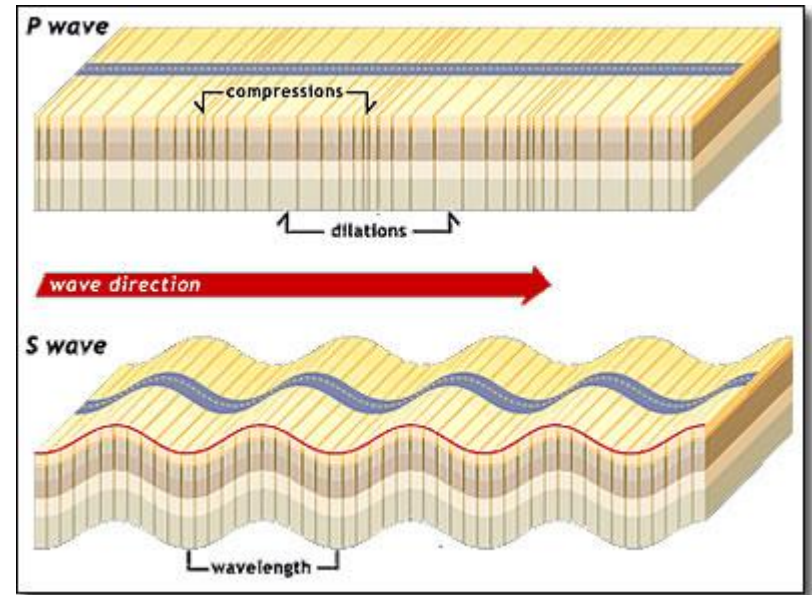
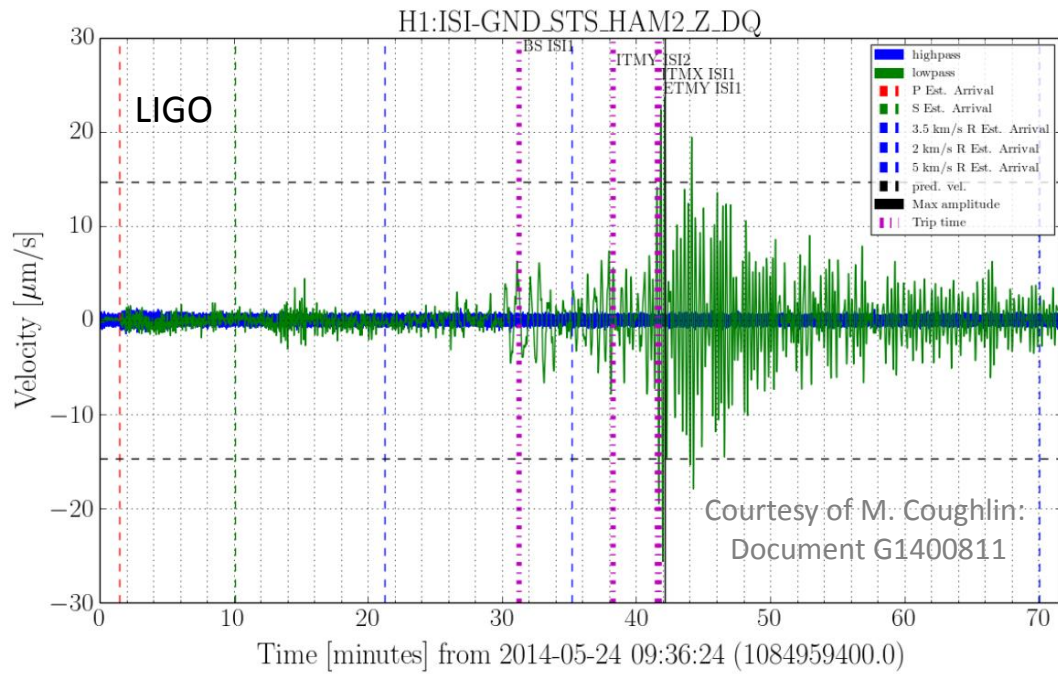

## 1. Similar ground behavior LIGO/VIRGO

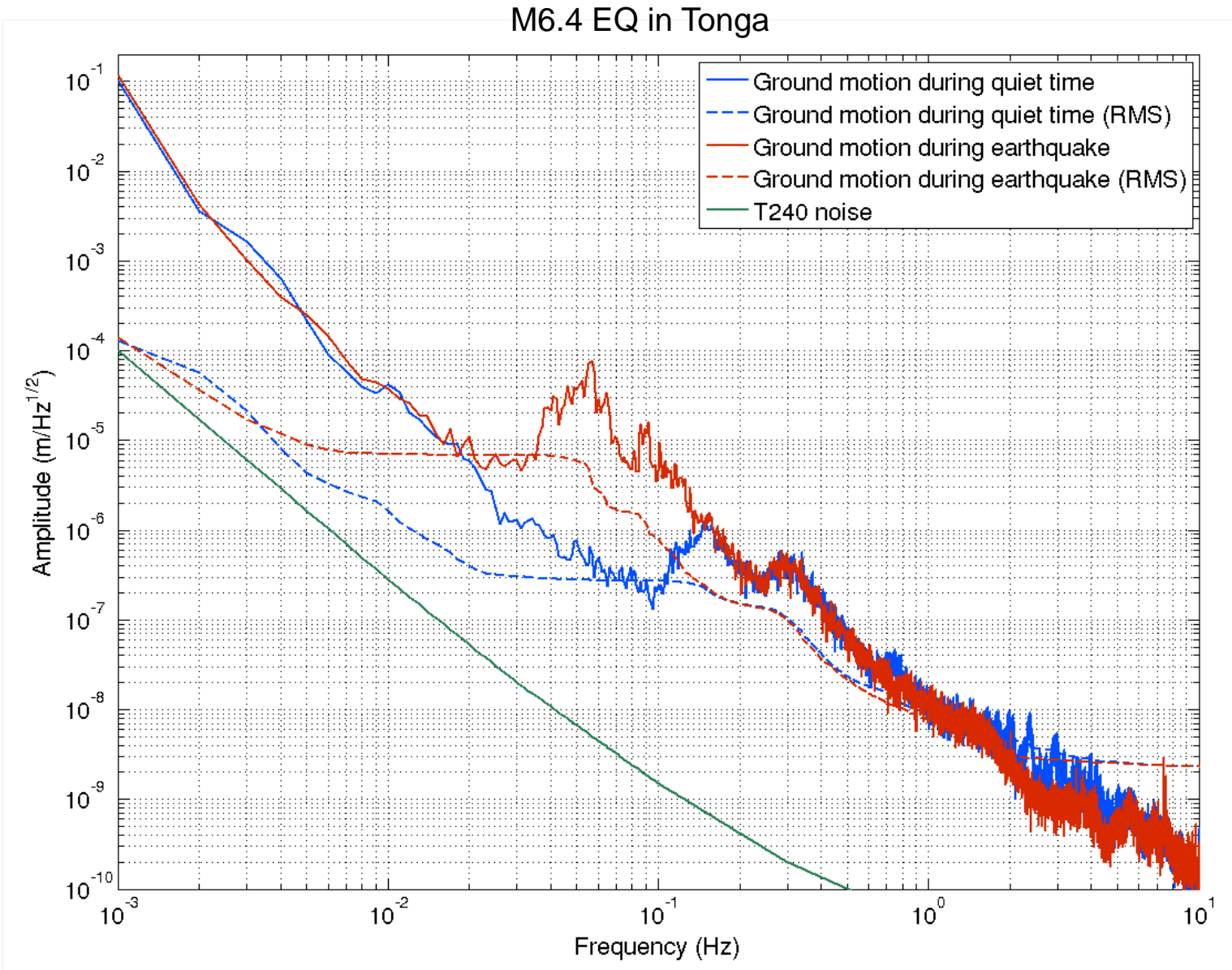

2. Amplification of the ground motion by a factor of  $\sim 100$  below 150mHz

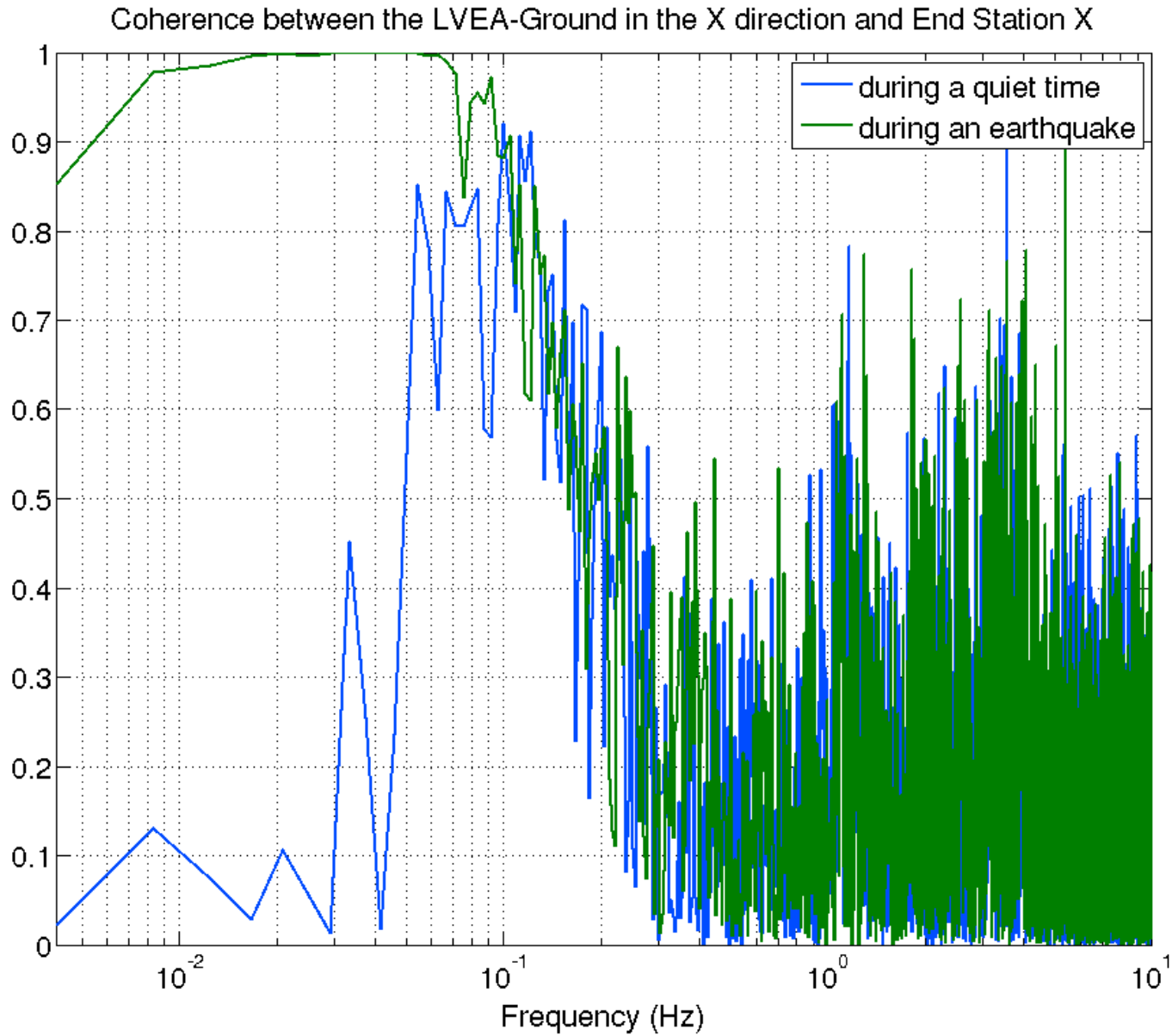

### 3. Common amplification between the stations

## M6.4 EQ in Tonga

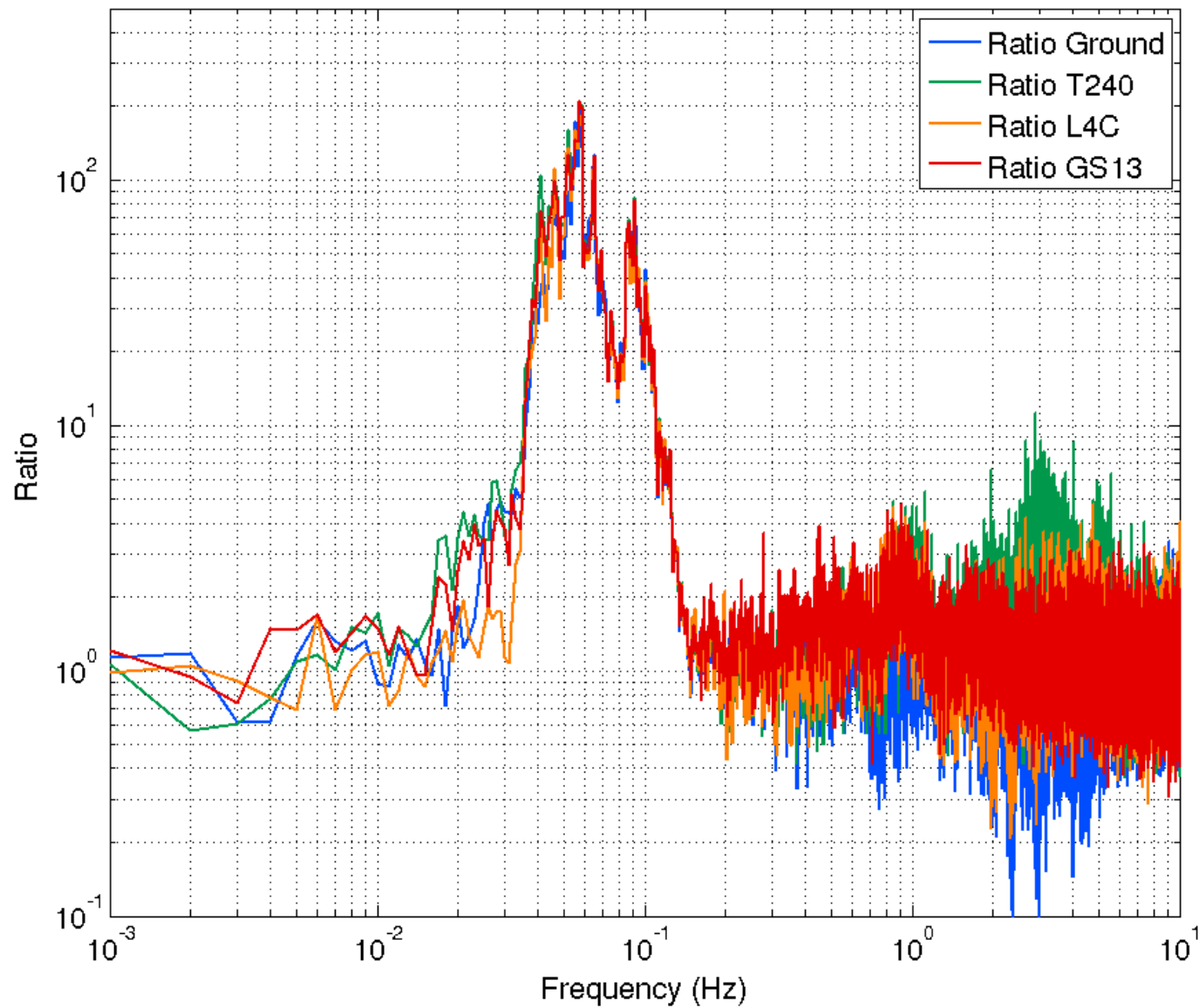

4. Same amplification seen on the platform. The platform is linear.

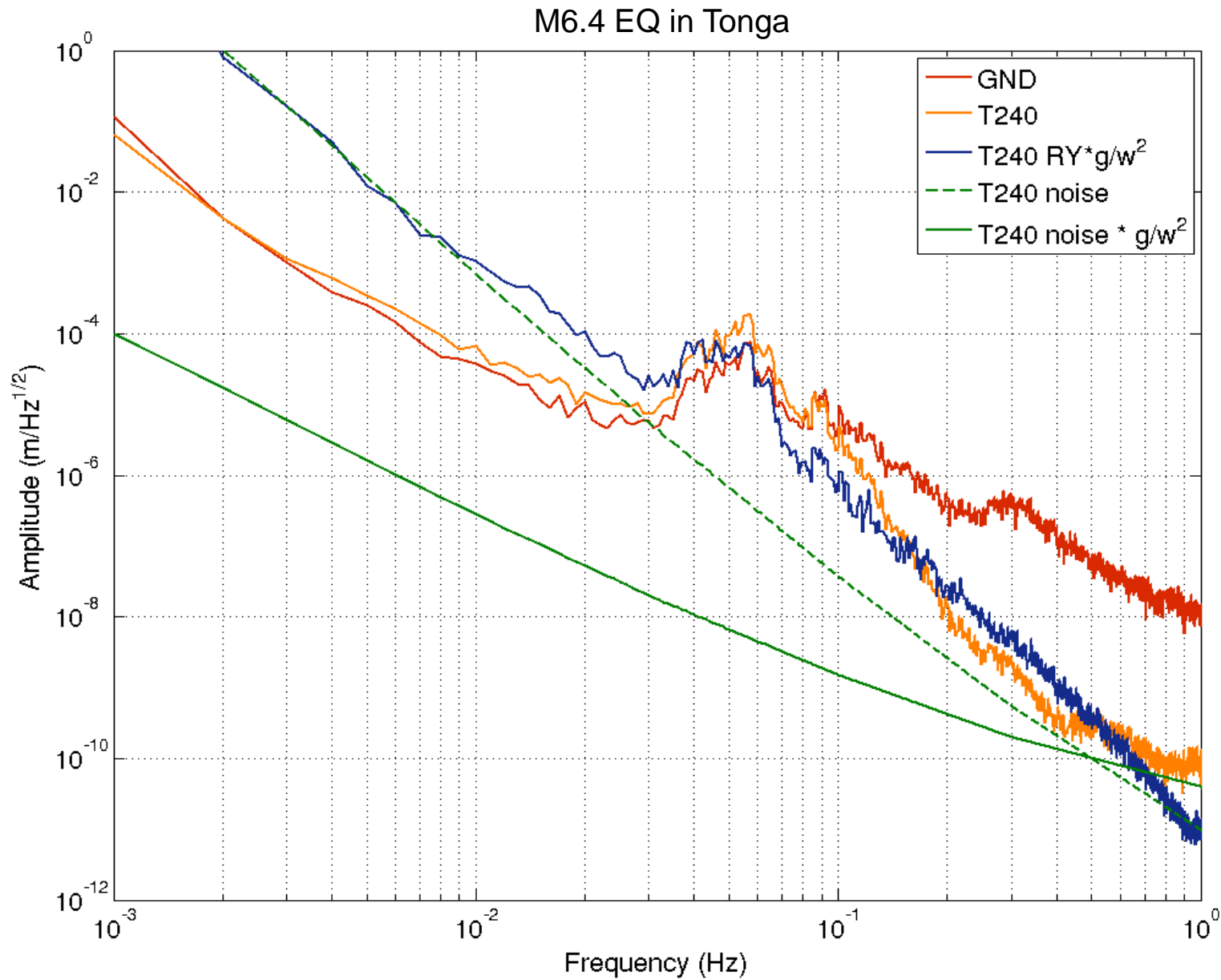

5a. A fair fraction of the amplification is induced by tilt



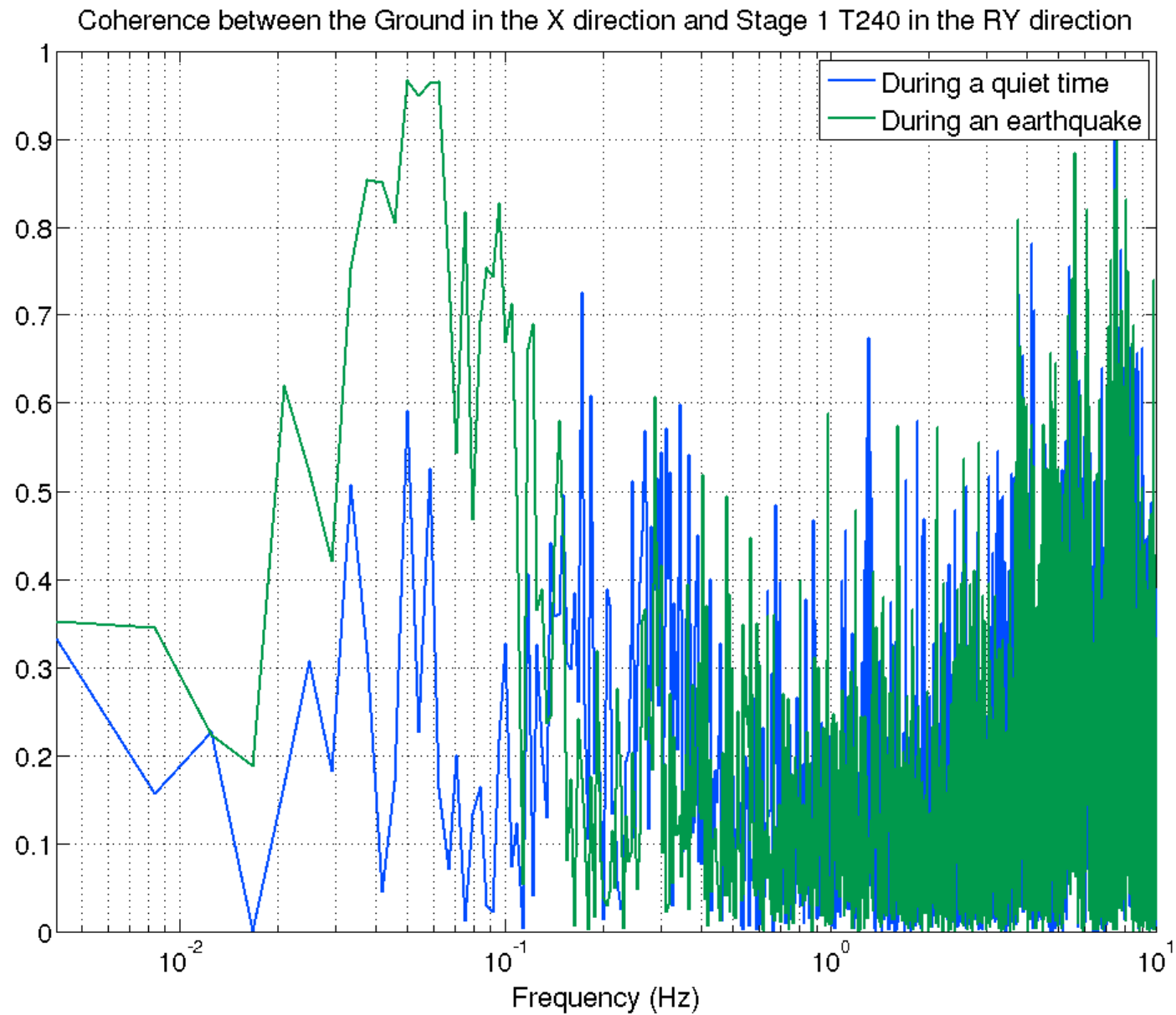

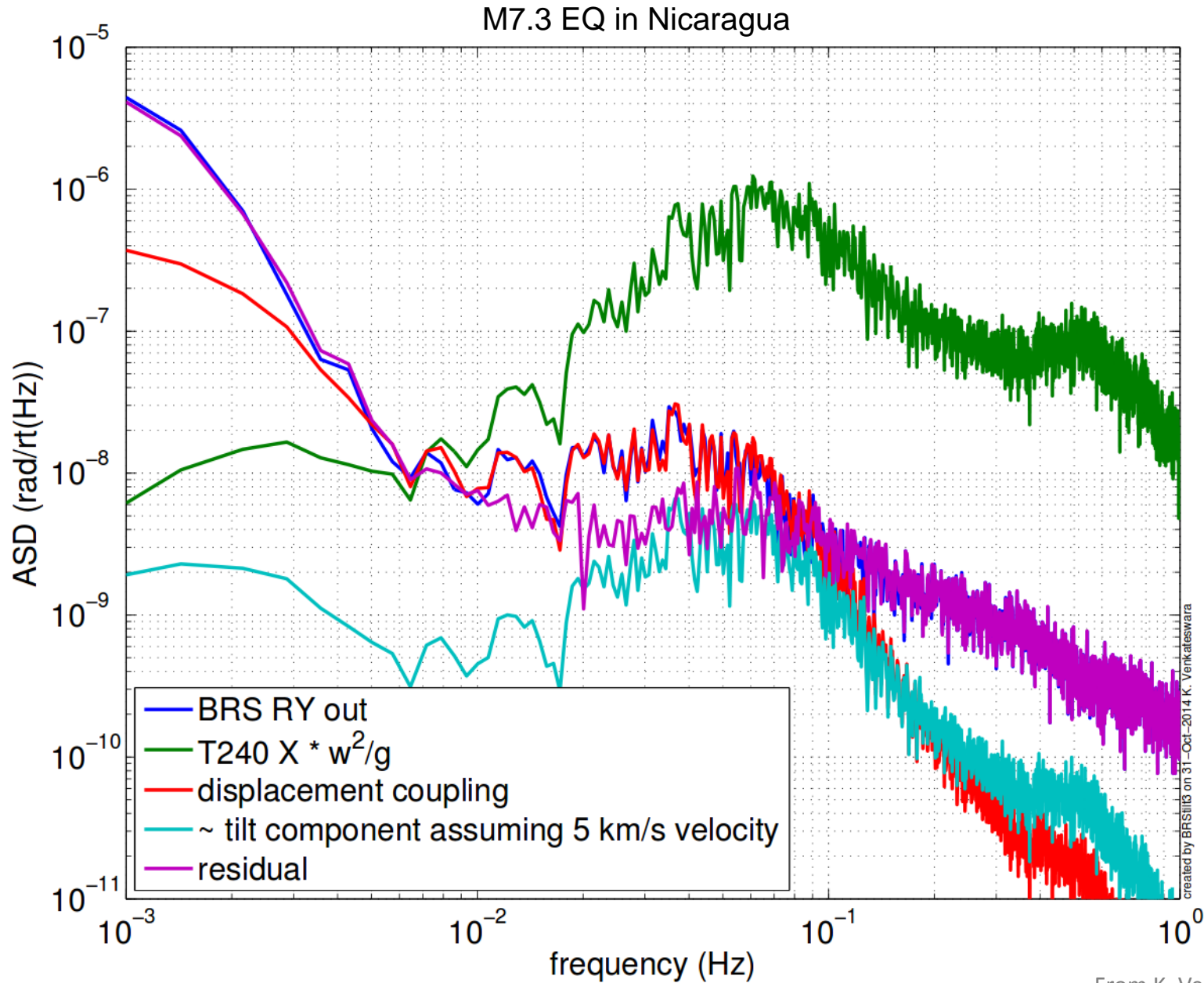

From K. Venkateswara:  
alog 14766

5b. Earthquake creates pure translation

### Earthquake characterization:

- Similar behavior LIGO/VIRGO
- Amplification of the ground motion below 150mHz
- The seismic platforms follow the ground at those frequencies
- Unclear if the motion created by earthquakes is mostly tilt or translation (depends on the earthquakes?). More analysis work needed.

### Consequences:

- The seismic platforms are most likely to trip
- Platform trips occur on S-wave arrivals, or a combination of S-waves and surface waves
- Trips are almost always actuator based (**horizontal direction**)

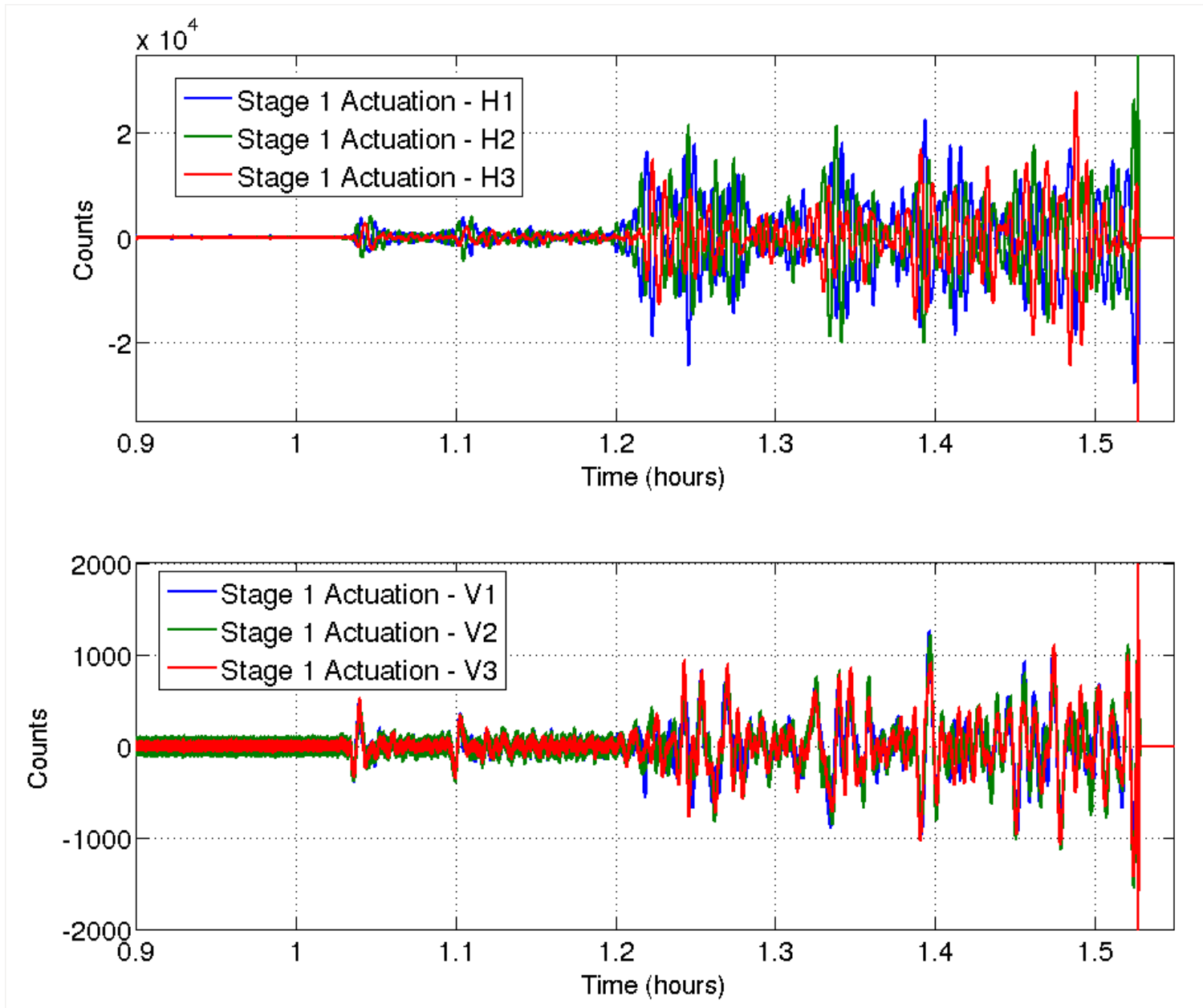

~30 minutes between the beginning of the EQ and the trip → time for reaction!

- Earthquake monitor developed by J. Harms and M. Coughlin.
- Developed in python.
- Two purposes:
  - estimate the arrival time of P-waves and S-waves
  - estimate the maximum amplitude of the event
- Estimate arrival times based on preliminary reference earth models (PREM)<sup>(1)</sup>
- Precision of 1-2 seconds
- Estimate amplitude based on experimental results (data from LHO during S5)
- Ended up with a 'semi-physical' equation that works for LHO

(1) Dziewonski, Adam M., and Don L. Anderson. "Preliminary reference Earth model." *Physics of the earth and planetary interiors* 25.4 (1981): 297-356.

- Using equation (1), can predict the amplitude of an event by a factor of 4 (outliers are data issues)

# M = magnitude  
 # r = distance [km]  
 # h = depth [km]

# Rf0 = Rf amplitude parameter  
 # Rfs = exponent of power law for f-dependent Rf amplitude  
 # Q0 = Q-value of Earth for Rf waves at 1Hz  
 # Qs = exponent of power law for f-dependent Q  
 # cd = speed parameter for surface coupling [km/s]  
 # ch = speed parameter for horizontal propagation [km/s]  
 # rs

#  $\exp(-2\pi h \cdot fc / cd)$ , coupling of source to surface waves  
 #  $\exp(-2\pi r \cdot fc / ch / Q)$ , dissipation

$fc = 10^{(2.3-M/2)}$   
 $Q = Q0 / (fc^{Qs})$   
 $Af = Rf0 / (fc^{Rfs})$

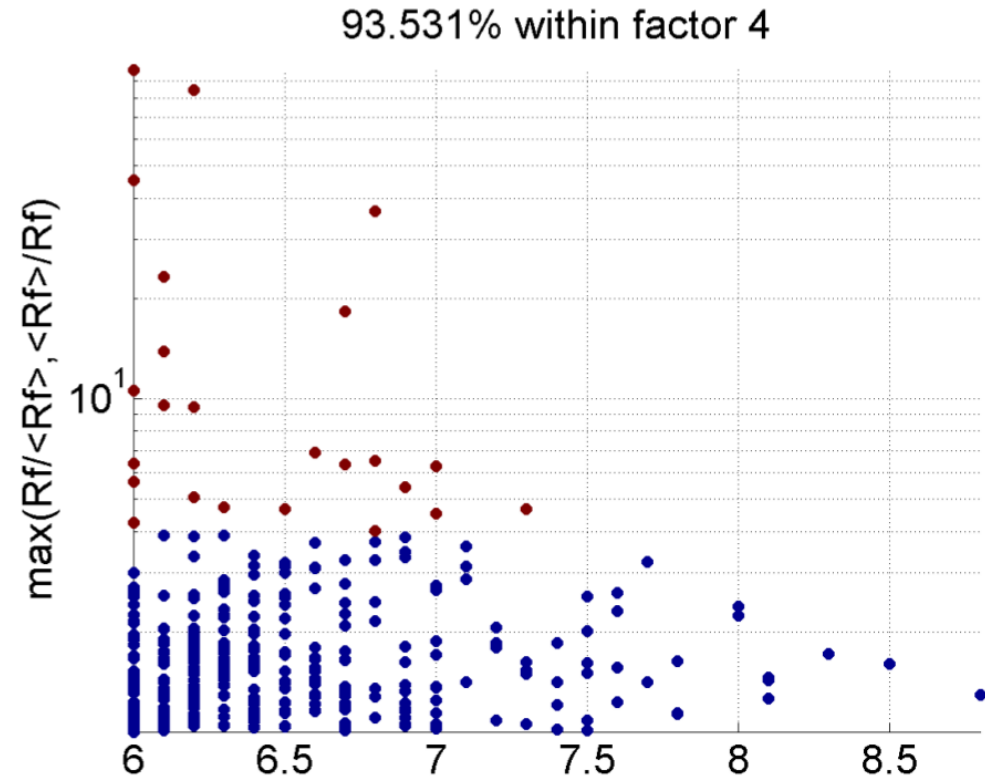

Comparison of fit to measurements at LHO

Courtesy of M. Coughlin:  
 Document G1400811

$$(1) \quad R_f = 10^{-3} * M * Af * e^{-2\pi h \cdot fc / cd} * e^{-2\pi r \cdot fc / ch / Q} / r^{rs}$$

- Reducing the digital gain and increasing the analog gain of the actuators
- Two approaches



Increase the blend frequency  
(decrease control authority) to  
not actuate on the  
common ground displacement



Decrease the blend frequency  
(increase control authority)  
to exploit the extra motion  
created by the earthquake



If translation signal: decrease blend frequency on horizontal DOFs  
If tilt signal: decrease blend frequency on rotational DOFs

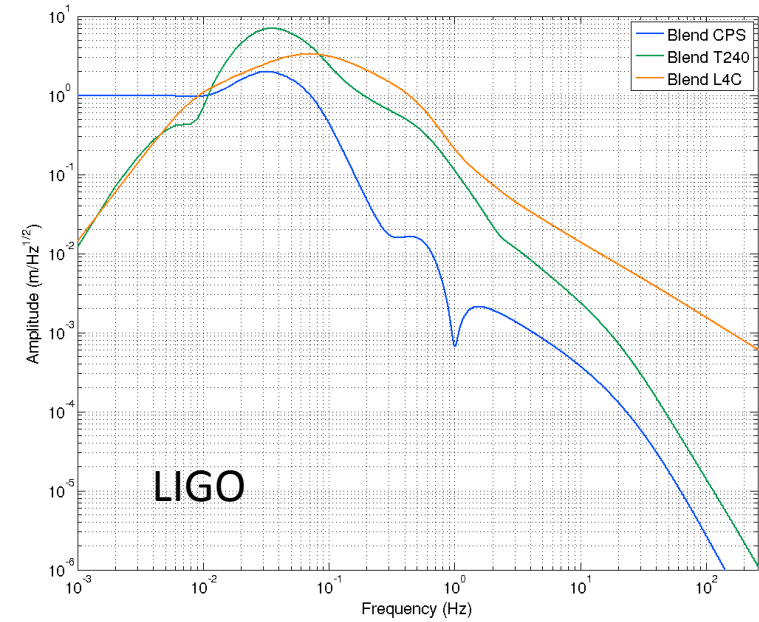

Current blend frequency ~45mHz

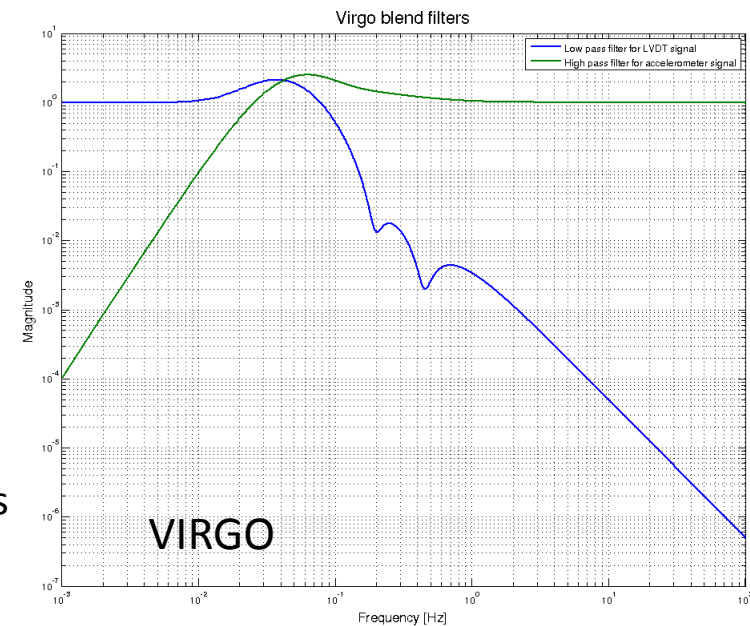

VIRGO

- More analysis work is needed (repeatability, tilt, ...). Each earthquake is different? Which earthquake (magnitude, location, ...) could we react on?
- The viability of the Earthquake monitor needs to be tested outside LHO (MIT tests)
- An “earthquake blend” could be developed and tested at MIT (VIRGO?)
- Distant future: automatic configuration switching with the guardians

Thank you for your attention



Extra-slides

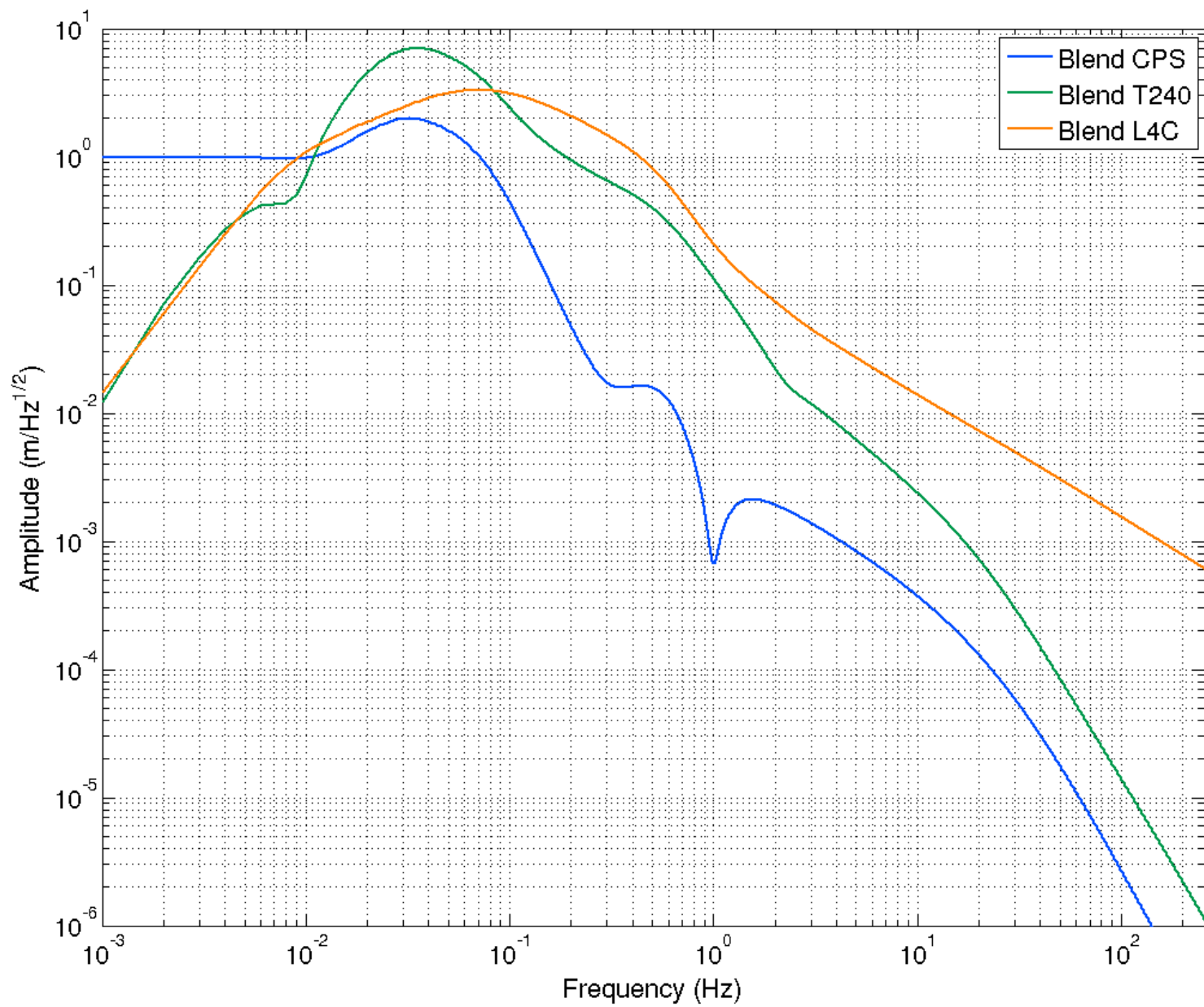

### Virgo blend filters

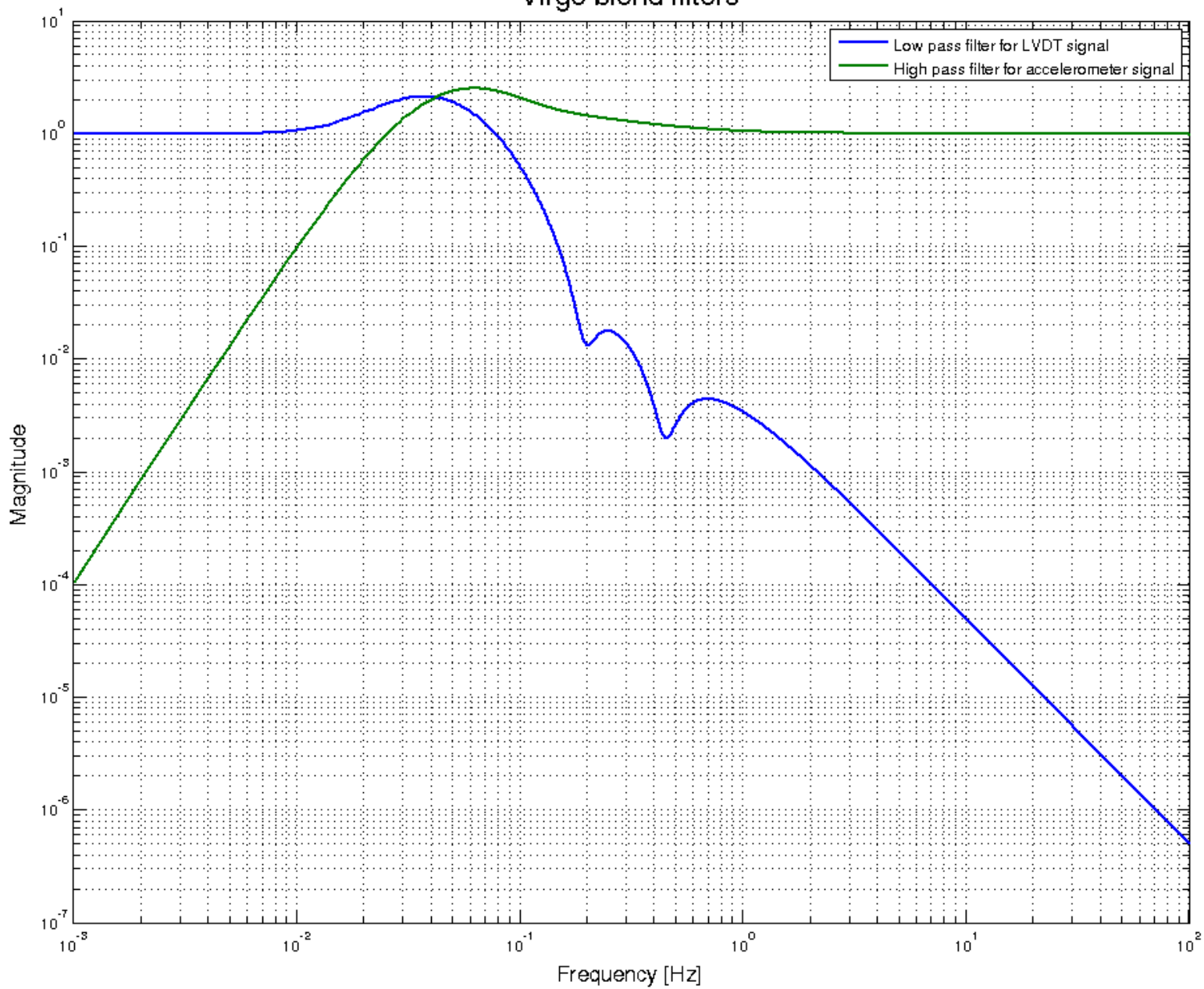

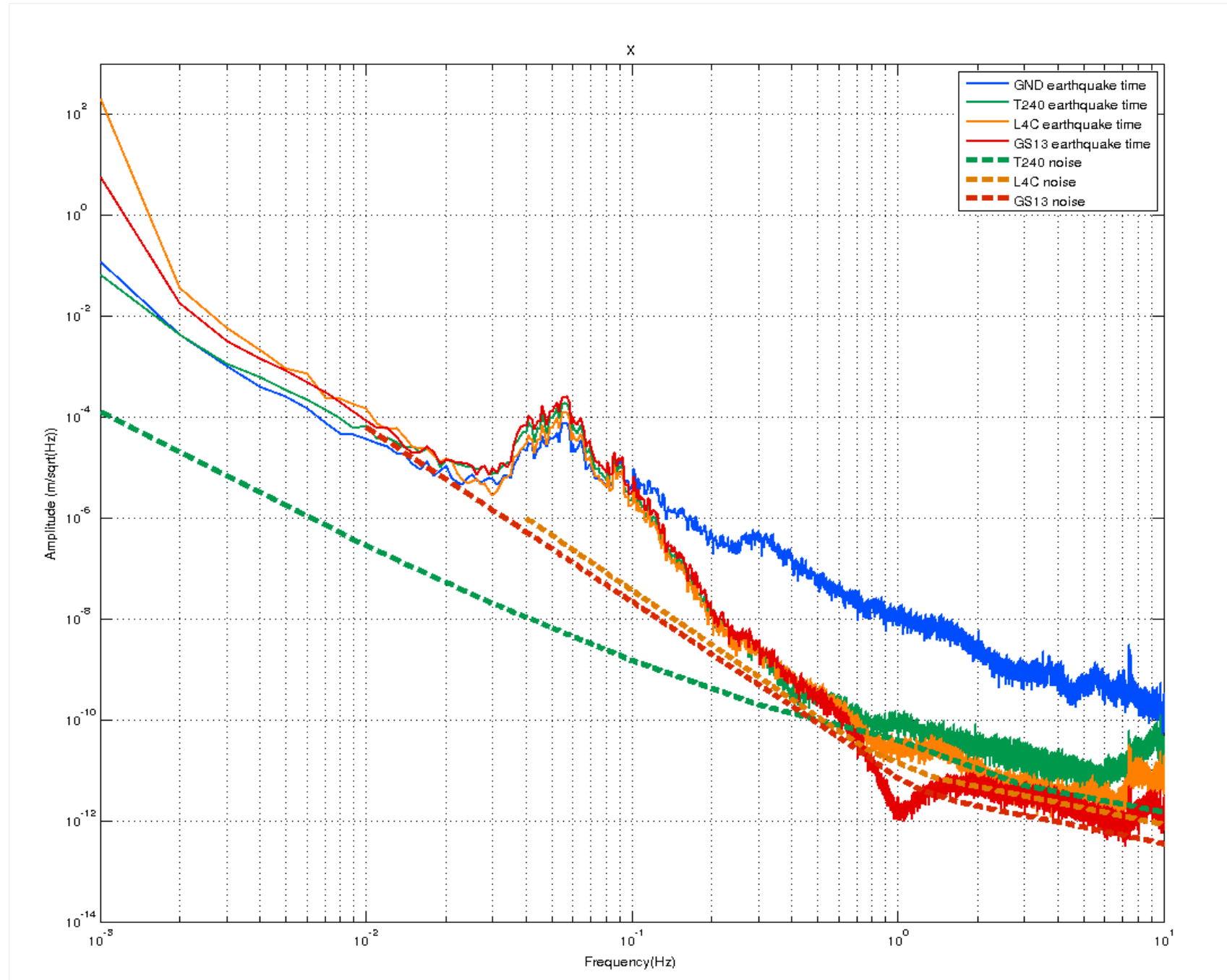

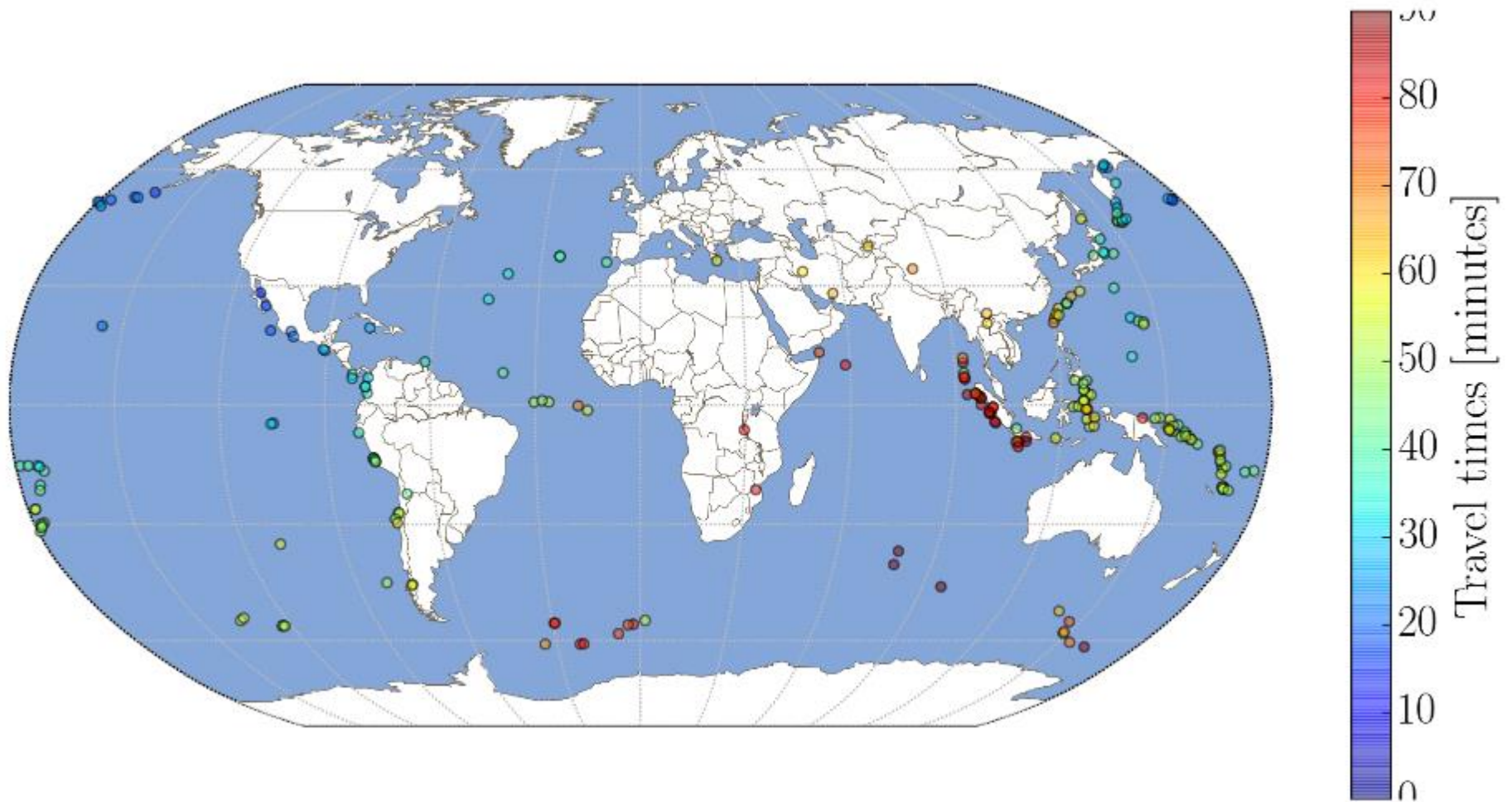

Travel times of peak seismic waves at LHO during S5

Take the amplitude the peak low-passed time-series of the seismometer data between 2 and 5 km/s

Wave velocities slightly below 3.5 km/s on average

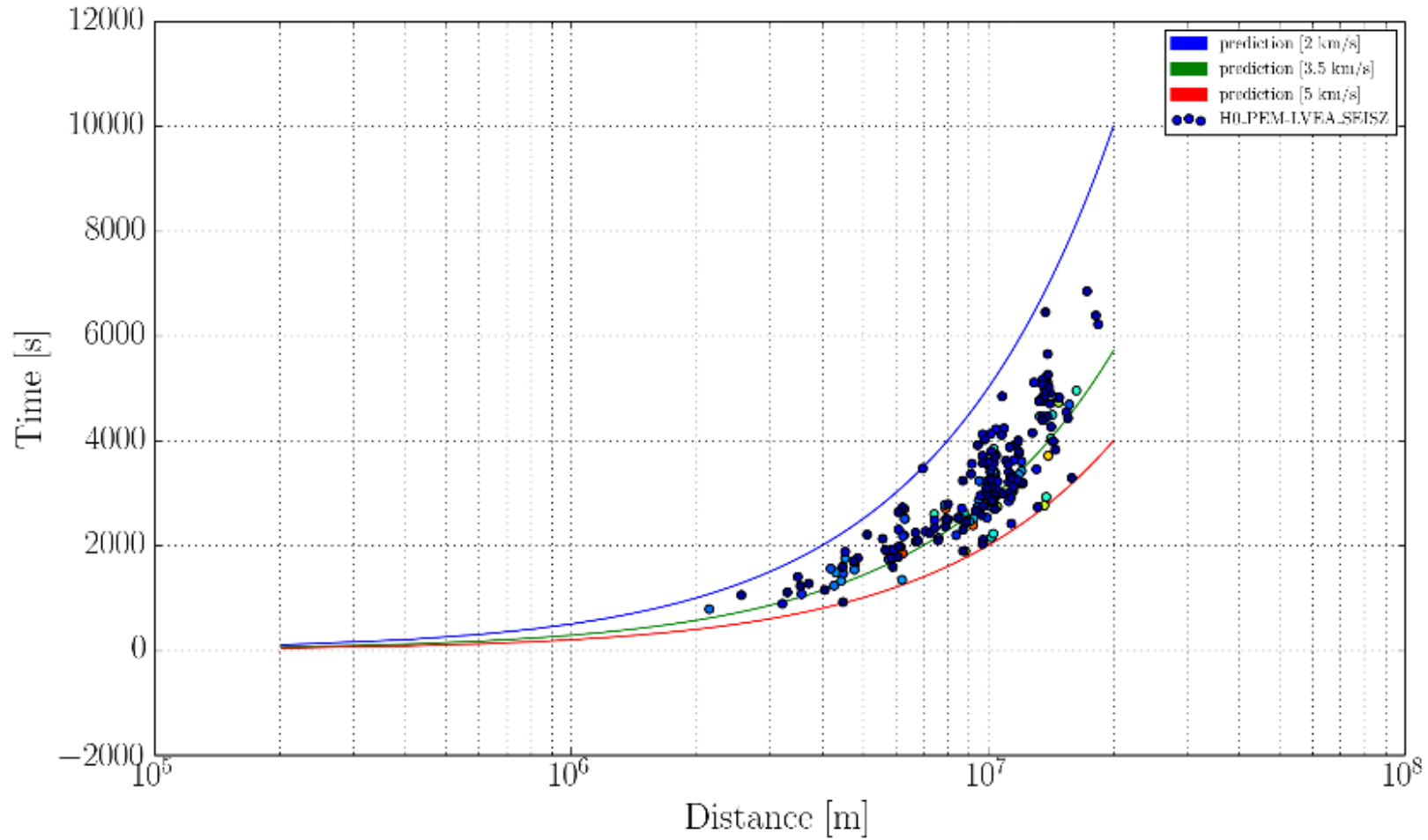

## HAM-HEPI/BSC-HEPI

Hydraulic External Pre Isolator (33 units)

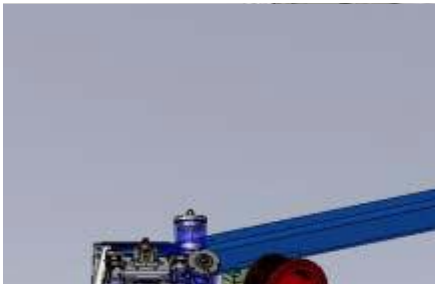
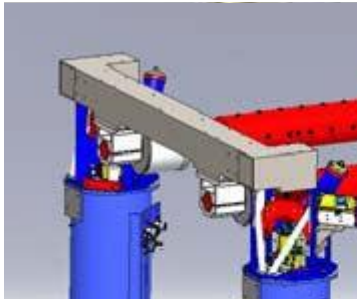

- Out of vacuum
- Hydraulically actuated
- Not much passive isolation (highly damped)
- Provides positioning and DC alignment
- Provides active isolation between  $\sim 0.1\text{Hz}$  and  $10\text{ Hz}$

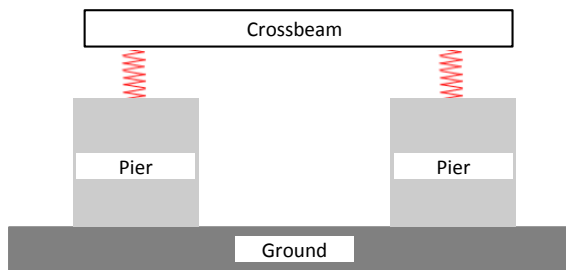

## HAM-ISI

Single Stage Internal Seismic Isolator (15 units)



- In vacuum
- Electromagnetically actuated
- Single stage of passive isolation (above  $\sim 1.8\text{Hz}$ )
- Provides positioning and DC alignment
- Provides active isolation between  $\sim 0.1\text{Hz}$  and  $35\text{ Hz}$

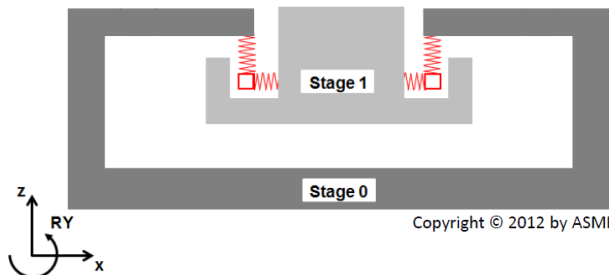

## BSC-ISI

Two-Stages Internal Seismic Isolator (15 units)

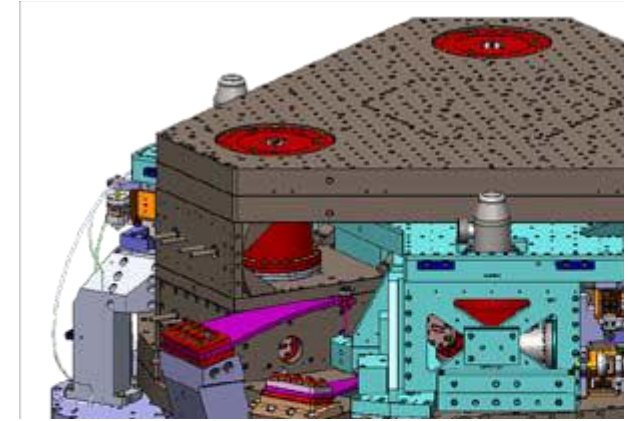

- In vacuum
- Electromagnetically actuated
- Two stages of passive isolation (above  $\sim 7\text{Hz}$ )
- Provides positioning and DC alignment
- Provides active isolation between  $\sim 0.1\text{Hz}$  and  $35\text{ Hz}$

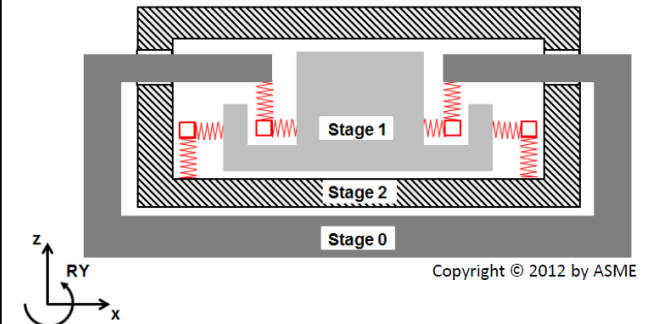

## HAM Chamber Layout & Configuration

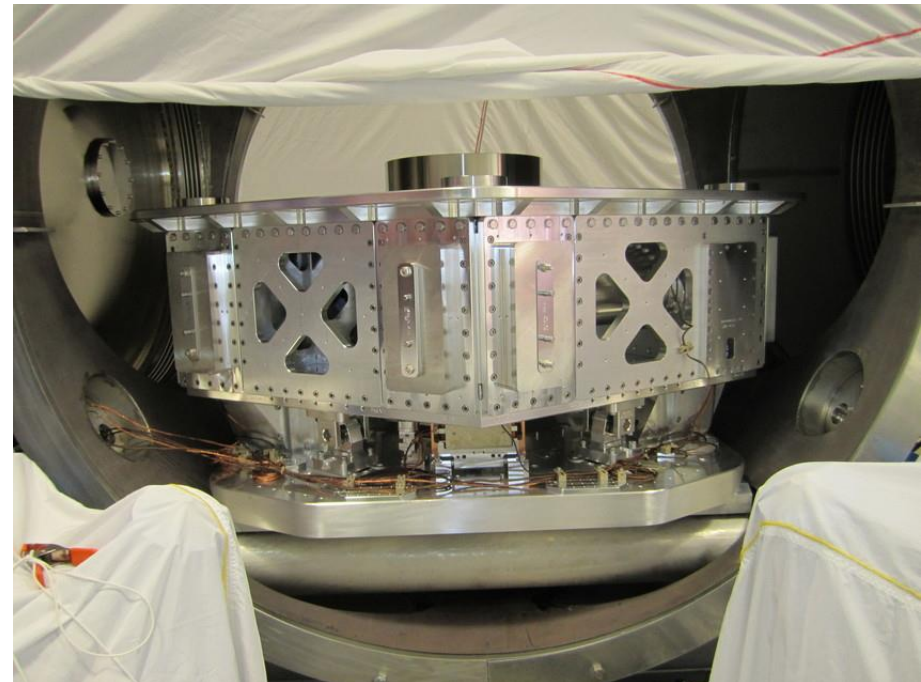
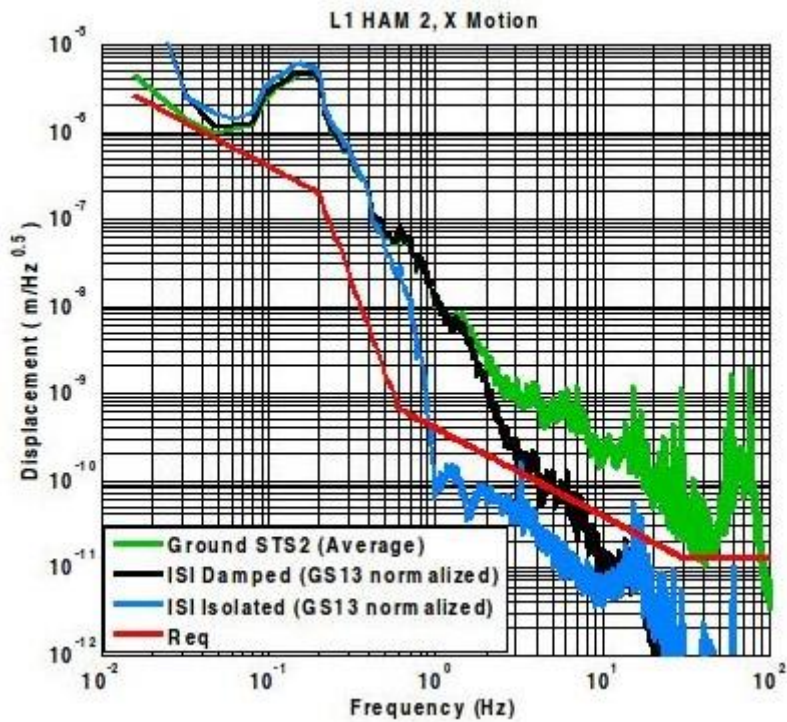
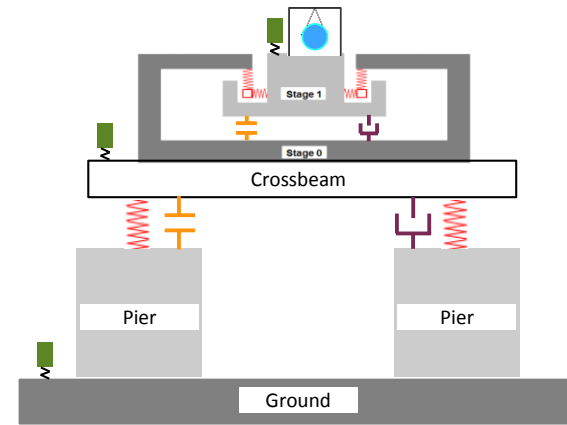
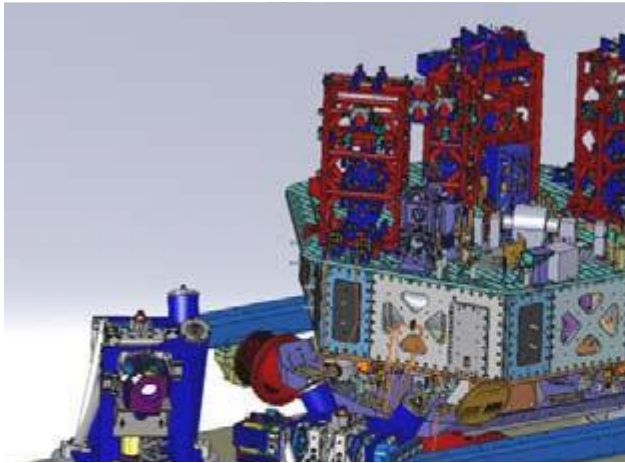



## BSC Chamber Layout & Configuration

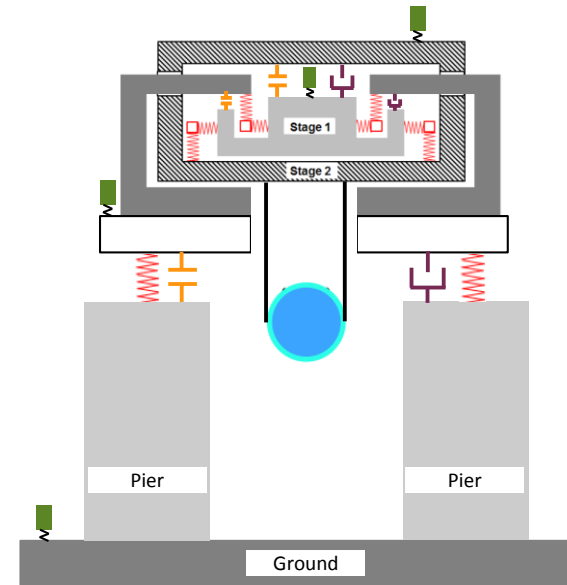
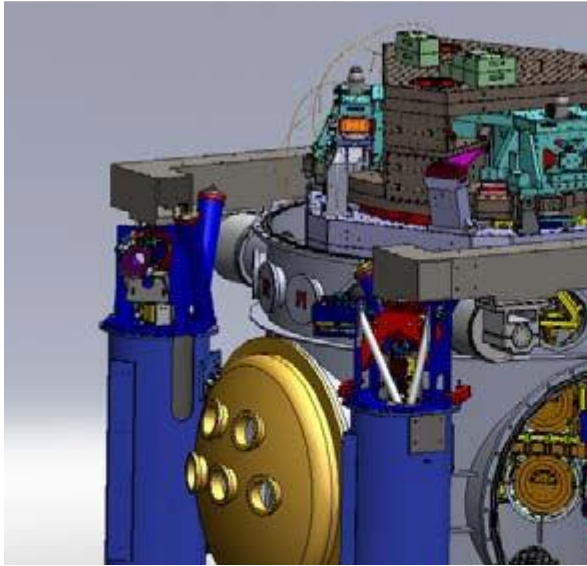

LLO ITMX X-Direction

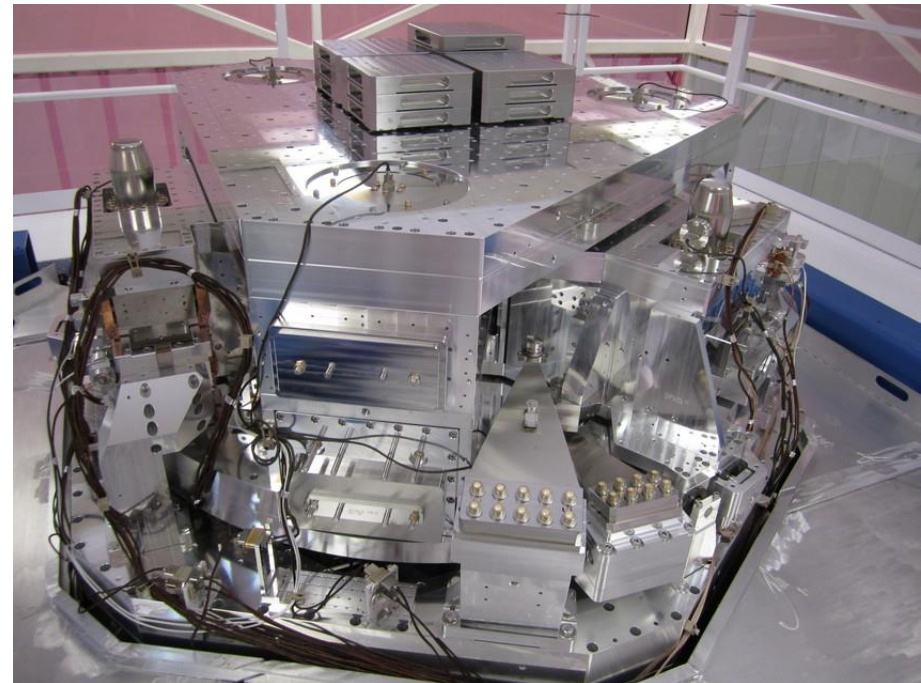
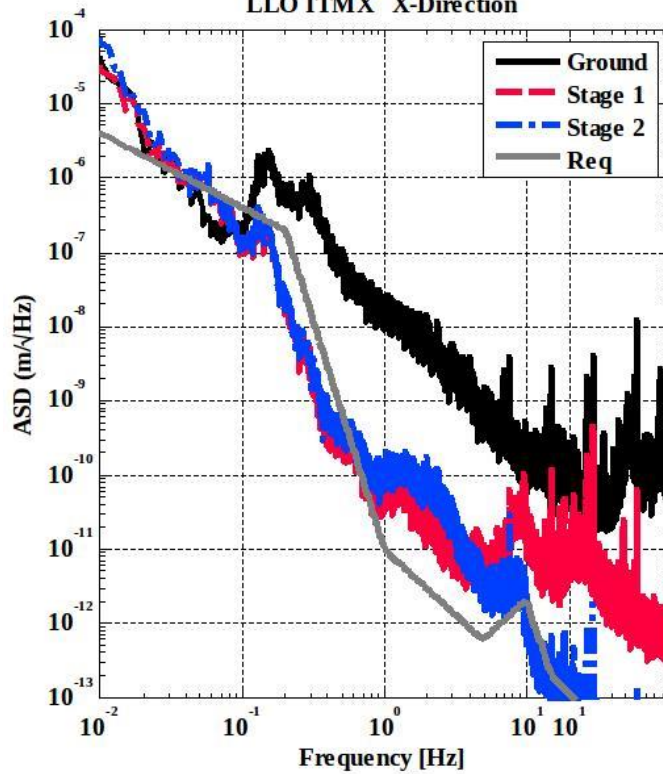

## Noise Budget

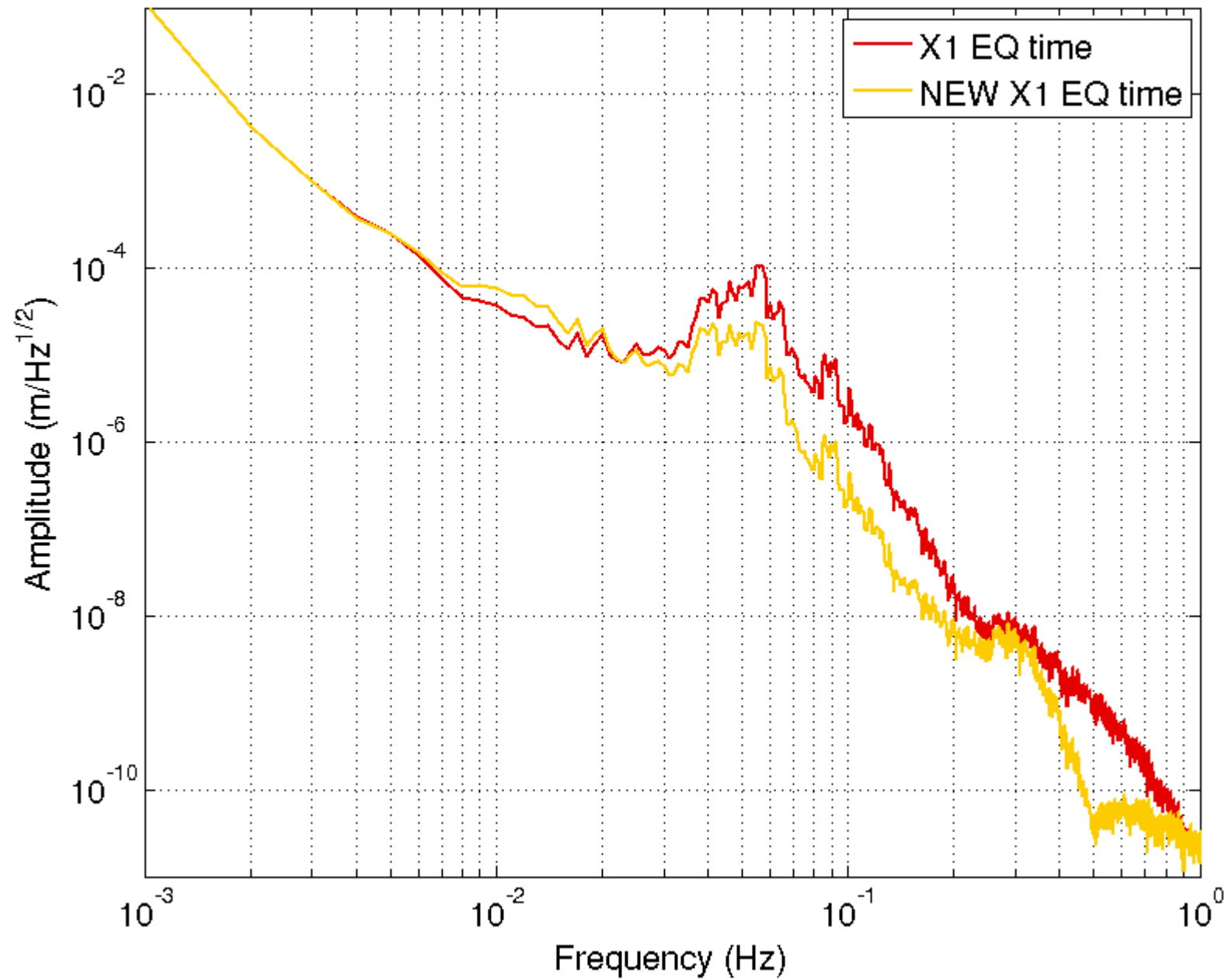

□ All the units have been installed and commissioned at both sites

