



LIGO and the network of terrestrial gravitational wave detectors

APS April Meeting, Baltimore

11 April 2015

David Shoemaker

For the LIGO Scientific Collaboration



The starting point for GW detection via Interferometry

- Rai Weiss of MIT was teaching a course on GR in the late '60s
- Wanted a good homework problem for the students
- Why not ask them to work out how to use laser interferometry to detect gravitational waves?
- Weiss wrote the instruction book we have been following ever since

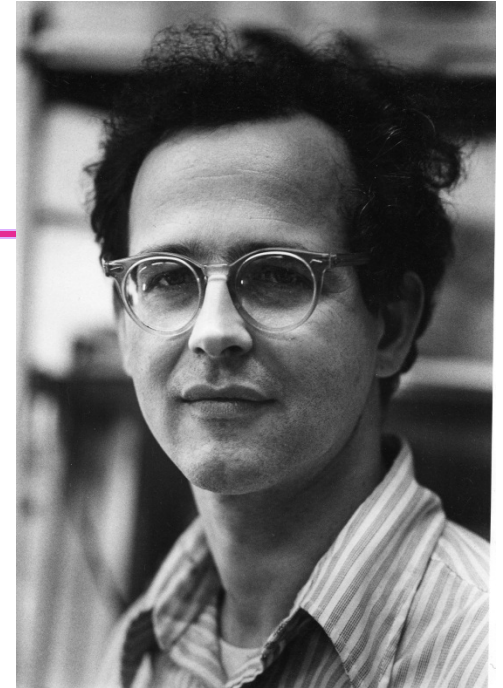

QUARTERLY PROGRESS REPORT

No. 105

APRIL 15, 1972

MASSACHUSETTS INSTITUTE OF TECHNOLOGY
RESEARCH LABORATORY OF ELECTRONICS
CAMBRIDGE, MASSACHUSETTS 02139

(V. GRAVITATION RESEARCH)

B. ELECTROMAGNETICALLY COUPLED BROADBAND GRAVITATIONAL ANTENNA

1. Introduction

The prediction of gravitational radiation that travels at the speed of light has been

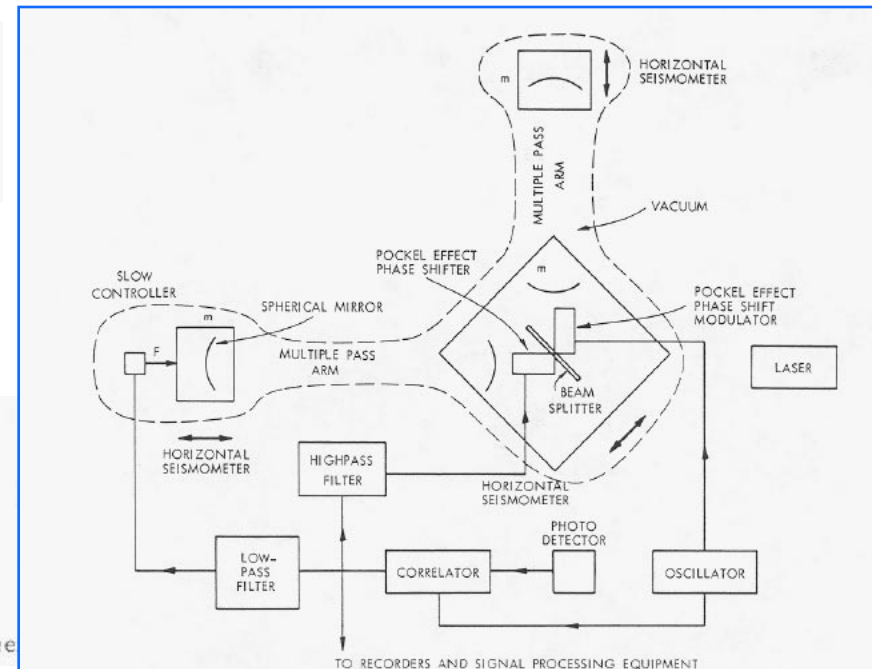

Interferometric Gravitational-wave Detectors

- Enhanced **Michelson interferometers**
 - » LIGO, Virgo, and GEO600 use variations
- Passing GWs modulate the distance between the end test mass and the beam splitter
- The interferometer acts as a transducer, turning GWs into photocurrent proportional to the strain amplitude
- **Arms are short compared to our GW wavelengths, so longer arms make bigger signals**
→ multi-km installations
- Arm length limited by taxpayer noise....

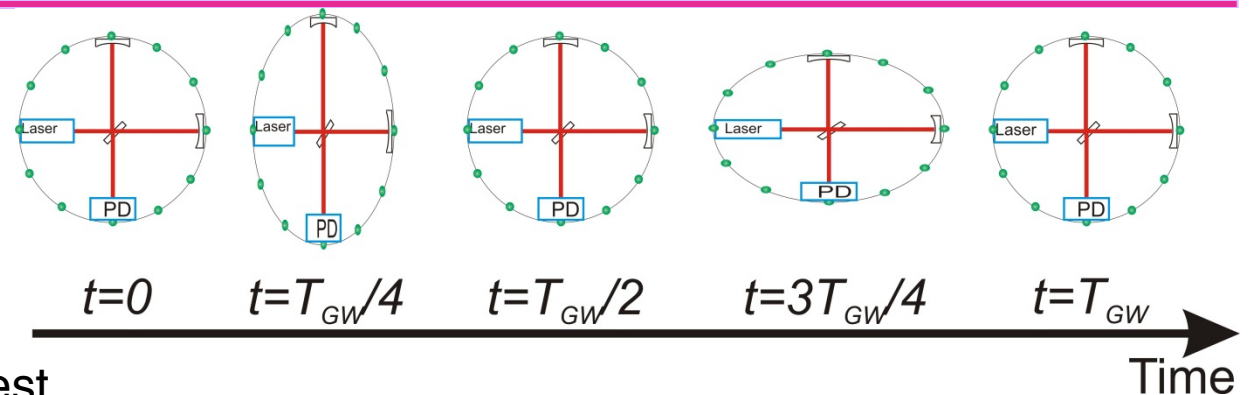

$$h \approx \frac{\Delta L}{L}$$

Magnitude of h at Earth:
 Largest signals $h \sim 10^{-20}$
 For $L = 1 \text{ m}$, $\Delta L = 10^{-20} \text{ m}$
 For $L = 4\text{km}$, $\Delta L = 4 \cdot 10^{-16} \text{ m}$

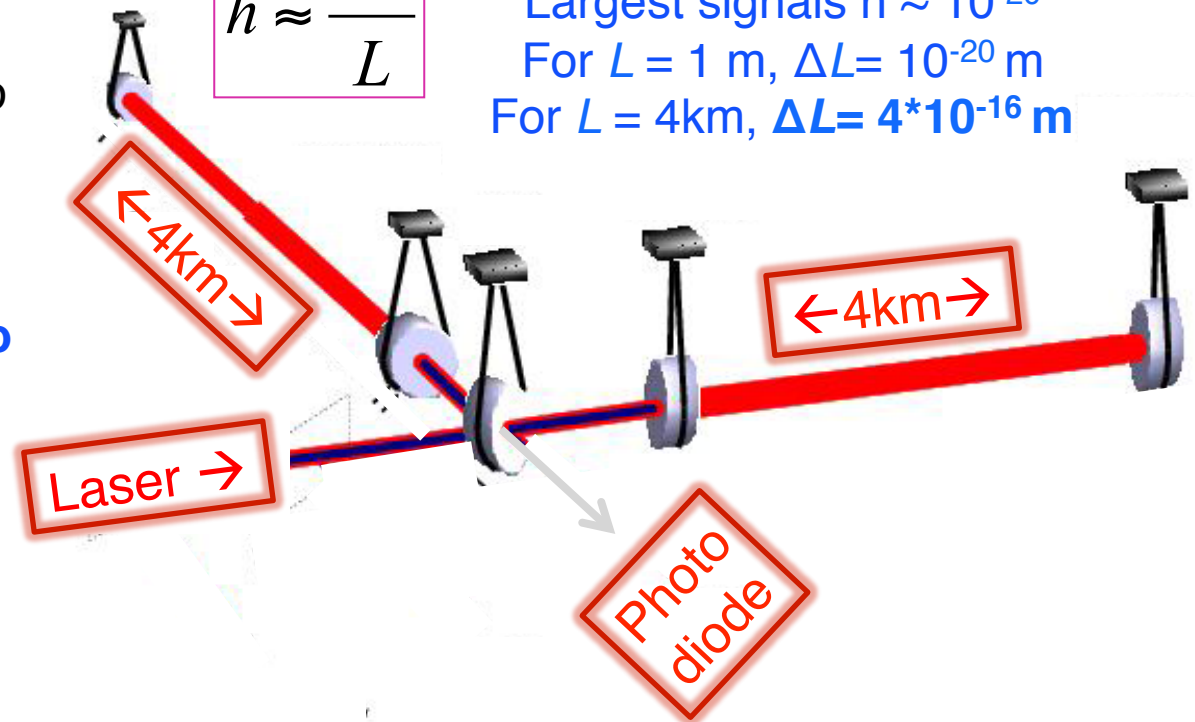



Weiss' groundwork and a worldwide development effort led to a 1989 Proposal to the US NSF

PREFACE

This proposal requests support for the design and construction of a novel scientific facility—a gravitational-wave observatory—that will open a new observational window on the universe.

The scale of this endeavor is indicated by the frontispiece illustration, which shows a perspective of one of the two proposed detector installations. Each installation includes two arms, and each arm is 4 km in length.

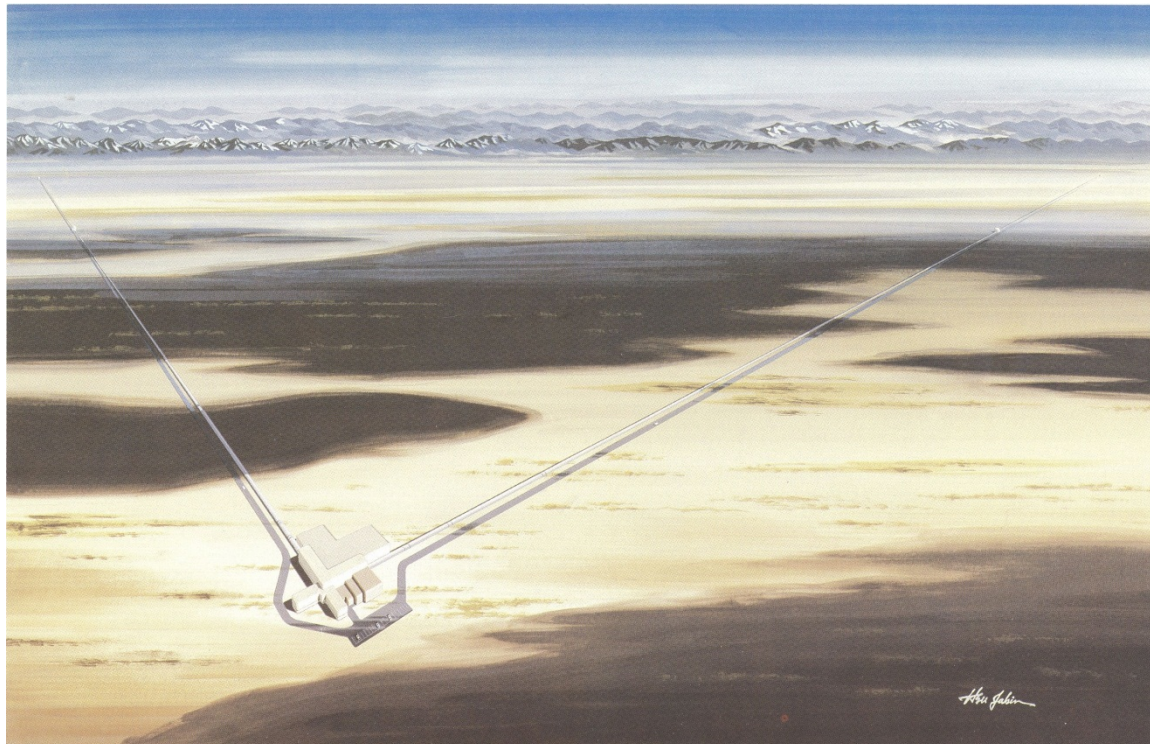



LIGO: Today, Washington state...





...LIGO in Louisiana





LIGO Laboratory: two Observatories and Caltech, MIT campuses

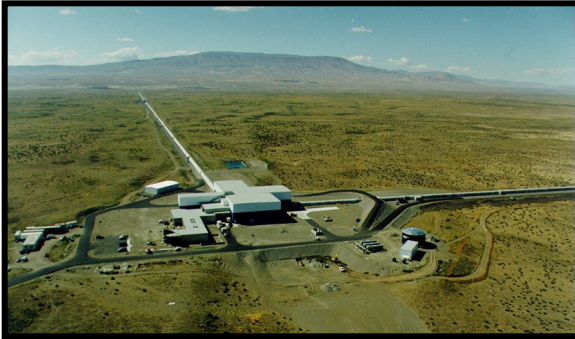

- Mission: to develop gravitational-wave detectors, and to operate them as astrophysical observatories
- Jointly managed by Caltech and MIT; LIGO Hanford and Livingston Observatories
- Requires instrument science at the frontiers of physics fundamental limits

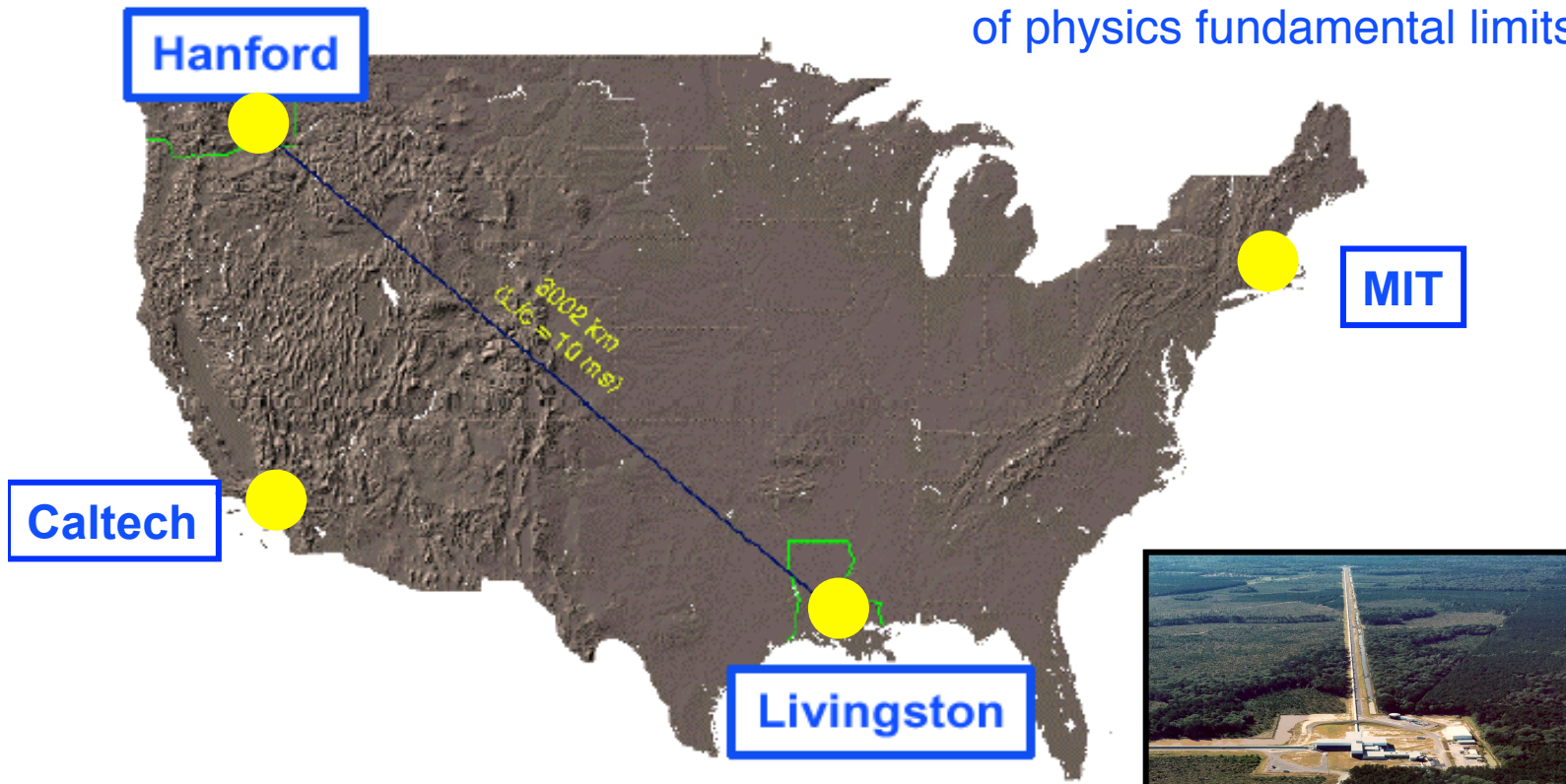



LIGO Scientific Collaboration

The LSC is the organization that conducts the science of LIGO



www.ligo.org

900+ members, 80+ institutions, 16 countries

Slide: Gabriela González

LIGO

The advanced GW detector network

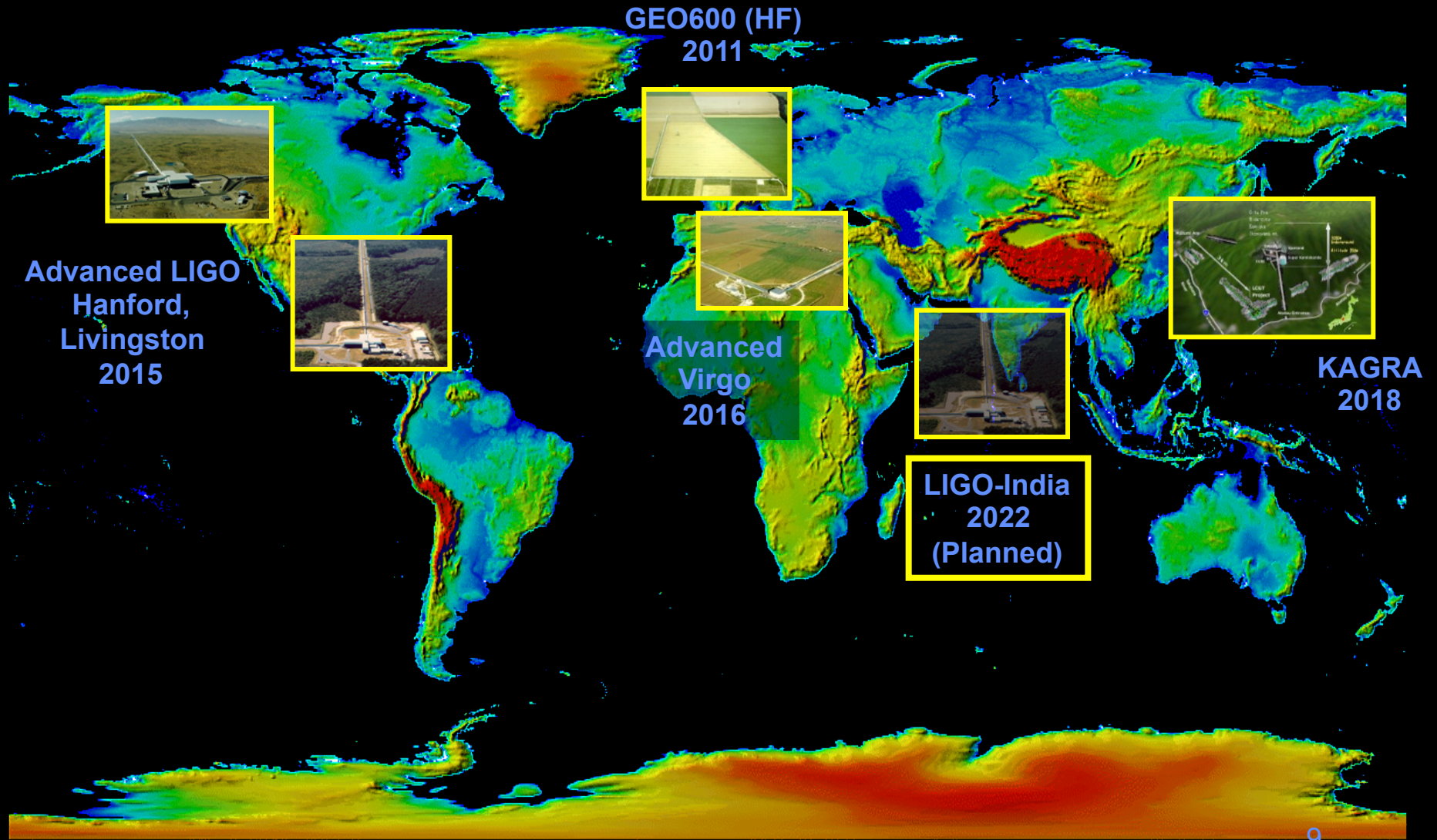

The Gravitational Wave Spectrum

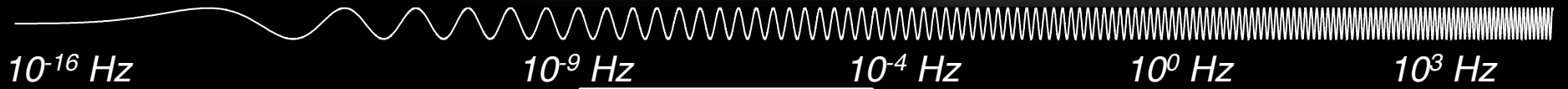
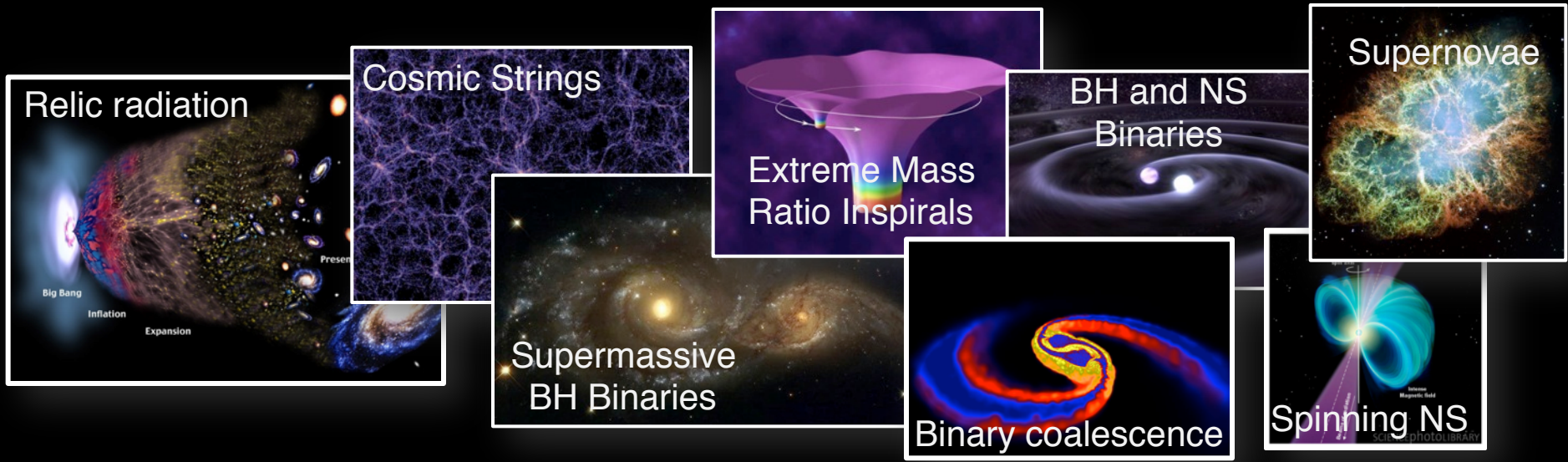

Inflation Probes Pulsar timing Space detectors Ground interferometers



Astrophysical Targets for Ground-based Detectors

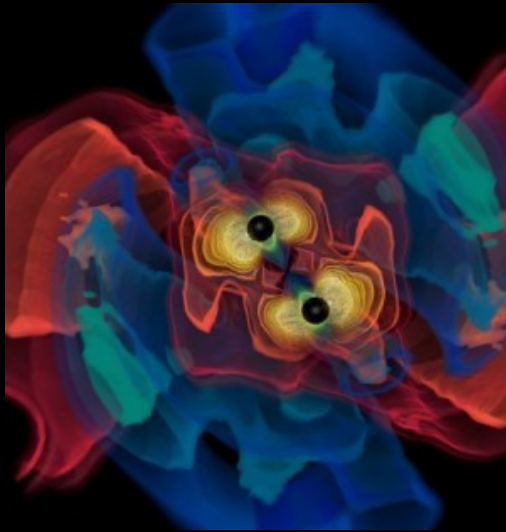

- Coalescing Binary Systems*
- Well-modelled
 - Neutron stars, low mass black holes, and NS/BS systems

Credit: AEI, CCT, LSU

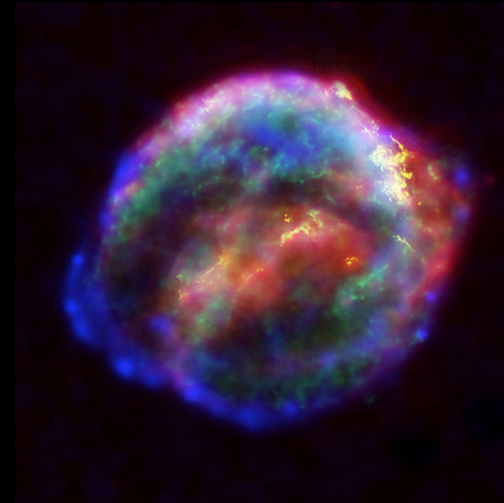

- 'Bursts'*
- Unmodelled
 - galactic asymmetric core collapse supernovae
 - cosmic strings
 - ???

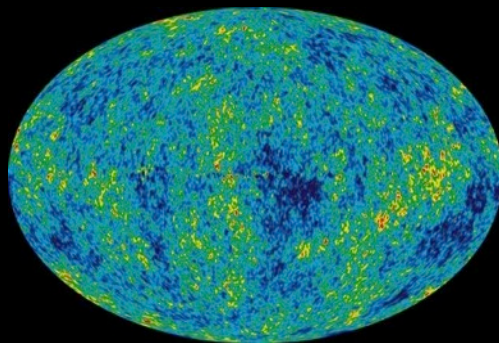

NASA/WMAP Science Team

- Stochastic GWs*
- Noise
 - Incoherent background from primordial GWs or an ensemble of unphased sources
 - primordial GWs unlikely to detect, but can bound in the 10-10000 Hz range

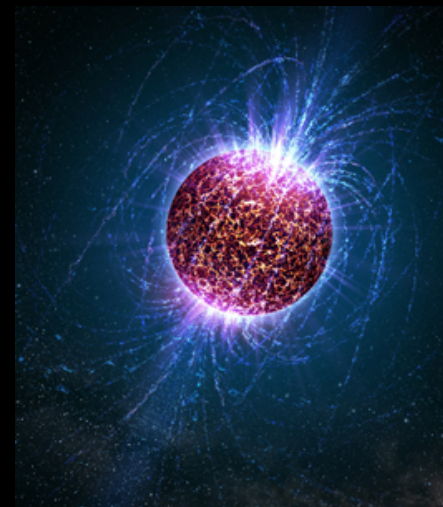

Casey Reed, Penn State

- Continuous Sources*
- Essentially Monotone
 - Spinning neutron stars
 - probe crustal deformations, equation of state, 'quarkiness'



First generation detectors

- First generation detectors and infrastructure built from mid-'90s to mid-2000; commissioned to design sensitivity; and observed for several years
- Sensitivity sufficient to reach about 100 galaxies; however...
- NS-NS coalescence events happen once every 10,000 years per galaxy...
- Need to reach more galaxies to see at least one signal per lifetime



M. Evans

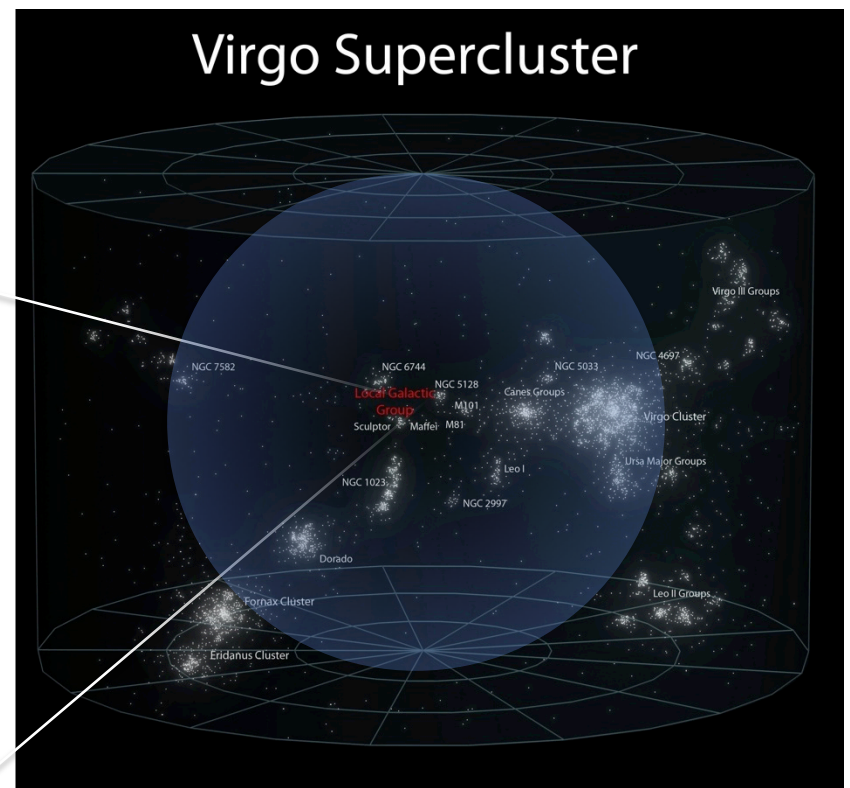
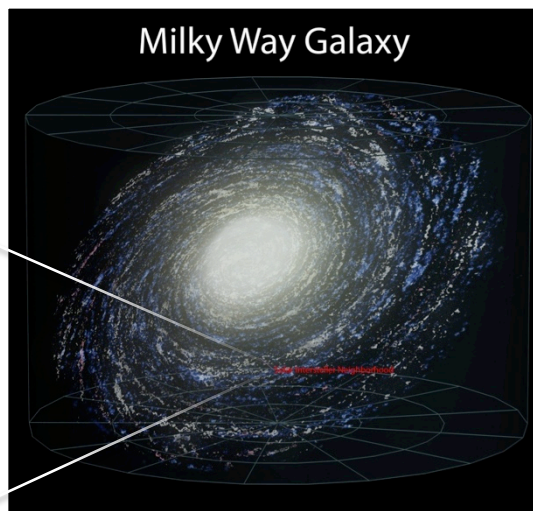

Results from 2005-2010 Initial LIGO Data

Upper limit of $<6.7 \times 10^{-6}$ on stochastic background energy density in GW (below nucleosynthesis limit)

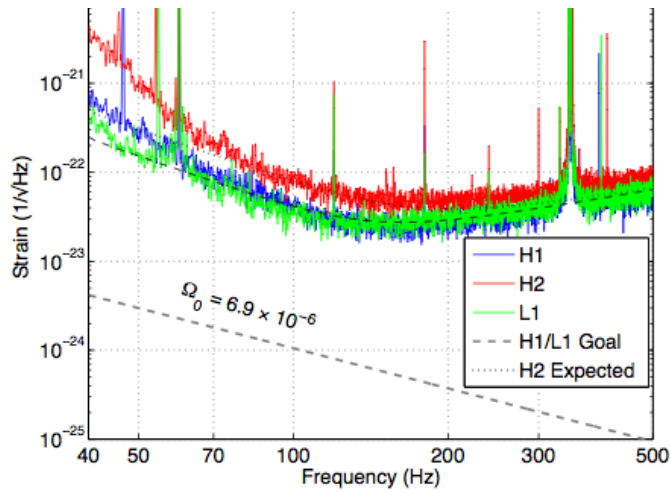

[Nature 460 \(2009\) 990](#)

Exclusion of GRB070201 from Andromeda if GRB due to inspiral coalescence

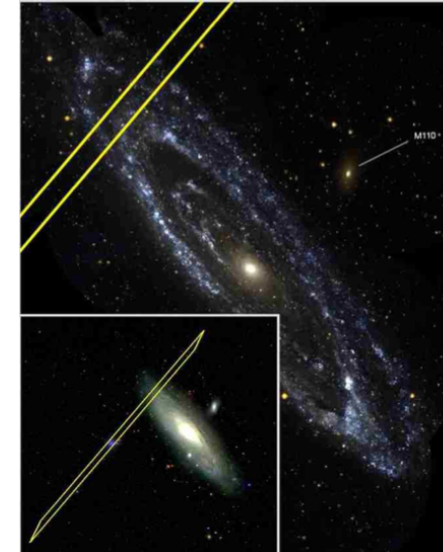

[Astrophys. J. 681 \(2008\) 1419](#)

Upper limit on GW energy emitted by generic sources at 10 kpc

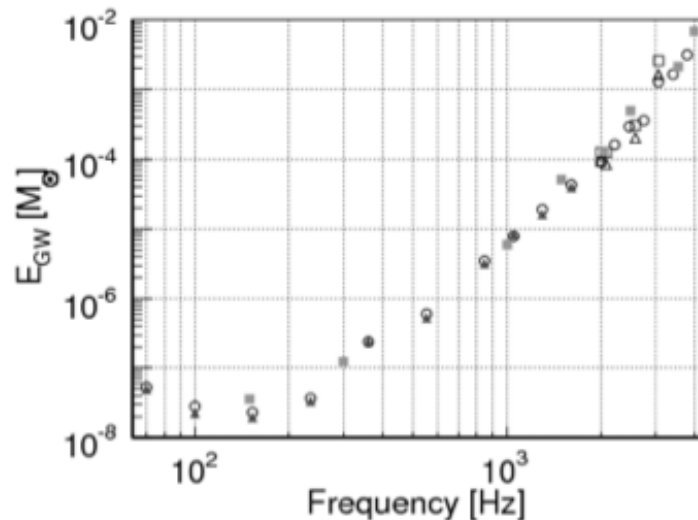

[Phys. Rev. D 81 \(2010\) 102001](#)

Upper limits on GW emissions from Crab and Vela pulsars - $\epsilon < 1.8 \times 10^{-4}$

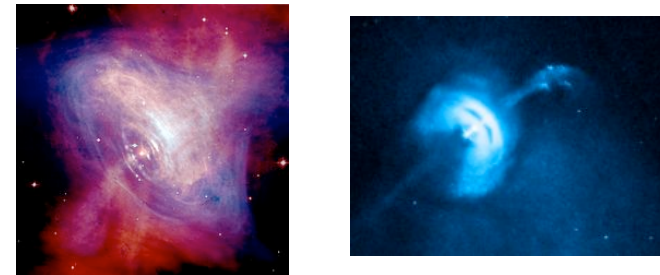

(X-ray: NASA/CXC/Univ of NASA/CXC/ASU/J Hester *et al.* (Chandra); Toronto/M. Durant *et al.*; NASA/HST/ASU/J Hester *et al.* (Hubble) Optical: DSS/Davide De Martin)

[Astrophys. J. 722 \(2010\) 1504; 737 \(2011\) 93](#)



Advanced LIGO Sensitivity: *a qualitative difference*

- While observing with initial detectors, parallel R&D led to better concepts
- ‘Advanced detectors’ now coming on line are ~10x more sensitive, will reach about 100,000 galaxies
- Events happen once every 10,000 years per galaxy...
- NS-NS detection rate order of 1 per month
- Advanced LIGO concept ~1999
- Project start 2008, \$205M NSF
- Completed 2015, tuning underway



M. Evans

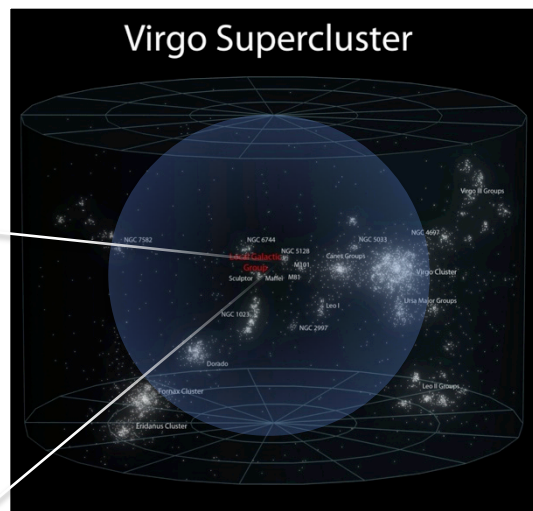

Initial Reach

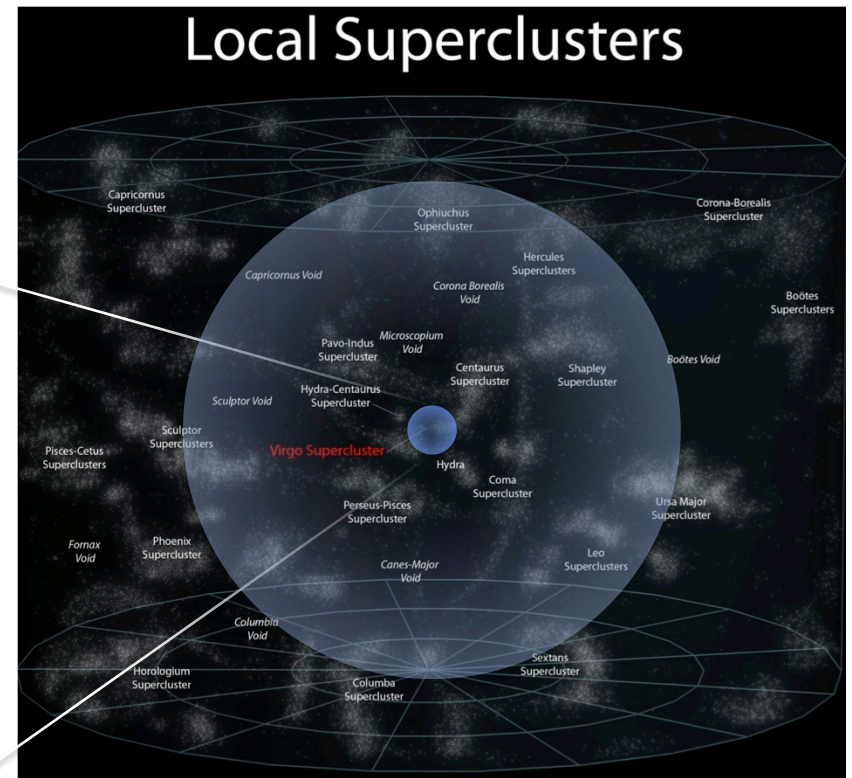

Advanced Reach

How to get there: Addressing limits to performance

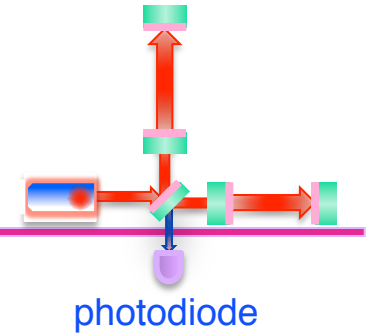

- **Shot noise** – ability to resolve a fringe shift due to a GW (counting statistics)
- *Zum gegenwärtigen Stand des Strahlungsproblems, A. Einstein, 1909*
- Fringe Resolution at high frequencies improves as as $(\text{laser power})^{1/2}$
- Point of diminishing returns when buffeting of test mass by photons increases low-frequency noise – use heavy test masses!
- ‘Standard Quantum Limit’
- Advanced LIGO reaches this limit with its **200W laser, 40 kg test masses**

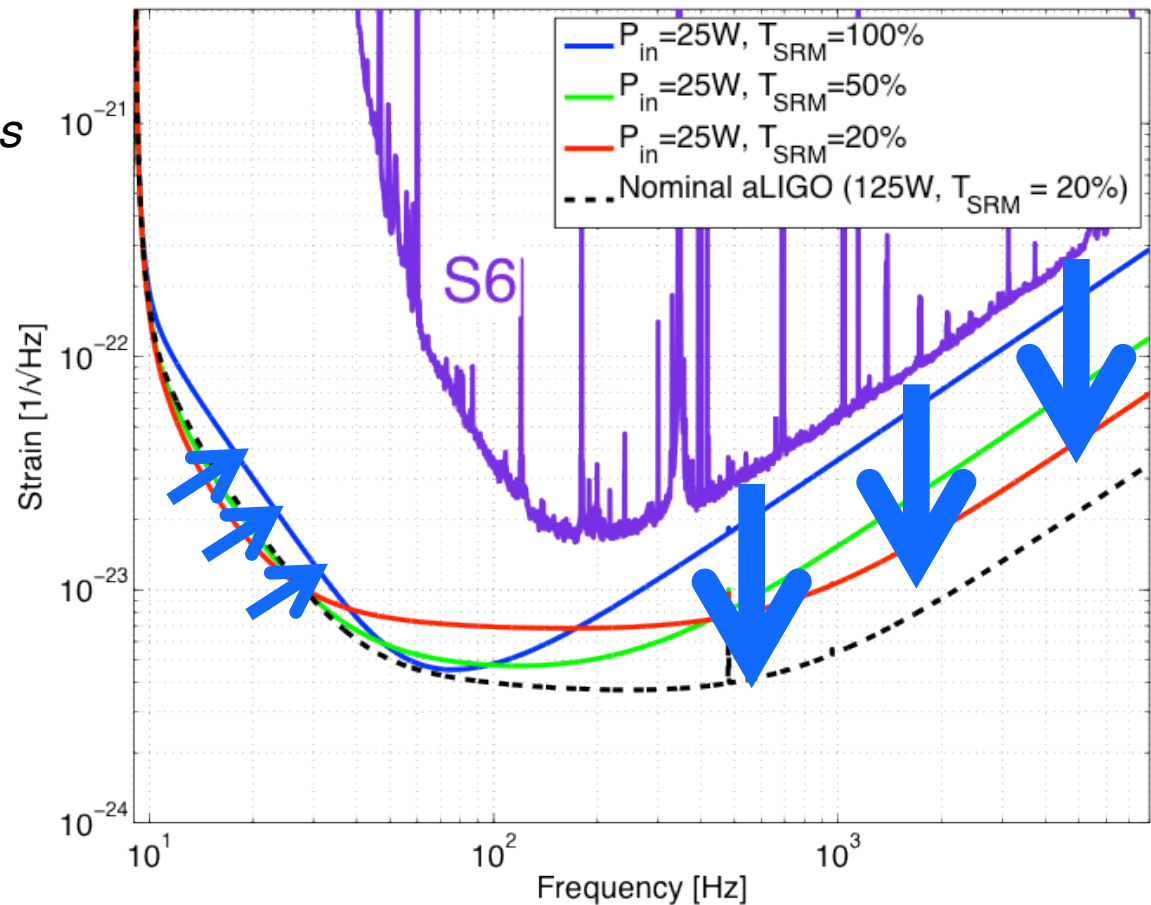

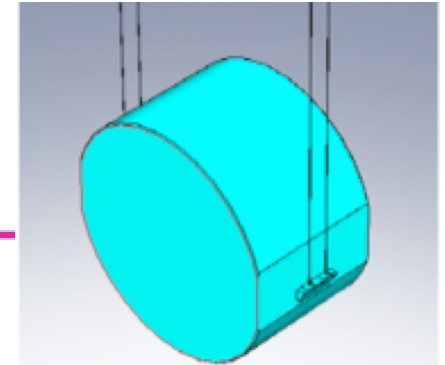

- **Thermal noise** – kT of energy per mechanical mode
- *Über die von der molekularkinetischen Theorie der Wärmegeforderte Bewegung von in ruhenden Flüssigkeiten suspendierten Teilchen, A. Einstein, 1905*
- Motion of components due to thermal energy masks GW
- Low mechanical loss materials gather this motion into a narrow peak at resonant frequencies
- Realized in aLIGO with an all **fused-silica test mass suspension** – Q of order 10^9
- **Test mass internal modes, Mirror coatings engineered for low mechanical loss**

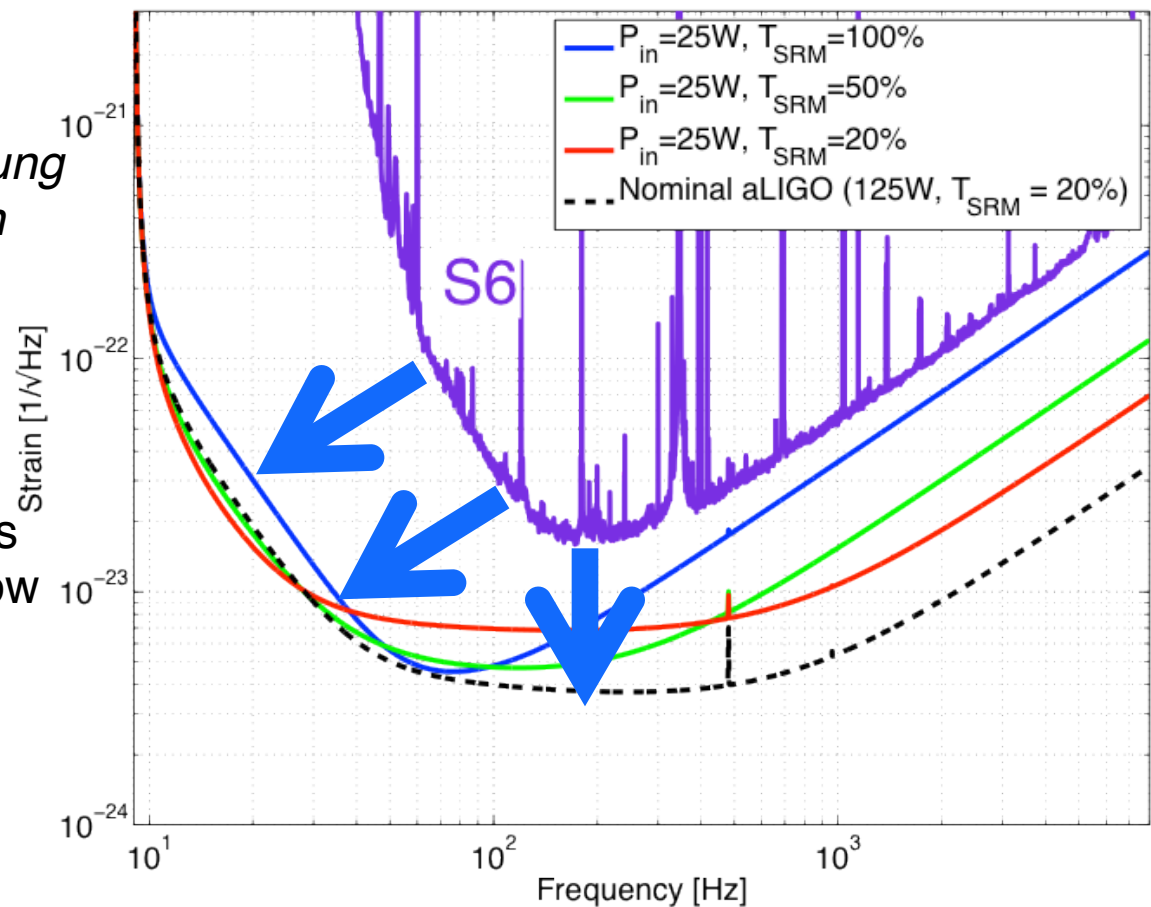

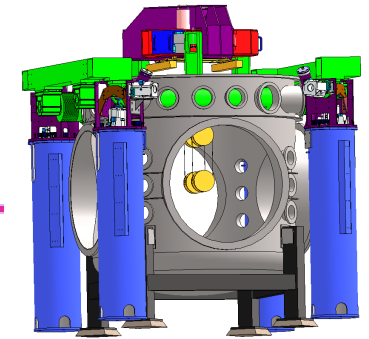

- **Seismic noise** – must prevent masking of GWs, enable practical control systems
- Motion from waves on coasts... and people moving around
- GW band: 10 Hz and above – direct effect of masking
- Control Band: below 10 Hz – forces needed to hold optics on resonance and aligned
- aLIGO uses **active servo-controlled platforms, multiple pendulums**
- Ultimate limit on the ground: Newtonian background – wandering net gravity vector; a limit in the 10-20 Hz band

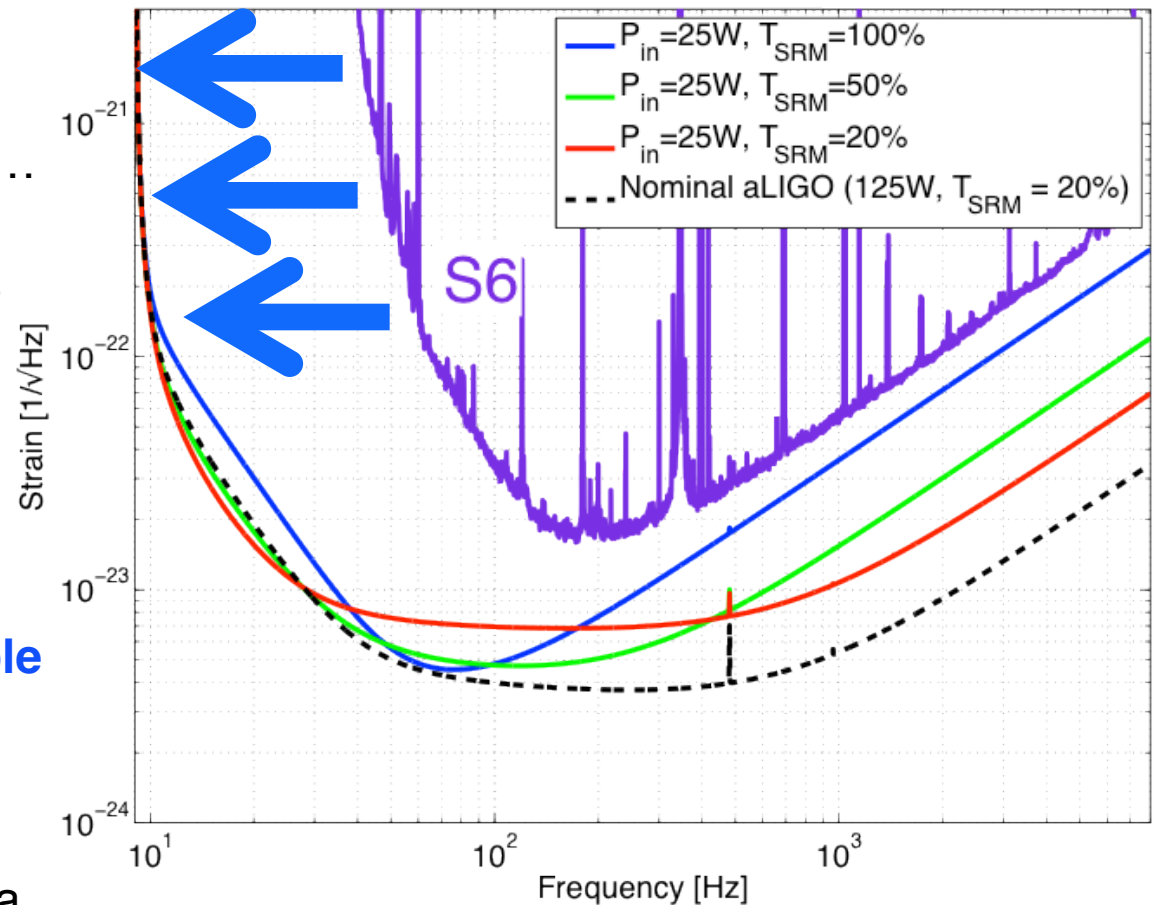

L. Barsotti - March 9, 2012
Adapted from G1200071-v1

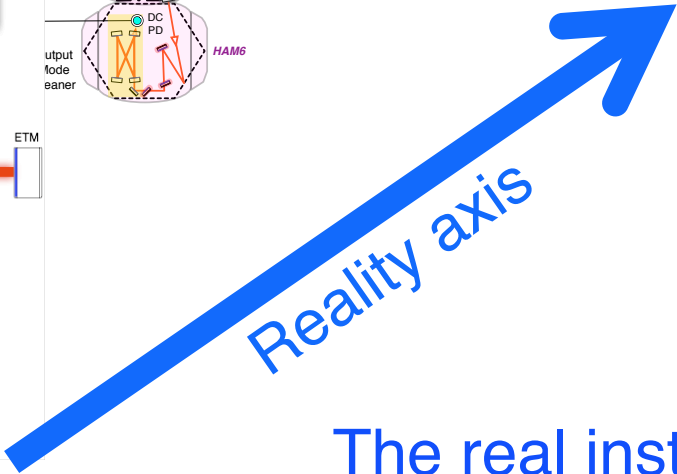
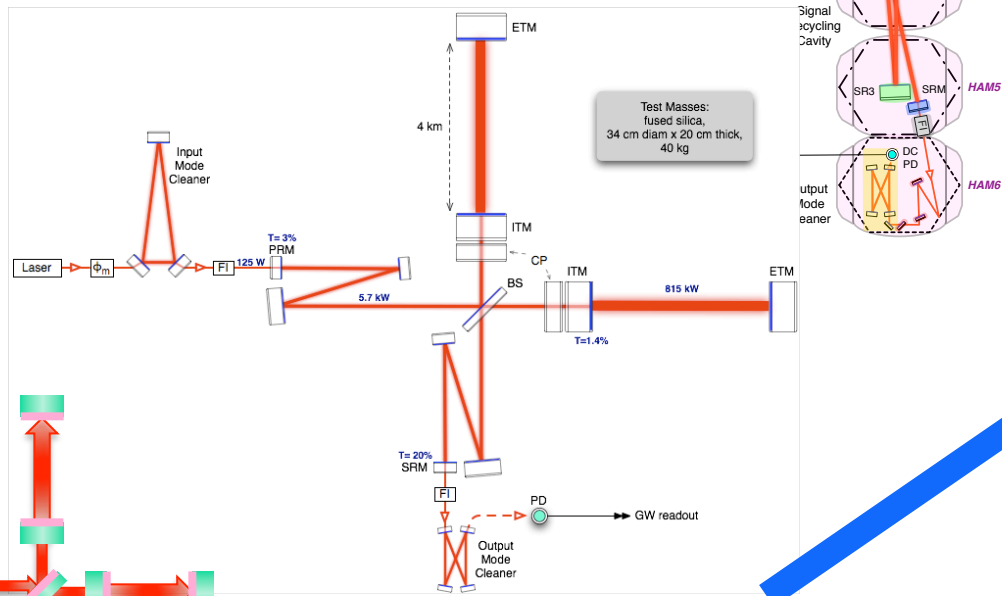
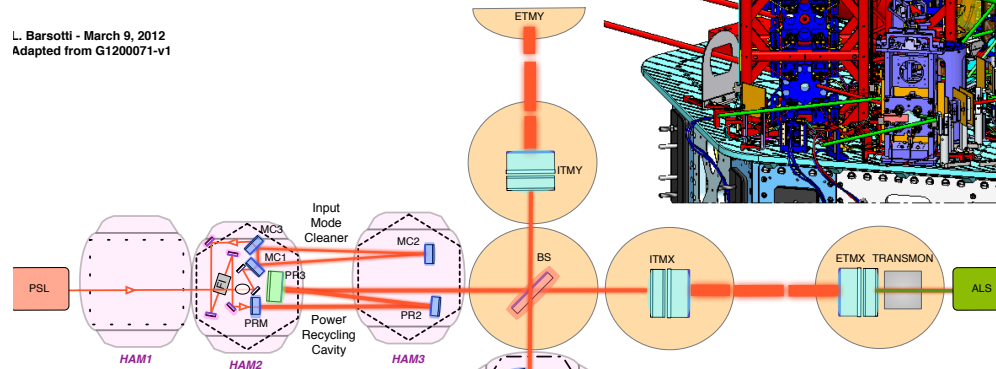
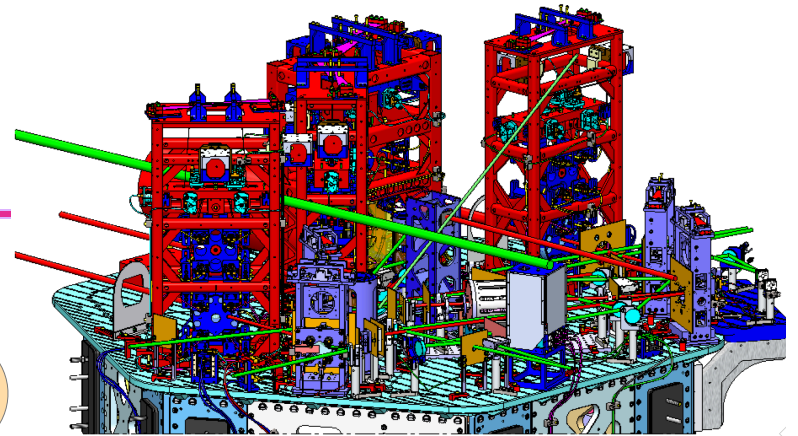

The real instrument is far more complex...

photodiode

The Design: Optical Configuration

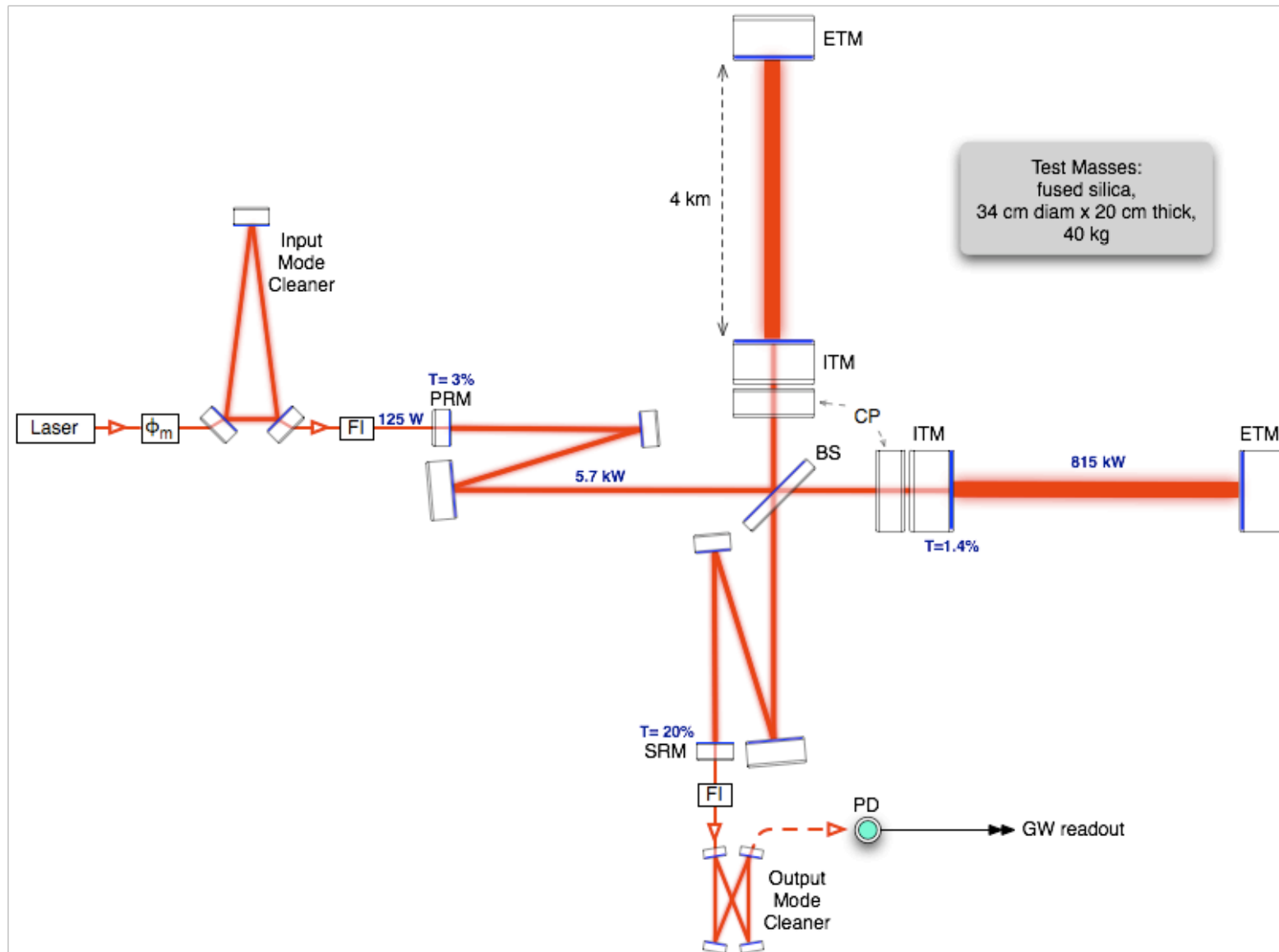

Infrastructure: 4km Beam Tubes



- Light must travel in an excellent vacuum
 - » Just a few molecules traversing the optical path makes a detectable change in path length, masking GWs!
 - » 1.2 m diameter – avoid scattering against walls
- Cover over the tube – stops hunters' bullets and the stray car
- Tube is straight to a fraction of a cm...not like the earth's curved surface



LIGO Vacuum Equipment – designed for several generations of instruments

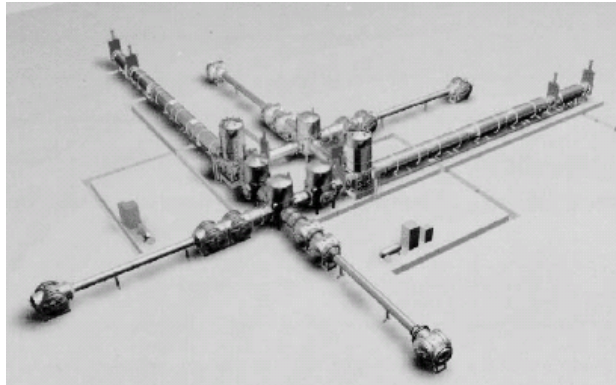

200W Nd:YAG laser

Designed and contributed by Max Planck Albert Einstein Institute

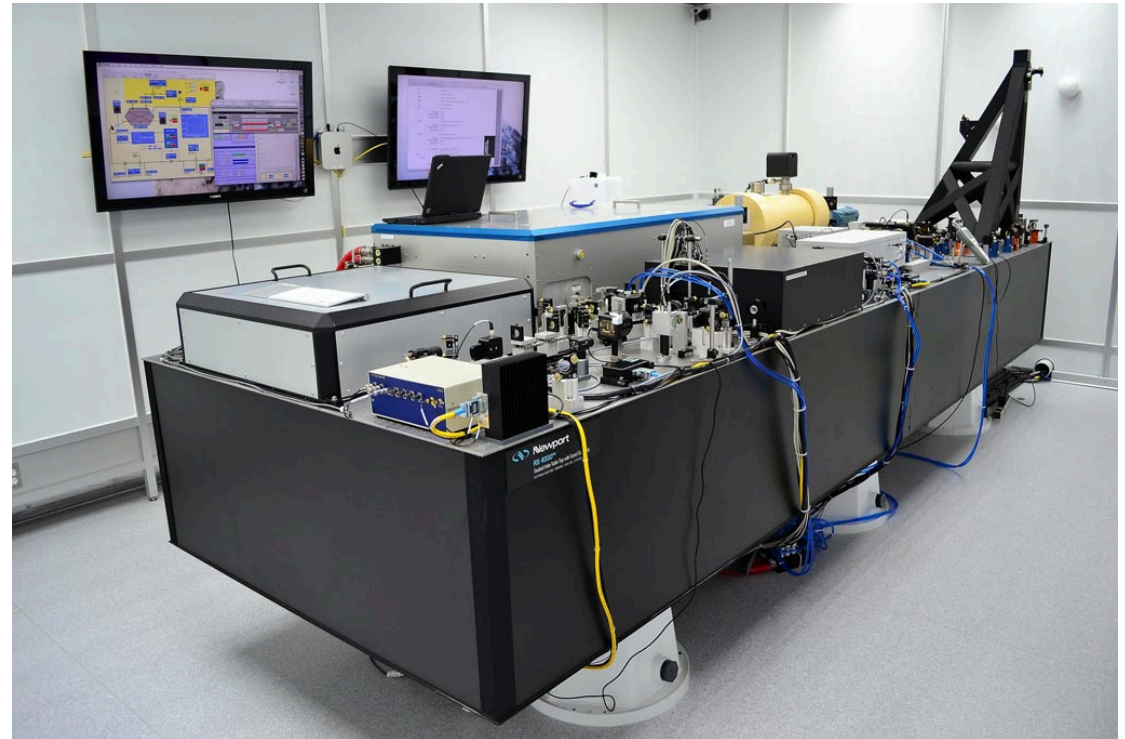
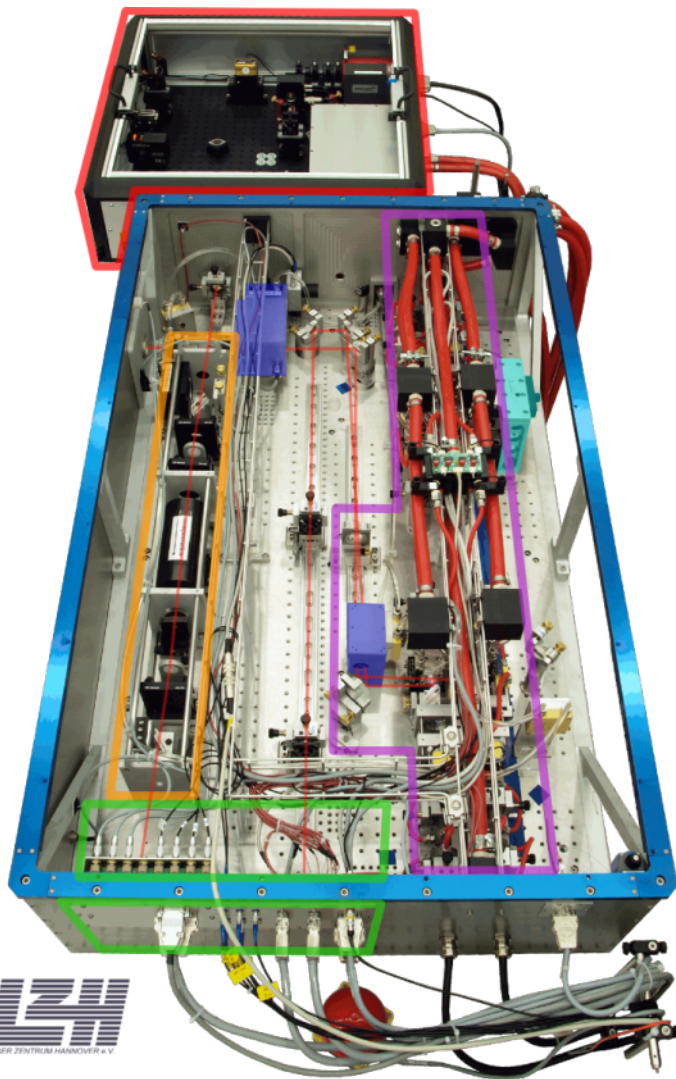

- Stabilized in power and frequency
- Uses a monolithic master oscillator followed by injection-locked rod amplifier



Test Masses

- Requires the state of the art in substrates and polishing
- Pushes the art for coating!
- Sum-nm flatness over 300mm

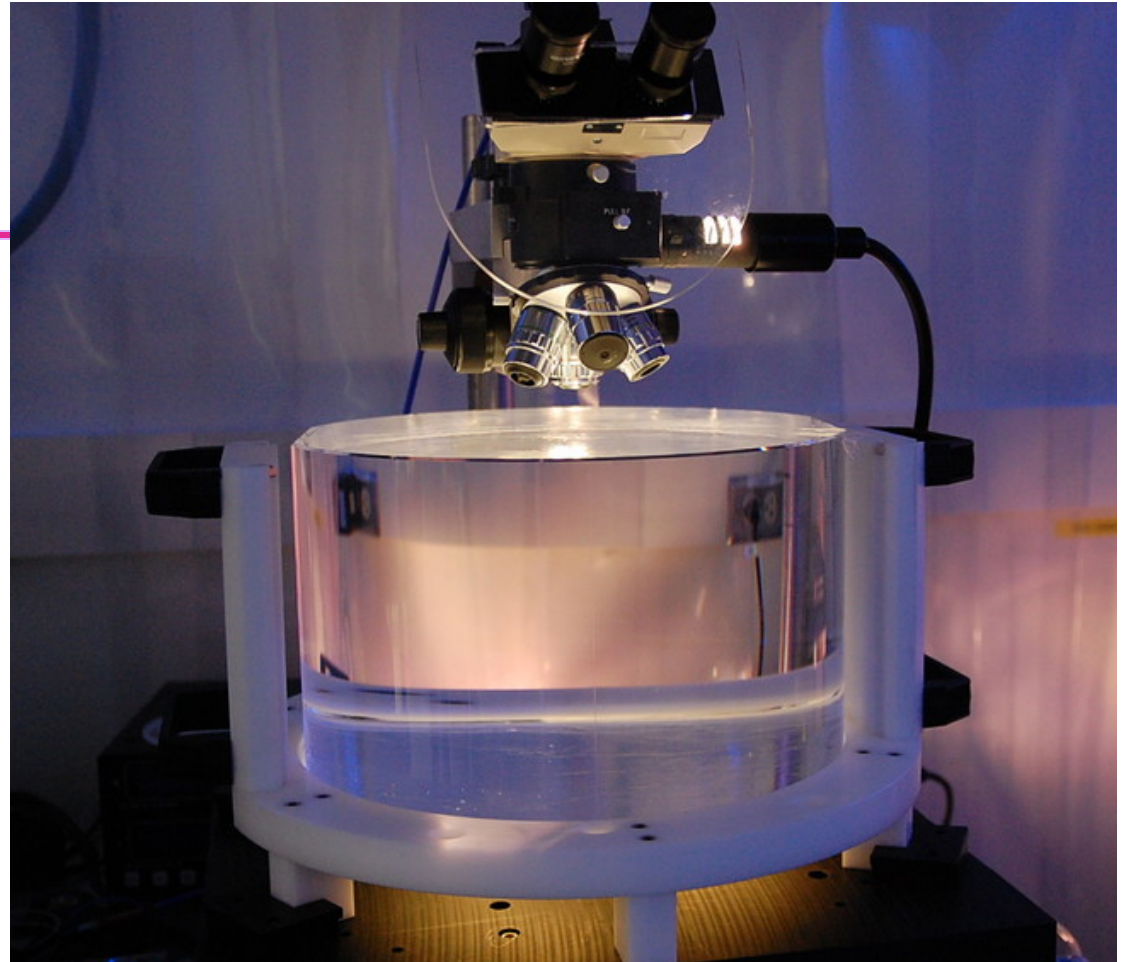
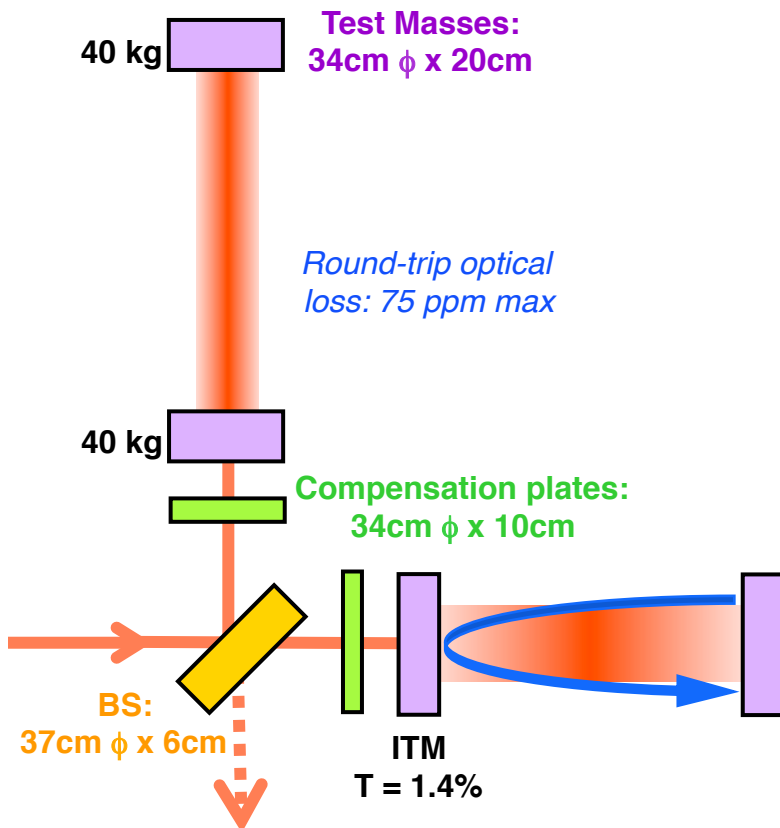

- Both the physical test mass – a free point in space-time – and a crucial optical element
- Mechanical requirements: bulk and coating thermal noise, high resonant frequency
- Optical requirements: figure, scatter, homogeneity, bulk and coating absorption



Test Mass Quadruple Pendulum suspension

designed jointly by the UK (led by Glasgow) and LIGO lab,
with capital contribution funded by PPARC/STFC

- Quadruple pendulum suspensions for the main optics; second 'reaction' mass to give quiet point from which to push
- Create quasi-monolithic pendulums using fused silica fibers to suspend 40 kg test mass
 - » VERY Low thermal noise!
- Another element in hierarchical control system

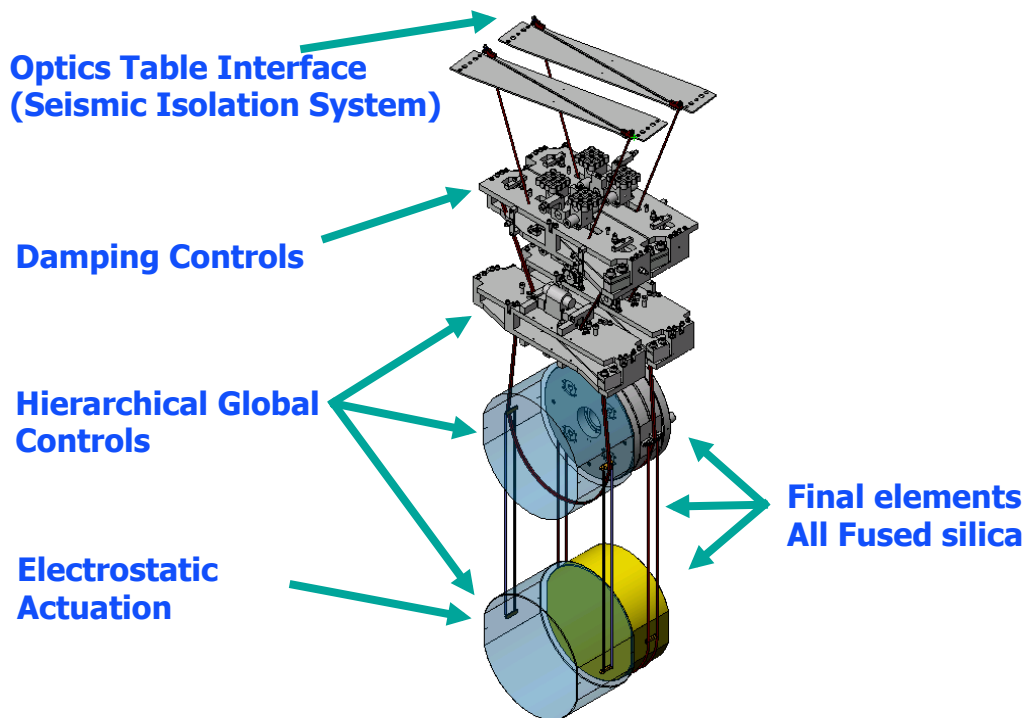



Seismic Isolation: Multi-Stage Solution

- Objectives:
 - » Render seismic noise a negligible limitation to GW searches
 - » Reduce actuation forces on test masses
- Both suspension and seismic isolation systems contribute to attenuation
- Choose an active isolation approach, 3 stages of 6 degrees-of-freedom :
 - 1) Two Active Stages of Internal Seismic Isolation
 - 2) Hydraulic External Pre-Isolation
- Low noise sensors (position, velocity, acceleration) are combined, passed through a servo amplifier, and delivered to the optimal actuator as a function of frequency to hold platform still in inertial space

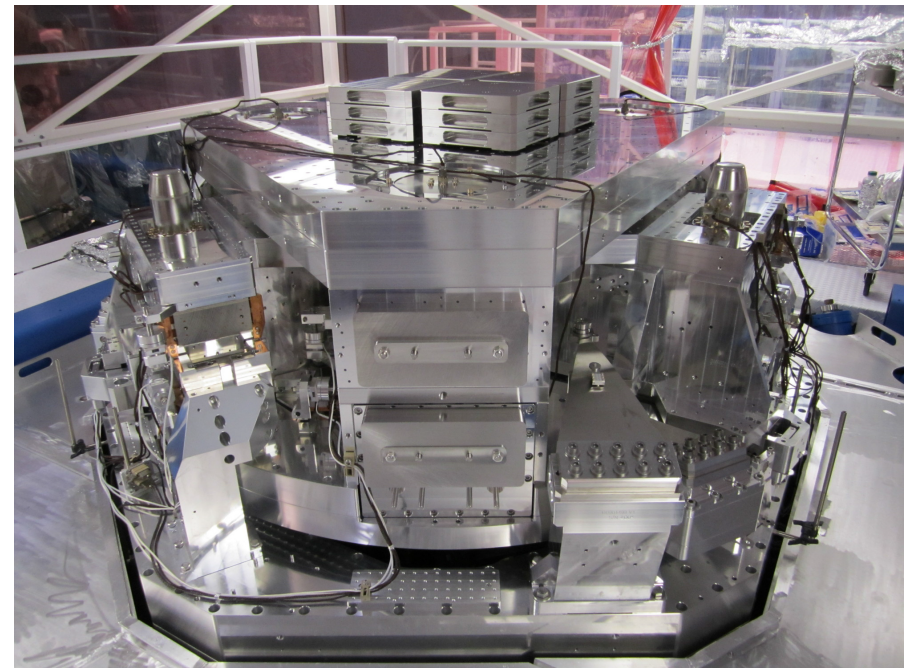
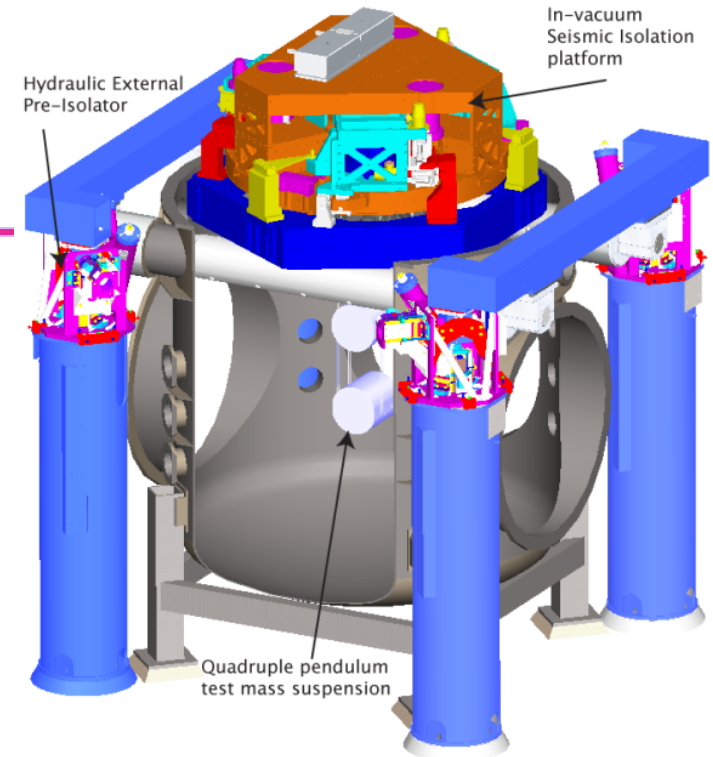



Where are we?

- What astrophysics can be accomplished with Advanced LIGO once commissioned?
- What is the status of the instrument?
- When do we have a chance of making a detection?



Observing Scenario, focus on NS-NS Binaries

<http://arxiv.org/abs/1304.0670>

Epoch	Estimated Run Duration	$E_{GW} = 10^{-2} M_{\odot} c^2$ Burst Range (Mpc)		BNS Range (Mpc)		Number of BNS Detections	% BNS Localized within	
		LIGO	Virgo	LIGO	Virgo		5 deg ²	20 deg ²
2015	3 months	40 – 60	–	40 – 80	–	0.0004 – 3	–	–
2016–17	6 months	60 – 75	20 – 40	80 – 120	20 – 60	0.006 – 20	2	5 – 12
2017–18	9 months	75 – 90	40 – 50	120 – 170	60 – 85	0.04 – 100	1 – 2	10 – 12
2019+	(per year)	105	40 – 80	200	65 – 130	0.2 – 200	3 – 8	8 – 28
2022+ (India)	(per year)	105	80	200	130	0.4 – 400	17	48

Advanced LIGO

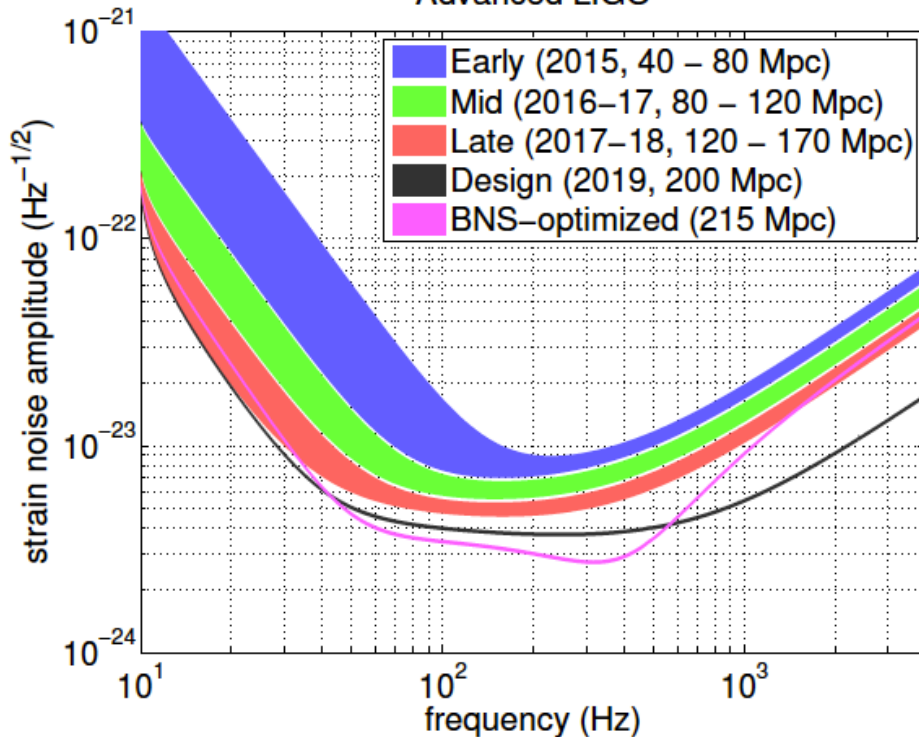

Binary Neutron Star Range :

Advanced LIGO: ~ 200 Mpc
“Realistic rate” ~ 40/year
 CQG, 27, 173001 (2010)

Initial LIGO: ~15 Mpc
 Rate ~1/50years



Very rapid progress – Current sensitivity acceptable for Fall run!

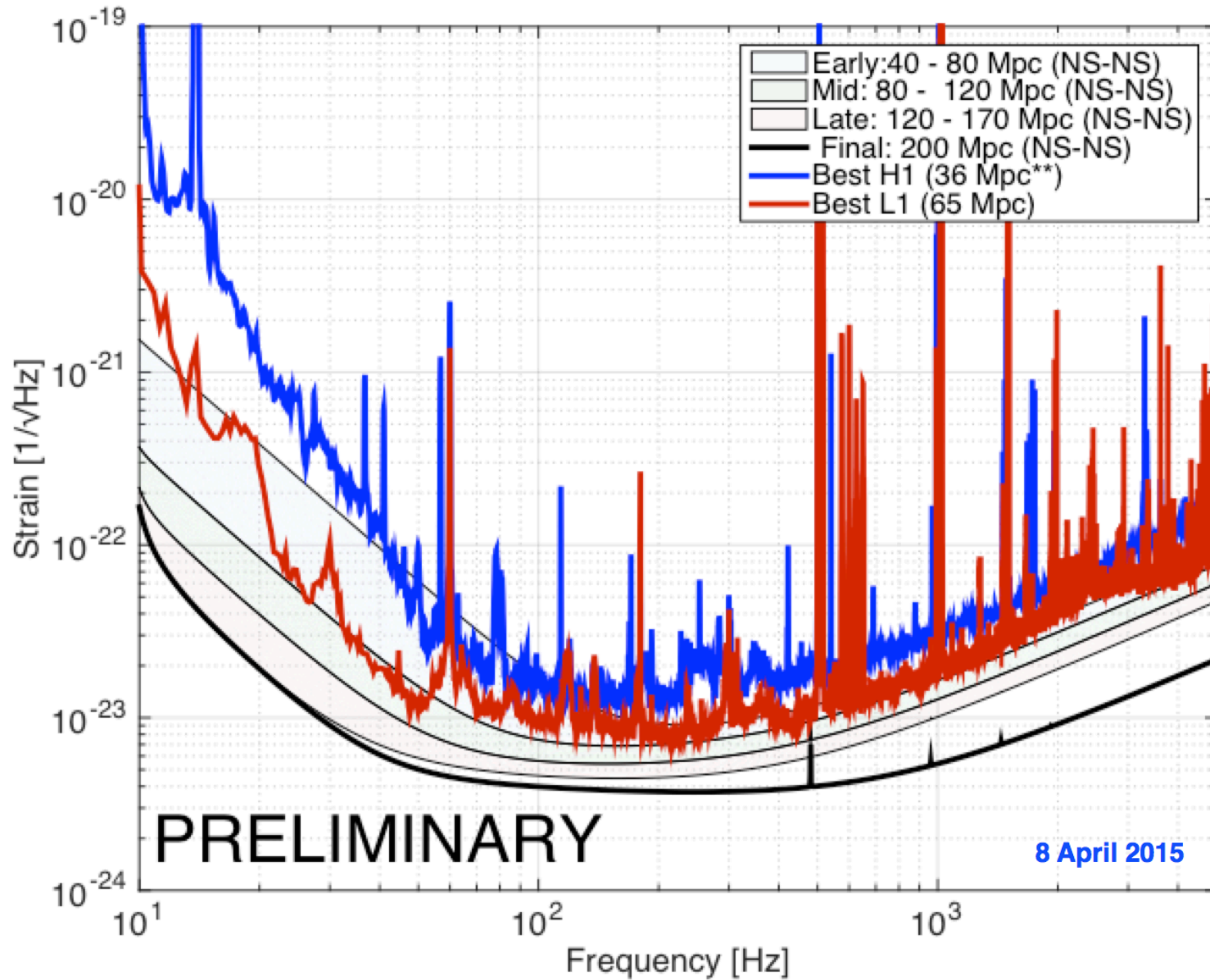

Enabling multi-messenger astronomy with gravitational waves

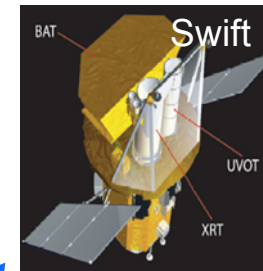
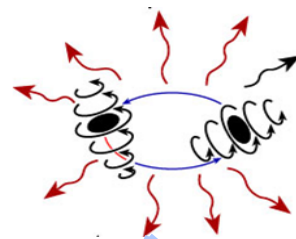
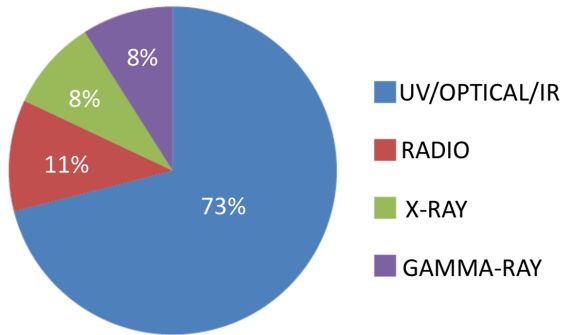

X-ray, γ -ray follow-up

- About 60 Partners from 19 countries
- About 150 instruments covering the full spectrum from radio to very high-energy gamma-rays

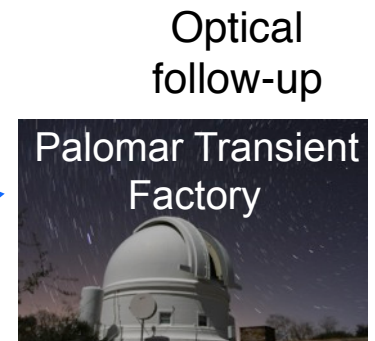
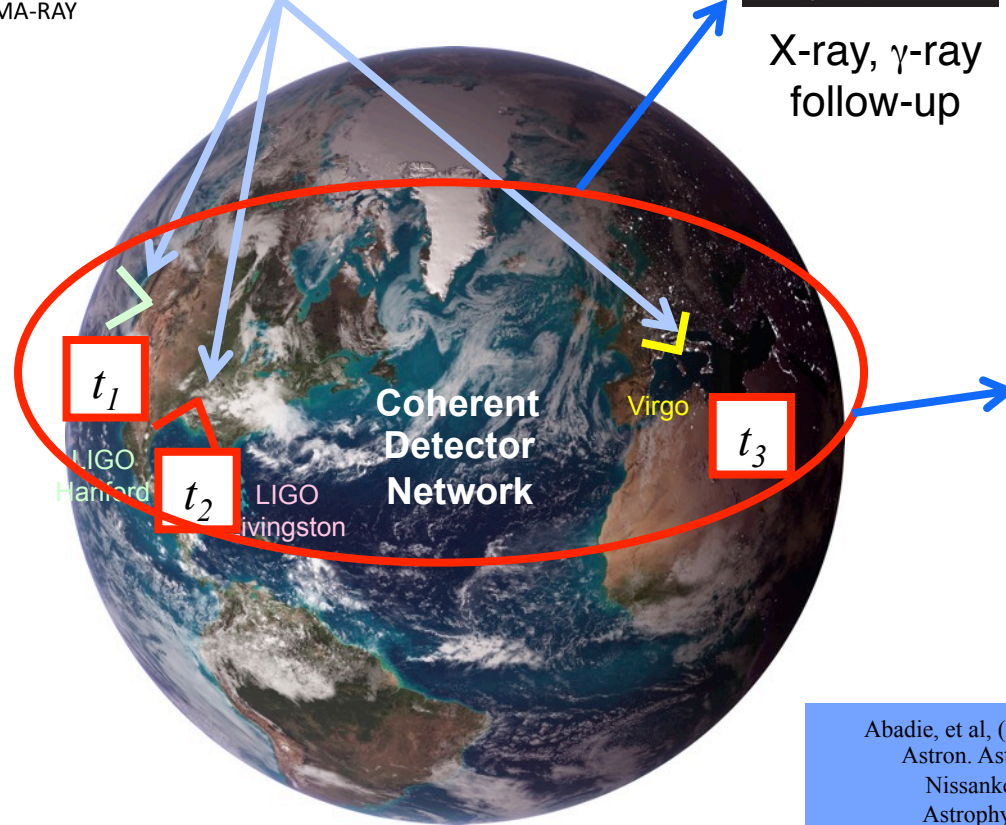

Abadie, et al, (LSC & Virgo Collaborations)
 Astron. Astrophys. 541 (2012) A155.
 Nissanke, Kalsiwal, Georgieva,
 Astrophysical J. 767 (2013) 124.
 Singer, Price, et al., Astrophysical J., 795 (2014)
 105.

Image:
<http://earthobservatory.nasa.gov/>



Future Improvements

- Need to have some detections – both to convince ourselves and others that it is worthwhile, and to help focus future astrophysics goals
- R&D continuing; see sensible paths in near and far time scales
- Factor ~ 1.7 in sensitivity: **possible as early as 2018**
 - » Would give increase in event rate of ~ 5
- Use of squeezed light expected (and demonstrated)
- Larger test masses to control radiation pressure noise, and for lower thermal noise
- Factor 10: **perhaps by 2035**
 - » Maybe a longer baseline – 40km instead of 4km
 - » Almost all noise sources stay constant – but signal grows a factor of 10
 - » Models indicate feasibility

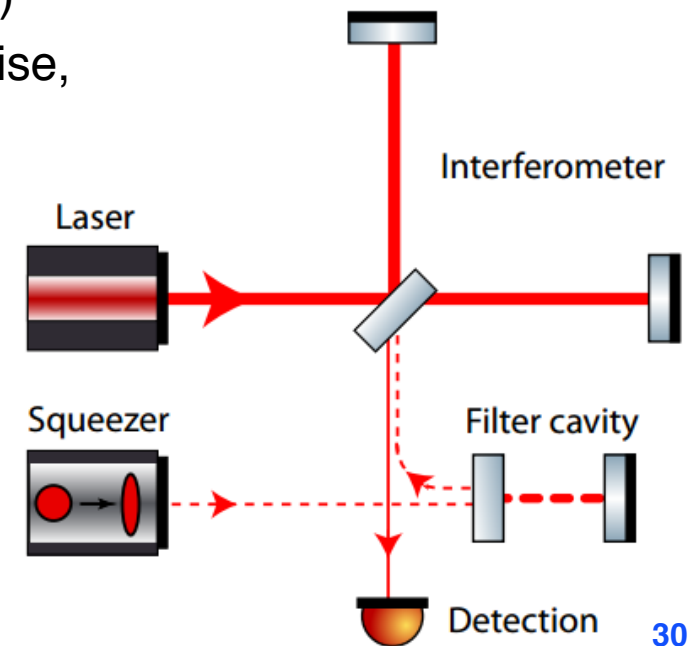
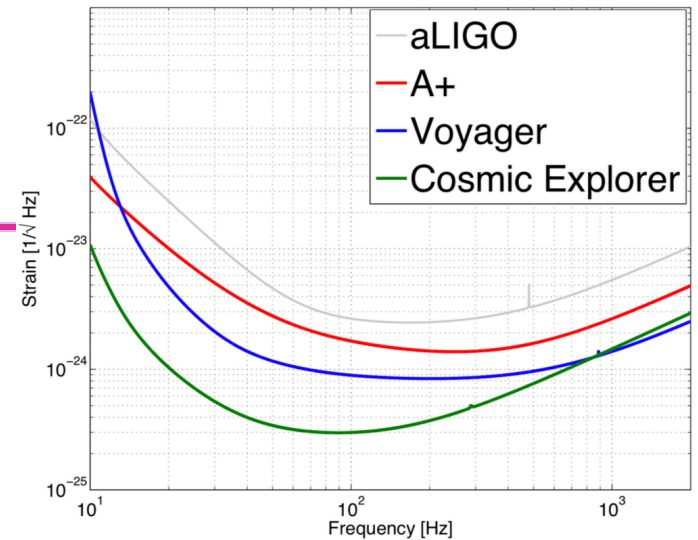



Next-to-last page Acknowledgments

Thanks to:



www.ligo.org



Support: National Science Foundation



The last page: A Familiar Story

- Often experimentalists find that they prove some even very fine theorists wrong
- In this case, it is a theorist – one A. Einstein – who helped enormously with the fundamentals of the experimental technique we use
- We are seeking to show that a paper published in 1916 was in error –
 - » *Einstein, A.: Näherungsweise Integration der Feldgleichungen der Gravitation, 1916* – in which he stated that gravitational waves do not exist!

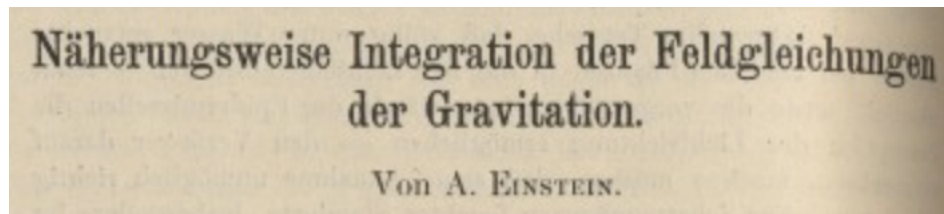

- **Believe we have a good chance to make a direct detection of Gravitational Waves 100 years after the publication of this paper**
 - » (and 98 years after the author's own correction of the error, in *Über Gravitationswellen, 1918*)

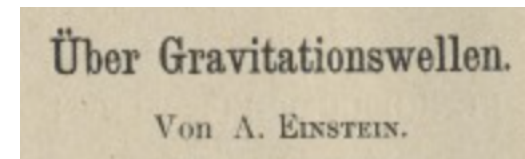

Here's hoping for a first detection in 2016!