

LIGO and its Scientific Collaboration



Gabriela González,
Louisiana State University
LIGO Scientific Collaboration
spokesperson



LIGO Scientific Collaboration

900+ members, 80+ institutions, 16 countries



LSC-USA

- Of LSC 900+ members, 500+ are in the USA.
- Large institutional diversity: large and small departments, graduate and undergraduate institutions, several serving large under-represented groups.
- Most US groups are supported by NSF by competitive, single investigator NSF grants. LIGO Laboratory (~25% of LSC) is supported by MRFC NSF grant to Caltech and MIT.
- Many LSC “graduates” now working in STEM industry (Intel, Synaptics, Google, SpaceX, Apple, Facebook,...), national facilities (Lincoln Labs, NASA, ...) and academia.



LIGO and LSC

- The LSC and the LIGO Laboratory together make up “LIGO”.
- LSC Mission: The LIGO Scientific Collaboration (LSC) is a **self-governing collaboration** seeking to detect gravitational waves, use them to explore the fundamental physics of gravity, and develop gravitational wave observations as a tool of astronomical discovery.
- LSC Responsibilities:
 - data analysis strategy, goals, and timeline, and carry out the data analysis program;
 - identify priorities for research and development, and carry out the R&D program;
 - carry out a public outreach, and provide educational opportunities for young people;
 - disseminate the results of the data analysis program and the R&D program;
 - participate in the scientific operations of the LIGO detectors;
 - perform internal evaluation of progress in data analysis and R&D.

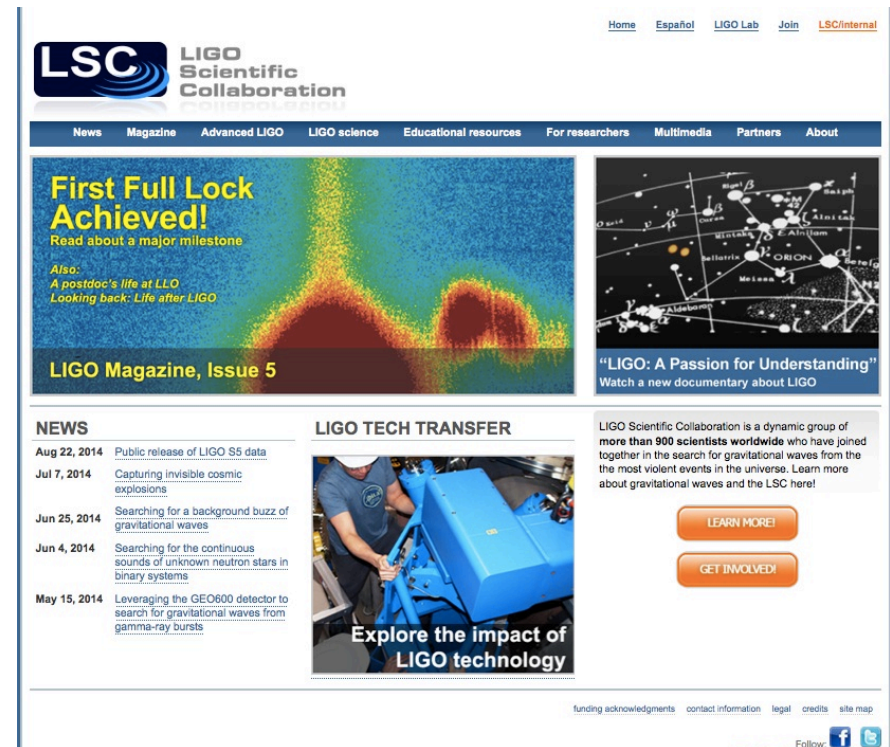

The screenshot shows the LIGO Scientific Collaboration website. At the top right, there are navigation links: Home, Español, LIGO Lab, Join, and LSC/internal. The main header features the LSC logo and the text "LIGO Scientific Collaboration". Below this is a dark blue navigation bar with links for News, Magazine, Advanced LIGO, LIGO science, Educational resources, For researchers, Multimedia, Partners, and About.

The main content area is divided into several sections:

- First Full Lock Achieved!**: A large banner with a colorful gravitational wave detection plot. Text includes "Read about a major milestone", "Also: A postdoc's life at LLO", "Looking back: Life after LIGO", and "LIGO Magazine, Issue 5".
- LIGO Magazine, Issue 5**: A smaller banner with a star map.
- NEWS**: A list of recent news items:
 - Aug 22, 2014: Public release of LIGO S5 data
 - Jul 7, 2014: Capturing invisible cosmic explosions
 - Jun 25, 2014: Searching for a background buzz of gravitational waves
 - Jun 4, 2014: Searching for the continuous sounds of unknown neutron stars in binary systems
 - May 15, 2014: Leveraging the GEO600 detector to search for gravitational waves from gamma-ray bursts
- LIGO TECH TRANSFER**: A section featuring a photo of a person working on a blue piece of equipment. Text says "Explore the impact of LIGO technology".
- LIGO Scientific Collaboration is a dynamic group of more than 900 scientists worldwide**: A text block describing the collaboration's mission. Below it are two orange buttons: "LEARN MORE!" and "GET INVOLVED!".

At the bottom of the page, there are links for "funding acknowledgments", "contact information", "legal", "credits", and "site map". On the right, there are social media icons for Facebook and Twitter, with the text "Follow:" next to them.

www.ligo.org

LIGO leads but it's not alone: gravitational wave network

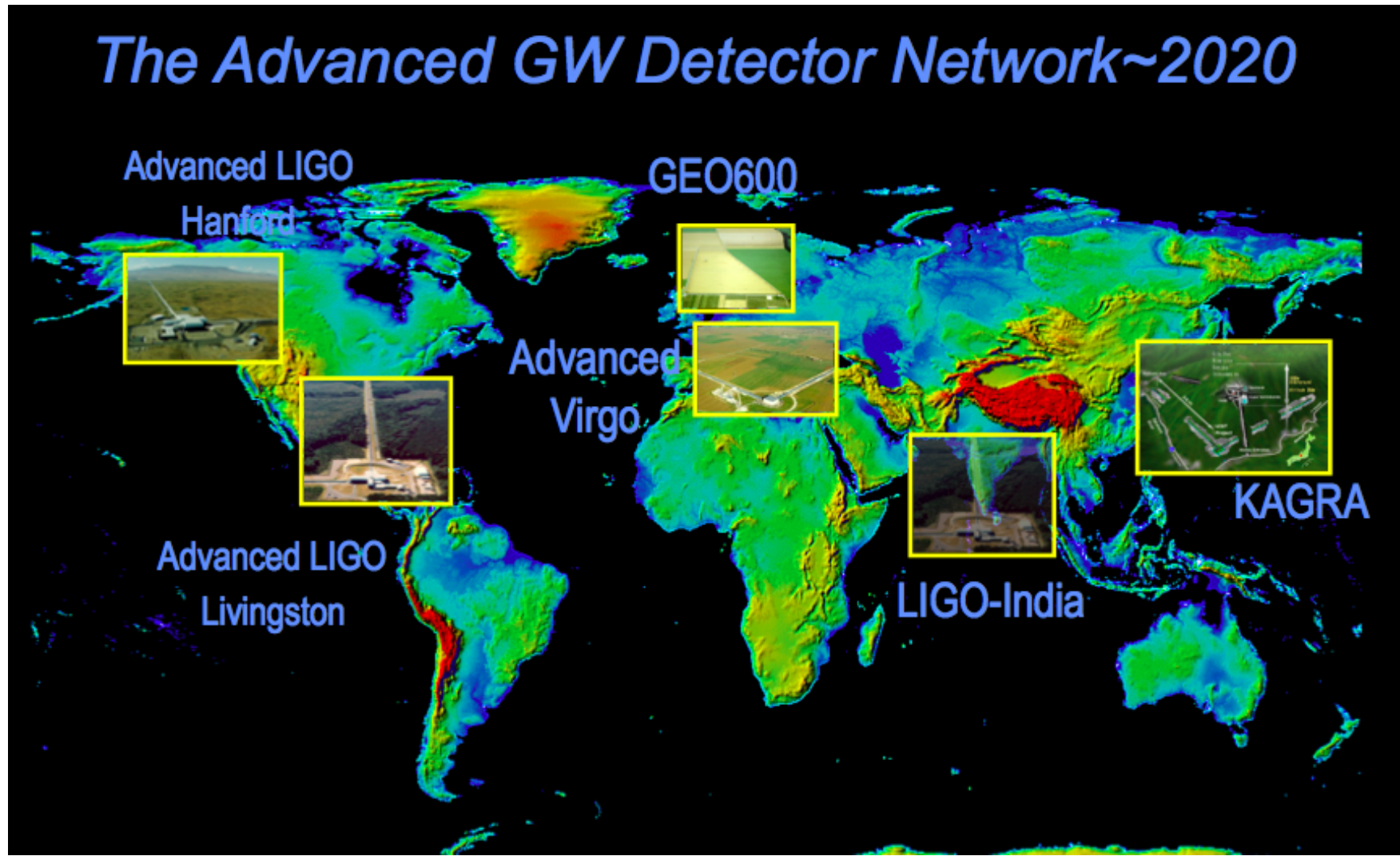

LIGO Detectors Technology

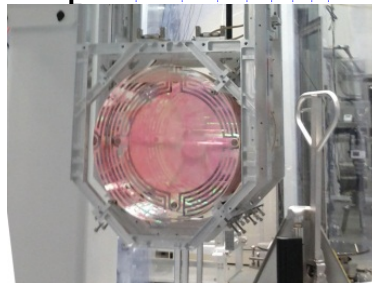
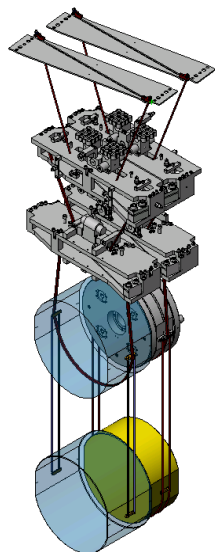
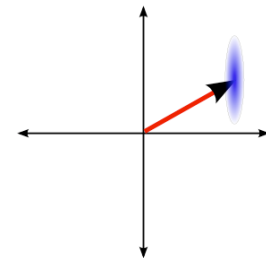
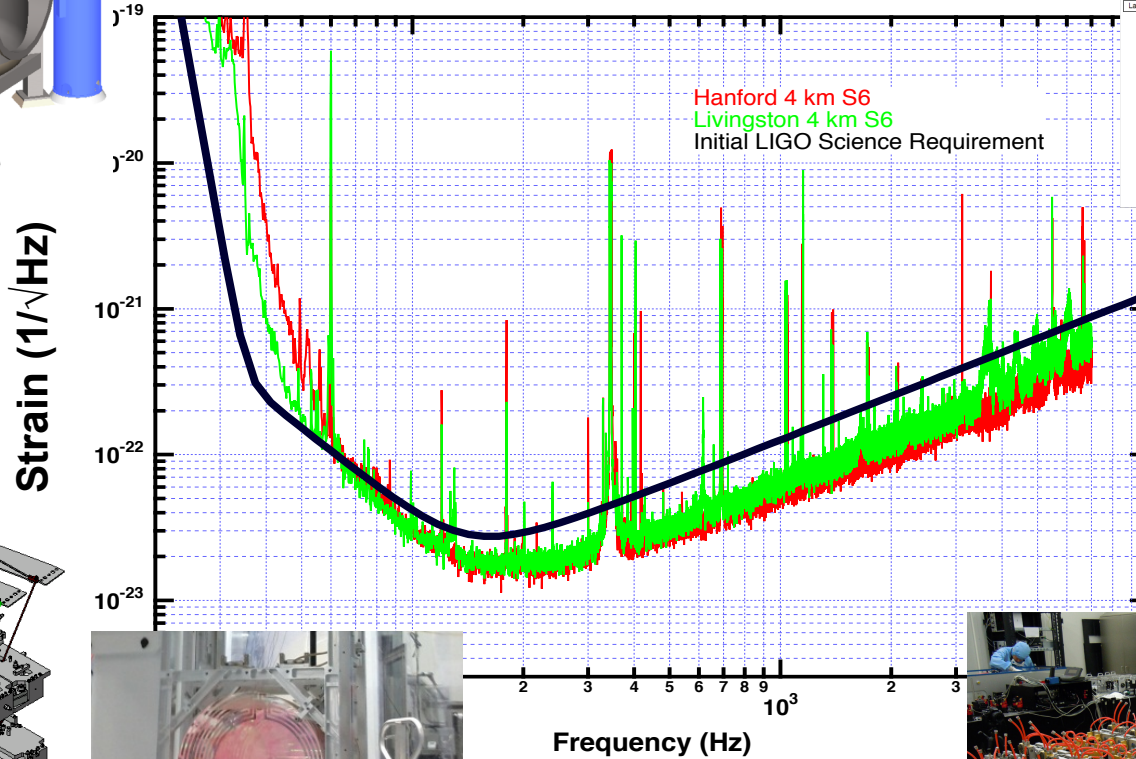
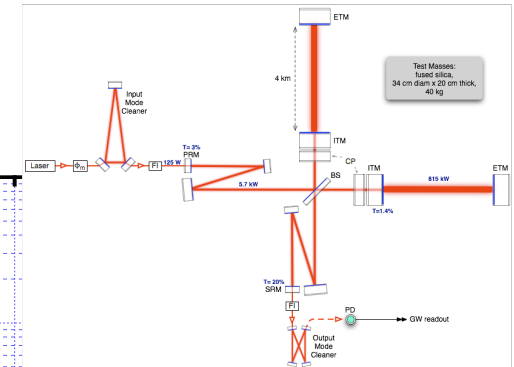
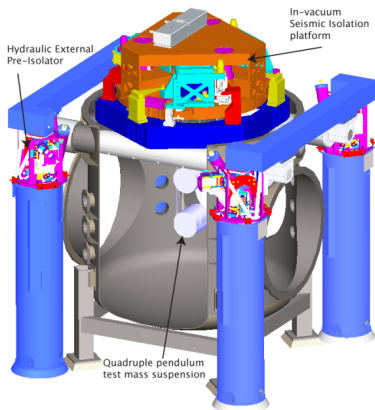

Five instrumental working groups – white paper LIGO-T1400316 (dcc.ligo.org).

LIGO Data Analysis

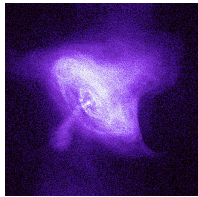

Crab pulsar (NASA, Chandra Observatory)

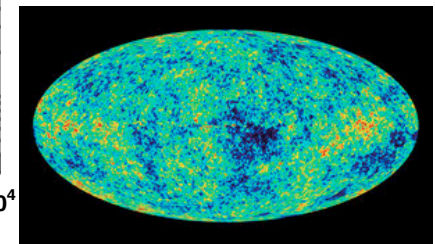
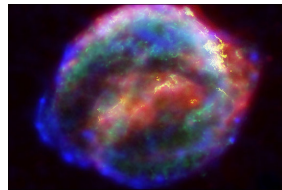
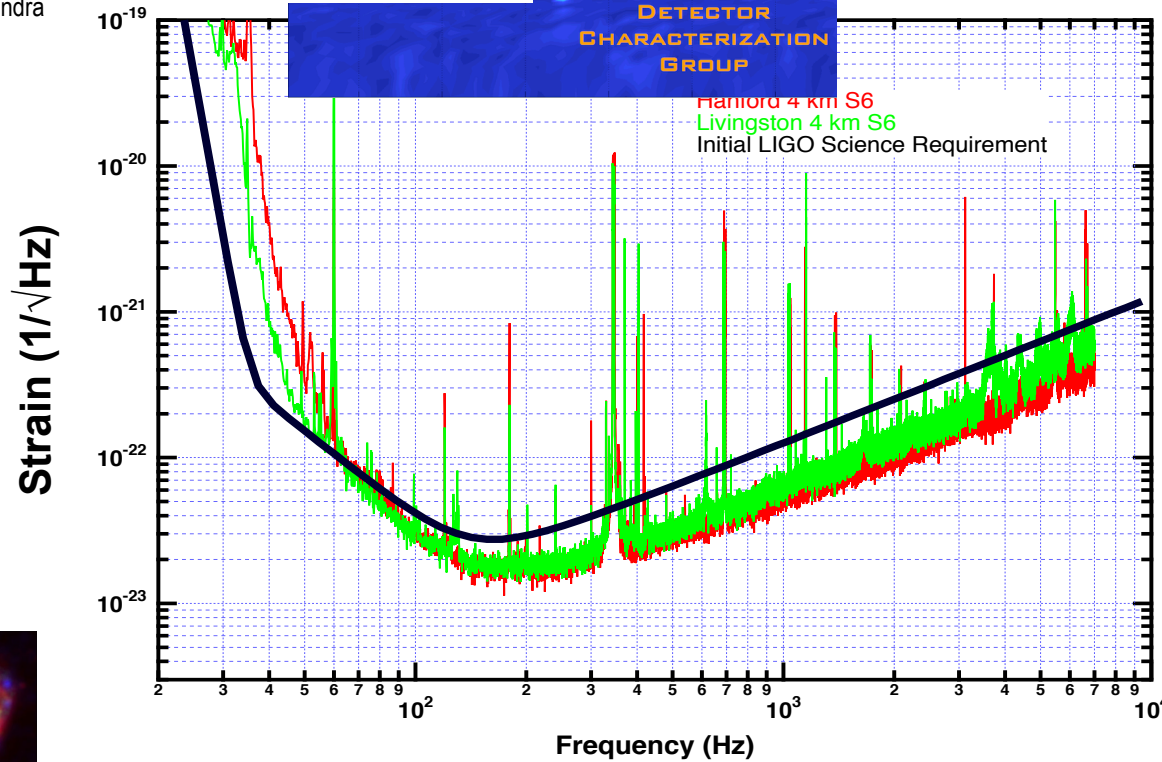
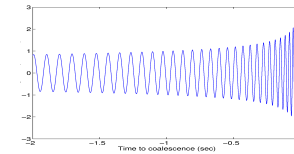
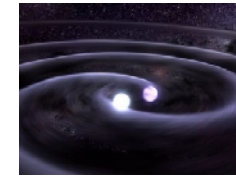
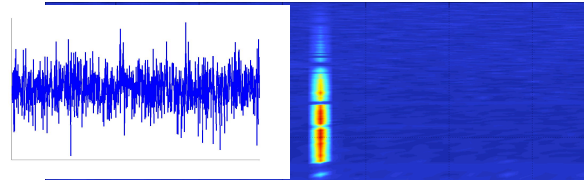
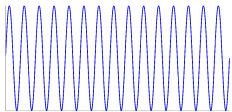

NASA, WMAP

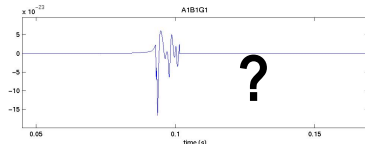
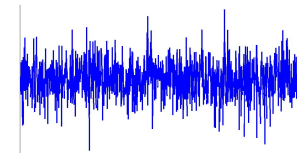

Four analysis working groups (plus detector characterization, software and computing) white paper LIGO-T1400054 (dcc.ligo.org).

LIGO-Virgo detectors 2005-2010

atlasoftheuniverse.com

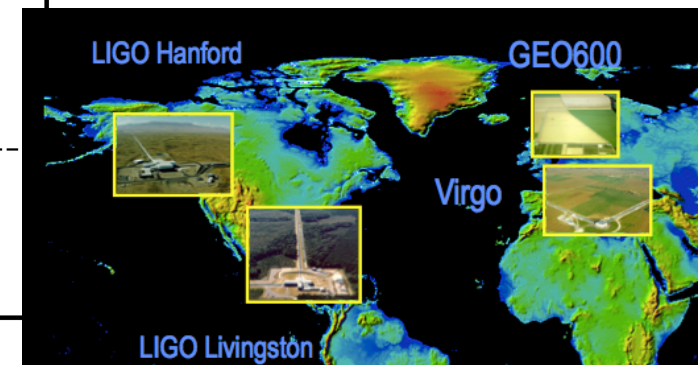
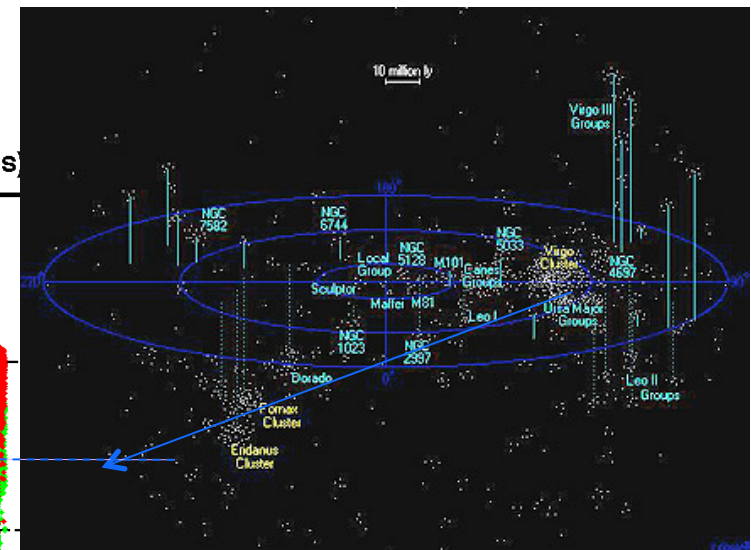
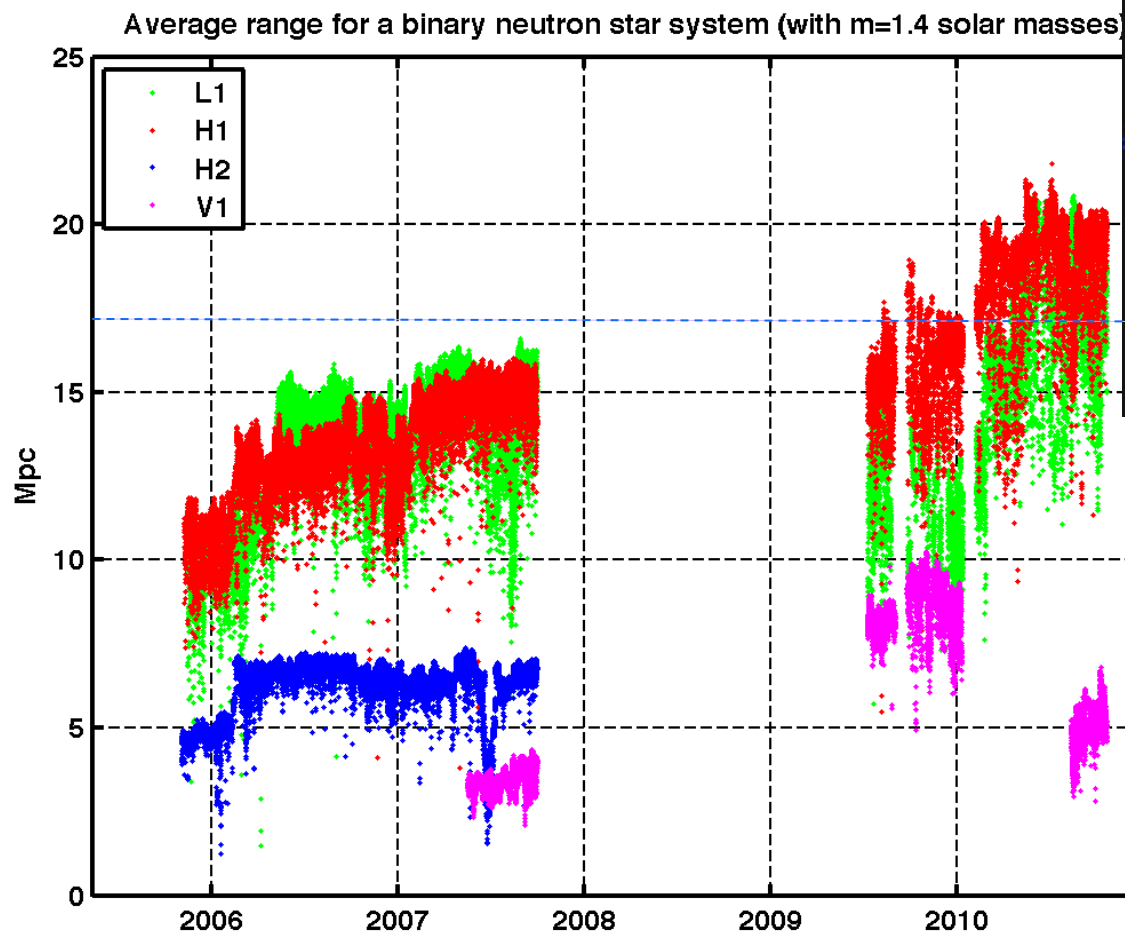

Advanced LIGO current status

Is already better than S6! L1 detector, Sept 25: 30+ Mpc!

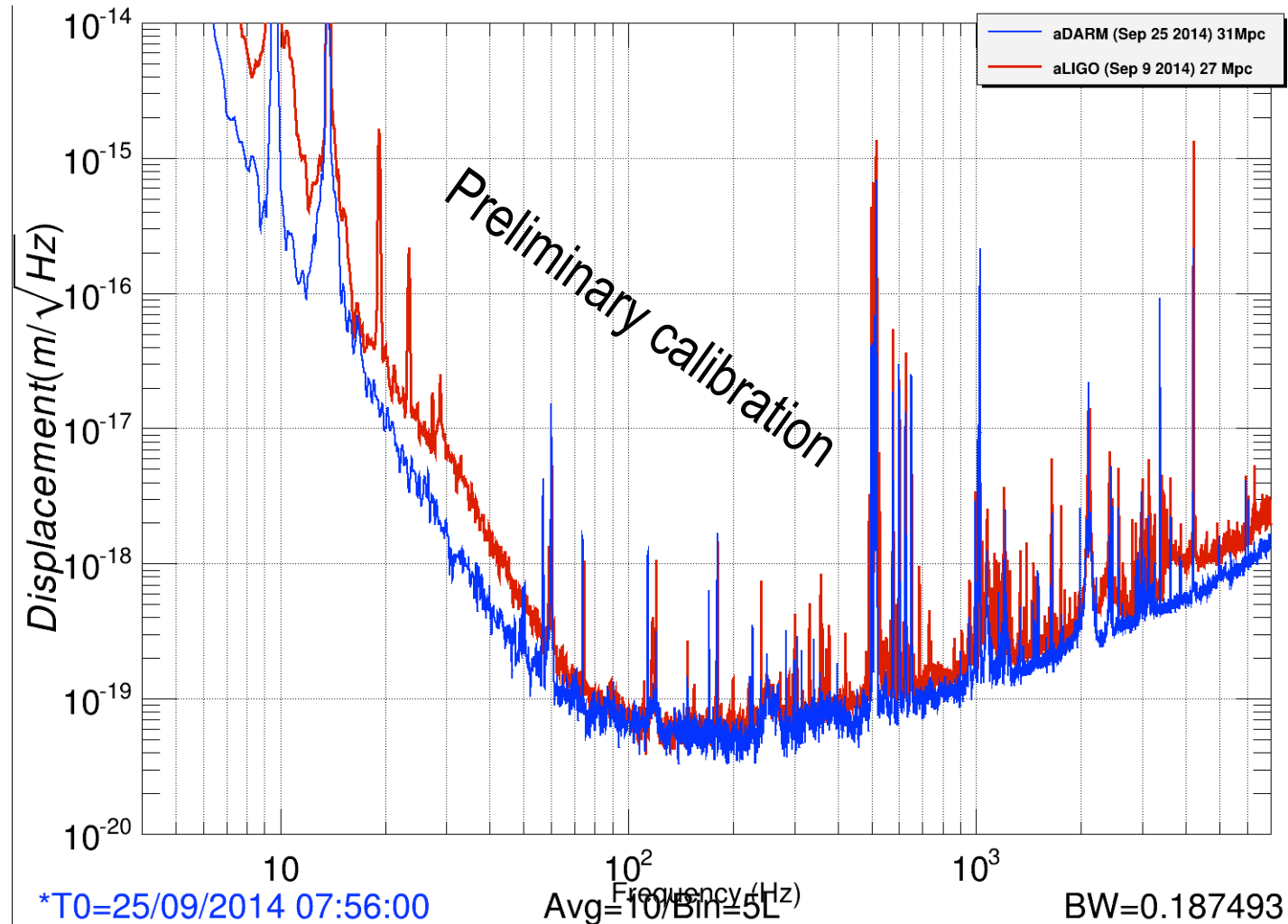

Academic interest in LIGO

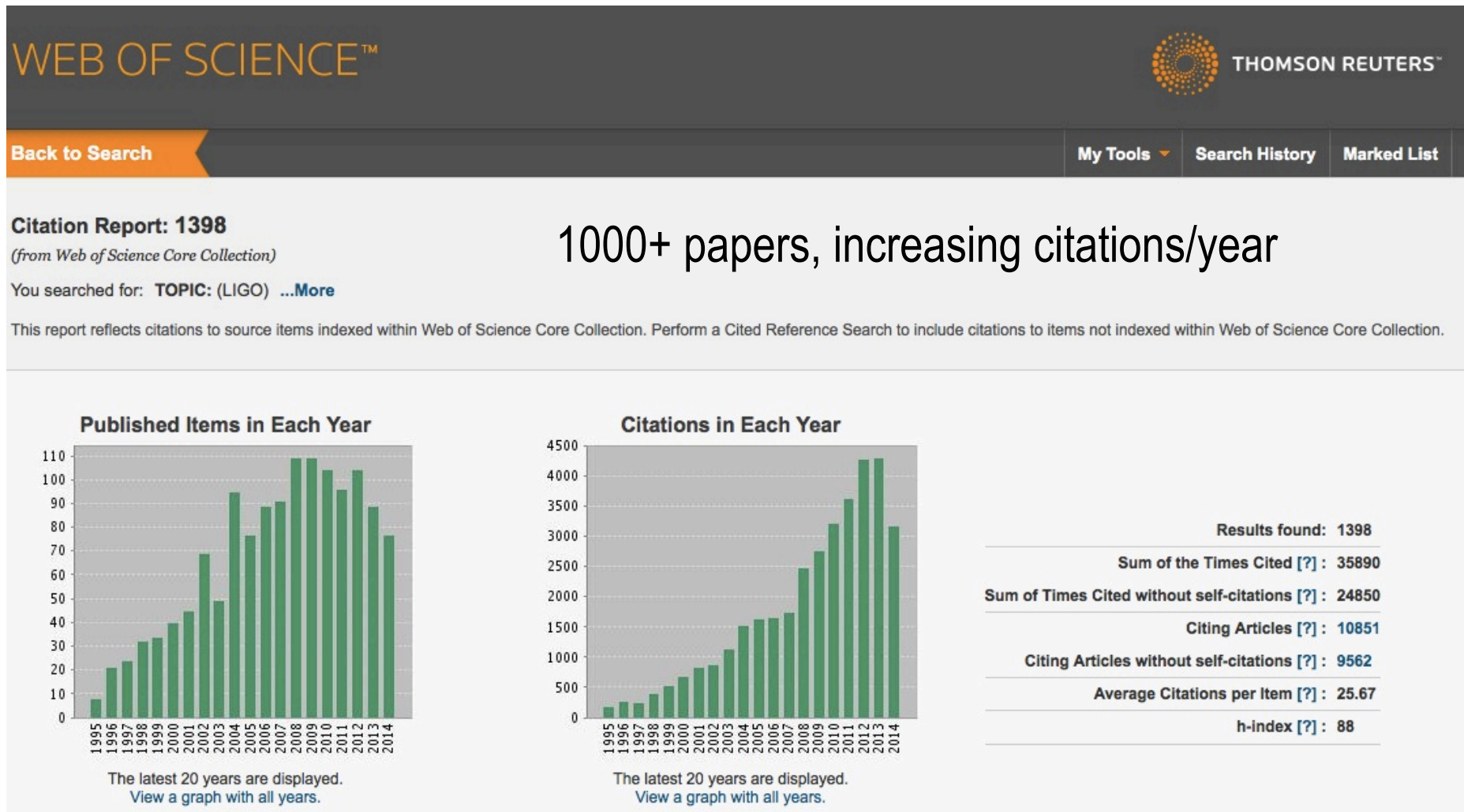

September 2014

Latest LSC papers

SUMMARIES OF LSC SCIENTIFIC PUBLICATIONS

We now feature, for each new research article, a summary written for the general public with a downloadable and printable flyer in PDF format.

2014

- Jul 7, 2014** [Capturing Invisible Cosmic Explosions \[flyer\]](#)
- Jun 25, 2014** [Searching for a Background Buzz of Gravitational Waves \[flyer\]](#)
- Jun 4, 2014** [Searching for the Continuous Sounds of Unknown Neutron Stars in Binary Systems \[flyer\]](#)
- May 15, 2014** [Leveraging the GEO600 Detector to Search for Gravitational Waves from Gamma-ray Bursts \[flyer\]](#)
- Apr 15, 2014** [Searching for Gravitational Waves Associated with Gamma-ray Bursts Detected by the InterPlanetary Network \[flyer\]](#)
- Apr 09, 2014** [Observing the Invisible Collisions of Intermediate Mass Black Holes \[flyer\]](#)
- Mar 26, 2014** [Ringing of the Cosmic Bells: A Search for Black Hole Vibrations \[flyer\]](#)
- Feb 24, 2014** [All-sky Search for Continuous Gravitational Waves in the Virgo Data \[flyer\]](#)
- Jan 16, 2014** [Can we Hear Black Holes Collide? Testing Our Search Methods using Numerically Generated Gravitational-wave Signals \[flyer\]](#)

2013

- Nov 14, 2013** [Do Cosmic Strings Exist? \[flyer\]](#)
- Nov 14, 2013** [Searching for Continuous Gravitational Wave Signals with the Hough Transform \[flyer\]](#)
- Oct 16, 2013** [Scanning the Skies for Cosmic Explosions: First Search for Optical Counterparts to](#)

You searched for: **AUTHOR:** (Saulson AND Gonzalez AND Weiss) ...[More](#)

This report reflects citations to source items indexed within All Databases.

Published Items in Each Year

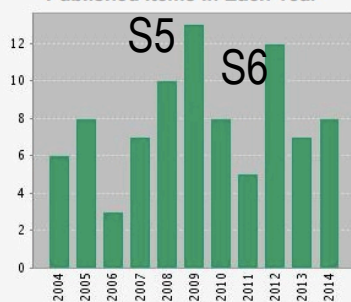

Citations in Each Year

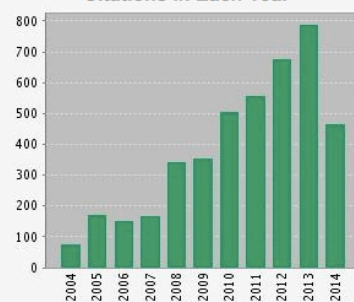

Results found: 87

Sum of the Times Cited [?]: 4278

Sum of Times Cited without self-citations [?]: 3761

Citing Articles [?]: 1603

Citing Articles without self-citations [?]: 1520

Average Citations per Item [?]: 49.17

h-index [?]: 39

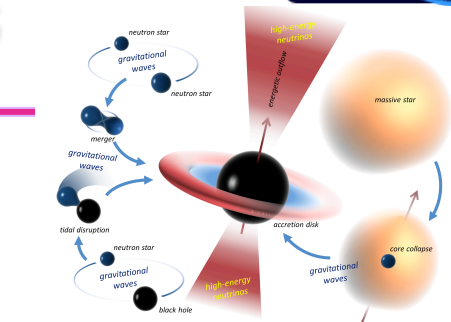

Credit: I. Bartos/Based on arXiv:1212.2289

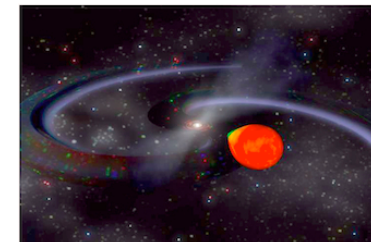
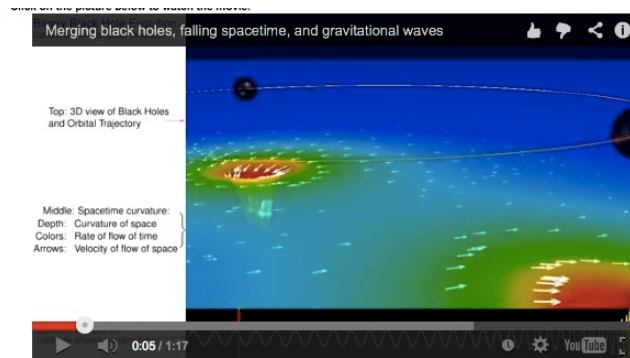

Courtesy of NASA Goddard

LIGO and the National Cyberinfrastructure

- Gravitational-wave science is Big Science on Big Data - petascale data sets through massive workflows
- LIGO has driven development in
 - Computing clusters (e.g. exploration of consumer-grade GPUs for science)
 - Crowd-sourced computing (e.g. Einstein at Home)
 - Scientific workflow management (e.g. Condor and Pegasus)
 - Federated identity management (e.g. Co-manage and Shibboleth)
- Gravitational-wave science trains people with real world computing skills that are applicable to many scientific domains and to industry



LIGO open data

LIGO is committed to open data and prompt release of GW observations.

Much development is needed for releasing LIGO data - prototyping with initial LIGO data: S5 is now public.

- Getting Started
- Data & Catalogs
- Timelines
- Tutorials
- Software
- My Sources
- GPS ↔ UTC
- About LIGO
- Student Projects
- Acknowledgement

Welcome to the LIGO Open Science Center

This site provides access to data from the LIGO observatories and associated software tools. Please click below to join the email list, so that we can inform you of updates and data releases from this site.

[Click to join the email list](#)

If this is your first visit to the site, we suggest you **START HERE**.

For general information on LIGO, please visit ligo.org.
If you have LSC credentials, you may go to the [development site](#).



LIGO Hanford Observatory, Washington (Image: C.Gray)



LIGO Livingston Observatory, Louisiana (Image: J.Glaime)

<https://losc.ligo.org/>

Some S5/S6 LSC results

- Best experimental limits to cosmic GW background around 100 Hz ([Nature 460 \(2009\) 990](#))
- Limits on GW radiation from known pulsars: “mountains” on Crab are less than 1m high ([Astrophys. J. 785 \(2014\) 119](#))
- Multi-messenger searches for GW transients in coincidence with neutrinos, gamma ray bursts, soft gamma repeaters, pulsar glitches, magnetars, ...
- We can detect GWs! [Phys. Rev D85 \(2012\) 082002](#)

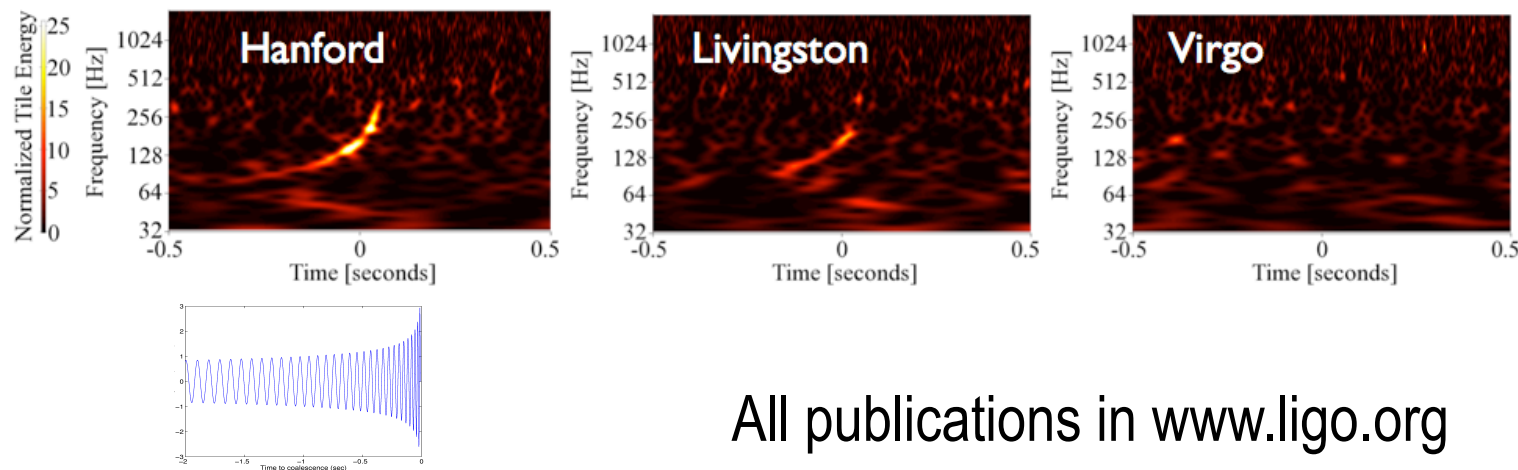

All publications in www.ligo.org

The future is coming – soon!

- Prospects for Localization of Gravitational Wave Transients by the Advanced LIGO and Advanced Virgo Observatories, The LIGO Scientific Collaboration and The Virgo Collaboration, [arXiv:1304.0670](https://arxiv.org/abs/1304.0670)

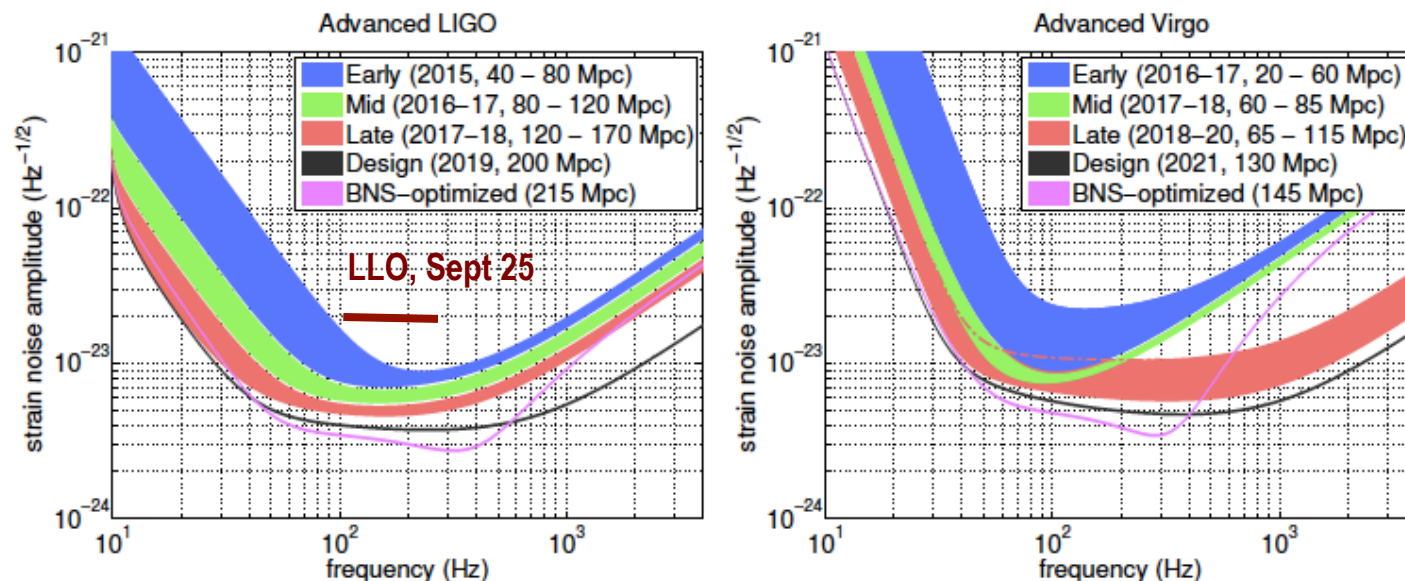

Figure 1: aLIGO (left) and AdV (right) target strain sensitivity as a function of frequency. The average distance to which binary neutron star (BNS) signals could be seen is given in Mpc. Current notions of the progression of sensitivity are given for early, middle, and late commissioning phases, as well as the final design sensitivity target and the BNS-optimized sensitivity. While both dates and sensitivity curves are subject to change, the overall progression represents our best current estimates.

Observing Scenario

Epoch	Estimated Run Duration	$E_{\text{GW}} = 10^{-2} M_{\odot} c^2$ Burst Range (Mpc)		BNS Range (Mpc)		Number of BNS Detections	% BNS Localized within	
		LIGO	Virgo	LIGO	Virgo		5 deg ²	20 deg ²
2015	3 months	40 – 60	–	40 – 80	–	0.0004 – 3	–	–
2016–17	6 months	60 – 75	20 – 40	80 – 120	20 – 60	0.006 – 20	2	5 – 12
2017–18	9 months	75 – 90	40 – 50	120 – 170	60 – 85	0.04 – 100	1 – 2	10 – 12
2019+	(per year)	105	40 – 80	200	65 – 130	0.2 – 200	3 – 8	8 – 28
2022+ (India)	(per year)	105	80	200	130	0.4 – 400	17	48

Table 1: Summary of a plausible observing schedule, expected sensitivities, and source localization with the advanced LIGO and Virgo detectors, which will be strongly dependent on the detectors' commissioning progress. The burst ranges assume standard-candle emission of $10^{-2} M_{\odot} c^2$ in GWs at 150 Hz and scale as $E_{\text{GW}}^{1/2}$. The burst and binary neutron star (BNS) ranges and the BNS localizations reflect the uncertainty in the detector noise spectra shown in Fig. 1. The BNS detection numbers also account for the uncertainty in the BNS source rate density [28], and are computed assuming a false alarm rate of 10^{-2} yr^{-1} . Burst localizations are expected to be broadly similar to those for BNS systems, but will vary depending on the signal bandwidth. Localization and detection numbers assume an 80% duty cycle for each instrument.

Planned O1 searches

Described in public white paper LIGO–T1400054

- All-sky burst search
- Binary neutron star coalescences
- Stellar-mass binary black holes coalescences
- Neutron star-black hole coalescences
- Intermediate mass black hole binary coalescences
- GRB sources of transient gravitational waves
- All-sky searches for isolated spinning neutron stars
- Targeted searches for gravitational waves from known pulsars
- Isotropic stochastic gravitational wave background
- Directional search for persistent gravitational waves
- ... other plans in preparation

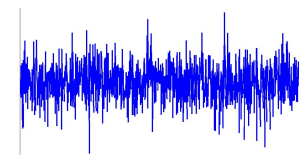
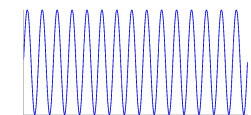
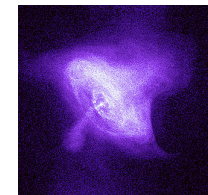
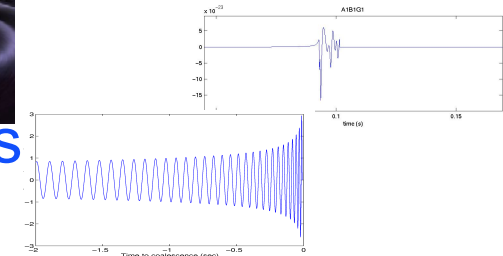
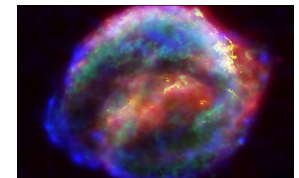
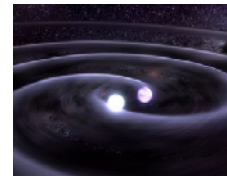

Detection and GR tests

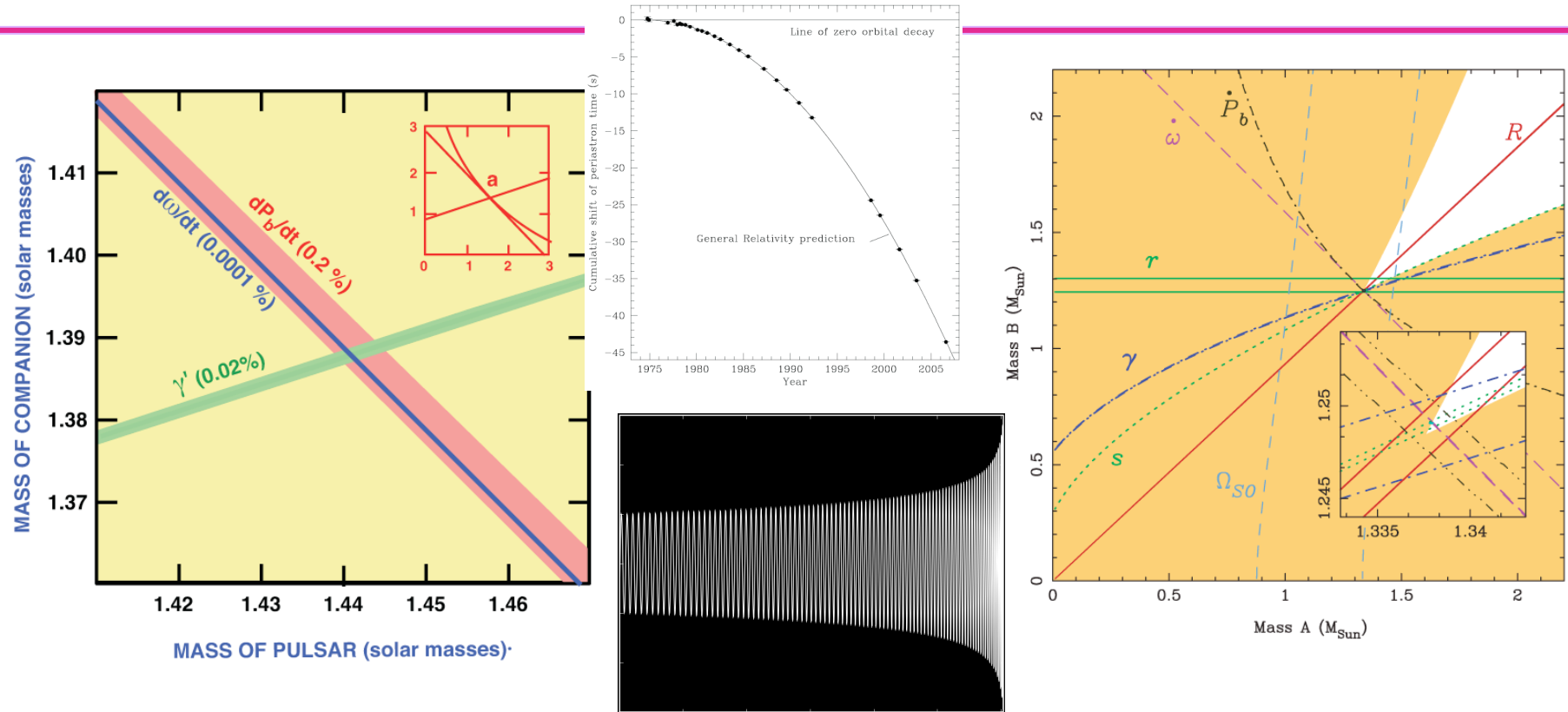

Pulsar tests measure leading orders in orbit decay.
 Waveforms in GW detectors will measure the coalescence, millions of years later, in the extreme strong gravity regime: birth of black holes!

Living Rev. Relativity, 17 (2014), 4

Numerical relativity

- There are good numerical results for a given system – computationally expensive, but they are doable! (not true before ~2005)
- There are parameterized approximations that fit numerical results, and a collaboration to produce these: “**NRAR**” collaboration, numerical and analytical relativity communities.
- Efficiency of analysis methods with PN or phenomenological approximations can be tested against numerical models: “**NINJA collaboration**”: LVC and NR communities. Most useful for post-detection parameter estimation.

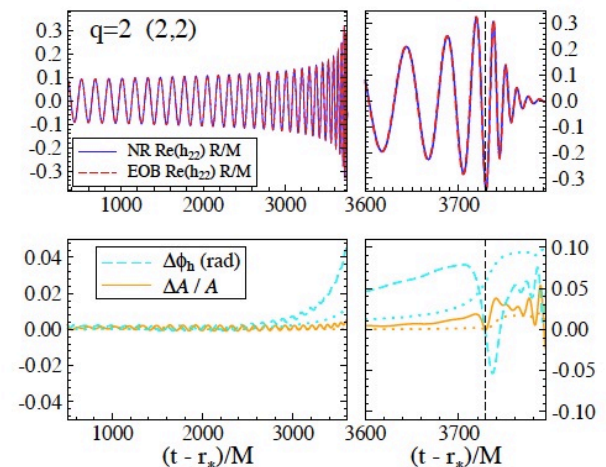
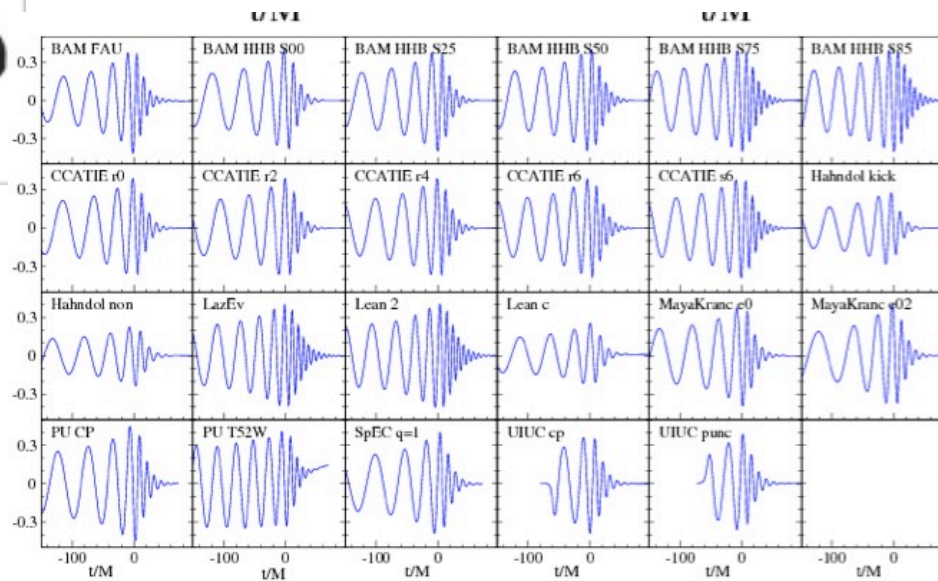

Phys.Rev. D84 124052

Class.Quant.Grav. 26 (2009) 165008

Astrophysics with GW detections: parameter estimation



After a search algorithm finds a candidate with some confidence, we can run (computationally expensive) parameter estimation studies, using many different models of waveforms with many possible parameters.

<http://www.ligo.org/science/Publication-S6PE/>

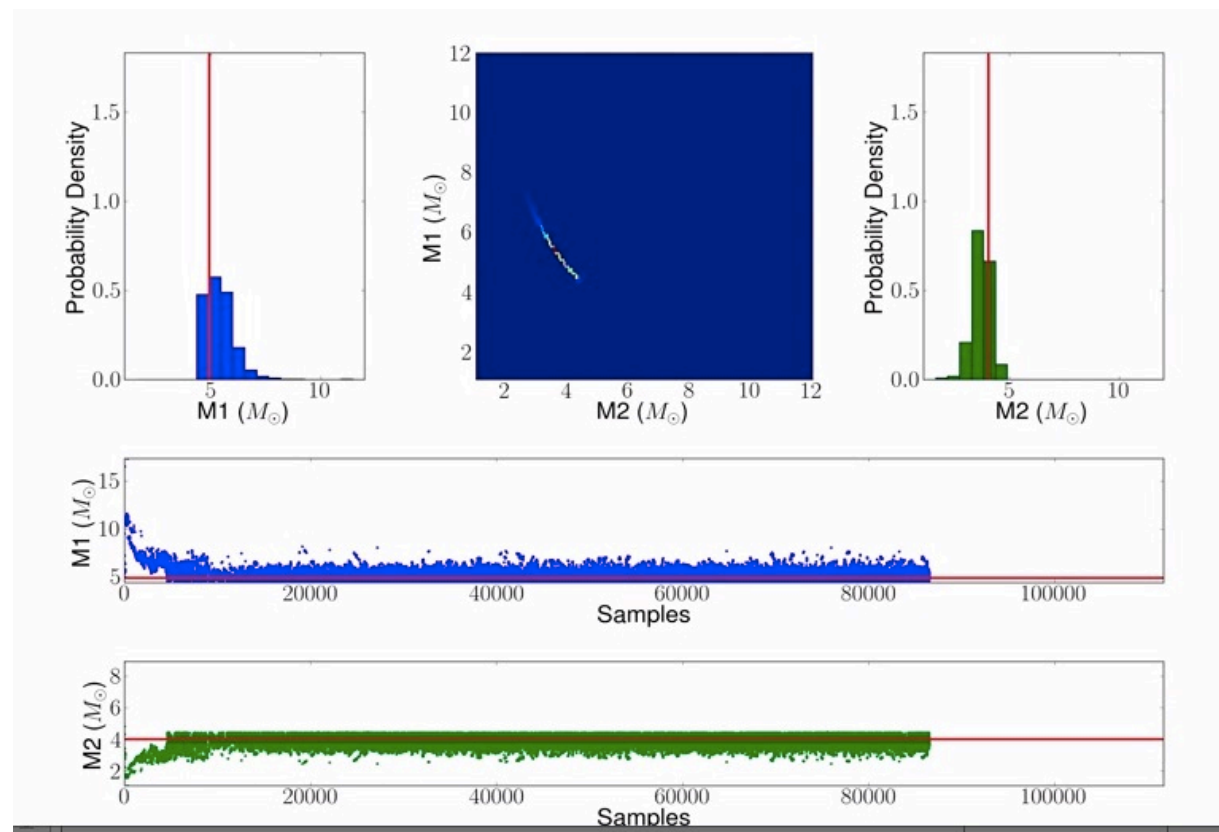

Multi-messenger astronomy: GW/EM observations



We will obtain rich astrophysics combining gravitational-wave and electromagnetic information.

- LSC and Virgo opened a call to sign agreements for the identification of EM counterparts to GW triggers in Advanced detectors starting in 2015.
- We received and approved more than 60 applications from 19 countries, with about 150 instruments covering the full spectrum, from radio to high-energy gamma-rays!
- Shortly after a few detections, LSC/Virgo will publicly release GW triggers for follow up.



LIGO-G1401102

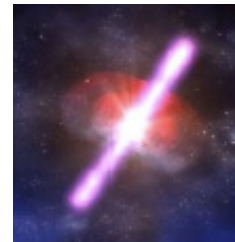

Other important LSC activities

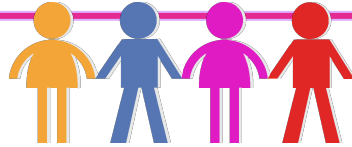

- Diversity

- LSC has a “Diversity Committee. Some initiatives:
 - LSC Diversity statement; anti-harassment policy, LSC “best practices”
 - LSC “Ombudsperson” (former NSF program officer!)
 - LIGO summer undergraduate fellowships sponsored by NSBP and NSHP
 - “Family grants” to attend LSC meetings
 - Set up a booth and organize sessions in scientific meetings of women and minorities



Corey Gray

Corey Gray has served as an operations specialist at LIGO Hanford since 1998. A graduate of Humboldt State University with a B.S. in physics and mathematics, Corey enjoys participating in public outreach activities that connect with students and adults of all ages. He is a member of the Siksika Nation.

LIGO goes to SACNAS

- Academic mentoring

- The LSC has an “Academic Advisory Committee” to care about mentoring of young members. Some recent activities:
 - Student and postdoc events and useful tutorials.
 - “Industry panels” with colleagues working now in industry.
 - Mentoring program: a platform for members of the LSC to form and maintain mentoring relationships.



Telling our story

- Education and Public Outreach is a very active LSC working group
- www.ligo.org, LIGO magazine, science summaries, documentaries, Facebook, Twitter, and much more!



Major milestone:
First full lock
achieved!

Life at the Louisiana site
– LIGO Livingston:
A postdoc's experience p. 6



The Transmission Monitor
Suspension Telescope
Auxiliary optics p. 10



www.ligo.org/magazine

LIGO Science Education Center

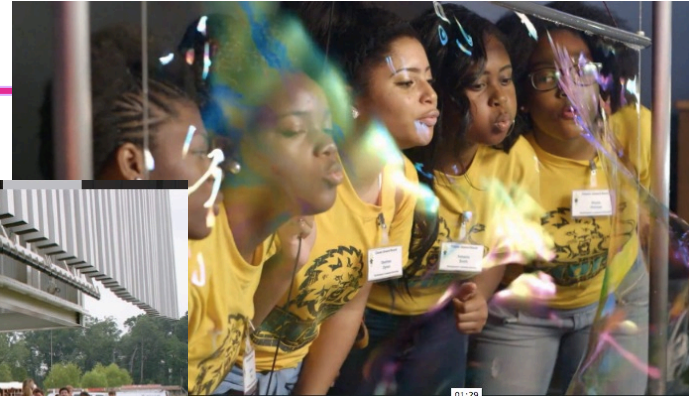

An Interactive, Exhibit-Based Science and Mathematics Learning Center

LIGO Science Education Center has over 40 interactive, hands-on exhibits that relate to the science of LIGO. We host field trips for students, teacher training programs, and tours for the general public. Explore science concepts such as light, gravity, waves, and interference; learn about LIGO's search for gravitational waves; and interact with our scientists and engineers.

Follow Us on [Facebook](#) !

LIGO is supported
by:



The National Science
Foundation (NSF)

Any opinions, findings,
conclusions or
recommendations expressed
here are those of the
author(s) and do not
necessarily reflect the view
of the NSF.

FIELD TRIPS:

Registration for the Fall 2014 Semester Field trips is now closed.
Registration for the Spring Semester is open. Please note that scheduling
and confirmation will begin in November.
Please click on the link below to complete this form:
[Field Trip Request Form](#)

SCIENCE SATURDAY

Every third Saturday of each month; 1:00 p.m. - 5:00 p.m

Exhibit Hall Exploration	Topic Demonstrations	LIGO Videos
Topic Related Activity	Q&A with Scientist, Guest Speakers, and Science Specialist	Control Room Tours

LIGO Livingston concentrates its outreach resources on teachers and students, striving to enhance their exposure to cutting-edge physics research. Science Saturday caters to families and the general public. No reservation is required for individuals or groups less than 15. Although we encourage visits on these Saturdays, large groups may request a tour on other dates using the following [link](#).

SCIENCE SATURDAY DATES

- August 16th**
Program Topic: Feels like pressure
- September 20th**
Program Topic: Fall into Science
- October 18th**
Program Topic: Appear to Disappear
- November 15th**
Program Topic: Cafe Style Science
- December 20th**
Program Topic: Year in Review

PARTNERS



LIGO
Hanford



Recent LIGO documentaries



WATCH NOW: 'LIGO, A Passion for Understanding' Documentary Premiere

By Space.com Staff | April 15, 2014 09:35am ET

847

Share

117

Tweet

242

Submit

8

Reddit

More



You can now watch a new, 20-minute [film](#) that chronicles the people and strange science behind an amazing astronomical tool that uses lasers to search for violent cosmic events trillions of miles from Earth. The

- New York, May 29-Jun 2, 2013

INNOVATION ALLEY

CoderDojo

Coding = fun! Learn how to code and check out games made by other CoderDojo kids.

Blue Man Group

Make music and a light show on this one-of-a-kind instrument, equipped with acoustics, electronic sounds, and LED lighting.

New York City/New Jersey FIRST Robotics

Robots alive! Join the New York City/New Jersey FIRST robotic team to take control of state-of-the-art robots that will keep you saying, "How *do* they do *that*?"

Listening to the Serenade of Cosmic Black Holes

Be part of a quest with Columbia Experimental Gravity group for the LIGO Scientific Collaboration and Laser Interferometer Gravitational-wave Observatory (LIGO). Black holes collide and merge violently in the Universe. We cannot see them, but we can listen to them with modern experiments. Play with a real interferometer, simulate curved space-time, try out fun computer games, and meet real scientists.



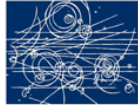

ASPEN
SCIENCE
CENTER



HOME ABOUT US PROJECTS EDUCATION PROGRAMS NEWS AND EVENTS

Aspen Science Festival - Science Street Fair

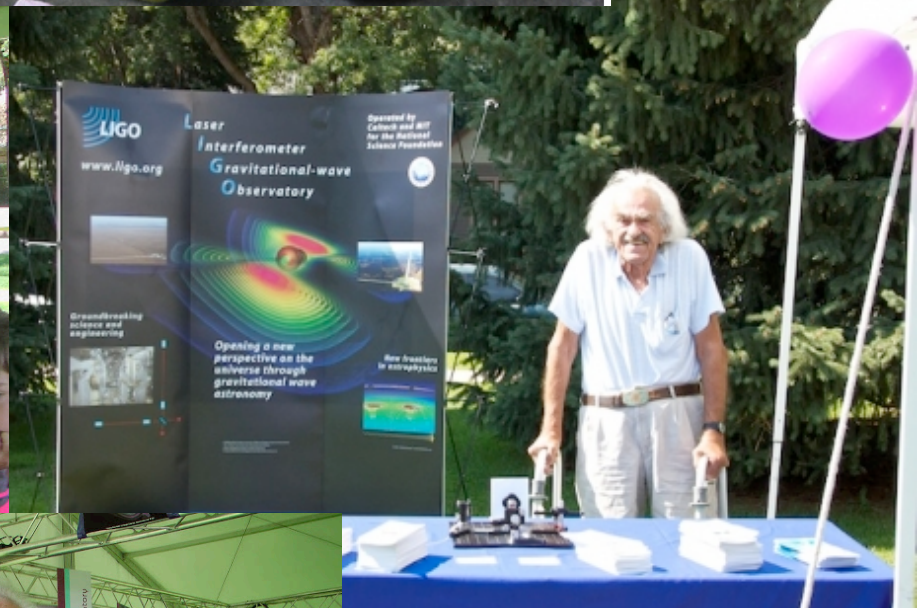

AstroDance

(Rochester Institute of Technology initiative)



LIGO traveling exhibit (University of Mississippi)

Welcome to Astronomy's New Messengers

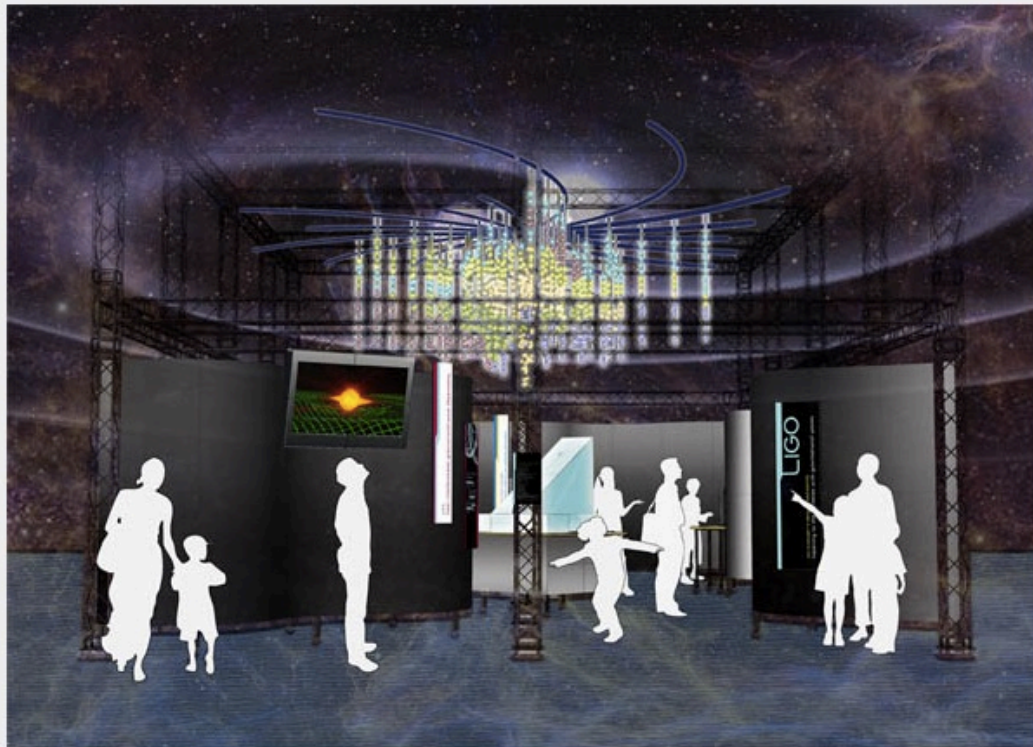

"Astronomy's New Messengers: Listening to the Universe with Gravitational Waves" is an interactive educational experience. [More...](#)

The future is now, and is very bright!

- Decades of NSF investment in LIGO and hundreds of scientists' efforts are about to pay off.
- The convergence of gravitational-wave experiments, numerical and analytical relativity, modeling of electromagnetic counterparts, wide-field optical telescopes will revolutionize our astrophysical knowledge of the universe : “transformative science”!
- The benefits to the country will be broad, and not just in the scientific arena: also in K-12 education, public outreach, STEM resources, worldwide leadership,...

