

Notes:  
 Label both end of the cable with cable label from wiring diagram.  
 Labels of coax cables on TNC side need to include cable number, i.e., ISC\_RF40-B/3  
 Chamber feedthrough is Accuglass 25D-5CX2-450 Part # 100522

### Typical In-vacuum RFPD ASC (Wavefront Sensor) Wiring Chain

U7  
 In-vac ASC RFPD

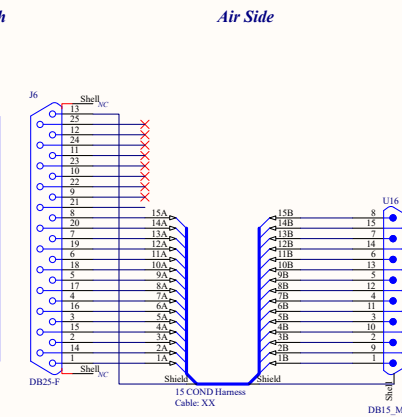
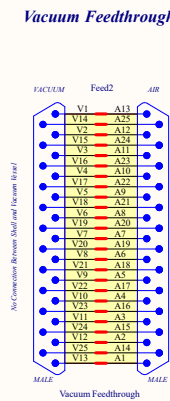
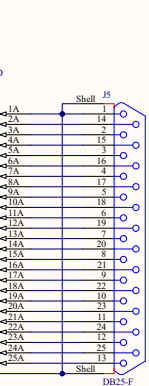
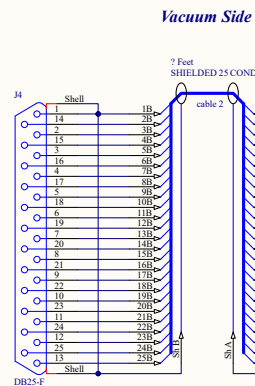
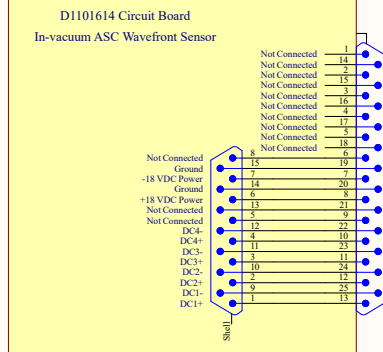
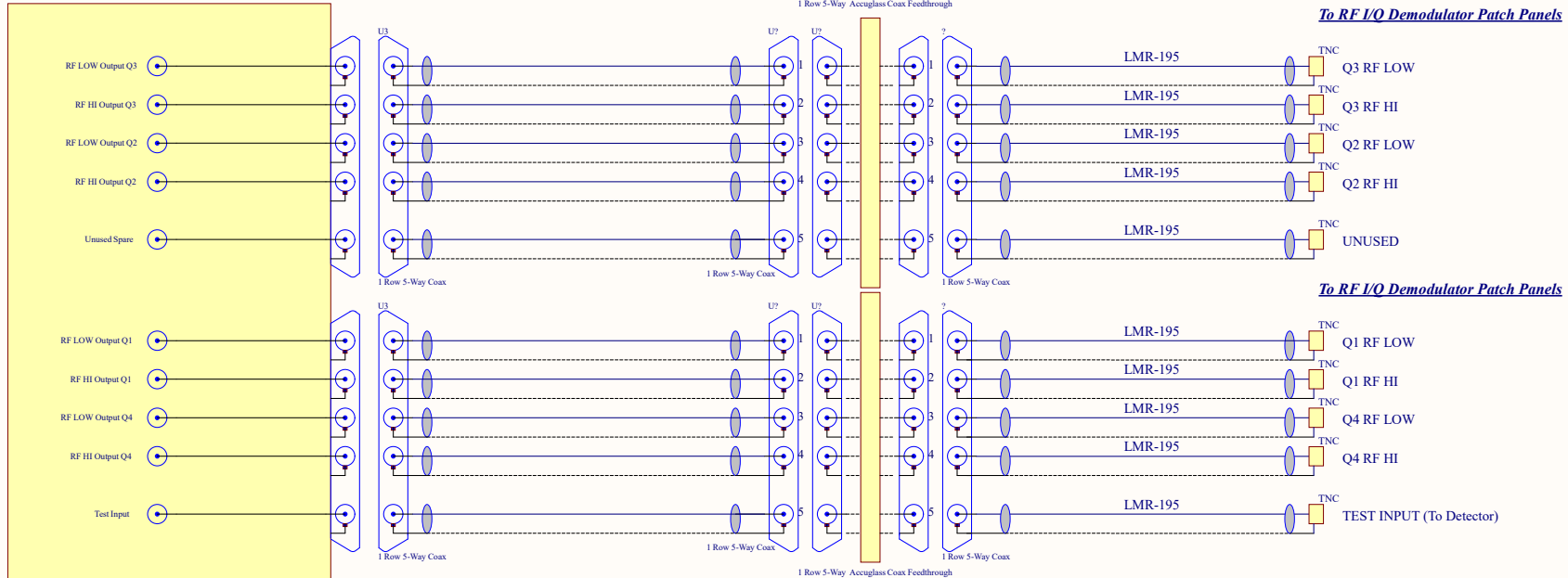

To ASC RFPD Interface D1101865

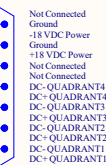

Version 1 - Initial Release  
 Version 2 - Revised pinout to reflect the nonsensical way the single row coaxial 5-way D-sub was pinned in another conflicting, but older document.  
 Version 3 - Noted added to tell which side to look at for the connectors.  
 Version 4 - Move to new Accuglass feedthroughs.