



Advanced LIGO

5 July 2012

David Shoemaker
For the LIGO Scientific Collaboration



Advanced LIGO

Goal: open the era of gravitational-wave astronomy through the direct detection of gravitational waves

- Replaces the instruments at the Washington and Louisiana sites
 - » ~15 years of R&D and Initial LIGO experience
- Advanced LIGO is designed to increase the distance probed ('reach') by ~ 10X
 - » Leads to 1000X increase in volume
→ 1000X increase in event rate
- Expect tens of detections per year at design sensitivity
 - » 1 aLIGO observational day = a few years of iLIGO

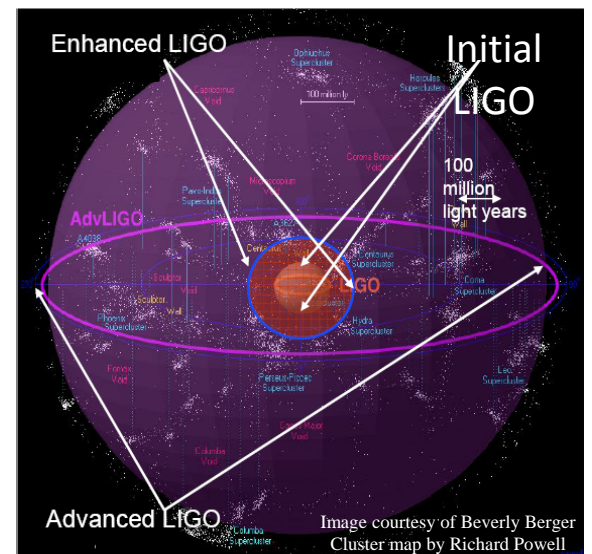



Advanced LIGO: Philosophy

- Ensure that the second generation of LIGO instruments will have sufficient sensitivity to see gravitational wave sources
 - » Sets a minimum bar for sensitivity
- Use the most advanced technology that is sure to deliver a reliable instrument
 - » Some neat ideas did not fit in this category
- Provide a base which would allow enhancements, fully exploiting the basic topology
 - » Major investment by NSF; needs to have a long lifetime
- Don't repeat errors of initial LIGO!
 - » Build full scale prototypes, and where possible use in real instruments
 - » Test subcomponents and subsystems rigorously
 - » Maintain configuration control on hardware and software
 - » Document everything well, and organize it for easy access



Advanced LIGO: History

- 1990's: small-scale testing of various ideas to go beyond initial detectors
- 1999: LIGO Scientific Collaboration White Paper describing a range of candidate technologies meriting exploration, but with a potential sensitivity enabled by...:
 - » Low-loss monolithic fused silica suspensions
 - » Signal-recycled interferometer topologies
- 1999 – 2005: Structured, focused R&D by the community and LIGO Lab, resolving key open design facets:
 - » Fused silica or sapphire optics
 - » Approach to the high-power laser source
 - » Approach to seismic isolation
 - »and, develop and operate Initial LIGO; learn lessons
- 2005: Leads to a firm design; successful proposal to NSF by the LIGO Lab for \$205M USD, plus significant contributions from Max Planck (Germany), STFC (UK), ARC (Australia)
- **2008: The NSF-funded Advanced LIGO Project Starts!**



- “Ensure that the second generation of LIGO instruments will have sufficient sensitivity to see gravitational wave sources”
- **What are the basic limits?**

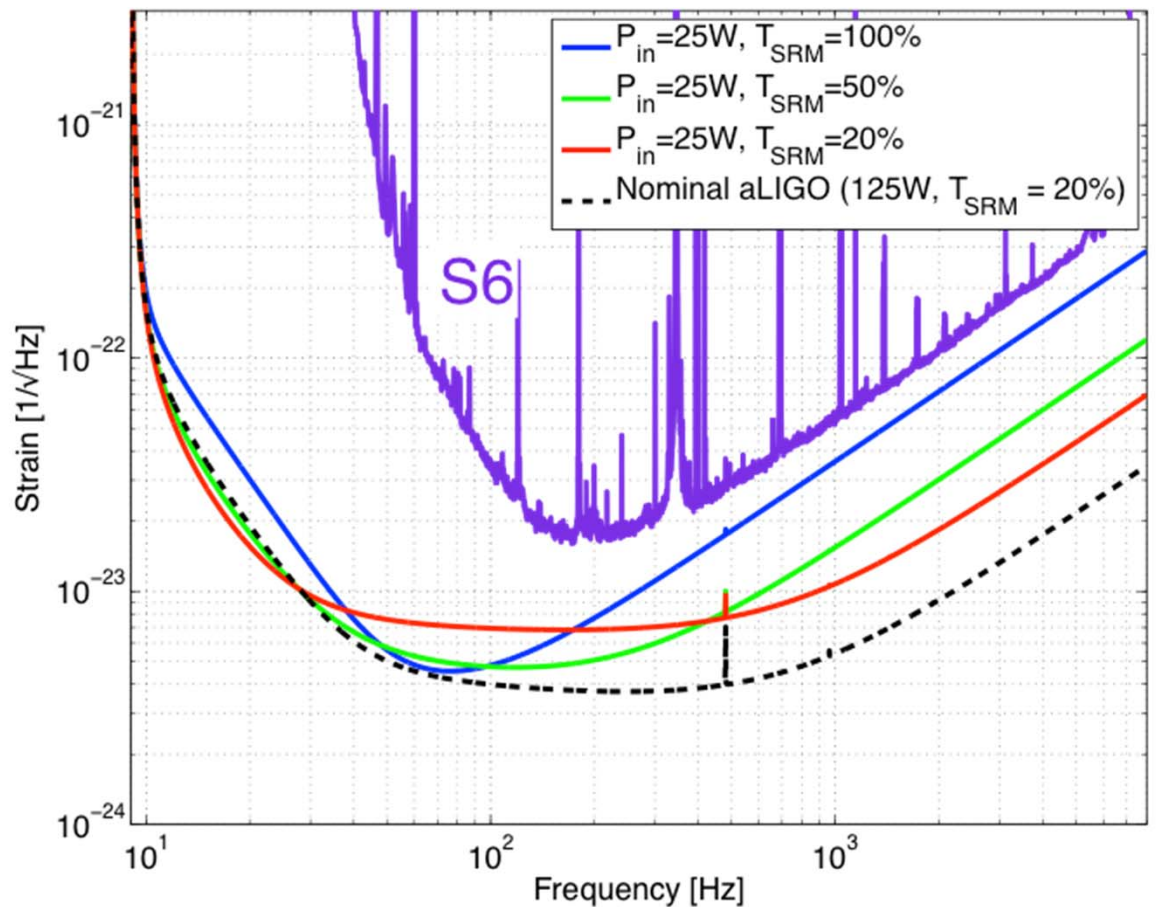

Interferometric Gravitational-wave Detectors

- Enhanced Michelson interferometers
 - » LIGO, Virgo, and GEO600 use variations
- Passing GWs modulate the distance between the end test mass and the beam splitter
- The interferometer acts as a transducer, turning GWs into photocurrent proportional to the strain amplitude
- Arms are short compared to GW wavelengths, so longer arms make bigger signals
→ multi-km installations

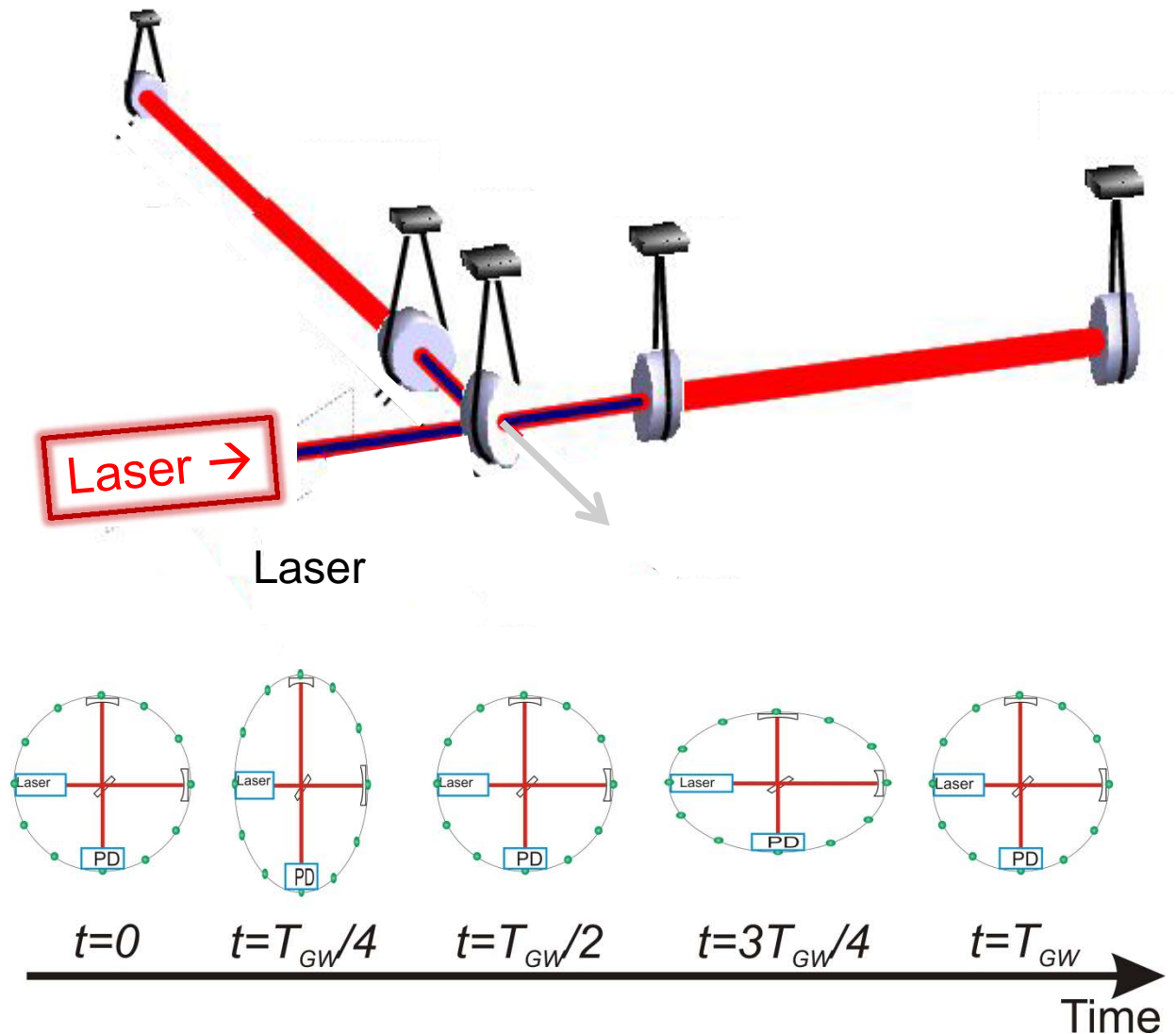

- **Shot noise** – ability to resolve a fringe shift due to a GW (counting statistics)
- Increases in laser power help, as $\sqrt{\text{power}}$
- Resonant cavity for signals helps in managing power, tuning for astrophysics
- Point of diminishing returns when buffeting of test mass by photons increases low-frequency noise – use heavy test masses!
- ‘Standard Quantum Limit’
- Advanced LIGO reaches this limit with its 200W laser source, 40 kg test masses

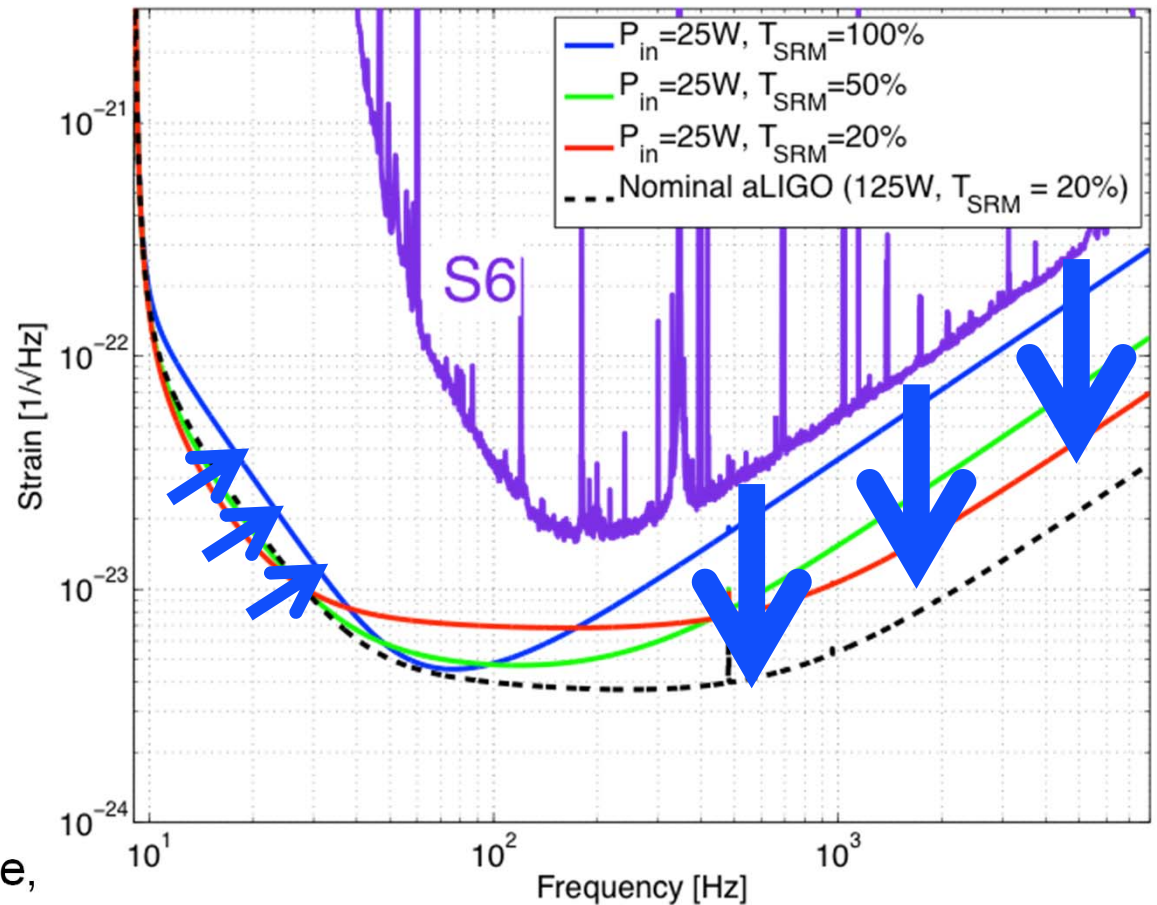

- **Thermal noise** – keeping the motion of components due to thermal energy below the level which masks GW
- Low mechanical loss materials gather this motion into a narrow peak in frequency
- Realized in aLIGO with an all fused-silica test mass suspension – Q s of order 10^9
- Mirror coatings engineered for low mechanical loss

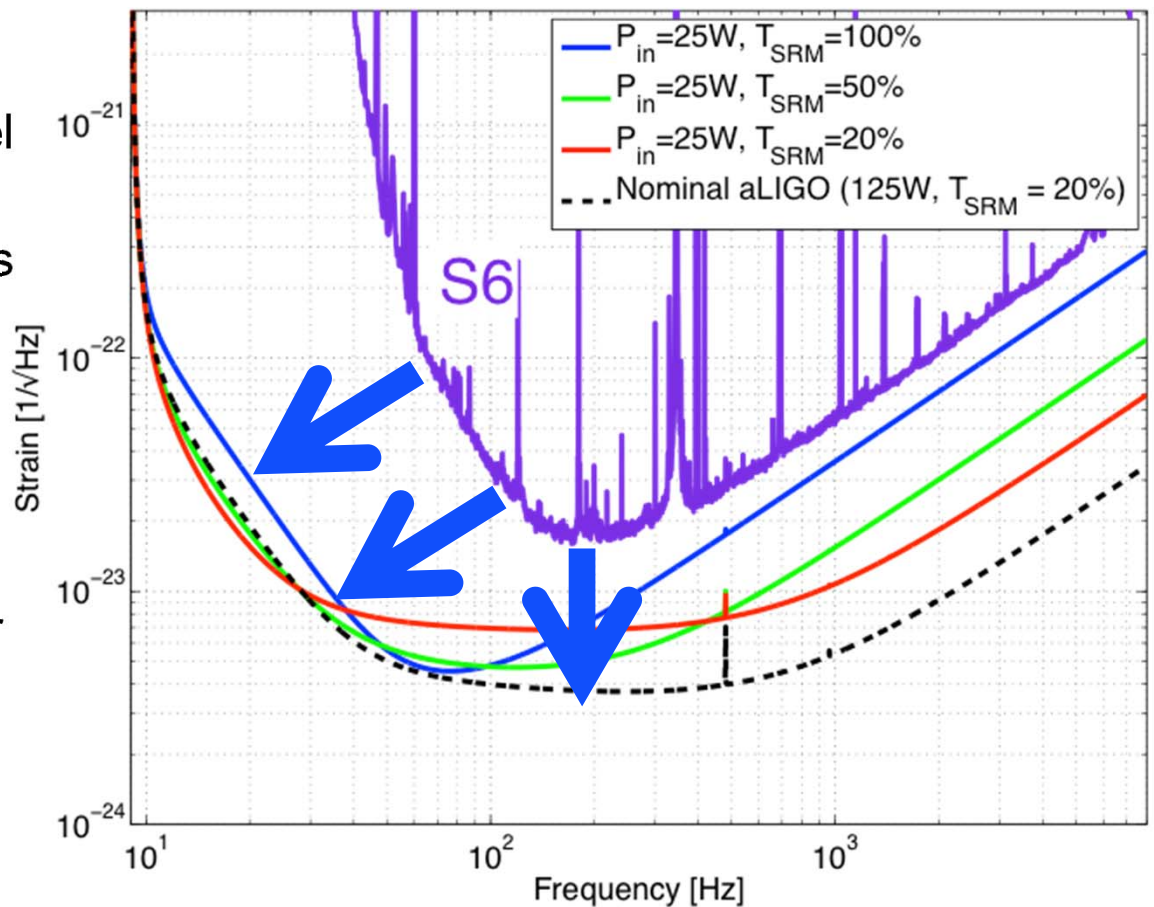

- **Seismic noise** – must prevent masking of GWs, enable practical control systems
- GW band: 10 Hz and above – direct effect of masking
- Control Band: below 10 Hz – forces needed to hold optics on resonance and aligned
- aLIGO uses active servo-controlled platforms, multiple pendulums
- Newtonian background – wandering in net gravity vector; a limit in the 10-20 Hz band

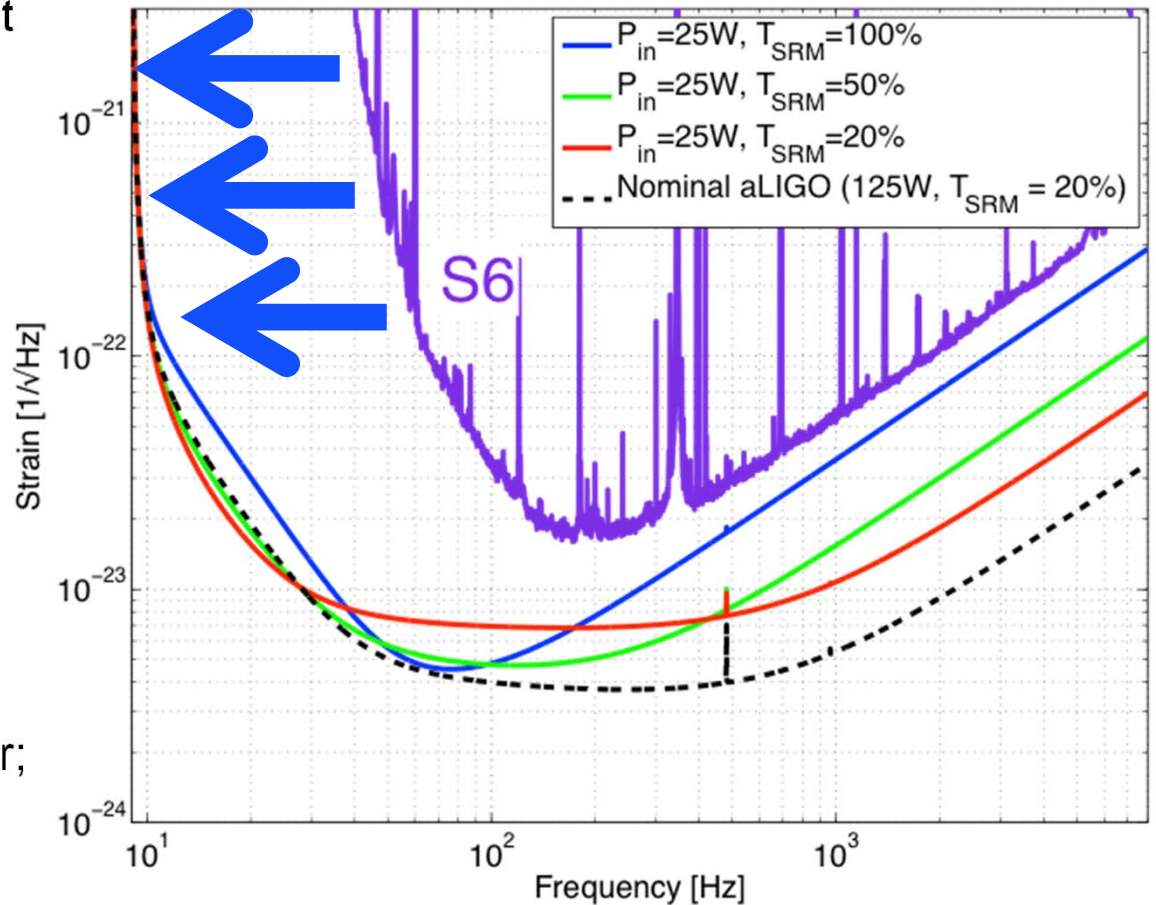

The Design: Optical Configuration

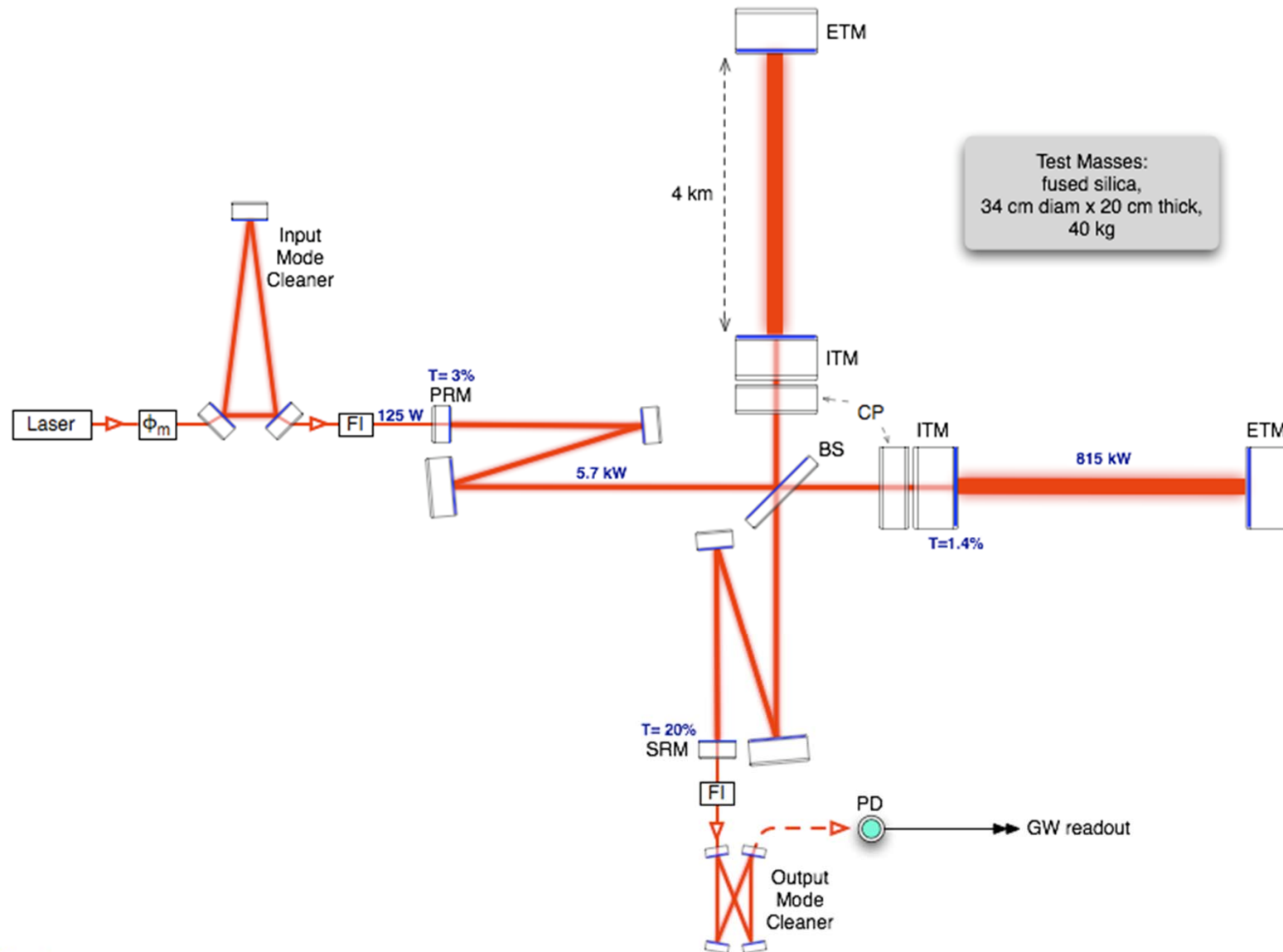

Key Interferometer Features

4km Arm cavity design

- Finesse: 450
 - » 2x higher than iLIGO
 - » Value involves trade-offs between optical loss, sensitivity to noise in other degrees-of-freedom, and interferometer sensitivity in different modes of operation
- Beam sizes: 6.2 cm on far mirror, 5.3 cm on near mirror
 - » Approx. 50% larger than iLIGO, to reduce thermal noise
 - » Smaller beam on the ITM to allow smaller optic apertures in the vertex
- Cavities are made to be dichroic
 - » Low finesse cavity for 532 nm to aid in lock acquisition

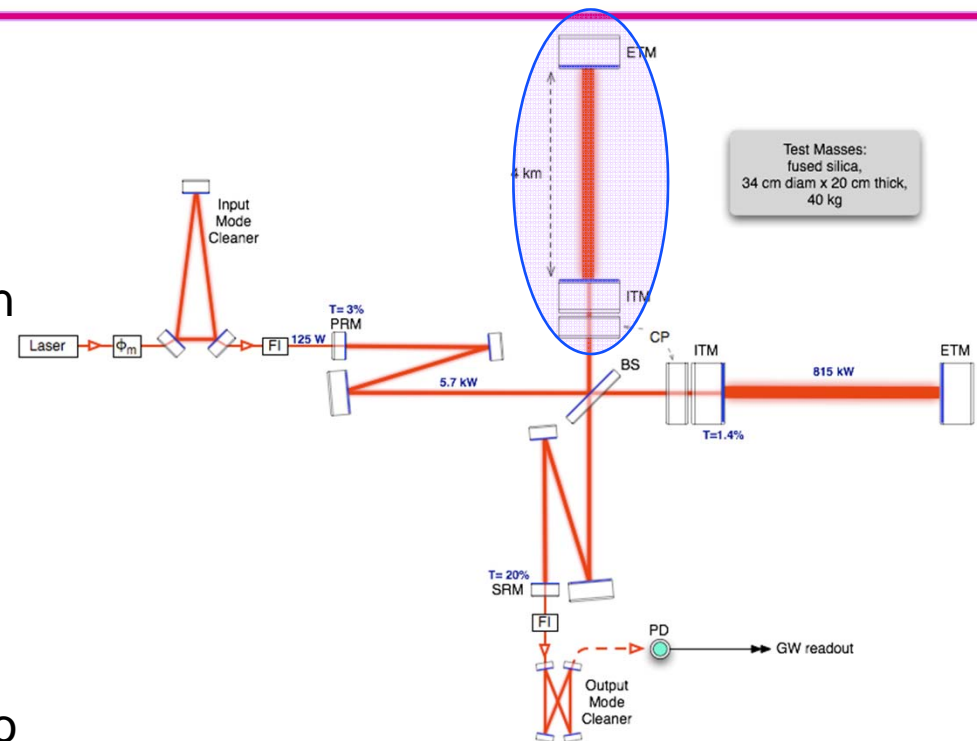

- Near-confocal design

$$R_{ITM}, R_{ETM} \approx L$$

- » Gives better angular stability than the near flat-flat case (torques from off-center beams)

Stable Recycling Cavities

- iLIGO had a marginally stable recycling cavity
 - » Nearly a plane-plane cavity; higher order spatial modes are nearly resonant
 - » Mode quality (& thus optical gain) very sensitive to optic, substrate defects
- Stable geometry for aLIGO
 - » Beam expansion/reduction telescopes are included in the recycling cavities
 - » Higher order spatial modes are suppressed
 - » Configuration is more tolerant to optical distortions

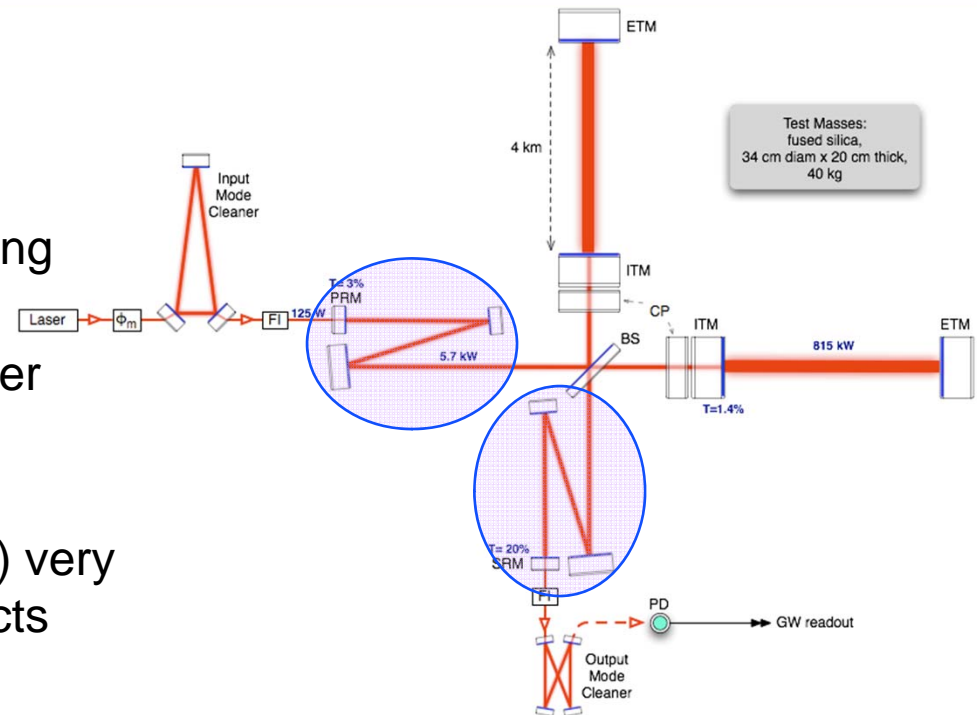



Resulting flexibility in the instrument response

Initial LIGO curves for comparison

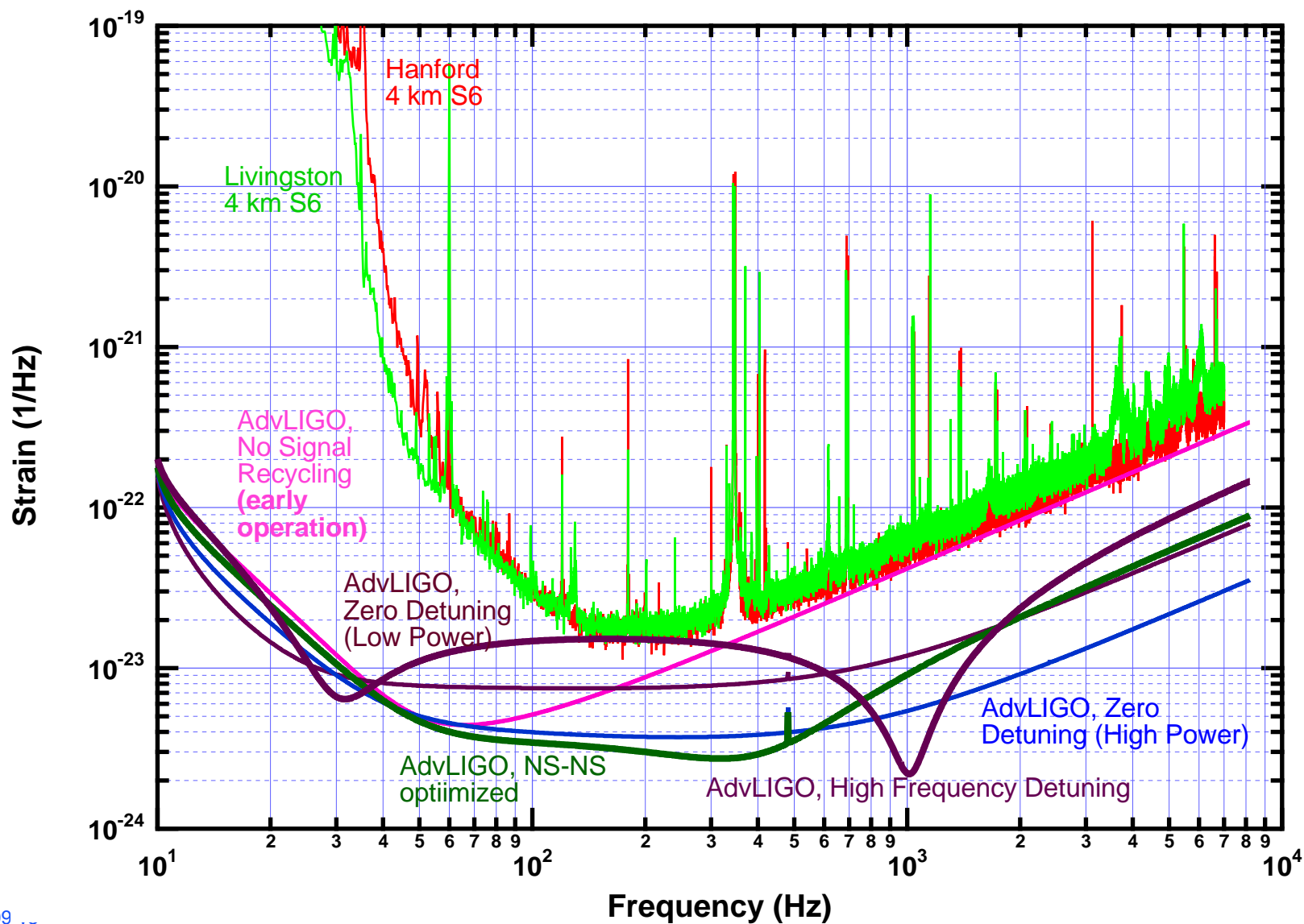



A look at the hardware –
with a focus on things unique to
Advanced LIGO

200W Nd:YAG laser, stabilized in power and frequency

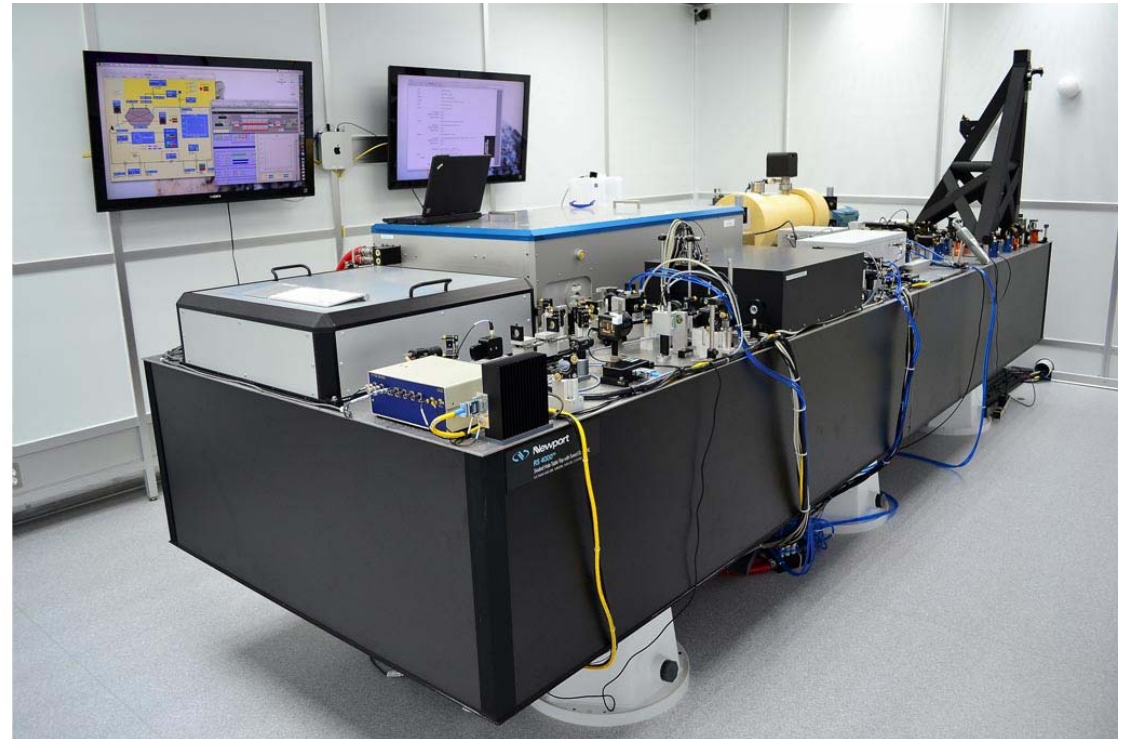
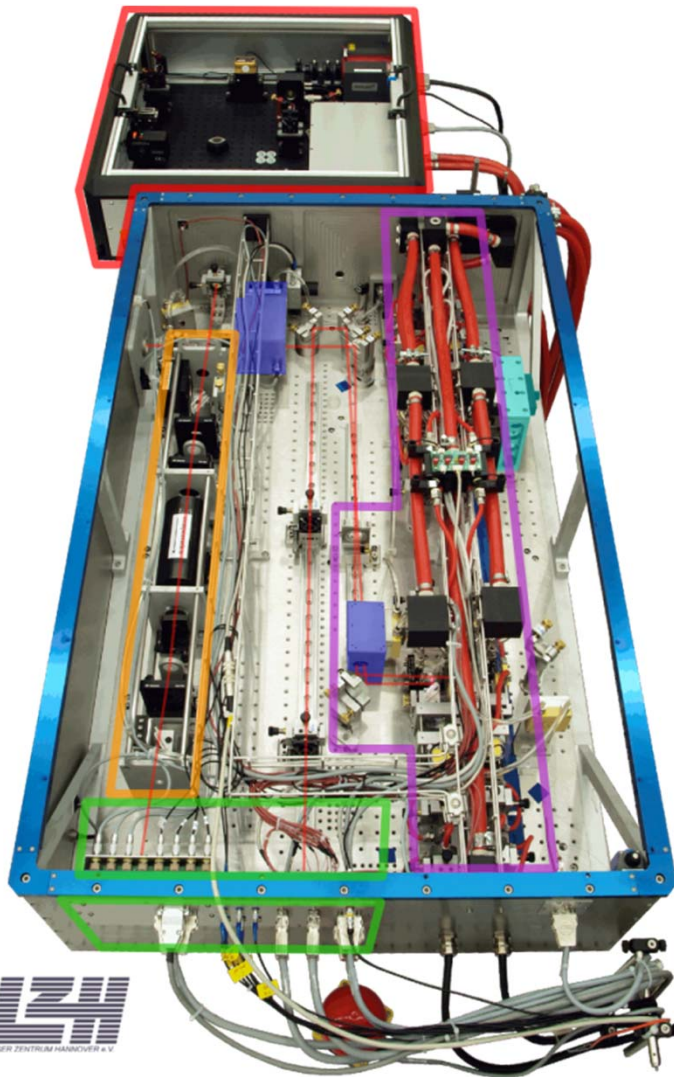

- Designed and contributed by Max Planck Albert Einstein Institute
- Uses a monolithic master oscillator followed by injection-locked rod amplifier



Input Mode Cleaner

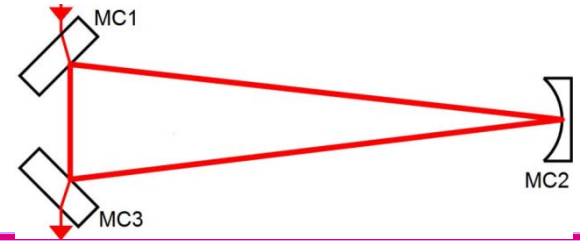

- Triangular ring cavity to stabilize pointing of beam, act as frequency reference
- $L/2 = 16.5$ m; Finesse = 520
- Mirrors suspended as 3 pendulums in series for seismic isolation, control
- Mirrors 15 cm diameter x 7.5 cm thick -- 3 kg: 12x heavier than iLIGO, to limit noise due to radiation pressure

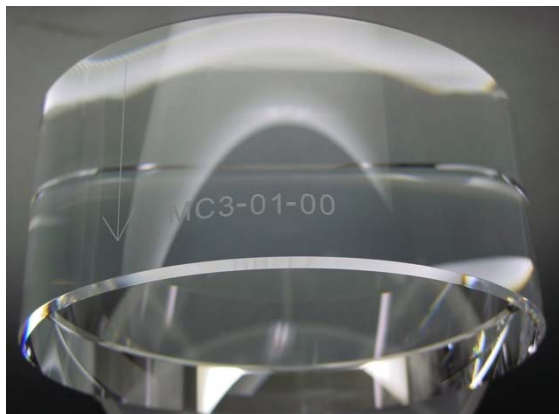



Test Masses

- Requires the state of the art in substrates and polishing
- Pushes the art for coating!

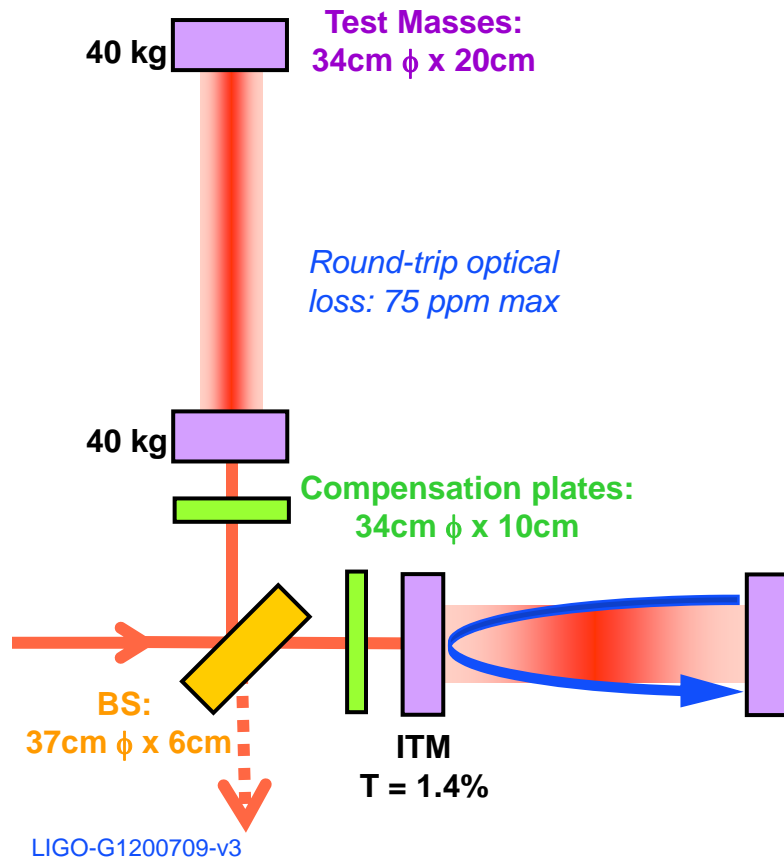
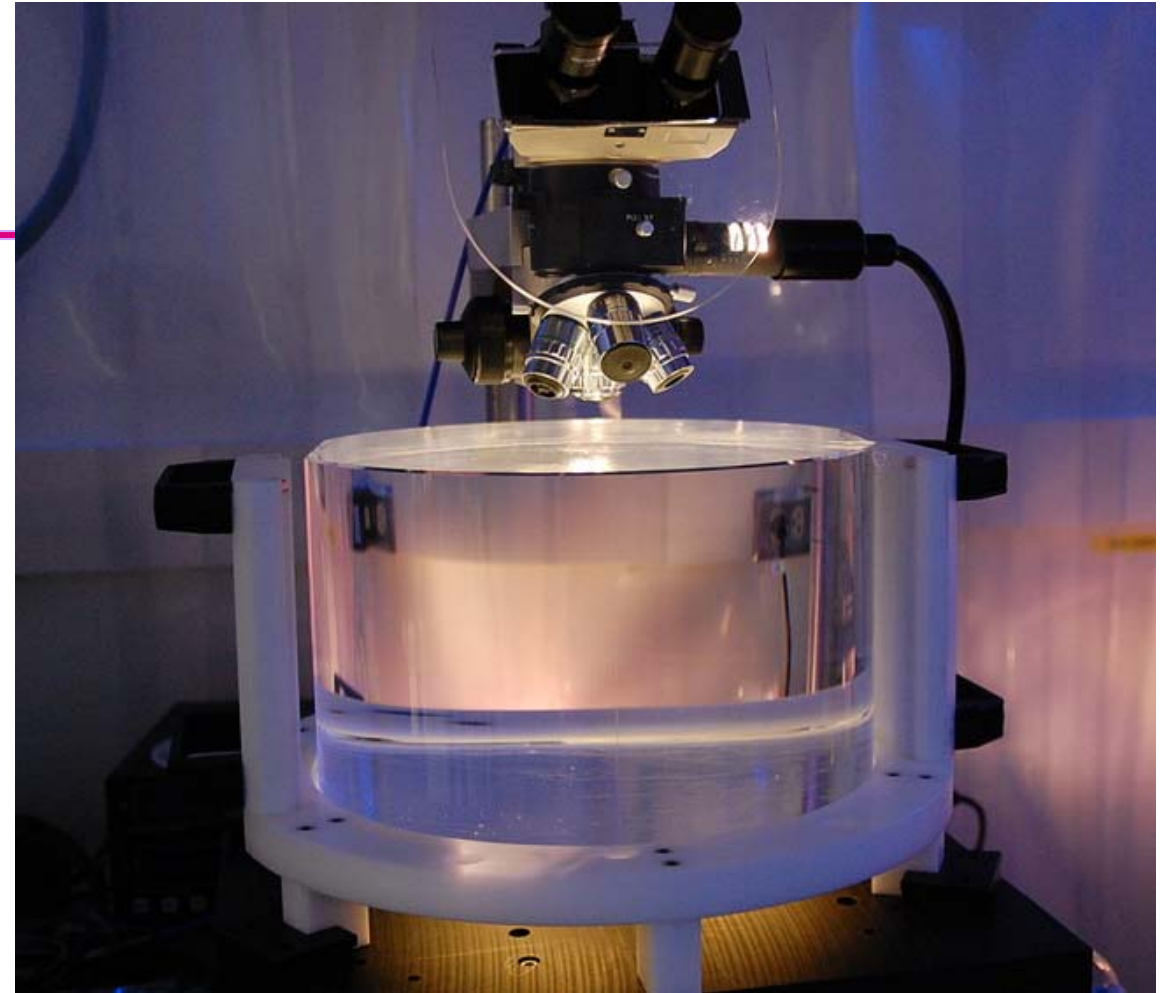

- Both the physical test mass, a free point in space-time, and a crucial optical element
- Mechanical requirements: bulk and coating thermal noise, high resonant frequency
- Optical requirements: figure, scatter, homogeneity, bulk and coating absorption

Test Mass Polishing, Coating

- Heraeus substrates: low absorption, excellent homogeneity, stability under annealing
- Superpolished; then, cycle of precision metrology and ion-beam milling to correct errors; surface is as good as 0.08 nm RMS over 300 mm aperture (Tinsley)
- Ion-beam assisted sputtered coatings, ~ 0.6 ppm/bounce absorption, and showing 0.31 nm RMS over 300 mm aperture (LMA Lyon)
- Meets requirements of projected 75 ppm round-trip loss in 4km cavity

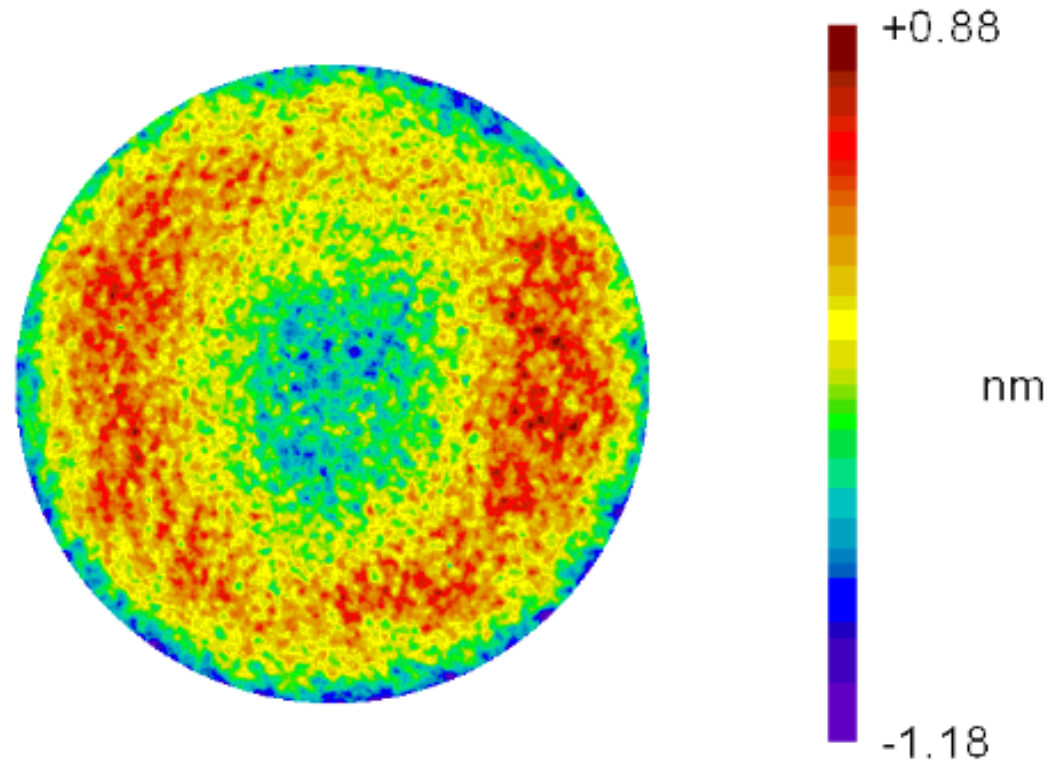

Correcting index inhomogeneity of substrate

- Have also used the ion-beam milling technique to compensate for substrate inhomogeneity – principally a ‘focus’ term, but higher order also compensated
- On Left, 63 nm peak to valley; on Right, after figuring, 2 nm PV

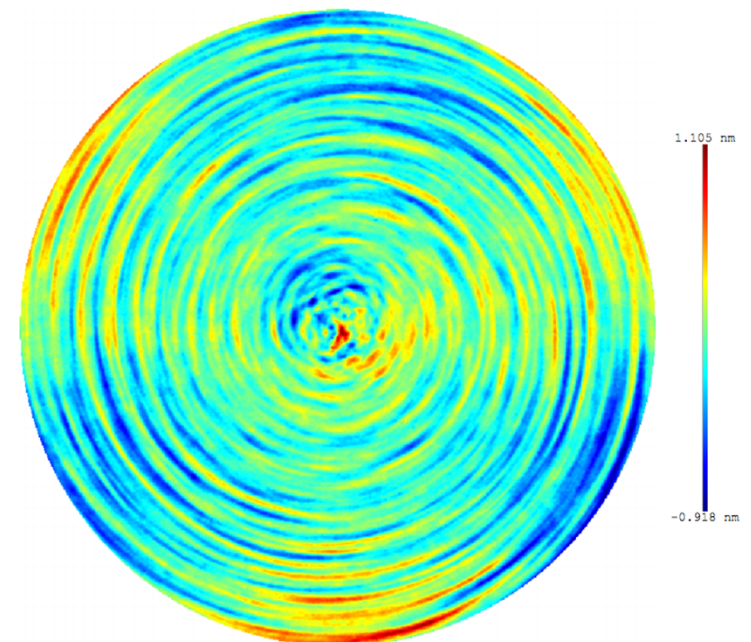
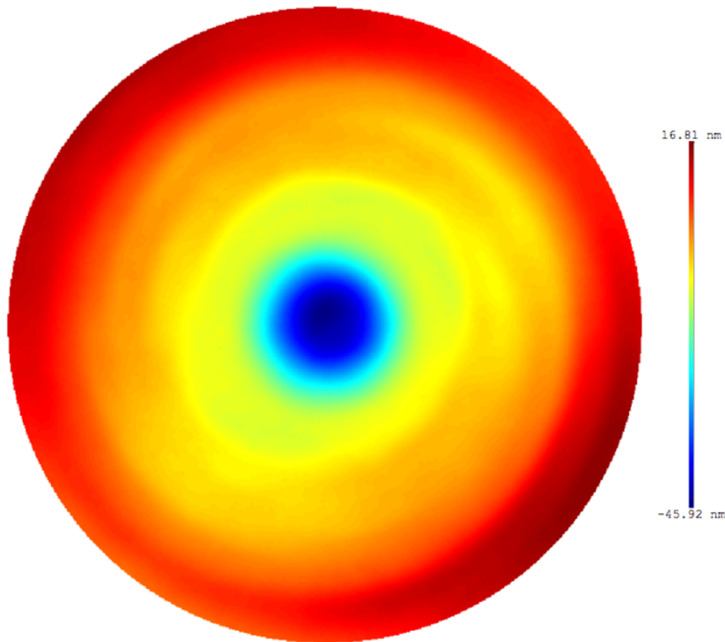

Compensation of focus induced by laser-induced substrate heating

Elements contributed by Australian consortium

- Measure & Control thermal lens in the Input Test Mass
 - » Maintain thermal aberrations to within $\lambda/50$
- Control the Radius Of Curvature (ROC) in the Input and End Test Masses
 - » Provide 35 km ROC range

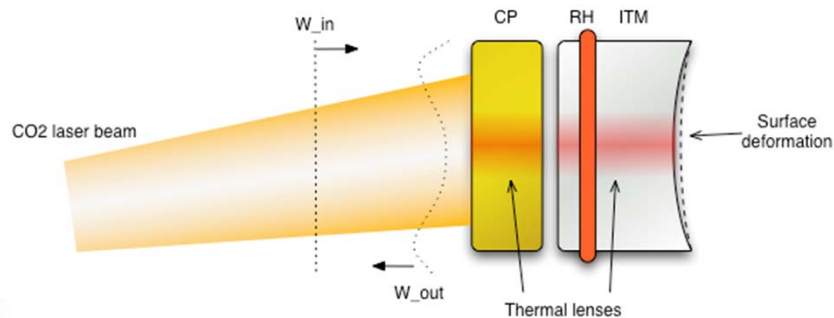
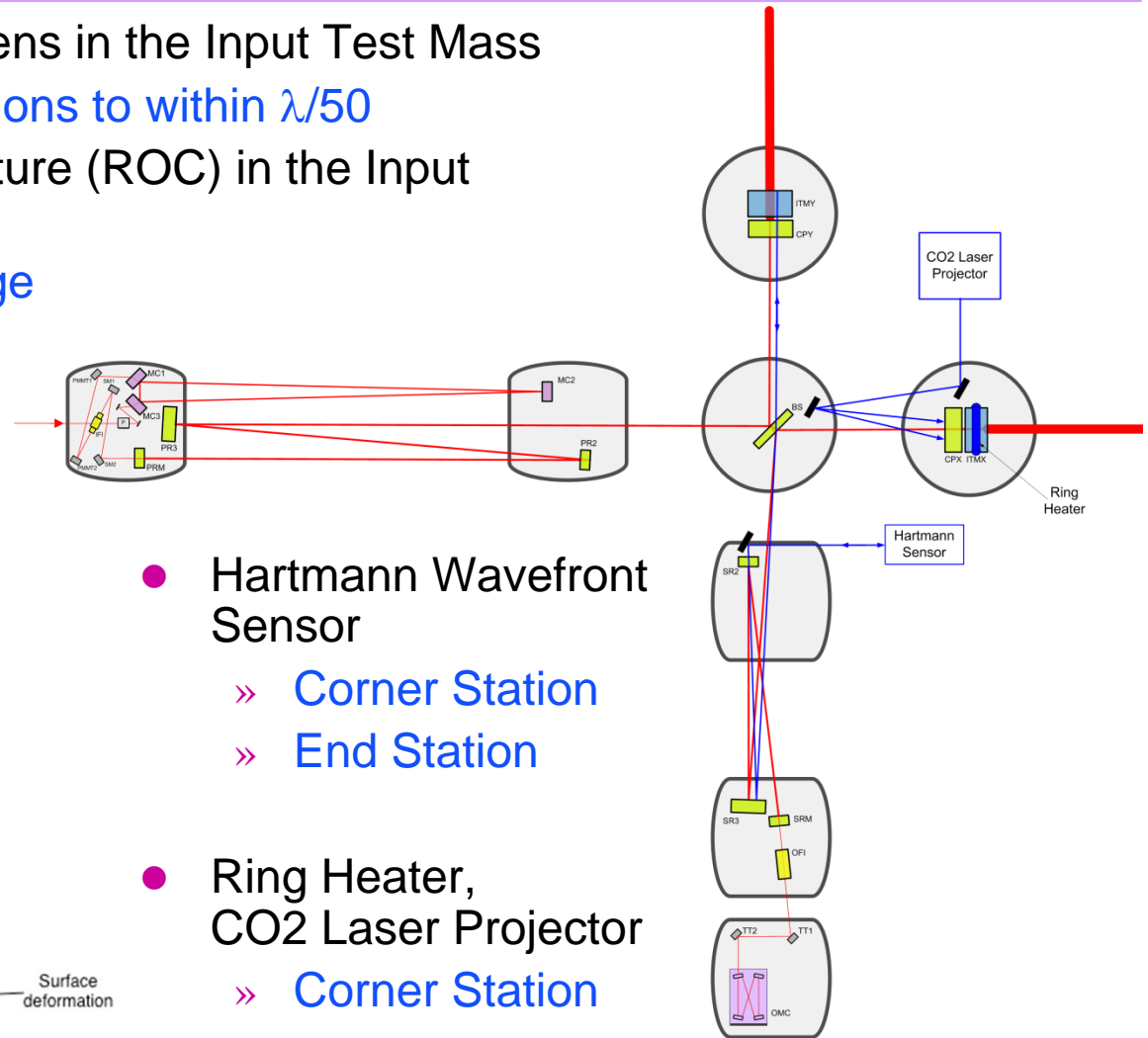

Stray Light Control

- Ensure that phase noise due to scattered light does not compromise interferometer performance by scattering back in to the beam
- Baffles suspended to reduce motion
- All baffles & beam dumps are oxidized, polished stainless steel sheet

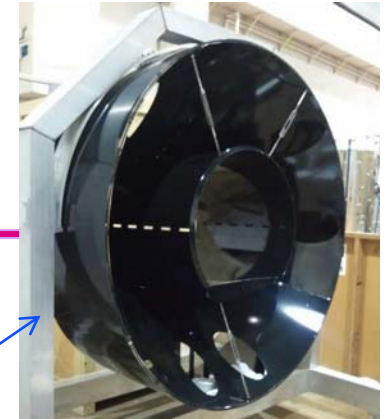

Manifold/
Cryopump
Baffle

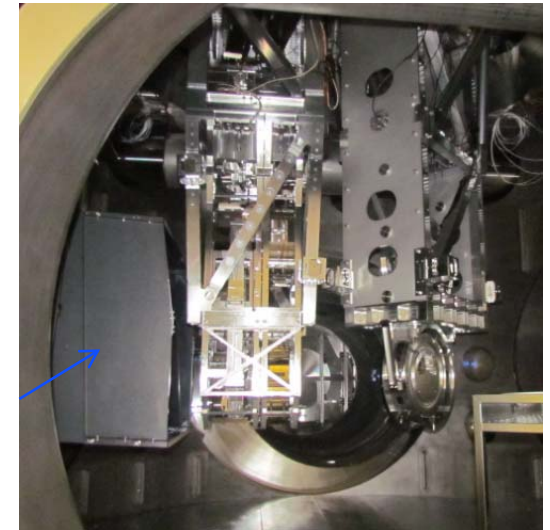

Arm cavity

Modecleaner Tube Baffle

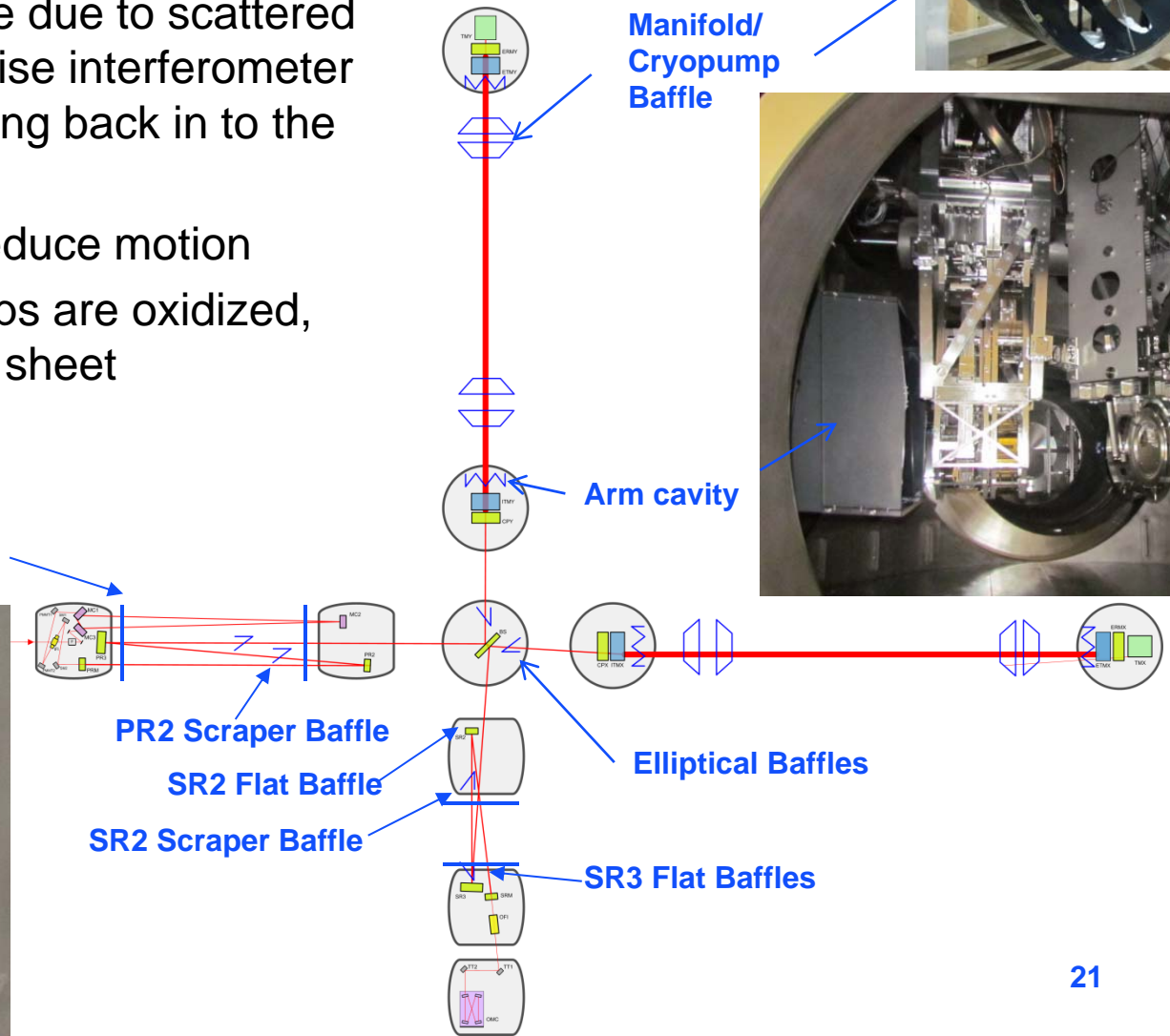



Pre-Lock Arm Length Stabilization

Contributed by Australian consortium

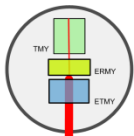
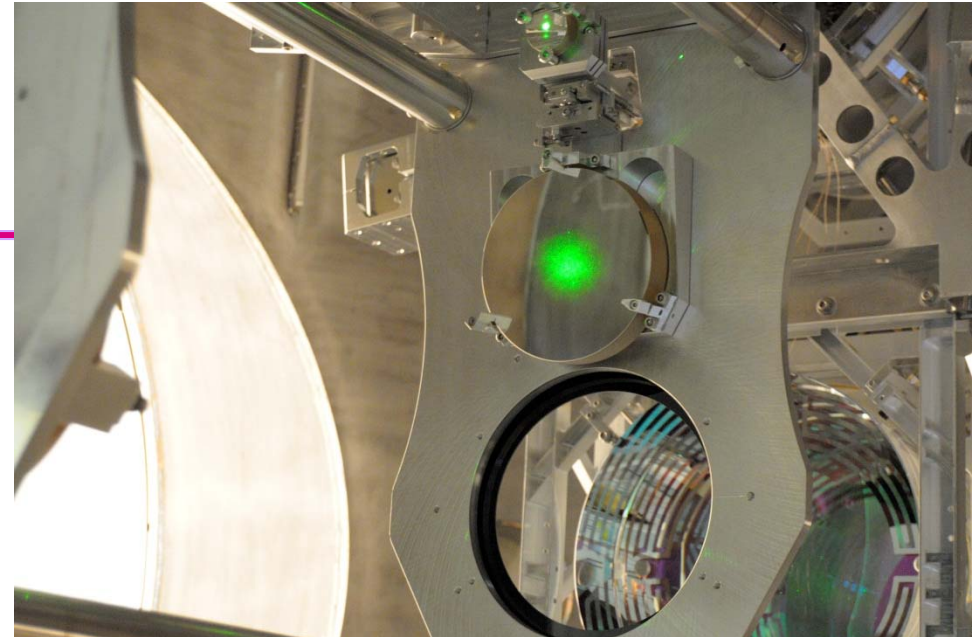

- Green light injected through End Test Mass
- Forms low-finesse 4km cavity, provides robust and independent locking signal for 4km cavities
- Sidesteps challenge seen in first-generation detectors
- Off-axis parabolic telescope to couple light in/out; in-vacuum and seismically isolated
- Just brought into operation on the first Advanced LIGO 4km arm

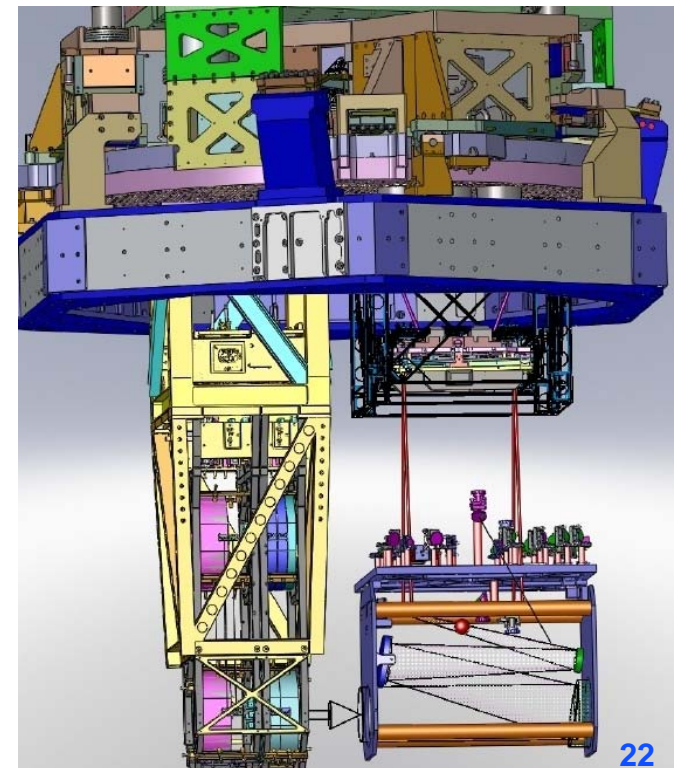
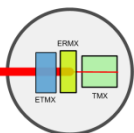
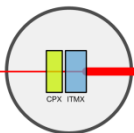
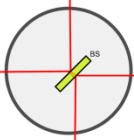
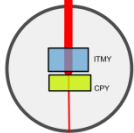

Seismic Isolation: Multi-Stage Solution

- Objectives:
 - » Render seismic noise a negligible limitation to GW searches
 - » Reduce actuation forces on test masses
- Both suspension and seismic isolation systems contribute to attenuation
- Choose an active isolation approach, 3 stages of 6 degrees-of-freedom :
 - » 1) Hydraulic External Pre-Isolation
 - » 2) Two Active Stages of Internal Seismic Isolation
- Increase number of passive isolation stages in suspensions
 - » From single suspensions ($1/f^2$) in initial LIGO to quadruple suspensions ($1/f^8$) for aLIGO

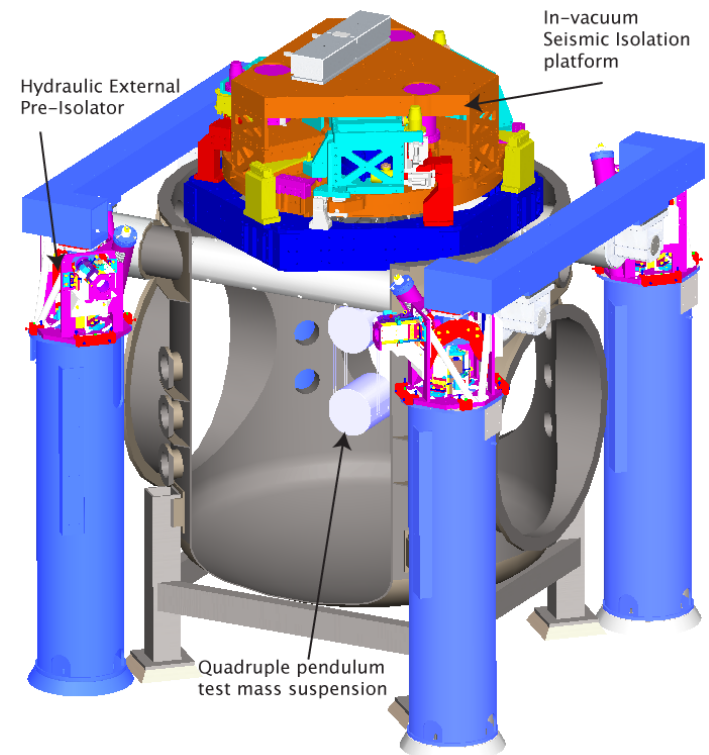



Seismic Isolation: two models

- **Type I:** Single stage (6 DOF) isolator with positioning, alignment capability
- Uses capacitive sensors for 'DC', and several types of seismometers to sense acceleration
- Electromagnetic motors for actuation
- Control system is digital, and fully multiple- input multiple-output to optimize for complex figures of merit

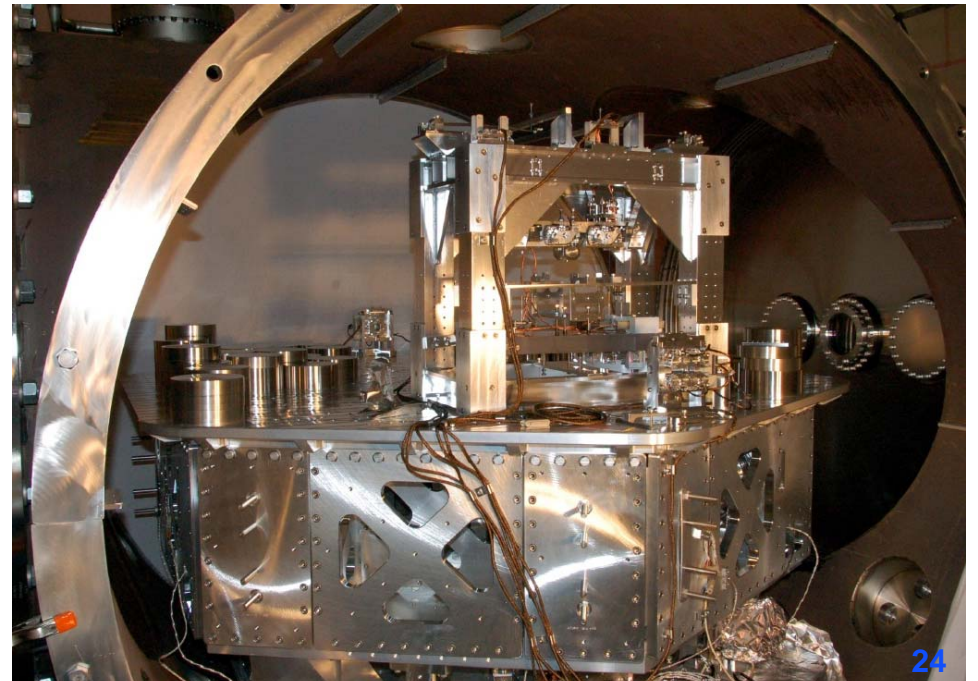
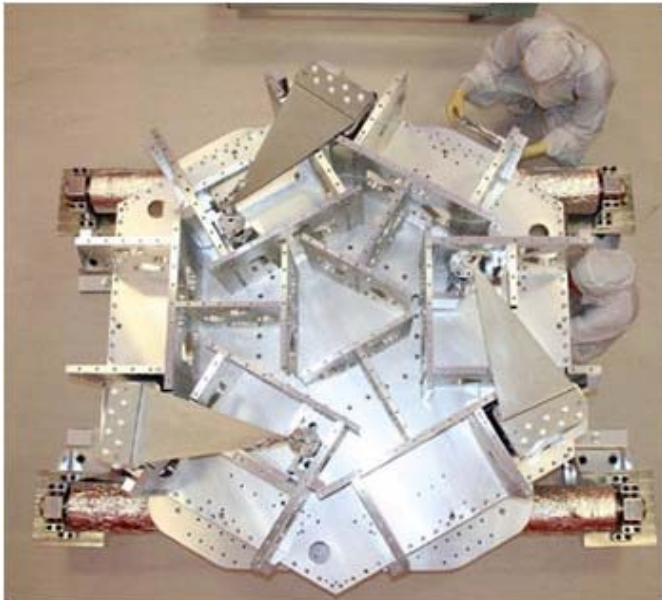

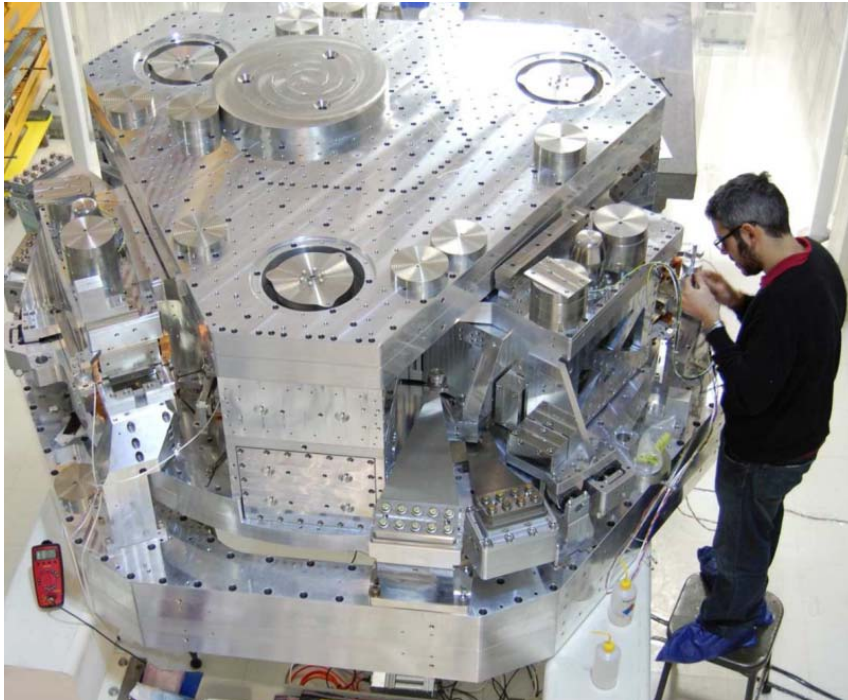

Seismic: Test Mass isolator

- **Type II:** Two-stage system, each with 6 DOF measured and actuated upon – 18 DOF including hydraulic pre-actuator!
- Suspensions, baffles, etc. hung from quiet optical table
- Part of a hierarchical control system, with distribution of forces for best performance
- Provides a quiet versatile optical table; can carry multiple suspensions, baffles, detectors, etc.





Optics suspensions: Multiple types

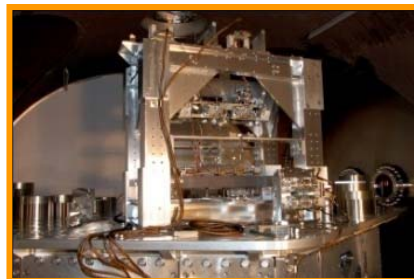
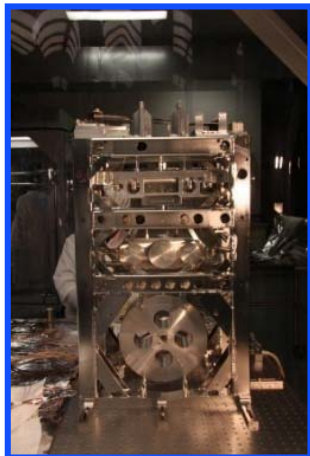
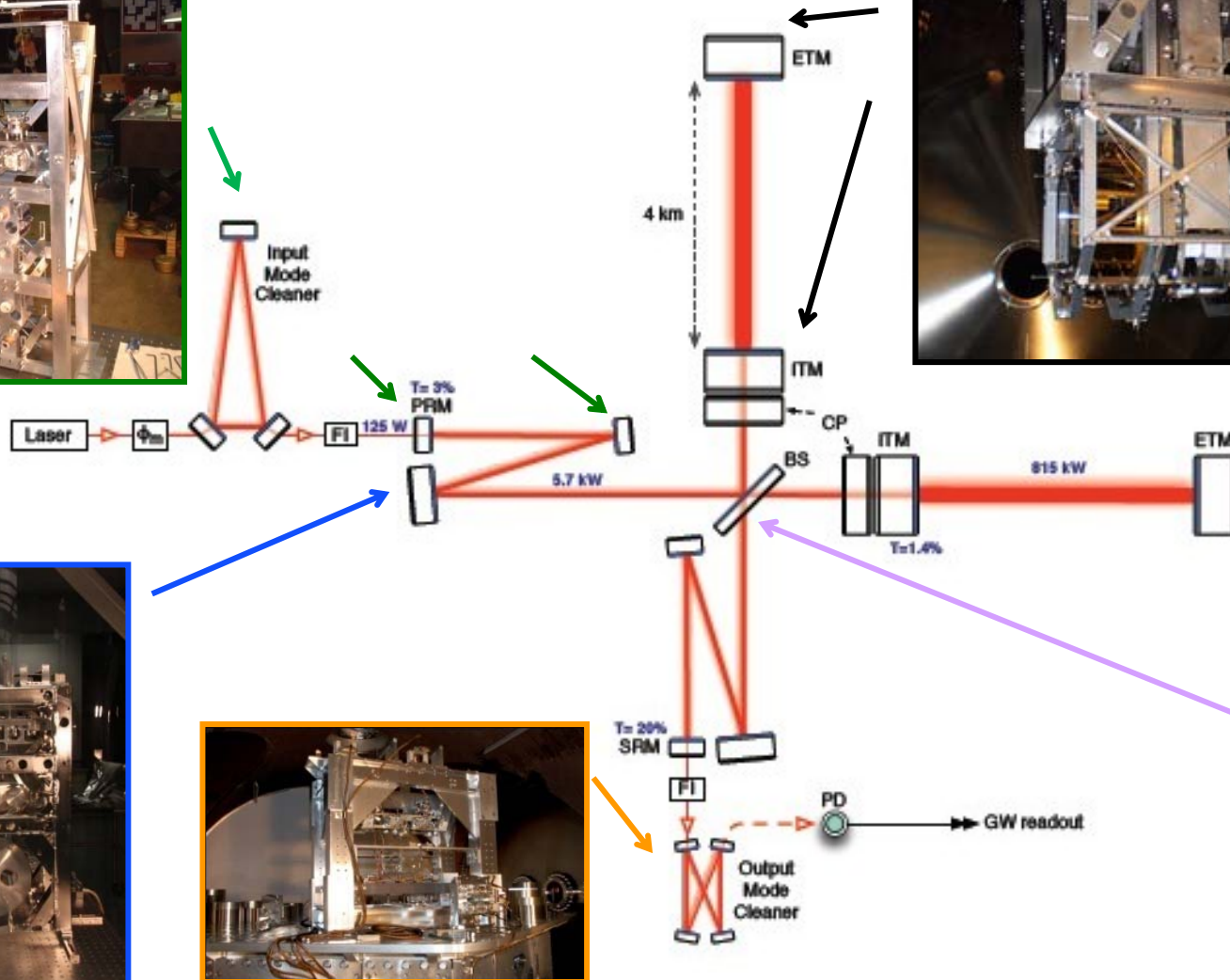
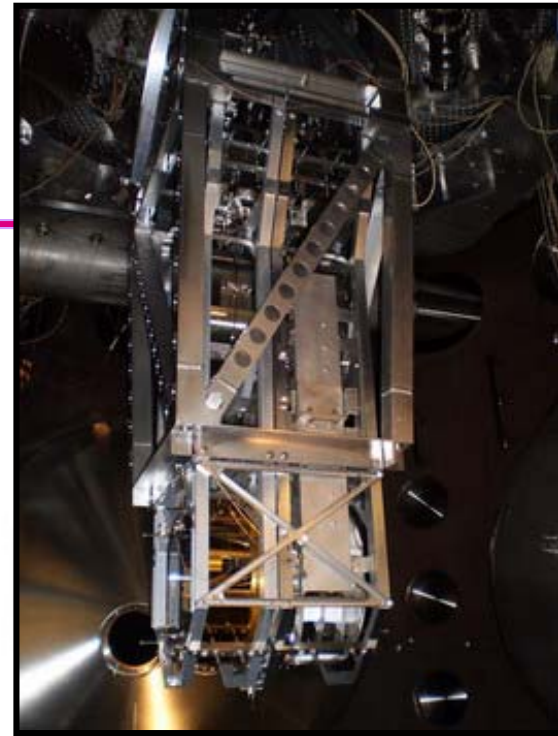



Test Mass Quadruple Pendulum suspension

Contributed by UK consortium

- Choose quadruple pendulum suspensions for the main optics; second 'reaction' mass to give quiet point from which to push
- Create quasi-monolithic pendulums using fused silica fibers to suspend 40 kg test mass
- Another element in hierarchical control system

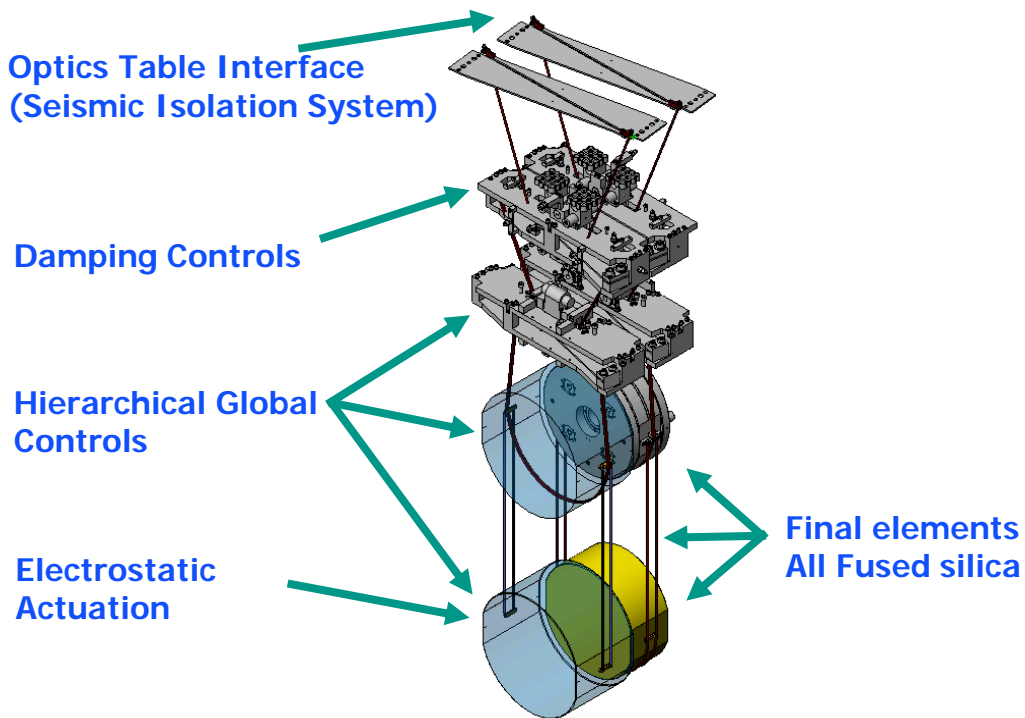



Advanced LIGO Systems Engineering

- Team ensures uniformity of designs, compatibility of interfaces
- Integrated layouts allow virtual installations, fit/interference checks during design

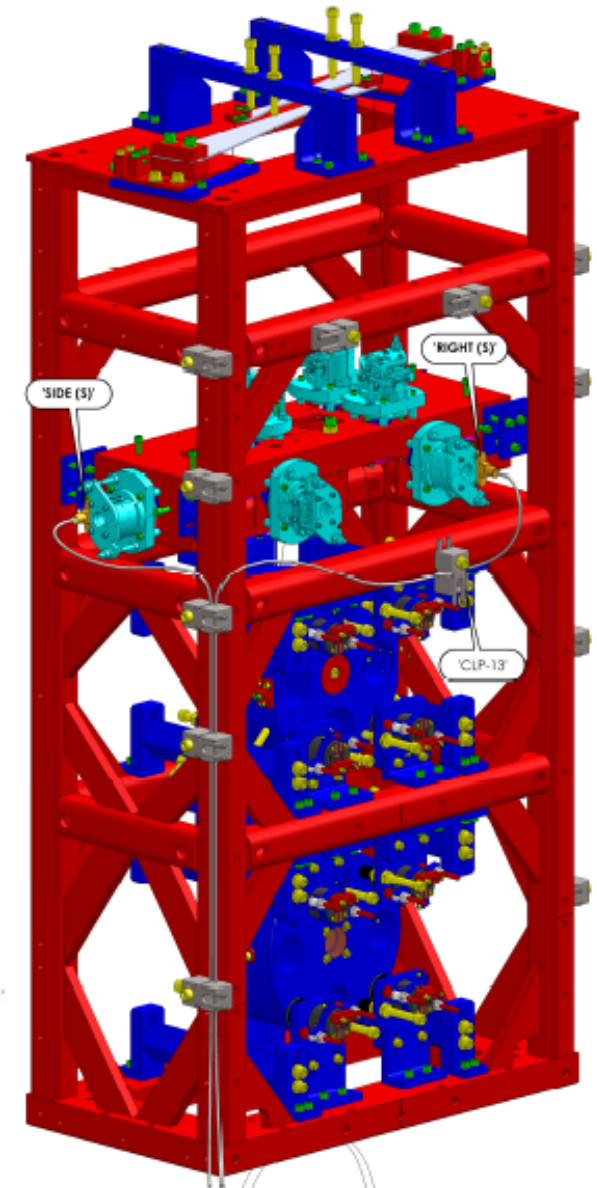
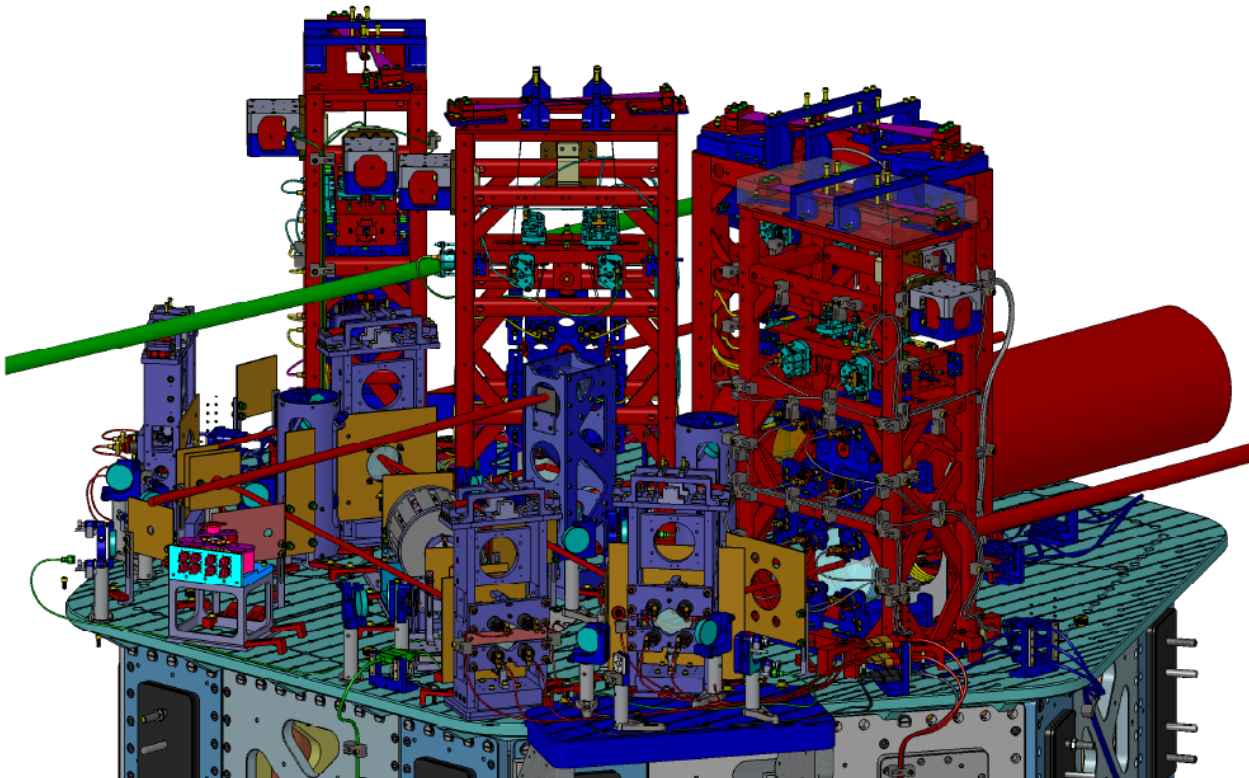



Advanced LIGO Systems Engineering

- Team ensures uniformity of designs, compatibility of interfaces
- Integrated layouts allow virtual installations, fit/interference checks during design

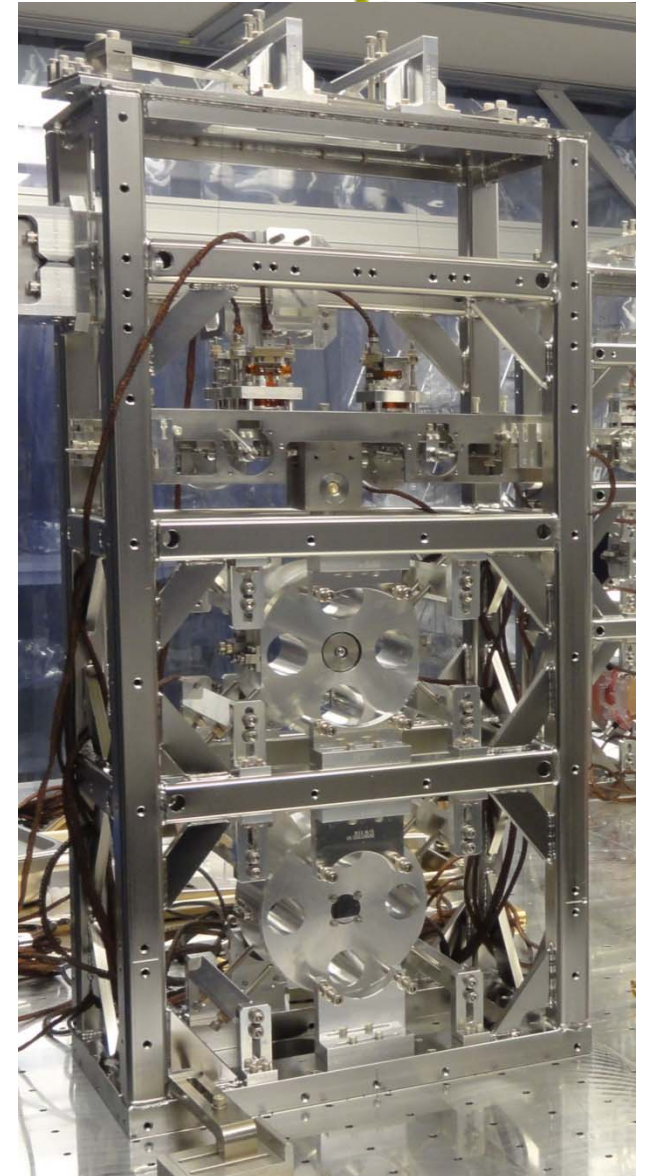
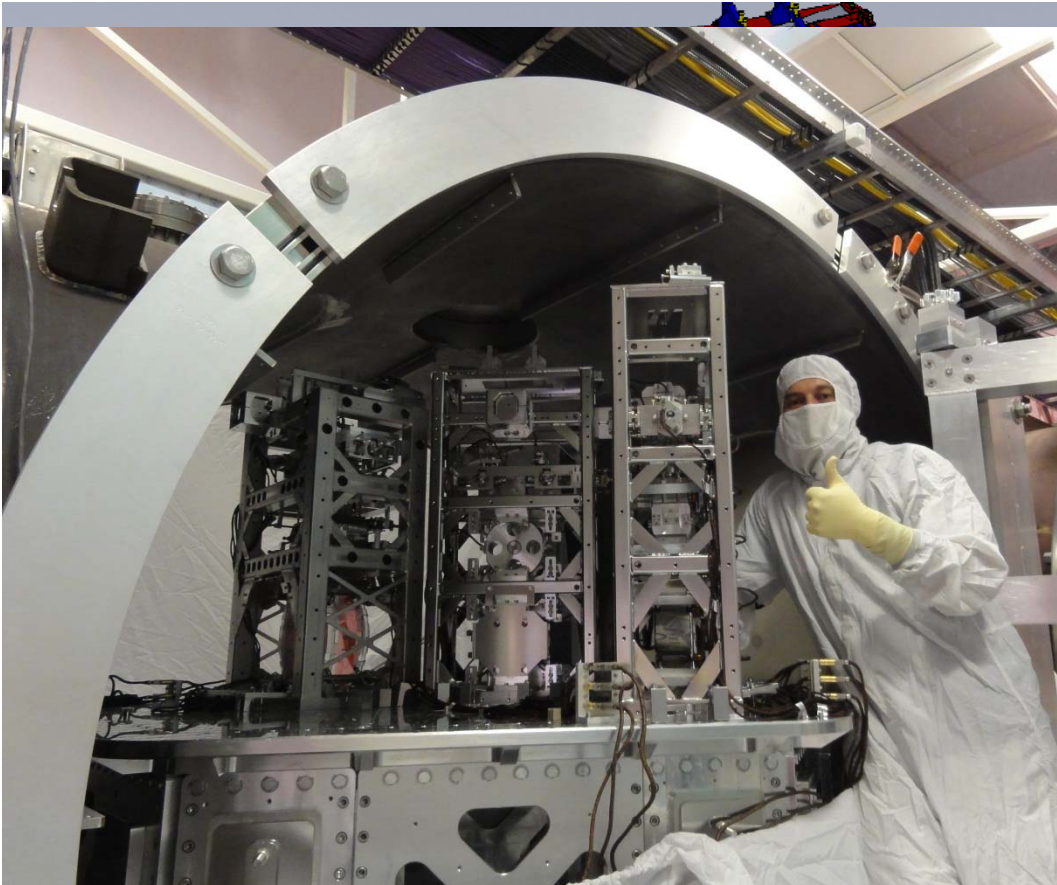

Where are we?

- All designs are complete, all major items procured
- ~85% of the subsystem work is completed
- The installation phase is well underway, with at least one example of each part installed
....and they all fit and work together, happily
- The 'integrated testing' of many components together is getting started
- **First 4km aLIGO cavity just locked at Hanford!
First light in suspended mode cleaner at Livingston !**
 - » Part of a test of isolation, suspension, optics, and the pre-lock system; not a complete interferometer...but still a big step forward!

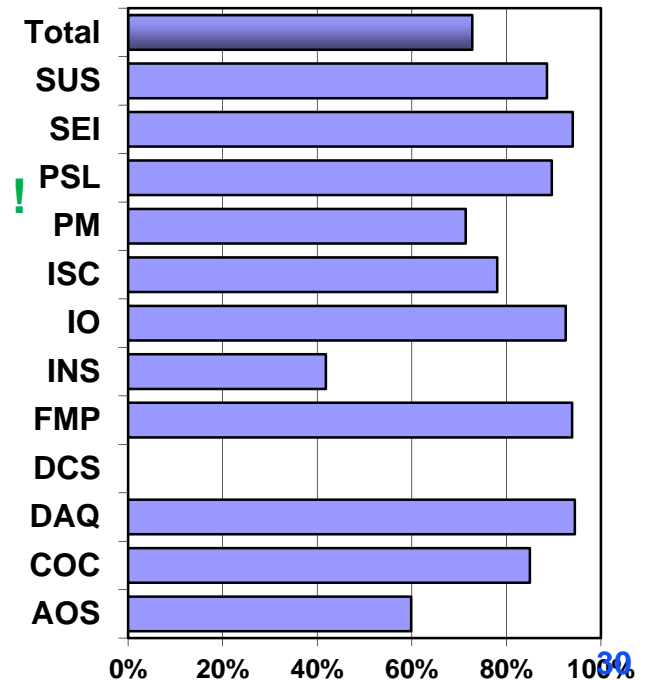



Progression through the Project

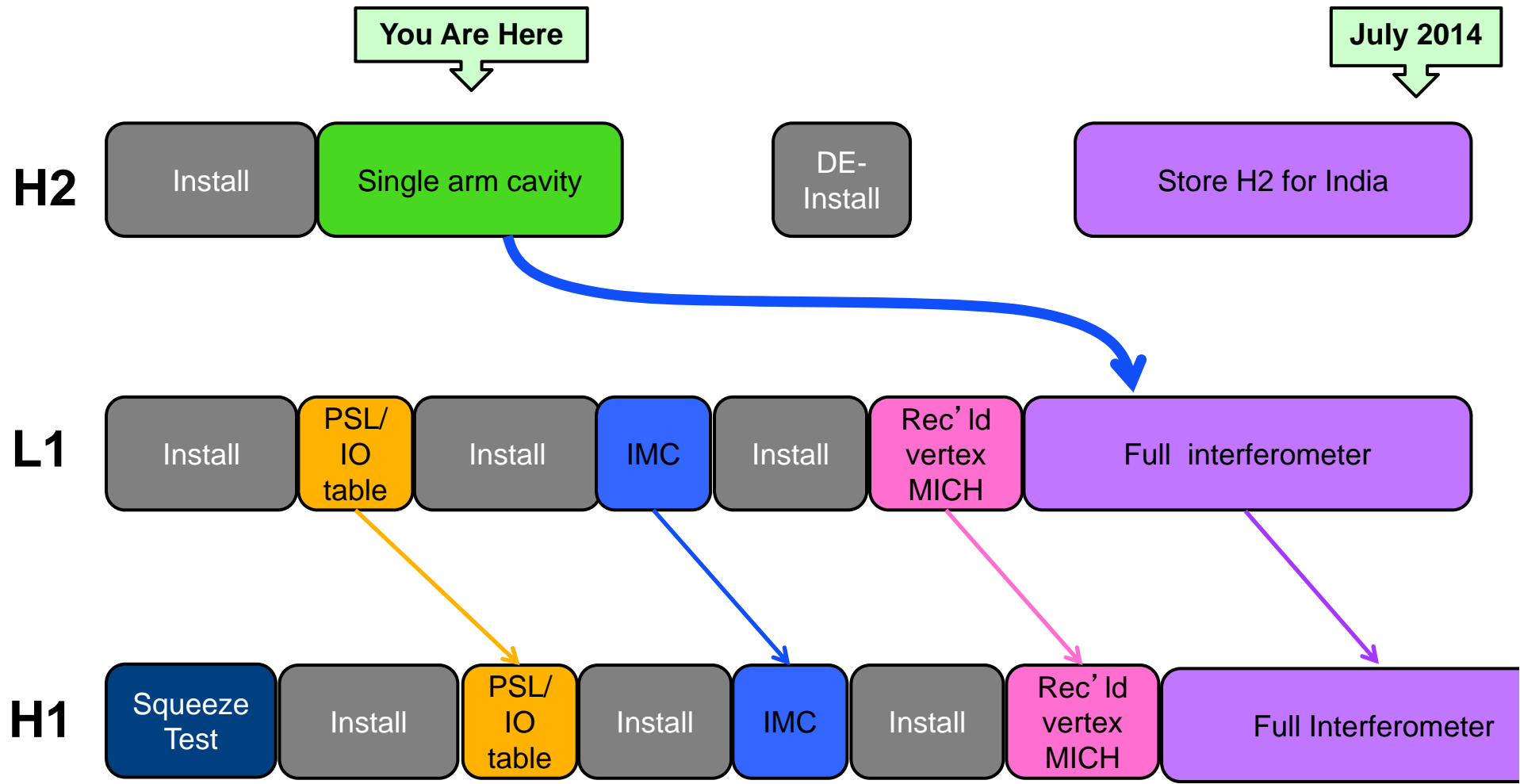

- LIGO Laboratory and the IndIGO consortium pursuing a project to locate an Advanced LIGO interferometer in India
- Greatly improved sky localization of gravitational-wave events
- LIGO Laboratory provides components for one Advanced LIGO interferometer from the Advanced LIGO project (leaves two in the US – WA, and LA)
- India provides the site, roads, building, vacuum system, and the team to make it happen
- Working its way through the Indian government funding system, and the NSF
- For now, 3rd interferometer components going in boxes

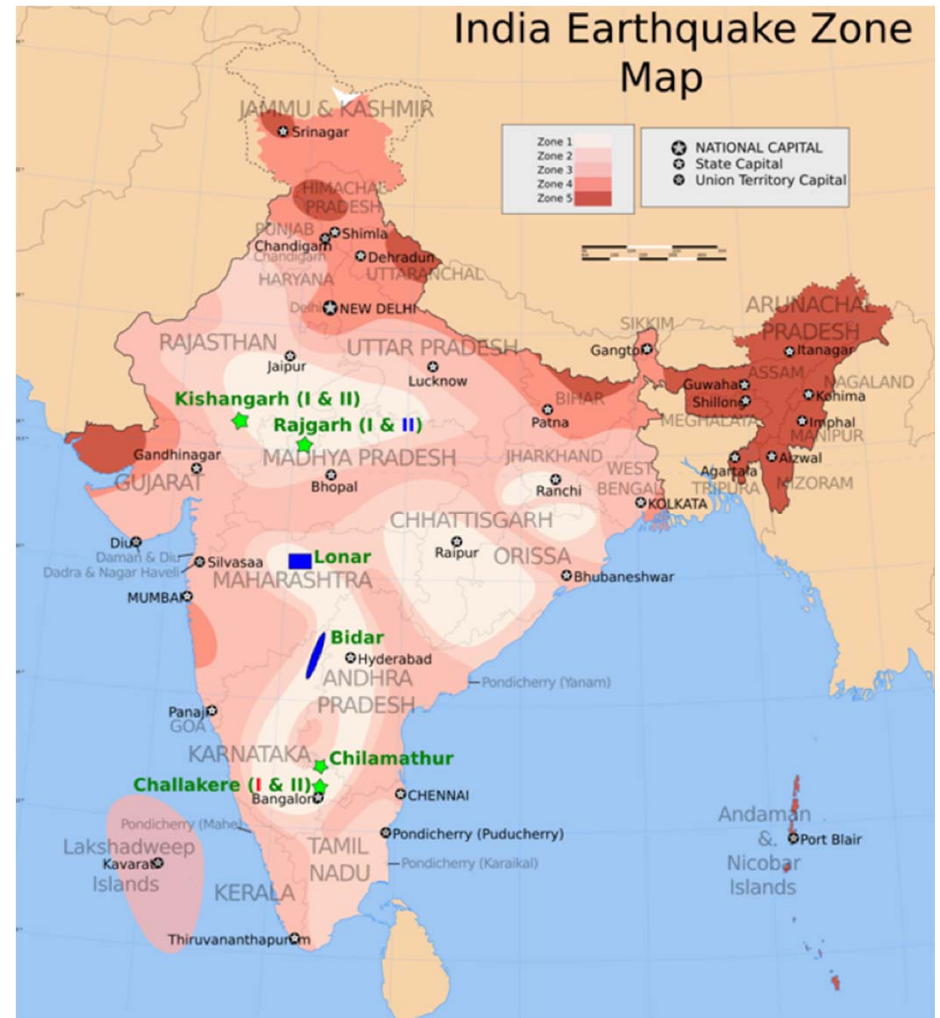

Candidate sites in green, blue



And after the Project: Tuning for Astrophysics, and Observation

- ✧ Transition from Project back to Lab/collaboration after two-hour lock
 - ✧ Planned for 2014
- ✧ First work with low laser power
 - ✧ No heating problems
 - ✧ No optically-driven torques
 - ✧ Focus on low frequencies
 - ✧ Probably no signal recycling
- ✧ Ideal for first astrophysics as well
 - ✧ Standard candles are binary neutron stars
 - ✧ Most SNR in the 20-200 Hz region
- ✧ Focus later on high power, high frequency range

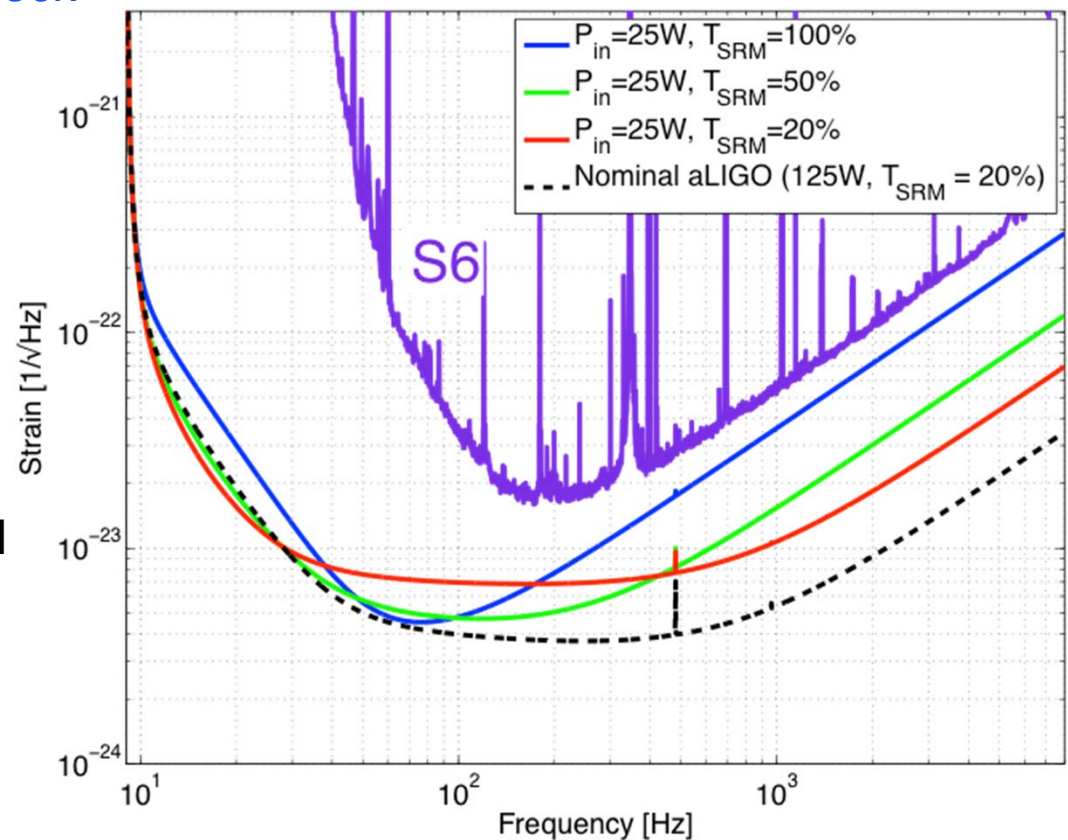



Current guess for sensitivity evolution, observation

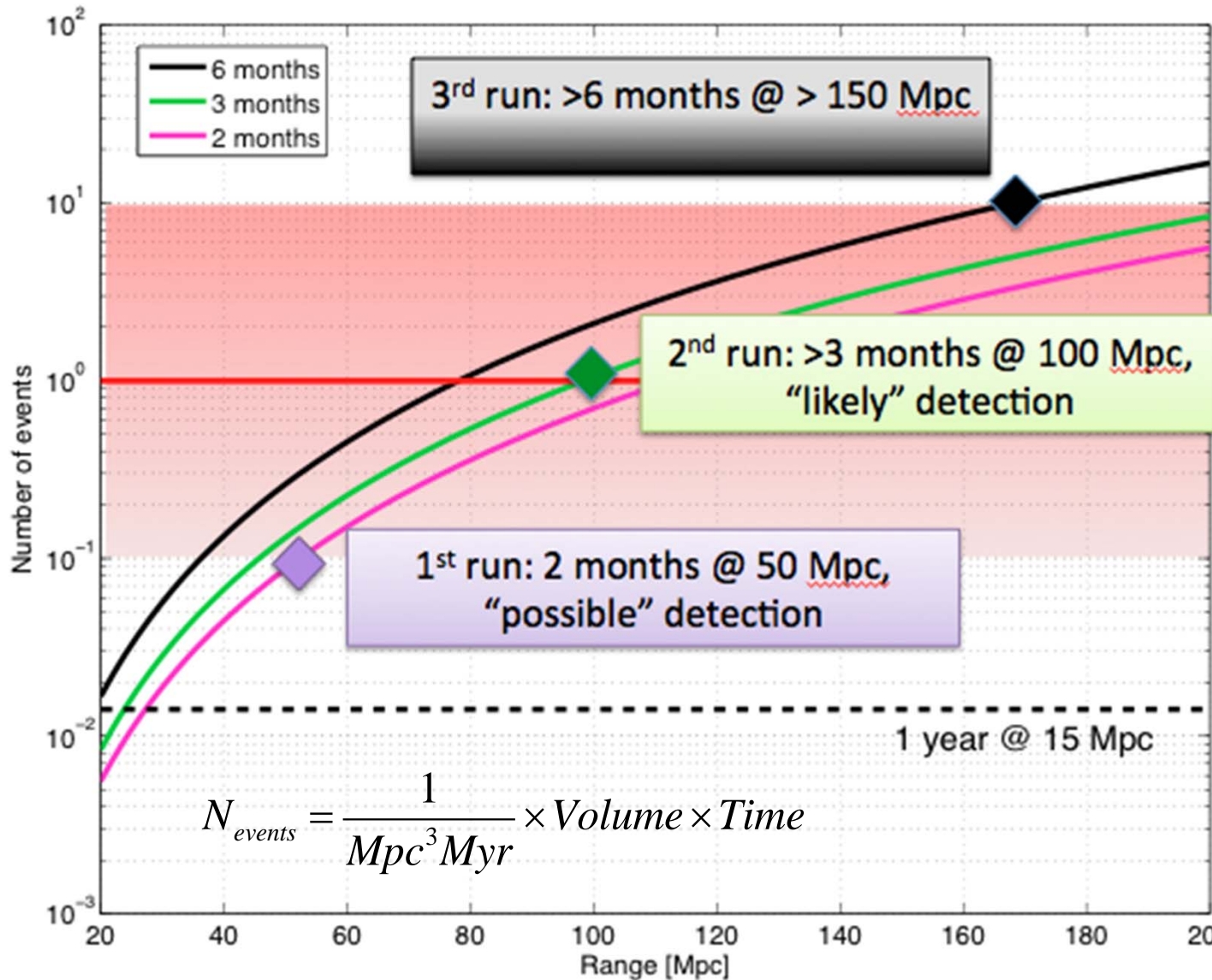



The Last Page

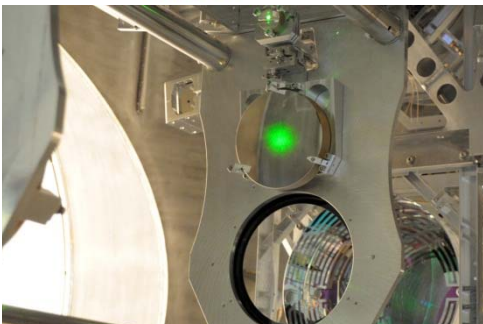
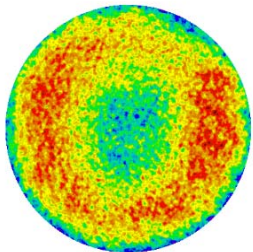
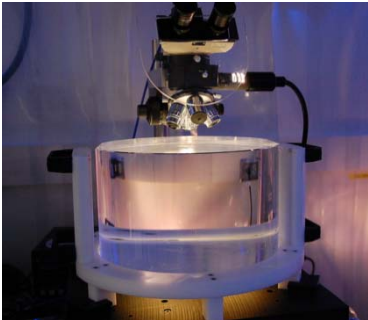

- The next generation of gravitational-wave detectors will have the sensitivity to make frequent detections
- The Advanced LIGO detectors are coming along well, planned to complete in 2014
- The world-wide community is growing, and is working **together** toward the goal of gravitational-wave astronomy

Planning on a first observation 'run' as early as 2015

