

Geophones Corner 1&2 CPS Corner 1&2

HAM6, C1-31

ISI Interface (Part 1)

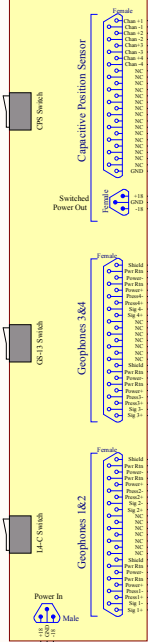

Rack Field

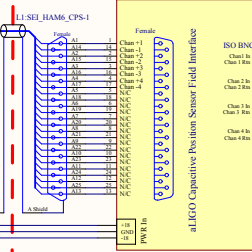

Air Vacuum

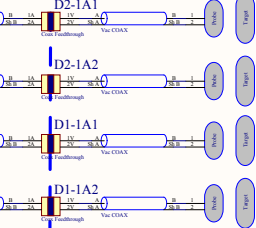

Horiz. Corner 1
Vert. Corner 1
Horiz. Corner 2
Vert. Corner 2

D2-3C1

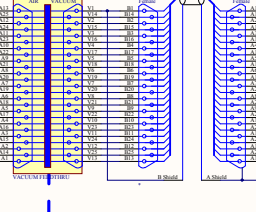

D1000222 D1000227

D1-3C1

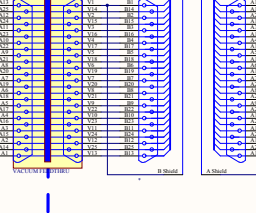

D1000220 D1000227

GS-13 Horiz (Geoph 4) Corner 2
GS-13 Vert (Geoph 3) Corner 2
GS-13 Horiz (Geoph 2) Corner 1
GS-13 Vert (Geoph 1) Corner 1

Geophones Corner 3 CPS Corner 3

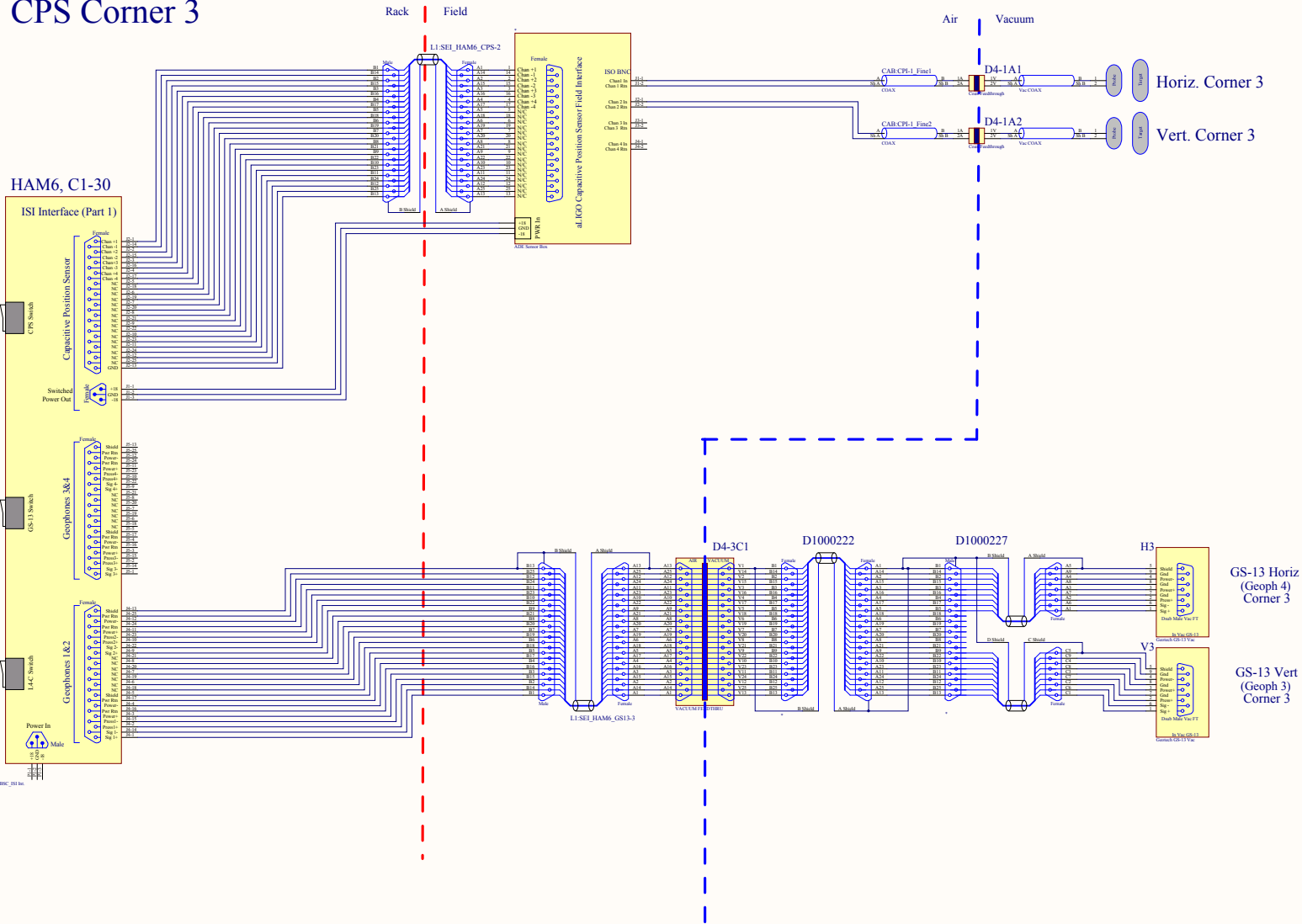

HAM6, C1-28

HAM AA Interface Chassis
D1000269

HAM6, C1-31

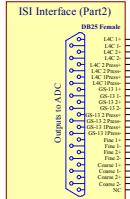

Corner 1&2 Coil Driver
Page 4

L1-SEL_HAM6_Coil_ADC-1

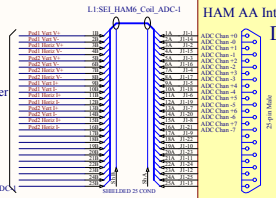

Corner 3 Coil Driver
Page 4

L1-SEL_HAM6_Coil_ADC-2

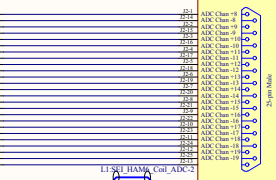

From STS A(HAM2)

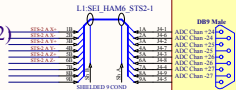

Duotone channel

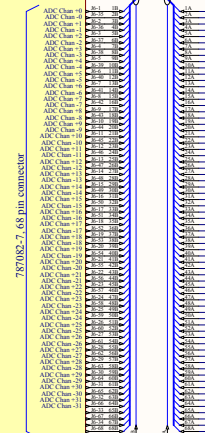

ADC_0_C1800	Pd01_Vest_V
ADC_0_C1801	Pd01_Hotter_V
ADC_0_C1802	Pd02_Vest_V
ADC_0_C1803	Pd02_Hotter_V
ADC_0_C1804	Pd01_Vest_I
ADC_0_C1805	Pd01_Hotter_I
ADC_0_C1806	Pd02_Vest_I
ADC_0_C1807	Pd02_Hotter_I
ADC_0_C1808	Ch01_GS-13_V
ADC_0_C1809	Ch01_GS-14_V
ADC_0_C1810	Ch02_GS-13_V
ADC_0_C1811	Ch02_GS-14_V
ADC_0_C1812	Ch01_DIHP_GS11
ADC_0_C1813	Ch01_Press_GS11
ADC_0_C1814	Ch02_DIHP_GS11
ADC_0_C1815	Ch02_Press_GS11
ADC_0_C1816	Ch01_CPS-H
ADC_0_C1817	Ch01_CPS-V
ADC_0_C1818	Ch02_CPS-H
ADC_0_C1819	Ch02_CPS-V
ADC_0_C1820	Pd01_Vest_V
ADC_0_C1821	Pd01_Hotter_V
ADC_0_C1822	Pd02_Vest_V
ADC_0_C1823	Pd02_Hotter_V
ADC_0_C1824	STS-2 A X
ADC_0_C1825	STS-2 A Y
ADC_0_C1826	STS-2 A Z
ADC_0_C1827	
ADC_0_C1828	
ADC_0_C1829	
ADC_0_C1830	
ADC_0_C1831	Duotone

HAM 6 ISI ADCs

HAM6, C1-30

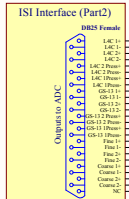

Corner 3 Signals (Sheet 2)

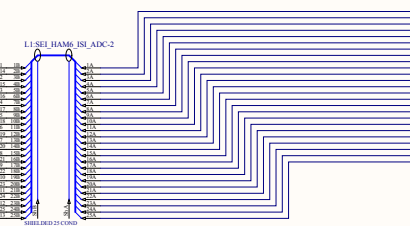

From STS B(BSC2)

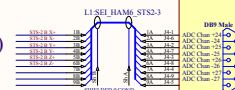

From STS C(HAM5)

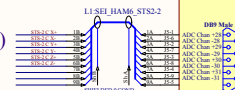

HAM6, C1-27

HAM AA Interface Chassis
D1000269

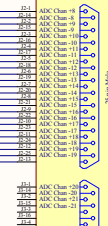

Corner 3 Signals (Sheet 2)

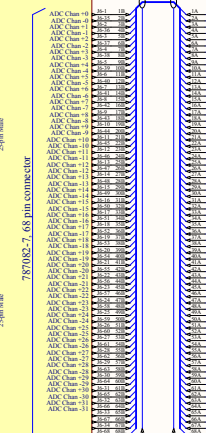

ADC_1_C1400	
ADC_1_C1401	
ADC_1_C1402	
ADC_1_C1403	
ADC_1_C1404	
ADC_1_C1405	
ADC_1_C1406	
ADC_1_C1407	
ADC_1_C1408	Ch01_GS-13_V
ADC_1_C1409	Ch01_GS-14_V
ADC_1_C1410	
ADC_1_C1411	
ADC_1_C1412	Ch01_DIHP_GS11
ADC_1_C1413	Ch01_Press_GS11
ADC_1_C1414	
ADC_1_C1415	Ch02_GS-13_V
ADC_1_C1416	Ch02_GS-14_V
ADC_1_C1417	
ADC_1_C1418	
ADC_1_C1419	
ADC_1_C1420	
ADC_1_C1421	
ADC_1_C1422	
ADC_1_C1423	
ADC_1_C1424	STS-2 B X
ADC_1_C1425	STS-2 B Y
ADC_1_C1426	STS-2 B Z
ADC_1_C1427	
ADC_1_C1428	STS-2 C X
ADC_1_C1429	STS-2 C Y
ADC_1_C1430	STS-2 C Z
ADC_1_C1431	

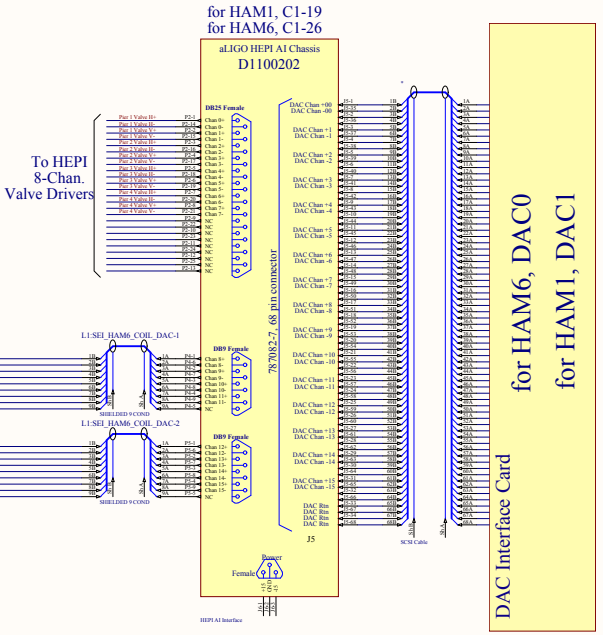
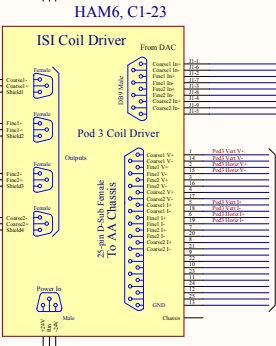
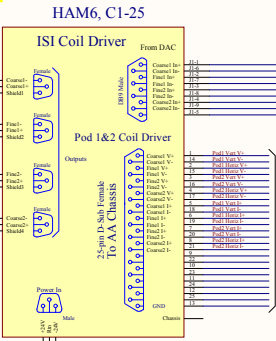
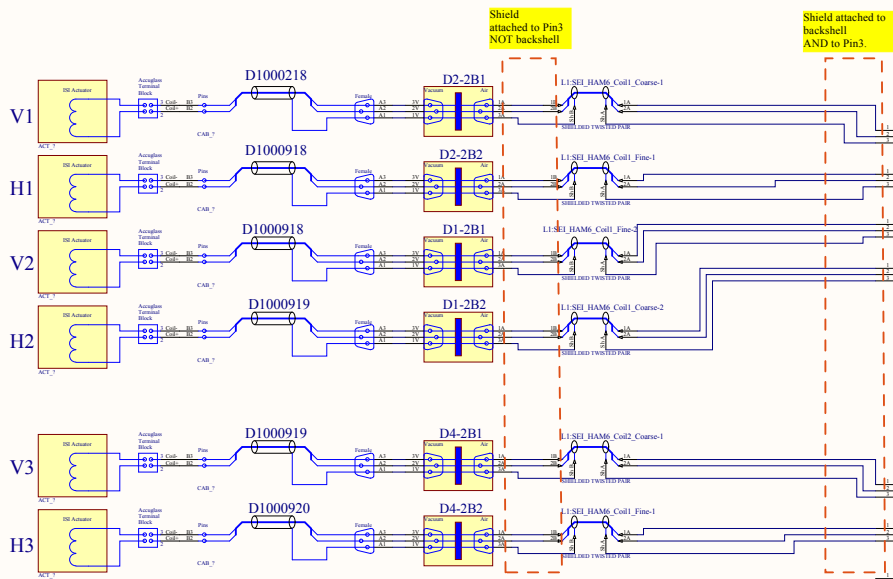

HAM 6		HAM 1	
DAC 0 CH80	Panel Valve Horiz HAM6	DAC 1 CH80	Panel Valve Horiz HAM1
DAC 0 CH81	Panel Valve Vert HAM6	DAC 1 CH81	Panel Valve Vert HAM1
DAC 0 CH82	Panel Valve Horiz HAM6	DAC 1 CH82	Panel Valve Horiz HAM1
DAC 0 CH83	Panel Valve Vert HAM6	DAC 1 CH83	Panel Valve Vert HAM1
DAC 0 CH84	Panel Valve Horiz HAM6	DAC 1 CH84	Panel Valve Horiz HAM1
DAC 0 CH85	Panel Valve Vert HAM6	DAC 1 CH85	Panel Valve Vert HAM1
DAC 0 CH86	Panel Valve Horiz HAM6	DAC 1 CH86	Panel Valve Horiz HAM1
DAC 0 CH87	Panel Valve Vert HAM6	DAC 1 CH87	Panel Valve Vert HAM1
DAC 0 CH88	Coil 1 HAM6	DAC 1 CH88	Coil 1 HAM1
DAC 0 CH89	Coil 2 HAM6	DAC 1 CH89	Coil 2 HAM1
DAC 0 CH90	Coil 3 HAM6	DAC 1 CH90	Coil 3 HAM1
DAC 0 CH91	Coil 4 HAM6	DAC 1 CH91	Coil 4 HAM1
DAC 0 CH92	Coil 5 HAM6	DAC 1 CH92	Coil 5 HAM1
DAC 0 CH93	Coil 6 HAM6	DAC 1 CH93	Coil 6 HAM1
DAC 0 CH94	Coil 7 HAM6	DAC 1 CH94	Coil 7 HAM1
DAC 0 CH95	Coil 8 HAM6	DAC 1 CH95	Coil 8 HAM1

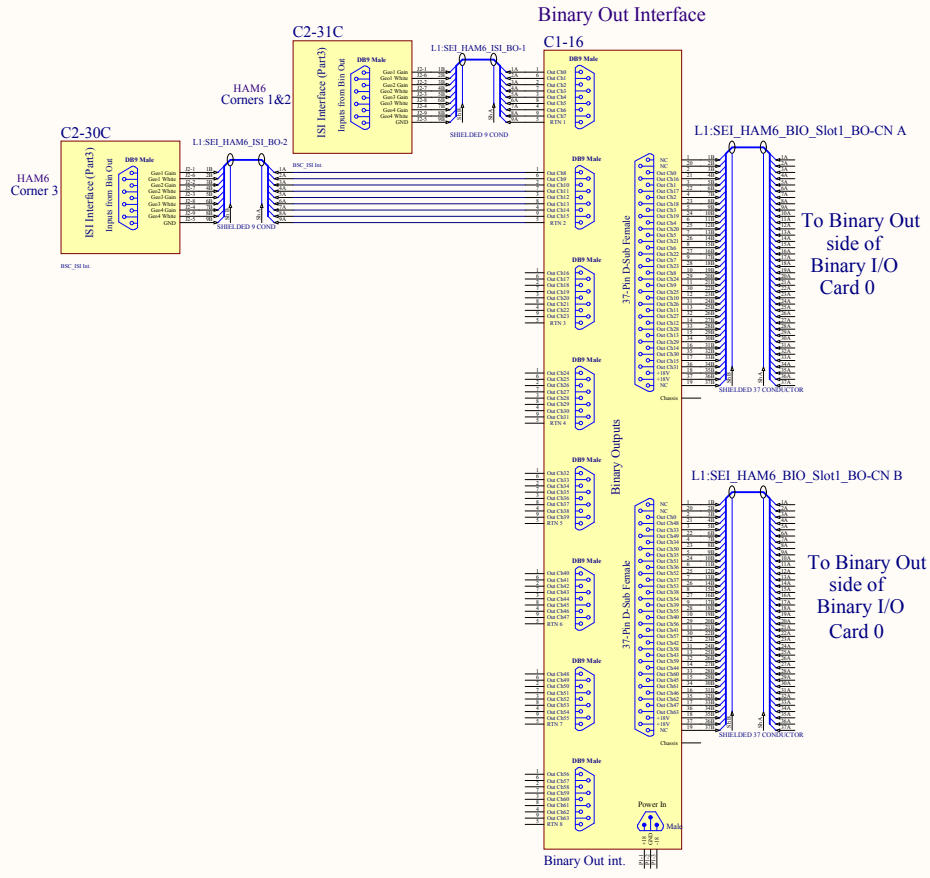

To Binary Out side of Binary I/O Card 0

To Binary Out side of Binary I/O Card 0

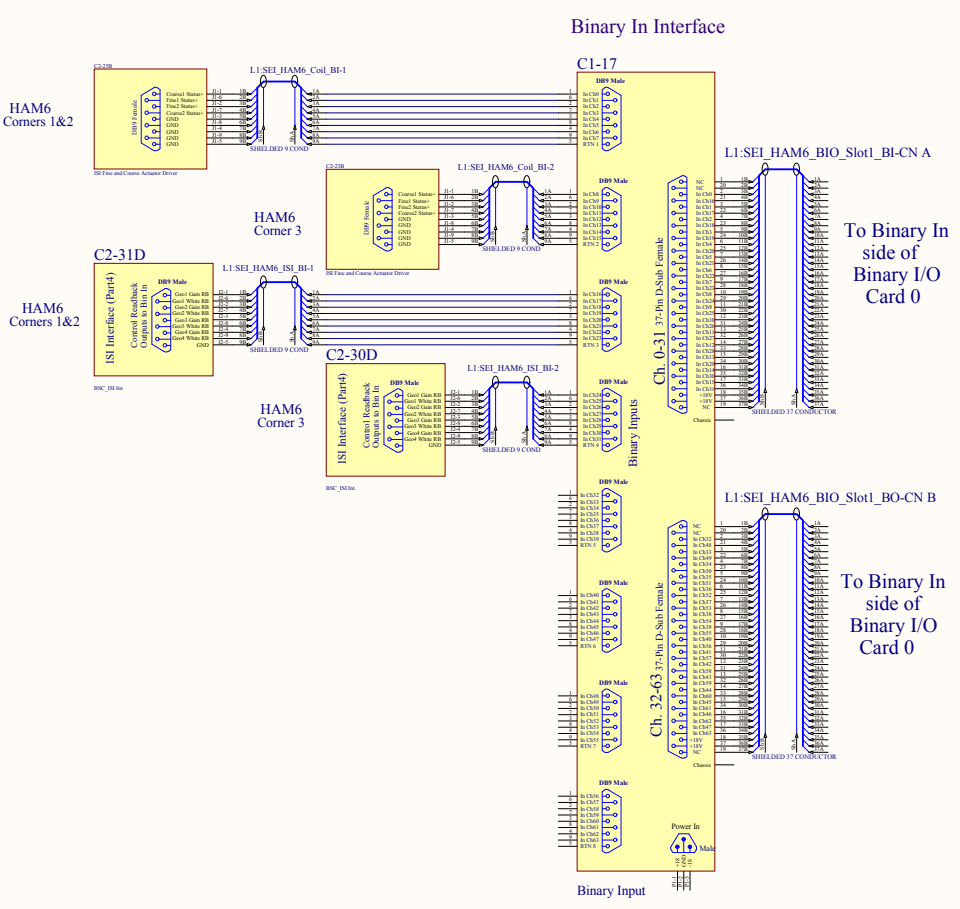

To Binary In side of Binary I/O Card 0

To Binary In side of Binary I/O Card 0

adIGO HAM6 1&6 ISI System Wiring			
Rev:	001	4497 Project	Created with the
Author:	D	NSC Number 01101214	California Institute of Technology
Part Number:	000-000000	Revision: 01	© 2000-2001

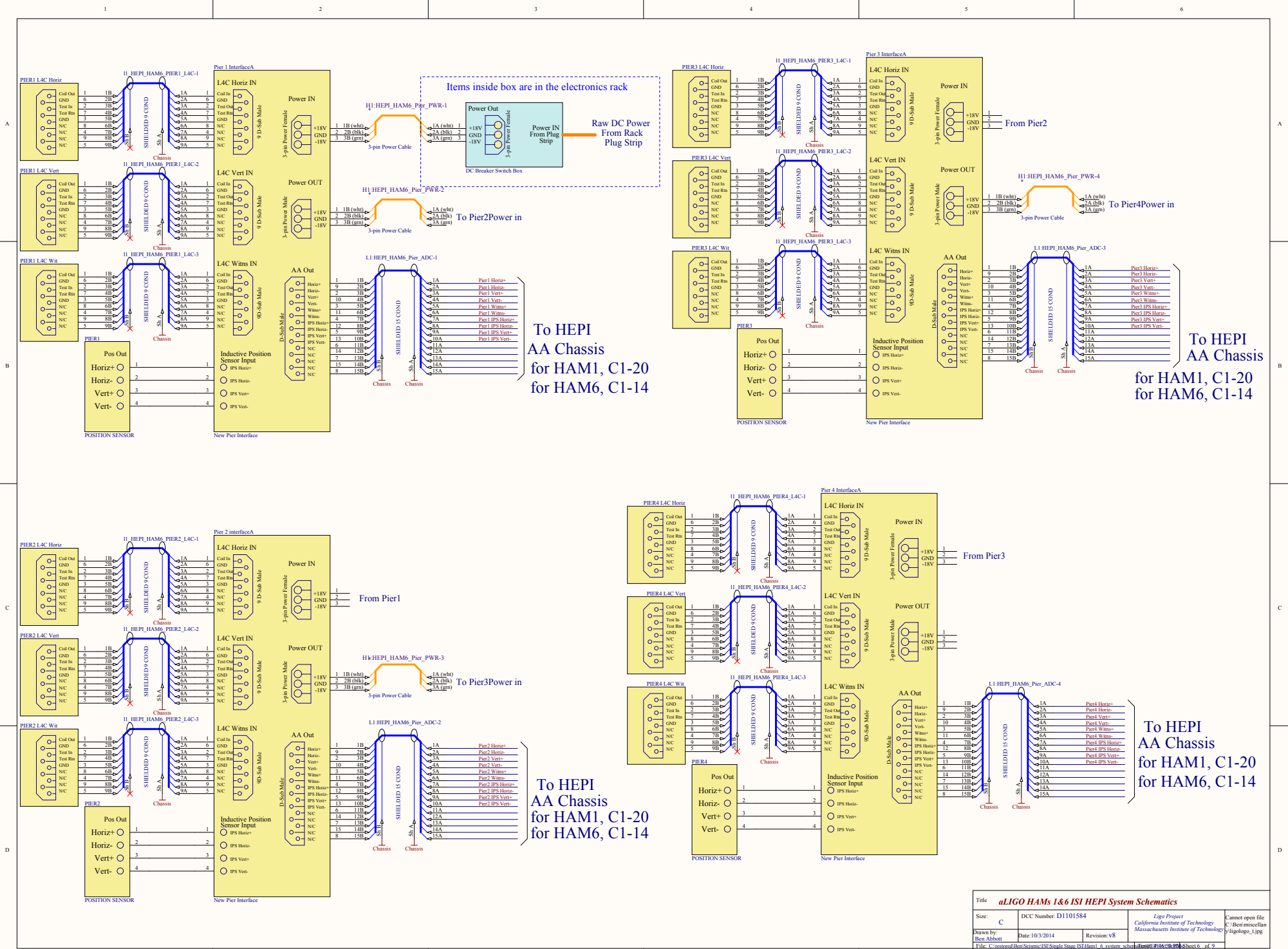

Items inside box are in the electronics rack

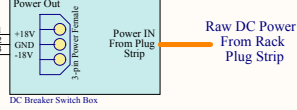

To HEPI AA Chassis for HAM1, C1-20 for HAM6, C1-14

To HEPI AA Chassis for HAM1, C1-20 for HAM6, C1-14

To HEPI AA Chassis for HAM1, C1-20 for HAM6, C1-14

To HEPI AA Chassis for HAM1, C1-20 for HAM6, C1-14

Title		ALIGO HAMS 1&6 ISI HEPI System Schematics	
Size:	C	DCC Number:	D1101584
Drawn by:	Ben Abbott	Date:	10/3/2014
File:	C:\astro\ben\Science\ISI\Single\Shas\ISI\Ham1_6_system_schematic_#161628_111_Sheet 6. of 9	Revision:	v8
Ligo Project		California Institute of Technology Massachusetts Institute of Technology	
Cannot open file C:\Ben\miscellan\aligologo_1.jpg			

for HAM1, C1-20
for HAM6, C1-14

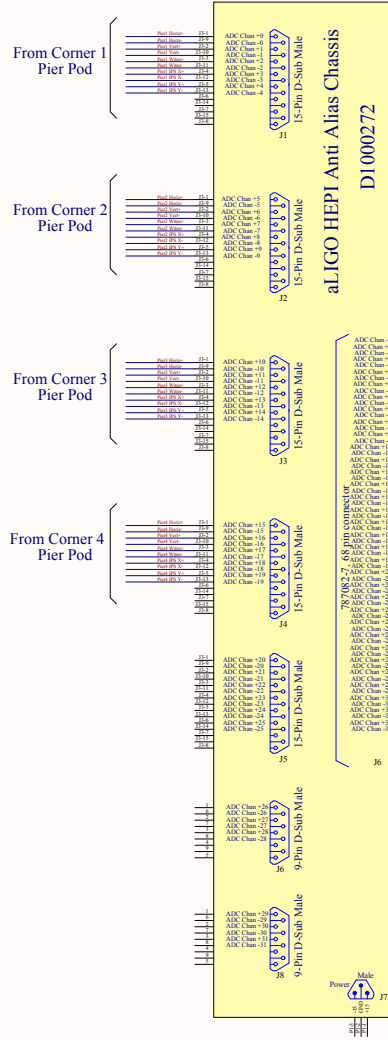

ADC Interface Card
for HAM1, ADC2
for HAM6, ADC3

HAM 1

ADC-2 C100	Pier1 Horiz
ADC-2 C101	Pier1 Vert
ADC-2 C102	Pier1 Wit
ADC-2 C103	Pier1 LPS Horiz
ADC-2 C104	Pier1 LPS Vert
ADC-2 C105	Pier2 Horiz
ADC-2 C106	Pier2 Vert
ADC-2 C107	Pier2 Wit
ADC-2 C108	Pier2 LPS Horiz
ADC-2 C109	Pier2 LPS Vert
ADC-2 C110	Pier3 Horiz
ADC-2 C111	Pier3 Vert
ADC-2 C112	Pier3 Wit
ADC-2 C113	Pier3 LPS Horiz
ADC-2 C114	Pier3 LPS Vert
ADC-2 C115	Pier4 Horiz
ADC-2 C116	Pier4 Vert
ADC-2 C117	Pier4 Wit
ADC-2 C118	Pier4 LPS Horiz
ADC-2 C119	Pier4 LPS Vert
ADC-2 C120	
ADC-2 C121	
ADC-2 C122	
ADC-2 C123	
ADC-2 C124	
ADC-2 C125	
ADC-2 C126	
ADC-2 C127	
ADC-2 C128	
ADC-2 C129	
ADC-2 C130	
ADC-2 C131	

HAM 6

ADC-3 C100	Pier1 Horiz
ADC-3 C101	Pier1 Vert
ADC-3 C102	Pier1 Wit
ADC-3 C103	Pier1 LPS Horiz
ADC-3 C104	Pier1 LPS Vert
ADC-3 C105	Pier2 Horiz
ADC-3 C106	Pier2 Vert
ADC-3 C107	Pier2 Wit
ADC-3 C108	Pier2 LPS Horiz
ADC-3 C109	Pier2 LPS Vert
ADC-3 C110	Pier3 Horiz
ADC-3 C111	Pier3 Vert
ADC-3 C112	Pier3 Wit
ADC-3 C113	Pier3 LPS Horiz
ADC-3 C114	Pier3 LPS Vert
ADC-3 C115	Pier4 Horiz
ADC-3 C116	Pier4 Vert
ADC-3 C117	Pier4 Wit
ADC-3 C118	Pier4 LPS Horiz
ADC-3 C119	Pier4 LPS Vert
ADC-3 C120	
ADC-3 C121	
ADC-3 C122	
ADC-3 C123	
ADC-3 C124	
ADC-3 C125	
ADC-3 C126	
ADC-3 C127	
ADC-3 C128	
ADC-3 C129	
ADC-3 C130	
ADC-3 C131	

for HAM1, C1-18
for HAM6, C1-12

From AI Chassis
for HAM1, C1-19
for HAM6, C1-26
Page 4

