

CALIFORNIA INSTITUTE OF TECHNOLOGY

LIGO Project, 18-34 East Bridge Laboratory, Pasadena, California 91125
(626) 395-2129, Fax (626) 304-9834

Date: October 12, 1998
Refer to: LIGO-L980492-00-P

Ms. Carol A. Langguth
Grants Officer
Division of Grants and Agreements
National Science Foundation
4201 Wilson Blvd.
Arlington, VA 22230

Subject: LIGO Project Quarterly Progress Report, LIGO-M980208-00-P

Reference: NSF Award No. PHY-9210038

Dear Ms. Langguth:

Four copies of the LIGO Project Quarterly Progress Report providing status information for the quarter ending August 1998 are enclosed in accordance with the requirements of the award referenced above. Please forward three (3) copies to Dr. Berley.

Sincerely,

Philip E. Lindquist
LIGO Project Controls Manager

Concurrence for Caltech:

Richard Seligman
Director, Sponsored Research

PEL:pel

cc:

G. Sanders
B. Barish
Chronological File
Document Control Center

Quarterly Progress Report

(Quarter Ending August 1998)

The Construction, Operation and Supporting Research
and Development of a Laser Interferometer Gravitational-
Wave Observatory (LIGO)

NSF Cooperative Agreement No. PHY-9210038

LIGO-M980208-00-P

Quarterly Progress Report

(End of August 1998)

THE CONSTRUCTION, OPERATION AND SUPPORTING RESEARCH AND DEVELOPMENT OF A LASER INTERFEROMETER GRAVITATIONAL-WAVE OBSERVATORY (LIGO)

NSF COOPERATIVE AGREEMENT No. PHY-9210038

LIGO-M980208-00-P

CALIFORNIA INSTITUTE OF TECHNOLOGY

1.0 Introduction

This Quarterly Progress Report is submitted under NSF Cooperative Agreement PHY-9210038¹. The report summarizes Laser Interferometer Gravitational-Wave Observatory (LIGO) Project status for the quarter ending August 1998.

2.0 Recent Progress and Status

The project has entered an exciting new phase. The highly successful facility construction, including the vacuum system, is nearing completion, and the focus is now shifting to the Detector with the beginning of Detector installation at the Hanford Observatory. The majority of Detector subsystems is being fabricated, and most have delivered some hardware to Hanford for installation. Overall, the project continues to make excellent progress and is 88 percent complete as of the end of August 1998.

2.1 Vacuum Equipment

Commissioning activities in Livingston, Louisiana began in August. Most of the installation is complete. The commissioning in Washington is now eight weeks behind schedule due to the required inspection and rework of the large 44 and 48 inch gate valves. However, Process Systems International (PSI) has ordered work priorities to avoid significant delays in the Beam Tube bake and Detector installation. The primary constraints are in the corner station Laser and Vacuum Equipment Area (LVEA) where LIGO and PSI personnel are sharing work space and the overhead cranes.

During this quarter PSI completed acceptance testing in the Hanford corner station and the X-arm end station. Only the X-arm mid-station remains to be tested, and this is now in process since the gate valve work there has been completed. Also during this period, PSI began vacuum baking the chambers in the Livingston X-arm end-station.

1. Cooperative Agreement No. PHY-9210038 between the National Science Foundation, Washington, D.C. 20550 and the California Institute of Technology, Pasadena, CA 91125, May 1992.

Figure 1 below provides two views of the completed LVEA vacuum system. Figure 2 shows the internal components of a gate valve during inspection.



FIGURE 1. Hanford Laser and Vacuum Equipment Area (LVEA).

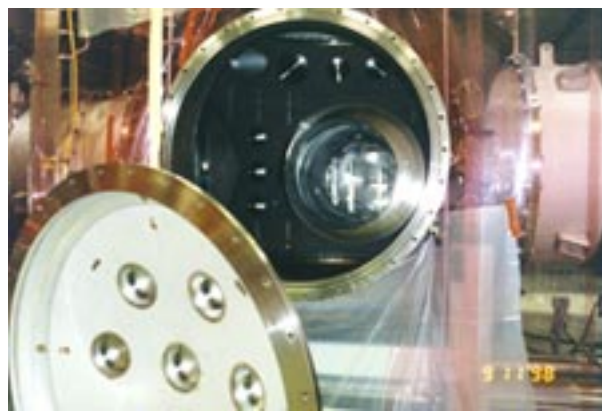

FIGURE 2. Open Beam Splitter Chamber Showing Access to Gate Valve.

2.2 Beam Tube

The Beam Tube contractor, Chicago Bridge & Iron (CB&I), installed the balance of the Beam Tube sections on the Y-arm in Livingston, Louisiana during June, thereby completing installation at the Livingston site eighteen weeks ahead of schedule. The contractor then disposed of the production equipment and most of the field installation equipment. This concluded a very successful fabrication and installation operation. Experience gained during the production and installation of the 800 tube sections at the two sites was manifested in steady improvement in both quality and

efficiency. LIGO purchased the fixtures and equipment that will be useful for Beam Tube maintenance during site operation.

The incident with the X-arm mid-station valve (reported at the end of May) complicated the acceptance test of the Livingston X-arm. Since the valve failed in a nearly closed position, simultaneous accumulations were performed on each of the two X modules to fully account for total arm leakage. A small vacuum pump at the valve bellows removed any contribution that a valve bellows leak might have made. The X-arm modules were accepted early in August based on test data showing a maximum equivalent air load of 2×10^{-7} to 4×10^{-7} torr liter/second--assuming that the entire gas loads of atomic mass units (AMUs) 32 and 40 were due to air leakage.

PSI, the Vacuum Equipment subcontractor, will repair the damaged mid-station valve on the Livingston X-arm, scheduled to start in October.

Improved techniques were used to align the Beam Tube sections at Livingston. Initial positioning of the tube sections was based on preset Global Positioning Satellite (GPS) reference marks for control supports (every sixth support), and laser and string lines for the supports between. Chicago Bridge and Iron (CB&I), the Beam Tube contractor, developed this procedure during alignment activities at the Hanford site. Improvements at Livingston involved coring holes in the Beam Tube Enclosure over the control supports to make direct GPS measurements on the tube support rings for position confirmation. We are reviewing final alignment data submitted late in August for the Livingston Beam Tube.

2.3 Beam Tube Enclosures

Washington Beam Tube Enclosure. Construction activity is complete. We are in the process of closing the contracts for the fabrication and installation of the Beam Tube enclosure.

Louisiana Beam Tube Enclosure. Fabrication and installation of all the enclosure segments is complete. The contractor has finished all construction activities along the X-arm. This includes installation of doors, grouting of the enclosure segments, caulking of the joints, and asphalt paving of the service road. On the Y-arm the contractor is continuing work on the installation of the doors and caulking of the joints. We are preparing the service road for asphalt paving.

2.4 Civil Construction

Washington Civil Construction. Construction activities for the facilities are complete. The subcontractor, Levernier, has finished all "punch list" items. We have selected Apollo Construction, Inc., of Richland, Washington for the water system modification contract. This contract will start early in September and will be completed in three months. We have selected the George Grant Construction Company, also of Richland, to construct the Staging and Storage Building. Construction begins early in October and will require nine months to complete.

Louisiana Civil Construction. Construction activities are 97 percent complete. Accomplishments during this reporting period include the completion of "punch list" items, such as the rework on the Heating, Ventilation, and Air Conditioning (HVAC) system and resolution of problems with the electrical power supply system. The remainder of the "punch list," including sealing

of the roof, repair of some wall panels, and completion of the water integration system, are in progress and most will be finished in October.

2.5 Beam Tube Vacuum Bake

During this quarter, we completed installation and checkout of the vacuum bake equipment of the Hanford Y2 Beam Tube module. On August 18, heating of the tube started, and a bake temperature of (150 C) was reached at 03:00 on August 22. All systems are operating as expected, and the first Beam Tube module bake will continue through the week of September 29, 1998. Figure 3 illustrates the temperature vs. time history during initial heating, while Figure 4 on page 5 shows the residual gas spectrum from the tube after ten days of baking.

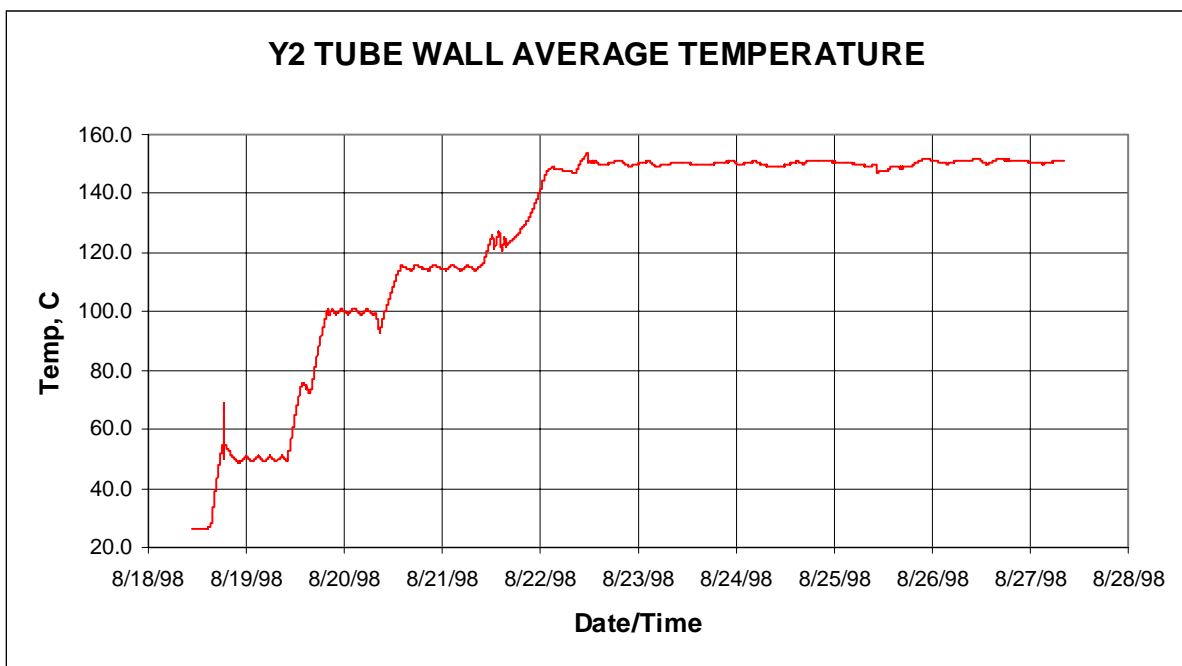

FIGURE 3. Beam Tube Bake Temperature vs. Time During Initial Heating

2.6 Detector

2.6.1 40 Meter Laboratory

During this reporting period we continued to characterize the LIGO configuration test interferometer. We made progress with the wavefront sensors on the Power Recycled Michelson configuration, controlling pitch and yaw of the beam splitter and recycling mirror. Using these sensors, we achieved greatly improved system performance. Some slight instabilities remain, most likely due to inadequate gain--none of the suspension controllers at the 40 meter were designed for Alignment Sensing Control (ASC) system inputs. We are now using a prototype LIGO Data Acquisition System (LDAS) to find sources of residual motions.

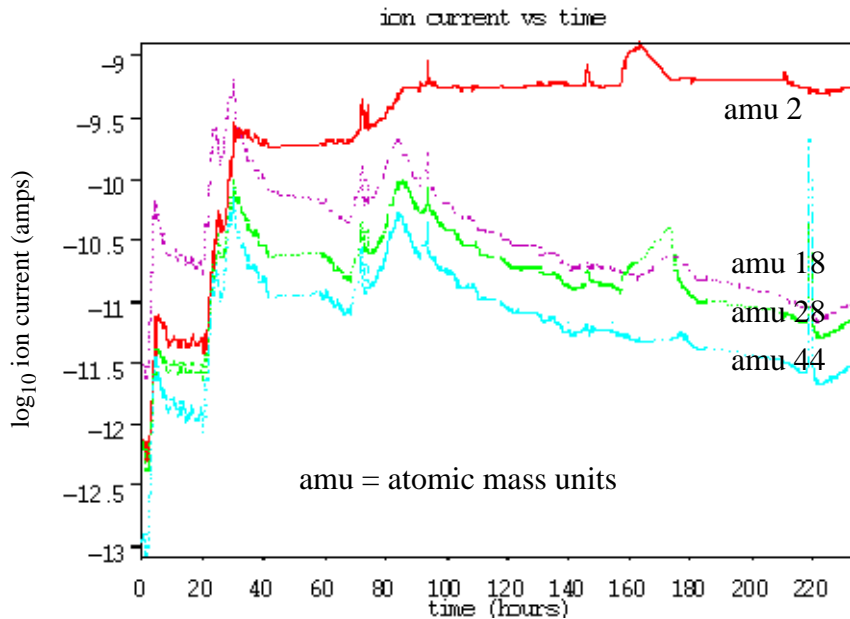

FIGURE 4. Residual Gas Spectrum After Ten Days

Attention then reverted to the full interferometer locking process and the comparison with the dynamic model (also used for the LIGO servocontrol design). The LDAS was used to diagnose the locking process and to understand reasons for loss of lock. Diagnostic programs developed are being incorporated into the full LIGO diagnostics approach.

2.6.2 Interferometer Sensing and Control

Alignment Sensing and Control. The Final Design Review for Wavefront Sensing was held July 23. Prototypes have been fabricated and tested for much of the system, and the few issues raised during the review were resolved. This system will now go into production.

Most parts for the optical lever, video, and chamber illumination systems are in-house. We assembled the first article hardware for the optical lever transmitter assembly, the optical lever receiver assembly, the video camera housing, and the chamber illuminator housing, with fit and finish deemed acceptable in each case. Assembly areas for the optical levers and other Interferometer Sensing/Control elements have been established in the new MIT lab. Assembly of the first complete deliverable optical lever is nearly complete with shipment to the site planned for September 1. The grout plates for the optical levers, needed for site installation, have been received, checked, and forwarded to Hanford for mounting to the concrete floor.

Length Sensing and Control. The Final Design Review of the Length Sensing/Control system was held July 29. We revisited the “optical plant” to finalize the design of the detection mode servos and signal conditioning. The “baseline” Fast Fourier Transform (FFT) simulation, using our best understanding of the substrate coatings and thermal lensing properties, shows a large carrier contrast defect (2.8×10^{-3} , with most of the power in modes $m + n > 2$), four times larger than the previous “baseline” simulation. This does not significantly affect the net sensitivity of the inter-

ferometer, but the optimum modulation index and the total power at the antisymmetric port do increase considerably, and these changes have been incorporated into the design. One consequence is that twice as many photodetectors, eight instead of four, will be required. Other aspects of the design addressed were signal conditioning (anti-aliasing/pre-whitening, digital filtering, de-whitening) for the differential mode controls; the addition of the vertical “bounce” mode of the pendulum in the common-mode controls model; test mass (pendulum) damping feedback for the Michelson and recycling cavity servos; and an increase in the threshold velocity for locking thereby reducing the locking time by roughly an order of magnitude.

During prototype tests we demonstrated amplitude stabilization of the Marconi RF signal generator to be used as the modulation source. A Schottky diode detector was used to measure the RF amplitude, and the signal was returned to the external AM input on the Marconi to stabilize the generator. The RF amplitude signal was also split to another, out-of-loop diode detector used to measure the residual AM noise. The test showed a residual noise somewhat better than the requirement of fractional fluctuations of $5 \times 10^{-8}/\sqrt{\text{Hz}}$; thus this method will work to stabilize the oscillator to the required level (See Figure 6.)

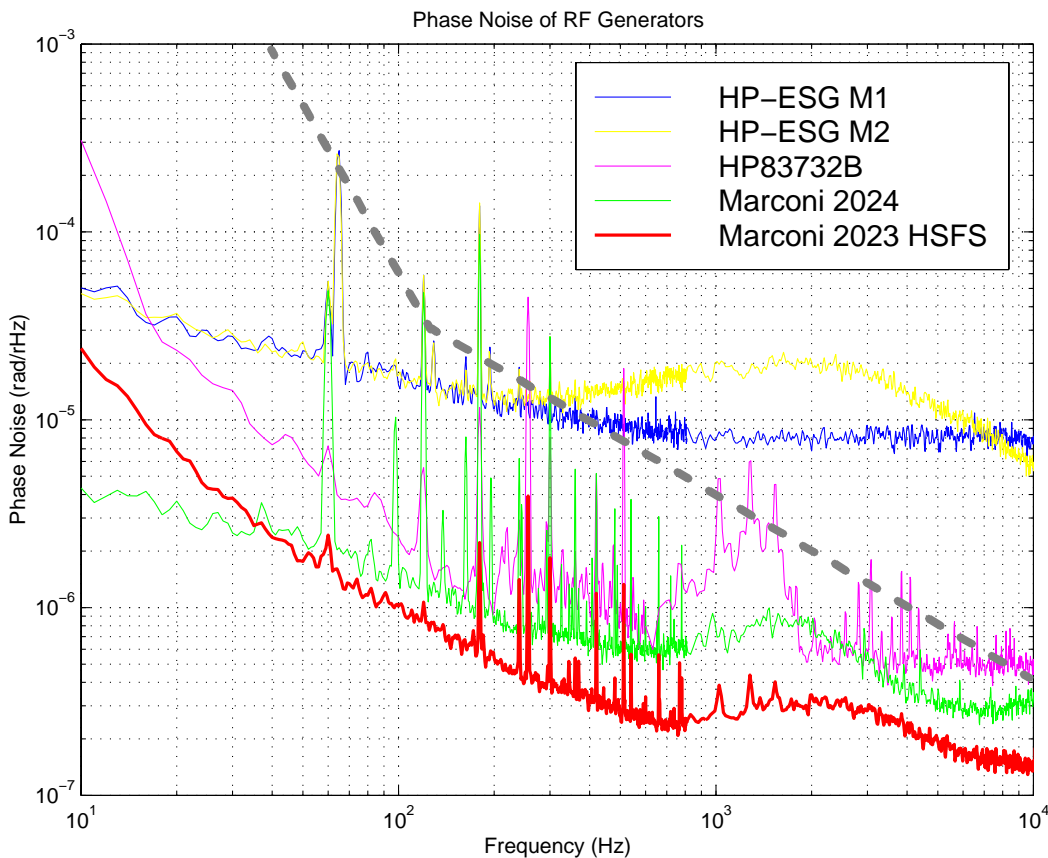

FIGURE 5. The Raw Amplitude Noise of Several RF Oscillators. There is no clear correlation between the noise in this frequency range and the cost.

The Interferometer Sensing/Control support for the Input Optics subsystem includes the alignment and length control systems. The final design, optic and coating selection, and bill of materi-

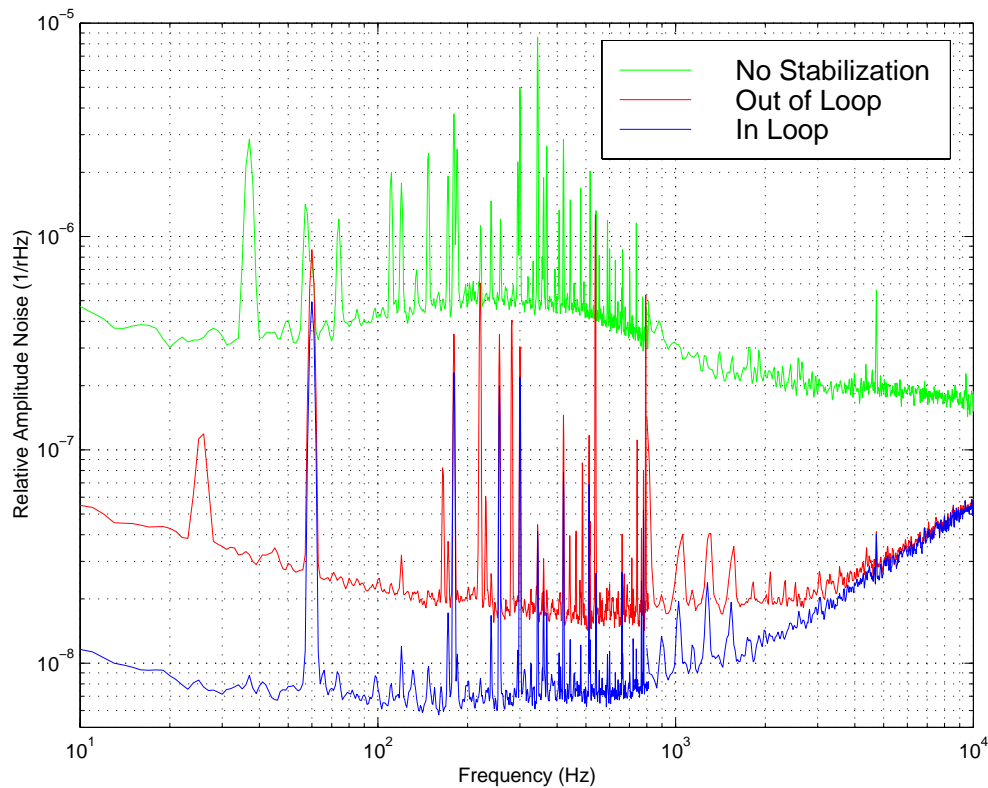
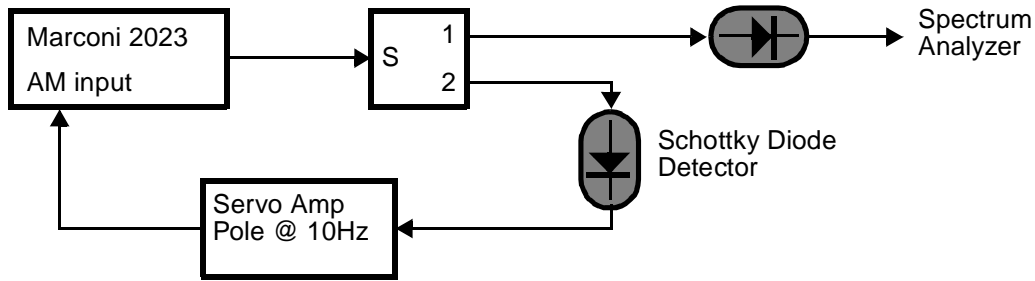

FIGURE 6. Amplitude Noise Unstabilized, Stabilized (Measured in the Loop), and with an Independent Diode of the Selected Marconi Oscillator.

als for the Input Optics Sensing/Control table were completed, and the selection and placement of components is in progress. We will ship this material to Hanford in October on schedule.

Phase Noise Interferometer (PNI) Mixed-signal Loop Test. This test, performed in the test facility for demonstrating phase noise sensitivity, is designed to explore the technology for the digital servosystem for length control. Some highlights:

- We implemented a digital filter in the servo that acts as a resonant gain stage, increasing the gain at the suspension vertical (“bounce”) mode (at 19 Hz) by a factor of 10 over a narrow bandwidth (0.5 Hz). This filter is switched in after the instrument is locked. To do this without breaking lock, we found that we had to switch it in slowly, and we developed an algorithm that

adds in the filter over a one second interval. Measurements showed that we did achieve a suppression of ~20 dB in the vertical mode with the filter in the loop. A gain section of this design will be part of the LIGO length control design.

- We implemented a digital test point system. The signal injection and readout system, using the reflective memory network and the Global Diagnostic System arbitrary wave form generator, is operational. The system was used to inject single frequency sine waves into the loop, and to measure the closed loop transfer function of the Michelson servo. The system worked very well, and we consider this a major success in implementing the diagnostic testing and interfacing of the sensing and control system.
- We measured phase noise data with the Michelson under digital control via two methods: looking at an analog monitor point located after the mixer in the whitening module with a dynamic signal analyzer; and writing digital data to the reflective memory where they are accessed and then stored by a Global Diagnostic System processor. These data are compared to the phase sensitivity seen with the analog loop. The phase sensitivity under digital control is seen to be very similar to that under analog control, giving us confidence in our digital approach.
- We implemented a digital elliptic stop band filter on the Phase Noise Interferometer (PNI) digital crate. This type of filter may be used to provide the required loop attenuation at the test mass resonance frequency to ensure loop stability. The filter worked well and appears to be a reasonable way to provide this function.

With the completion of the mixed-signal servo test, the Phase Noise Interferometer work is complete, and the system has been disassembled. One of the chambers will be used for the thermal noise research at Caltech, and the others for several experiments in and outside of LIGO.

2.6.3 Pre-Stabilized Laser.

10 Watt Laser Source. This quarter we finalized the contractual arrangement for the continued production and improvement of the Lightwave 10W laser. The organization of the Advanced Products Group (APG) at Lightwave will include senior, experienced staff, and 10W lasers will be delivered roughly every three months including two option lasers and two production lasers. A schedule for enhancements is being negotiated.

Pre-stabilized Laser (PSL) Subsystem. We investigated two options for the rapid control of the laser intensity this quarter: modulation of the pump laser diode current, and the use of an acousto-optic modulator as a variable light attenuator for the output beam. The University of Florida performed tests of the high-power performance of the acousto-optics modulator. No problems were observed, and this approach was selected, bringing the design to completion. After the installation of the final electronics package, the first article Pre-stabilized Laser (PSL) at Caltech was operated with very positive results:

- The PSL remains locked to the reference cavity for indefinite periods. Signals from a signal analyzer (0.2 V, 10 Hz - 100 kHz) into the frequency shifter's voltage controlled oscillator (VCO) input do not cause the PSL to lose lock to the reference cavity.

- The temperature of the reference cavity was changed by approximately 30 degrees Celsius by changing the set point of the temperature stabilization servo. For approximately an hour after the change of the set point, the frequency stabilization servo tracked the change in the reference cavity temperature and the PSL remained locked to the reference cavity.
- The pre-mode cleaner (PMC) remained locked to the laser while the laser was simultaneously locked to the reference cavity, during overnight operation.
- The PSL was operated with all four servocontrols running simultaneously: the frequency stabilization servo, the PMC servo, the intensity servo and the temperature stabilization servo.

On July 10, we completed a major NSF milestone, “Begin Interferometer Installation,” by beginning the installation of the Laser and Input Optics table. By the close of this quarter, the first PSL had been shipped to the Hanford site for installation.

2.6.4 Input Optics.

The Input Optics are being fabricated. All orders for commercial components have been placed. The first-needed, longest-lead item, the Large Telescope Mirror, which matches the beam into the 2-km interferometer, is polished and ready for shipment to Research Electro-Optics (REO) for coating. The machined parts for the fixed, in-vacuum, mirror holders have been received from the University of Florida and will be assembled to test for fit before shipping to Caltech for vacuum bake-out.

Mode matching sensor tabletop experiments progressed this quarter. After some adjustments, the magnitude of the TEM₂₀ mismatching signal can be clearly seen, and the detector tested and refined. We performed high-power testing of Input Optics and Pre-Stabilized Laser components.

The Input Optics group is mobilizing to Hanford for the installation of the Input Optics components. Installation of the those Input Optics components which are on the Pre-Stabilized Laser table, and suspension and testing of the mode cleaner and small telescope optics, are all planned for the near future at Hanford.

2.6.5 Core Optics Components.

Commonwealth Scientific & Industrial Research Organization (CSIRO) in Australia and General Optics (GO) in California continue to polish LIGO substrates, and the full complement of 2-km optics (and spares) had been polished by the close of the quarter. Research Electro-Optics (REO) has been pursuing an aggressive coating schedule and has delivered end test masses, folding mirrors, recycling mirrors, and beam splitters. Unfortunately, two of the four beam splitters were stained and streaked, apparently due to problems with cleaning procedures, which rendered them useless. They have been sent back to CSIRO for repolishing, which will be completed by mid-September. New quality-control measures (LIGO personnel will be present during preparation and coating) have been implemented. No delay in interferometer integration is anticipated.

Infrared interferometer. The Veeco Infrared interferometer was conditionally accepted at Veeco July 17th. It was then installed at Caltech and tested; however, multiple failures of a motor that spins a ground-glass disc and some optical performance problems required us to return the system

to Veeco; re-delivery and testing will occur in mid-September. Veeco has loaned us a 632 nm system for the interim.

Cleaning Procedures. A new lab at Caltech to develop and perform cleaning procedures was completed this quarter. As part of the development, trial procedures were performed on a three inch coated optic with magnet/standoff assemblies. This part was baked according to LIGO specifications after the magnets were coated with epoxy. Water did not wet the surface after baking, indicating some type of contamination. The surface then was cleaned following our procedure. The optic was tested for cleanliness by the vapor wetting test, where the cleaned part is placed at an angle, directly over steaming water. On a clean part, interference fringes are observed running uniformly throughout the part. This test is able to detect low surface energy contaminants such as hydrocarbons, and the results indicated that the cleaning had been successful.

2.6.6 Core Optics Support.

We performed the detailed design for the Core Optics Support this quarter. Some designs (external pick-off telescopes for the end test masses and sensing/control ports) were finished and provided to the Interferometer Sensing/Control group to be fabricated or procured. Three full-size wooden mock-ups of the pick-off telescopes have been built and are positioned in a simulated Horizontal Access Module (HAM-10) configuration to check the layout. The mock-ups have also provided useful information concerning some features of the height and tilt adjustment mechanism which will be redesigned. A prototype of the beam dump and mounting structure, as used in the Beam Splitter Chamber (BSC-7 and 8) configuration, is nearing completion.

A number of components are in production. At the close of the quarter, three bid responses were being evaluated for the in-vacuum telescope, the central element of the Core Optics Support system.

Figure 7 on page 11 is a sample baffle design for one of the near test masses. The two large holes are for the 2-km and 4-km principle beams. The smaller holes are for the pointing beams. Figure 8 on page 12 is a perspective view showing the pointing beams entering and exiting from viewports mounted in a beam reducing manifold.

2.6.7 Seismic Isolation.

We performed an early first-article test of the seismic isolation “stack” for the HAM chamber this quarter. This program, which involved a significant mobilization of detector manpower to the Hanford Observatory, as well as the staff at Hanford, fulfilled a number of important functions:

- The assembly procedure and fixtures were exercised. A number of alternative approaches were developed which will be adopted for the series installation to start next quarter.
- A complete fit check of the internal and external hardware was performed, again with improvements and refinements to the manufactured design.
- A dynamic characterization was performed of the transfer function of the isolation system and of its drift with time; this led to the timely identification of the need for a balanced spring configuration.

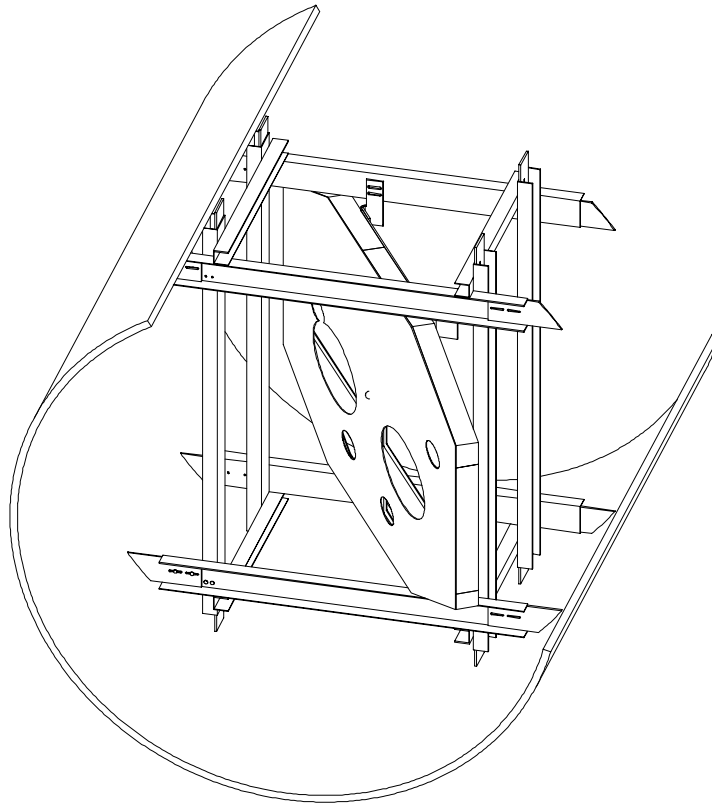

FIGURE 7. Sample Baffle Design for Near Test Mass.

- Our ability to plan and manage Detector installation had a significant and largely successful trial. Lessons learned have been incorporated into the remainder of the detector installation plan.

Figure 9 on page 13 is a photograph of the completed Horizontal Access Module (HAM) first article Seismic Isolation System. The cylindrical objects on the top optics table are counter-weights to supply the static load anticipated for the complete system. The larger cylinders beneath the top optics table are the isolation masses separated by internally damped springs.

There is a parallel effort to build a first article of the Beam Splitter Chamber (BSC) isolation system at the Hytec Los Alamos lab, providing valuable experience for the Hytec team and participating LIGO staff. Based on these experiences, the resulting modifications, and the successful Final Design Review held this quarter, we are proceeding with the fabrication and installation of the seismic isolation system. Some of the highlights of the parallel test and fabrication status are:

- Authorization was given to Senior Flexonics (bellows manufacturer) and Pegasus (coil spring manufacturer) to procure materials with long lead times in preparation for full production. Pegasus is developing a set of left-handed springs to complement the existing right-handed springs to minimize rotational drift associated with the initial settling of the assembled stack.



FIGURE 8. Perspective View of the Beams. The pointing beams are shown entering and exiting from viewports mounted in a beam reducing manifold.

- Hytec has completed dynamic testing of all delivered coil springs, to be followed by fatigue testing.
- Hytec received all mechanical components for the first four fine actuators and has completely assembled and checked one, including the Piezo-electric Transducer (PZT) drive. Everything is working as expected.
- The scissors table testing is nearing completion. Tests of both aluminum and stainless steel tables, with various finish and bearing surfaces, were performed at Hytec. A stainless steel design has been selected.
- Two of the four air bearings have been positioned on the coarse actuation assembly and assembled on the piers. The bearings have been tested for fit and appear to be functioning as expected. The pneumatic components have arrived at Hytec and are being integrated into the electronics/pneumatic cabinet and onto the Beam Splitter Chamber (BSC) components. Hytec has completed the assembly of the air power system to supply the air bearings.

Coarse Actuation System. We are testing a prototype multiplexer for the coarse actuation system to demonstrate the feasibility of using one set of electronics to drive up to four actuators with potentially significant cost reductions. An alternative manual actuation system has been adopted for the Horizontal Access Module (HAM) leveling system, also with significant cost savings.



FIGURE 9. Horizontal Access Module (HAM) First Article Seismic Isolation System

This modification does not appear to limit the normal operations of the interferometer and allows a later retrofit of the remote adjustment.

2.6.8 Suspensions

The Suspensions subsystem is in fabrication. The Small Optics Suspensions have been provided to the Input Optics group and are largely finished. The first article for the structure of the Large Optics Suspension was received and inspected this quarter. A number of small discrepancies were noted and are being reworked by the fabrication vendor. Two hundred forty-five of the required 252 sensor/actuator heads were received from the vendor (Progressive). These have been sent to American Thin Film for molybdenum coating, which gives them a slight conductivity to reduce static charge buildup.

2.6.9 System Integration.

As noted above, the Seismic First Article tests provided an opportunity to test our ability to assemble a mixed team of experienced and inexperienced people to execute a complex installation and test procedure. In all, the effort was a success, with some general lessons learned in addition to a wealth of specific technical points. The second System Preliminary Design Review, to be

held early next quarter, will be used to communicate the strategy as modified by this experience to the entire Detector team.

Global Diagnostics System. The Global Diagnostics System (GDS) provides diagnostic access to interferometer test points both for observing and for applying small perturbations. We made significant progress this quarter coding and testing real-time interfaces to the GDS subsystems and to the LIGO Data Acquisition System (LDAS). The GDS arbitrary wave form generator was tested in the Phase Noise Interferometer. During this test, diagnostics and the length control VME (Versa Modular Eurocard--IEEE 1014) crates were synchronized via a reflective memory interrupt and a shared memory structure, as is planned for LIGO. Attempts to read the digital servo loop parameters and data as well as excite the interferometer to perform transfer function measurements were successful.

The EPICS (Experimental Physics and Industrial Control System) controller software for one of the general-purpose signal generators is complete (although there are some remaining timing glitches in the RS232 communications interface).

Timing received attention; we installed the NTP (network time protocol) services on the main LIGO Hanford Observatory servers, making it possible to complete the testing of the VME GPS (Global Positioning Satellite) slave module driver (GPS time is used to synchronize events within and between the LIGO sites.)

2.6.10 Physics Environment Monitoring (PEM) System

The hardware for the Physics Environmental Monitor is largely in-house, and some parts are now installed. The portable acquisition carts and samples of the mechanical sensors and actuators were on-site at Hanford to help support the Horizontal Access Module (HAM) Seismic Isolation first article test. The shakers and accelerometers worked very well. There were lessons learned (and bugs found in vendor software) about the data acquisition system, and those issues are being addressed. Installation is starting for the weather monitors and residual gas analyzers. The remaining final designs for the magnetic excitation system (being provided by the University of Oregon), and for the cosmic muon detector, are proceeding.

2.6.11 Control and Data System (CDS).

Infrastructure installation at the two sites is progressing. At Hanford, high-speed networking to the external world is in place, and the local area network is in use for scientific computing and, for example, monitoring the facilities environmental control. Individual subsystem installations are starting; the suspension controller test stand (to be first used during setup of the Input Optics suspensions) is installed, as are the wired control racks for the Input Optics in the main Vacuum Equipment Area. All Control and Data Systems (CDS) racks are mounted and ready for wiring and module installation. Initial data acquisition software integration is complete, and the test system is now running. In Louisiana, we are testing the vacuum controls, and the fiber optics networking specification has been released for quote.

The electronics hardware and software for the detector subsystems are either in the final stages of design or in fabrication, and many of the successes of the prototype and first articles discussed above involve the use of modules produced by the CDS group and the close participation of CDS

staff. The assembly of the Pre-Stabilized Laser and the Small Optics Suspension controllers are examples of systems which are now complete, with first article tests finished, and fabrication underway for the 2-km Hanford and later interferometers.

Final design of the Interferometer Sensing/Control systems is ongoing, in close collaboration with the scientific staff.

2.7 Systems Engineering

2.7.1 Systems Integration

Reliability Analysis. The Control and Data System (CDS) Control and Monitoring Systems Reliability Prediction Report addresses the contribution of individual subsystems to the top level LIGO availability. The CDS Control and Monitoring Systems Prediction was revised to reflect the Final Design Documentation.

Cable Tray Bid Package. The bid package for installation of the Hanford instrumentation cable trays was released and a contract awarded.

2.7.2 Simulation, Modeling and Data Analysis

LIGO Data Analysis System (LDAS) Conceptual Design Verification. Prototype software was implemented to verify the LIGO Data Analysis System (LDAS) conceptual design. The distributed computing environment for the LDAS prototype uses TCL/TK for command parsing, event logging, exception handling, hypertext help, multiple event loops, and first-in-first-out (FIFO) command queuing. TCL/TK language extensions may be written in C and C++.

A prototype C++ class library was developed for interprocess communications, based on a commercial package developed by ObjectSpace, which supports distributed object communications through UNIX TCP/IP sockets. All or part of the functionality of the software can be uploaded from a central algorithm server via sockets, providing automatic updates and version control in remote processes.

“Metadata” Structure Definition. We have begun to identify the types of data LIGO will generate that need to be indexed as “metadata.” These include reduced data sets (running time averages and other filtered and decimated data subsets) and event catalogs (as data are processed, events will be generated that will be indexed and saved independently of the raw data sets). The result is a preliminary specification of major LIGO metadata elements: FrameDataSets, EventSets, and DataObjects. The sorting, querying and indexing methods for accessing LIGO data are also being identified.

We have selected XML as a LIGO “lightweight” data format to be used by applications that do not require the full capability of framed data. XML is a widely used data format which allows easy translation for web-based browsing, and provides many existing viewing and processing tools. We have identified requirements for distributed data, essential because of the multiple locations and data access times involved in metadata filtering.

Database Archival and Retrieval Prototype. The Beam Tube vacuum bake database server has been used to prototype database archival and retrieval processes. The Beam Tube vacuum bake underway at Hanford is generating data from various monitoring instruments including temperature probes, a gas analyzer, ambient condition monitors, and operator logs. The LIGO Data Analysis System (LDAS) is providing internet access to 663 temperature channels for all interested LIGO personnel. Temperatures are measured each minute. By specifying a collection of channels and start and end times, the user can download a table of data. This service can be accessed through the URL: <http://www.cacr.caltech.edu/~roy/ligo/bakeout.html>.

Operator Logs. We have evaluated and installed a web-based system for recording operator logs developed at Fermilab. The “Elog” system, written in Perl, allows comments and images to be placed into a digital log based on operator shifts. Contributions are only accepted from specific client machines, and the log may be viewed only from a specified internet domain. LDAS will enhance the system with a priority scheme for log entries and a collection of LIGO-specific forms.

LIGO/VIRGO Frame Format Class Library Implementation. An object oriented C++ LIGO/VIRGO Frame Format class library (FCL) has been implemented based on the common data format specification developed jointly by LIGO and VIRGO (French-Italian Laser Interferometer Collaboration) and accepted by GEO (British-German Cooperation for Gravity Wave Experiment) and TAMA (Japanese Interferometric Gravitational-Wave Detector Project). User documentation was prepared and released. Frame objects have been passed between extended TCL/TK interpreters using the C++ socket class library described above. FCL files can also be easily imported into ROOT, a powerful visual data analysis environment developed at CERN (Conseil Européen pour la Recherche Nucléaire).

Parallel Processing. Performance studies were completed for Message Passing Interface (MPI) based, clustered (BEOWULF) computers for use for LDAS. Benchmarks indicate that current processor performance is in the range needed to perform binary inspiral and ringdown template searches on an on-line BEOWULF server composed of 30 to 40 nodes per interferometer with presently available computer technology and using the UNIX operating system and ANSI computer languages.

2.7.3 LIGO Computing Infrastructure

Networking hardware was installed at both observatories. Preliminary testing for connectivity and performance has been accomplished. A T1 (T1 is a telecommunications standard, 1.54 Mbps) network connection for the Livingston Observatory was provided through Louisiana State University. A very high-speed Backbone Network Service (vBNS) or similar connection at that site is being discussed. A T1 network connection for the Hanford Observatory has been established through ESnet via Pacific Northwest National Laboratory (PNNL/Battelle). A Memorandum of Understanding (MOU) between the DOE and the NSF is in process.

General computing servers have been installed at both Hanford and Livingston, and the general computing and data acquisition networks are working together.

2.8 Quality Assurance (QA) and Safety

Large Gate Valve. The manufacture, assembly, inspection, and test of the LIGO 44 and 48 inch electric, and 44 inch pneumatic gate valves was completed at GNB Corporation in Hayward, California. All valves have now been shipped to the LIGO sites. Currently, the twenty valves installed at the Hanford Site are in the process of post installation inspection and modification, repair, and final acceptance testing.

LIGO provided Quality Assurance (QA) oversight and assistance at both the GNB facility and the Hanford Site. During fabrication at GNB, LIGO QA provided GNB guidance in developing and implementing assembly, inspection, and test procedures for the LIGO gate valves. As a condition of shipment, the LIGO QA Group verified the particulate cleanliness of the valves after final assembly bake out and witnessed final helium mass spectrometer leak testing of the valves.

Gate valve bellows leakage was discovered at the Hanford Site on some of the valves undergoing vacuum system final acceptance testing. It was determined that because of a design error the carriage assembly can move beyond the intended range when the valves are opened and exceed design limits for compression of the bellows. The actuator/bellows to carriage/gate connection had been changed after the first two valves had been manufactured. The new configuration allowed the 44 inch valves to compress the actuator bellows 0.6 to 0.8 inches beyond design limits. Under these conditions some gate valve bellows were crushed and developed leaks. The correction required disassembly of each valve for bellows inspection and leak testing. Damaged components were replaced. The actuator/bonnet to carriage/connector interface dimension was also checked and verified to be compliant with the correct configuration requirement. Additionally, hard stops were to be installed in the valves to prevent the possibility of excessive carriage travel. GNB personnel, with Process Systems International (PSI) and Apollo site support, are implementing these actions. LIGO QA is assisting in the inspections and verifications.

Other inspections, repairs and tests are also being performed while the valves are disassembled. The additional valve work being performed includes:

- The gate seal O-ring groove is being inspected to assure adequate retention. To date, it has been necessary to replace three gates that did not satisfy design or workmanship requirements.
- Damaged O-rings are being replaced, and O-ring size is monitored to assure the tightest possible fit. O-ring damage was caused by several factors: 1) sticking of the gate seal O-ring to the valve body during bake out in the closed position, 2) post bake cycling of the valve which in some cases pulled the O-ring out of the groove when the valve was opened, and 3) loose O-rings cut when the valve was closed.
- We are performing a demonstration test of a valve bake out with a “soft gate closure” configuration. The goal of this test is to eliminate the possibility of O-ring sticking during future valve or Beam Tube bake operations.
- Valve bearing drive assemblies that exhibit excessive free-play are being refurbished so that the valves will operate smoothly at lock over and opening.
- The ball screw/nut assemblies are being replaced on valves where their mating clearances are found to be discrepant causing the carriage to “strike” the body side walls during travel.

- We are performing five-cycle open/close tests on all valves. We subject the valves to an additional five-cycles off the closed position after the valves have been repaired/inspected and are in the final system configuration. The intent of this cycling is to make a final verification for smooth and quiet valve operation.
- All beam tube gate valves receive a 50-cycle open/close test to demonstrate additional operation reliability.

Process Systems International (PSI), the LIGO Vacuum Equipment contractor, has scheduled inspection, repair and testing of the 12 Louisiana Site gate valves during October and November, 1998. The Louisiana Right Arm mid-station valve is expected to require additional rework or repair due to damage incurred when the gate assembly was dropped. LIGO QA will continue to support the gate valve inspection, modification, repair, and test activity at the Louisiana Site.

Hanford Operations Procedure Review. LIGO QA assisted the LIGO Project Manager and the LIGO Project Safety Officer in planning, coordinating, and conducting the LIGO Hanford Operations Procedure Review. The LIGO Hanford Observatory staff is assuming responsibility for the buildings, beam tube enclosures, beam tubes, and vacuum equipment and must also assume responsibility for the safe and effective operations of these systems.

Since last year, the LIGO Hanford staff has been implementing the operational and technical framework necessary to assure safe operation, installation, and commissioning of the LIGO systems. With the transition from construction to operations in progress at the Hanford site, the LIGO safety committee recommended to the Project Manager that an audit/review of the Hanford site operational framework should be performed. A review committee was established consisting of three members with extensive and varied facility operations experience. Dr. Rich Orr, the chairperson for the LIGO Safety Review conducted in October 1996, was asked to chair this review committee. Two other review committee members were selected: Mr. C. Scislowicz, Manager of the Caltech Safety Office, and Mr. J. Harrell, recently retired Manager of the JPL Environmental Test and Fabrication Section. The committee was charged with providing advice and recommendations to the LIGO Project Manager with regard to the Hanford operational framework. The committee's charge included the identification of areas that are off to a good start, areas requiring additional attention, and areas that have been overlooked in establishing the framework for safe and effective operations. In addition, the committee was asked to review and comment on several questions considered to be particularly important:

- Is there clear authority for safety and operations at the Hanford Observatory?
- Is there an adequate documented basis for safety policy and procedures at Hanford?
- Does the management of the Observatory take ownership of safety and operational efficiency? Is this clearly communicated to the staff?
- Are procedures in place, in either interim or final form, to define how the major hazardous operations are to be carried out?

In addition, the committee was provided with copies of representative operational procedures and check lists for review and information. They were asked to comment on whether these procedures are clear and effective, whether they need to be better formulated, and whether they are burdensome and an over-prescription that reduces operational effectiveness while providing only marginal benefit.

The two day review included informal presentations by the managers responsible for site operations. The presentations provided an overview and description of a particular operation and insight into the safety and operational planning that was incorporated in the applicable operational procedures or checklists. The site personnel safety training certification and the plans for beam tube bake were also covered. The committee toured various site labs and related facilities, inspected the Y2 Module beam tube vacuum bake installation, and performed a simulated walk-through of several procedures.

The review committee's report indicated that they were satisfied with the state of the Hanford site operational/safety plans and procedures. The site management has established an appropriate safety program with clear lines of authority and responsibility. The site management has in place the necessary tools, training and documentation for establishing and maintaining safe and repeatable operations. The review committee also included in their report specific Findings and Recommendations for improvements and corrective actions.

Chicago Bridge and Iron (CB&I) Beam Tube Completion Review 2 Conducted at Livingston, Louisiana Site. We conducted a successful audit of the Livingston, Louisiana Beam Tube as-built documentation at the end of June. This was performed in conjunction with the CB&I Completion Review, by the LIGO Document Control Center and Quality Assurance (QA) personnel, working with the CB&I Beam Tube QA Manager. The CB&I Beam Tube as-built documentation was found to be complete, readable, well organized and indexed. An sample data search was easily accomplished starting with the end item (assembled Beam Tube module) and traced back to the initial mill processing of the stainless steel coils. All in-process “defects” or manufacturing problems are included in the as-built records along with disposition and corrective action information. During this audit, it became clear that CB&I's method for cataloging and assembly of the as-built data could easily be described with a “flow-chart”. This flow chart was prepared and presented as part of the as-built documentation audit committee report and will be filed with the as-built documentation to expedite future reference use.

2.9 Meetings

The third meeting of the LIGO Science Collaboration (LSC) was held at JILA, University of Colorado, in Boulder, August 13-15, 1998. Each of the development groups presented introductory reports, which were followed by intensive working groups.

2.10 LIGO Visitors Program

Three short term visitors, Dr. Agnes Dominjon (Savoie), Dr. Raffaella Flaminio (Annecy) and Dr. Seiji Kawamura (National Astronomical Observatory, Tokyo) made significant contributions to the LIGO program this summer. Dr. Agnes Dominjon, an expert on lasers and optics, applied that expertise to the Scatterometer that LIGO is building to measure the scatter from LIGO core optics. Dr. Raffaella Flaminio, visiting from VIRGO (the French-Italian Laser Interferometer Collaboration), worked at the 40 meter facility where he assisted with the recycling experiment, offering insights into interferometer optical behavior and servo controls. Dr. Seiji Kawamura, an expert in suspension design, helped with the Resonant Sideband Extraction experiment. He also contributed to the interchange of results and designs with TAMA, the Japanese Interferometric Gravitational-Wave Detector Project.

Two long-term Visitors continued at LIGO. Professor Keith Riles, and other members of the University of Michigan group, have had a profound influence in making the 40 meter facility a productive research environment. The bulk of this effort supported the nearly completed recycling experiment and the demonstration of wave-front sensing control of the suspended mirrors. They are now preparing to take data in the fully recycled configuration. That data will be searched for evidence of periodic sources of gravitational radiation in a broad frequency band not accessible to existing bar detectors.

Dr. Janet Houser, visiting at MIT, concluded her LIGO assignment at the end of August and returned full time to the Smithsonian Astrophysical Observatory. Dr. Houser focused her talents on modeling possible gravitational-wave sources using a three dimensional numerical Smoothed Particle Hydrodynamics (SPH) code. Some of the astrophysical scenarios modeled include simulations of non-axisymmetric dynamical instabilities in rotating stars, the introduction of Relativity into time-dependent dynamics, and the computation of wave forms for binary coalescences.

3.0 Project Milestones

The status of the project milestones identified in the Project Management Plan (PMP) for the LIGO Facilities is summarized in Table 1.

LIGO has assumed “Beneficial Occupancy” of all buildings in Hanford. “Joint Occupancy” has been achieved for the Livingston site buildings.

The milestone “Accept Vacuum Equipment (WA)” was slipped four weeks during the summer of 1997 to reflect the expected late completion of the X-arm buildings at Hanford. The NSF milestone was not changed because it was anticipated that Process Systems International (PSI) would not require the entire four weeks to finish. An additional six weeks, delaying the milestone to July 1998, was due to a floor elevation change order. The floors in the Laser and Vacuum Equipment Area (LVEA) and Vacuum Equipment Area (VEA) at Hanford proved to be more than an inch too low. As a result the subcontractor, PSI, had to order new anchor bolts. Delivery required approximately nine weeks. During this time PSI was only able to work effectively in one building (Y-arm mid-station). More recently, inspection and rework of gate valves has delayed acceptance.

The milestone “Accept Vacuum Equipment (LA)” slipped to reflect the delays in Hanford. The two installations are serially linked because common subcontractor staffing is planned for accomplishing the work. However, the subcontractor is still targeting a Louisiana completion date of December 1998. The “Initiate Facility Shakedown” milestones are tied to the vacuum equipment acceptance milestones.

TABLE 1. Status of Significant Facility Milestones

Milestone Description	Project Management Plan Date ^a		Actual (A)/Projected (P) Completion Date	
	Washington	Louisiana	Washington	Louisiana
Initiate Site Development	03/94	08/95	03/94 (A)	06/95 (A)
Beam Tube Final Design Review	04/94		04/94 (A)	
Select A/E Contractor	11/94		11/94 (A)	
Complete Beam Tube Qualification Test	02/95		04/95 (A)	
Select Vacuum Equipment Contractor	03/95		07/95 (A)	
Complete Performance Measurement Baseline	04/95		04/95 (A)	
Initiate Beam Tube Fabrication	10/95		12/95(A)	
Initiate Slab Construction	10/95	01/97	02/96 (A)	01/97 (A)
Initiate Building Construction	06/96	01/97	07/96 (A)	01/97 (A)
Accept Tubes and Covers	03/98	03/99	03/98 (A)	10/98 (P)
Joint Occupancy	09/97	03/98	10/97 (A)	02/98 (A)
Beneficial Occupancy	03/98	09/98	03/98 (A)	09/98 (P)
Accept Vacuum Equipment	03/98	09/98	09/98 (P)	12/98 (P)
Initiate Facility Shakedown	03/98	03/99	09/98 (P)	12/98 (P)

a. Project Management Plan, Revision C, LIGO-M950001-C-M submitted to NSF in November 1997

Table 2 shows the actual and projected status of the significant Project Management Plan (PMP) milestones for the Detector. Every effort has been made to prioritize critical-path tasks as required to support Detector installation.

On July 10, we completed a major NSF milestone, “Begin Interferometer Installation,” by beginning the installation of the Laser and Input Optics table. The first Pre-stabilized Laser (PSL) has been shipped to the Hanford site for installation.

The Horizontal Access Module (HAM) Seismic Isolation Final Design Review (FDR) was held June 12, 1998. This review focused on the structural components with an update for the actuation system to be held at a future date. The Beam Splitter Chamber (BSC) Seismic Isolation FDR will be held in September 1998. The Detector System Preliminary Design Review (PDR) will be held at the end of September.

The Alignment Sensing and Control System FDR was held July 23, 1998. The Length Sensing and Control FDR was held July 29.

The projected completion date for the Core Optics Support FDR is now October 1998. Significant scope originally in this task has been moved to the suspension task (the FDR has been completed), and this deferred some “need” dates for the Core Optics Support. The delay leaves unaffected the target date for first operation of the LIGO interferometers. A better understanding of the requirements and design for the Core Optics Support has reduced the expected fabrication time, and all critical components are expected to be ready in time to avoid installation delays.

TABLE 2. Status of Significant Detector Milestones

Milestone Description	Project Management Plan Date		Actual (A)/Projected (P) Completion Date	
	Washington	Louisiana	Washington	Louisiana
BSC Stack Final Design Review	04/98		08/98 (A)	
Core Optics Support Final Design Review	02/98		10/98 (P)	
HAM Seismic Isolation Final Design Review	04/98		06/98 (A)	
Core Optics Components Final Design Review	12/97		05/98 (A)	
Detector System Preliminary Design Review	12/97		09/98 (P)	
I/O Optics Final Design Review	04/98		03/98 (A)	
Prestabilized Laser Final Design Review	08/98		10/98 (P)	
CDS Networking Systems Ready for Installation	04/98		03/98 (A)	
Alignment (Wavefront) Final Design Review	04/98		07/98 (A)	
CDS DAQ Final Design Review	04/98		05/98 (A)	
Length Sensing/Control Final Design Review	05/98		07/98 (A)	
Physics Environment Monitoring Final Design Review	06/98		10/97 (A)	
Initiate Interferometer Installation	07/98	01/99	07/98 (A)	01/99 (P)
Begin Coincidence Tests	12/00		12/00 (P)	

4.0 Financial Status

Table 3 on page 23 summarizes costs and commitments as of the end of August 1998. During the reporting period Caltech completed a thorough review of the open commitments data for subcontracts to assure that accurate data are available for managing the project during the remaining 12 percent of the construction effort.

5.0 Performance Status (Comparison to Project Baseline)

Figure 10 on page 24 is the Cost Schedule Status Report (CSSR) for the end of August 1998. The CSSR shows the time-phased budget to date, the earned value and the actual costs through the end of the month for the NSF reporting levels of the WBS. The schedule variance is equal to the difference between the budget-to-date and the earned value, and represents a “dollar” measure of the ahead (positive) or behind (negative) schedule position. The cost variance is equal to the difference between the earned value and the actual costs. In this case a negative result indicates an overrun. Figure 11 on page 25 shows the same information as a function of time for the top level LIGO Project.

TABLE 3. Costs and Commitments as of the end of August 1998

(all values are \$Thousands)

WBS	Costs Thru Nov 1997	First Quarter LFY 1998	Second Quarter LFY 1998	Jun-98	Jul-98	Aug-98	Cumulative Actual Costs	Open Commit- ments	Total Cost Plus Commitments
1.1.1 Vacuum Equipment	30,517	3,389	5,192	(11)	74	1,408	40,567	3,193	43,760
1.1.2 Beam Tube	32,978	5,703	5,565	205	178	1,038	45,667	1,425	47,092
1.1.3 Beam Tube Enclosure	13,274	1,987	1,648	1,054	1,184	(7)	19,139	302	19,441
1.1.4 Civil Construction	44,681	4,249	1,933	220	(947)	441	50,576	896	51,472
1.1.5 Beam Tube Bake	75	704	836	197	375	138	2,325	803	3,128
1.2 Detector	14,340	4,363	4,104	1,786	1,684	2,311	28,587	10,375	38,962
1.3 Research & Development	19,681	670	216	118	317	93	21,095	807	21,902
1.4 Project Management	22,649	1,459	1,424	53	535	369	26,491	1,672	28,162
7LIGO Unassigned	1	6	4	1	2	3	17	19	36
Installation and Commissioning	330	840	258	57	8	9	1,502	60	1,562
TOTAL	178,526	23,370	21,179	3,679	3,410	5,802	235,967	19,552	255,519
Cumulative Actual Costs	178,526	201,896	223,076	226,755	230,165	235,967			
Open Commitments	62,510	47,085	43,458	40,332	24,342	19,552			
Total Costs plus Commitments	241,036	248,981	266,534	267,087	254,507	255,519			
NSF Funding - Construction	\$ 208,468	\$ 265,089	\$ 291,948	\$ 291,948	\$ 291,948	\$ 291,948			
NSF Funding - Operations	\$ 300	\$ 300	\$ 7,600	\$ 7,600	\$ 7,600	\$ 7,600			

Note: "Unassigned" Costs have not been assigned to a specific LIGO Construction WBS but are continually reviewed to assure proper allocation.

LIGO Project
Cost Schedule Status Report (CSSR)
 Period End Date: 30 August 1998
 (All values are \$Thousands)

Reporting Level	Cumulative To Date					At Completion		
	Budgeted Cost of Work Scheduled (BCWS)	Budgeted Cost of Work Performed (BCWP)	Actual Cost of Work Performed (ACWP)	Schedule Variance (2-1)	Cost Variance (2-3)	Budget- at- Completion (BAC)	Estimate- at- Completion (EAC)	Variance- at- Completion (6-7)
Work Breakdown Structure	(1)	(2)	(3)	(4)	(5)	(6)	(7)	(8)
1.1.1 Vacuum Equipment	42,511	41,892	40,567	(619)	1,325	43,424	43,812	(388)
1.1.2 Beam Tubes	44,939	45,807	45,667	868	140	47,185	47,284	(99)
1.1.3 Beam Tube Enclosure	18,658	19,842	19,139	1,184	703	19,991	19,349	642
1.1.4 Facility Design & Construction	50,905	51,731	50,576	826	1,155	52,010	52,183	(173)
1.1.5 Beam Tube Bake	2,595	2,874	2,325	279	549	4,879	4,989	(110)
1.2 Detector	43,779	35,264	28,587	(8,515)	6,677	56,411	56,360	51
1.3 Research & Development	23,490	23,490	21,095	-	2,395	23,490	23,484	6
1.4 Project Office	26,920	26,920	26,488	-	432	33,760	34,296	(536)
Subtotal	253,797	247,820	234,444	(5,977)	13,376	281,150	281,757	(607)
Contingency						-	10,343	(10,343)
Management Reserve						10,950	-	10,950
Total	253,797	247,820	234,444	(5,977)	13,376	292,100	292,100	-

FIGURE 10. Cost Schedule Status Report (CSSR) for the End of August 1998

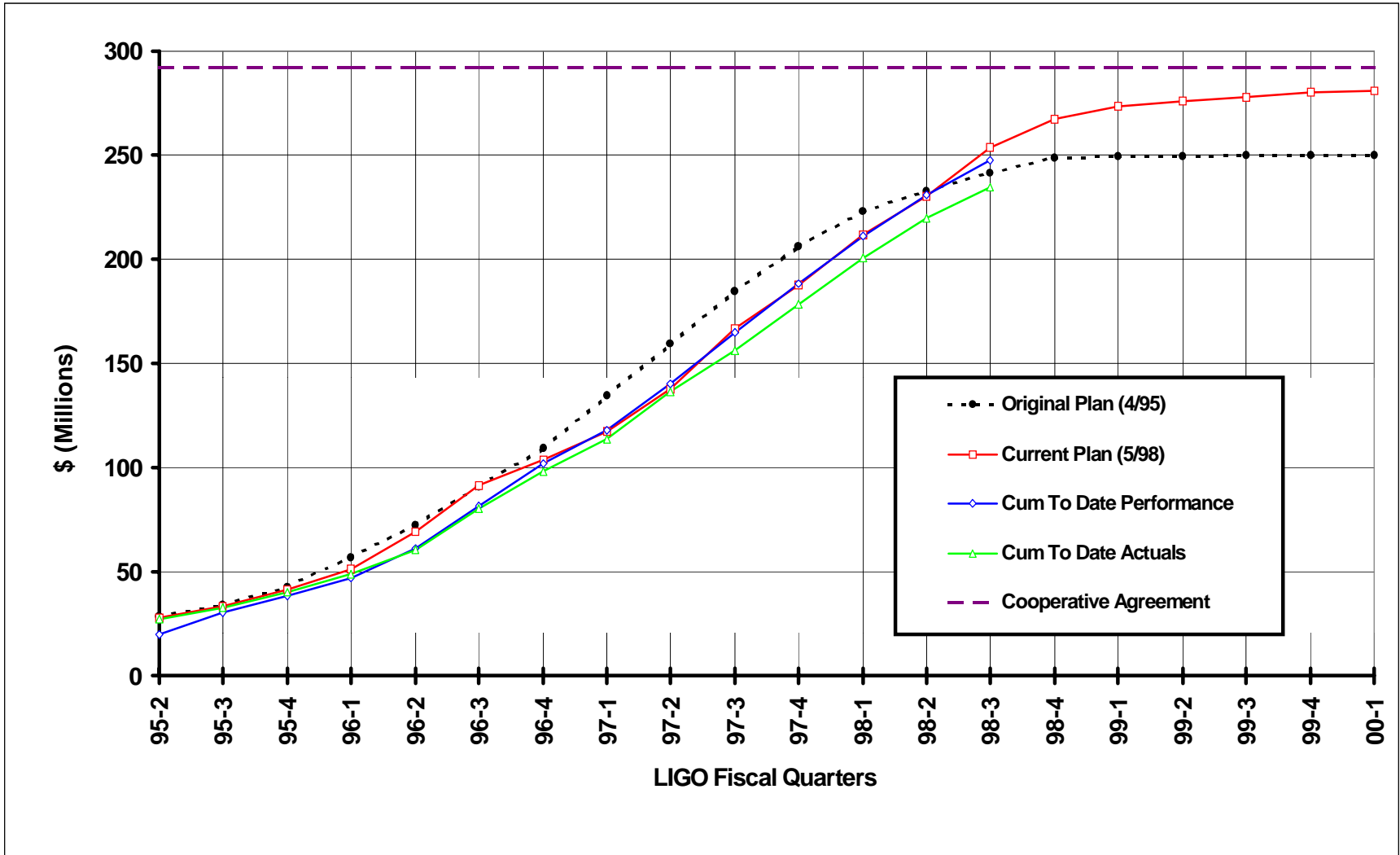

FIGURE 11. LIGO Construction Performance Summary as of the End of August 1998

5.1 Vacuum Equipment (WBS 1.1.1)

The unfavorable schedule variance is due to the GNB Corporation valve rework being behind schedule due to a shortage of replacement bellows. This has caused Process Systems International (PSI) to delay acceptance work in the X-arm stations in Hanford. PSI has been able to establish non-interfering priorities for the valve rework activities, and there has been no significant impact on other LIGO activities such as the Beam Tube Bake or Detector installation. Vacuum Equipment installation is on schedule in Livingston.

The favorable cost variance is due to the normal processing time for invoices.

5.2 Beam Tube (WBS 1.1.2)

All Beam Tube installation was completed ahead of schedule, and the Livingston, Louisiana X-arm acceptance test was completed during August. The estimate-at-completion reflects change requests that have not yet been finalized for submittal to the LIGO Change Control Board. These requests pertain to additional cleanliness tests, baffle cleaning, the purchase of vendor owned equipment used in the manufacture and installation of the Beam Tube and which will be useful during facility operations, and additional taxes.

5.3 Beam Tube Enclosures (WBS 1.1.3)

The contract for the Hanford site is complete with the exception of “punch list” items, and all enclosures have been installed in Livingston approximately three months ahead of schedule.

Possible state tax benefits are being negotiated with the subcontractors. These reductions have been reflected in the estimate-at-completion.

5.4 Civil Construction (WBS 1.1.4)

Civil Construction is ahead of schedule. The facilities in Hanford are complete. All completion issues for the closeout of the subcontract with Hensel-Phelps for the Livingston, Louisiana facilities were negotiated ahead of schedule at the end of June. “Punch List” items are being addressed.

5.5 Detector (WBS 1.2)

The Detector is behind schedule and under cost. Detector planning continues to emphasize the delivery of hardware to support installation of the first interferometer. Priorities have been adjusted to assure that critical milestones are met.

Laser and Optics. Core Optics Component fabrication is on schedule. The Pre-stabilized Laser prototype was shipped to Hanford, Washington in August. Input Optics fabrication is approximately one month behind schedule, but components will still be available to support installation.

Seismic Isolation. The Seismic Isolation effort is two to three months behind schedule. The procurement process has proved to be more time consuming than anticipated. Most production items

are now under contract. Production schedules are being managed to support initial interferometer installation.

Alignment Sensing and Control. The Alignment Sensing and Control (ASC) effort is behind schedule because resources have been shared to accomplish R&D tasks supporting interferometer development as well as the design of the input optics. The Initial Alignment System, needed first for installation, is on schedule.

Control and Data Systems. There are minor behind schedule positions reported for the controls for the Pre-stabilized Laser (one month), the Alignment Sensing and Control System (the Final Design Review was one month late), and the Length Sensing and Control System (the Final Design Review was two months late), but the group continues to support immediate needs.

5.6 Project Office (WBS 1.4)

The at-completion variance is for additional network and computer equipment at Caltech and at the sites. Change requests are being prepared.

6.0 Change Control and Contingency Analysis

Twenty-one change requests (see Table 4) were approved during this reporting period. These change requests allocated \$4.1 million from the contingency pool with corresponding additions to the budget baseline used for preparing the end-of-August 1998 reports. The current contingency pool is \$10.3 million (relative to the estimate-at-completion).

7.0 Staffing

The LIGO staff currently numbers 136 (full time equivalent). Of these, 38 are contract employees. Ninety-three LIGO staff are located at CIT including seven graduate students. Eighteen are located at MIT including five graduate students. Seventeen are now located at the Hanford, Washington site, and eight are assigned to Livingston, Louisiana.

TABLE 4. Change Requests Approved During the Third Quarter LIGO FY98

CR Number	WBS	Description	Amount
CR-980019	1.2.1	Core Optics Components, Develop and Qualify Cleaning Procedures	130,000
CR-980020	1.2.1	Detector - Additional Lasers and Laser Support	110,576
CR-980021	1.2.1	Detector - Laser/Optics Staffing	655,000
CR-980022	1.4.1.2	Project Controls - Revised ETC (5N502)	538,576
CR-980023	1.1.4	Civil Construction - Electrical Power for Hanford	130,000
CR-980025	1.1.3	Beam Tube Enclosure - Results of Negotiated Taxes for Livingston, LA (See CR-970020)	99,510
CR-980026	1.1.4	Civil Construction, Livingston, Hensel Phelps Closeout	481,366
CR-980027	1.2.2	CDS Staffing	500,000
CR-980028	1.2.1	Seismic Isolation and Suspension Staffing	235,000
CR-980029	1.1.4	Modification to Parking at Livingston	28,846
CR-980030	1.4.3.2	Document Control Center (DCC) Staffing (Schedule Delay)	68,315
CR-980031	1.1.2	Beam Tube Taxes, Clear Caps, FTIRs, Work Stoppages	75,306
CR-980032	1.1.2	Beam Tube - Purchase of Left Over Equipment	-
CR-980033	1.2	Detector Installation Travel for 1998	167,200
CR-980034	1.1.4	5000 Square Foot Building plus Mezzanine at Hanford (Revision to CR-980003)	224,000
CR-980035	1.1.4	Livingston Electrical Power Costs for FY 1999	221,500
CR-980036	1.1.4	Livingston Electrical Power Costs for FY 1998	100,000
CR-980037	1.1.4	Hanford Water System Integration	129,000
CR-980038	1.2.1	Core Optics Components, Beam Splitter Repolish	130,000
CR-980039	1.1.1	Miscellaneous Vacuum Equipment Charges	71,099
CR-980040	1.1.1	PSI Contract and Payment Milestone Modifications	37,079
Total			4,132,373

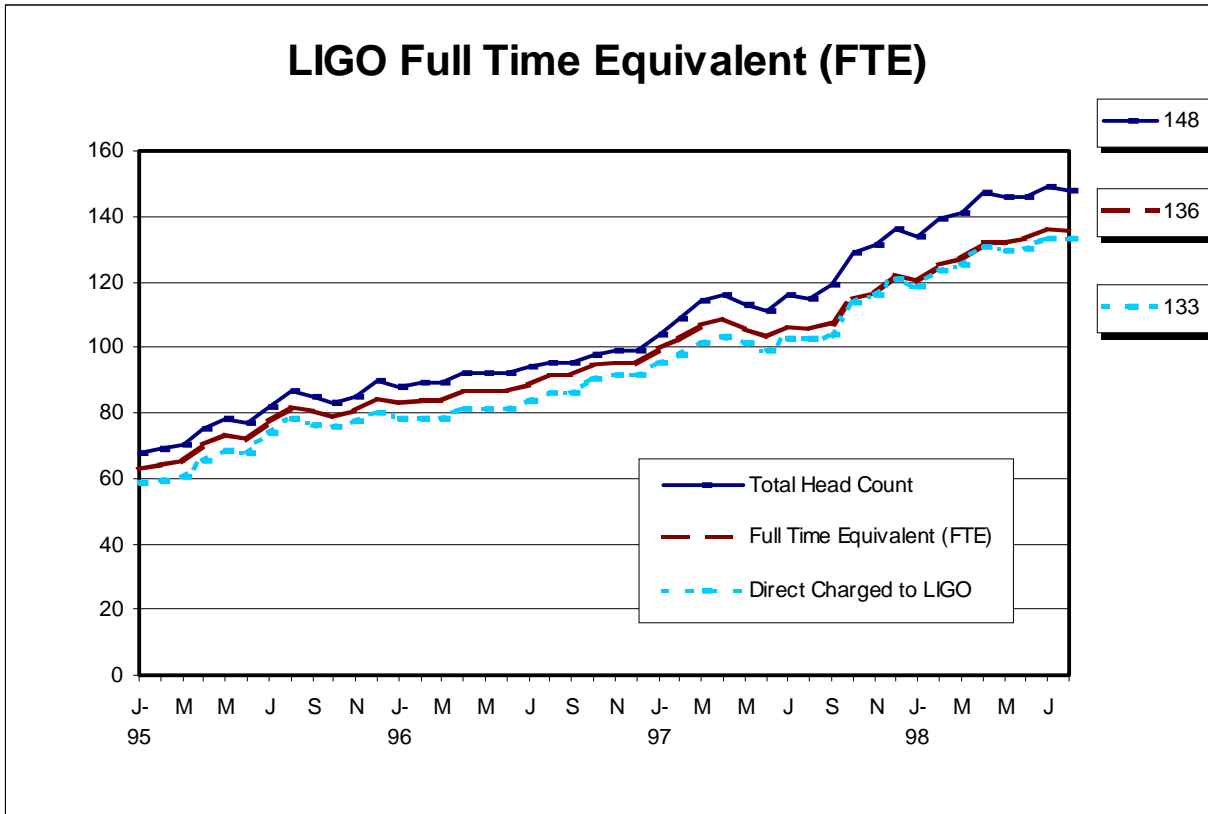

FIGURE 12. LIGO Staffing History