

Acoustic Detectors

M. Cerdonio

5 min

Auriga is alive and well. $T_{\text{eff}} = 2 \times 10^{-3} \text{ K}$ (lasting 2-3 days)

Optical transducer progressing

Ready to exchange data

W. O. Hamilton

5 min

G. Pizzella

15 min

D.G. Blair

10 min

W. Van Amerfoort

10 min

What studies might be of interest for advanced systems?

Common studies for data analysis?

Cosmic rays?

GWIC statement for acoustic detectors

- 1) Continuing bar network + upgrades
- 2) R & D for a spherical detector
- 3) Favor exchange of young scientists and sharing of technologies

Two Mode Prototype

First Measurements Q

	Alone	Coupled
Al res	13 E6	10 E6
Nb res	16 E6	15 E6

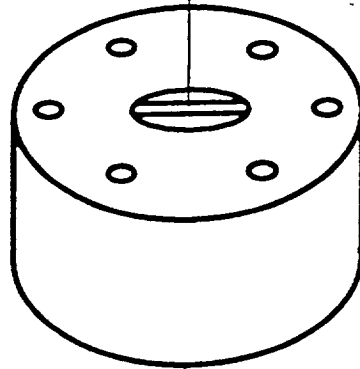

Coil Holder

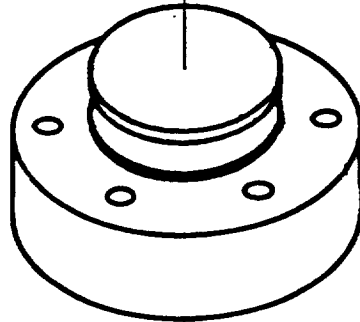

Niobium Resonator

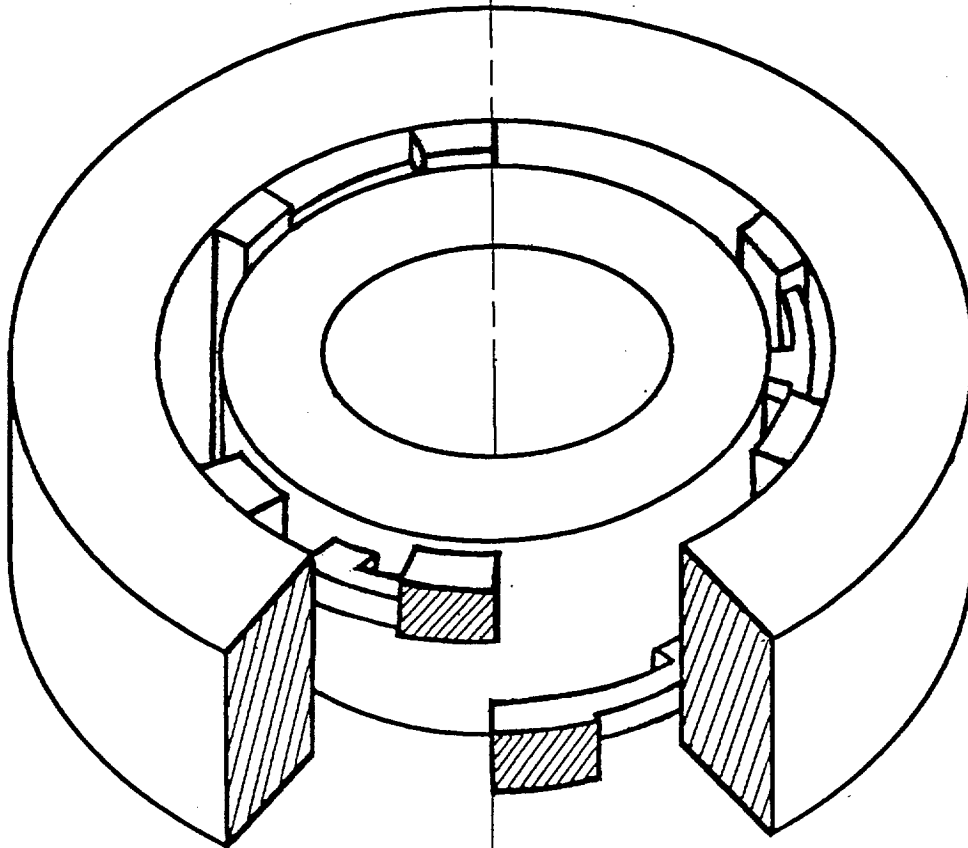

Aluminum Resonator

47 Tucannae

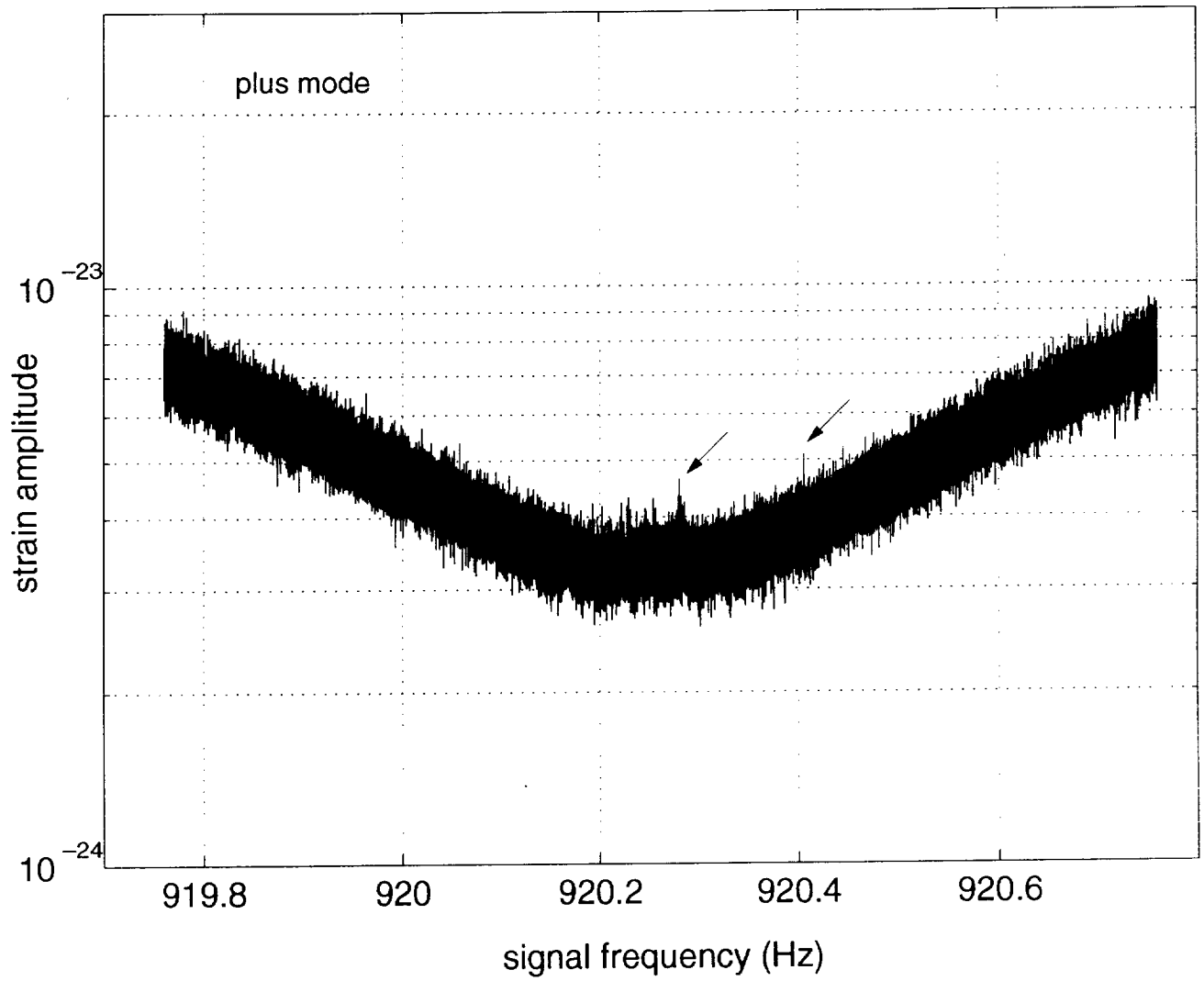

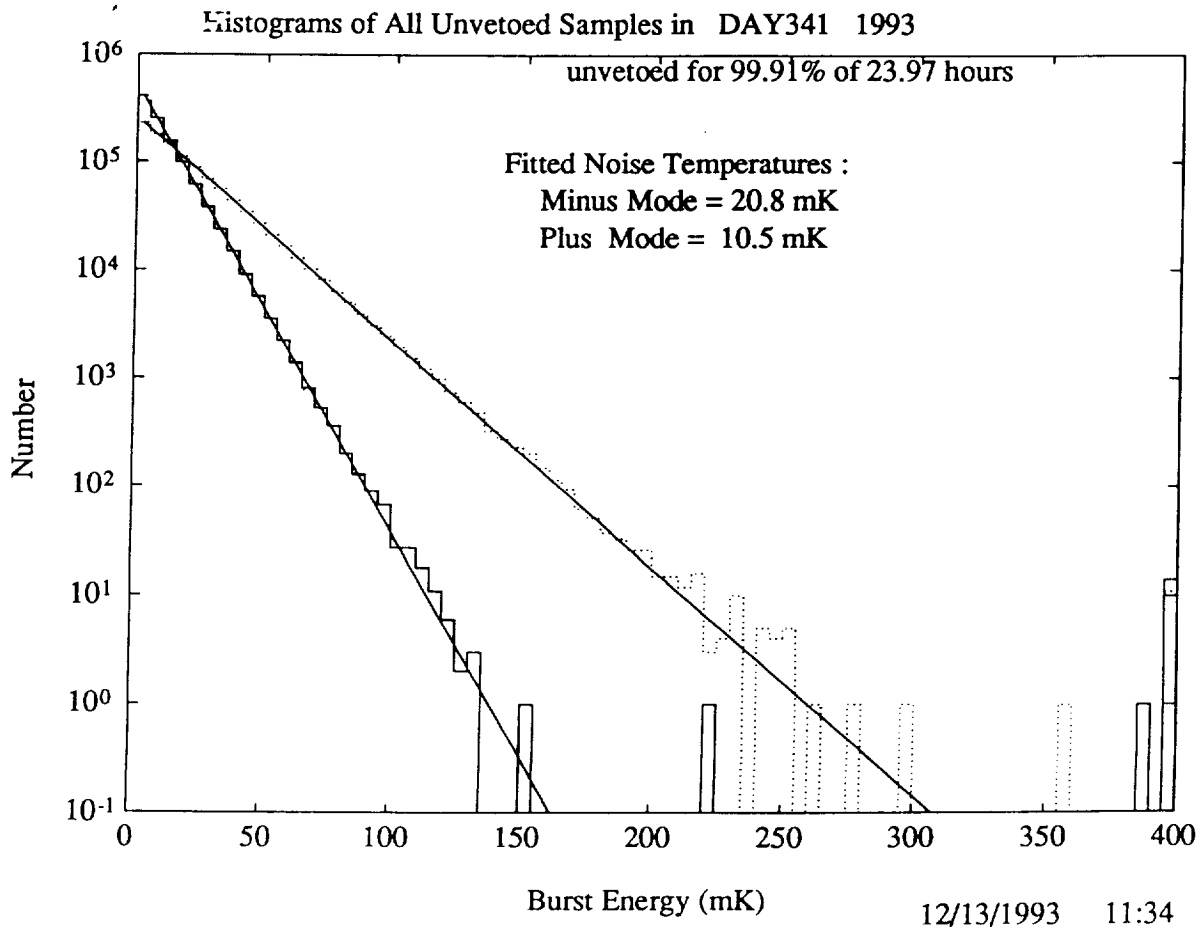
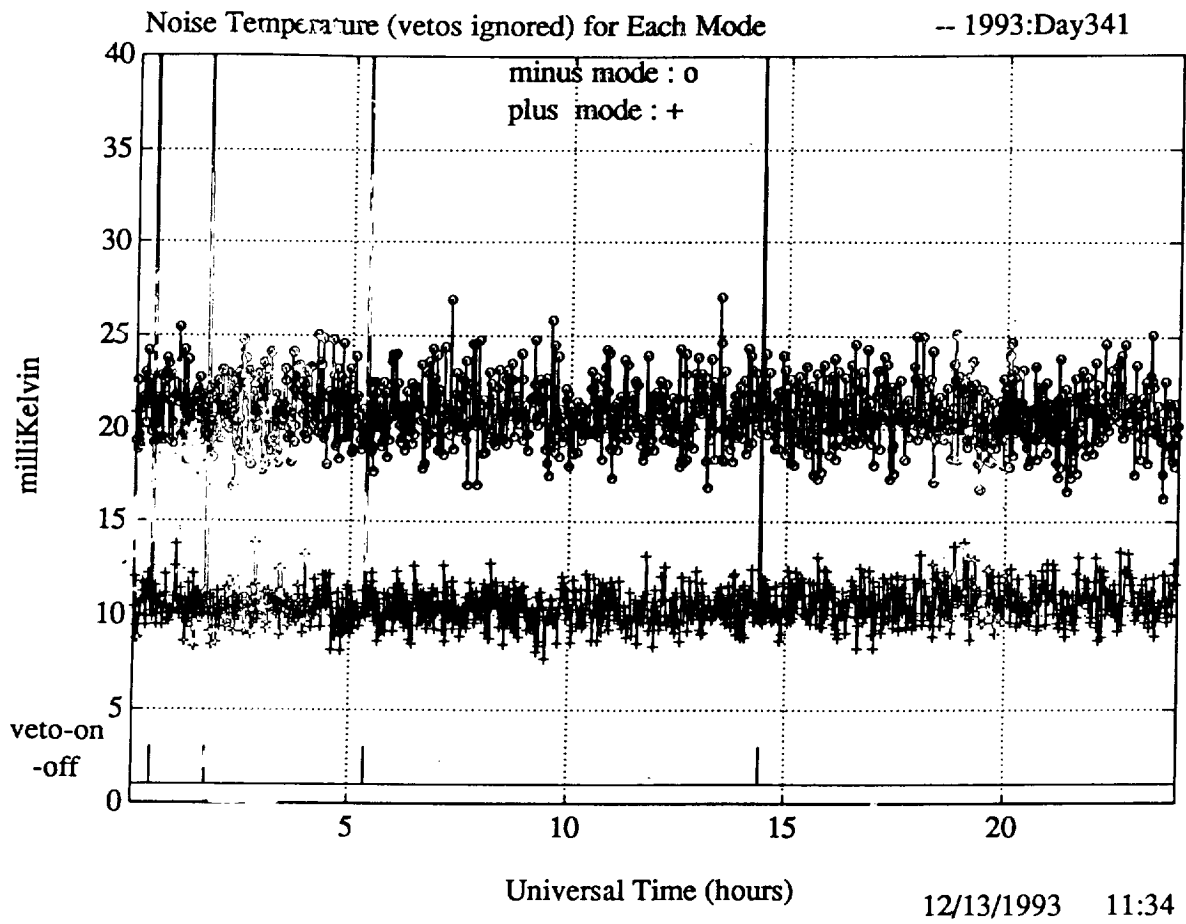

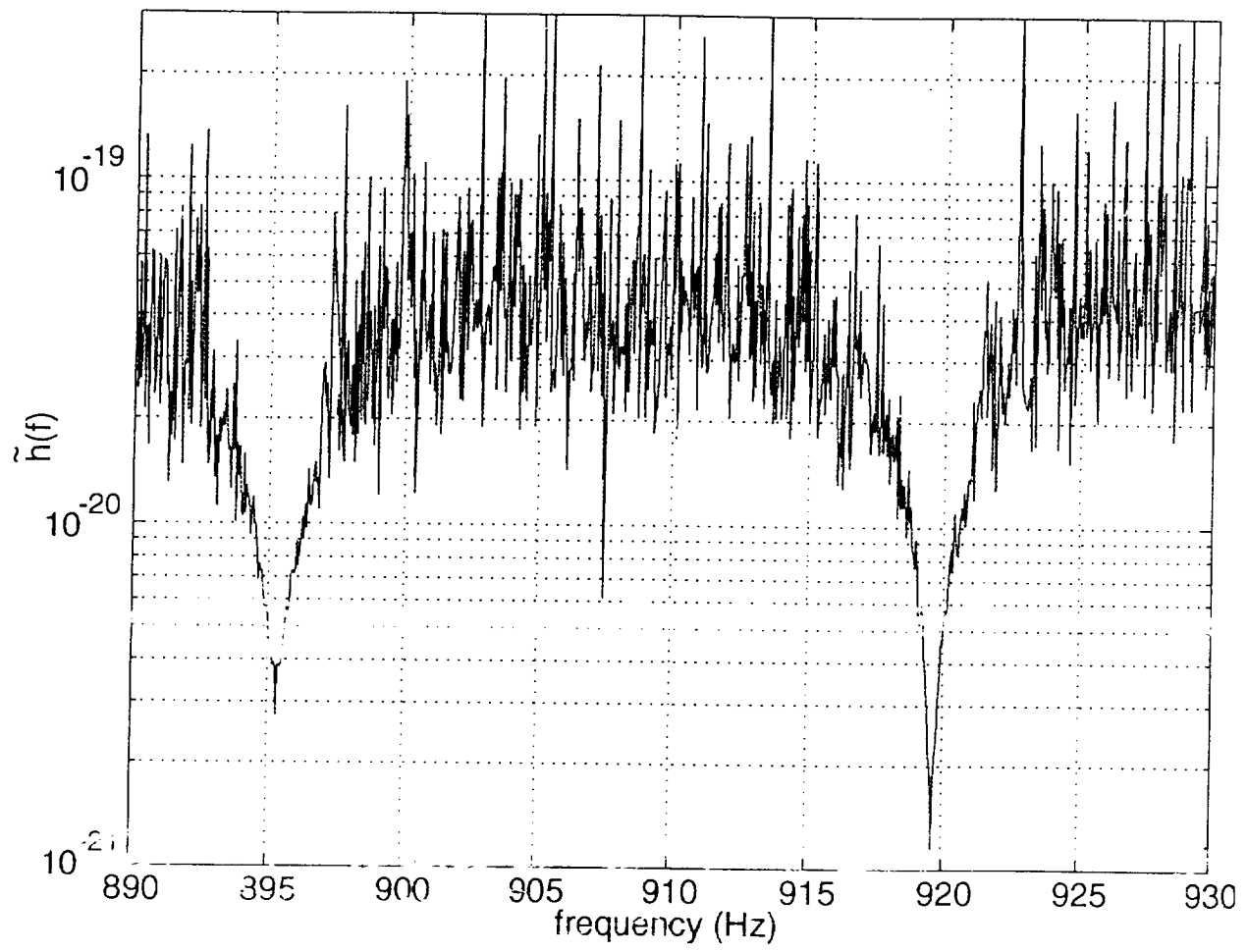

Note 1, Linda Turner, 04/30/98 10:47:58 AM
LIGO-G980073-08-M