The Detection of Gravitational Waves

LIGO

Barry Barish
Rice University
Nov 6, 1996



LIGO

Introduction

- Laser Interferometer Gravitational Wave Observatory
 - » **DIRECT** Detection of Gravitational Waves
- Joint Caltech/MIT Project funded by the National Science Foundation
- Under Construction
 - » Two Sites -- Louisiana and Washington



Gravitational vs E.M. Waves

	EM WAVES	GRAV. WAVES
Nature	Oscillation of EM Fields Propagating Through Spacetime	Oscillations of the "fabric" of spacetime
Emission Mechanism	Incoherent superposition of waves from molecules, atoms, particles	Coherent emission by bulk motion of energy
Interaction with Matter	Strong absorption and Scattering	Essentially None!
Frequency Band	$f > 10^7 \text{Hz}$	$f < 10^4 \text{Hz}$

■ Implications

- ◆ Most gravitational sources not seen as electromagnetic (and vice versa)
- ◆ Potential for great surprises
- ◆ Uncertainty in strengths of waves

Gravitational Wave *Forces*

IF

- Detector Size \ll Wavelength
(4 km) (300-30,000km)
(10 kHz - 10 Hz LIGO)

THEN

- Free Masses
- Quadrupolar Lines of Force

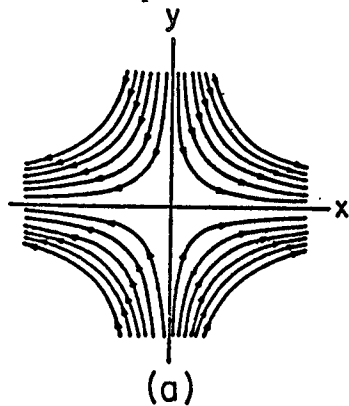

+ Polarization

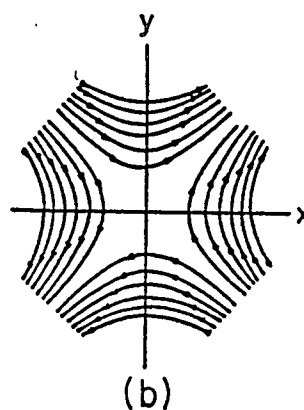

x Polarization

Gravitational Waves

Two Polarizations

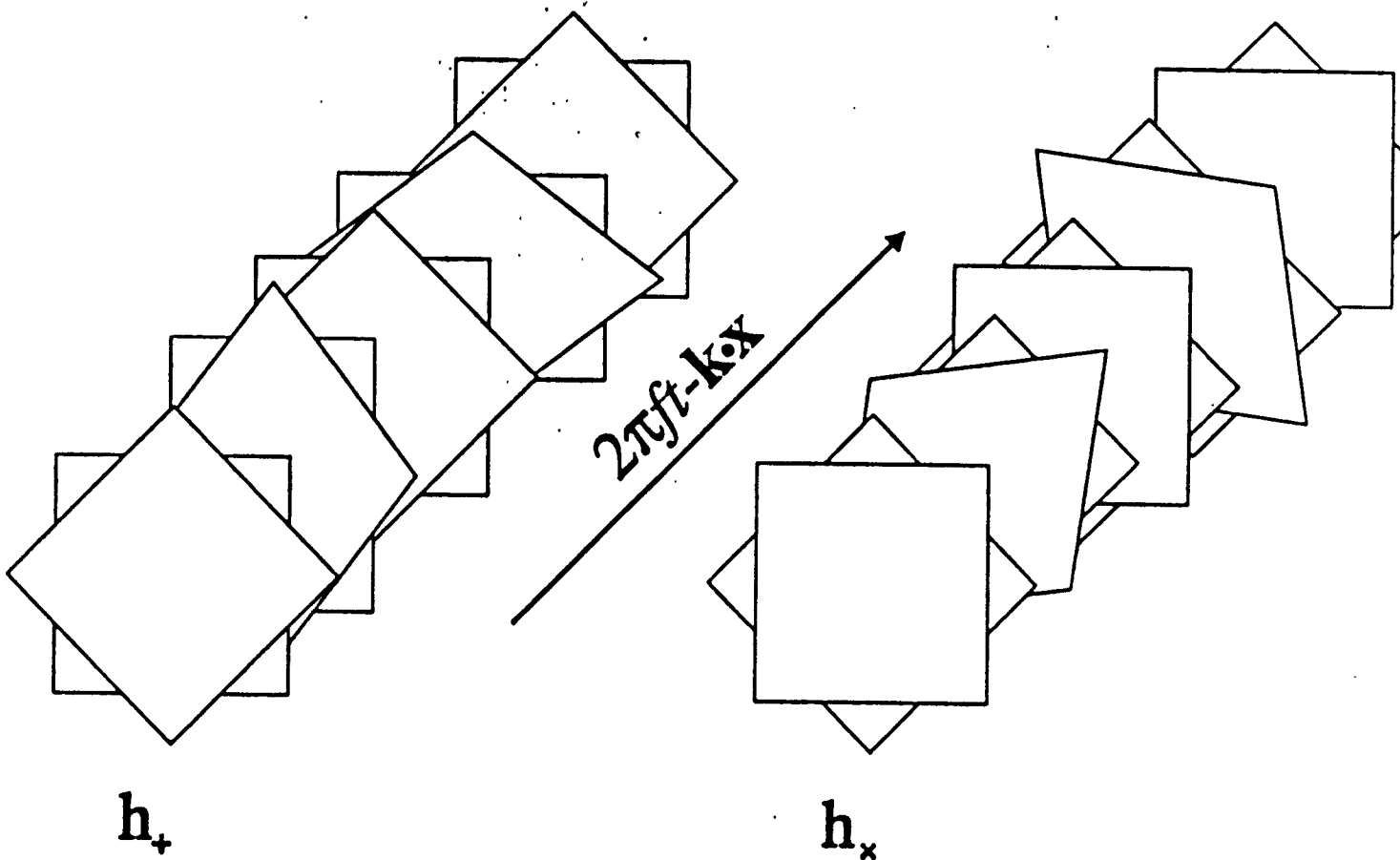

Gravitational Waves

Effects

- Displacement of free particles

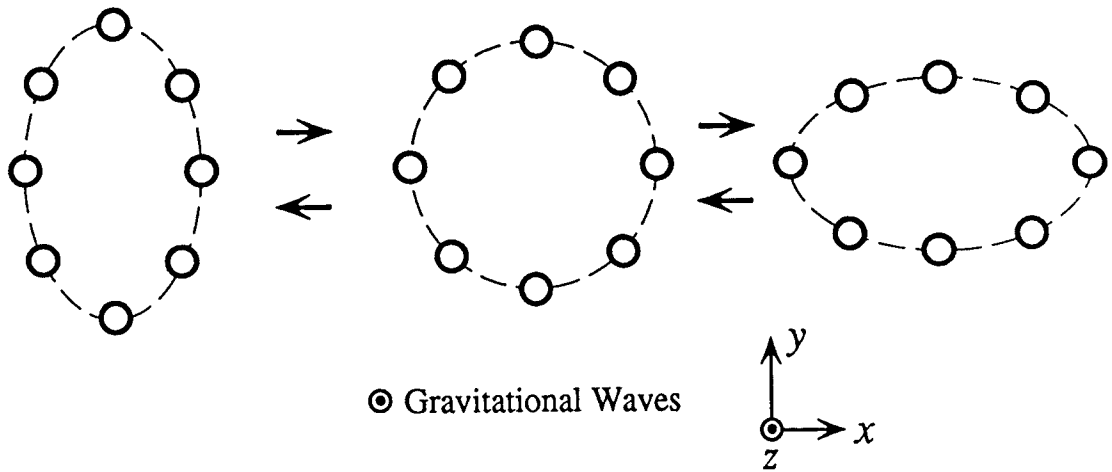

» h_+ polarization

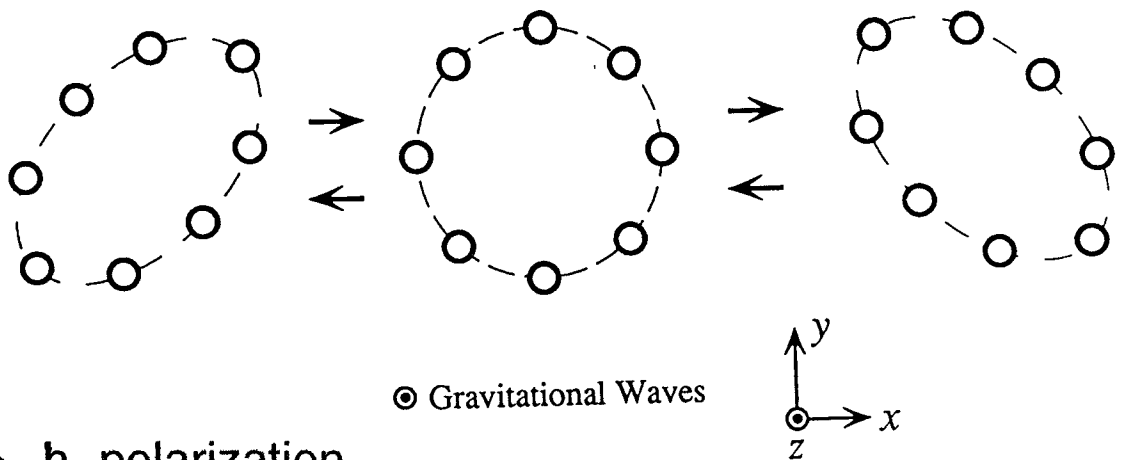

» h_x polarization

Gravitational Waves

Detection

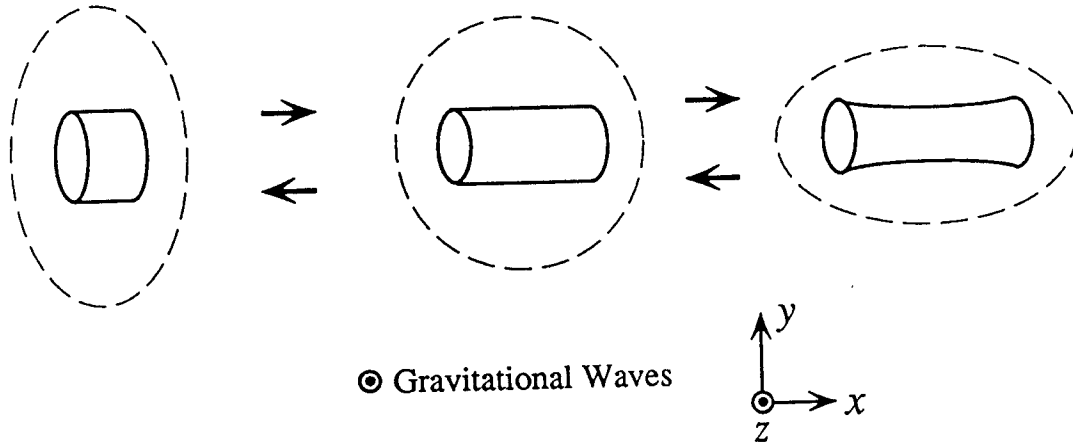

● Bar detector

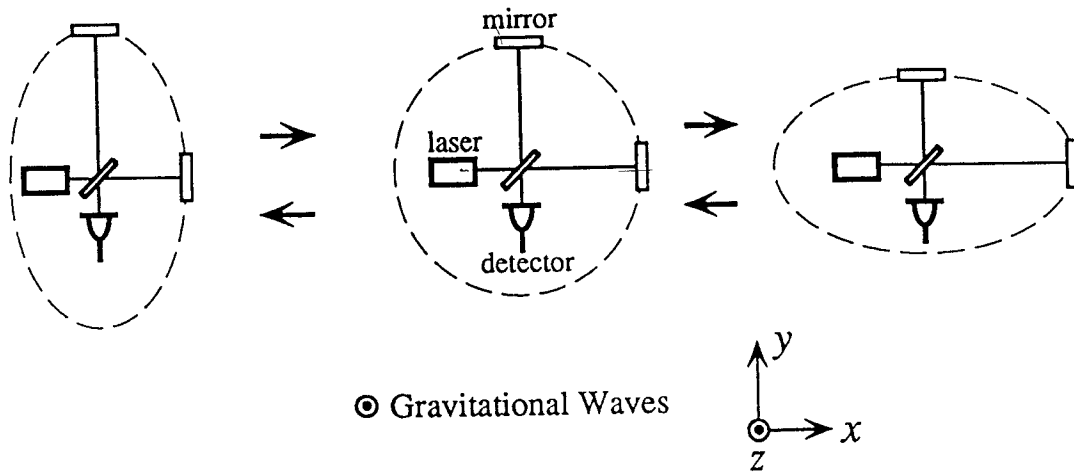

● Interferometer detector

Gravitational Waves

Evidence

- **Russell Hulse and Joseph Taylor**
- **Neutron Binary System**
 - » PSR 1913 + 16 -- Timing of Pulsars

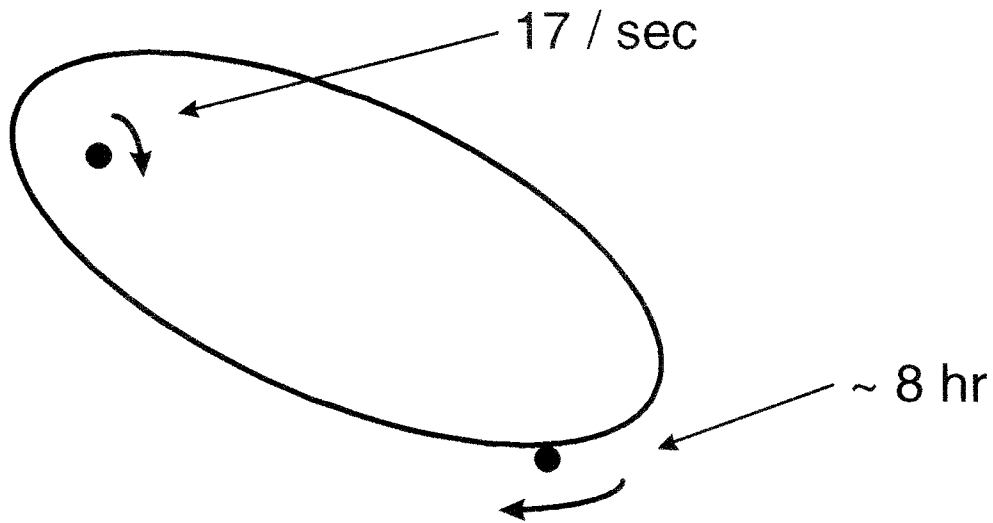

Hulse and Taylor

Timing of Orbit

- Speed up 10 sec in 15 years
 - » measured to $\sim 50 \mu\text{sec}$ accuracy
- Deviation grows quadratically in time

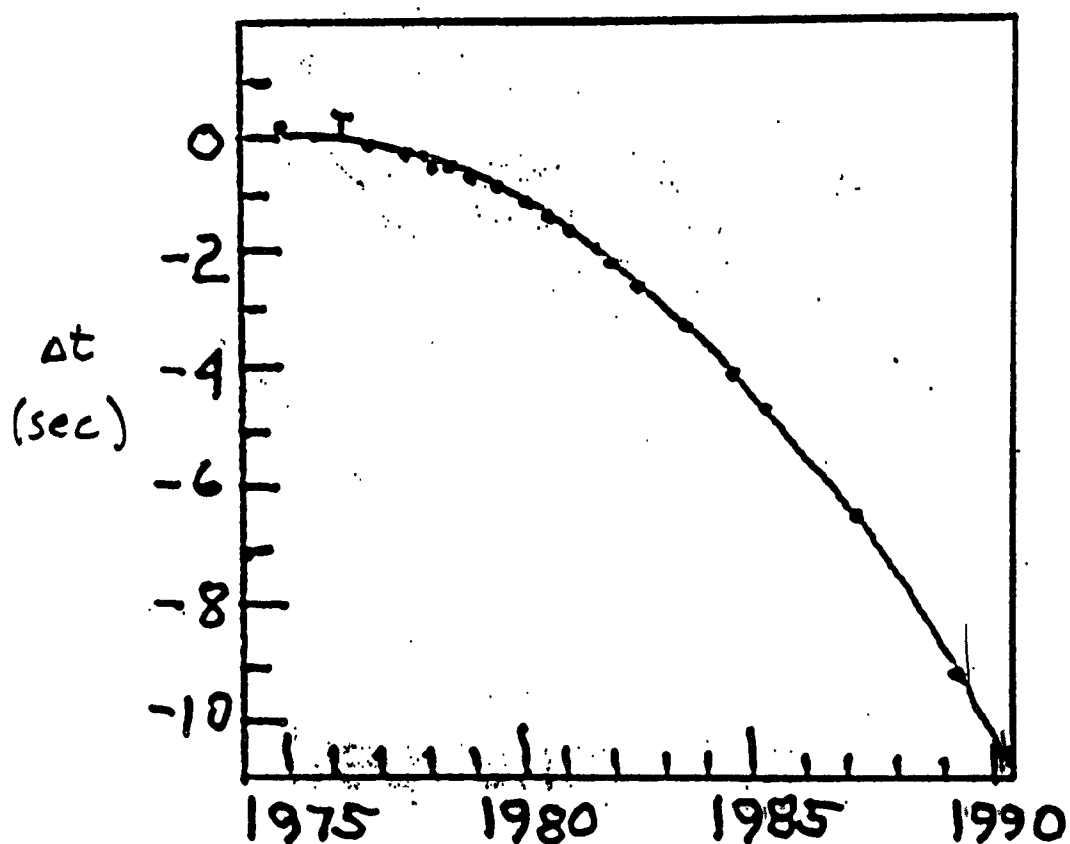

- Due to loss of orbital energy, from emission of gravitational waves

Laboratory Experiment (a la Hertz)

Laboratory Dumbbell System

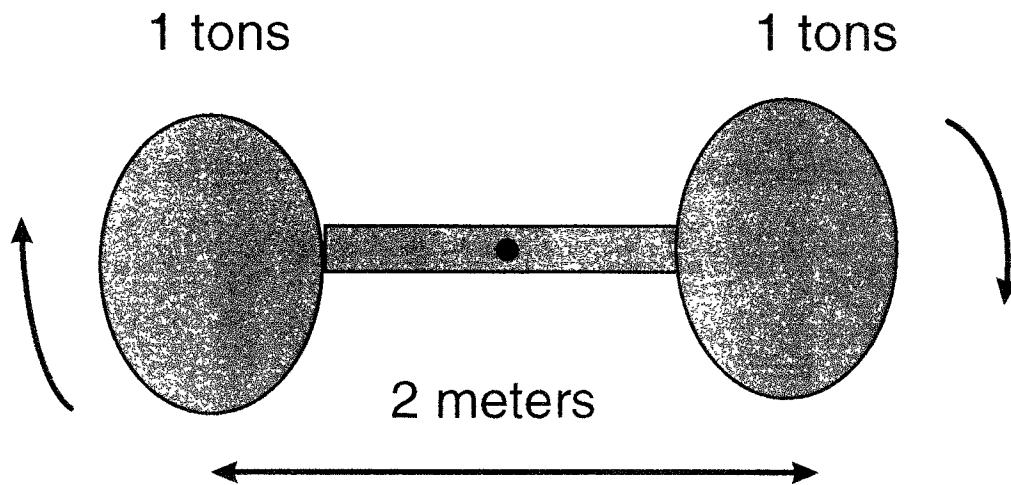

$$f_{\text{rot}} = 1 \text{ kHz}$$

$$h_{\text{lab}} = 2.6 \cdot 10^{-33} \text{ m} \times 1/R$$

$$R = \text{detector distance } (> 1 \text{ wavelength}) = 300 \text{ km}$$

$$h_{\text{lab}} = 9 \cdot 10^{-39}$$

This is too weak by about 16 orders of magnitude!

Gravitational Waves

Sources and Detection

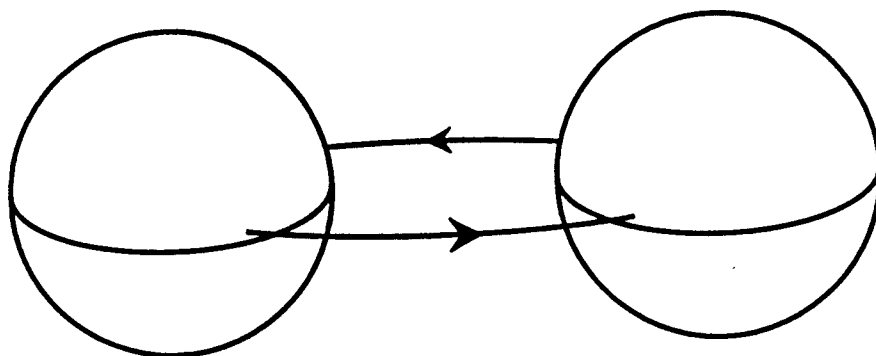

- binary star system

Sources	Frequency	h	Event Rate	Detection
Coalescing Binary Neutron Stars (200 Mpc)	10~1000 Hz	10^{-22}	~3/year	Interferometer + Template
Supernovae (in our Galaxy)	~1 kHz	10^{-18}	~3/century	Interferometer, Resonant
Supernovae (in Virgo)	~1 kHz	10^{-21}	several/year	Interferometer
Generation of Large Black Holes	~1 mHz	10^{-17}	1/year	Interferometer in Space
Pulsars	10~1000 Hz	10^{-25}	periodic	Interferometer, Resonant
Cosmic Strings	10^{-7} Hz	10^{-15}	stochastic	Pulsar Timing

- sources and detection

Astrophysical Sources

Frequency Range

- Electromagnetic Waves - ~ 20 orders of magnitude (ULF radio -> HE γ rays)
- Gravitational Waves - ~ 10 orders of magnitude
- Combination of terrestrial and space experiments

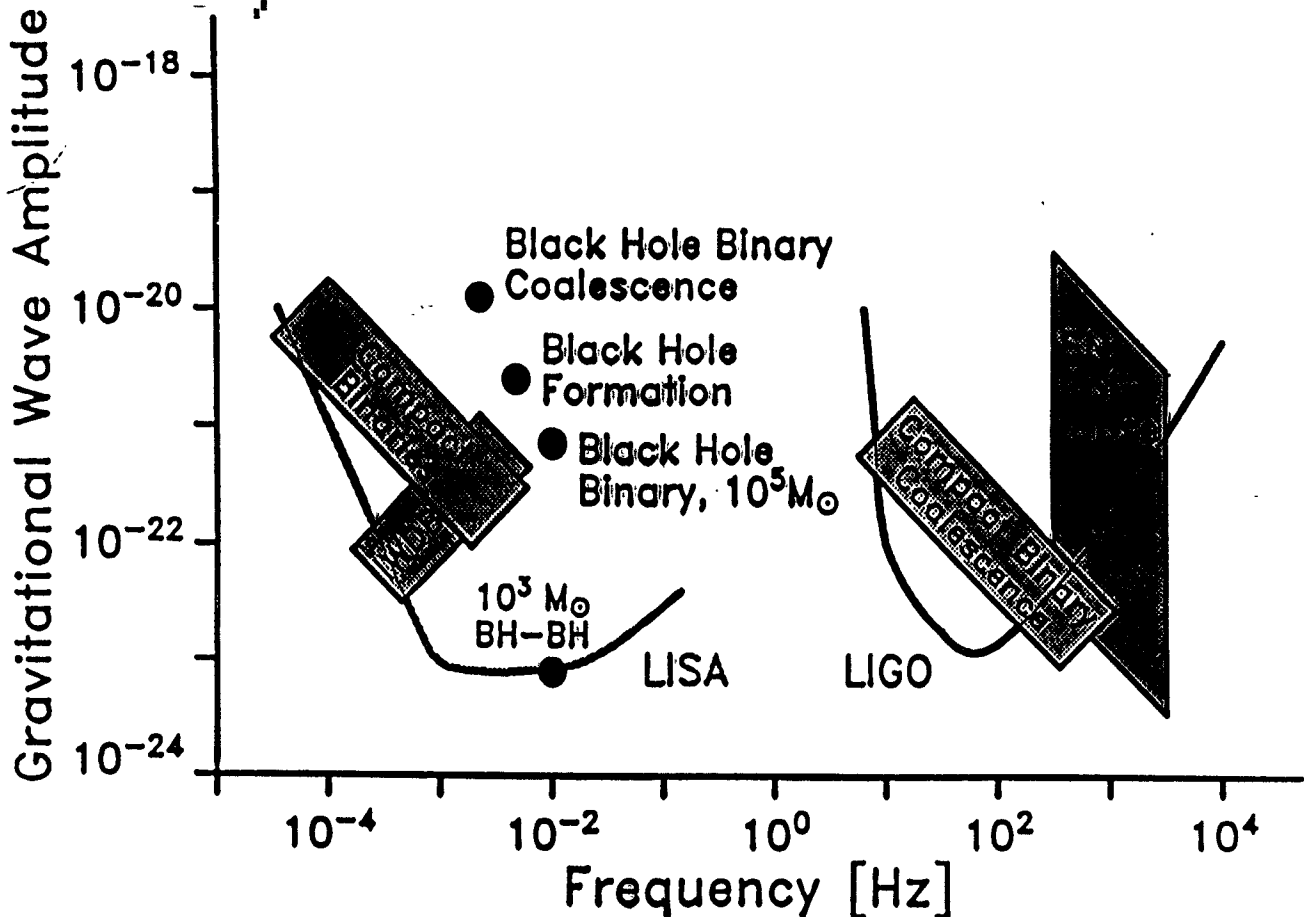

Gravitational Waves

Space Experiment

- LISA - Laser Interferometer Space Antenna
 - » six spacecraft in triangle (four needed)
 - » pair at each vertex

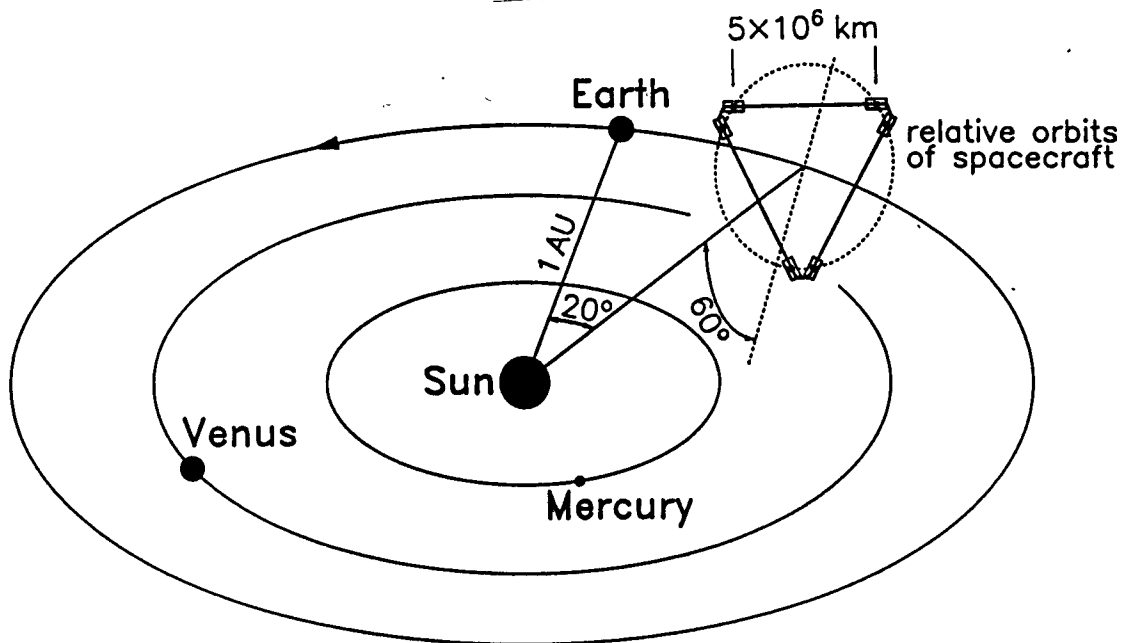

LISA

Annual Revolution

- 60 degree half opening angle
- 'tumbling' allows determination of position of source and polarization of wave

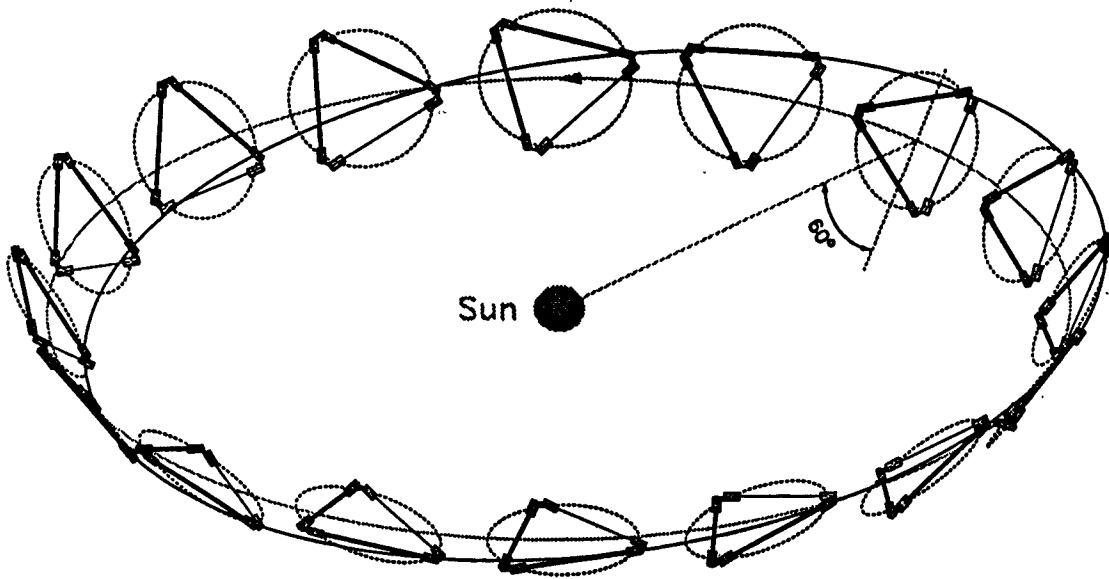

Gravitational Waves

Resonant Bar Detector

- Schematic Version

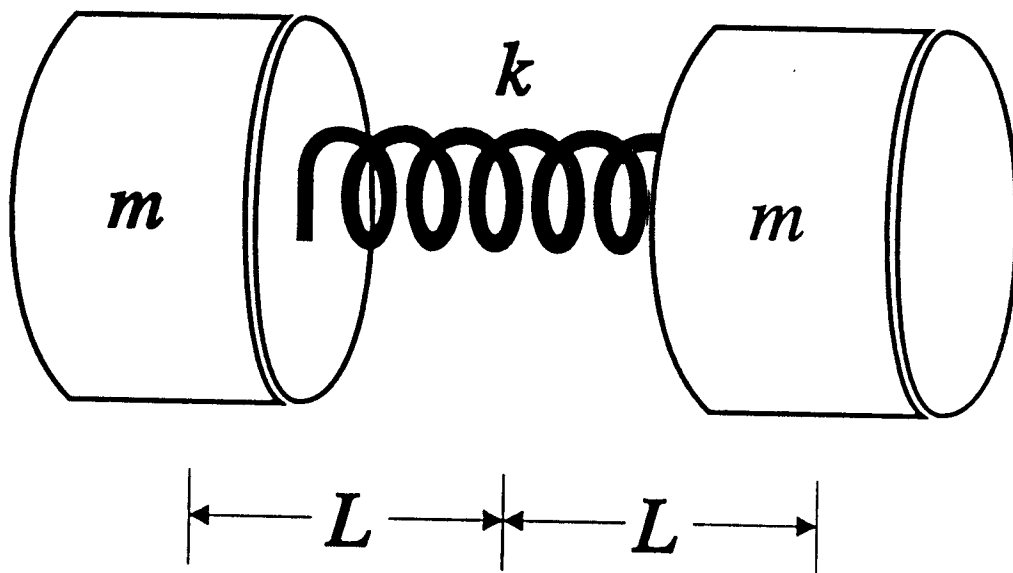

Gravitational Waves

Resonant Bar Detection

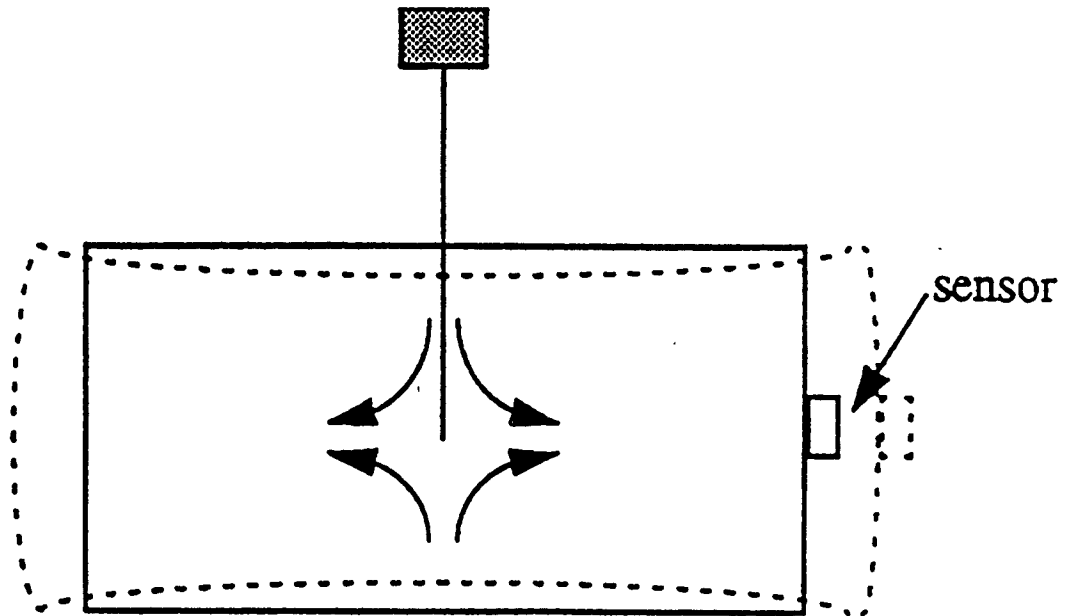

- Bar detector

Group	Antenna	Transducer	Sensitivity (h)
CERN/Rome	Al5056, 2.3ton, 2.6K	Capacitive+SQUID	7×10^{-19}
CERN	Al5056, 2.3ton, 0.1K	Capacitive+SQUID	2×10^{-18}
LSU(USA)	Al5056, 1.1ton, 4.2K	Inductive+SQUID	7×10^{-19}
Stanford	Al6061, 4.8ton, 4.2K	Inductive+SQUID	10^{-18}
UWA(Australia)	Nb, 1.5ton, 5K	RF cavity	9×10^{-19}
ICRR(Japan)	Al5056, 1.7ton, 300K	Laser Transducer	-
KEK(Japan)	Al5056, 1.2ton, 4.2K	Capacitive+FET	4×10^{-22} (60Hz)

- Status of bar detectors



Gravitational Waves

International Effort

- Techniques
 - » Resonant Bar Detectors (LSU, Rome, etc)
 - narrow band
 - » Large Scale Interferometers
 - broad band

- International Interferometer Effort
 - » U.S. -- LIGO (Two Sites)
 - Caltech & MIT (Wash and Louisiana)
 - » Europe -- VIRGO (One Site)
 - French and Italian (near Pisa)
 - » Smaller efforts
 - Germany, Japan, Australia

- Time Scale (Interferometers)
 - » Approximately year 2000



SCHEMATIC INTERFEROMETRIC DETECTOR

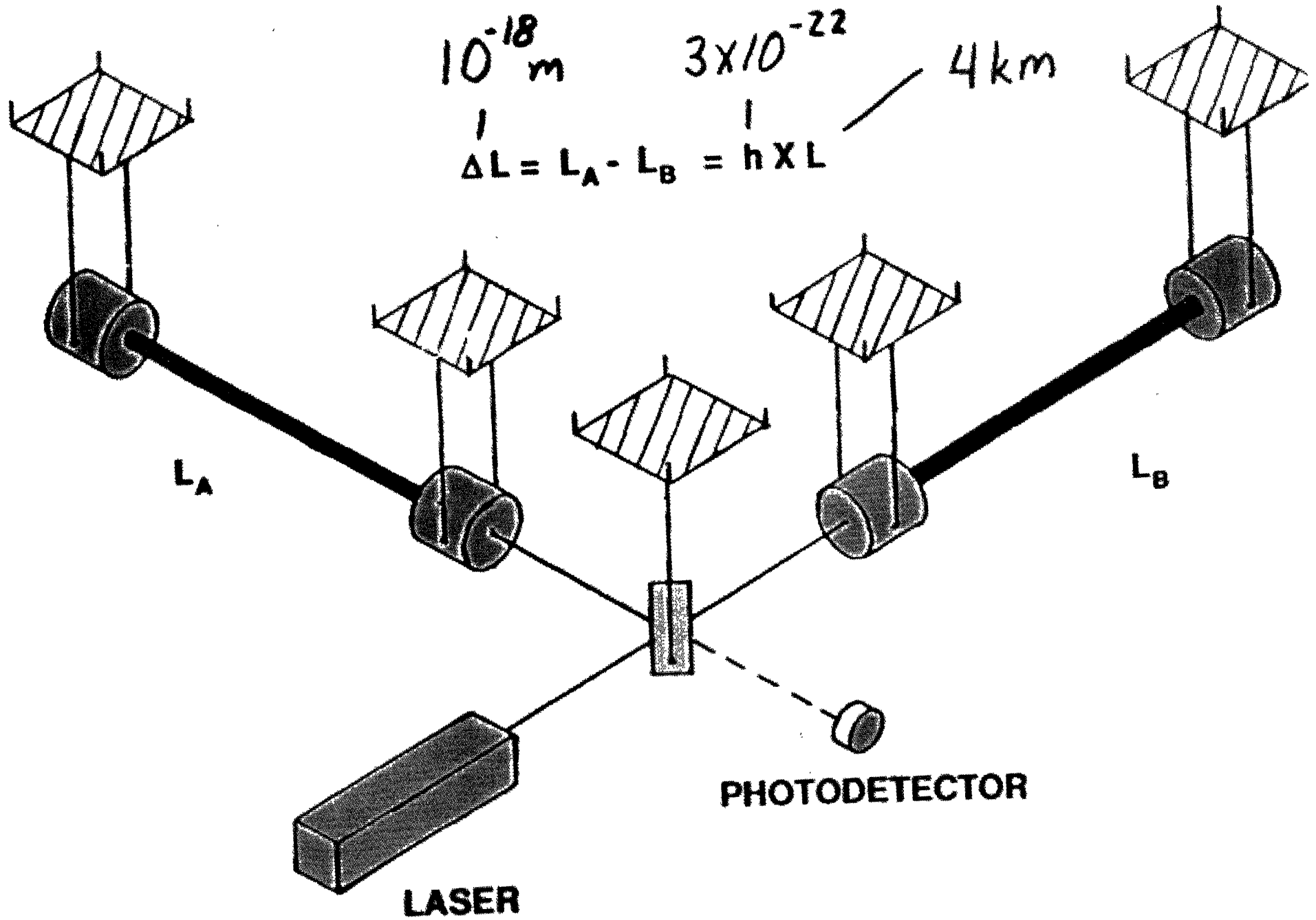

LIGO

Achieving 10^{-18} m Sensitivity

How is it possible????

- Air molecules:

Buffer mirrors

Buffer light beam
(fluctuating dispersion)

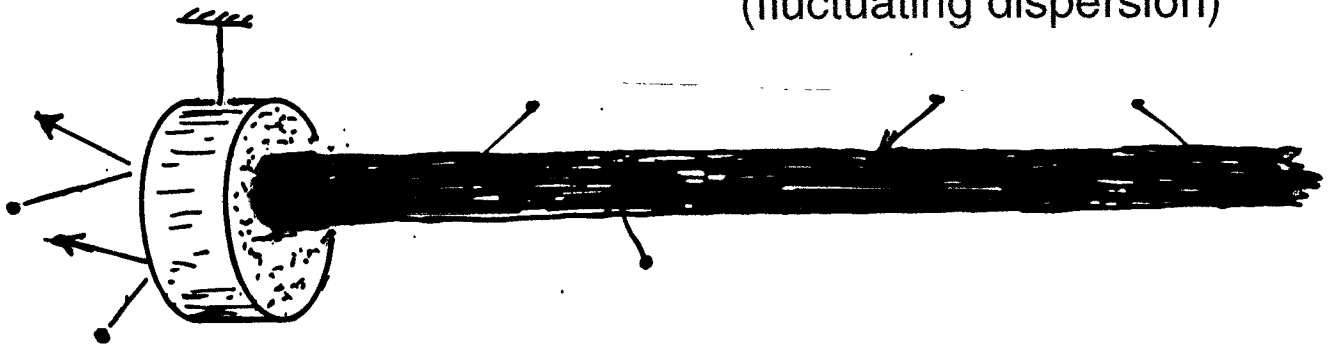

- » Mirrors and light beam must be in vacuum

- Mirror's atoms vibrate (thermal noise)

- » light beam feels 10^{18} atoms

- » atoms vibrate fast: $\sim 10^{13}$ Hz

- » beam measures slow variables: ~ 100 Hz

- Earth vibrates and shakes mirrors

- » anti-vibration suspension

- » quiet environment

Noise Budget For First LIGO Detectors

- 5 Watt Laser
- Mirror Losses 50 ppm
- Recycling Factor of 30
- 10 kg Test Masses
- Suspension $Q=10^7$

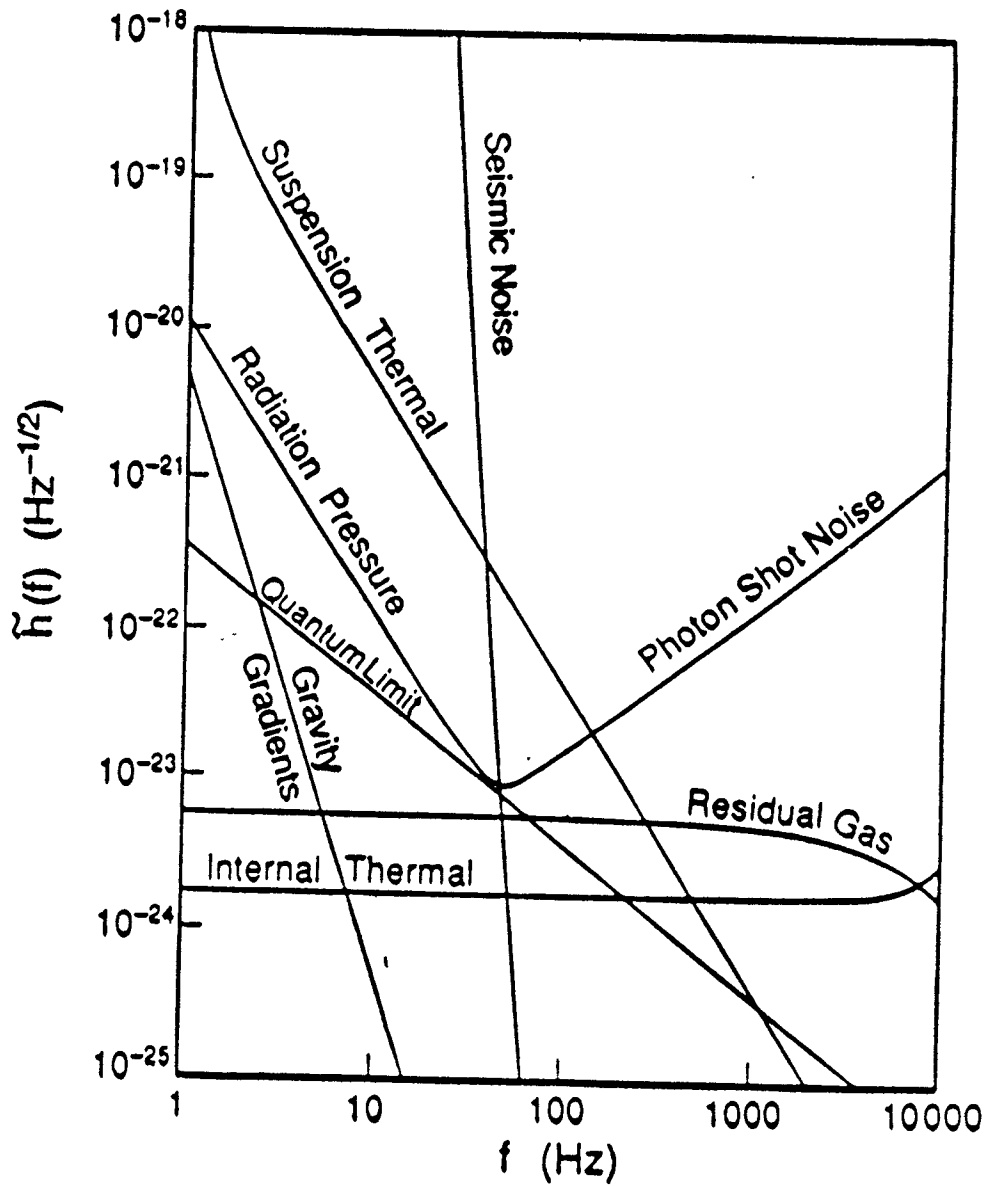

LIGO

Scientific Mission

- Direct Detection of Gravitational Waves
 - Benchmark Source: Neutron Binary Coalescence
 - Detect the last 15 minutes of Hulse/Taylor type binary system (eg. 100 million years)
 - Sensitivity -- detection rate >3 year
 - Other Sources

- Fundamental Physics (GR)
 - » Test General Relativity in Strong Field and High Velocity Limit
 - » Measure Polarization and Propagation Speed

Neutron Star Binary Coalescence

<u>Method</u>	<u>Our Galaxy</u>	<u>Distance for 3/yr</u>
Progenitor Death Rate	$\sim 1/1000$ yr	130 M.L.yr
Binary Pulsar Searches and Discoveries	$\sim 1/10^{5\pm 1}$ yr	600 M.L.yr.
Ultra-conservative Limit from Binary Pulsar Searches	$\sim 1/10^7$ yr	3000 M.L.yr

Neutron Binary Systems

Inspiral

- LIGO frequency band
 - » last 15 minutes ($\sim 10^4$ cycles)
- 'Chirp Signal'
- Detailed waveform gives masses, spins, distance, eccentricity of orbit, etc

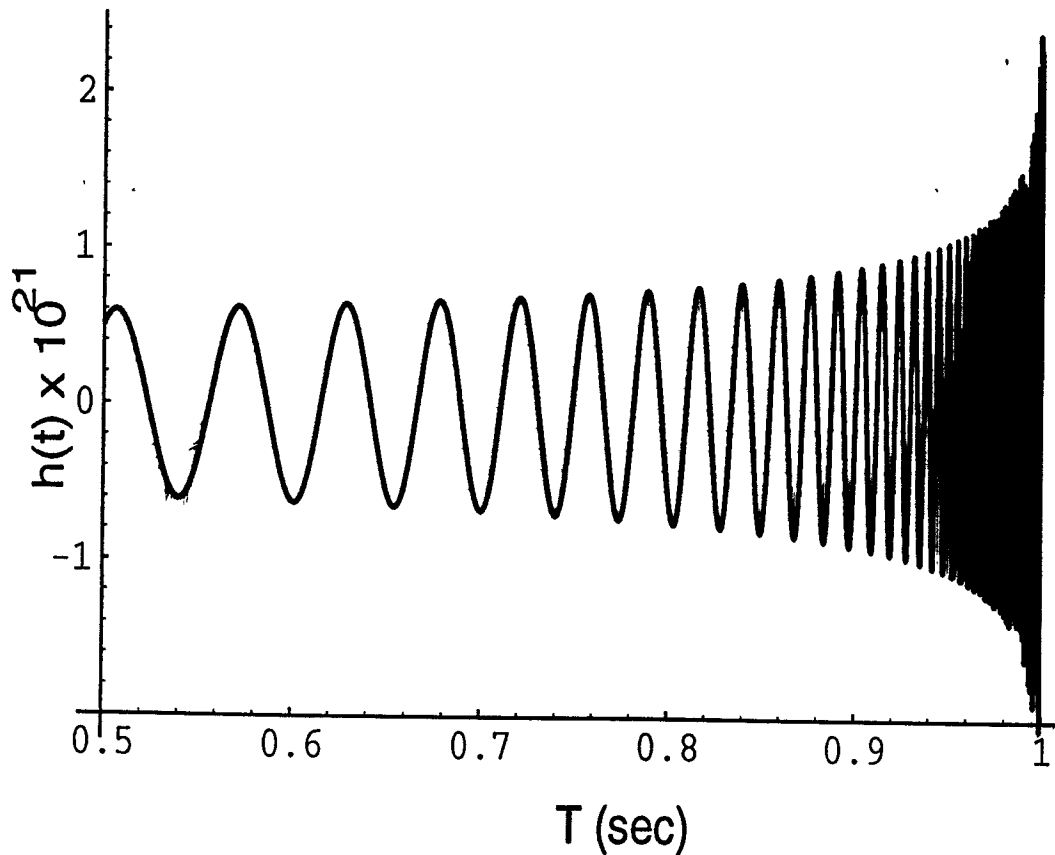
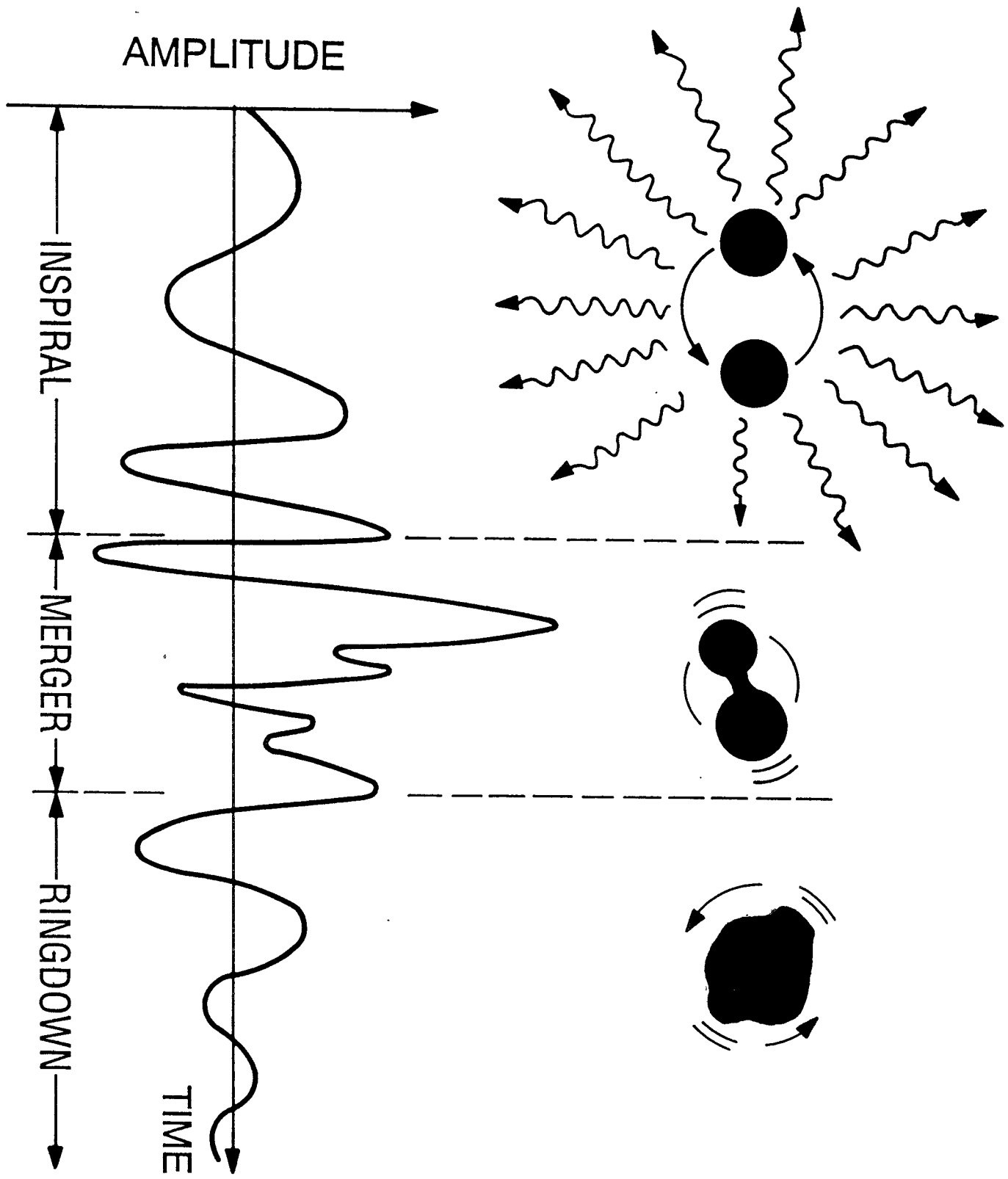
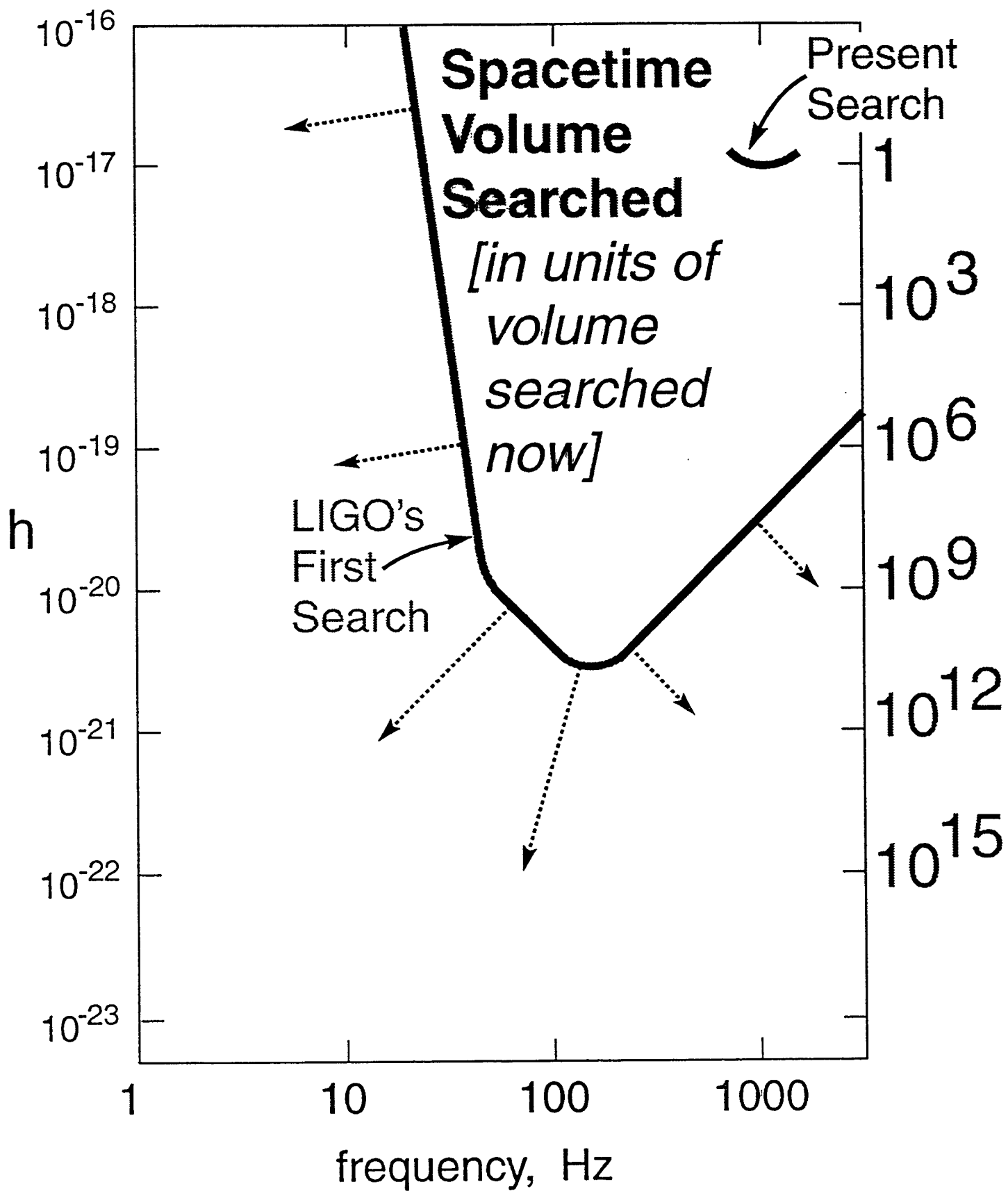

FIG 1





LIGO

Long Range Goals

- Final Coalescence of Binary Systems

- » Neutron Star/Neutron Star
 - Design Benchmark: last 15 min
20,000 cycles
600 MLyr
- » Black-hole/Black-hole
- » Black-hole/Neutron Star

- Supernovae

- » Axisymmetric in our galaxy
- » Non-axisymmetric ~300MLyr

- Early Universe

- » Vibrating Cosmic Strings
- » Vacuum Phase Transitions
- » Vacuum Fluctuations from Planck Era

- Unknown Sources



BLACK HOLE BINARIES

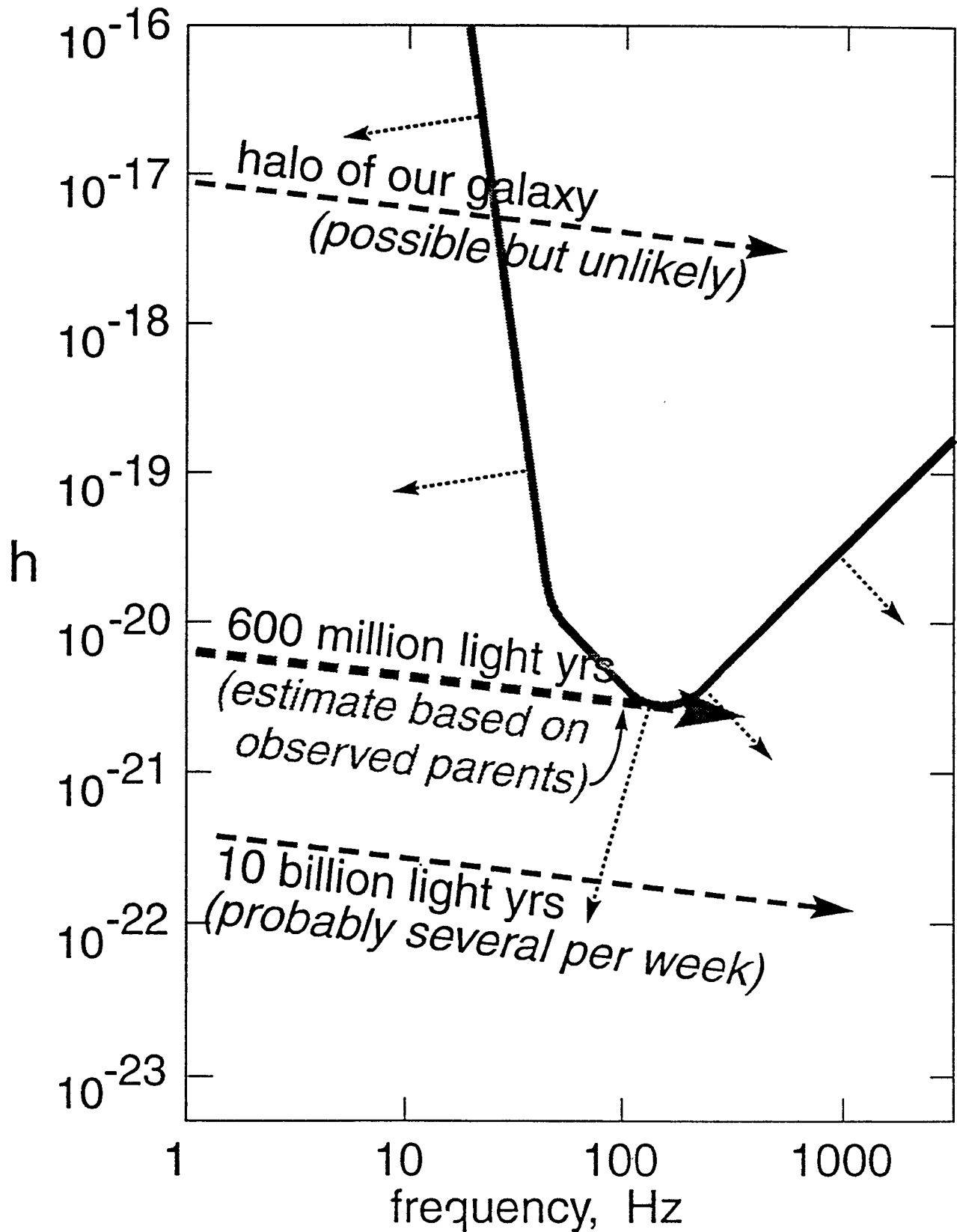
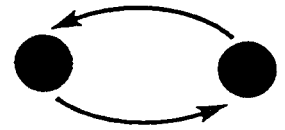

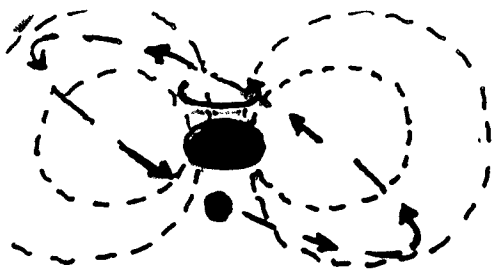

BH Spin → "gravitomagnetic field"
(frame dragging)
→ ~ 20 precessions of orbit

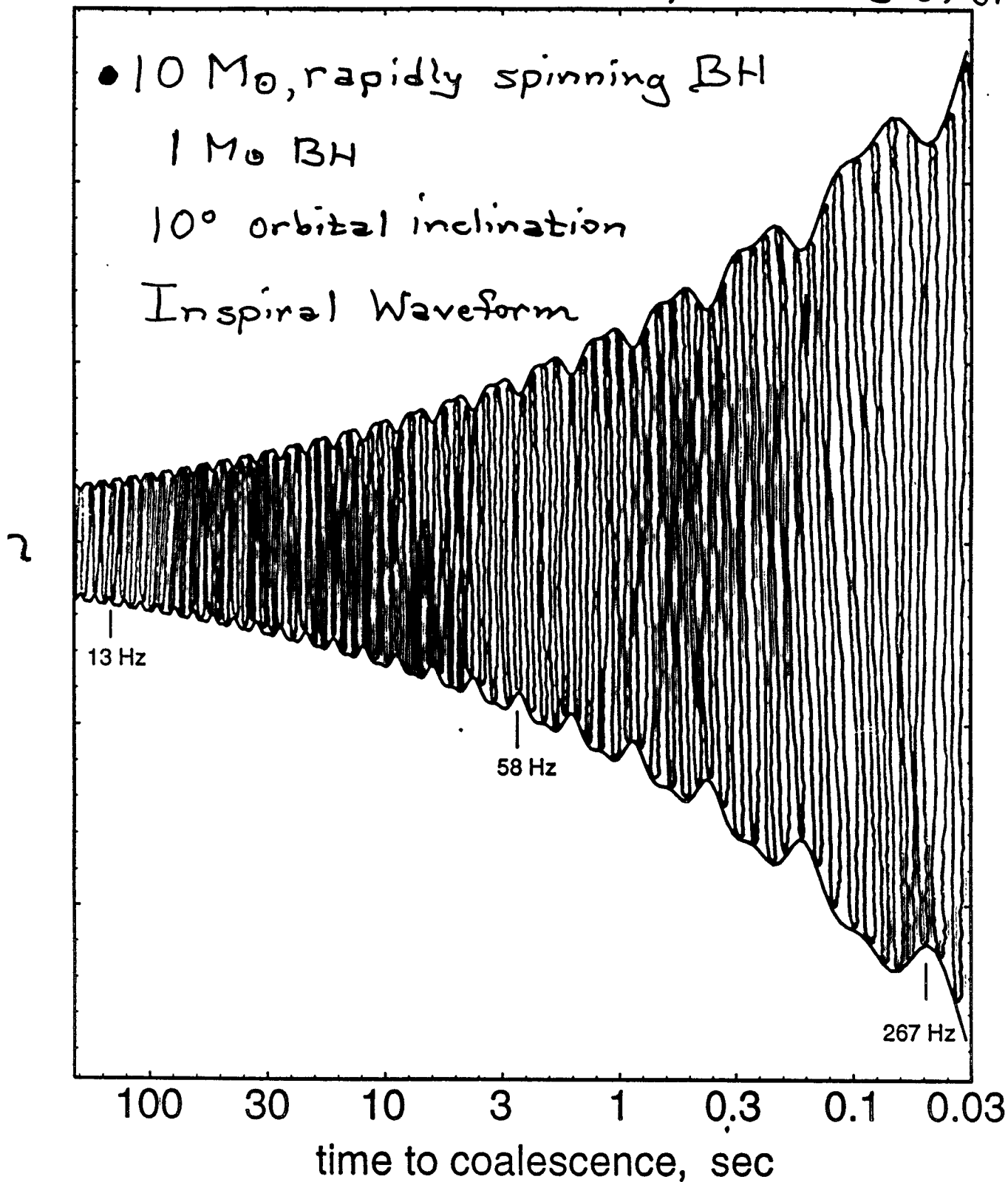

TWO WAVEFORMS [*Stereophonic*]

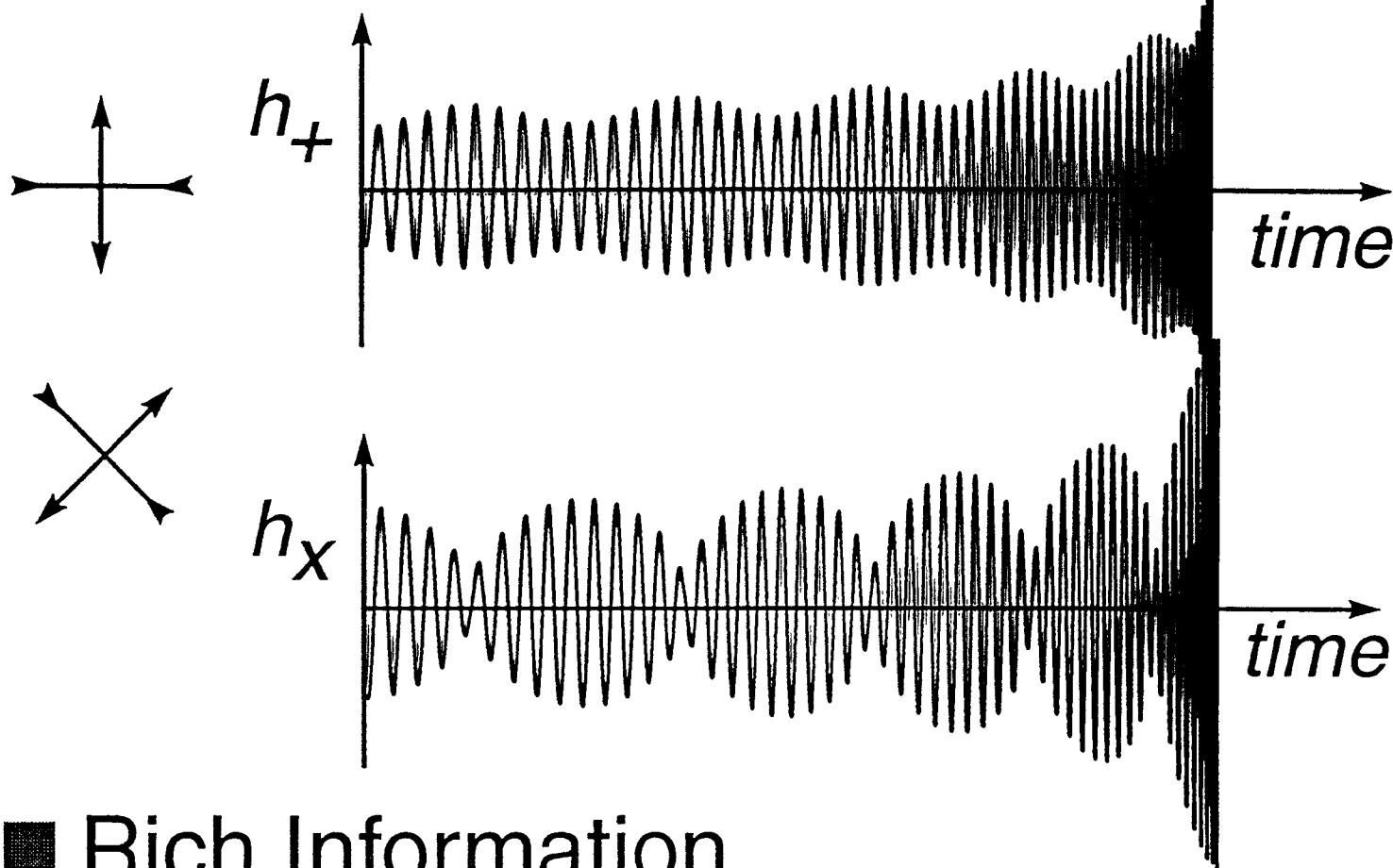

■ Rich Information

- *Map of spacetime warpage*

- *Tornado-like swirl of space around big hole*



- *Nonlinear vibrations of spacetime*
[Compare with Grand Challenge Supercomputer Simulations]

OTHER POSSIBLE SOURCES

SPINNING, "MOUNTAINOUS" NEUTRON STAR

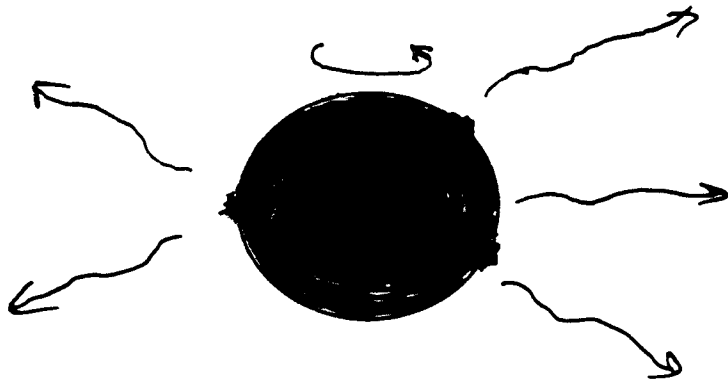

Periodic

IMPLOSION OF A STAR'S CORE

— WHICH TRIGGERS A SUPERNOVA

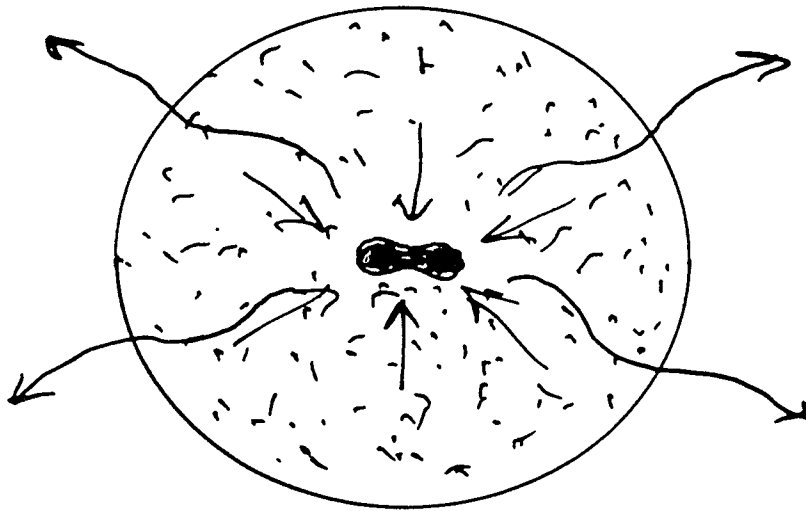

Bursts

VIBRATING LOOPS OF COSMIC STRING

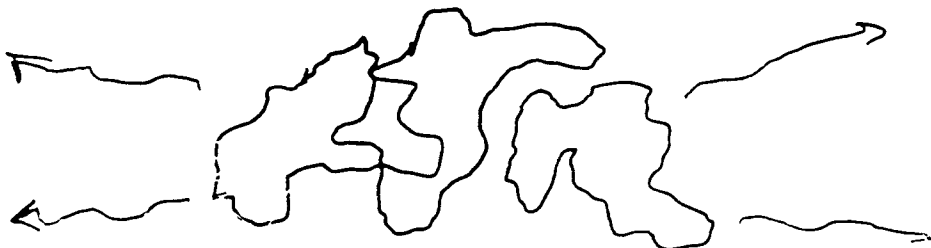

Stochastic

Pulsars

- periodic waveform (integrate for long time)
- rotating non-axisymmetric neutron stars

Simple model:

$$M = 1.4 M_{\odot}$$

$$r = 10 \text{ km}$$

$$I = 10^{45} \text{ gm cm}^2$$

f

$$\dot{\epsilon} = \frac{3\pi^2 G}{Rc^4} \epsilon I f^2$$

ϵ = equatorial ellipticity

→

→ $\dot{\epsilon}$ = $\dot{I} \epsilon + I \dot{\epsilon}$

Estimate distortion due to dipole magnetic field

$$\epsilon \approx \frac{U_{\text{mag}}}{U_{\text{grav}}} \approx \frac{B^2 R^4}{2M^2} = 10^{-12}$$

if $B \approx 10^{12}$ gauss (typical of pulsars)

$$h \approx 3 \cdot 10^{-31} \left(\frac{f}{1 \text{ kHz}} \cdot \frac{v}{10 \text{ km/s}} \right)$$

if pulsars born rapidly rotating then several most recent pulsars with such amplitude in our galaxy any time

Note fastest known pulsar PSR1937+214 only has $B \approx 10^8$ gauss, but it is thought this pulsar was 'spun up' by consuming low mass companion
ALSO "Wagener star" enhancement.

Supernovae

Type I - explosive detonation of a white dwarf star (no substantial emission of gravitational waves)

Type II - may emit strong gravitational waves

'naked eye' observations

16th century (Tycho)

SN 1987A (neutrinos)

Gravitational radiation (mechanism)

- massive star produces core $\sim 1.4 M_{\odot}$
which has burned to iron (white dwarf)
- electron degeneracy pressure no longer can support the core
- matter converts into neutrons
- collapses
- bounce @ nuclear densities ($\sim 3 \cdot 10^{14} \text{ gm/cm}^3$)

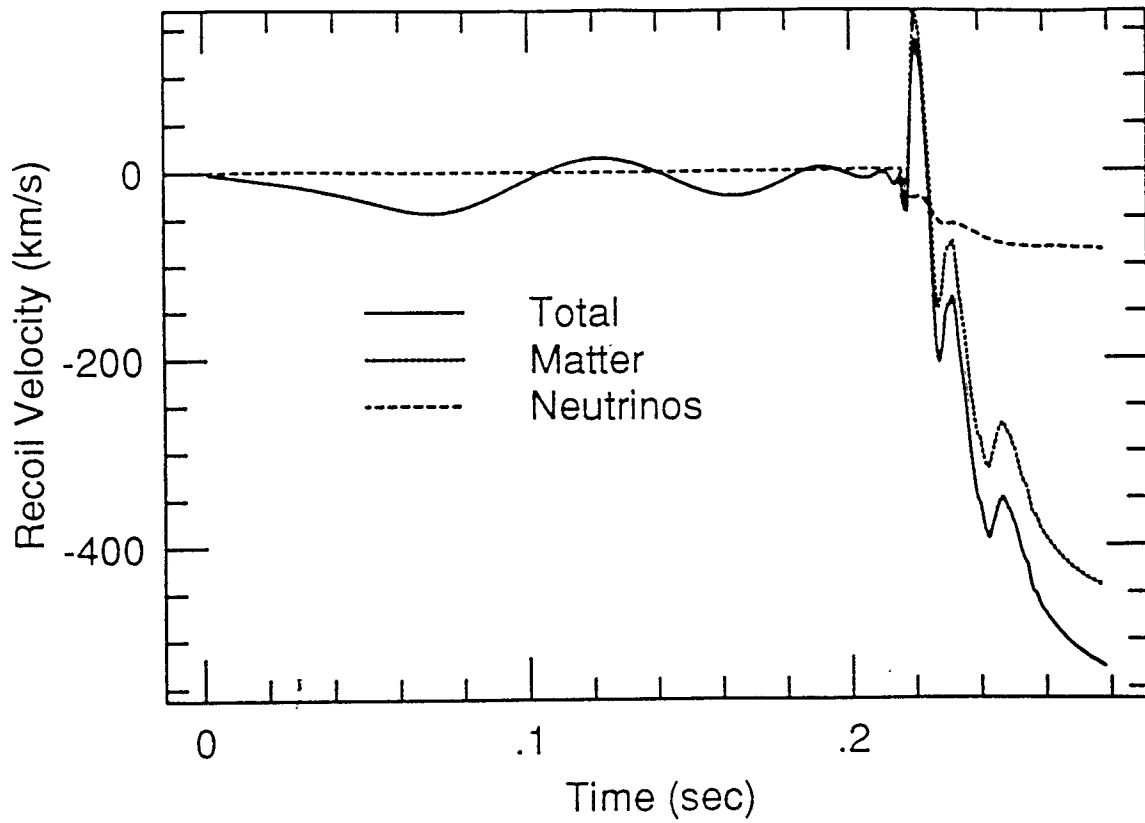

FIG. 2. The inferred recoil speed (in km s^{-1}) imparted to the core versus time (in seconds) for the simulation highlighted in this paper. The initial momentum is approximately zero, but grows systematically after bounce in the direction opposite to the artificial wedge, cut into the core to mimic an asymmetry just before collapse. Shown are the total recoil (solid) and the contributions due to the neutrino emission anisotropy (dashed) and the ejecta motions (dotted).

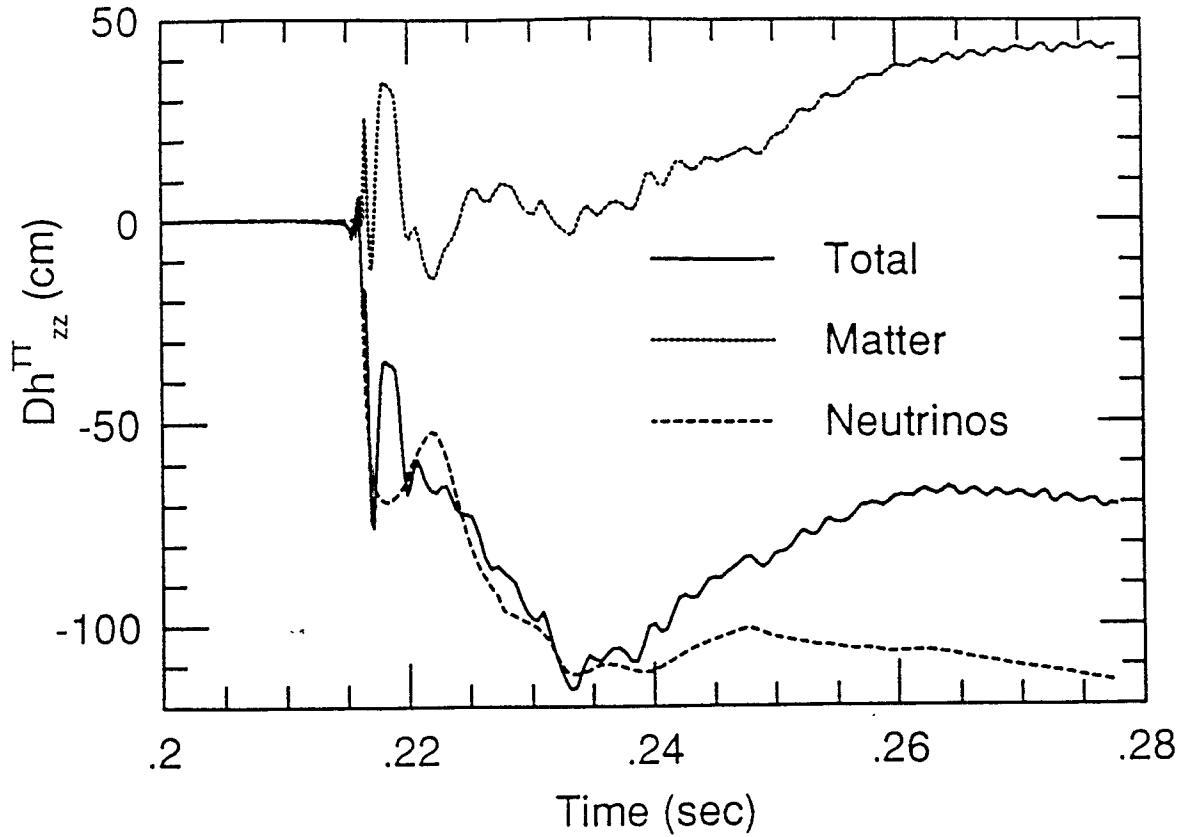

FIG. 3. The gravitational wave strain, h_{zz}^{TT} , times the distance to the supernova, D , versus time (in seconds). Core bounce is at 0.215 seconds. The total, matter, and neutrino waveforms are rendered with the solid, dotted, and dashed lines, respectively.

o physics modeling very difficult
(departure from spherical shape)

o guidance (unclear)

- supercomputers assume spherical sym.

- 2D models (Burrows)

- crab pulsar $f_{\text{rot}} \approx 30.3 \text{ Hz}$

$$J = 2 \cdot 10^{47} \text{ erg-sec}$$

(Saenz-Shapiro \rightarrow radiate gravitational
 $3 \cdot 10^{-6}$ of rest mass

$$h \approx 10^{-23} \text{ @ VIRGO}$$

- collapsing cores w/ high angular momentum?
(eg "millisecond pulsars")

FIGURES

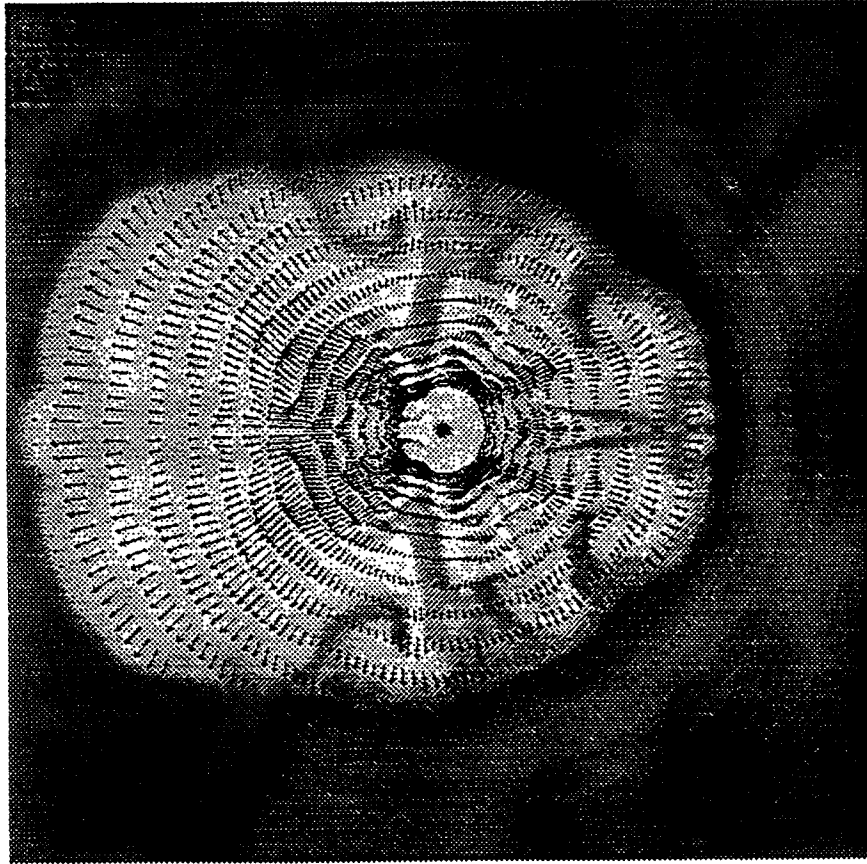

FIG. 1. A grey-scale rendering of the entropy distribution at the end of the simulation, about 50 milliseconds into the explosion. Note the pronounced pole-to-pole asymmetry in the ejecta and the velocity field (as depicted with the velocity vectors). The physical scale is 2000 km from the center to the edge. Darker color indicates lower entropy and $\theta = 0$ on the bulge side of the symmetry axis.

Stochastic Gravity-Wave Background

- could come from early Universe
LIGO Band $\sim 10^{-22}$ sec

(also could be overwhelmed by
more recent sources)

- graviton background analogous to Ω_{em}
THERMAL SPECTRUM $T \sim 0.9$ K

(smaller than Cosmic Microwave
Background Radiation because in
conventional hot big bang model,
gravitons decoupled when temperature
of Universe dropped below Planck temp)

THE BIG BANG SINGULARITY

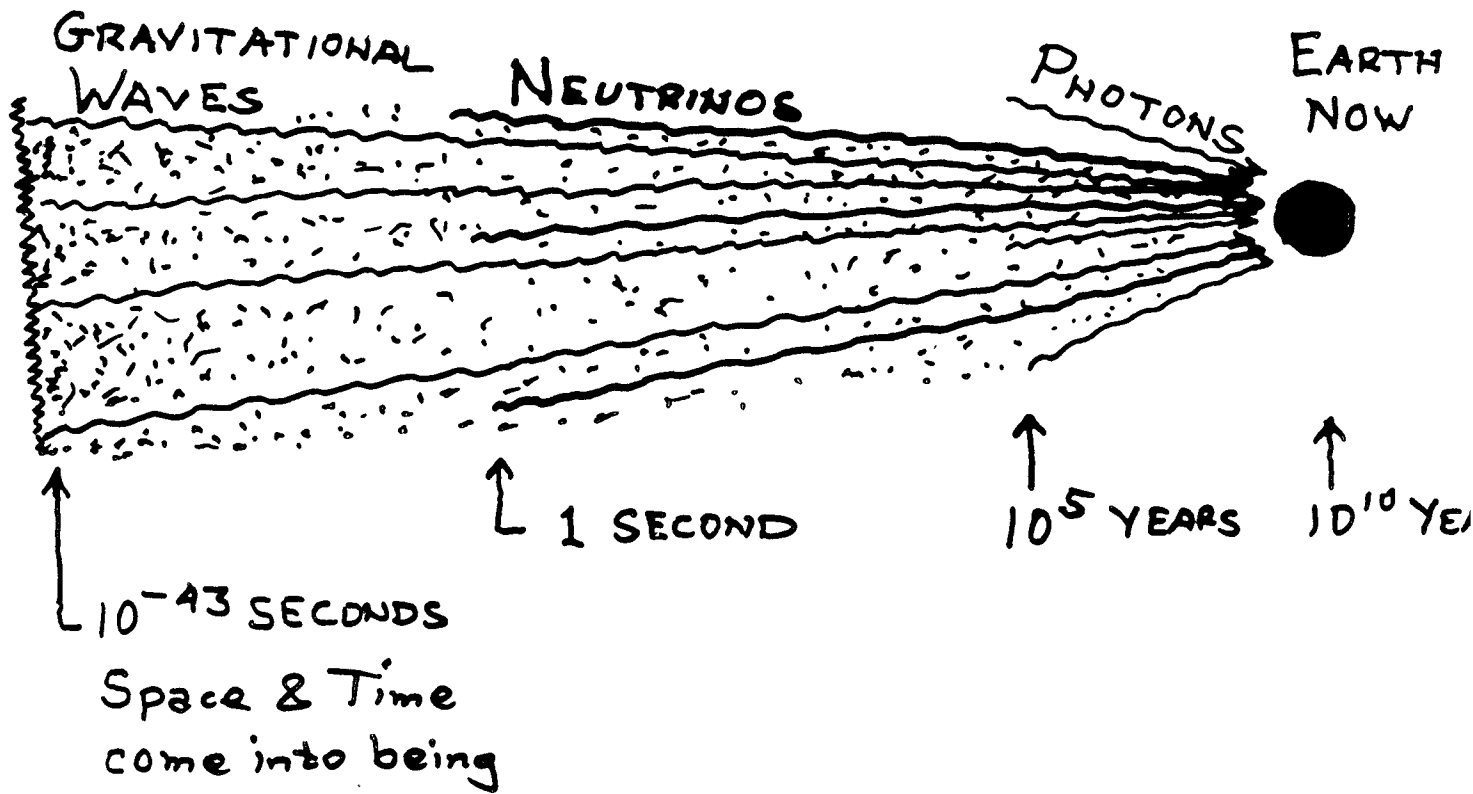

LIGO 10^{-22} sec Temp $\sim 10^6$ GeV
graviton ~ 10 MeV

LISA (10^{-2} Hz) 10^{-14} sec Temp $\sim 10^2$ GeV (electroweak)
graviton ~ 1 keV

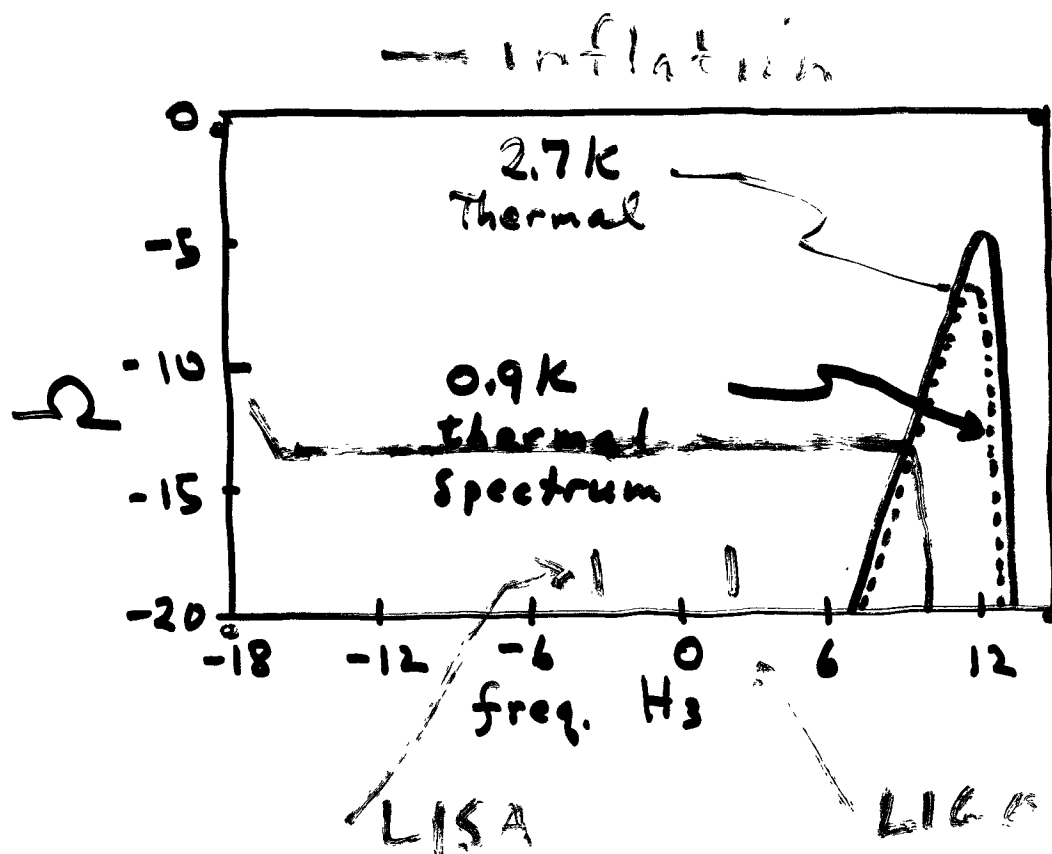

- unlikely equilibrium was established since gravitational interactions so weak (time required longer than expansion time)

- useful benchmark

- detection

correlate (anticorrelate) signals from different detectors

(eg $<64 \text{ Hz}$ LIGO detectors correlated)

How to detect Stochastic Background

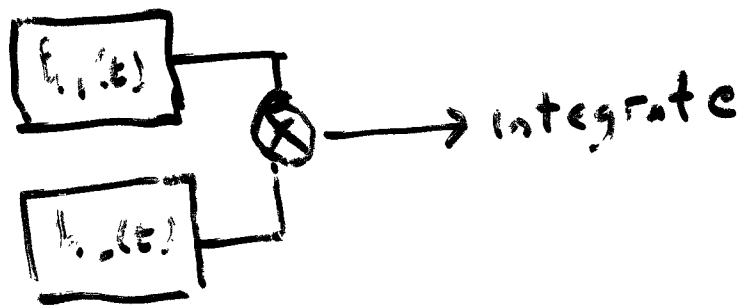
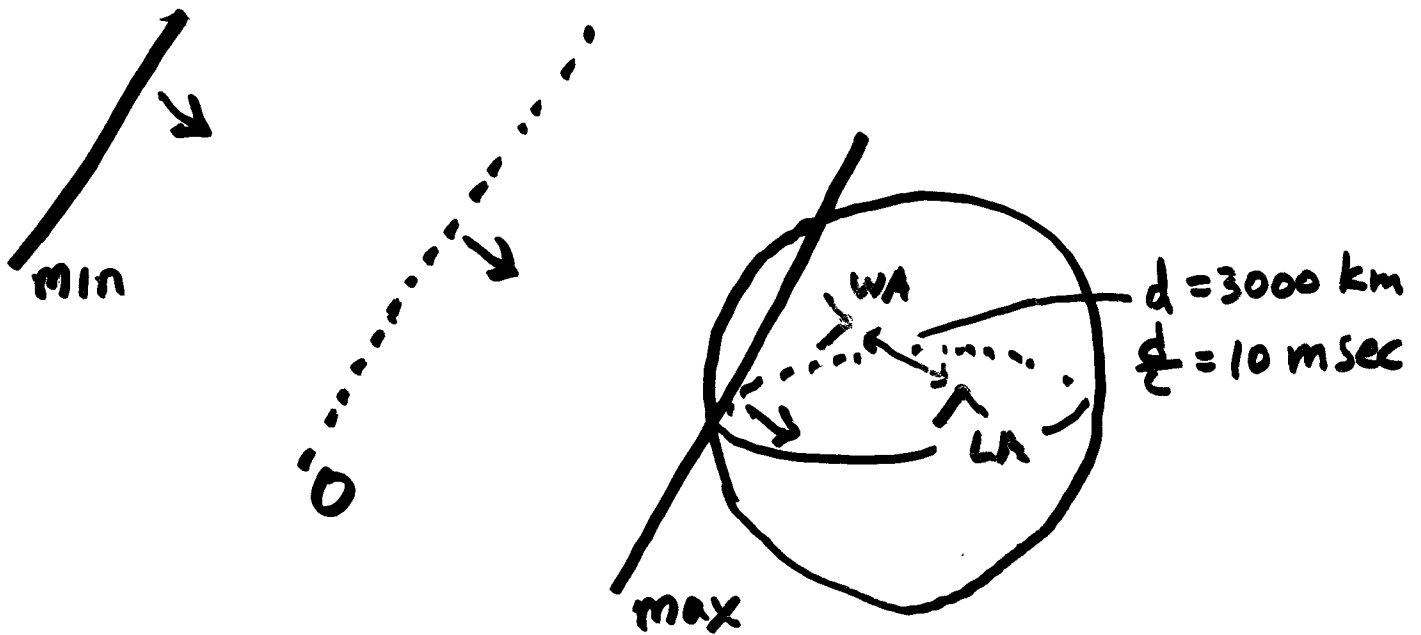

For waves with $\frac{\lambda}{2} > 3000 \text{ km}$ ($f \lesssim 50 \text{ Hz}$)
 detector arms move in phase (together) so
 average product $\langle h_1(t) h_2(t) \rangle > 0$

In absence of background (and other signal)
 average product $\langle h_1(t) h_2(t) \rangle \rightarrow 0$

Michelson, Mon. Not. Roy. Astron Soc 227 (1987) 933.
 Christensen, Phys. Rev. D46 (1992) 5250.
 Flanagan, Phys. Rev. D48 (1993) 2389

LIGO

Sensitivity

- Comparison of sensitivity and wave strengths ($h_{sb} = 11h_{rms}$)

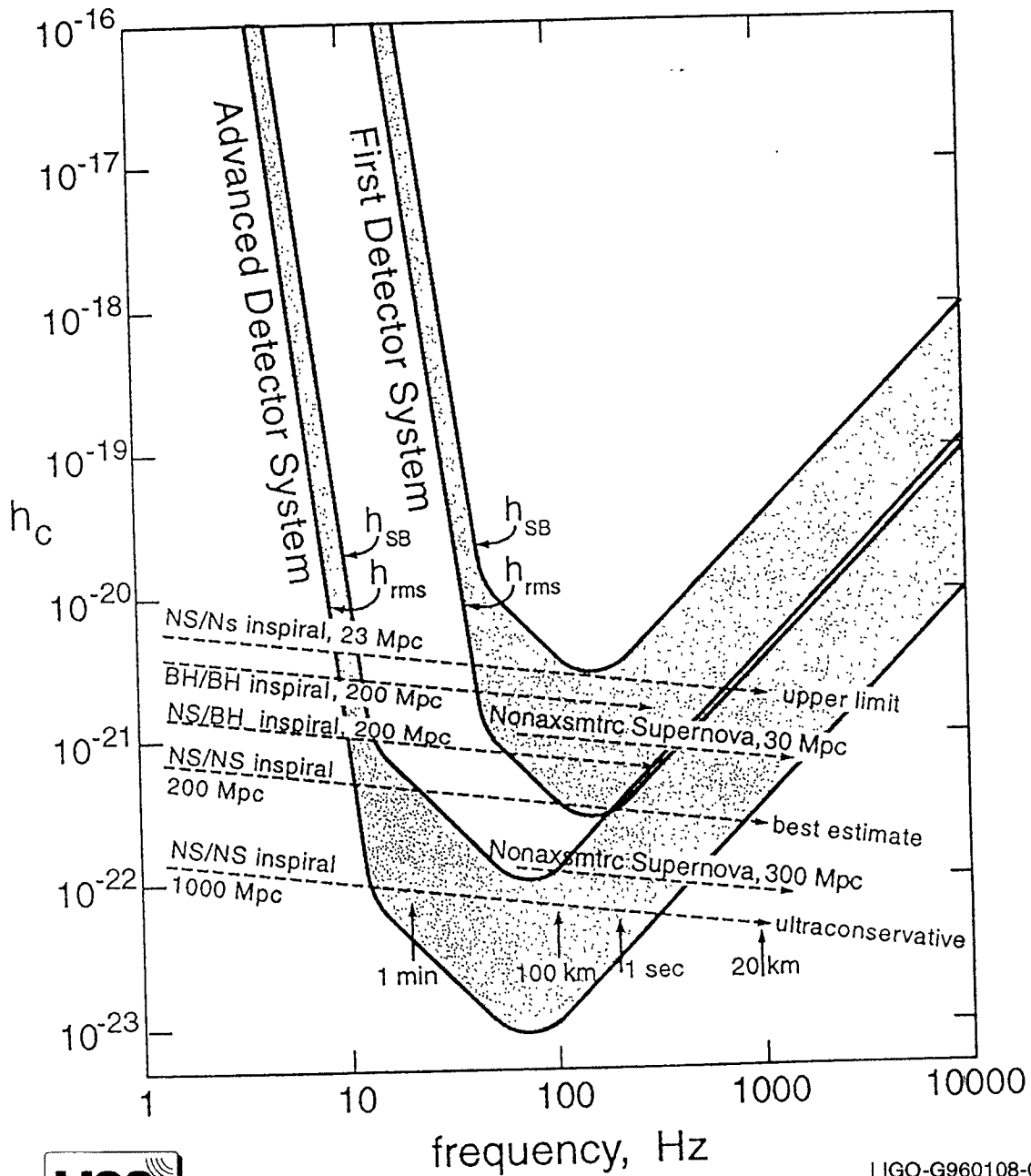

LIGO INTERFEROMETERS

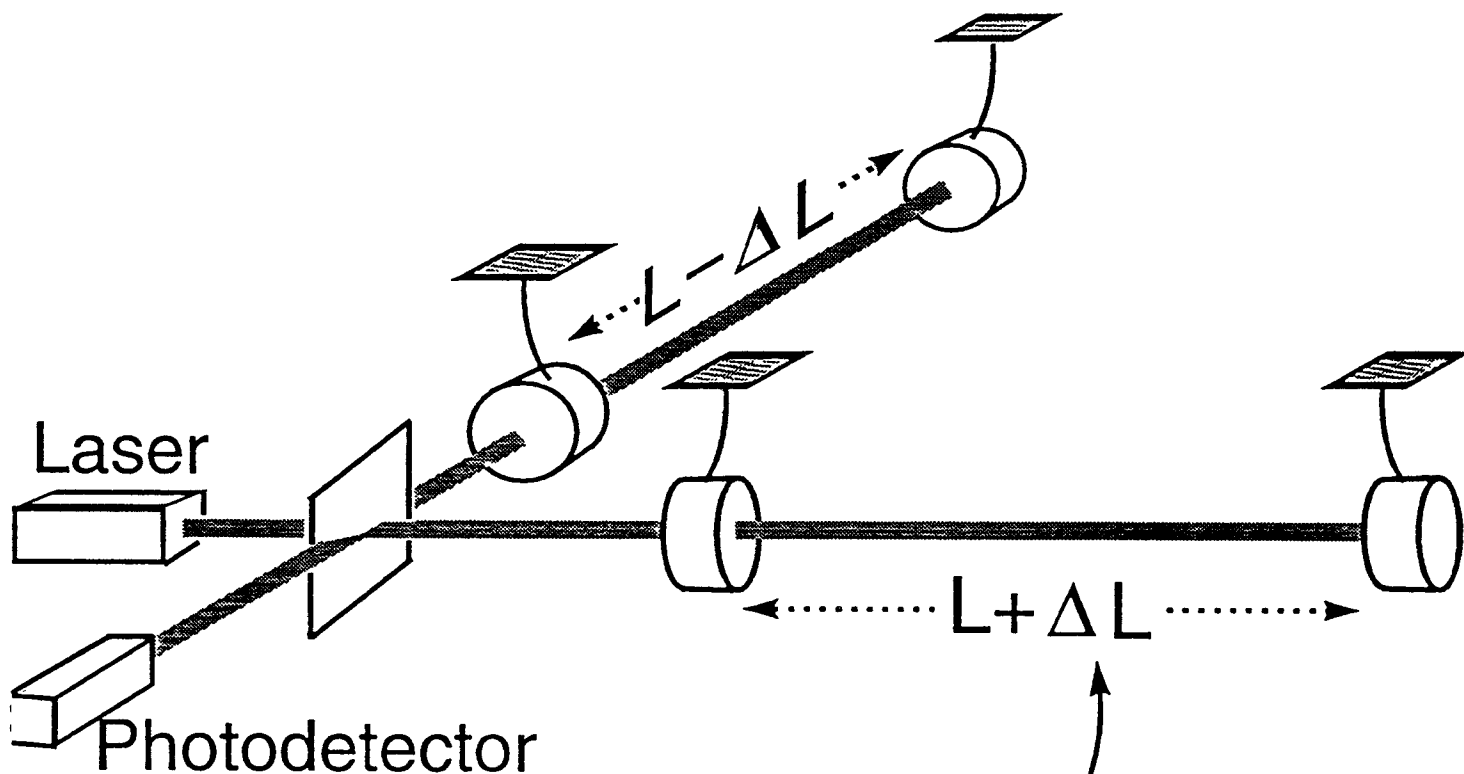

- To make ΔL large enough for detection requires $L \gtrsim 4 \text{ km}$

$$\Delta L = hL = 4 \times 10^{-16} \text{ cm}$$

10^{-21} 4 km

- Measured waveform, $h(\text{time}) = \Delta L/L$, is a linear combination of h_+ and h_x , which depends on interferometer's orientation

LIGO

The Project

- National Science Foundation

- Construction Project (1995-1999)
 - » Facilities and Initial Detector

- Commission Facility (1999-2001)
 - » Implement Initial Detectors
 - $h \sim 10^{-20}$ - Coincidence
 - Initial Search (end of 2000)
 - $h \sim 10^{-21}$ - Initial Design Sensitivity (end 2001)

- Full Operations (2002 + ...)
 - » Data Dating/Analysis
 - data collaboration with VIRGO
 - » Enhance Initial Detector
 - incorporate outside collaborations
 - » Advanced Detectors
 - Syracuse, Colorado, Stanford, etc
 - Caltech/MIT efforts



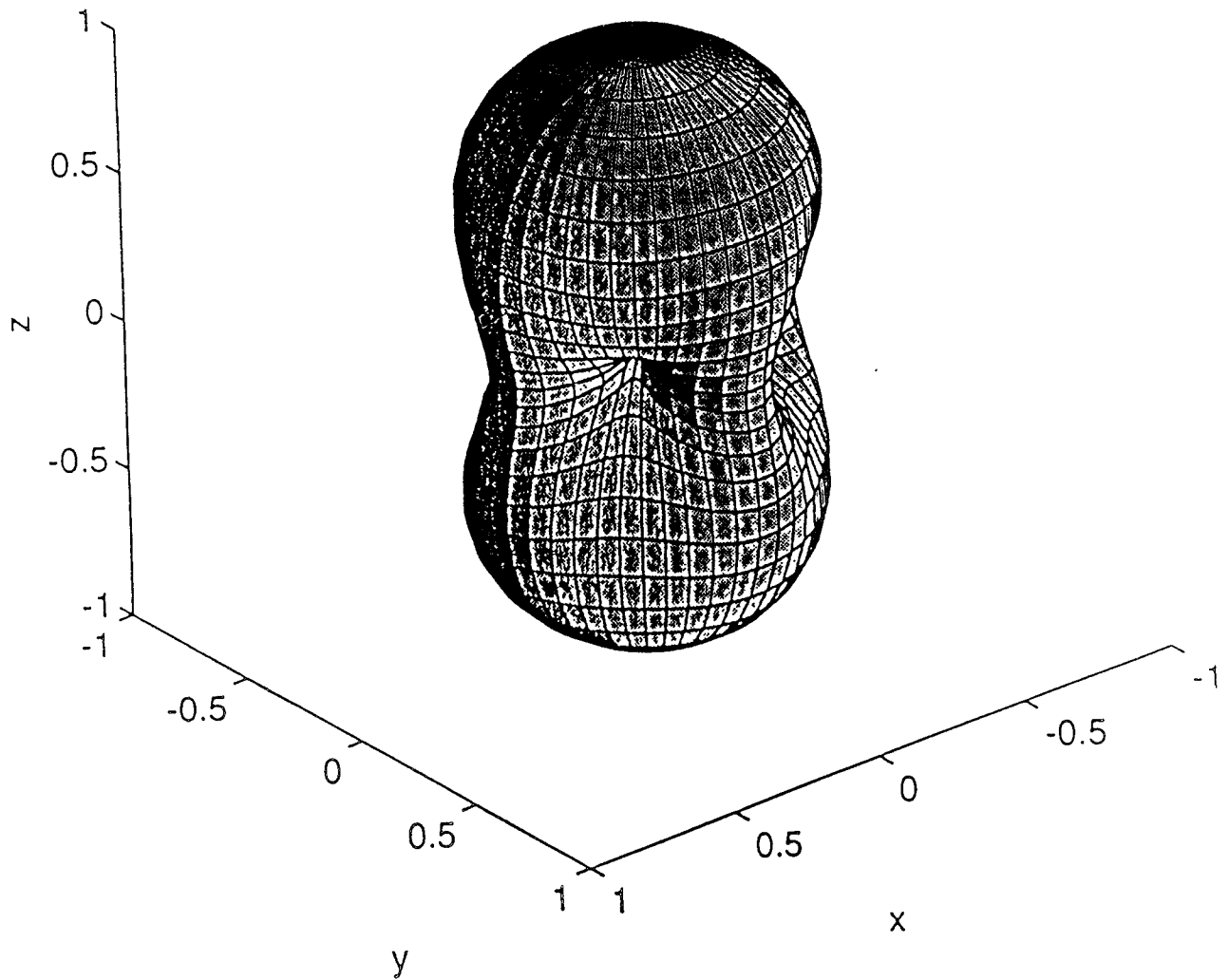
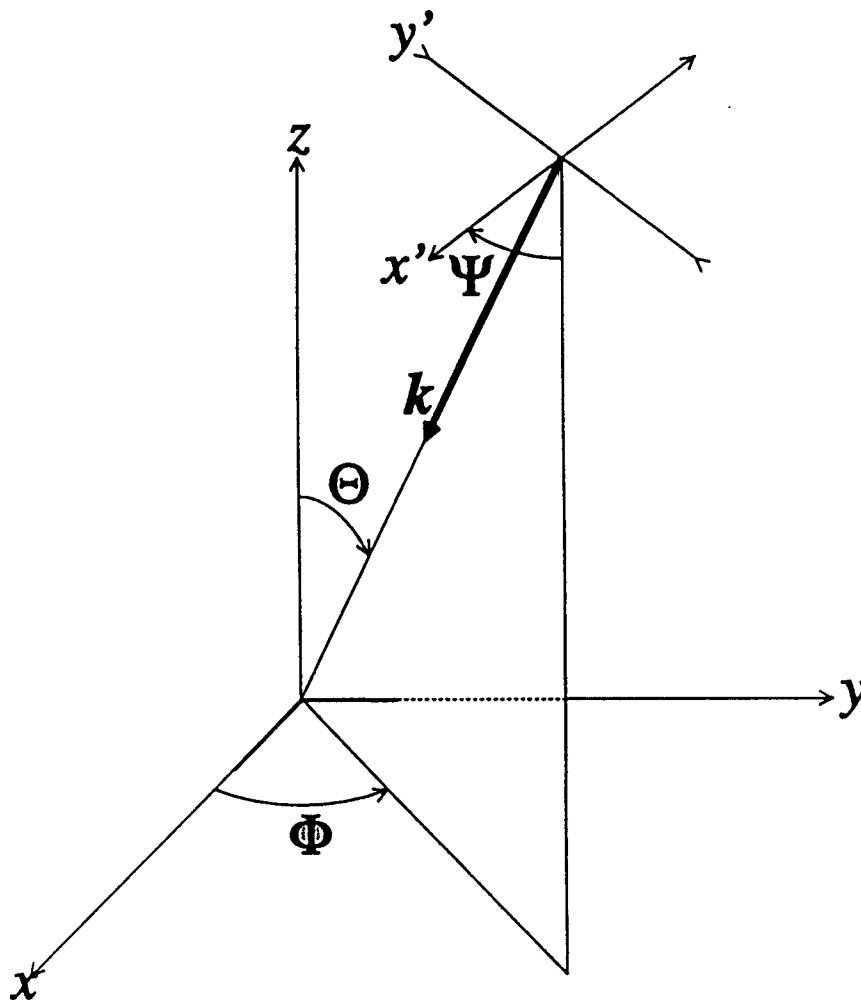
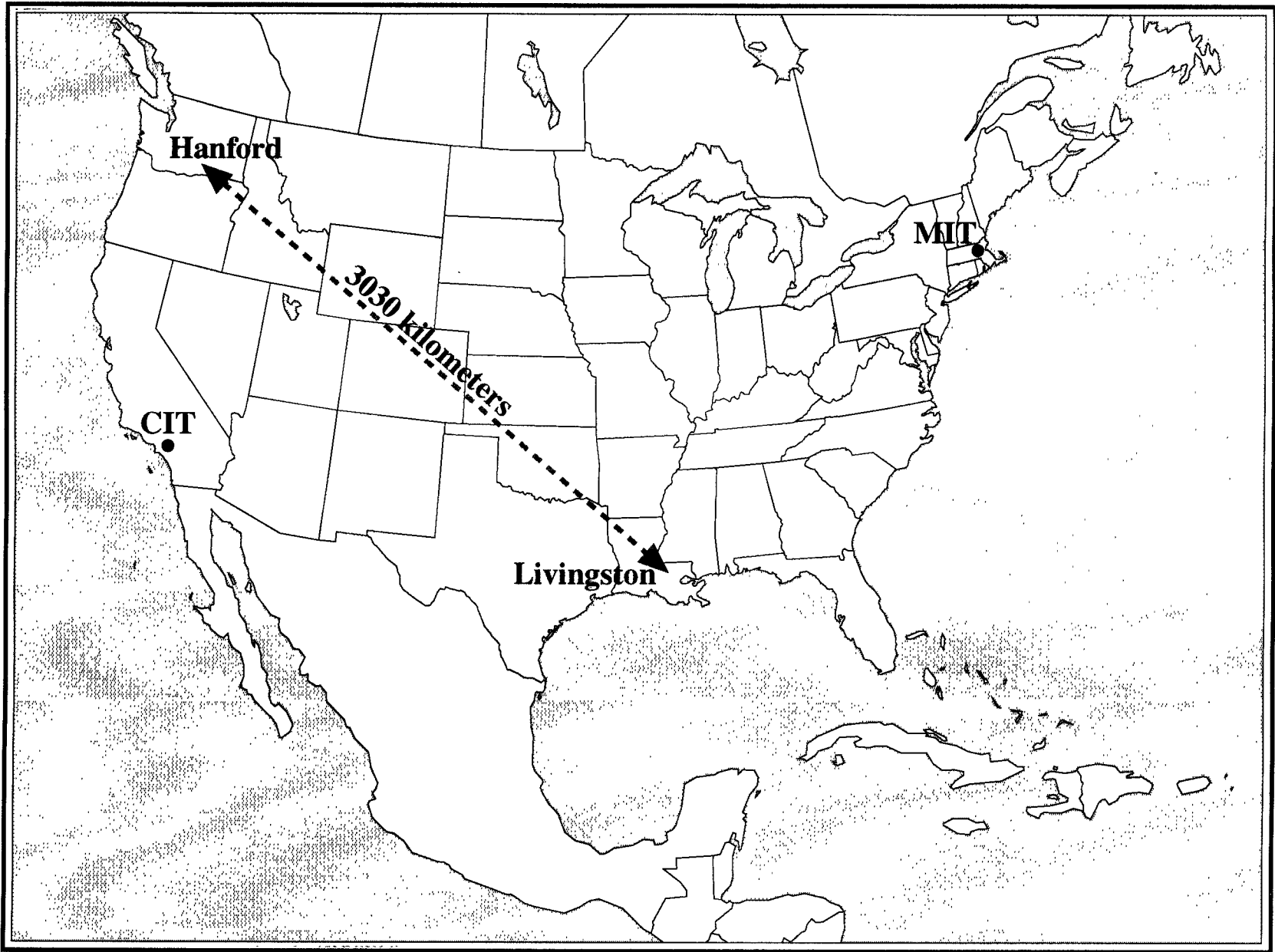

Figure 2.7 The sensitivity, as a function of direction, of an interferometric gravitational wave detector to unpolarized gravitational waves. The interferometer arms are oriented along the x and y axes.

Gravitational Wave Detector

- Antenna Pattern
 - » coordinate system





Interferometers

- $\Delta L/L = h = F_+ h_+(t) + F_x h_x(t)$

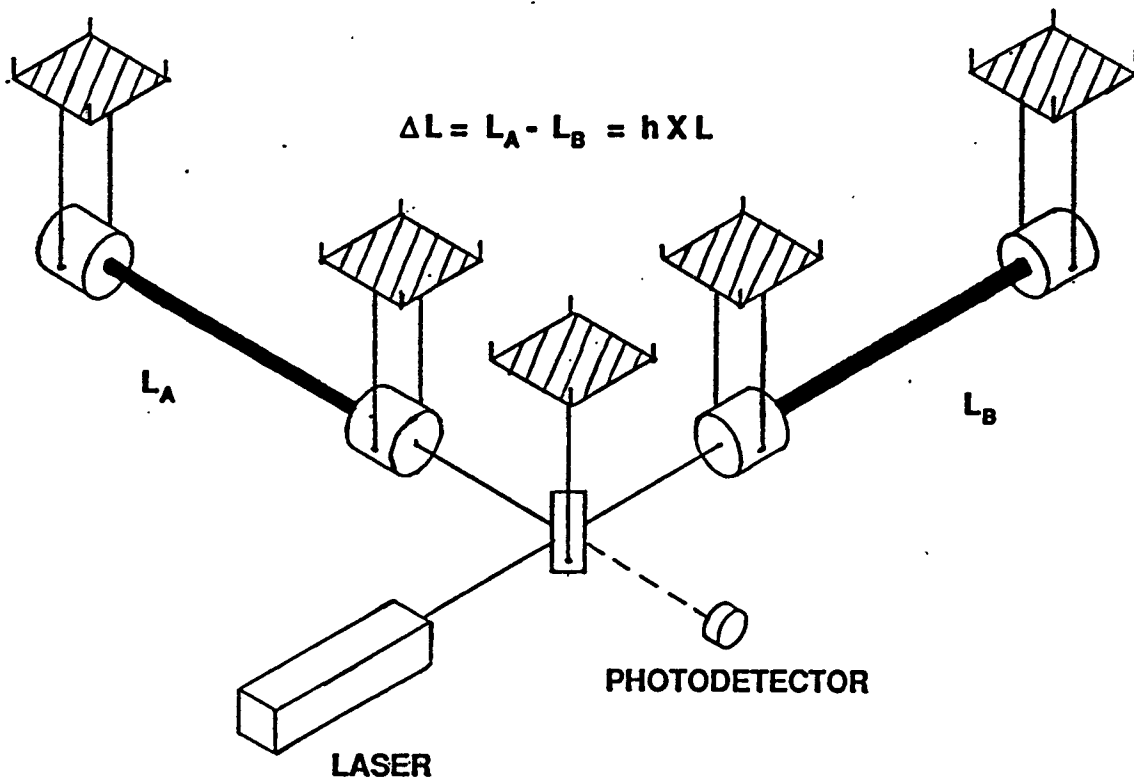

- LIGO Measures **one** waveform

- » orientation aligned (Washington & Louisiana)
- » direction(timing) determined $\sim 10'$ to $\sim 1^0$ on ring

- LIGO + VIRGO(Italy)

- » decompose waveforms ($h_+(t), h_x(t)$)
- » direction $10'$ to 1^0

Source Positions

- Celestial Sphere position location from LIGO (two interferometers)

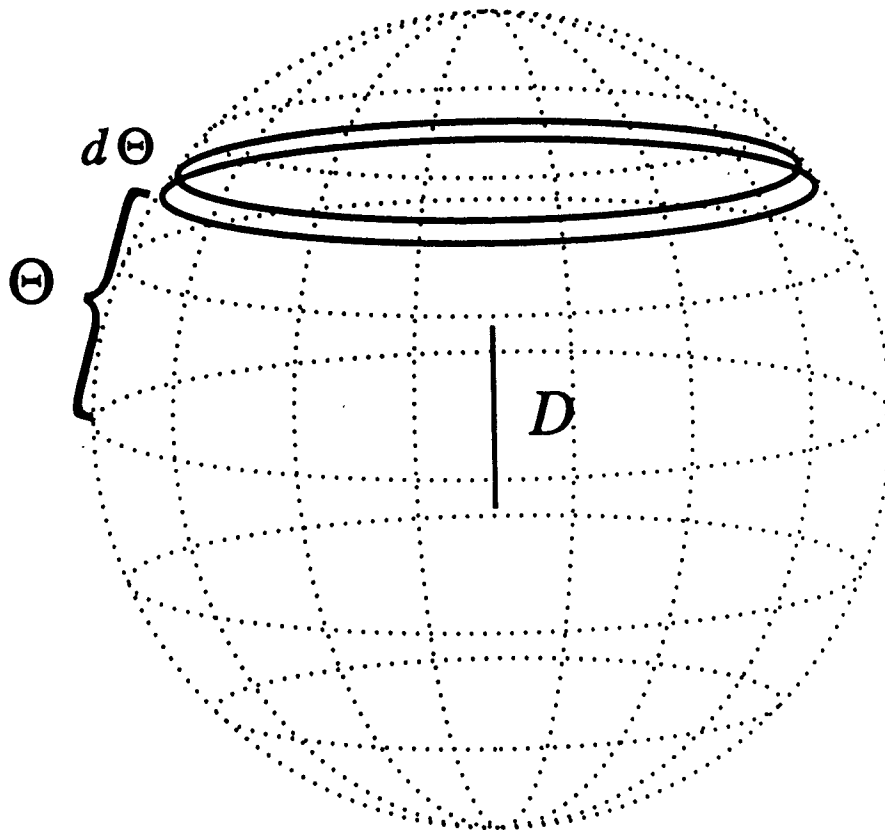

- determine from time shift between detectors ($\sim .1$ msec accuracy)
- ‘declination angle’ of circle (ring)

$$\Theta = \arcsin \frac{c\Delta t_{sig}}{D}$$

Source Positions

LIGO + VIRGO

- LIGO (2 det) + VIRGO (1 det)
- decomposition of waveforms
 - » $h_x(t)$, $h_+(t)$
- position on sky (two positions)

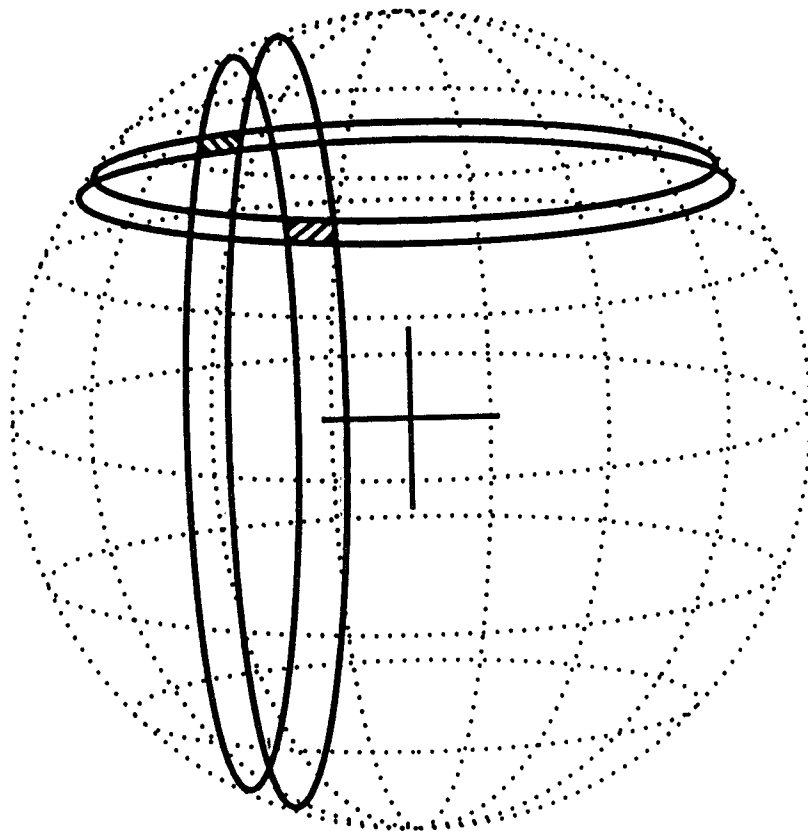

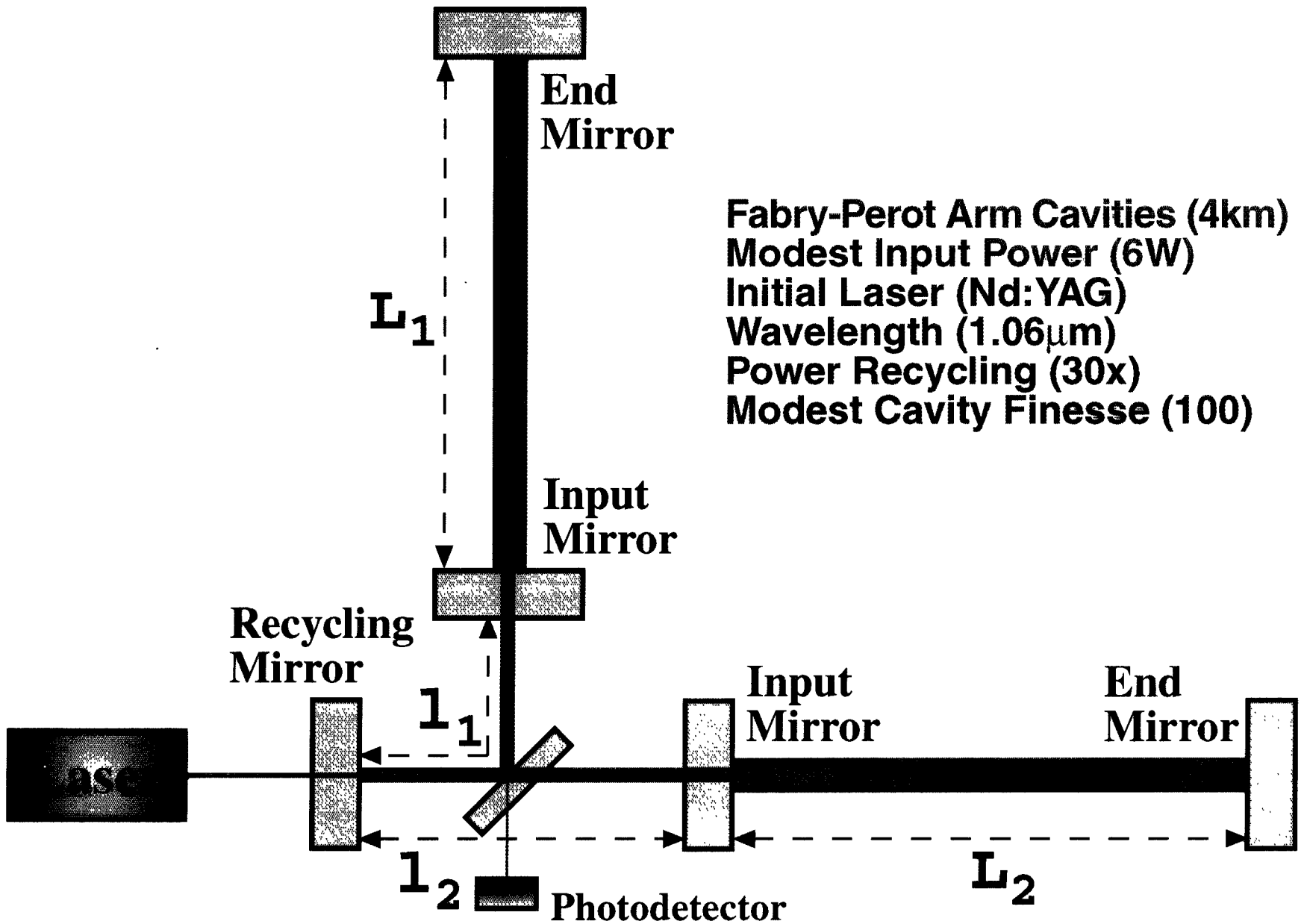

Initial Interferometer Specifications

Strain Sensitivity [rms, 100 Hz band]	10^{-21}
Displacement Sensitivity [rms, 100 Hz band]	$4 \times 10^{-18} \text{ m}$
Fabry-Perot Arm Length	4000 <i>m</i>
Vacuum Level	$< 10^{-6} \text{ torr}$
Laser Wavelength	1064 <i>nm</i>
Optical Power at Laser Output	10 <i>W</i>
Optical Power at Interferometer Input	5 <i>W</i>
Power Recycling Factor	30
Input Mirror Properties	Reflectivity = 0.97
End Mirror Properties	Reflectivity > 0.9998
Arm Cavity Optical Loss	$\leq 3\%$
Light Storage Time in Arms	1 <i>ms</i>
Test Masses	Fused Silica, 11 <i>kg</i>
Mirror Diameter	25 <i>cm</i>
Test Mass Period Pendulum	1 <i>sec</i>
Seismic Isolation System	Passive, 4 stage
Seismic Isolation System Horizontal Attenuation	$\geq 10^{-7}$ (100 <i>Hz</i>)
Maximum Background Pulse Rate	1 <i>per minute</i>

Initial Interferometers

Noise Floor

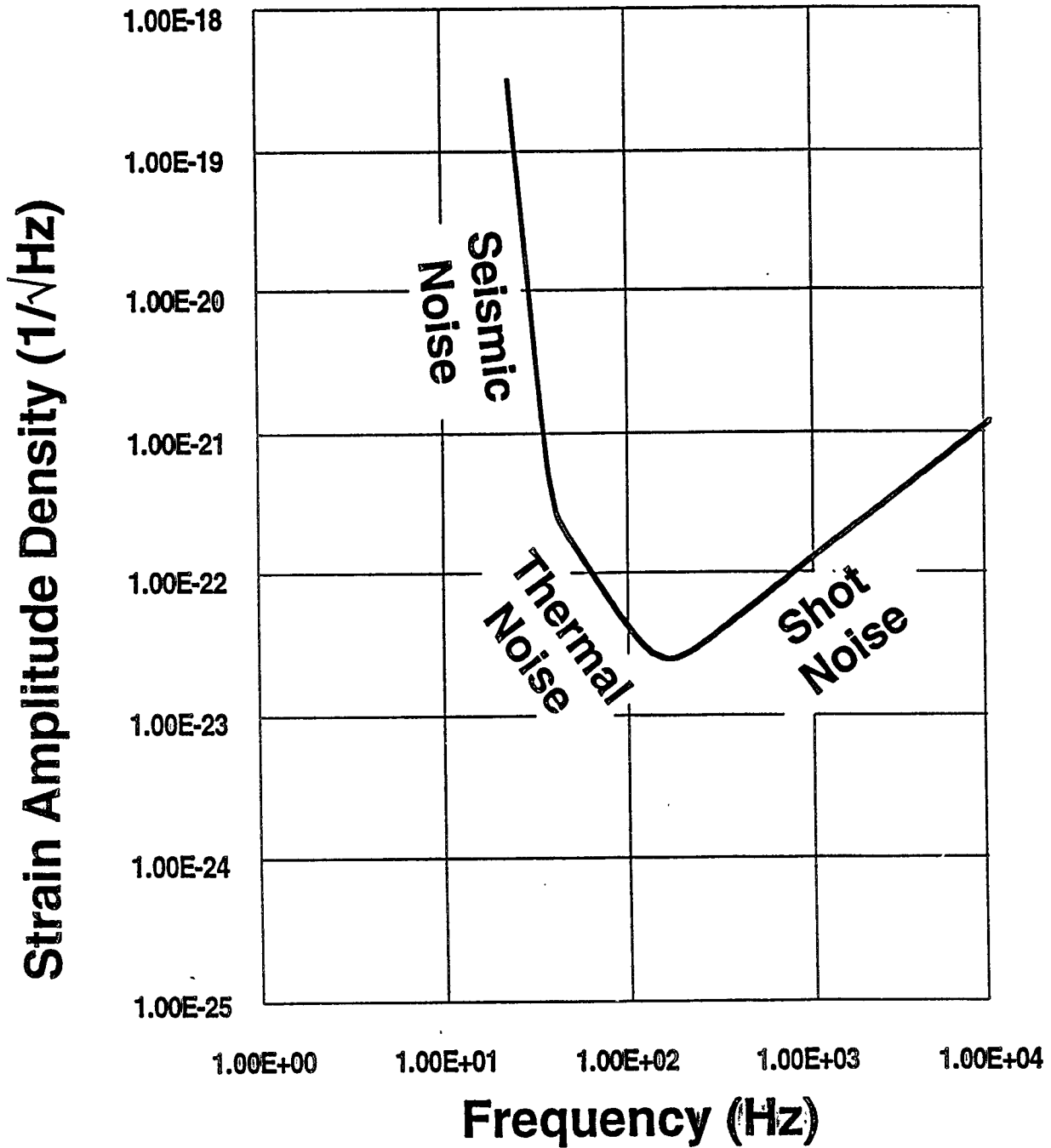

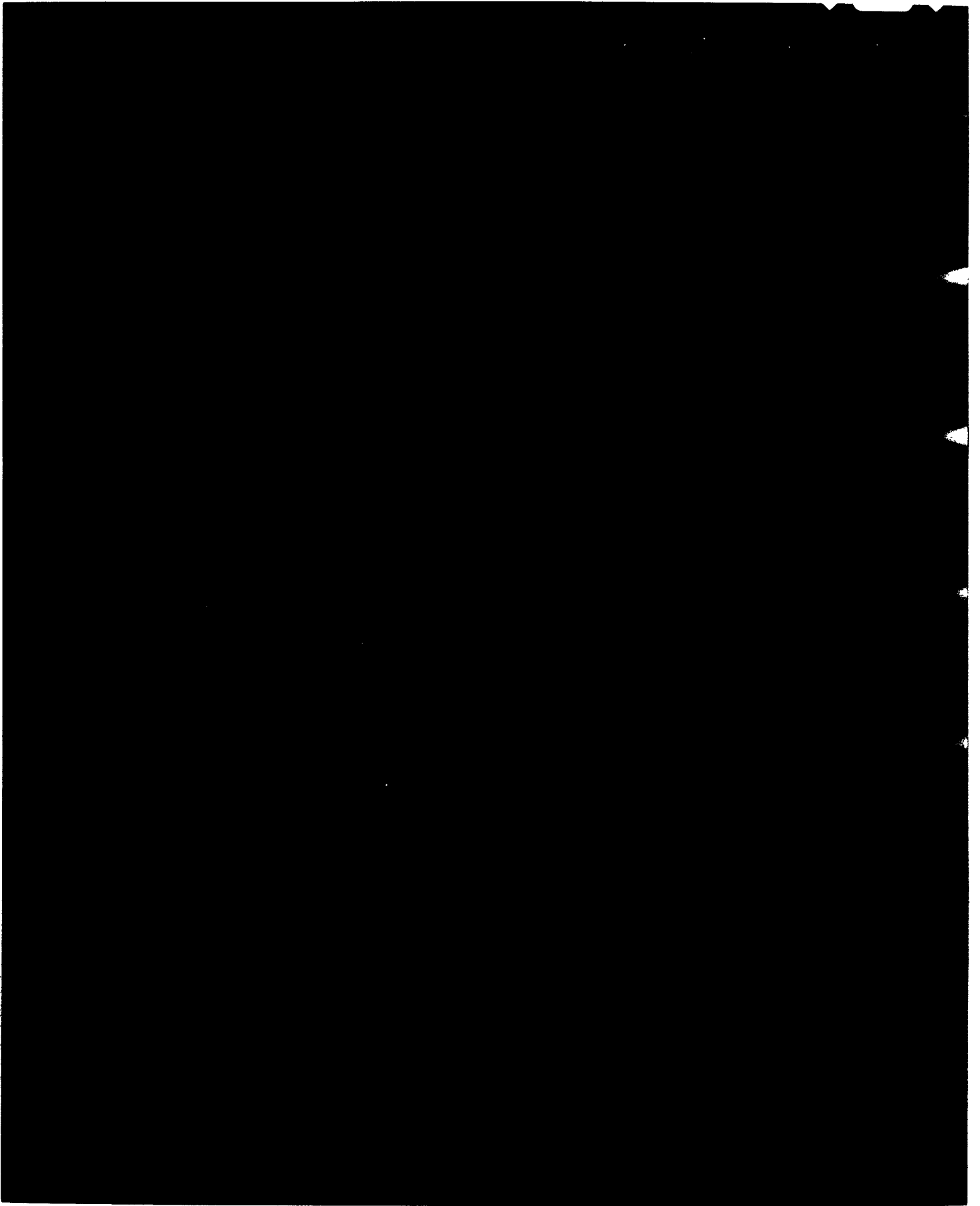

Displacement Sensitivity of 40-Meter Interferometer

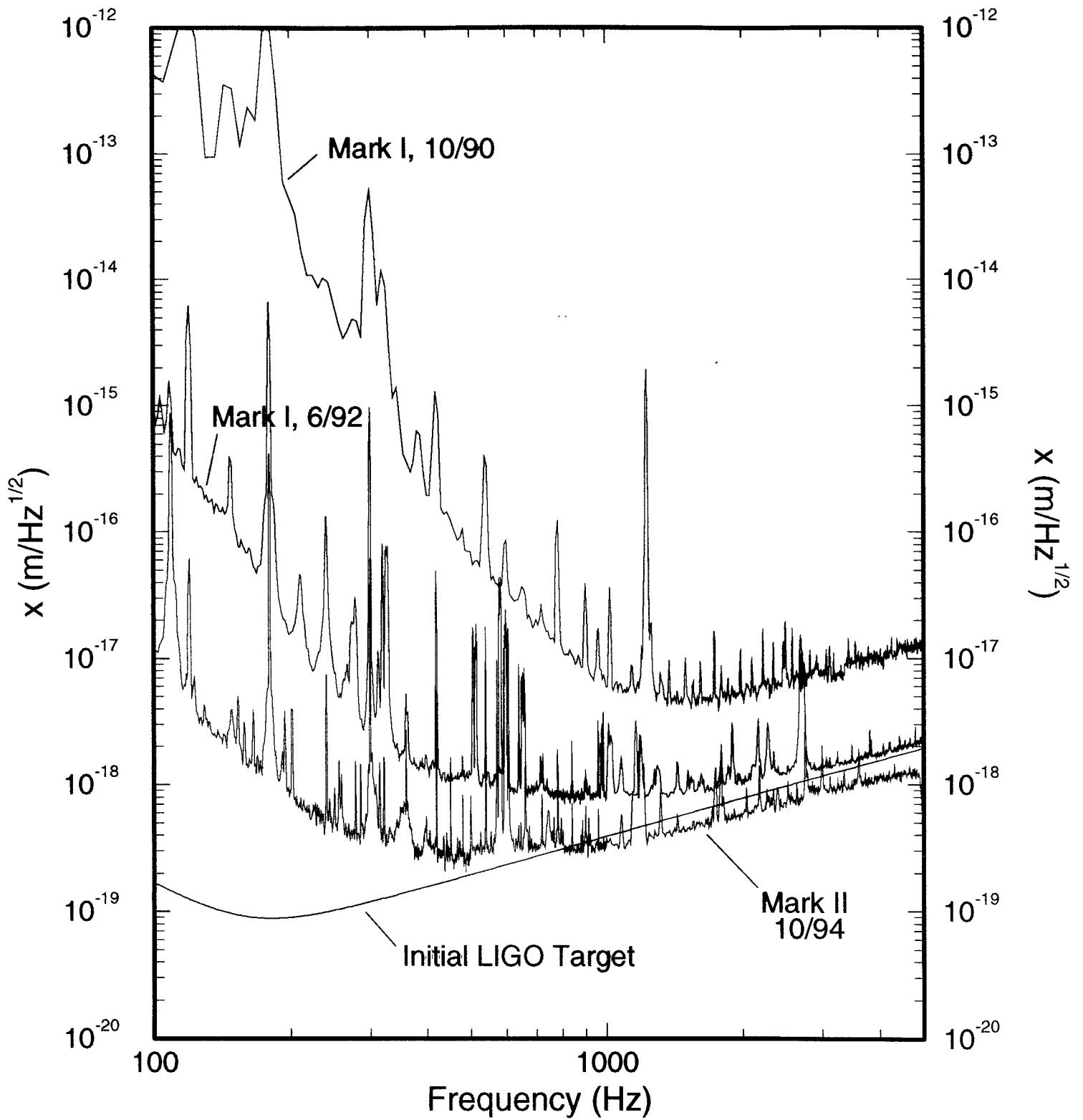

Phase Noise Sensitivity From MIT Interferometer

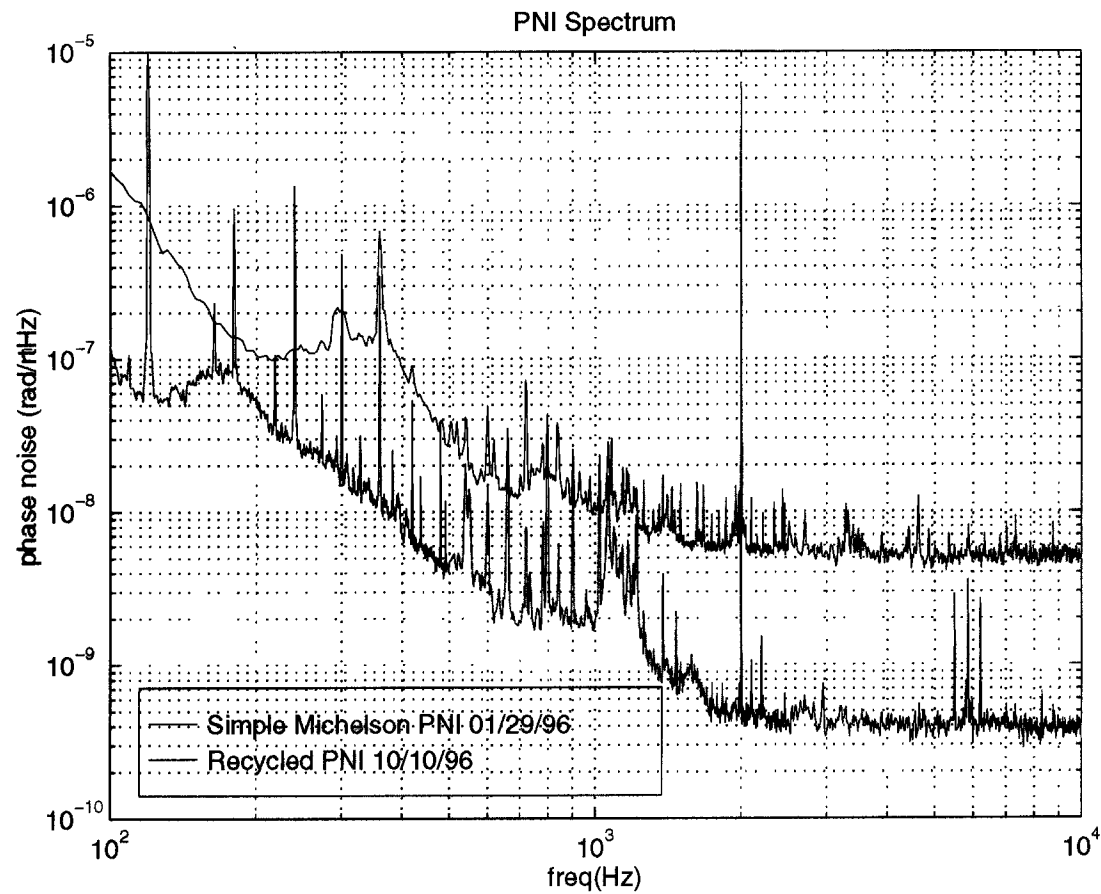

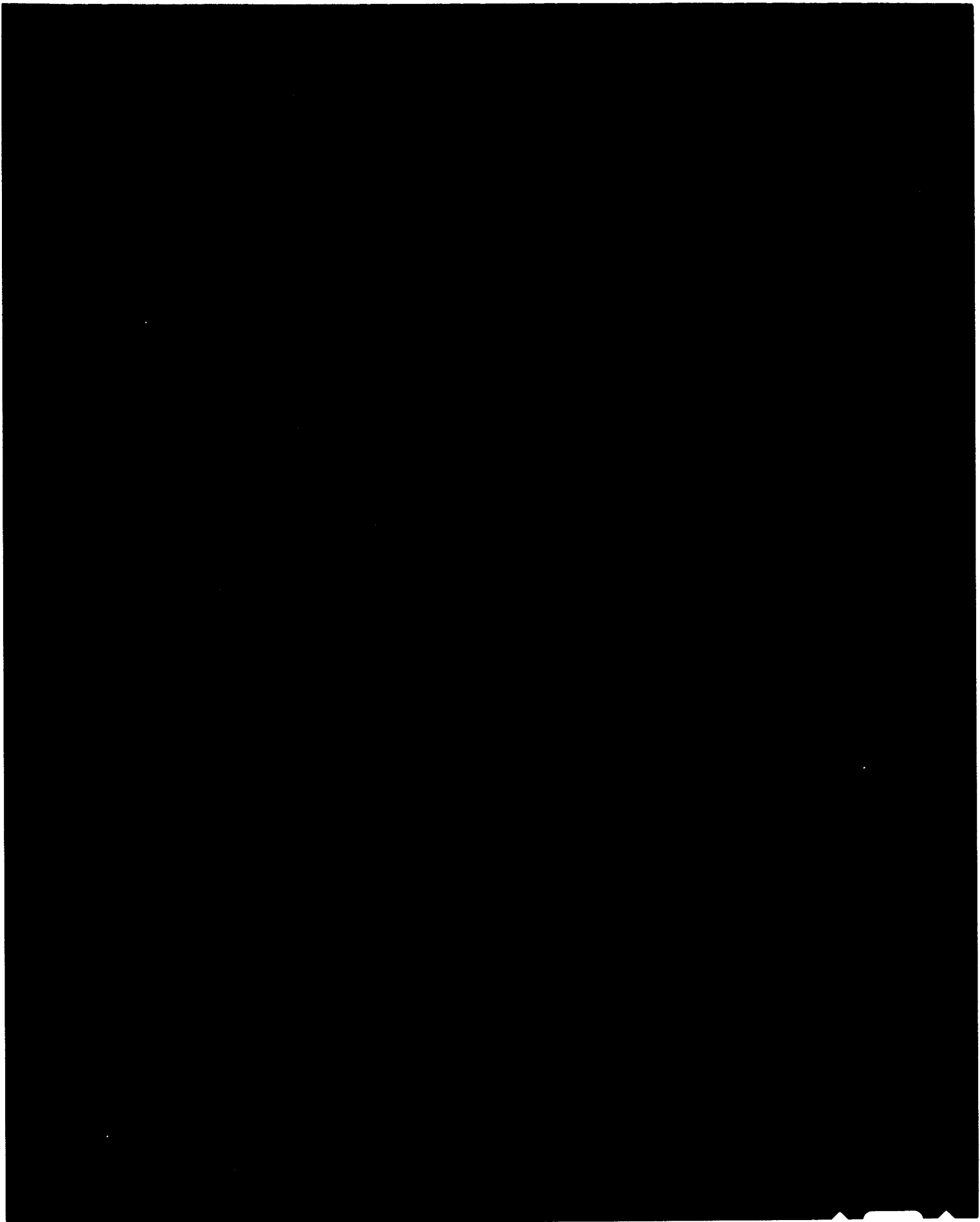

NEUTRON STAR BINARIES

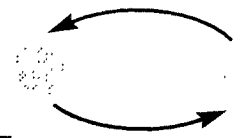

[“Near-Guaranteed” source]

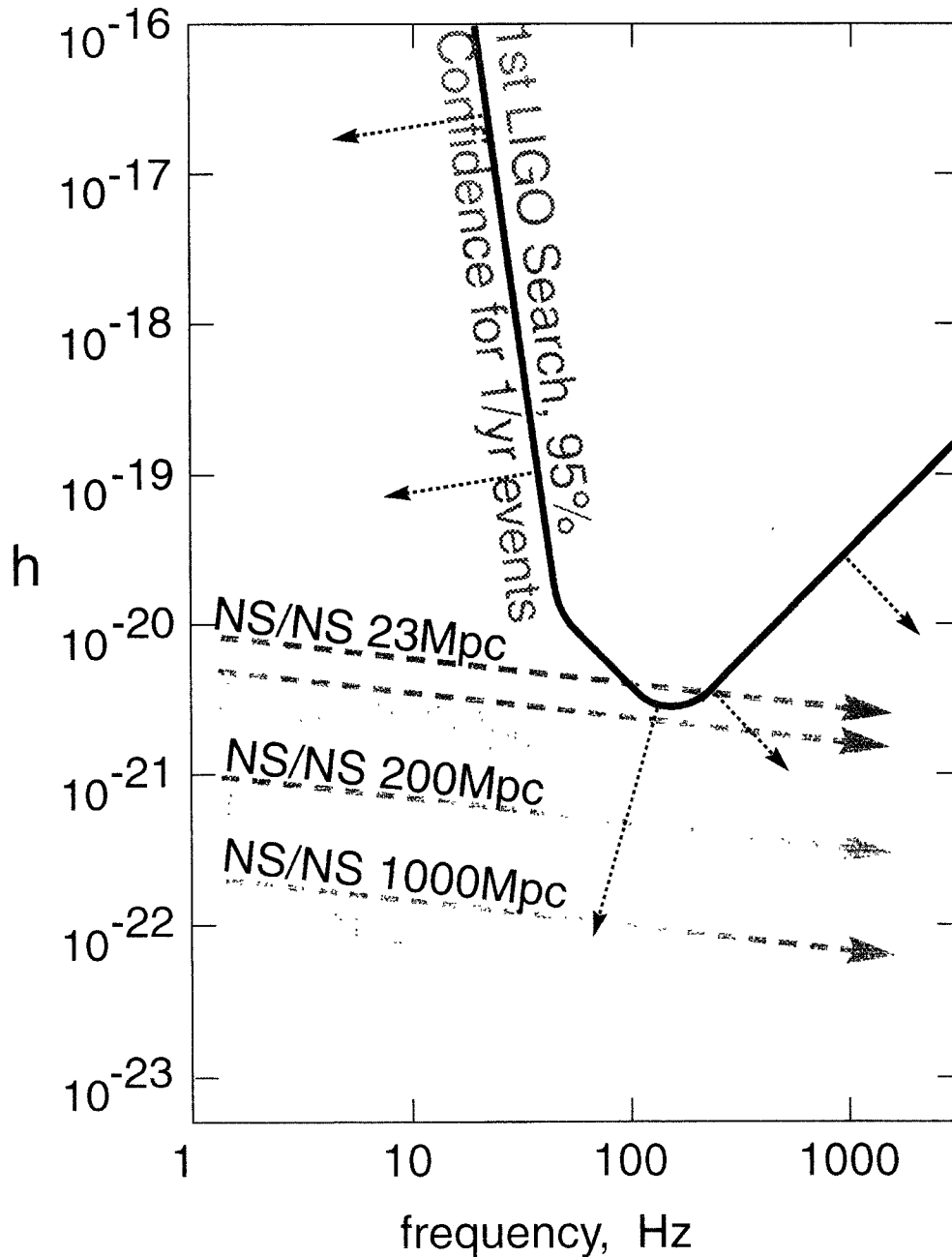

■ 15 minutes & 10,000 orbits in LIGO band

■ Rich information in waveforms:
masses, spins, distance, direction,
nuclear equation of state

Steps in the Advanced Subsystems Research

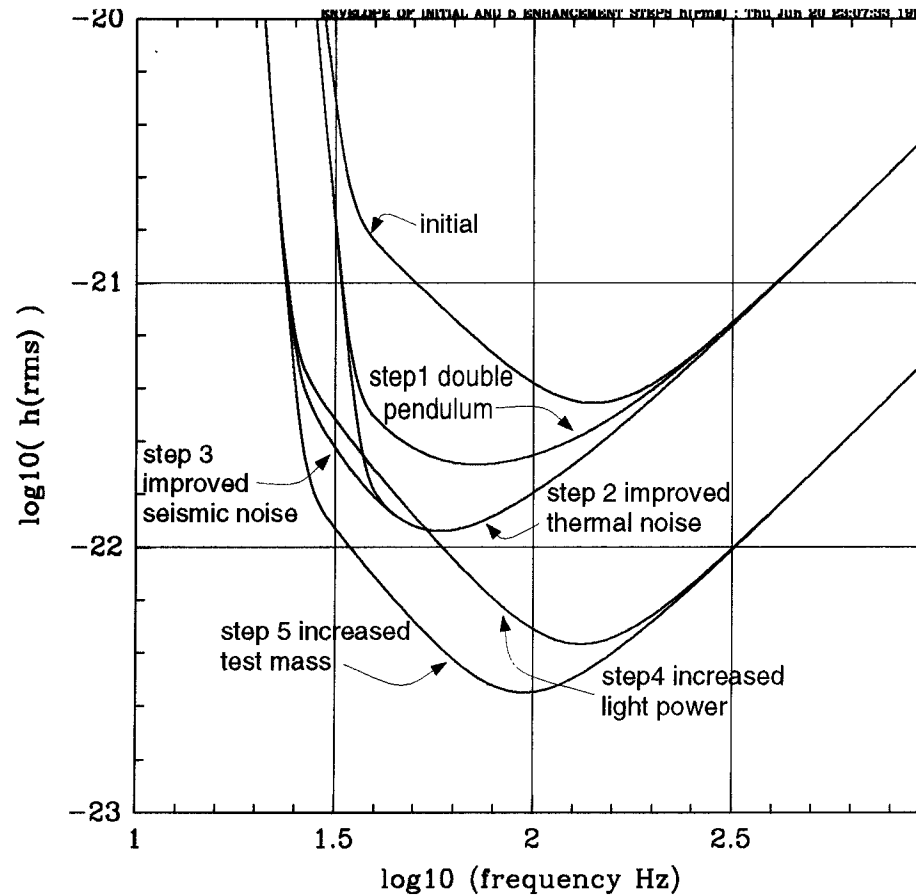

h_{rms} Noise Envelopes for Initial LIGO and Advanced Subsystems/Detectors

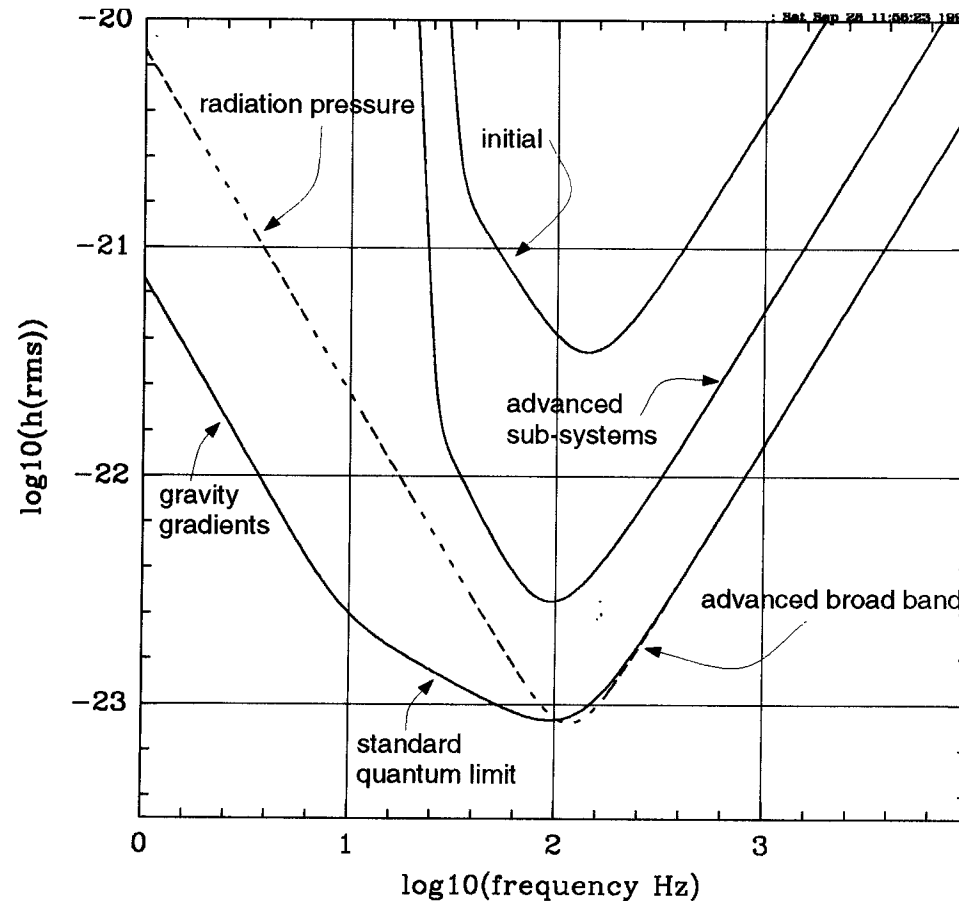

BB
AHM

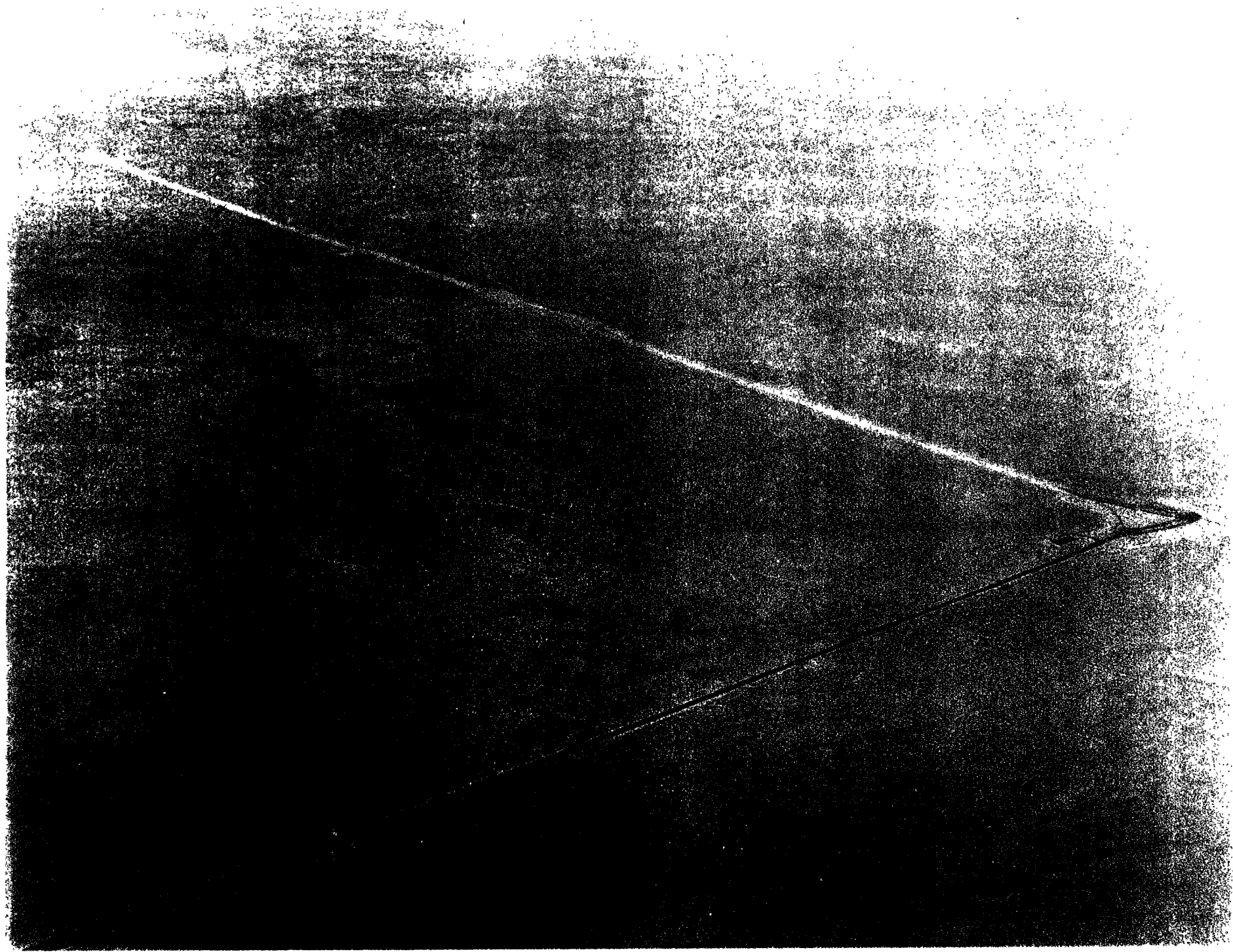

Beam Tube

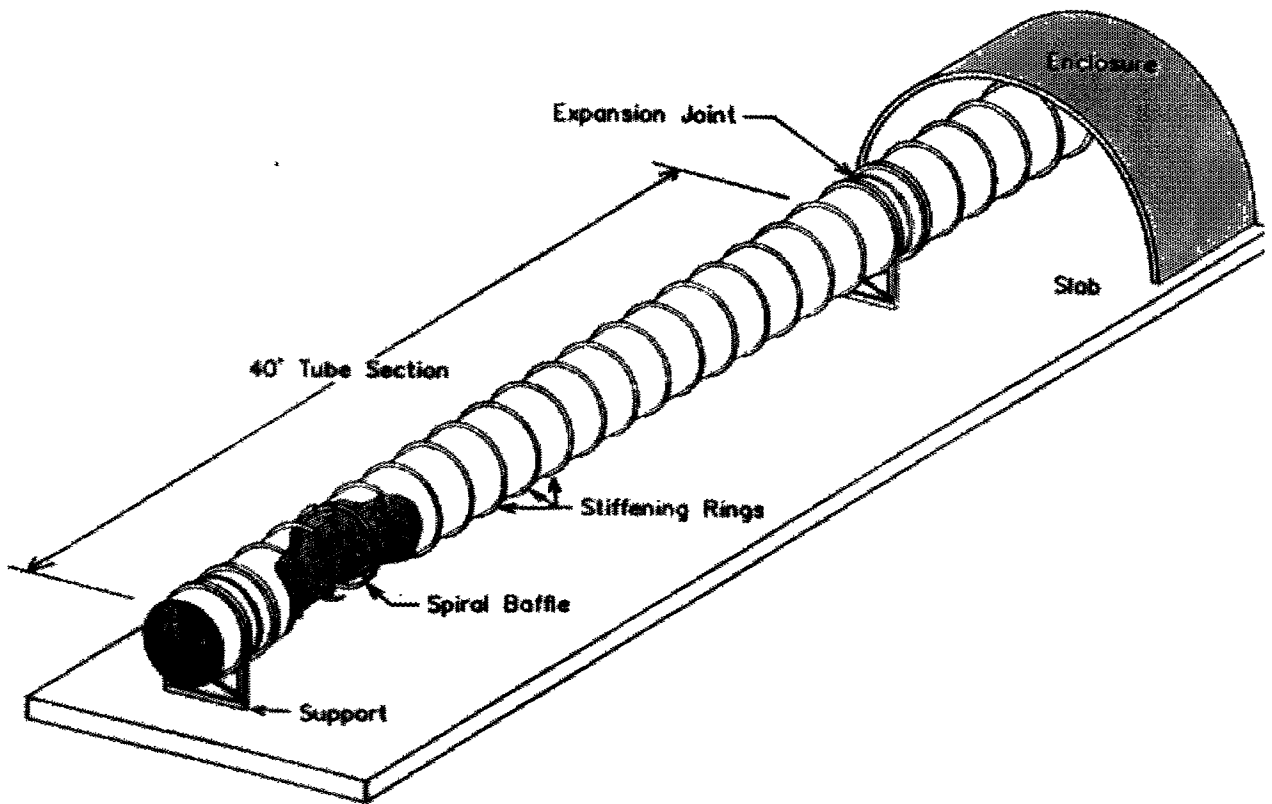

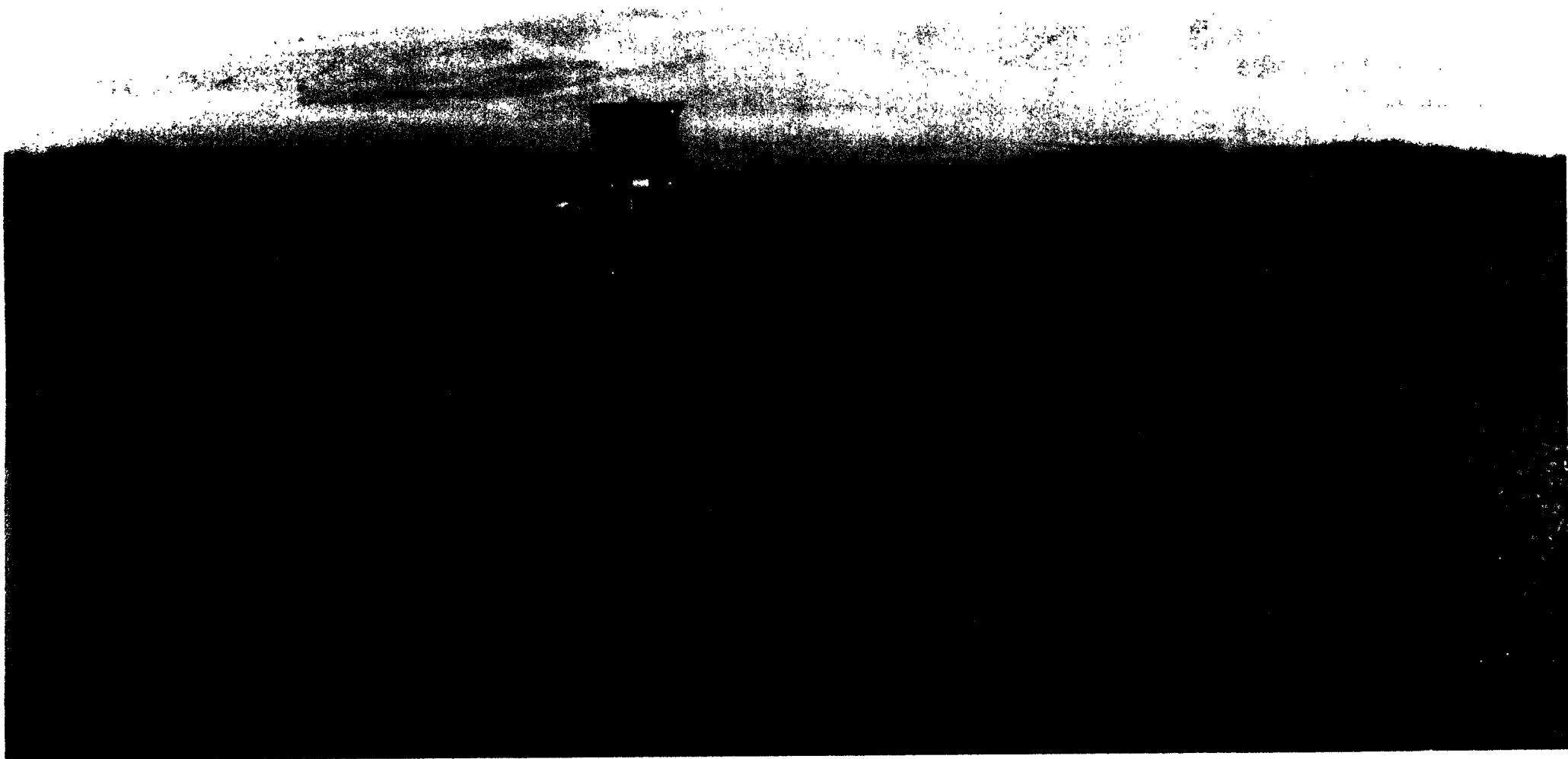

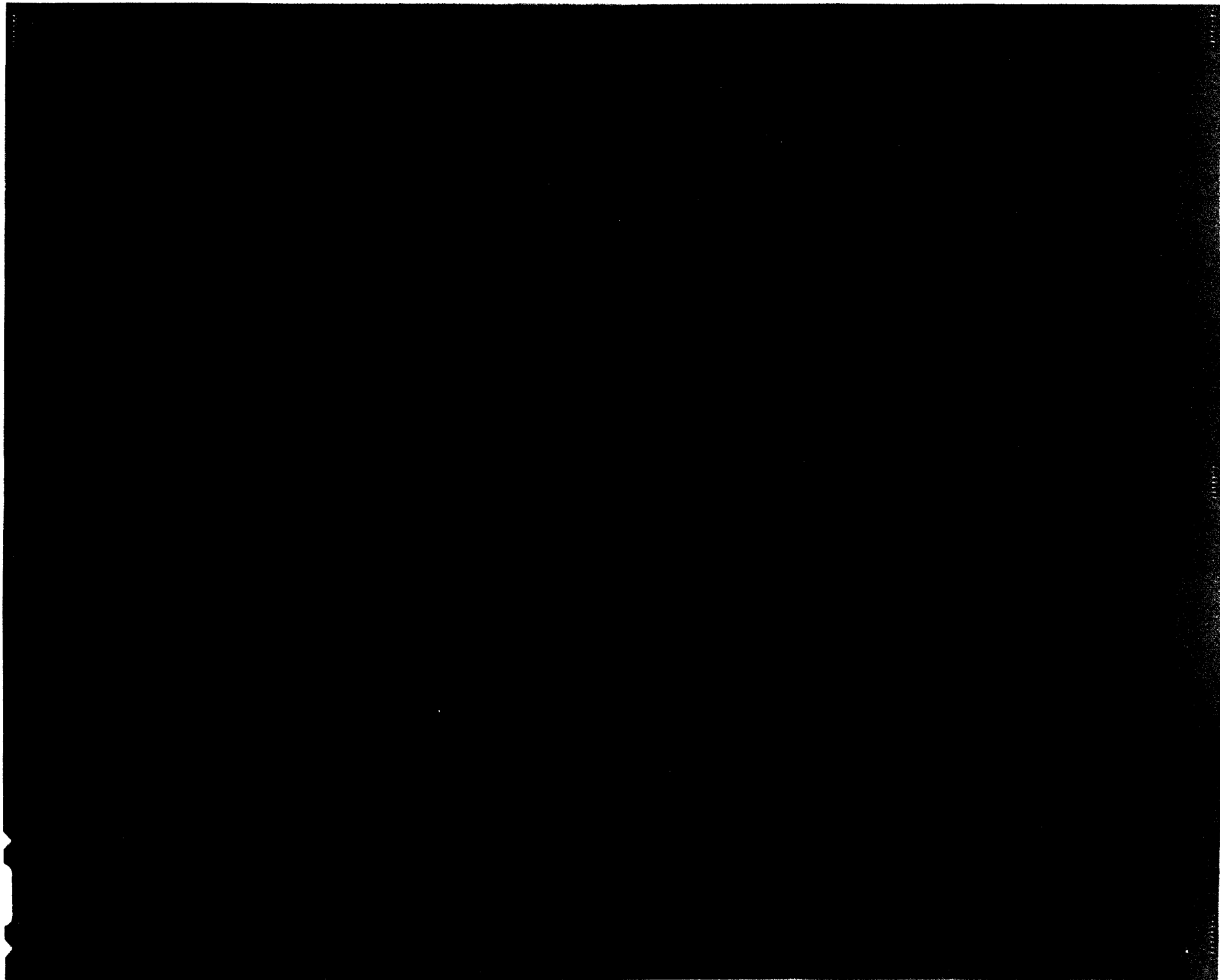

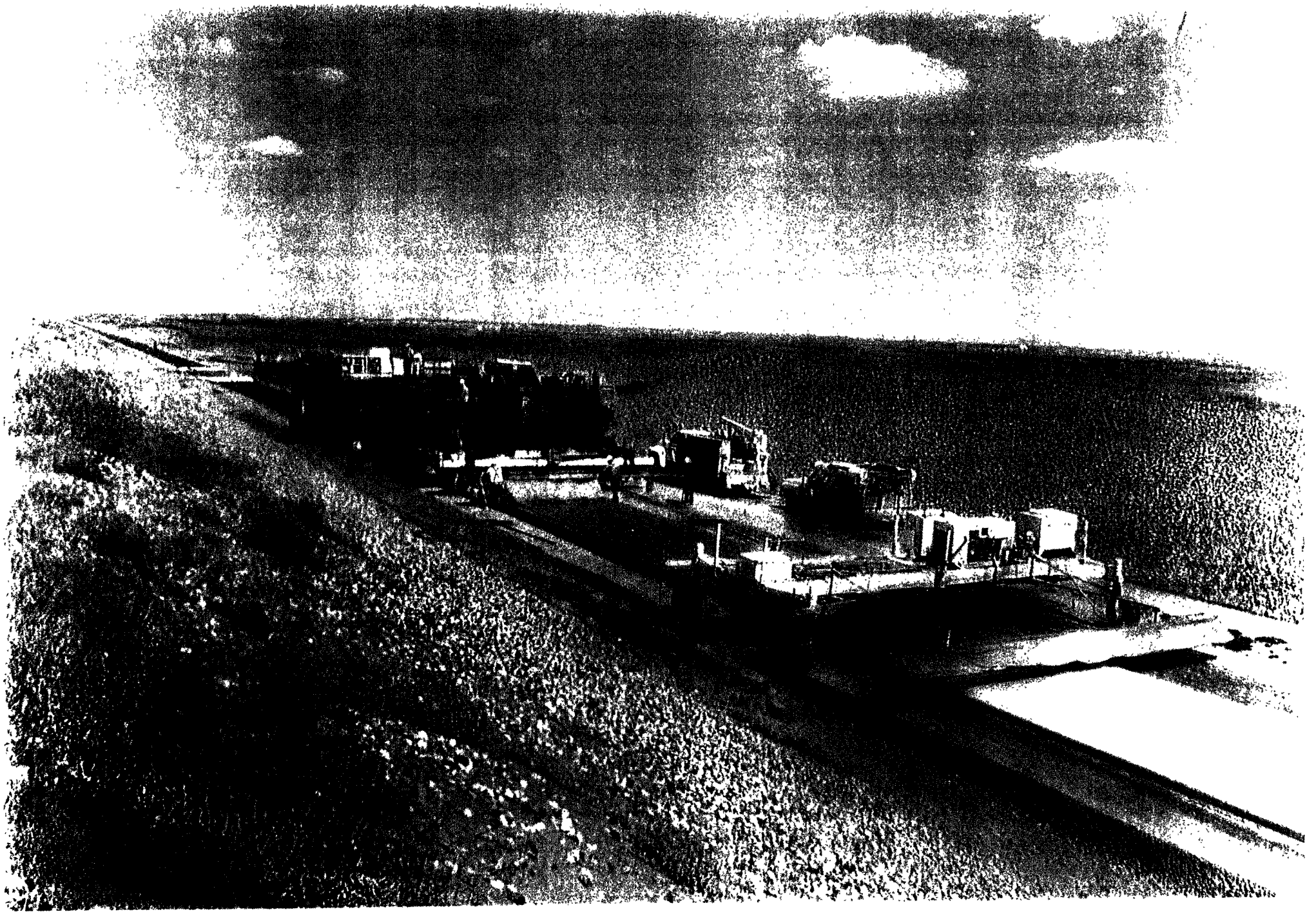



LIGO Facilities

Beam Tube Enclosure

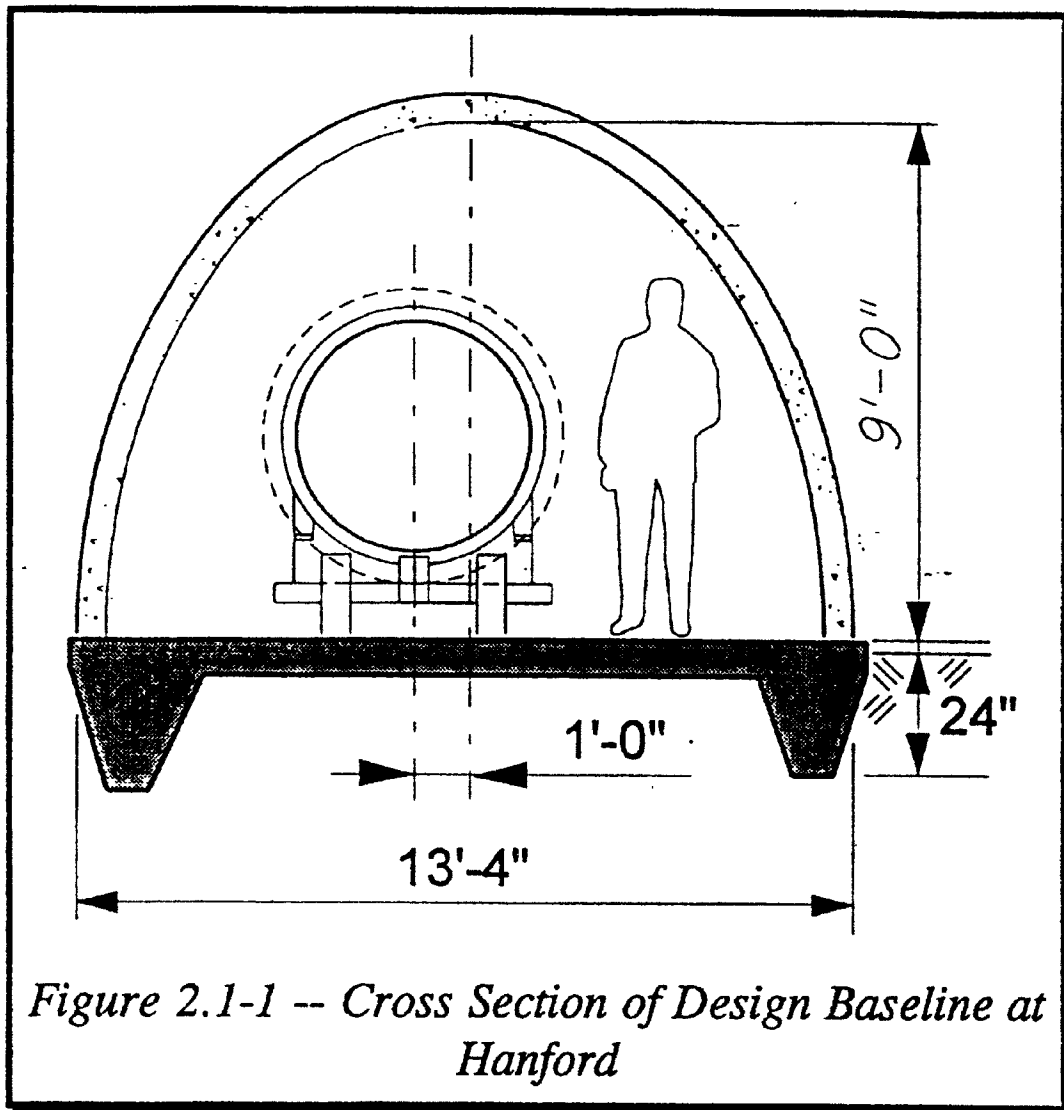
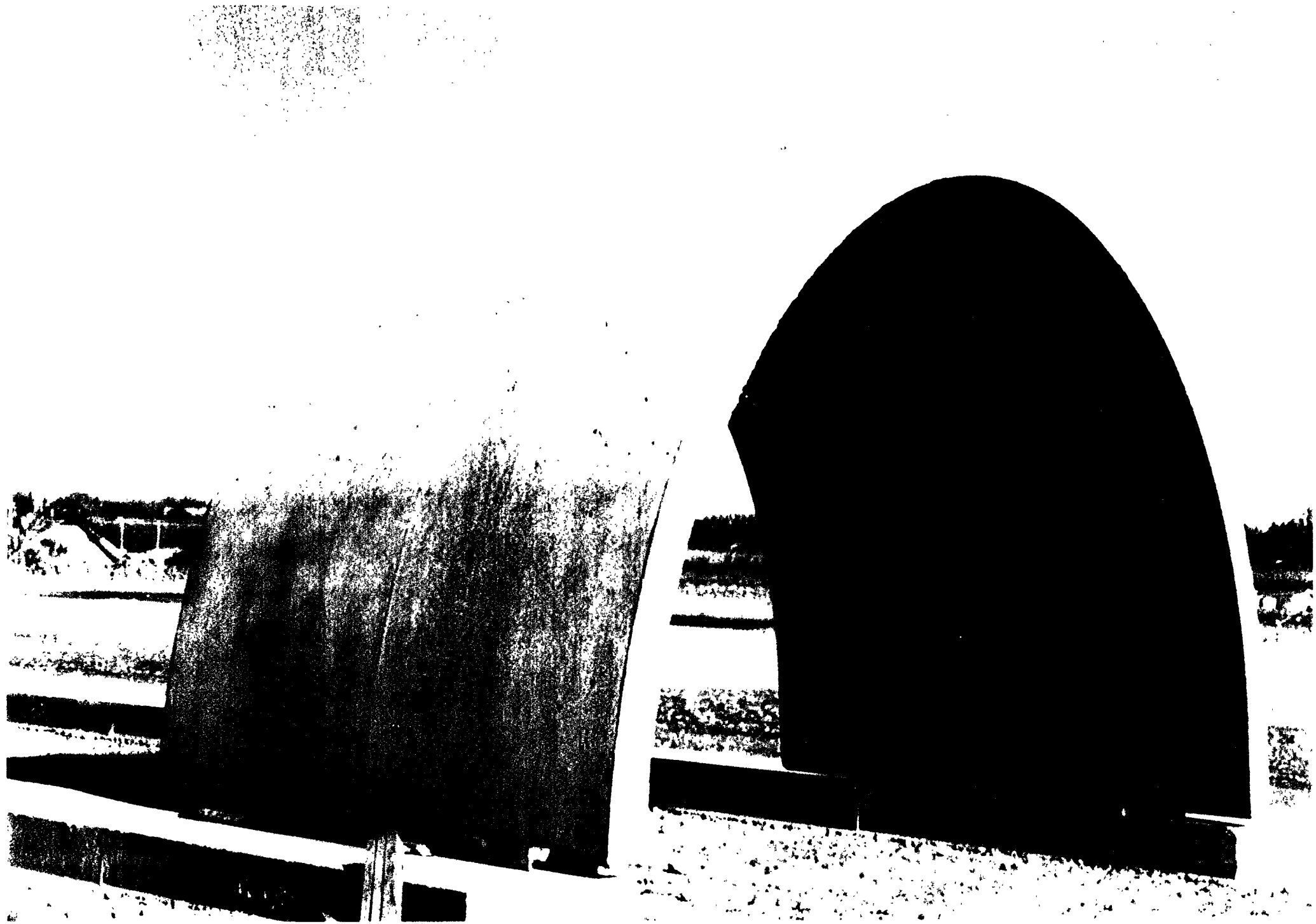
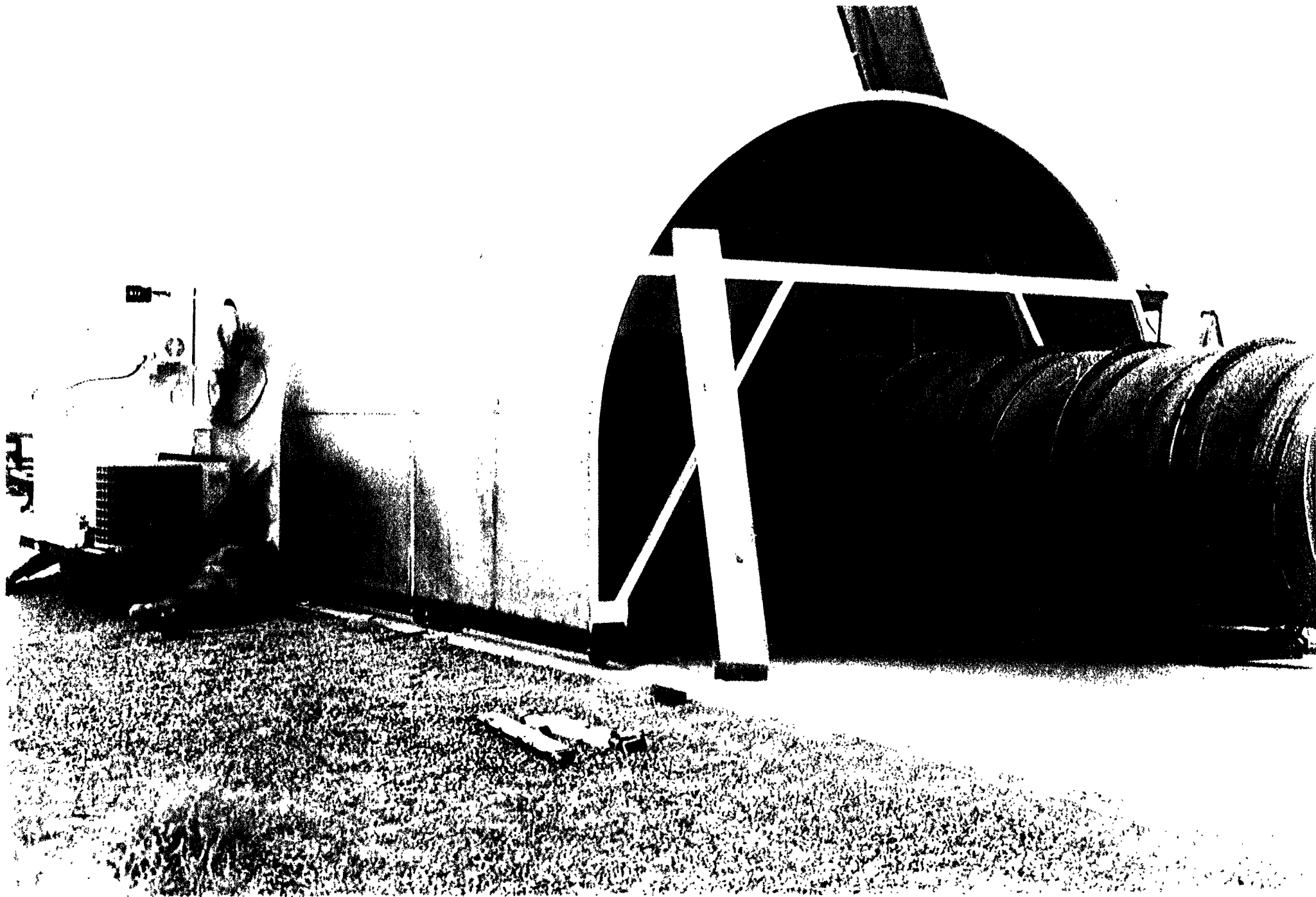
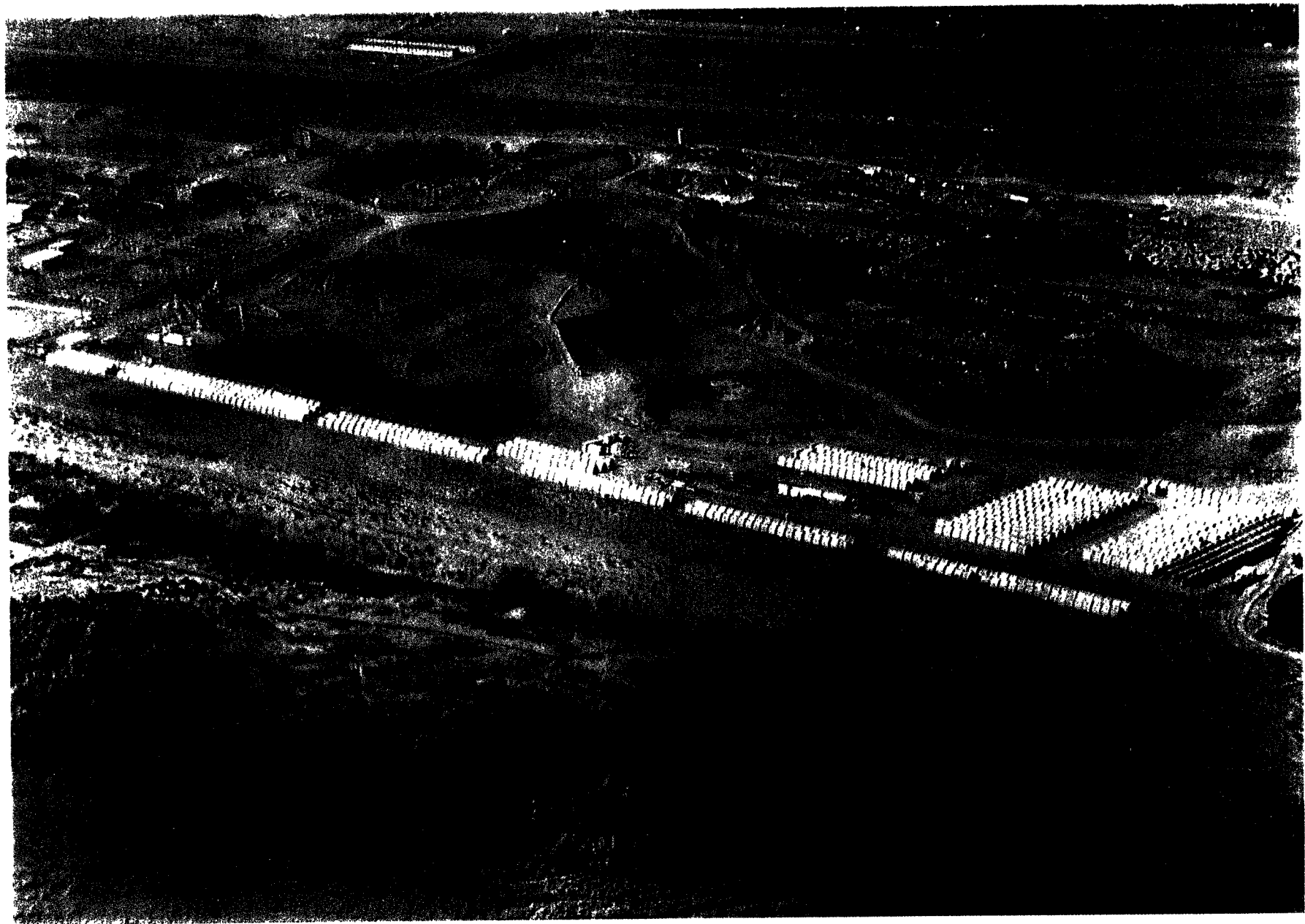
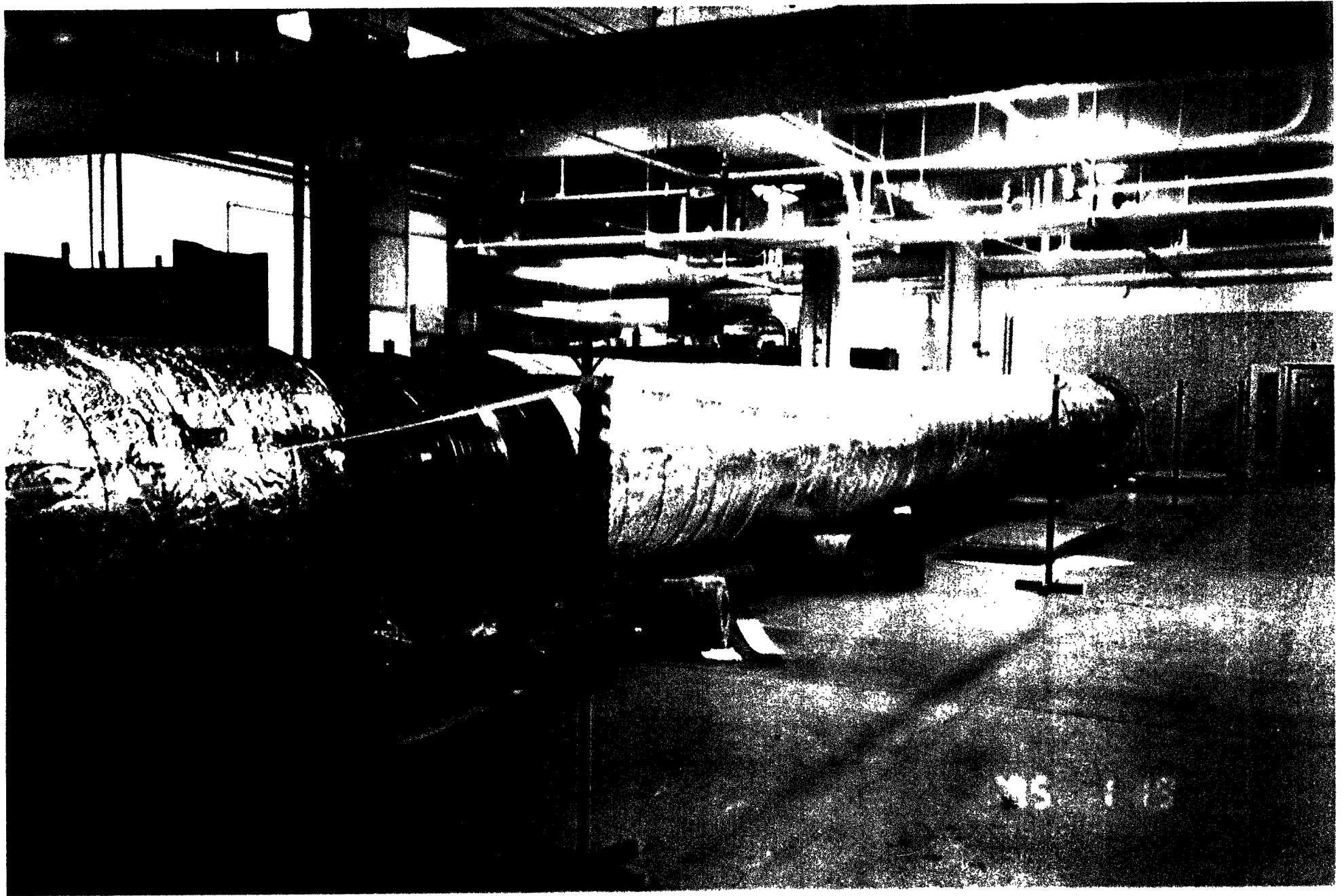

Figure 2.1-1 -- Cross Section of Design Baseline at Hanford









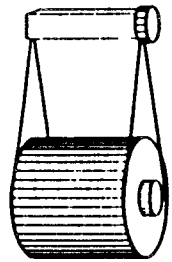

1

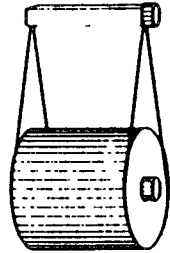

2



3

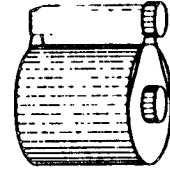

4



5



6

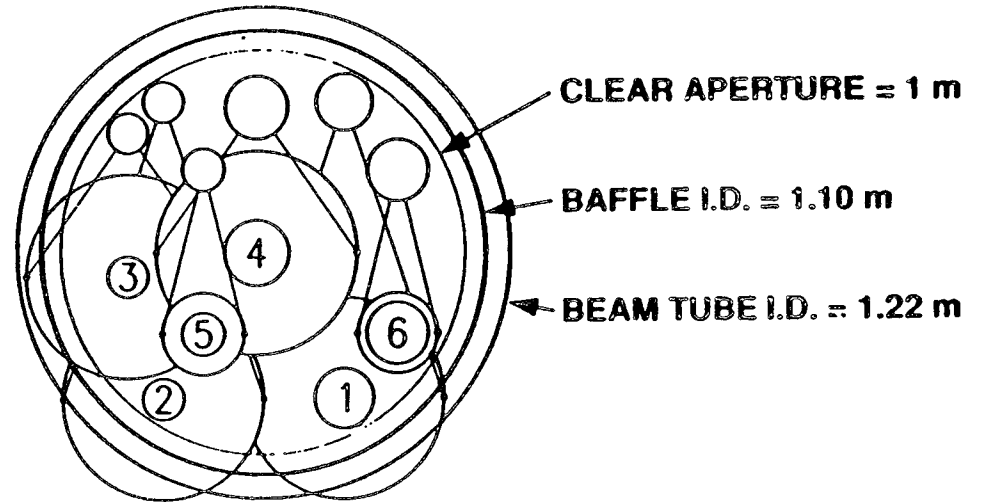
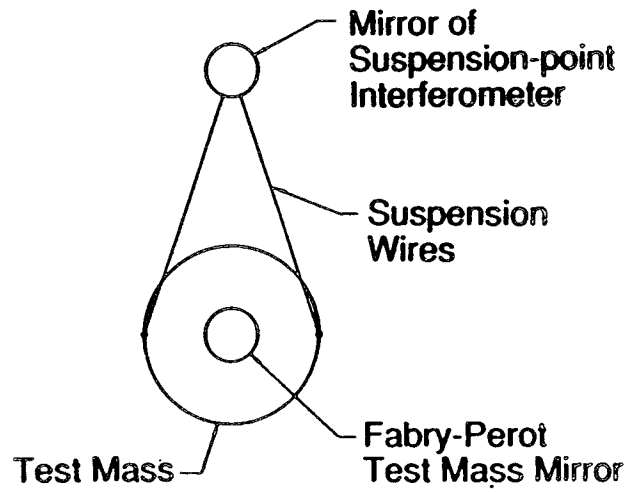

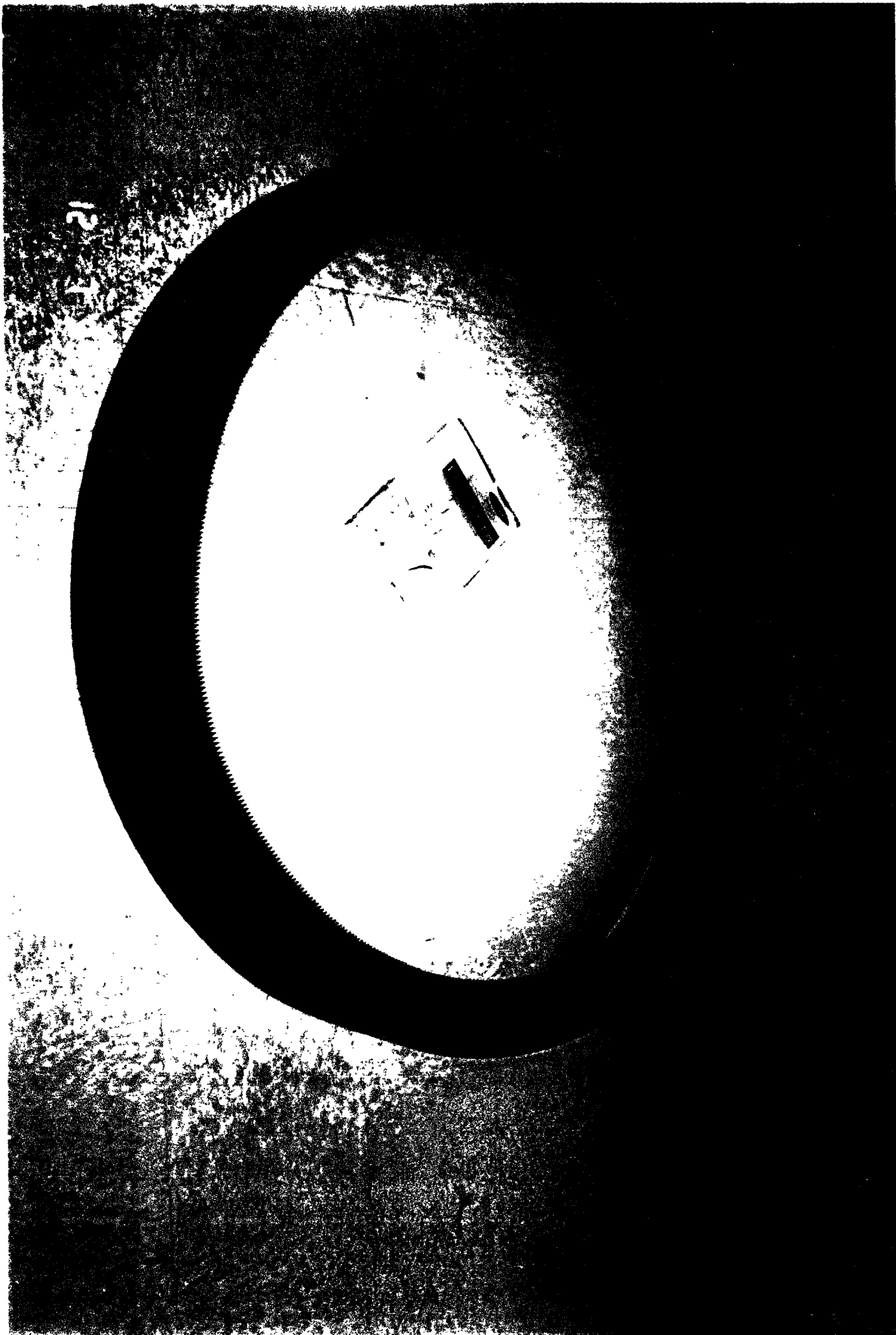

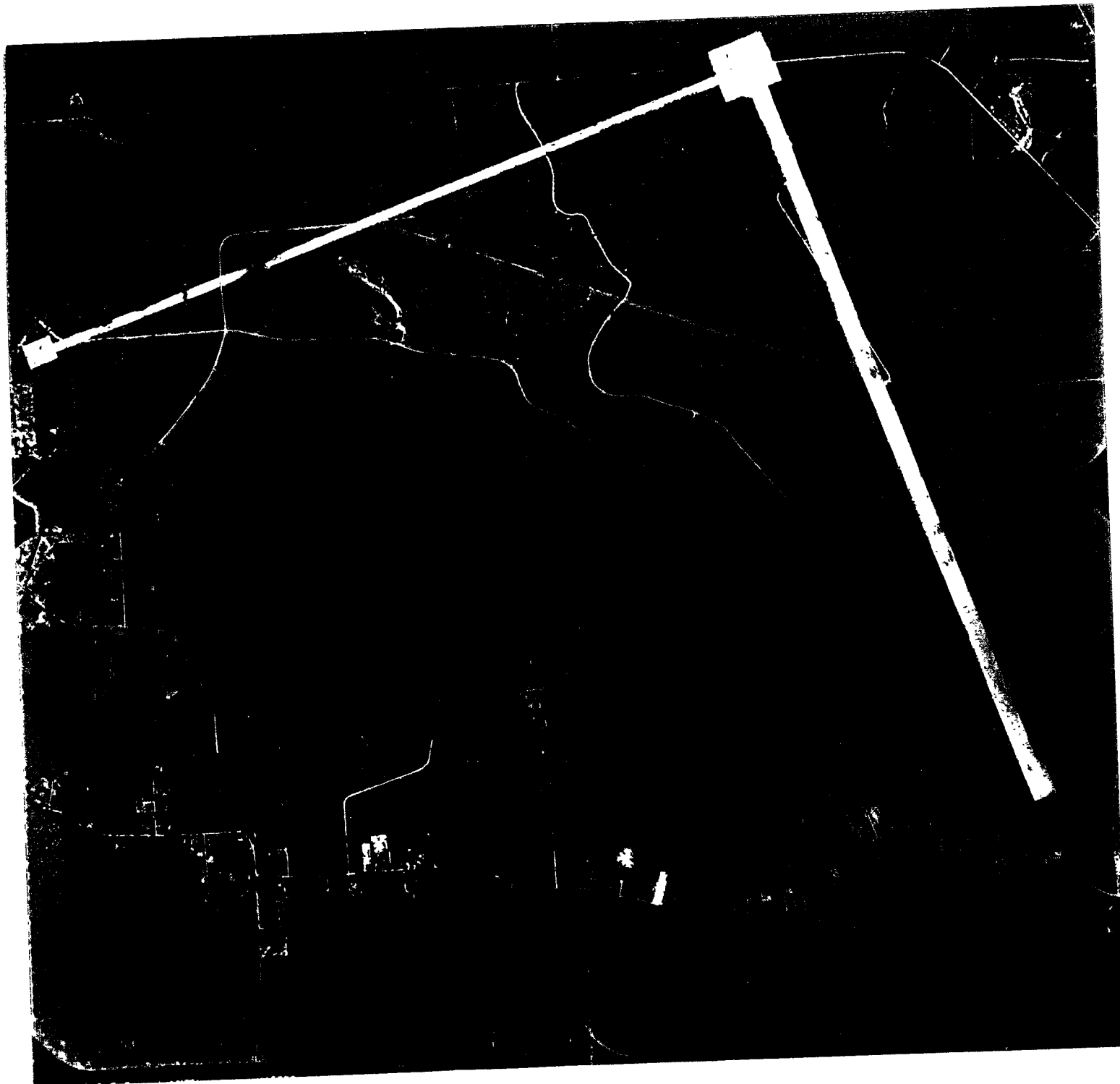

LIGO

LIVINGSTON PARISH

LOUISIANA

1A

AERIAL PHOTO BY:

GULF COAST AERIAL MAPPING

FLOWN: AUGUST 25, 1995

ALTITUDE: 12,000 FEET



G960028-17-O-V



0060017-010

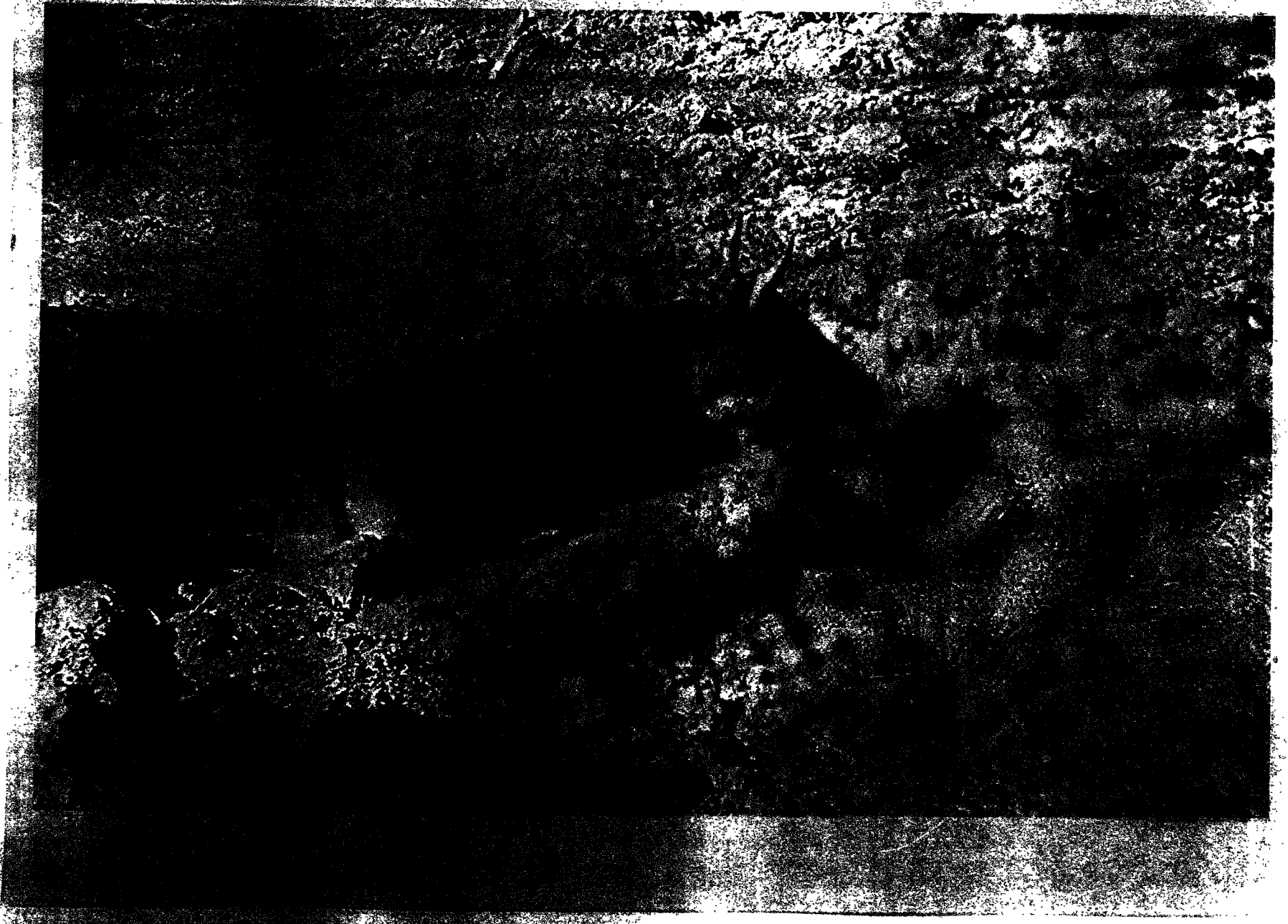

Conclusions

- LIGO Construction is well Underway
- Direct Detection of Gravitational Waves Appears Realistic within 10 years
- Ultimate Sensitivities Capable of Opening a New Field of Observational Astronomy with Gravitational Waves is the Long Term Goal.

NEUTRON STAR BINARIES

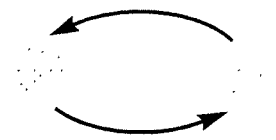

[“Near-Guaranteed” source]

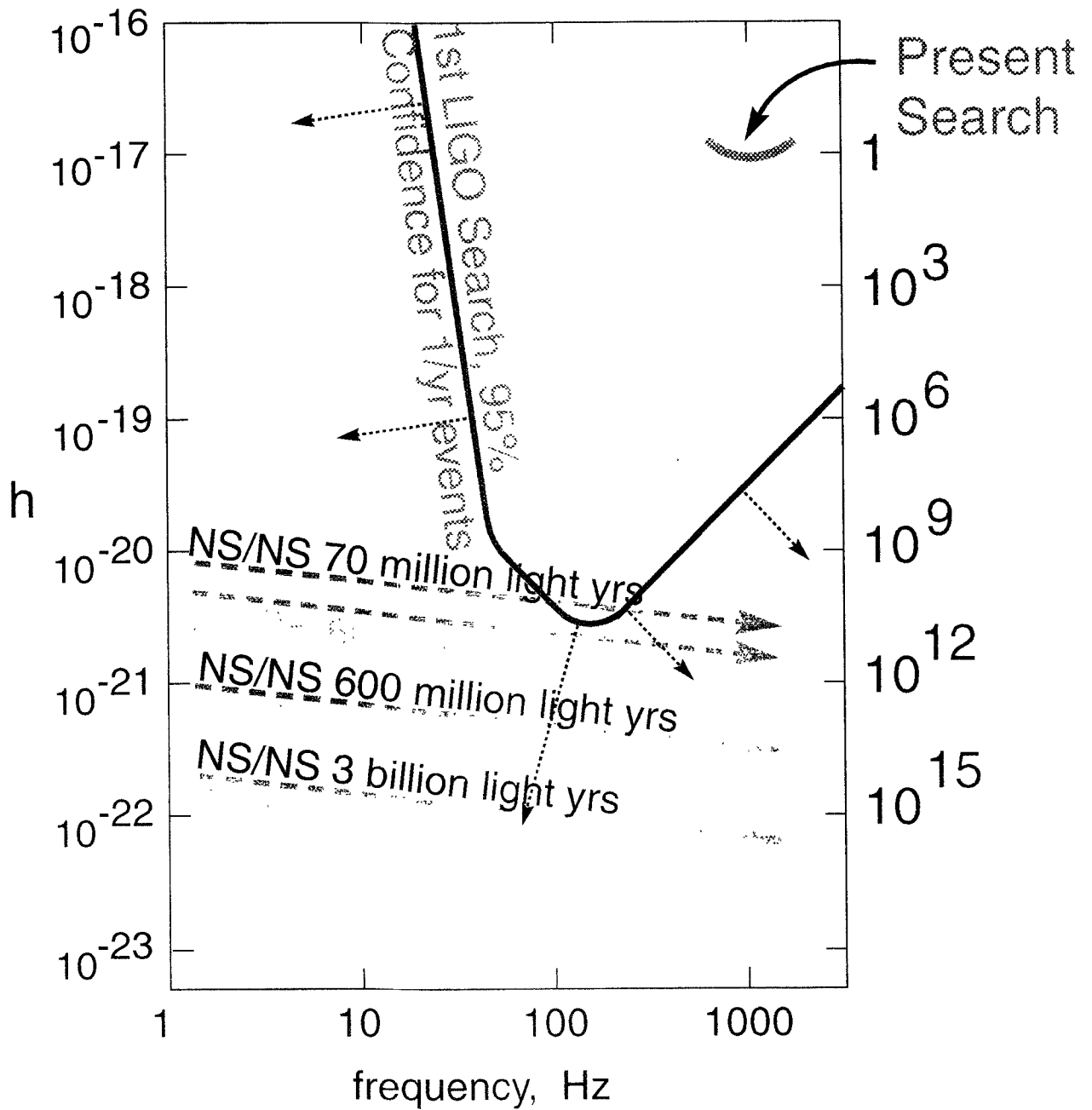

15 minutes & 10,000 orbits in LIGO band

Rich information in waveforms:
masses, spins, distance, direction,
nuclear equation of state