

***Precise measurement  
on longitudinal and transverse mode spacings  
of an optical cavity using an auxiliary laser***

**Koji Arai, Alberto Stochino, Rana Adhikari,  
and the LIGO 40m Lab**

**2008-Aug-16**

## ● Mode spacings of an optical cavity

- **Longitudinal mode spacing** (FSR: Free Spectral Range)

Determined by **the absolute length** of the cavity

- **Transverse mode spacing**

Depends on **the radius of the curvature** of the cavity mirrors

## ● Measurement of long. and trans. mode spacings

- **With one of the LIGO 40m arm cavities**
- **Using auxiliary laser, being injected from the dark port**
- **RF beating detection at the cavity transmission**

## ● Result

- **Longitudinal mode spacing & cavity length:**

$$\nu_{\text{FSR}} = 3878678 \pm 30 \text{ [Hz]} \quad \Rightarrow \quad L = 38.6462 \pm 0.0003 \text{ [m]}$$

- **Transverse mode spacing & mirror curvatures (flat-concave cavity):**

$$\delta\nu_{\text{TEM}_{10}} = 1207788 \pm 22 \text{ [Hz]} \quad \Rightarrow \quad R_H = 56.1620 \pm 0.0013 \text{ [m]}$$

$$\delta\nu_{\text{TEM}_{01}} = 1189070 \pm 17 \text{ [Hz]} \quad \Rightarrow \quad R_V = 57.3395 \pm 0.0011 \text{ [m]}$$

- **Importance to know mode spacings of cavities**
  - **Precise modelling of optical configurations**
  - **Precise diagnosis of existing optical systems**
  
  - **Longitudinal mode spacing**
    - o Precise adjustment of an optical system according to a design
    - o Characterizing phase shift of laser light in a coupled cavity system
  
  - **Transverse mode spacing**
    - o Characterizing structures of higher order modes
    - o Diagnoses of metrological qualities of optics

- **Typical application in interferometer GW detectors**

- **To determine how much suspensions should be moved in terms of the optical design**
- **To know how much phase shift modulation sidebands acquire at a non-resonant reflection by a cavity**
- **To avoid higher-order mode resonance at the carrier frequency**
- **To measure polishing quality**
- **To measure thermal lensing effect**



- **Method for the mode spacings of 1~100-m scale cavities**
  - => **mode spacings of about 1~100MHz**
  - **For shorter cavity (~10cm)**
    - cavity scanning would give a good measurement
  - **For longer cavity (100m~)**
    - frequency modulation (even through a mode cleaner) would provide a measurement of the cavity response
- **Precision of better than  $10^{-4}$** 
  - => **Cavity length / radius of curvature in ~1mm**
  - => **mode spacings with precision of ~100Hz**
- **Applicable for an existing complex optical system**
  - => **Testing at the LIGO 40m interferometer**
  - => **Preferred to be compatible with the LIGO 4km/2km interferometers**

## **R. G. DeVoe et al, Phys. Rev. A 30 (1984) 2827-2829**

### **“Laser-frequency division and stabilization”**

Measurement of the longitudinal mode spacing for a 50-cm table top cavity, using double frequency modulation/demodulation. Observed  $dL/L=2 \times 10^{-10}$  level fluctuation.

## **A. Araya et al, Applied Optics 38 (1999) 2848-2856**

### **“Absolute-Length Determination of a Long-Baseline Fabry-Perot Cavity by Means of Resonating Modulation Sidebands”**

Measurement of the longitudinal mode spacing for a 300-m suspended FP cavity, using similar technique to DeVoe's one. Observed  $dL/L=6 \times 10^{-8}$  level fluctuation.

## **M. Rakhmanov et al, Meas. Sci. Technol. 10 (1999) 190-194.**

### **“An optical vernier technique for in situ measurement of the length of long Fabry-Perot cavities”**

Measurement of the longitudinal mode spacing for a 40-m suspended FP cavity, using cavity length sweeping. The obtained precision was  $dL/L=10^{-4}$ .

## **The VIRGO collaboration, Applied Optics 46 (2007) 3466-3484.**

### **“Measurement of the optical parameters of the Virgo interferometer”**

Measurement of the longitudinal and transverse mode spacings for cavities including 3000-m suspended FP arms, using cavity length sweeping. The precisions for the longitudinal and the transverse were  $10^{-5}$  and  $5 \times 10^{-3}$ , respectively.

**M. Rakhmanov et al, Class. Quantum Grav. 21 (2004) S487-S492**

“Characterization of the LIGO 4 km Fabry-Perot cavities via their high-frequency dynamic responses length and laser frequency variations”

**R. Savage et al, LSC Meeting on March 2005**

**LIGO document G050111-00**

“Summary of recent measurements of g factor changes induced by thermal loading in the H1 interferometer”

**R. Savage et al, Poster in 6th Edoardo Amaldi Conference (2006)**

**LIGO document G050362-00**

“Measurement of thermally induced test mass surface curvature changes in a LIGO 4-km interferometer”

Measurement of the longitudinal and transverse mode spacings for LHO 4km suspended FP cavities, using transfer function measurement with injected phase modulation sidebands through the mode cleaner. The precisions for the longitudinal and the transverse were  $2 \times 10^{-8}$  and  $7 \times 10^{-4}$ , respectively. Change of the mirror curvature by the thermal effect is observed.

## ● Resonate two laser beams to the cavity simultaneously

- Main beam and the aux. beam injected from the dark port
- Frequency difference of the two beams: stabilized by PLL servo
- Beating appears at the cavity transmission

only at the resonance of the aux. beam

- The mode spacings are directly read

from the LO freq. of the PLL at the max transmission of the mode

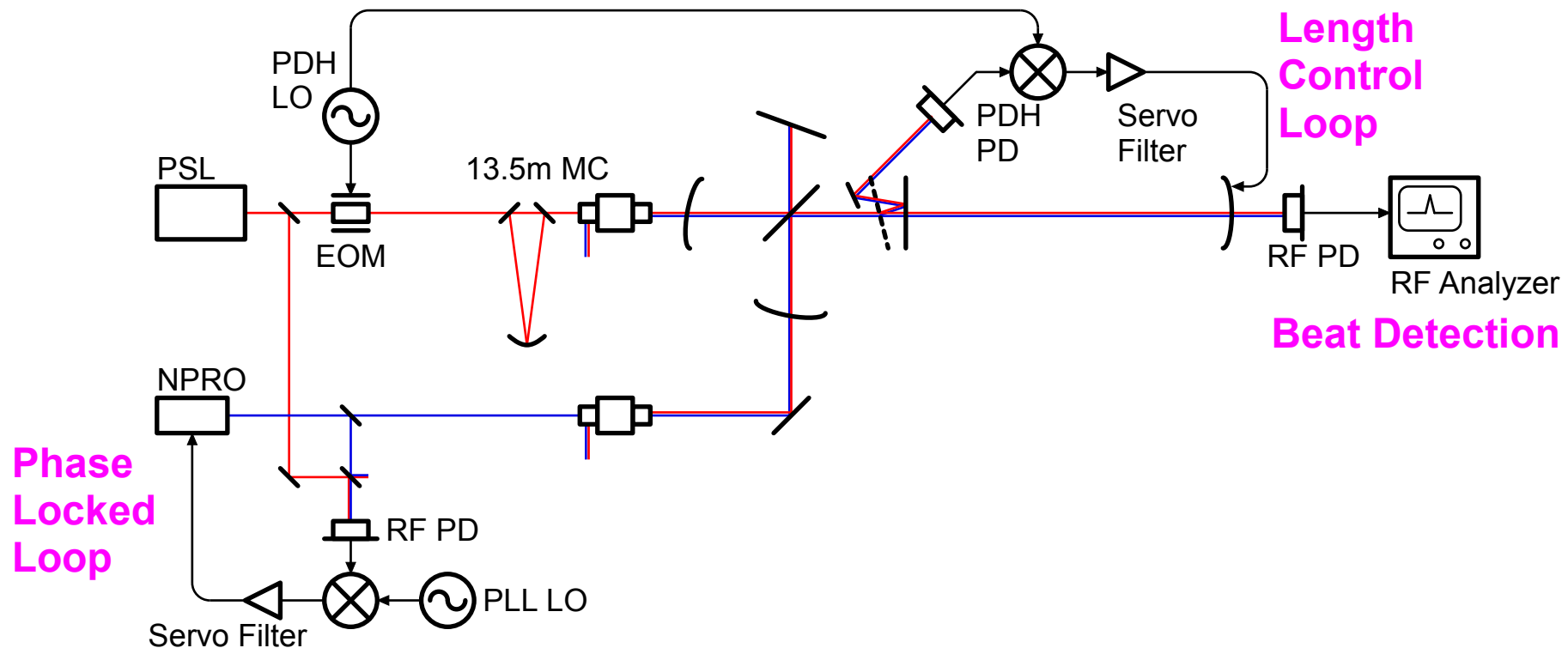



# Experimental Setup

2008/08/16  
Ver.2  
K. Arai

## ● Optical setup

### On the AP table

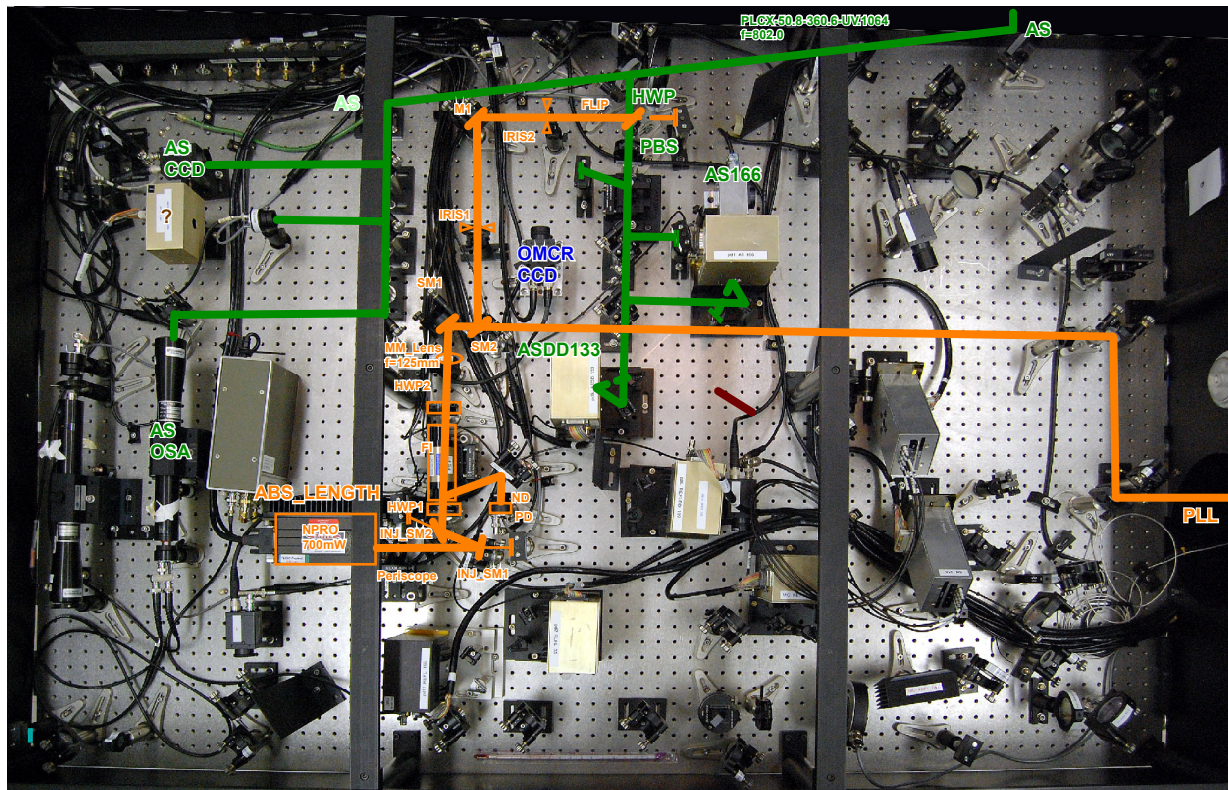

### On the PSL table

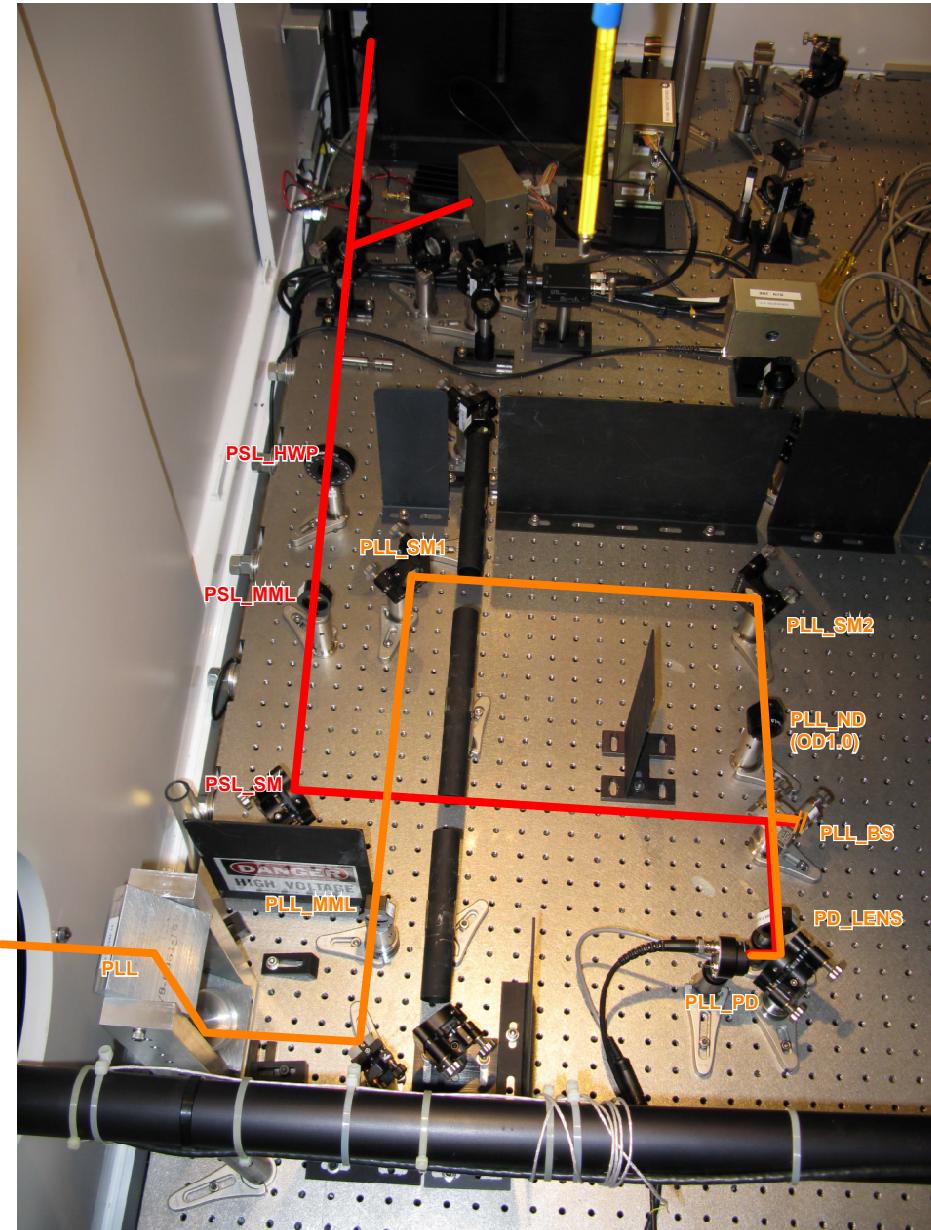

# Detection setup

2008/08/16  
Ver.2  
K. Arai

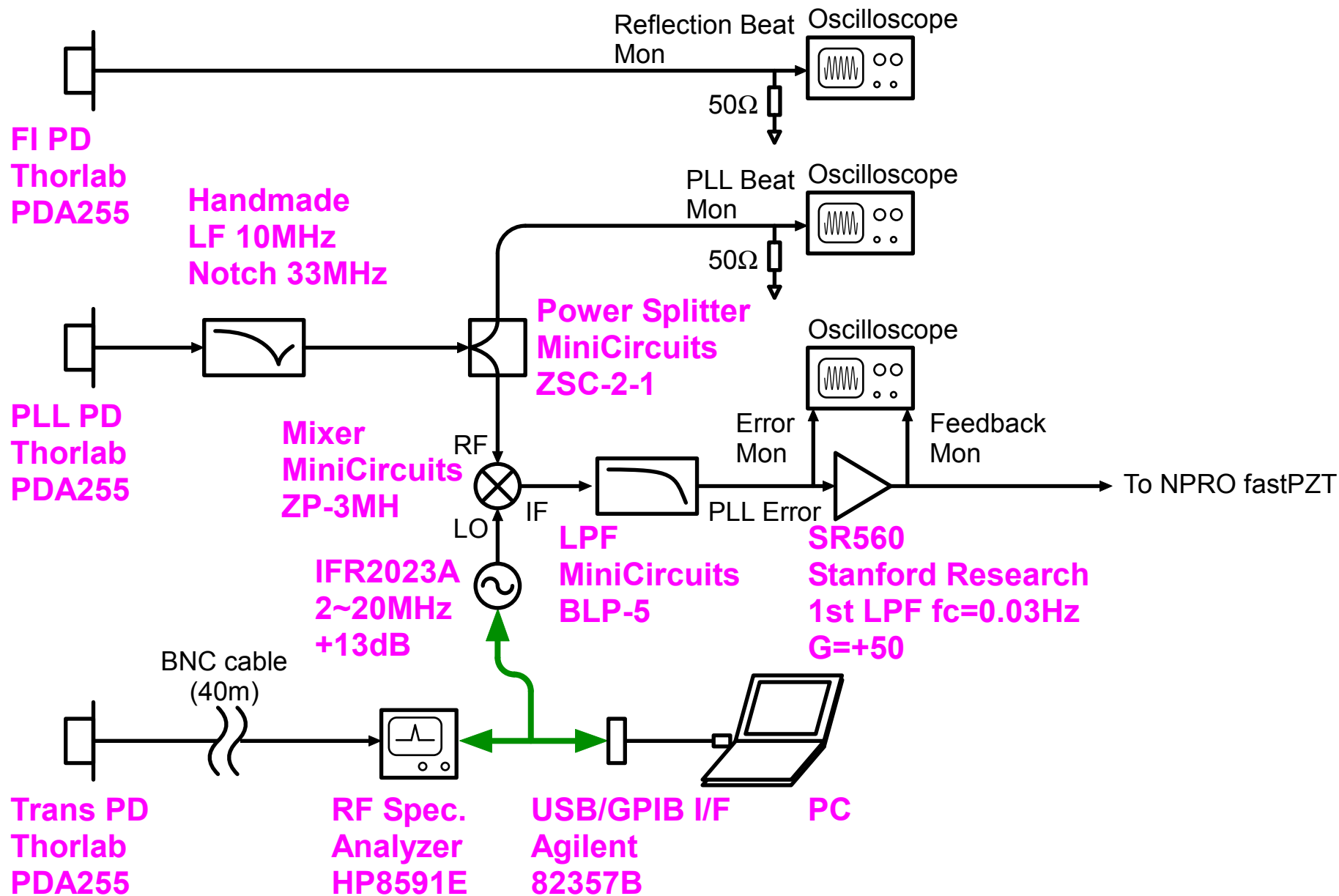



# Results ~ longitudinal mode

2008/08/16  
Ver.2  
K. Arai

- PLL LO frequency scanning from 2MHz to 20MHz

=> Record an RF amplitude at each frequency

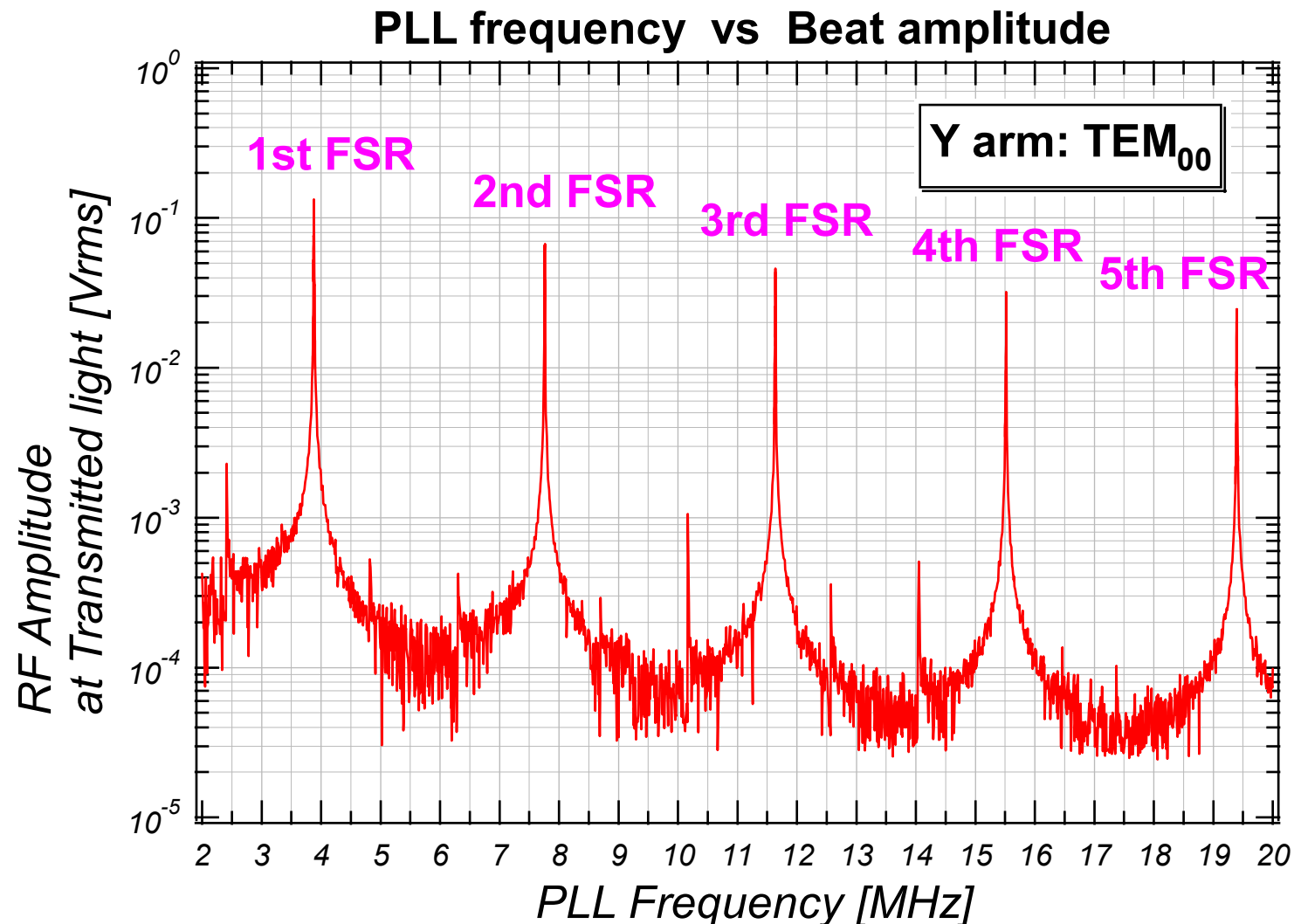

Equispaced peaks for TEM<sub>00</sub> modes are clearly observed

# Results ~ longitudinal mode

2008/08/16  
Ver.2  
K. Arai

## ● Detailed plot and fitting of each peak

Each of the five peaks are fitted by the following formula:

$$V(f) = A / \text{Sqrt}[1 - (f-f_0)^2/f_c^2] \quad f: \text{variable} \quad A, f_0, f_c: \text{parameters}$$

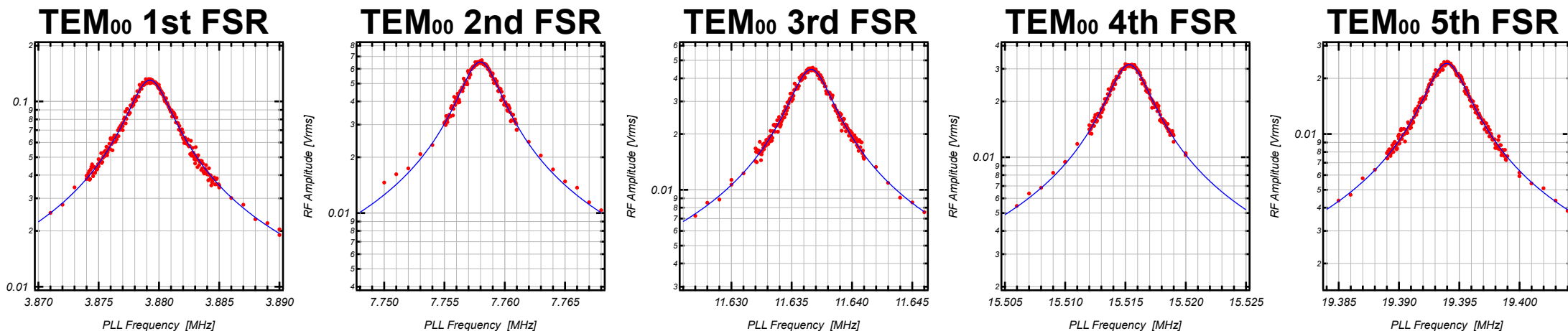

The table of the center frequency  $f_0$ :

f1:	3879251.9 Hz +/- 8.8 Hz
f2:	7757968.1 Hz +/- 10.8 Hz
f3:	11636612.9 Hz +/- 10.2 Hz
f4:	15515308.1 Hz +/- 8.7 Hz
f5:	19393968.7 Hz +/- 8.4 Hz

Each peak frequency was measured  
by precision of 10Hz (= 0.4ppm ~ 2ppm)



# Results ~ longitudinal mode

2008/08/16  
Ver.2  
K. Arai

## ● Analysis of the peak frequencies

The five peaks frequencies are on a linear line.

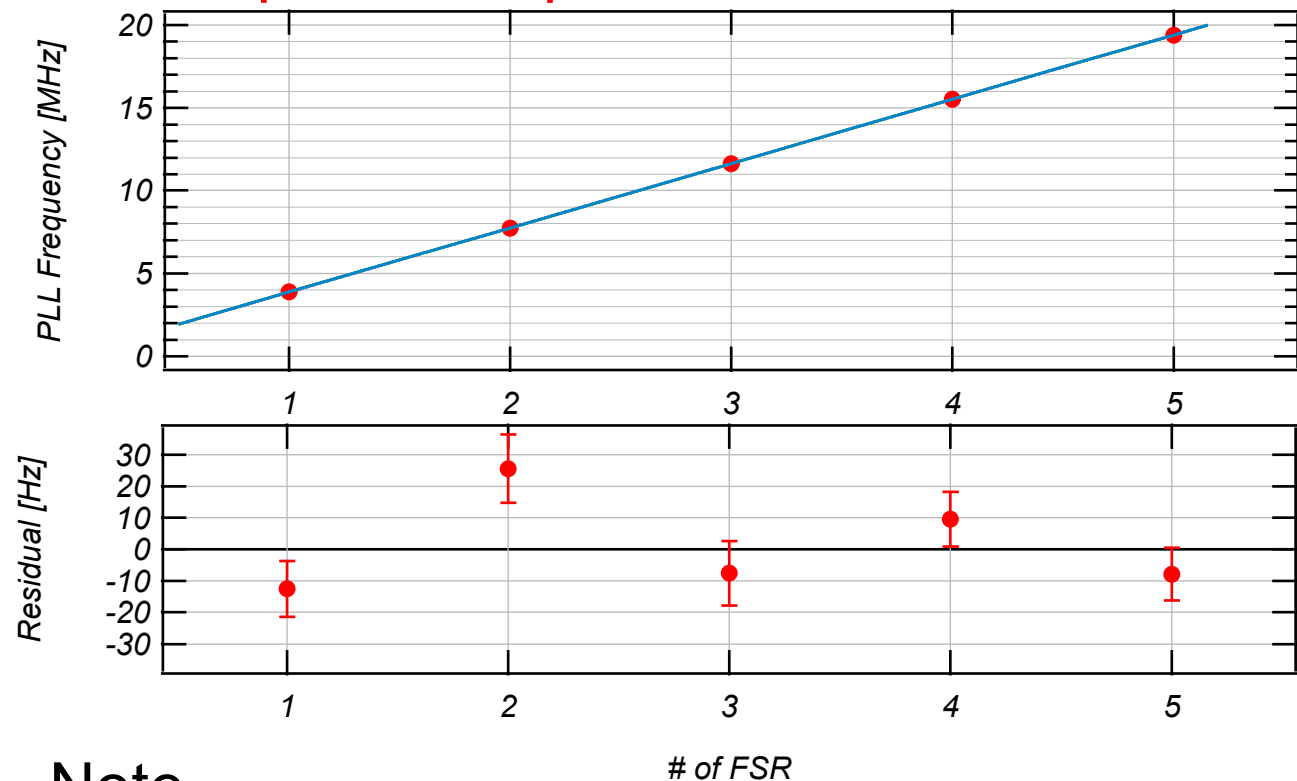

$$f_n = 586.4 + 3878678 n$$

**Longitudinal mode spacing  
(FSR)  
3878678 Hz**

**The lock of the carrier  
had detuning of 586 Hz**

### Note

- After the measurement the alignment was adjusted. This reduced the carrier lock detuning by 500Hz.
- Fluctuation of FSR was less than 30Hz. This includes statistical error, fluctuation of FSR, and that of the carrier lock detuning

(8ppm)

$$f_{\text{FSR}} = 3878678 \text{ Hz} \pm 30 \text{ Hz} \Rightarrow L_{\text{Yarm}} = 38.6462 \text{ m} \pm 0.0003 \text{ m}$$

# Results ~ transverse mode

2008/08/16  
Ver.2  
K. Arai

## ● Knife edge experiment

Horiz. or Vert half of the transmitted beam were blocked by a razor blade

=> the transmitted RF PD becomes sensitive to the higher order modes  
(similar to Anderson technique c.f. *Appl. Opt.* 23 (1984) 2944 )

Aux beam is also misaligned to increase the amount of injected TEM<sub>10/01</sub>

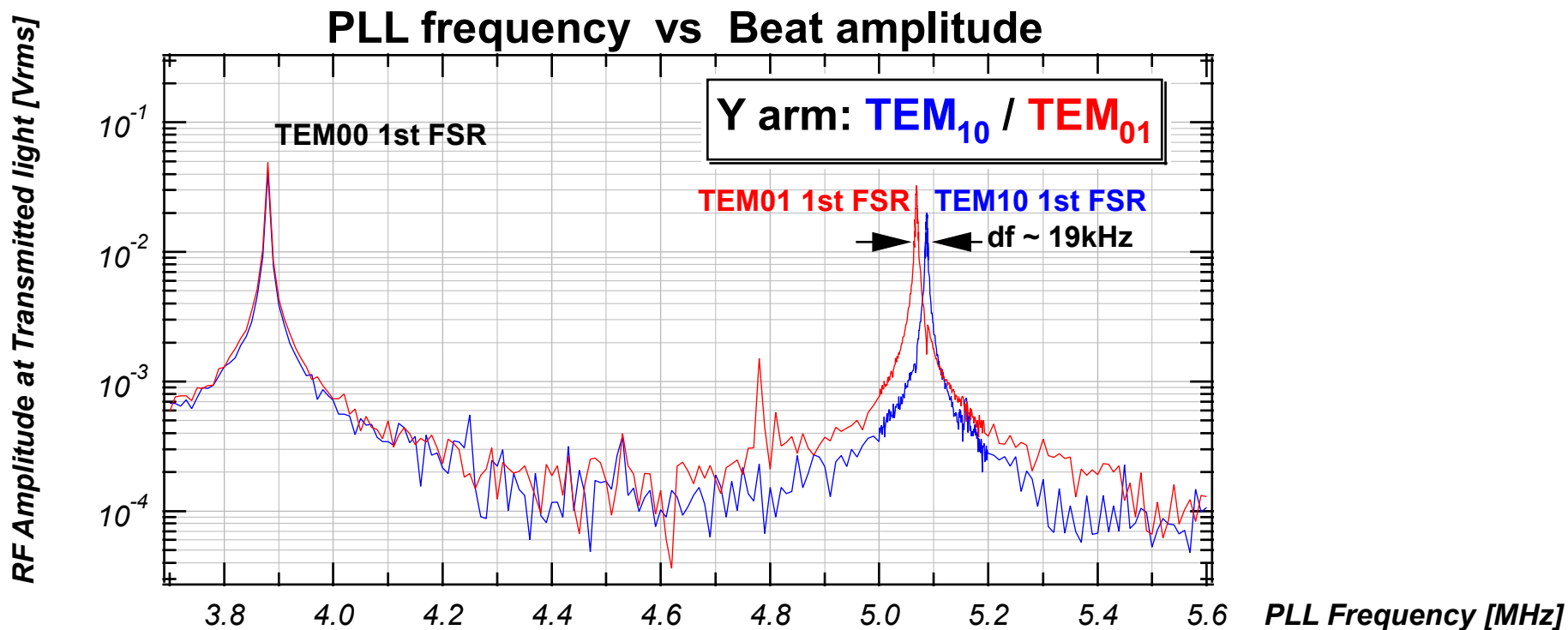

**TEM10 and TEM01 peaks appeared. Split of their frequency (~19kHz) is found!** => The cavity end mirror has an astigmatism

## ● TEM01/TEM10 resonances

PLL frequency vs Beat amplitude

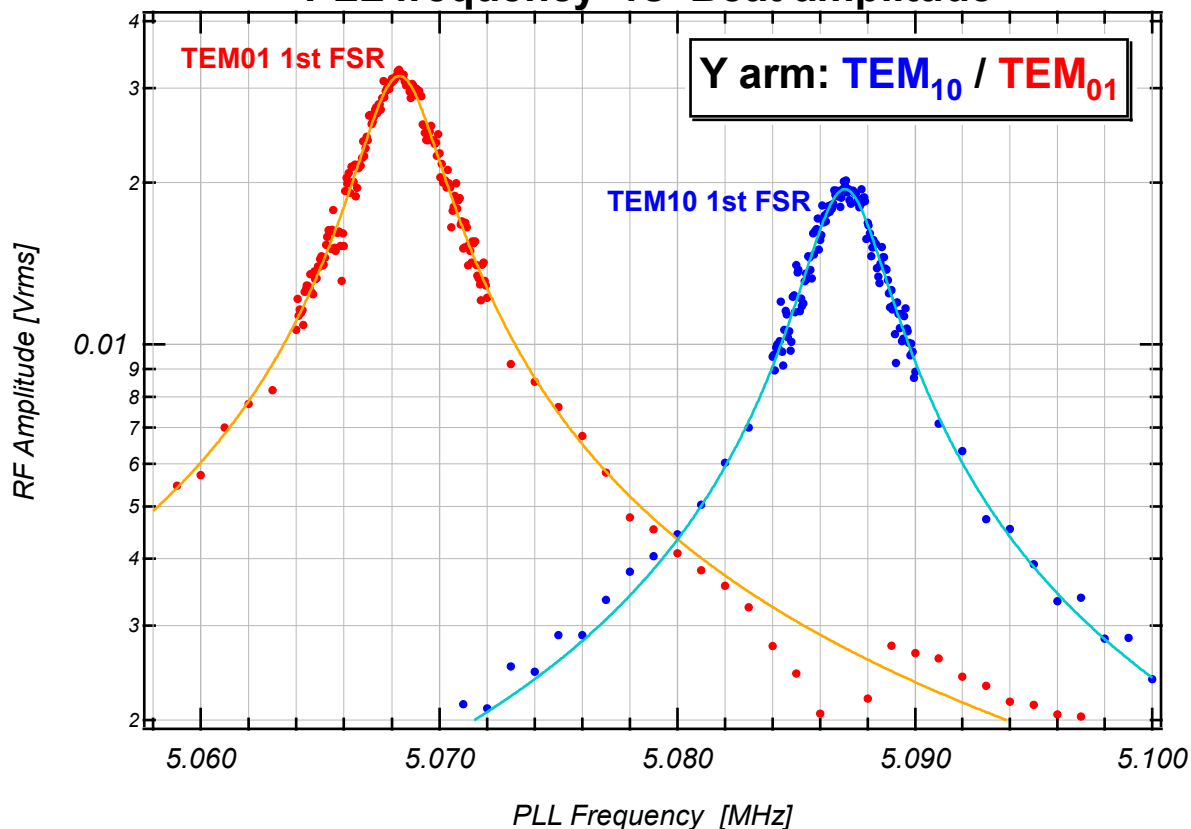

o Transverse mode resonance

$$f_{\text{TEM10}}: 5087040 \text{ Hz } \pm 20 \text{ Hz}$$

$$f_{\text{TEM01}}: 5068322 \text{ Hz } \pm 15 \text{ Hz}$$

$$\Delta f = 18.7 \text{ kHz.}$$

o Using TEM<sub>00</sub> results

$$f_{\text{TEM00}}: 3879252 \text{ Hz } \pm 9 \text{ Hz}$$

(for 1st FSR)

$$L_{\text{Yarm}}: 38.6462 \text{ m } \pm 0.0003 \text{ m}$$

o Those numbers give the radius of curvature of the mirror

$$R_H = 56.1620 \pm 0.0013 \text{ [m]} \quad (23 \text{ ppm})$$

$$R_V = 57.3395 \pm 0.0011 \text{ [m]} \quad (19 \text{ ppm})$$

## ● About the carrier (PSL) lock detuning

**The large (~500Hz) offset of the carrier lock by misalignment.**

- In principle, this should not happen by misalignment. \*\*\*In principle\*\*\*
- By a faster measurement, the precision may be improved.(?)

Scanning of the FSR not only **higer side** of the carrier  
but also **lower side** ensures the offset really exists.

## ● About phase detection

- The resonant freqs = the peak freqs => this is a power detection
- **Can we improve the precision by phase detection?**
- **Probably, it will be difficult.** Because:  
The aux beam is not enough stable owing to the low gain/bandwidth of the PLL servo. => This method is like a narrow band noise injection

The frequency of the aux beam is locked, but the phase is not locked.  
The incident beam has arbitrary phase.

- **Do we use phase correction? (PZT in the injection path)**

- **Measurement for the other 40m arm**

- For  $TEM_{00}$ ,  $TEM_{01/10}$

- **Characterization/Improvement of the PLL servo**

- Openloop TF, in-loop/out-of-loop signal
- Wider bandwidth, higher gain

- **Measurement for PRC/SEC**

- Extending the method for shorter cavities.
  - => **Wider scanning range** probably required
- The cavities with **lower finesse** (or even **frequency dependent**)
  - => Modeling will be needed for predicting/understanding the result.
- **Individual/recombined** PRC/SEC length
  - => provides a precise **BS branching ratio**

- **Modeling work for the 40m & AdvLIGO to know:**

- How much the optical lengths should be adjusted
- Requirements for the radius of curvature

- **Mode spacings of an optical cavity**

- Useful for the design and diagnosis of the optical system.

- **Longitudinal and transverse mode spacings**

- Measured for one of the LIGO 40m arm cavities
- Using auxiliary laser, being injected from the dark port
- RF beating detection at the cavity transmission

- **Result**

- **Longitudinal mode spacing & cavity length:**

$$\nu_{\text{FSR}} = 3878678 \pm 30 \text{ [Hz]} \quad \Rightarrow \quad L = 38.6462 \pm 0.0003 \text{ [m]}$$

- **Transverse mode spacing & mirror curvatures (flat-concave cavity):**

$$\delta\nu_{\text{TEM}_{10}} = 1207788 \pm 22 \text{ [Hz]} \quad \Rightarrow \quad R_H = 56.1620 \pm 0.0013 \text{ [m]}$$

$$\delta\nu_{\text{TEM}_{01}} = 1189070 \pm 17 \text{ [Hz]} \quad \Rightarrow \quad R_V = 57.3395 \pm 0.0011 \text{ [m]}$$

- **Future works**

- Extending the method for the other cavities / AdvLIGO



# Practical Details 1

2008/08/16  
Ver.2  
K. Arai

## ● Optical layout at the AP table

### Periscope:

To raise the beam elevation from 3inch to 4inch

### INJ\_SM1/2:

To steer the aux. beam independently from the main beam

### HWP1:

Half wave plate to make the beam horz-polarized (42deg nominal)

### FI:

Faraday isolator

### HWP2:

To make the beam to the IFO horz-pol (357deg nominal)

### MM\_Lens:

To match the NPRO mode to the IFO beam. (f=125mm)

### SM1/SM2:

Steering mirrors  
SM2 is a 45deg R=95% mirror so that there can be a beam to the PLL setup

### IRIS1/IRIS2:

For the coarse alignment of the aux beam

### FLIP:

Flipper mirror to turn on/off the aux optics.

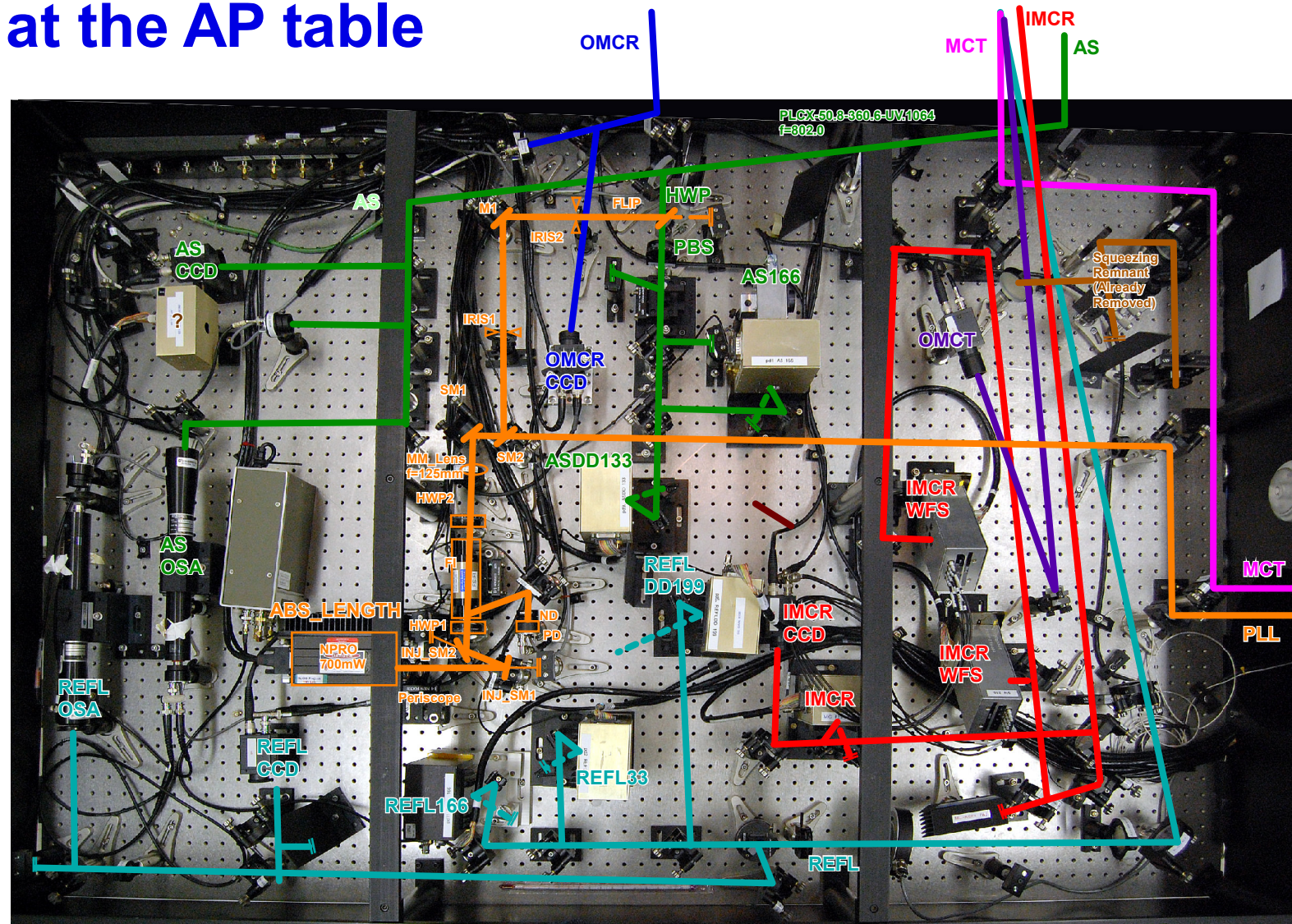







## ● Optical layout at the Y End table

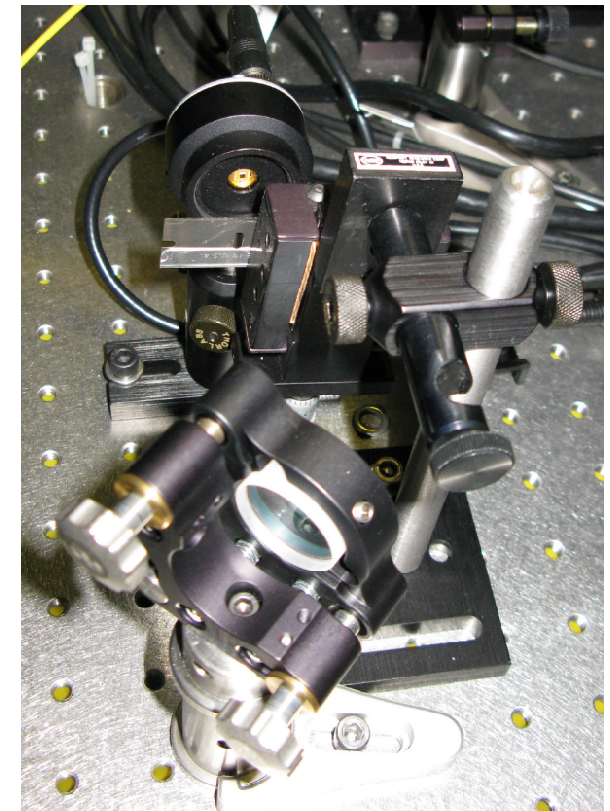
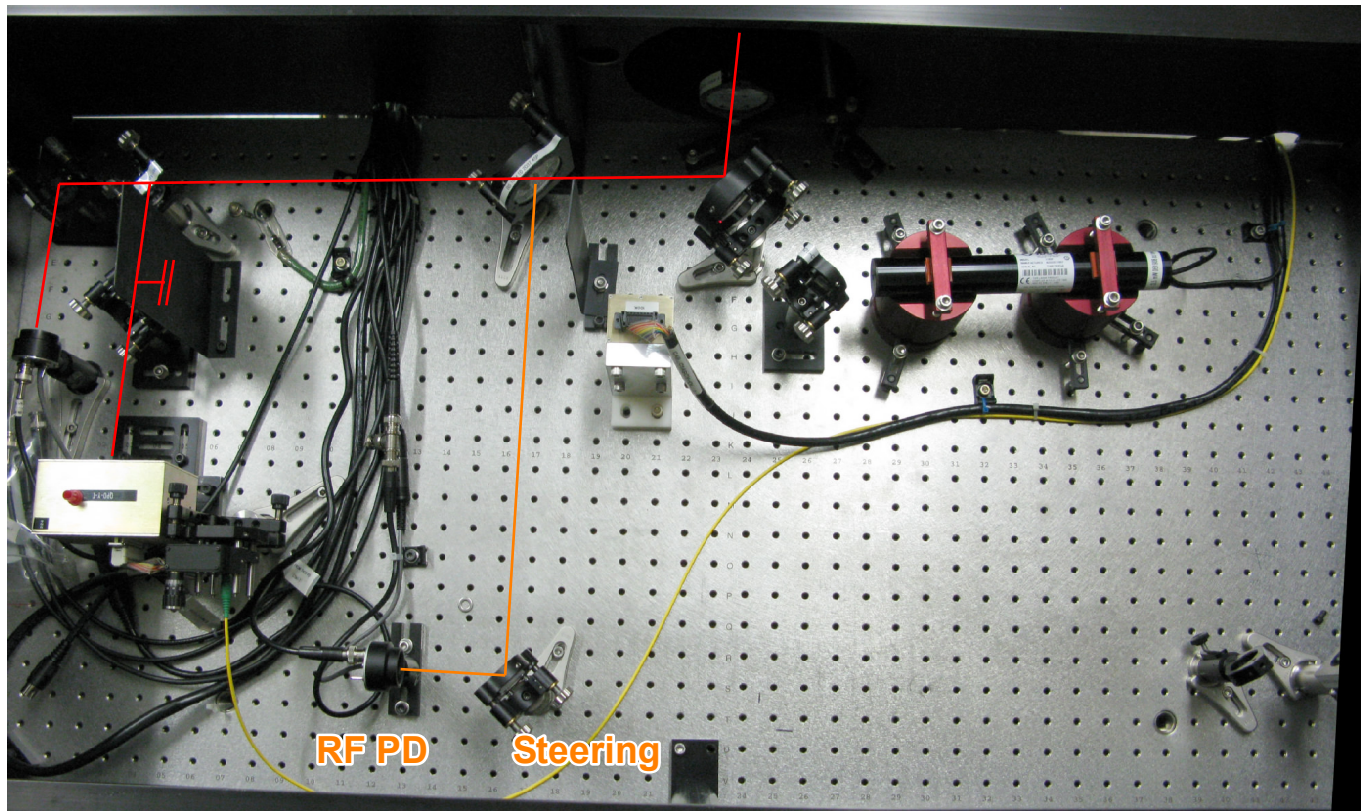

**Steering mirror:**  
To steer the beam to the PD

**RF PD:**  
Thorlab PDA255 ~50MHz  
The beam is focused at the PD  
because of the first lens

**Knife Edge:**  
Placed just in front of the PD  
so as to avoid diffraction

## ● Mode matching for the injection beam

### Position[m]

0.000	NPRO Shutter		
0.050	H Waist	radius: 0.230mm	zR: 0.156m (c.f. NPRO manual)
	V Waist	radius: 0.175mm	zR: 0.090m (c.f. NPRO manual)
0.483	Lens1 (f=0.125m)		
0.649	H Waist		zR: 0.0204m
0.656	V Waist		zR: 0.0136m
1.457	Lens2 (f=0.802m)		
10.39 (0.002)	H Waist		zR: 29.3m
	V Waist (virtual)		zR: 47.0m

**Actual obtained beam overlapping ~ 38%**

**\*The actual position of Lens1 was tweaked to optimize the actual mode matching.**

## ● Mode matching for the PLL setup

**PSL beam:** Beam collimated in  $\sim 1^+$  inch region  $\Rightarrow zR \sim 0.029m \Rightarrow w0 \sim 0.1mm$   
A lens with  $f=401mm$  is used so that the resulting  $zR \sim 5m$  is obtained.

**Aux beam:** Beam collimated in  $\sim 3$  inch region  $\Rightarrow zR \sim 0.075m \Rightarrow w0 \sim 0.16mm$   
A lens with  $f=687mm$  is used so that the resulting  $zR \sim 5m$  is obtained.

**Actual obtained beam overlapping ~ 29%**

**\*The merit of using thick collimated beam:**

The tolerances to the longitudinal and transverse position of the beam are relaxed.

## ● Alignment Procedure

### ○ Preparation

- 1) Turn on NPRO several hours before the experiment so that the laser frequency can be stable.
- 2) Open the shutter of NPRO.

### ○ Initial alignment of the injection beam

- 3) Adjust INJ\_SM1/SM2 so that the NPRO beam can go through the center of FI.
- 4) Turn up FLIP. Close the NPRO shutter.  
Adjust M1/FLIP so that the ifo beam can go through IRIS1/IRIS2.  
\* IRIS1/2 should be in a reasonable place from the beginning.
- 5) Open the shutter of NPRO again. Adjust SM1/SM2 so that the NPRO beam can go through IRIS1/IRIS2. Confirm the spots on the SM1/SM2 are located at reasonable places on the mirrors.
- 6) Now, it is expected that the reflection of the injection beam from SRM or ITM appears at AS CCD, if either SRM or ITM is aligned.
- 7) Adjust INJ\_SM1/INJ\_SM2 so that the injection beam at AS CCD can overlap to the IFO beam.
- 8) Confirm the beam at the output of the FI also overlaps. Adjust the steering mirror just before the RF PD.

## ● Alignment Procedure 2

### ○ Temperature scan for the beat

9) Change the ifo configuration to the X or Y arm only, if not yet done.

10) Put the RF PD output to an RF analyzer. Scan the crystal temperature of the 700mW NPRO so as to find the peak of beating. Note that the beating was found at NPRO LT~48.8deg for PSL LT=~46.5 deg.

### ○ Precise alignment of the injection beam

11) Once the beat is found, you can adjust INJ\_SM1/INJ\_SM2 such that the beating amplitude is maximized.

### ○ Precise alignment of the PLL alignment

12) Confirm all of the beam of the PLL setup is located on the proper position of the mirror. (Particularly, on the AP table)

13) Adjust PSL\_SM so that the PSL beam overlaps the aux beam at PLL\_BS.  
Adjust PLL\_BS so that the beating at the PLL\_PD is maximized.

15) Adjust PSL\_SM and PLL\_BS simultaneously so that the beating at the PLL\_PD is further maximized

### ○ Tip for the daily alignment

Only 10)-15) are fine for the daily alignment. If the alignment had been previously adjusted, and you found a large misalignment when FLIP is popped up, it is presumably caused by the flipper.

Adjust flipper so that the spot on the CCD video or the beating is optimized.



# Practical Details 7

2008/08/16

Ver.2

K. Arai

## ● Beating conditions on 2008-Aug-03

### o How to calculate mode overlapping ratio

$$E1 = \text{Sqrt}(P_1) \langle \text{TEM}_{00} | \text{Exp}(i w_1 t) \rangle$$

$$E2 = \text{Sqrt}(\alpha P_2) \langle \text{TEM}_{00} | \text{Exp}(i w_2 t) \rangle + \text{Sqrt}[(1-\alpha) P_2] \langle \text{TEM}_{XX} | \text{Exp}(i w_2 t) \rangle$$

$$E1 E1^* = P_1, E2 E2^* = P_2$$

$$P_{\text{beat}} = (E1+E2)(E1+E2)^* = P_1 + P_2 + 2 \text{Sqrt}(\alpha P_1 P_2) \text{Cos}[i (w_1 - w_2) t]$$

### o Temperature setups

NPRO LT = 48.74 deg, PSL LT = 46.45 deg

The higher NPRO LT has lead the lower beat freq

=>  $f(\text{NPRO}) > f(\text{PSL})$

### o Beating at the FI output on 2008-Aug-03

$$P_{\text{max}} = 398 \text{ mV}$$

$$P_{\text{min}} = 174 \text{ mV}$$

$$P_{\text{ifo}} = 252 \text{ mV}$$

$$P_{\text{ofs}} = 5.80 \text{ mV}$$

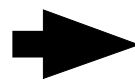

$$P1 = 246 \text{ mV}$$

$$P2 = 34 \text{ mV}$$

57% intensity modulated

$$\alpha = 0.37$$

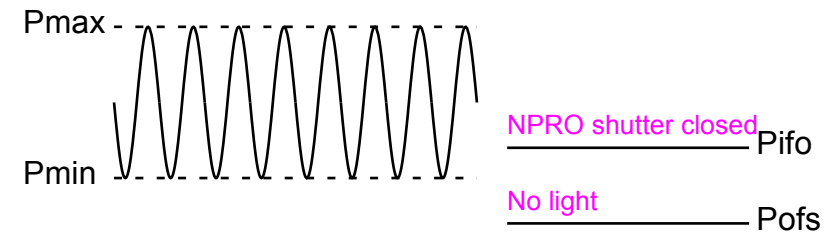

### o Beating at the PLL PD on 2008-Aug-03

$$P_{\text{max}} = 420 \text{ mV}$$

$$P_{\text{min}} = 162 \text{ mV}$$

$$P_{\text{ifo}} = 71.2 \text{ mV}$$

$$P_{\text{ofs}} = 6.40 \text{ mV}$$

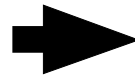

$$P1 = 64.8 \text{ mV}$$

$$P2 = 220 \text{ mV}$$

62% intensity modulated

$$\alpha = 0.29$$

## ● ifr2023A calibration

○ Calibration of the PLL LO frequency is essential for our measurement:

Because PLL LO is the frequency reference

○ Calibrated by frequency counter SR620 is locked to the GPS signal.

○ The frequency of the IFR2023A was scanned:

from 1MHz to 20MHz with 1MHz interval.

○ The linear fit was taken. Result:

$$f_{\text{freq\_count}} [\text{Hz}] = K0 + K1 * f_{\text{IFR}} [\text{Hz}]$$

$$K0 = 0.00 \quad \text{+/- } 0.02$$

$$K1 = 0.9999999470 \quad \text{+/- } 0.0000000001$$

○ All of the frequencies for the measured points were converted  
by this formula.

# Practical Details 9

2008/08/16  
Ver.2  
K. Arai

## ● GPIB commands for the PLL freq scanning

○ HP = RF Spectrum Analyzer, IFR = IFR2023 function generator

### ○ Initialization

Write to HP: "AUNITS V"

#Represent peak value in Vrms

Write to HP: "CF 3456789HZ"

#Set the center freq

Wait 1sec

Write to HP: "SP 1MHz"

#Set freq span to 1MHz

Wait 1sec

### ○ In the scanning loop

Write to HP: "CF 3456789HZ"

#Set the center freq

Write to IFR: "CFRQ 3456789HZ"

#Set the carrier freq

Write to HP: "MKPK HI"

#Find highest peak in the spectrum

Wait 1sec

Write to HP: "MKA?"

#Query for the peak amplitude

Read value from HP

#Get the peak value

# Thoughts and Test for HOM

2008/08/16  
Ver.2  
K. Arai

## ● Questions

- The TEM01 and TEM10 of the Yarm were found to split with 19kHz separation. Is this true?
- In which direction the eigenmodes are?

## ● Thoughts

- The separation of 19kHz is a kind of too big because the cavity bandwidth is several kHz.
- This means that "TEM01 and TEM10 can not resonate at the same time (by the PSL beam)".

## ● Test

- Imagine we are just using the PSL beam and playing with an arm cavity.
- Tilt the end mirror in pitch. Resonate the TEM01 mode (8-shaped).
- Then tilt the end mirror in yaw.
- a) If the resonances are degenerated within the bandwidth of the laser, it rotates freely.
- b) If the resonances splits, the tilt in yaw does not change the shape. Then suddenly jumps to TEM10 (by an accident).



# Thoughts and Test for HOM

2008/08/16  
Ver.2  
K. Arai

## ● Result

- o The shape does not change. Just jumps to the other mode.  
(The case above b.)
- o The eigenmode looked like quite horizontal and vertical.

## Conclusion: the mode really splits.

✗ a) TEM01/TEM10 degenerated  
Pitch misalign, lock TEM01

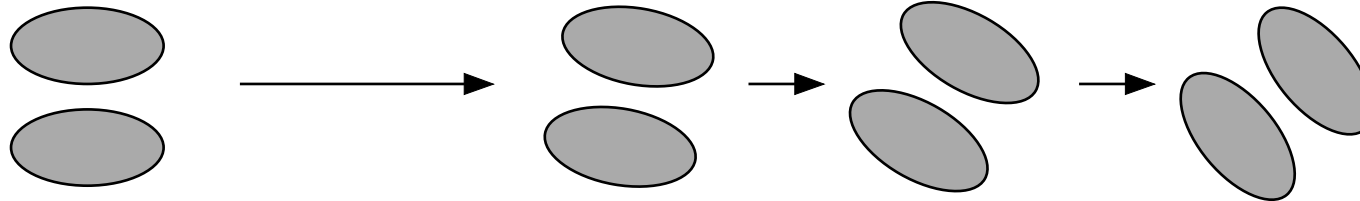

○ b) TEM01/TEM10 split  
Pitch misalign, lock TEM01

