

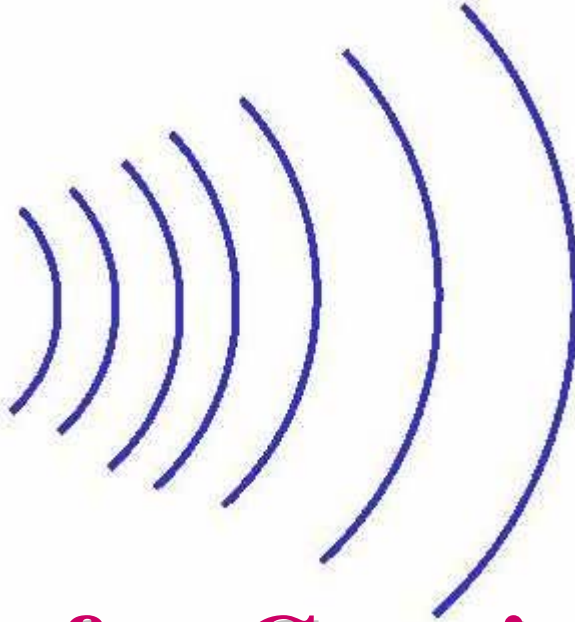

LIGO

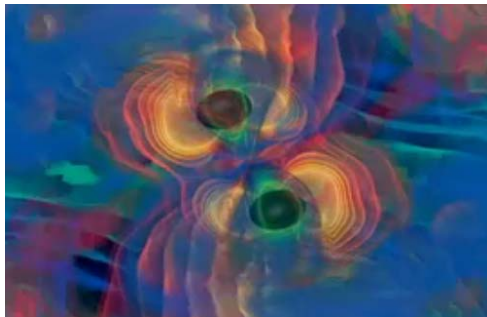

LSC



Searching for Gravitational Waves: news from the front

Gabriela González

Physics and Astronomy, Louisiana State University

LIGO Scientific Collaboration

University of Chicago

February 8, 2007



Einstein's gravitation

When masses move, they wrinkle the space time fabric, making other masses move...

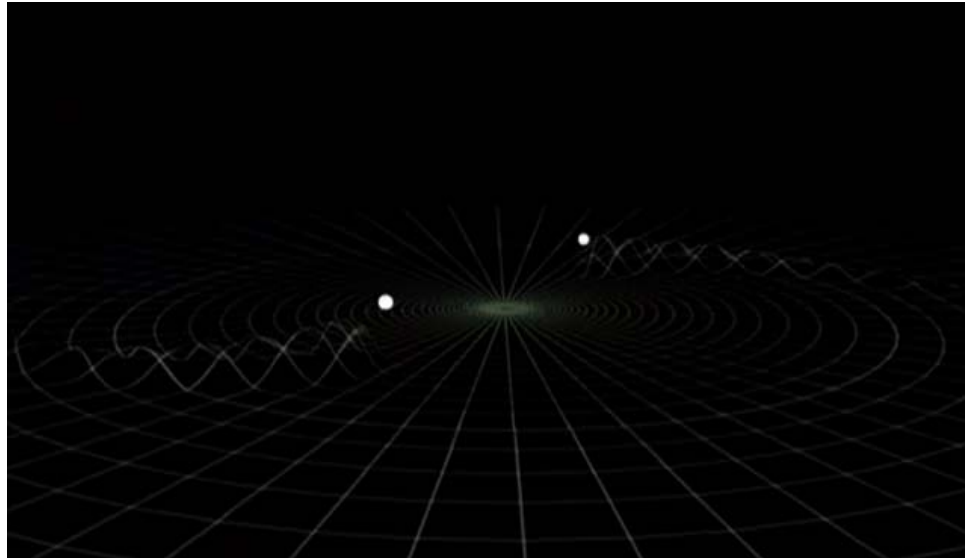
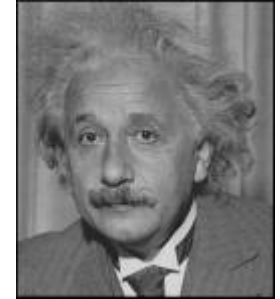

Einstein's messengers,
National Science Foundation video
www.ligo.caltech.edu

The theory predicts ~~gravitational waves~~ **gravitational waves** traveling away from moving masses.

Gravitational waves

Gravitational waves are quadrupolar distortions of distances between freely falling masses. They are produced by time-varying mass quadrupoles.

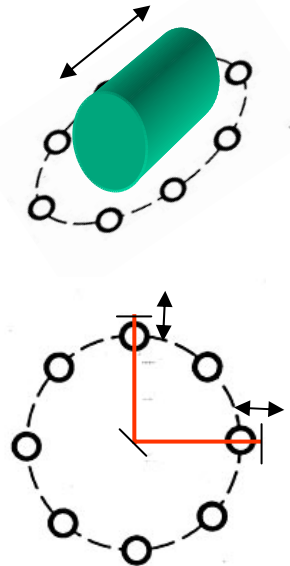
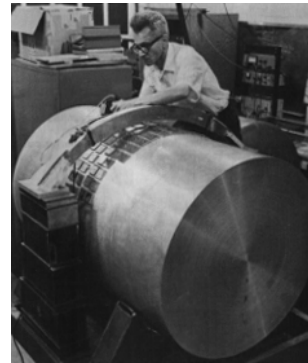
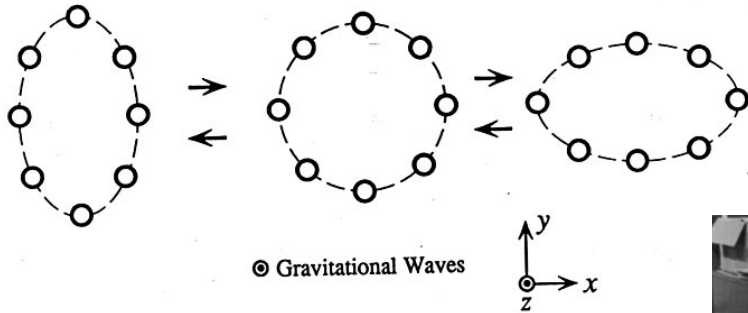

Resonant systems can measure elastic response to distance distortion: resonant bar detectors.

Michelson-type interferometers can detect distance changes in orthogonal directions.

In both cases, what's measured is $\Delta L = hL$

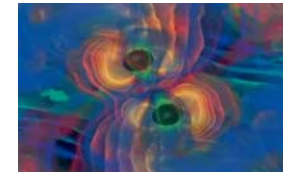

Amplitude of GWs produced by binary neutron star systems in the Virgo cluster have $h = \Delta L/L \sim 10^{-21}$ and frequencies sweeping up to ~ 1400 Hz.

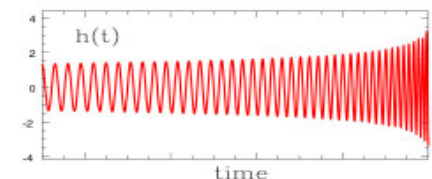

The LIGO project

$$h = \Delta L / L \sim 10^{-21} \text{ and } L = 4 \text{ km} \Rightarrow \Delta L = hL \sim 10^{-18} \text{ m !}$$



Hanford, WA



Livingston, LA



Three LIGO detectors: 4km long in Livingston, LA (L1); 4km and 2km long in Hanford, WA (H1, H2).

Hundreds of people working on the experiment and looking at the data:
LIGO Scientific Collaboration

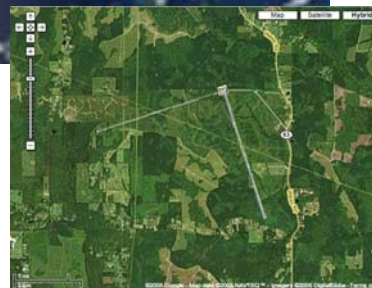

Collaborating Institutions



NORTHWESTERN UNIVERSITY



Universitat de les Illes Balears



THE UNIVERSITY OF BIRMINGHAM





- Worldwide Network:
 - GEO and LIGO detectors' data analyzed by LSC
 - We have coordinated observations and shared data with TAMA
 - We just finalized agreements with VIRGO
 - AIGO is still in planning stage; AIGO personnel currently share in LIGO operation

a difficult and fun experiment



QuickTime™ and a
Animation decompressor
are needed to see this picture.

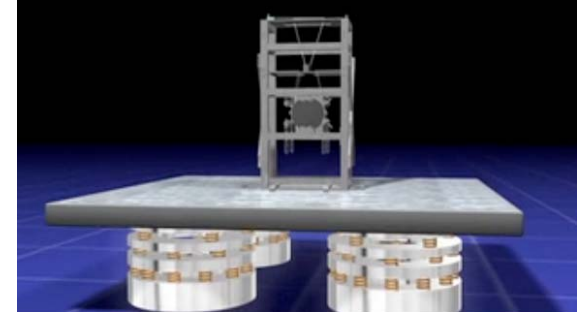

QuickTime™ and a
Animation decompressor
are needed to see this picture.



Best Strain Sensitivities for the LIGO Interferometers

Comparisons among S1 - S5 Runs LIGO-G060009-01-Z

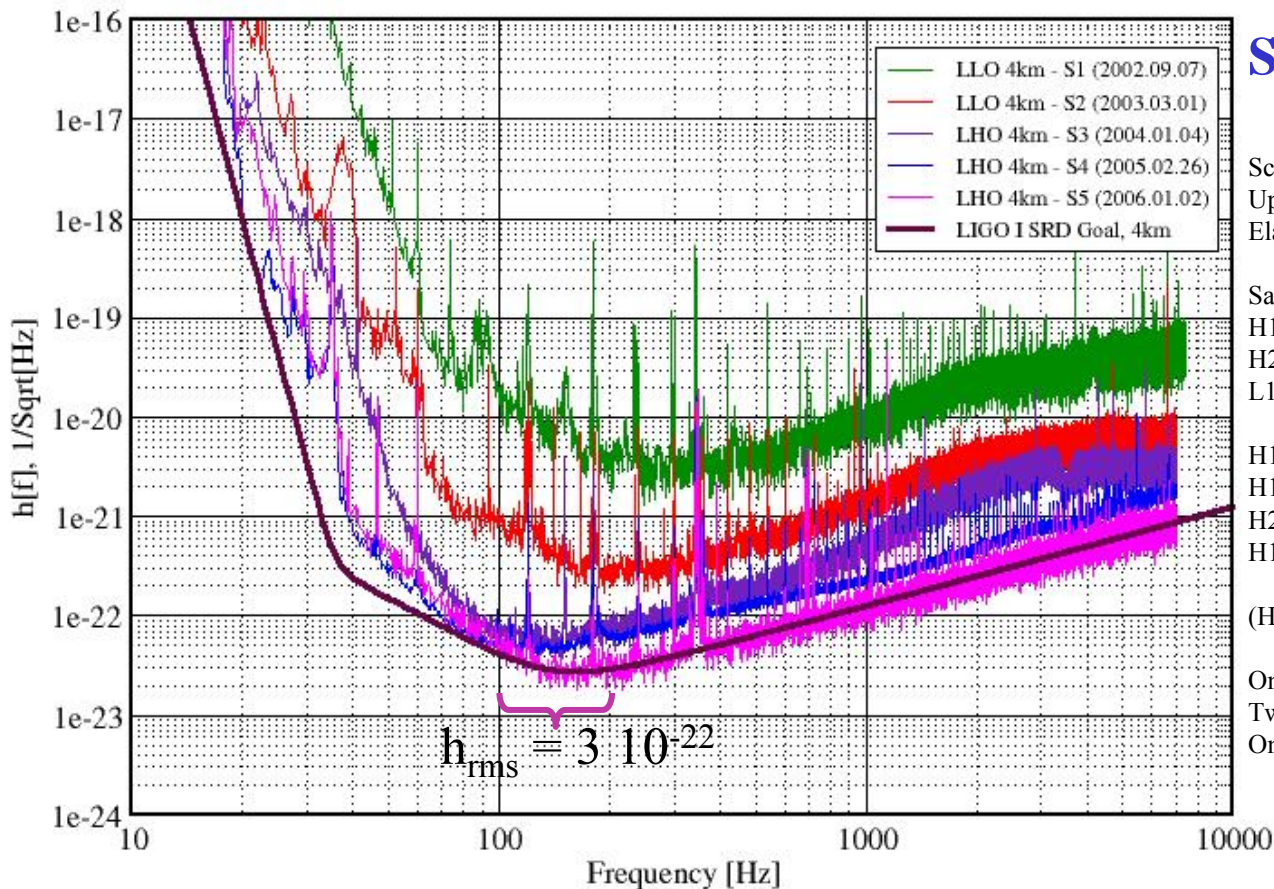

S5 so far:

Science-mode statistics for S5 run
Up to Feb 08 2007 17:36:05 UTC
Elapsed run time = 11065.6 hours

Sample	Hours	Percent	
H1	8097.8	73.2	since Nov 4, 2005
H2	8452.5	76.4	since Nov 4, 2005
L1	6658.9	61.5	since Nov 14, 2005
H1+H2	7427.3	67.1	since Nov 4, 2005
H1+L1	5545.0	51.2	since Nov 14, 2005
H2+L1	5586.9	51.6	since Nov 14, 2005
H1+H2+L1	5130.4	47.4	since Nov 14, 2005
(H1orH2)+L1	6002.2	54.2	since Nov 4, 2005
One or more LIGO	9780.4	88.4	since Nov 4, 2005
Two or more LIGO	8299.0	75.0	since Nov 4, 2005
One or more LSC	10491.8	94.8	since Nov 4, 2005

a measure of performance



Can translate strain amplitude into (effective) distance

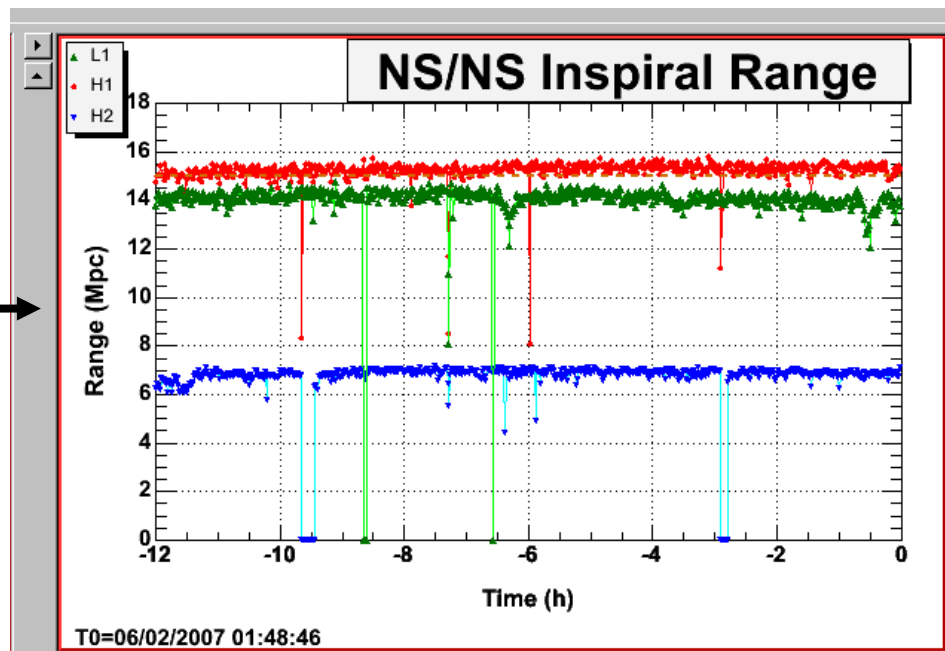
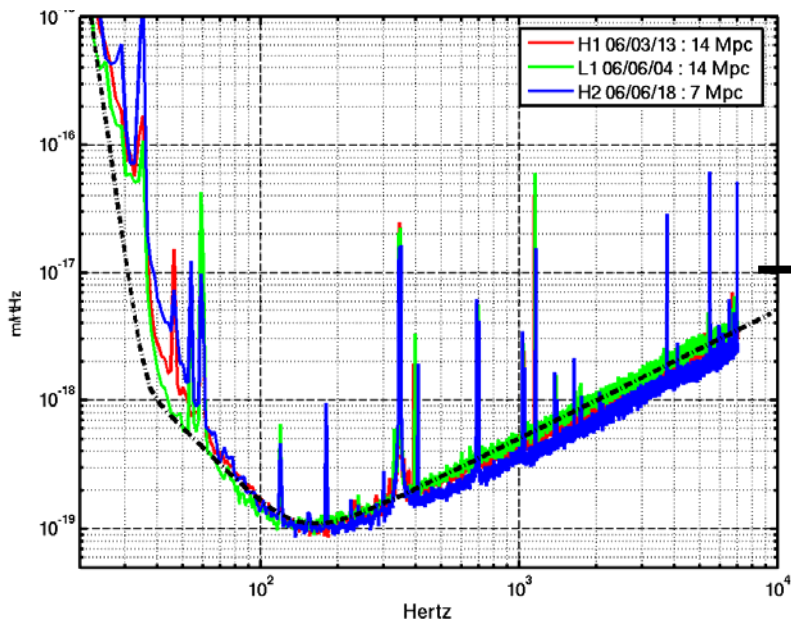
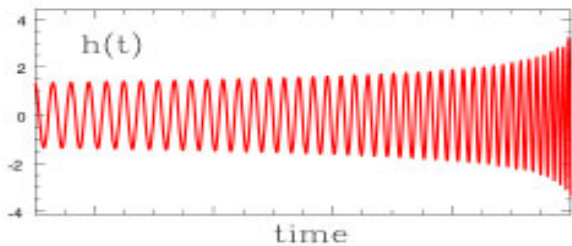

If system is optimally located and oriented, we can see even further: we are surveying hundreds of galaxies!

Electronic logs are public!
www.ligo.caltech.edu

www.ligo.org

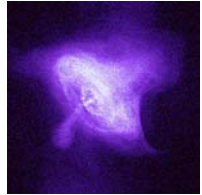

Crab pulsar (NASA, Chandra Observatory)

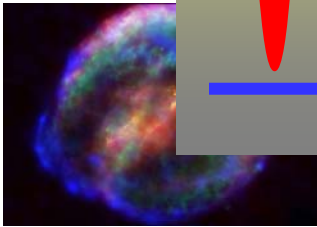
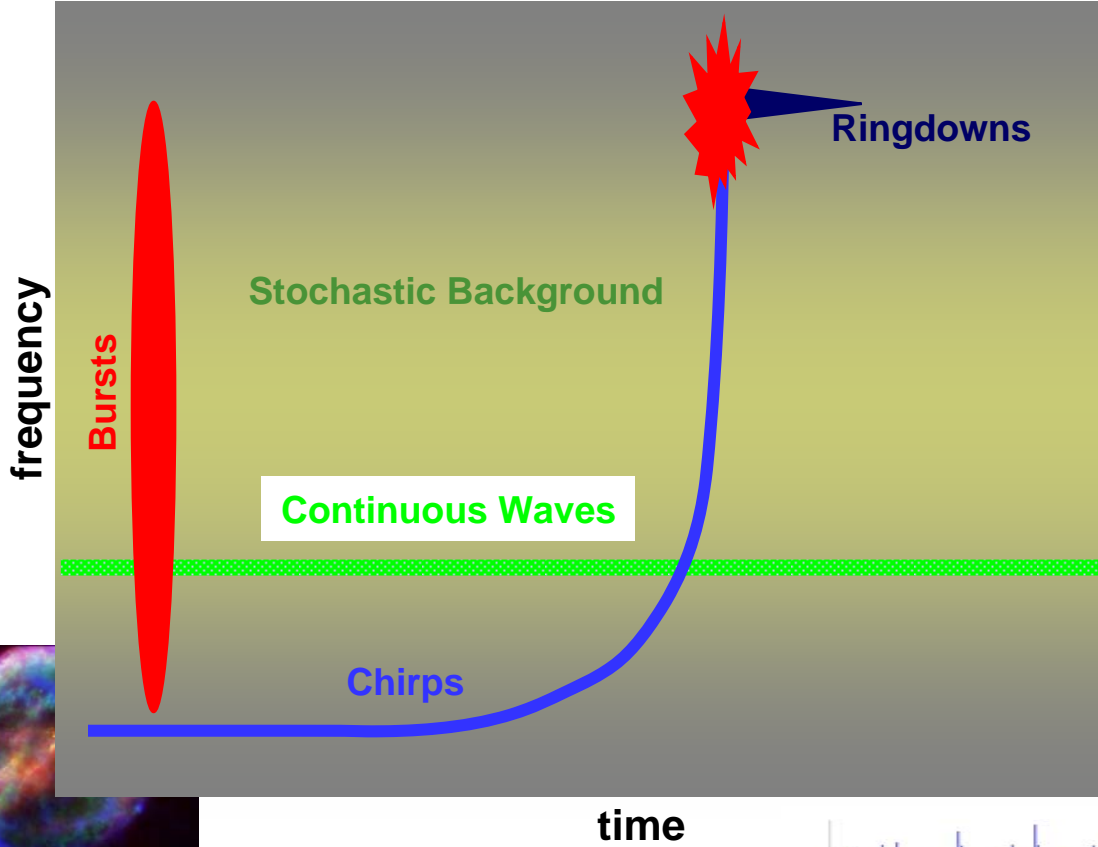
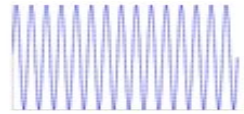

NASA, HEASARC

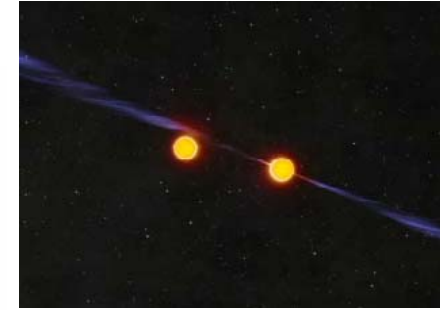
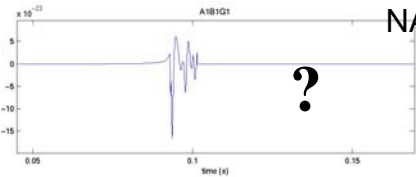

John Rowe, CSIRO

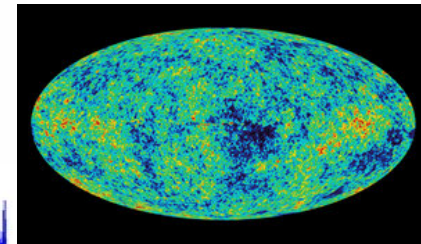
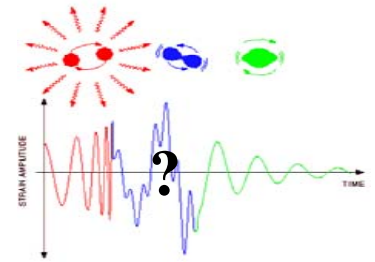

NASA, WMAP



Gravitational wave searches: pulsars

Crab pulsar
(Chandra Telescope)

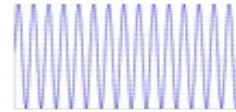
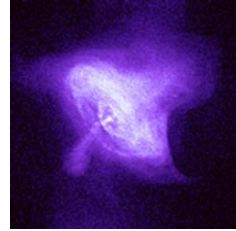

- Rotating stars produce GWs *if* they have asymmetries or *if* they wobble.
- *Observed* spindown can be used to set strong indirect upper limits on GWs.
- There are many known pulsars (rotating stars!) that produce GWs in the LIGO frequency band (40 Hz-2 kHz).
 - Targeted searches for 73 known (radio and x-ray) systems in S5: isolated pulsars, binary systems, pulsars in globular clusters...
- There are likely to be many non-pulsar rotating stars producing GWs.
 - All-sky, unbiased searches; wide-area searches.
- GWs (or lack thereof) can be used to measure (or set up upper limits on) the ellipticities of the stars.
- Search for a sine wave, modulated by Earth's motion, and possibly spinning down: easy, but computationally expensive!

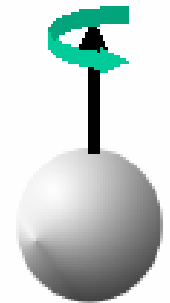

<http://www.einsteinathome.org/>

Gravitational wave searches: pulsars

Lowest GW strain upper limit:

PSR J1802-2124

($f_{\text{gw}} = 158.1 \text{ Hz}$, $r = 3.3 \text{ kpc}$)

$h_0 < 4.9 \times 10^{-26}$

Lowest ellipticity upper limit:

PSR J2124-3358

($f_{\text{gw}} = 405.6 \text{ Hz}$, $r = 0.25 \text{ kpc}$)

$\varepsilon < 1.1 \times 10^{-7}$

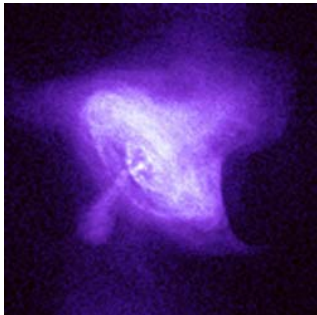

Crab pulsar

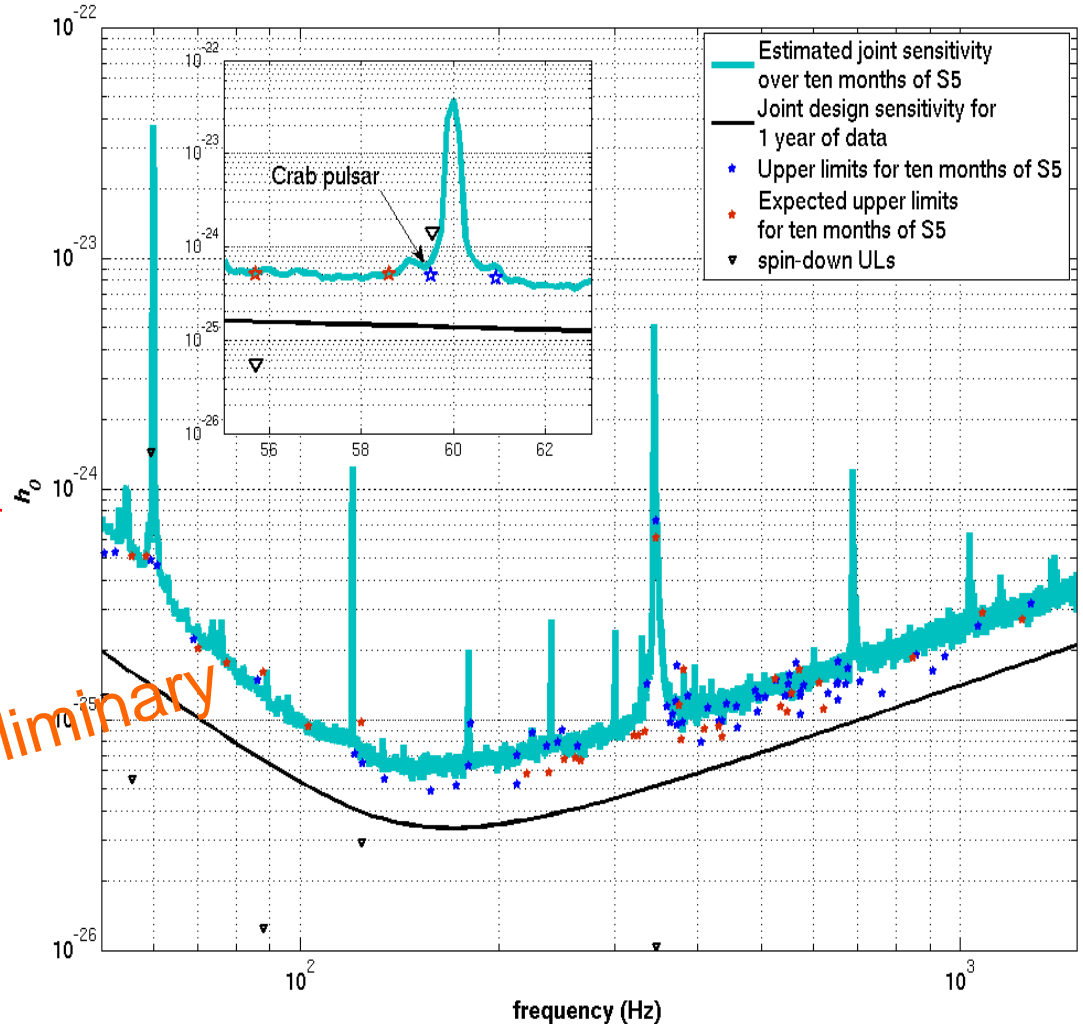

•

•

LIGO searches: “burst” sources (untriggered)

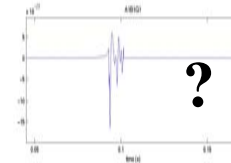
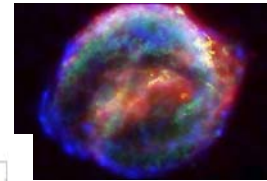

- Search for triple coincident triggers with a wavelet algorithm
- Measure waveform consistency
- Set a threshold for detection for low false alarm probability
- Compare with efficiency for detecting simple waveforms

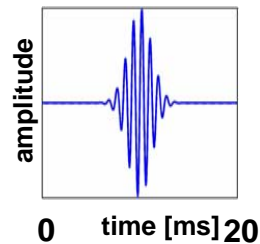
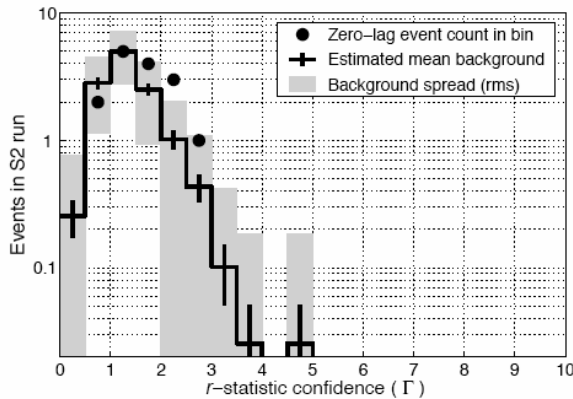

PRD 72 (2005) 042002

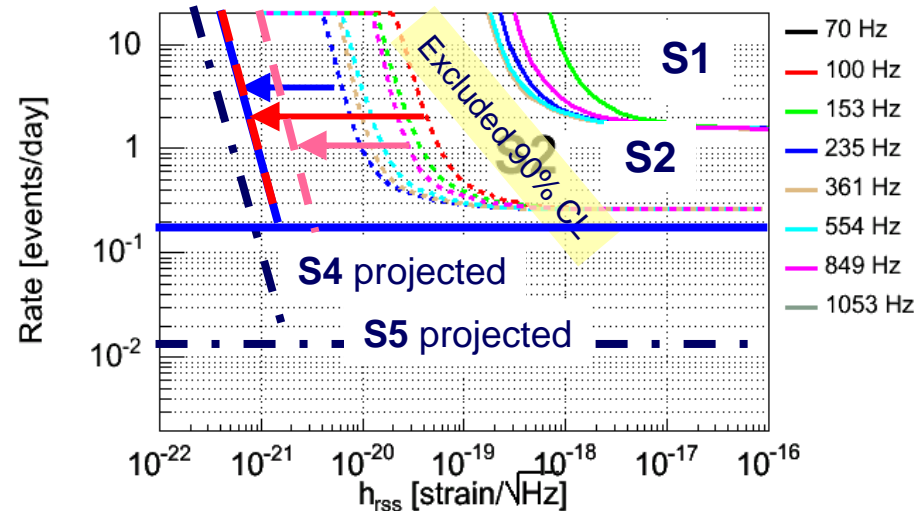

- S1: First upper limits from LIGO on gravitational wave bursts, Phys. Rev. D 69, 102001 (2004)
- S2: Upper Limits on Gravitational Wave Bursts in LIGO's Second Science Run, Phys. Rev. D 72, 062001 (2005)
- S2: Upper Limits from the LIGO and TAMA Detectors on the Rate of Gravitational-Wave Bursts, Phys. Rev. D 72, 122004 (2005)
- S3: Search for gravitational wave bursts in LIGO's third science run, Class. Quant. Grav. 23, S29-S39 (2006)
- S4: results completed, paper in progress
- S5 analysis in progress



HETE GRB030329 (~800 Mpc SN):
during S2, search resulted in no
detection (**PRD** 72, 042002, 2005)

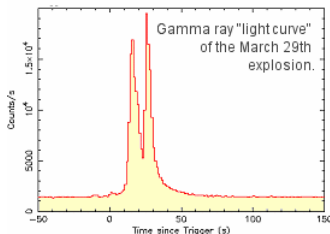

Soft Gamma Repeater 1806-20

- galactic neutron star (10-15 kpc) with intense magnetic field ($\sim 10^{15}$ G)
- source of record gamma-ray flare on December 27, 2004
- quasi-periodic oscillations found in RHESSI and RXTE x-ray data
- search S4 LIGO data for GW signal associated with quasi-periodic oscillations-- **no GW signal found**
- sensitivity: $E_{GW} \sim 10^{-7}$ to 10^{-8} Msun for the 92.5 Hz QPO**
- this is the same order of magnitude as the EM energy emitted in the flare

Gamma-Ray Bursts

- search LIGO data surrounding GRB trigger using cross-correlation method
- no GW signal found associated with 39 GRBs in S2, S3, S4 runs**
- set limits on GW signal amplitude
- 53 GRB triggers for the first five months of LIGO S5 run
- typical S5 sensitivity at 250 Hz:**
 $E_{GW} \sim 0.3 M_{sun}$ at 20 Mpc

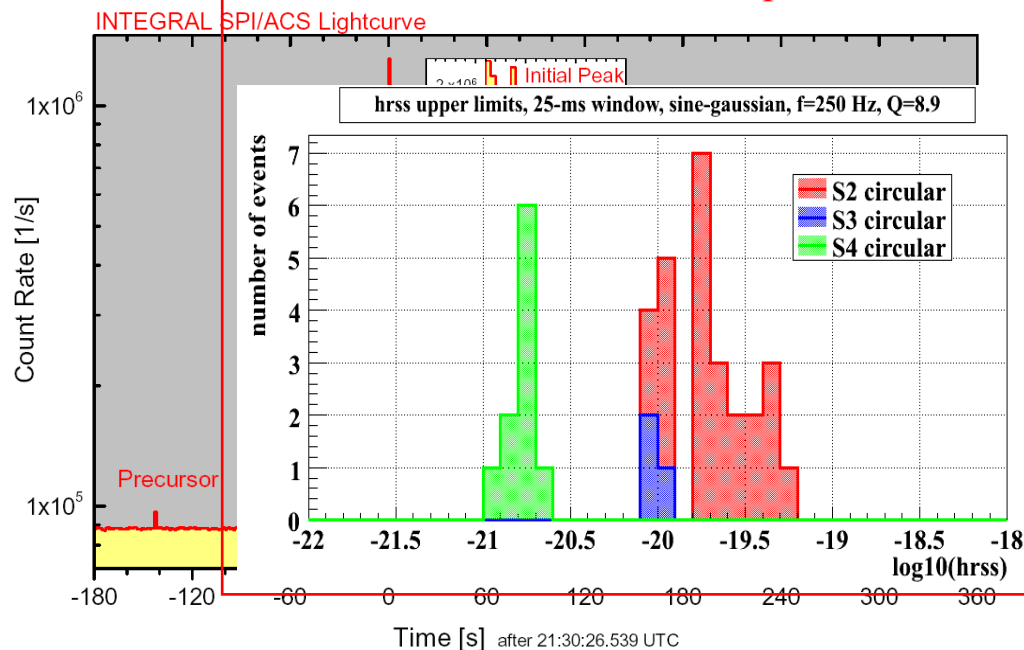

Searches for coalescing compact binary signals in S5

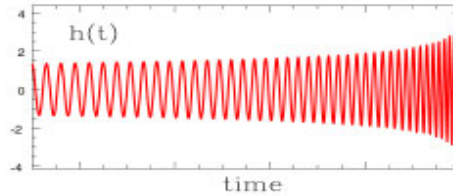

$$f_{\text{coal}} \sim 1/M$$

binary neutron star
horizon distance: **25 Mpc**

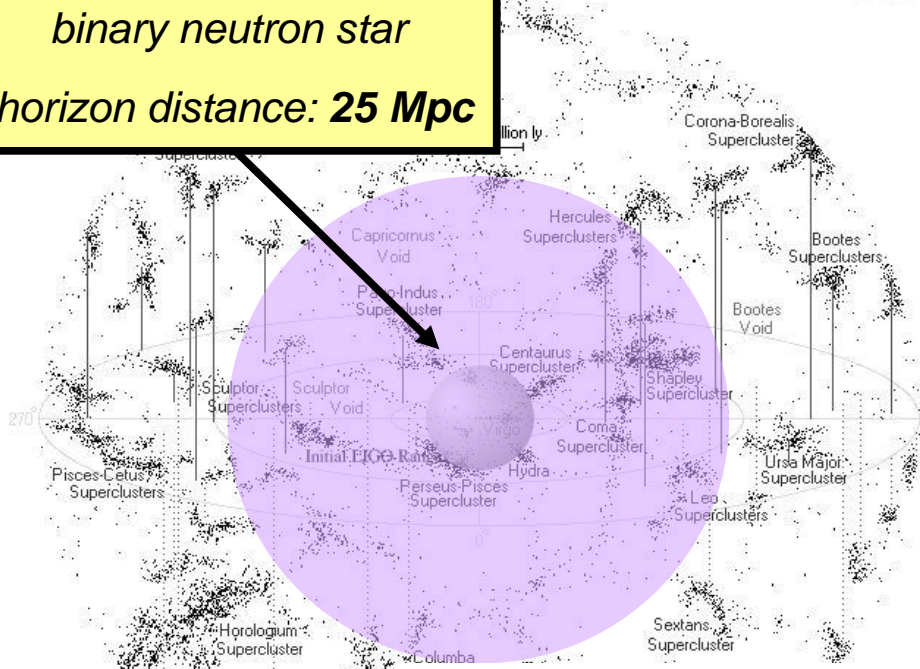

binary black hole
horizon distance

- 3 months of S5 data analyzed
- 1 calendar yr in progress

Inspiral Horizon distance vs mass

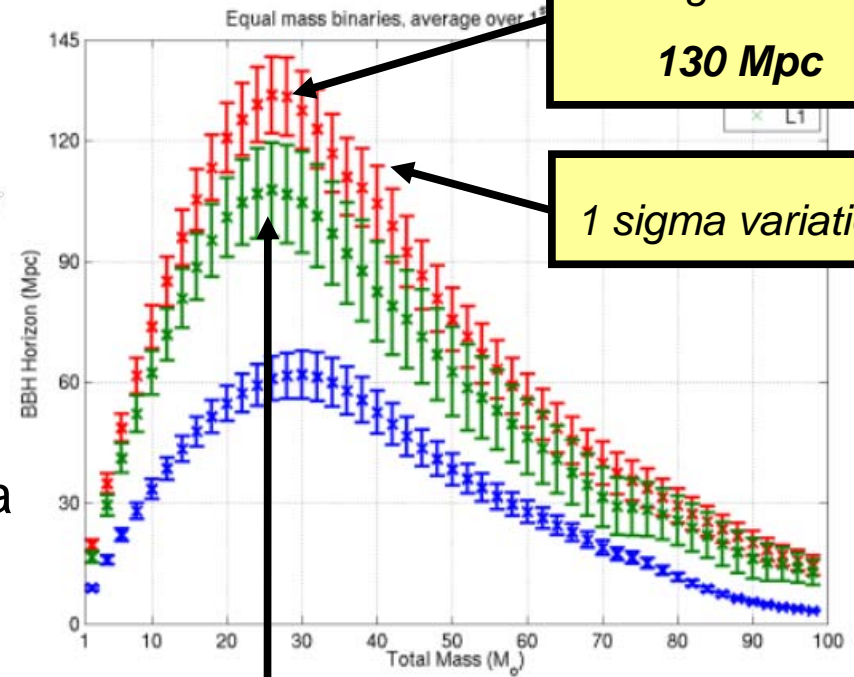

Average over run
130 Mpc

1 sigma variation

Peak at total mass $\sim 25M_{\text{sun}}$

Search for binary systems



John Rowe, CSIRO

- Use two or more detectors: search for double or triple *coincident* “triggers”
- Can infer masses and “effective” distance.
- Estimate false alarm probability of resulting candidates: detection?
- Compare with expected efficiency of detection and surveyed galaxies: upper limit

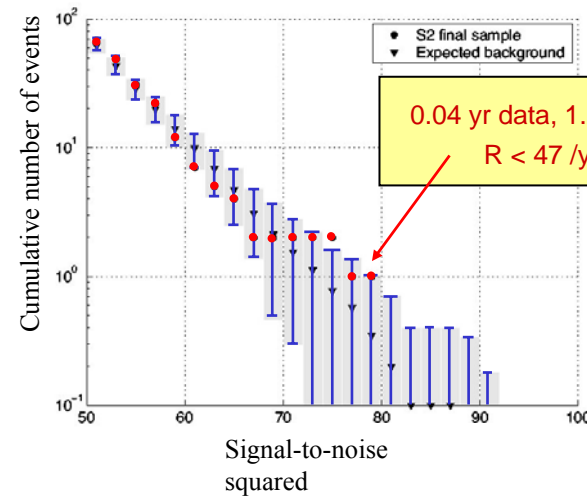
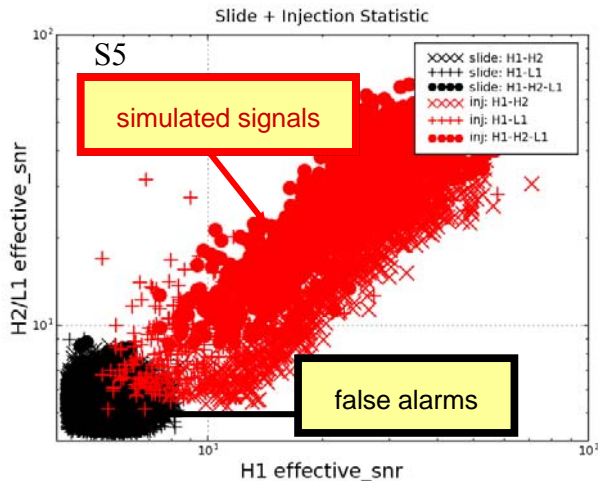

B. Abbott et al. (LIGO Scientific Collaboration):

- S1: Analysis of LIGO data for gravitational waves from binary neutron stars, Phys. Rev. D 69, 122001 (2004)
- S2: Search for gravitational waves from primordial black hole binary coalescences in the galactic halo, Phys. Rev. D 72, 082002 (2005)
- S2: Search for gravitational waves from galactic and extra-galactic binary neutron stars, Phys. Rev. D 72, 082001 (2005)
- S2: Search for gravitational waves from binary black hole inspirals in LIGO data, Phys. Rev. D 73, 062001 (2006)
- S2: Joint Search for Gravitational Waves from Inspiralling Neutron Star Binaries in LIGO and TAMA300 data (LIGO, TAMA collaborations), PRD, in press
- S3, S4: finished searched for BNS, BBH, PBBH: no detection; paper in progress
- S5: analysis in progress

Gravitational Wave sources: Stochastic Background

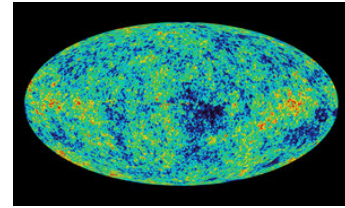

NASA, WMAP

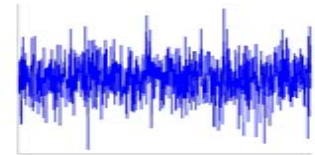

- A primordial GW stochastic background is a prediction from most cosmological theories.
- Given an energy density spectrum $\Omega_w(f)$, there is a strain power spectrum:

$$\Omega_{GW}(f) = \frac{1}{\rho_c} \frac{d\rho_{GW}(f)}{d \ln f}$$

$$S_{gw}(f) = \frac{3H_0^2}{10\pi^2} f^{-3} \Omega_{gw}(f)$$

$$h(f) = S_{gw}^{1/2}(f) = 5.6 \times 10^{-22} h_{100} \sqrt{\Omega_0} \left(\frac{100\text{Hz}}{f} \right)^{3/2} \text{Hz}^{1/2}$$

- The signal can be searched from cross-correlations in different pairs of detectors: L1-H1, H1-H2, L1-ALLEGRO... the farther the detectors, the lower the frequencies that can be searched.

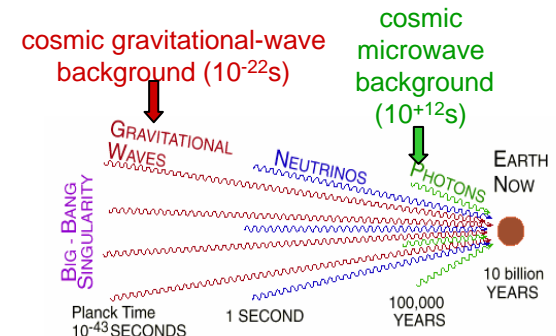

Gravitational Wave sources: Stochastic Background

- Cross-correlate signals between 2 interferometers
- LIGO S1: $\Omega_{\text{GW}} < 44$
PRD 69 122004 (2004) $H_0 = 72 \text{ km/s/Mpc}$
- LIGO S3: $\Omega_{\text{GW}} < 8.4 \times 10^{-4}$
PRL 95 221101 (2005)
- LIGO S4: $\Omega_{\text{GW}} < 6.5 \times 10^{-5}$ (new upper limit; accepted for publication in ApJ)
 - Bandwidth: 51-150 Hz;
- Initial LIGO, 1 yr data
Expected sensitivity $\sim 4 \times 10^{-6}$
upper limit from Big Bang nucleosynthesis 10^{-5} ; interesting scientific territory
- Advanced LIGO, 1 yr data
Expected Sensitivity $\sim 1 \times 10^{-9}$

Cosmic strings (?) $\sim 10^{-8}$
Inflation prediction $\sim 10^{-14}$

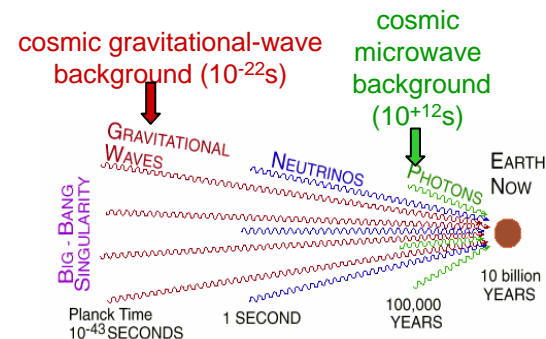

Predictions are difficult... many unknowns!

- Rotating stars: how lumpy are they?
- Supernovae, gamma ray bursts: how strong are the waves (and what do they look like)?
- Cosmological background: how did the Universe evolve?
- Binary black holes: how many are there? What masses do they have?
- Binary neutron stars: from observed systems in our galaxy, predictions are up to 1/3yrs, but most likely one per 30 years, at LIGO's present sensitivity.
- From rate of short GRBs, much more optimistic predictions for BNS and BBH rates? □ Ready to be tested with S5!

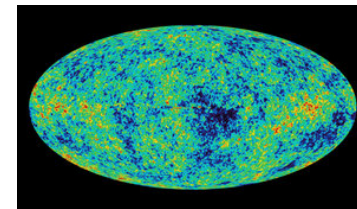
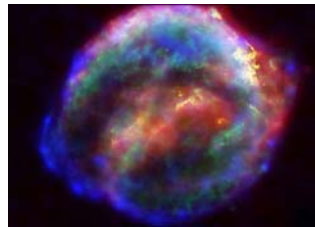
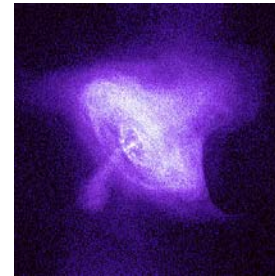

- **Neutron Star Binaries:**

Initial LIGO: ~10-20 Mpc →
 Advanced LIGO: ~200-350 Mpc

Most likely rate: 1 every 2 days !

- **Black hole Binaries:**

Up to $30 M_{\odot}$, at ~ 100 Mpc
 → up to $50 M_{\odot}$, in most of the observable Universe!

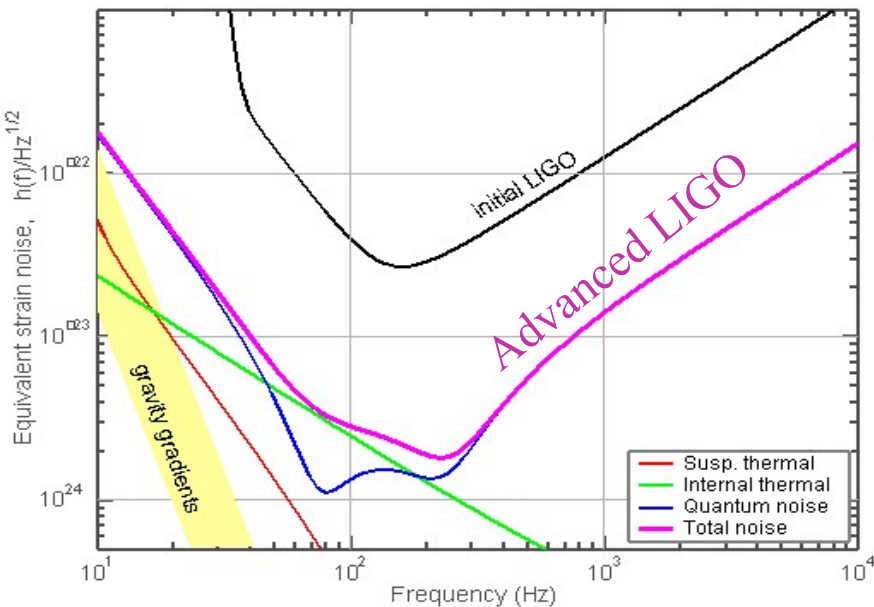
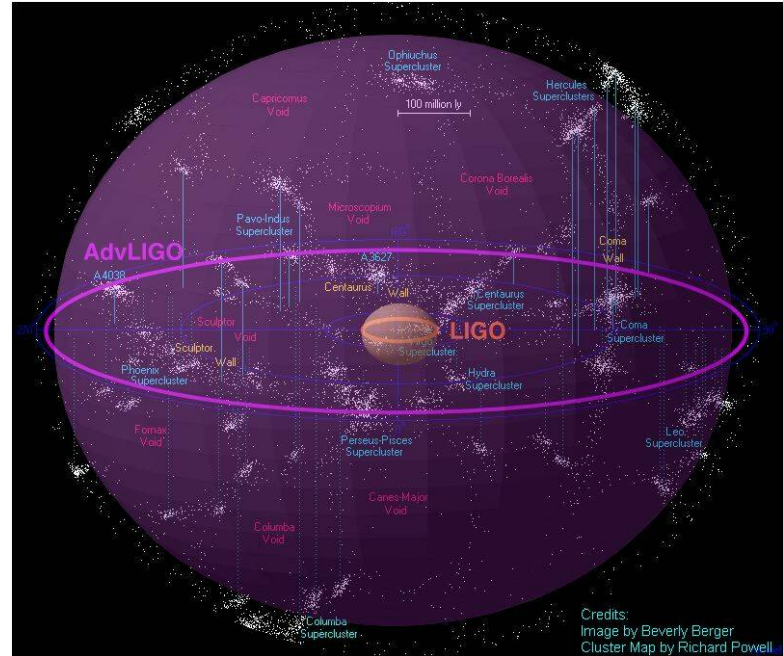

x10 better amplitude sensitivity
 ⇒ **x1000** rate=(reach)³
 ⇒ 1 year of Initial LIGO
 < 1 day of Advanced LIGO !

Planned NSF Funding in FY'08
 budget (being discussed right now!).

LIGO

Space interferometer: **LISA**

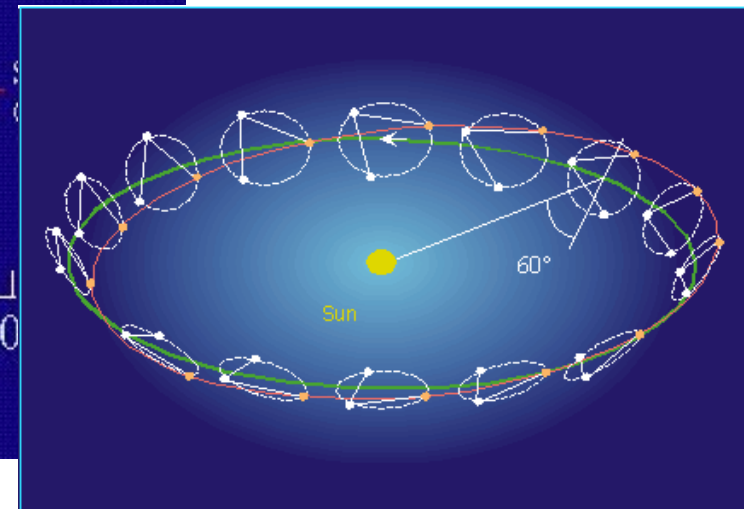
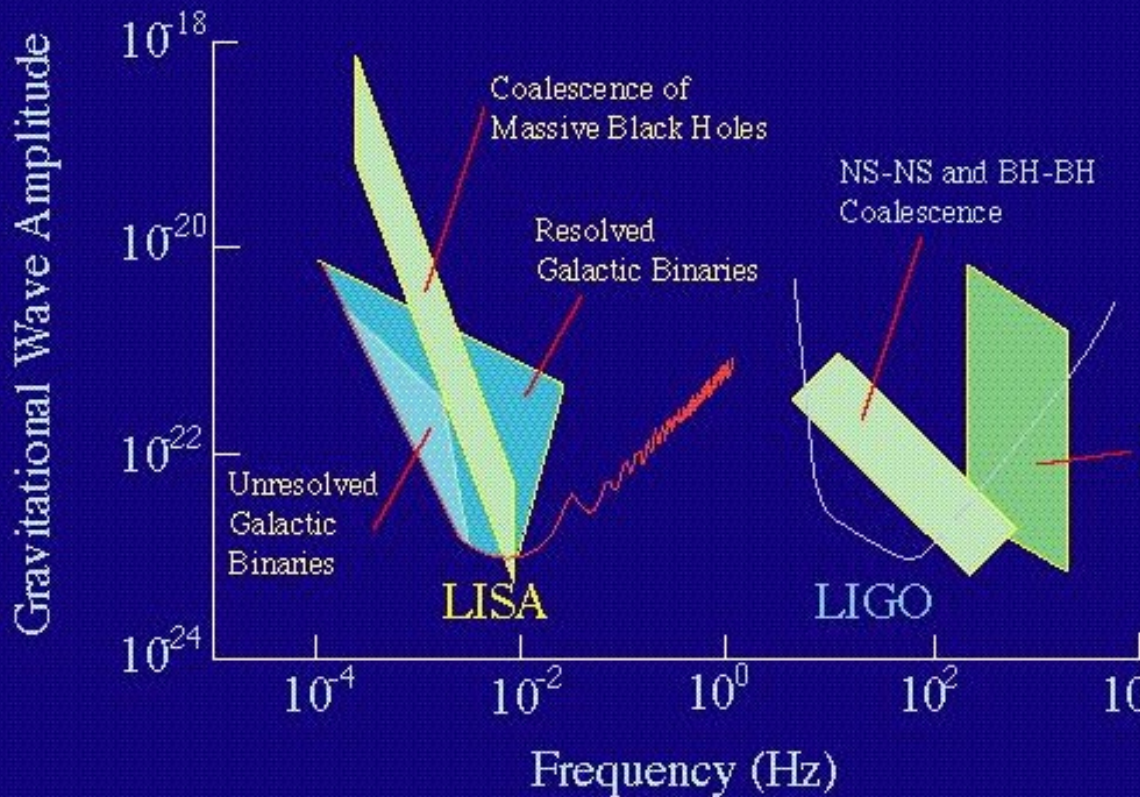

Displacement Sensitivity for the LIGO 4km Interferometers

Performance for S5 - June 2006 LIGO-G060292-00-E

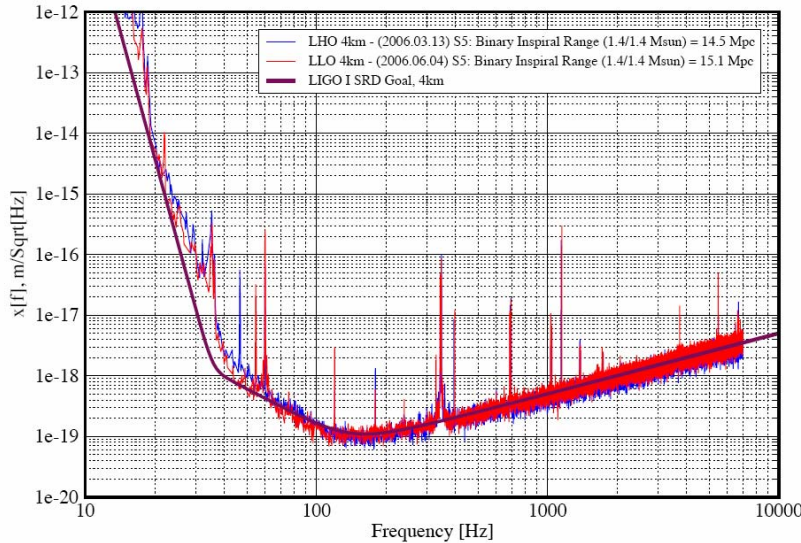

- We are taking data at unprecedented sensitivity, and we are searching for gravitational waves.
- We are getting ready for Advanced LIGO.

- We are preparing ourselves for a direct observation of gravitational waves: not if, but when!
- LIGO detectors and their siblings will open a new window to the Universe: what's out there?





Back up slides

Present, future

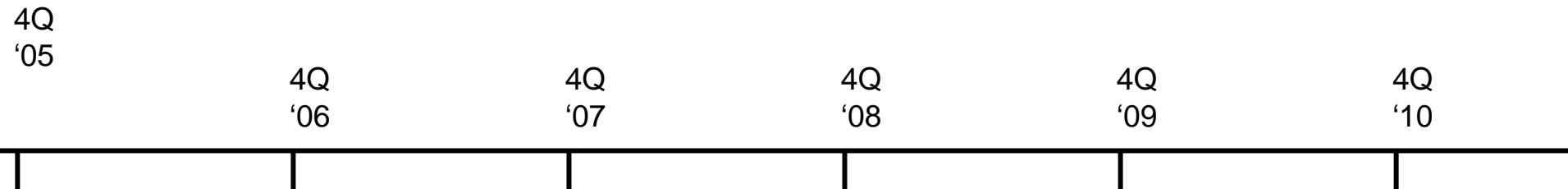

today ↑

BNS: 1/30 yr
BBH: ??

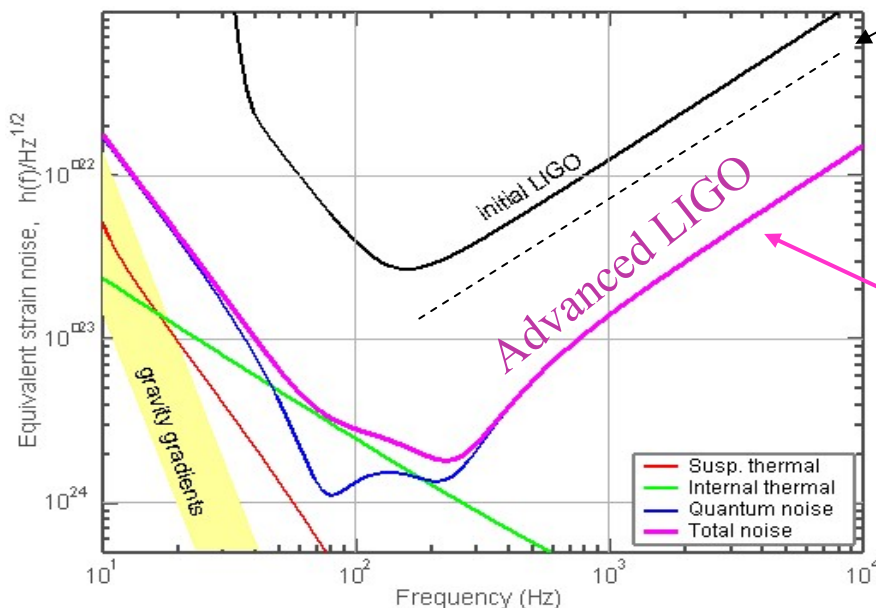

BNS: 1/2days
BBH: we'll measure it!

Stochastic Background: the landscape

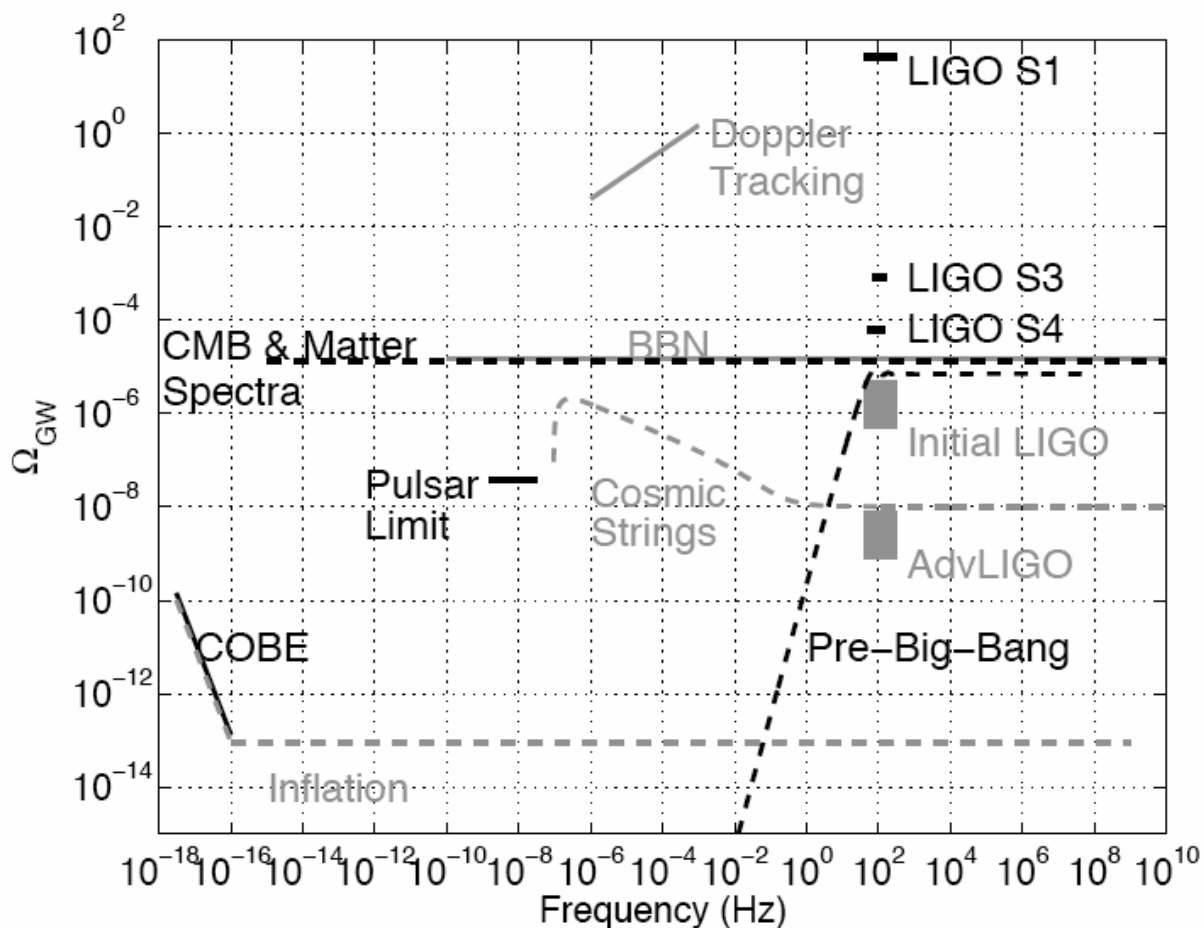

Interferometer Noise

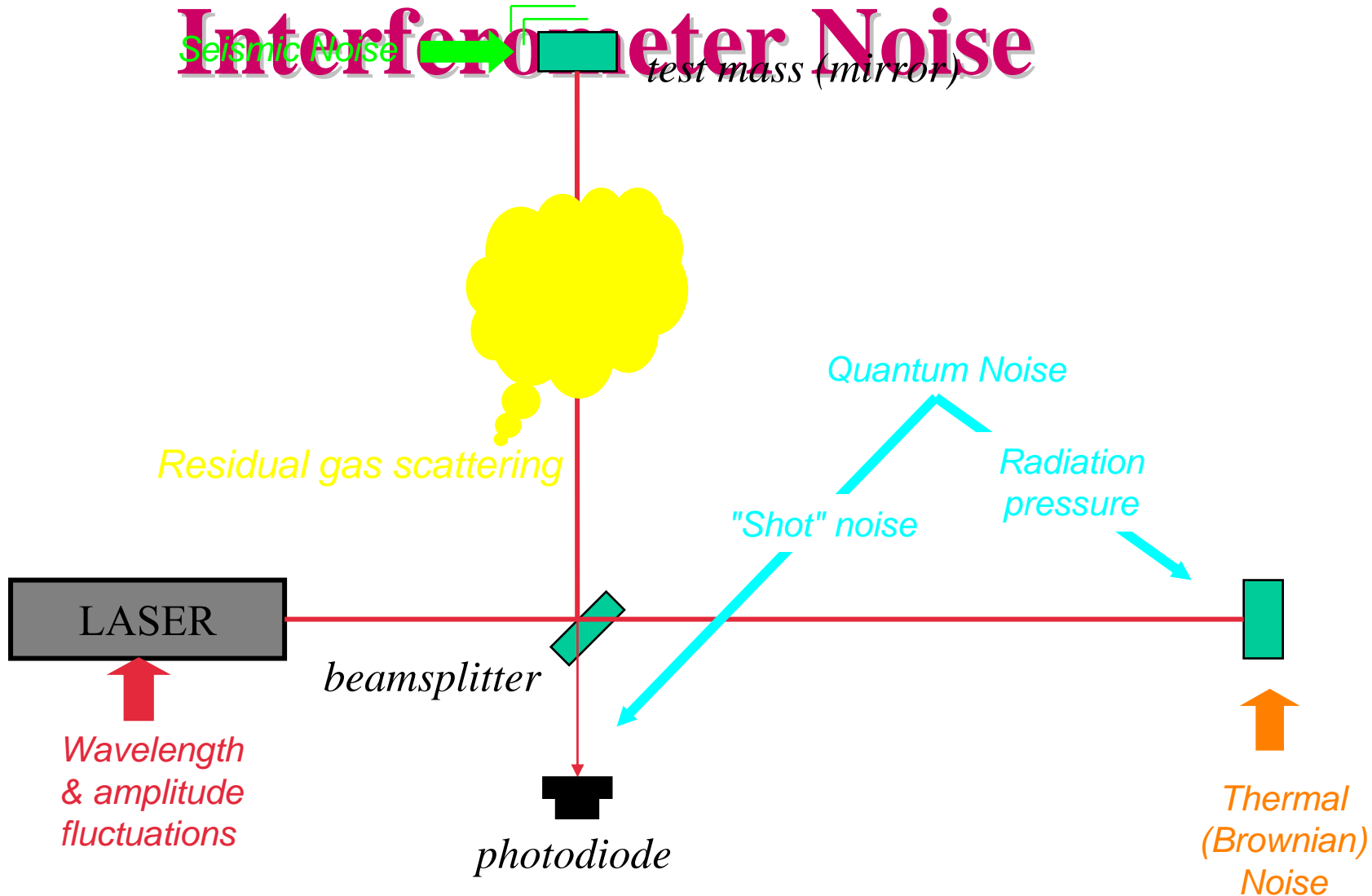

Initial sensitivity limits

- seismic noise at the lowest frequencies
- shot noise at high frequencies
- thermal noise at intermediate frequencies

Based on conservative extrapolation of prototype technologies (circa ~'97)

Facility limits designed much lower to allow improvement as detector technology advances

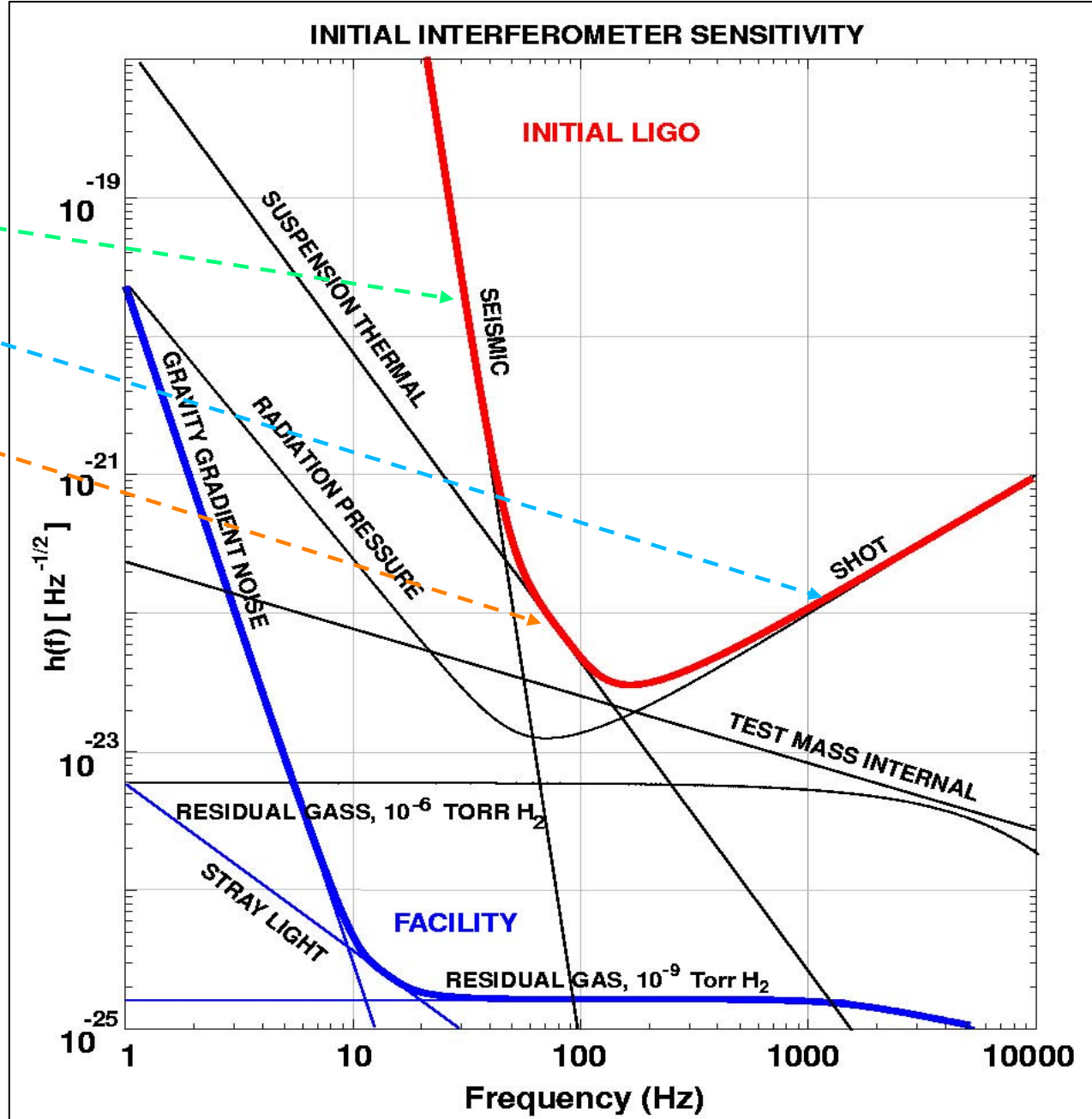

Beam Tubes and Enclosures

Precast concrete enclosure: *bulletproof*

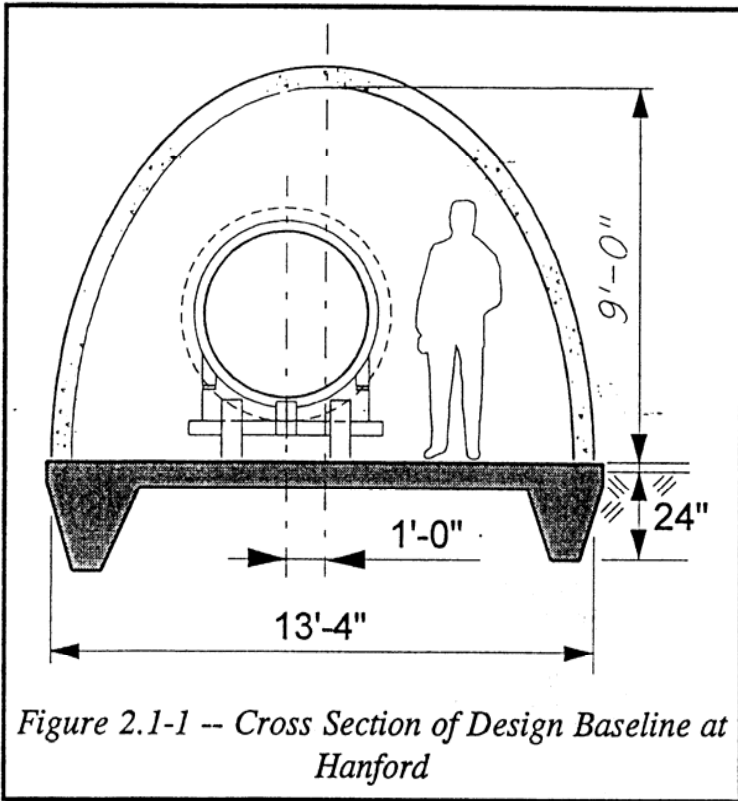

- **Beam Tube**
 - 1.2m diam; 3 mm stainless
 - special low-hydrogen steel process
 - 65 ft spiral weld sections
 - 50 km of weld (NO LEAKS!)
 - 20,000 m³ @ 10⁻⁸ torr; earth's largest high vacuum system

Vacuum Equipment



Seismic Isolation System

Tubular coil springs with internal constrained-layer damping, layered with reaction masses

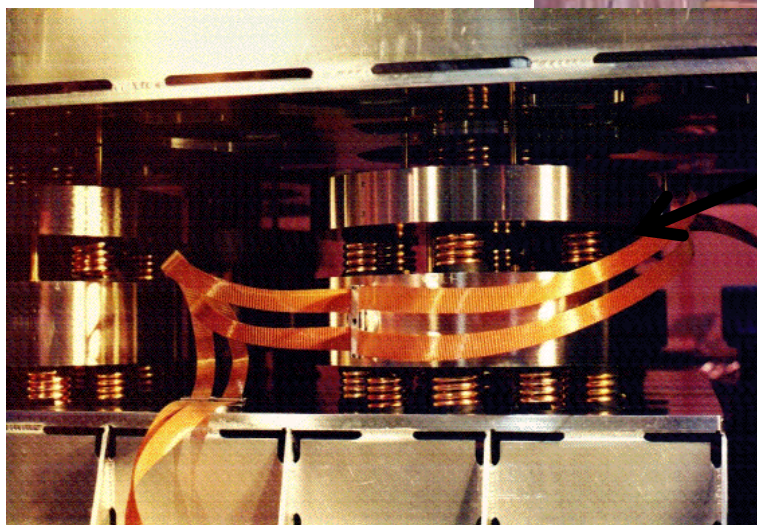

Isolation stack in chamber

Core Optic Suspensions

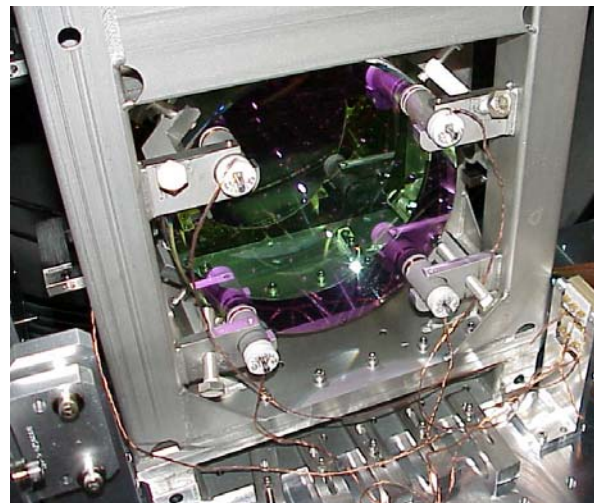

Interferometry

- Want "optical" arm length $\sim \lambda_{GW} / 4$ for best antenna response

- Adds complexity; now each arm needs to be held near

$$L = k * \lambda_{LASER} / 2$$

- Add mirror to "recycle" photons (equivalent to more laser power)

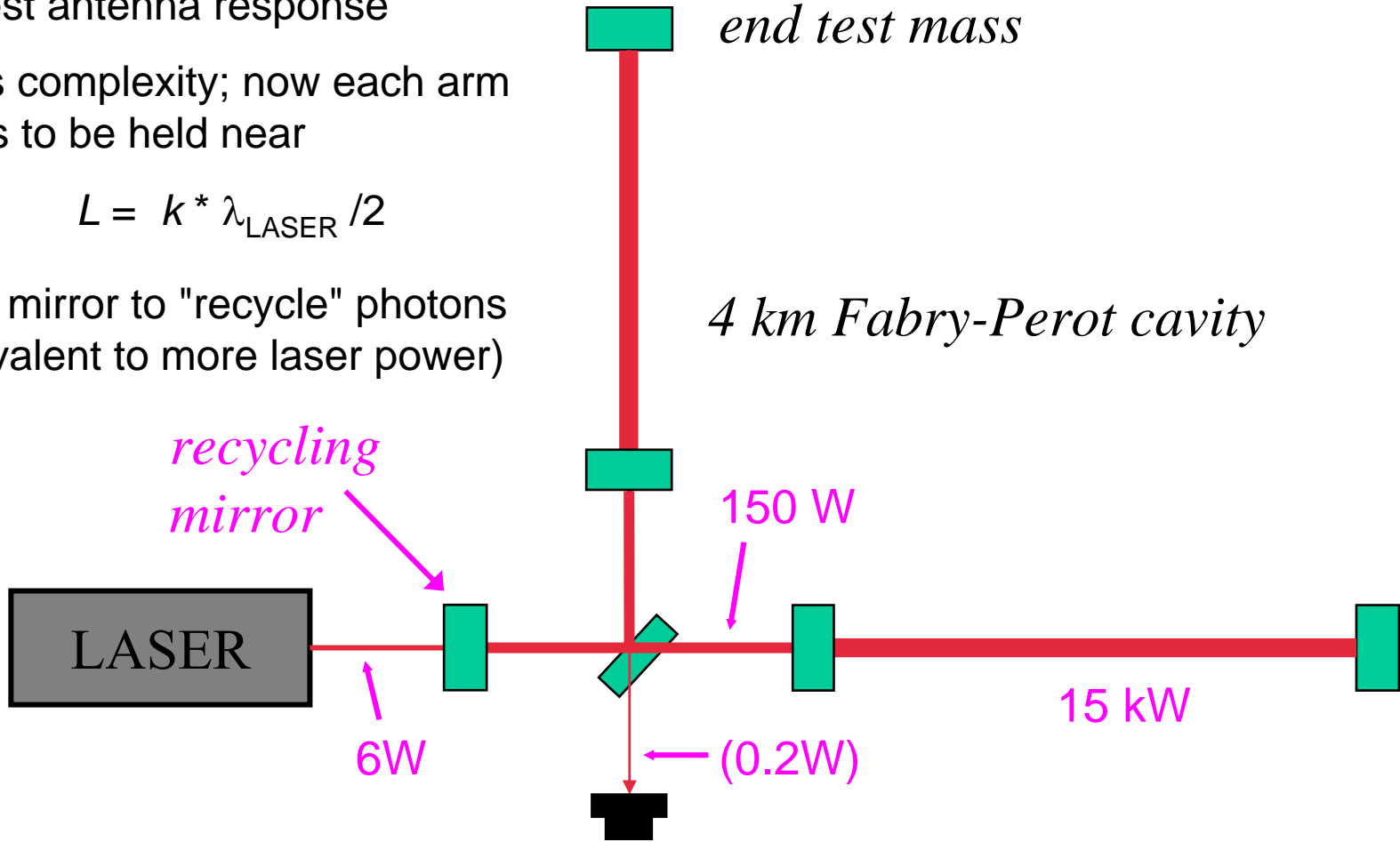

Core Optics

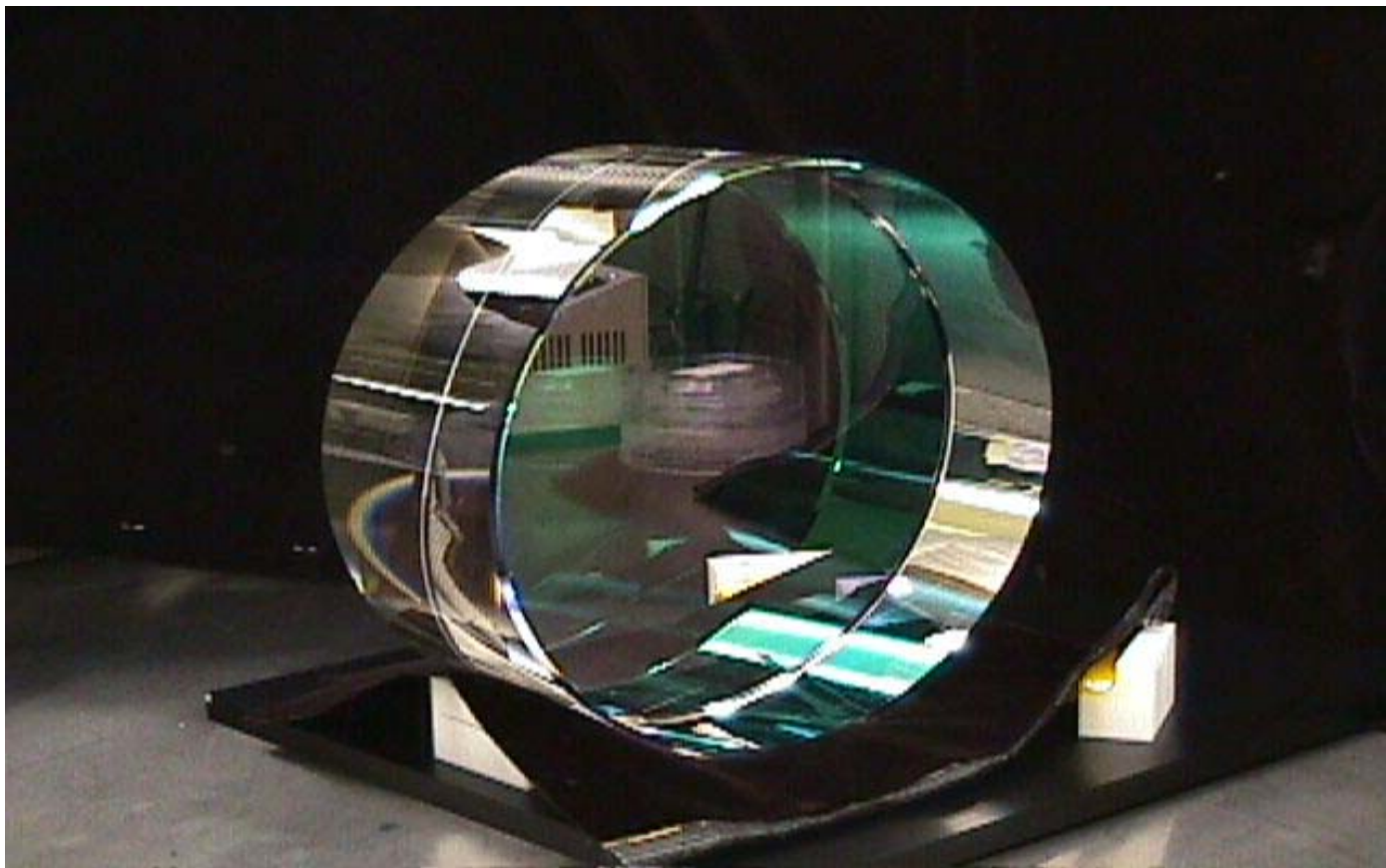

Core Optic Metrology

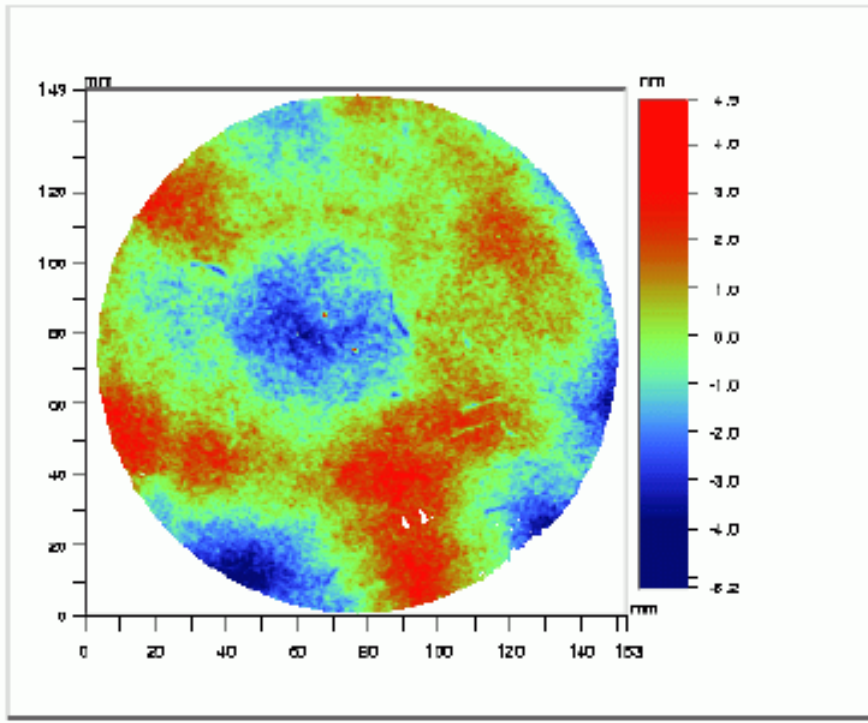

LIGO data (1.2 nm rms)

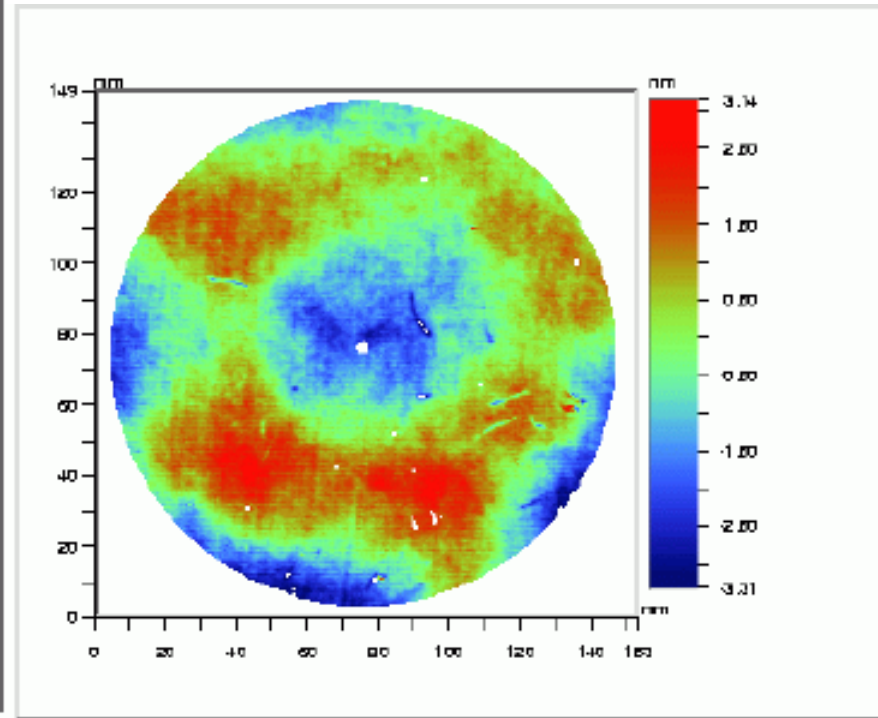

CSIRO data (1.1 nm rms)

➤ *Best mirrors are $\lambda/6000$ over the central 8 cm diameter*

Thermal Compensation System

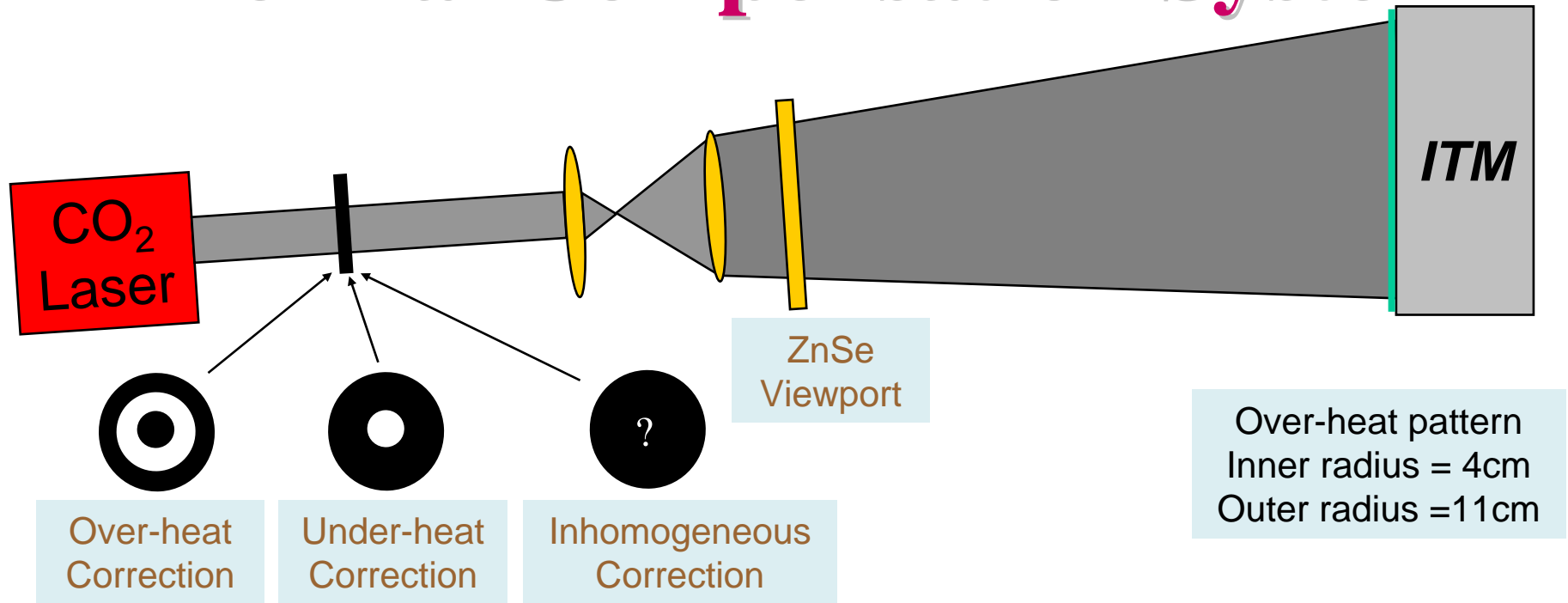

- Cold power recycling cavity is unstable: poor buildup and mode shape for the RF sidebands
- Require 10's of mW absorbed by 1 μ m beam



<http://www.einsteinathome.org/>

- GEO-600 Hannover
- LIGO Hanford
- LIGO Livingston
- Current search point
- Current search coordinates
- Known pulsars
- Known supernovae remnants

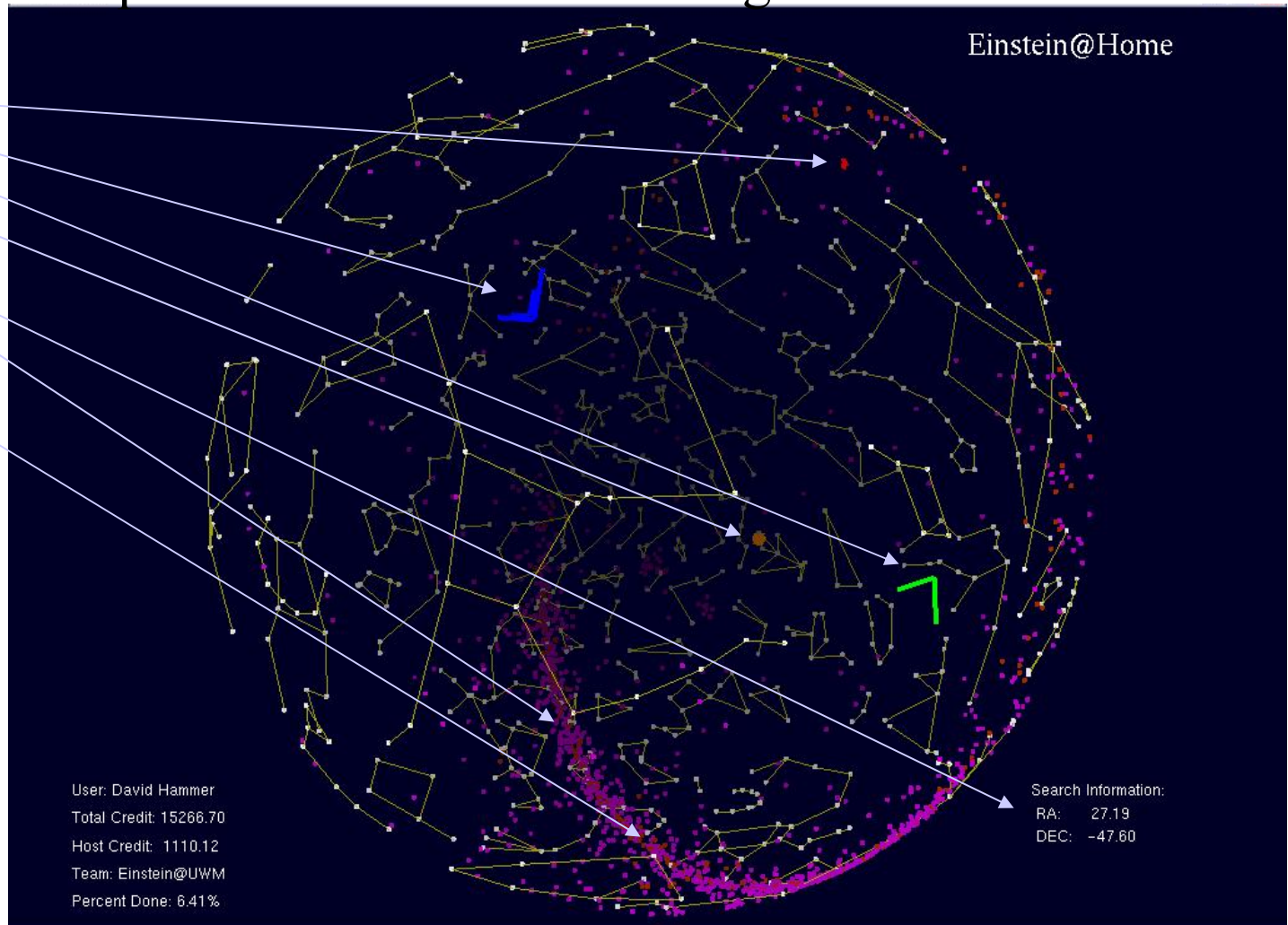

GW LIGO detectors: interferometers

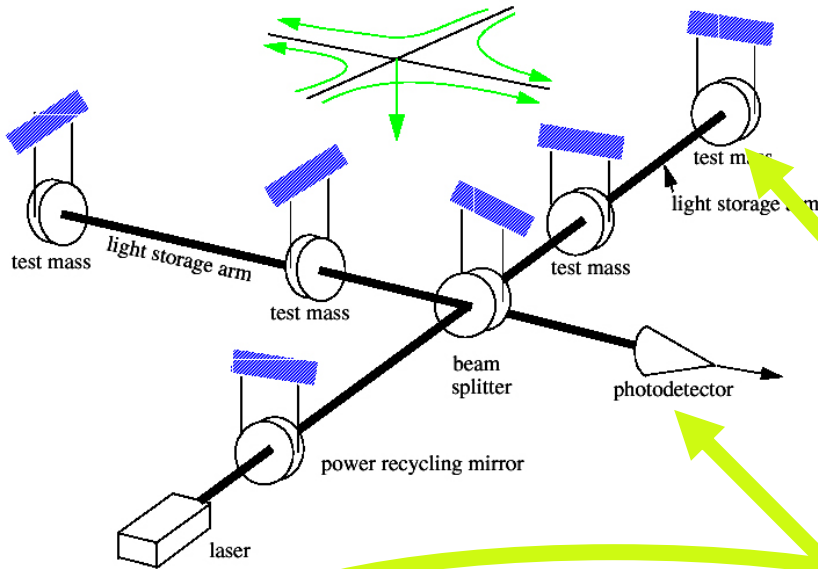

QuickTime™ and a
Animation decompressor
are needed to see this picture.

**suspended test masses
("freely falling objects")**

**dark port
(RF heterodyne modulation)**

