

Investigation of nonlinear crystals for optimizing squeezed vacuum sources for LIGO

Shally Saraf

Assistant Professor
Rochester Institute of Technology

Outline

- Scientific merit of proposed research
- Relevance to LIGO
- Capabilities of RIT Quantum Electronics Group
- Outreach
- Discussion

Proposed Research for Third-generation LIGO

- Build a compact OPO-based squeezer at RIT
 - Initial investigation using PPKTP
 - investigate other low-loss, high-nonlinear-coefficient materials (PPSLN/PPSLT/GaAs?)
 - GOAL: Achieve >10 dB squeezing with “squeezer-in-a-box”
- Investigate frequency-dependent squeeze angle generation
 - cavities and other techniques (EIT?)
 - GOAL: “Dial-in” the squeezing quadrature.

Scientific Merit

- Next generation GW interferometers such as Advanced LIGO will be quantum noise limited.
- To go beyond the SQL, we must reduce the quantum noise
- Quantum noise in LIGO
 - **Radiation pressure noise**
@ low frequencies (<70Hz)
 - **Shot noise**
@ high frequencies (>300Hz)

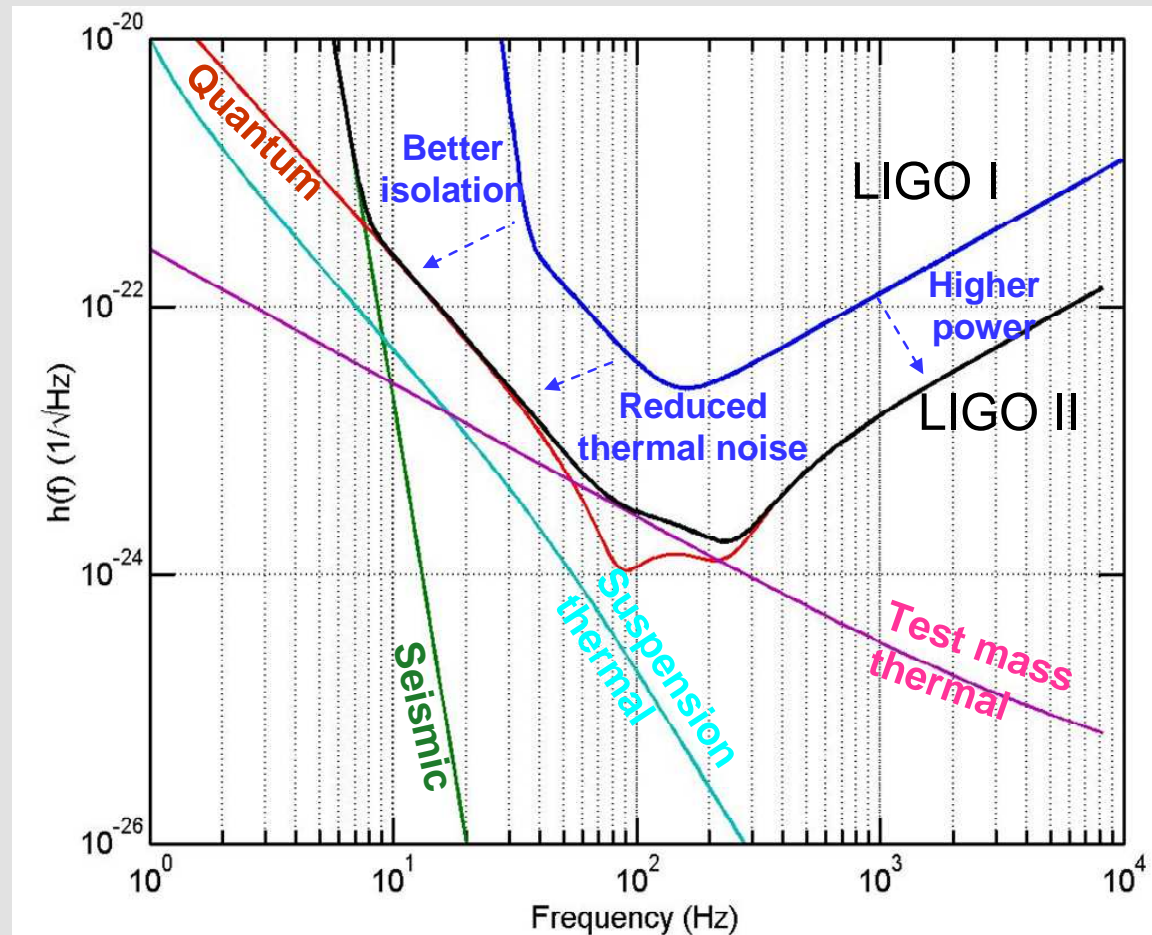

Squeezed states in the LIGO Michelson

- How do we increase the sensitivity of GW interferometers?
 - Inject a squeezed vacuum field into the dark port of a Michelson interferometer to replace vacuum noise.
 - Frequency dependent squeeze angle will increase sensitivity across GW detection band.

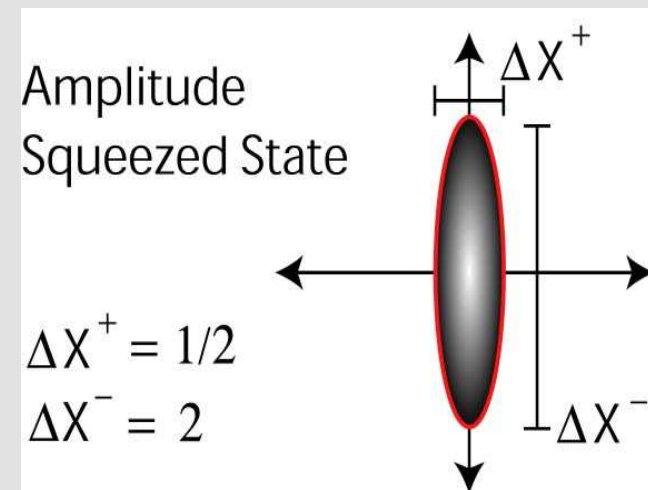
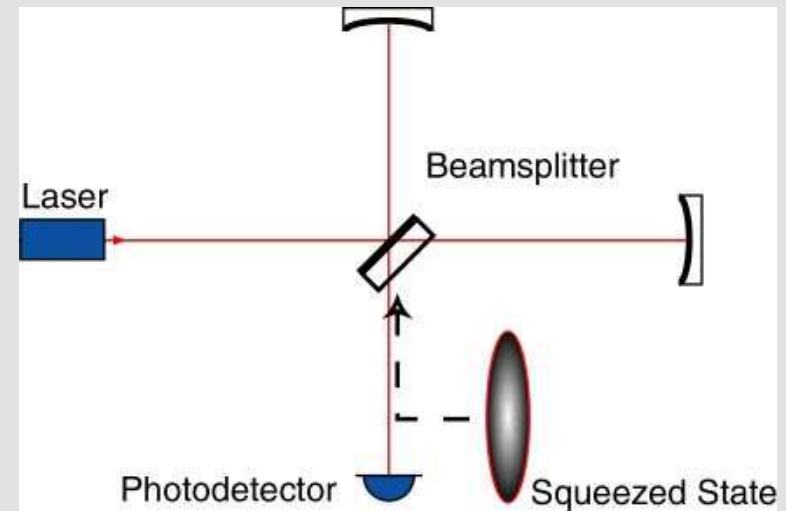

Proposed OPO-based Squeezer

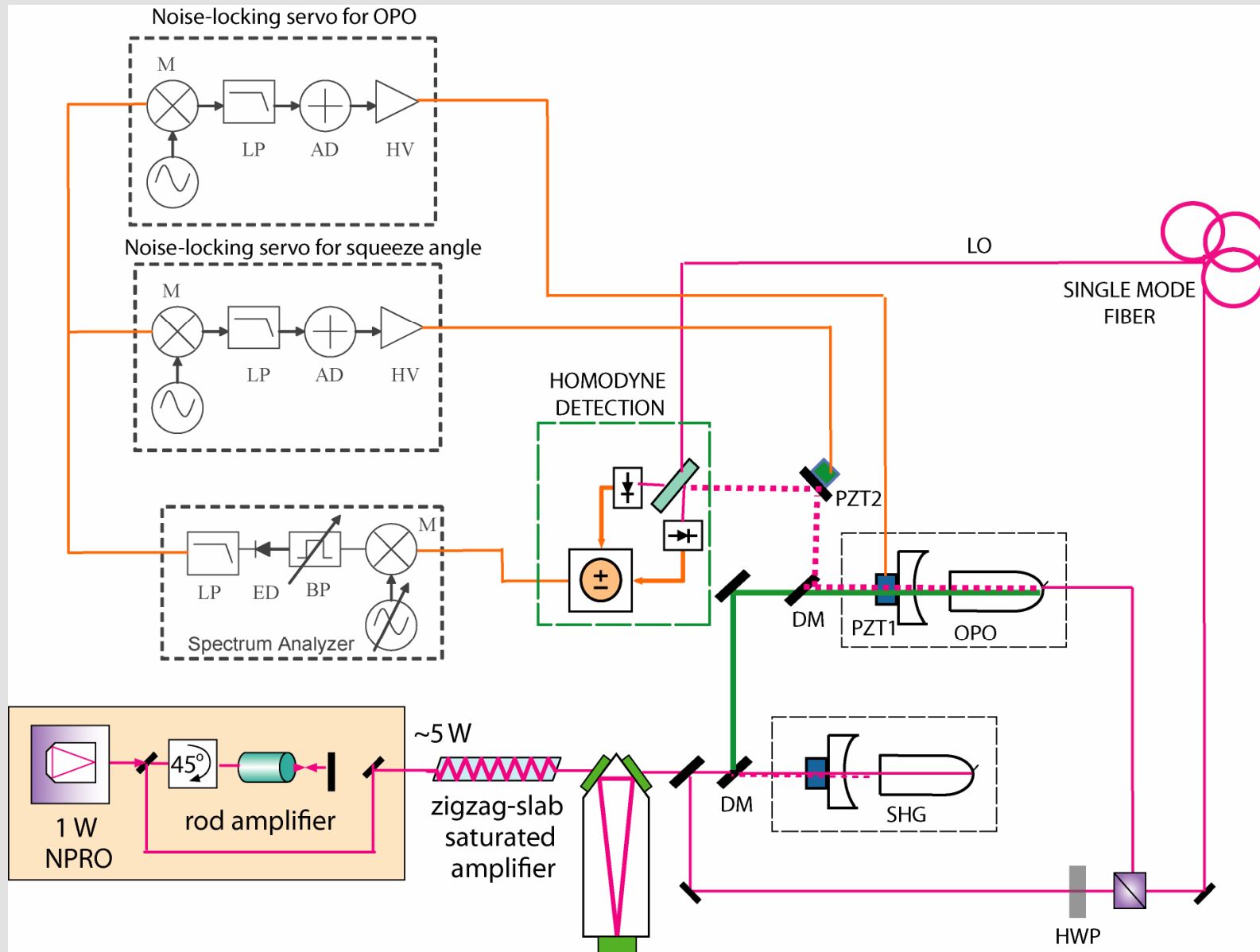

- Baseline design is similar to MIT design

Latest Squeezing Results at the 40 m

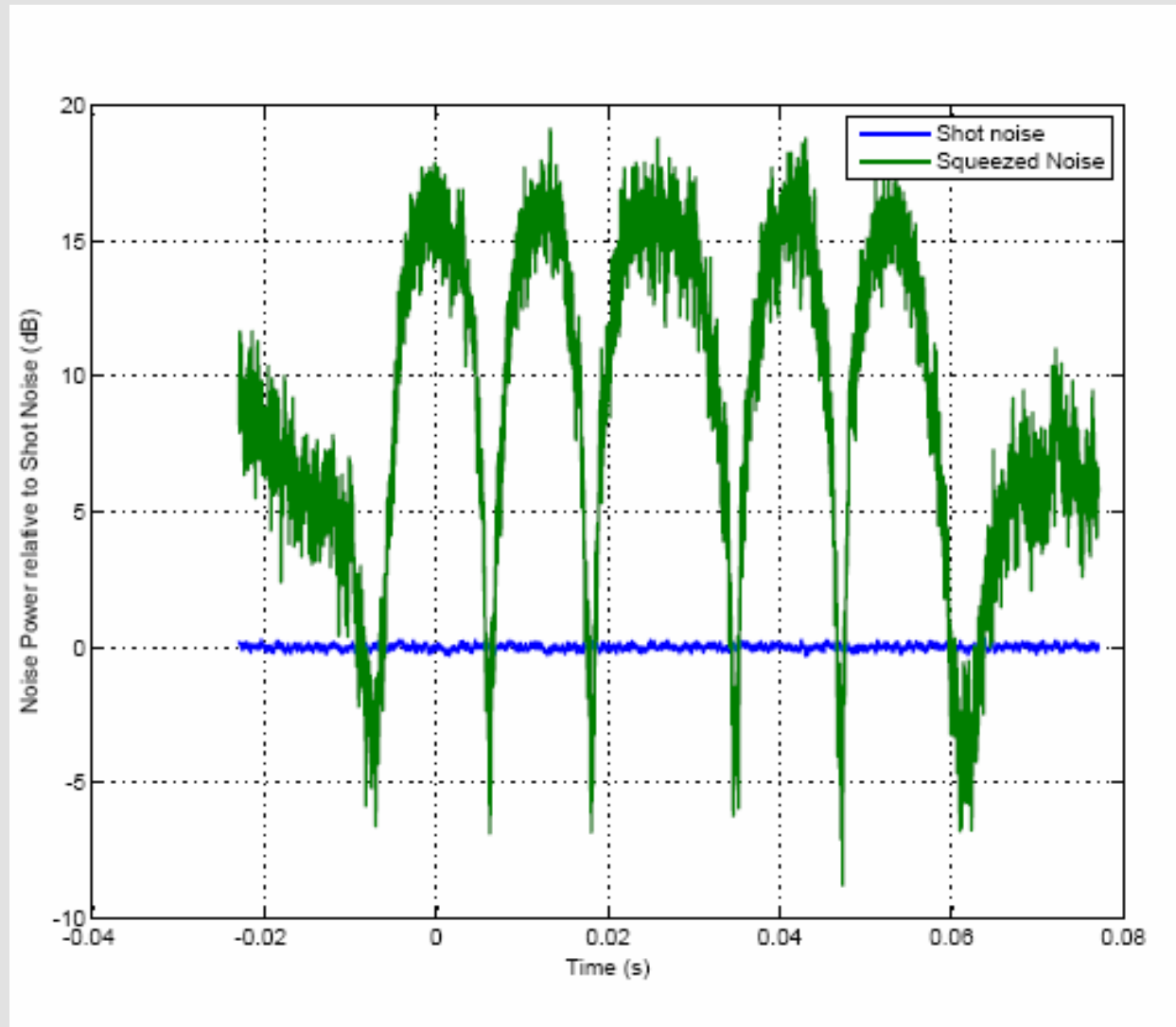

- >6 dB squeezing achieved in PPKTP!
- Quantum-noise locking of OPO to be implemented.

Impact of Optical Losses

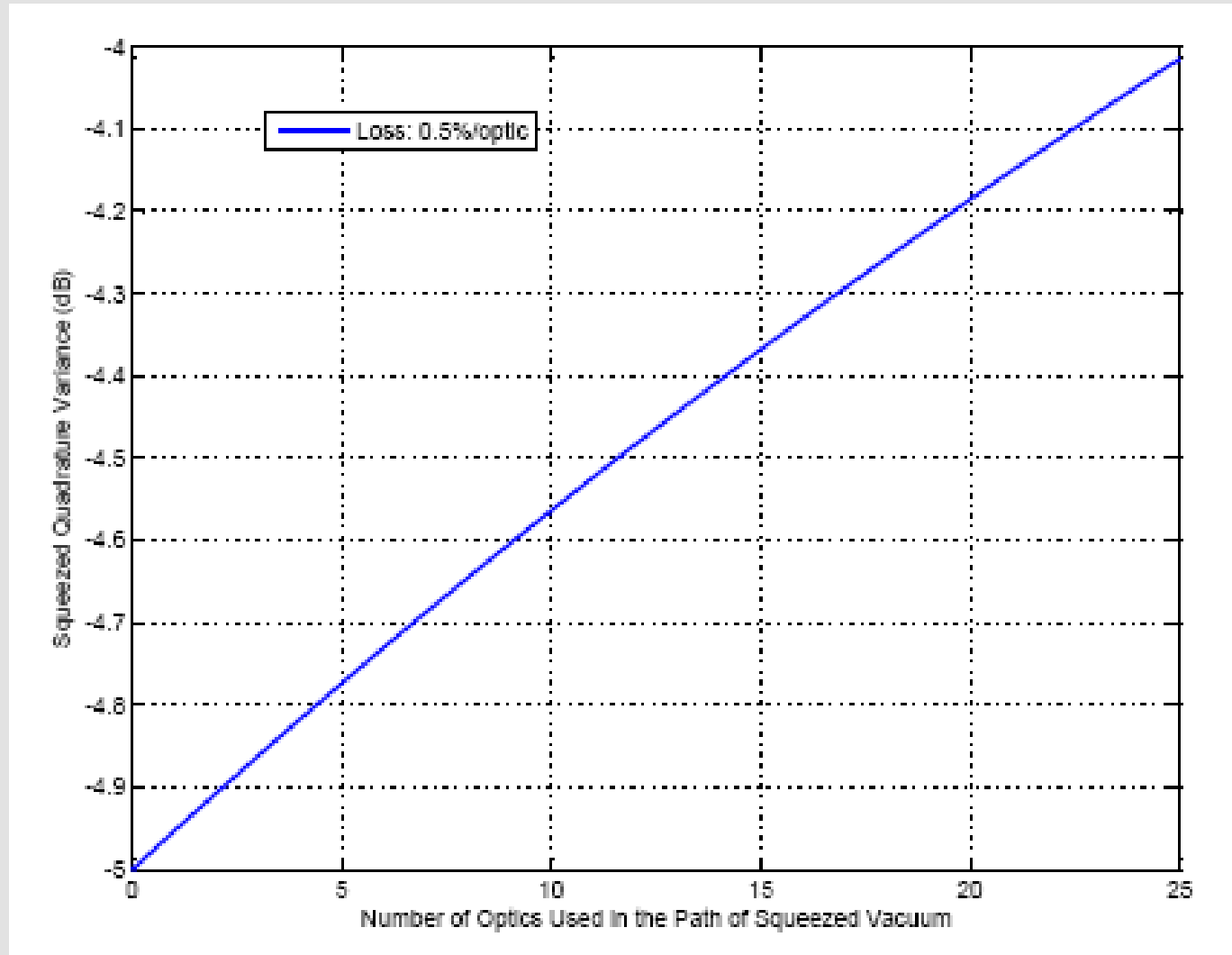

Capability to conduct proposed Research

Background of Shally Saraf

- Ph.D. thesis was on high-power laser development for LIGO and quantum noise measurements in saturated amplifiers.
- Expertise in the design and fabrication of mode cleaners for generating “quiet beams”.
- Expertise in electrical engineering.
- Currently collaborating with Nergis Mavalvala’s group at MIT on squeezed vacuum generation and injection at the 40 m interferometer at Caltech.

100-W-class Zigzag Slab Amplifier

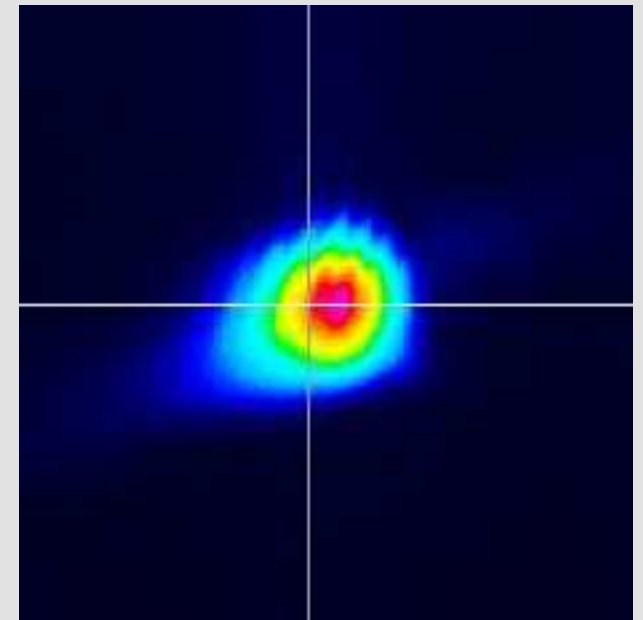
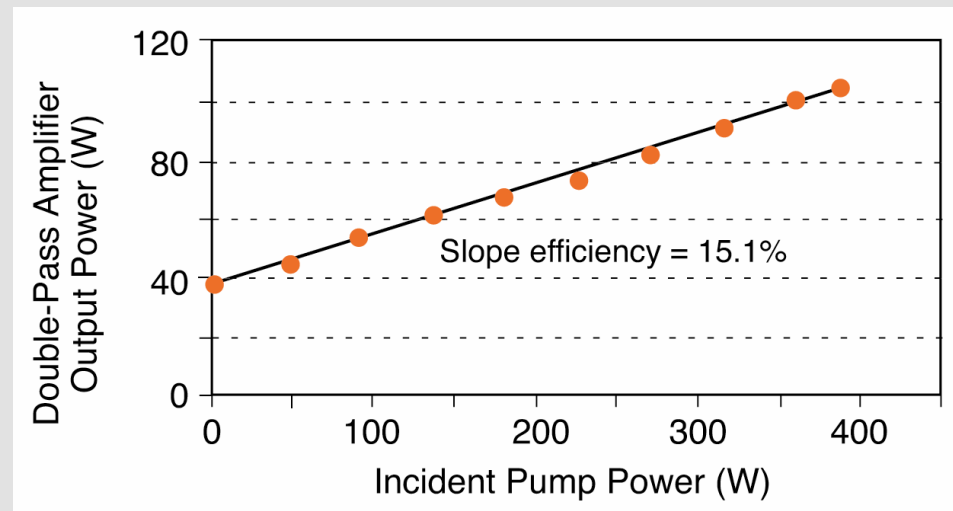
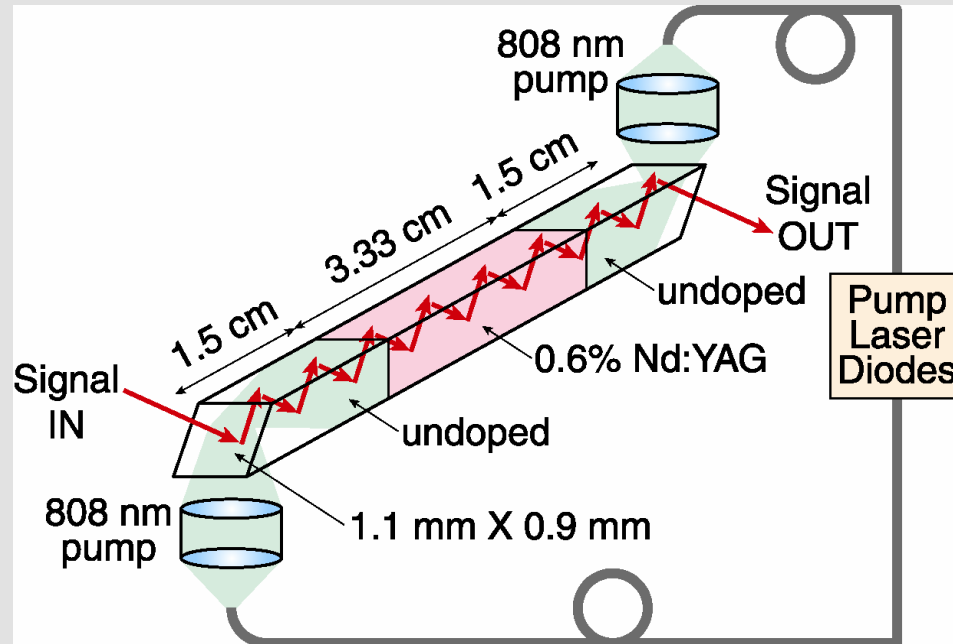

- 90% in TEM_{00} mode at 104 W output power!

Amplifier Quantum Noise Measurements

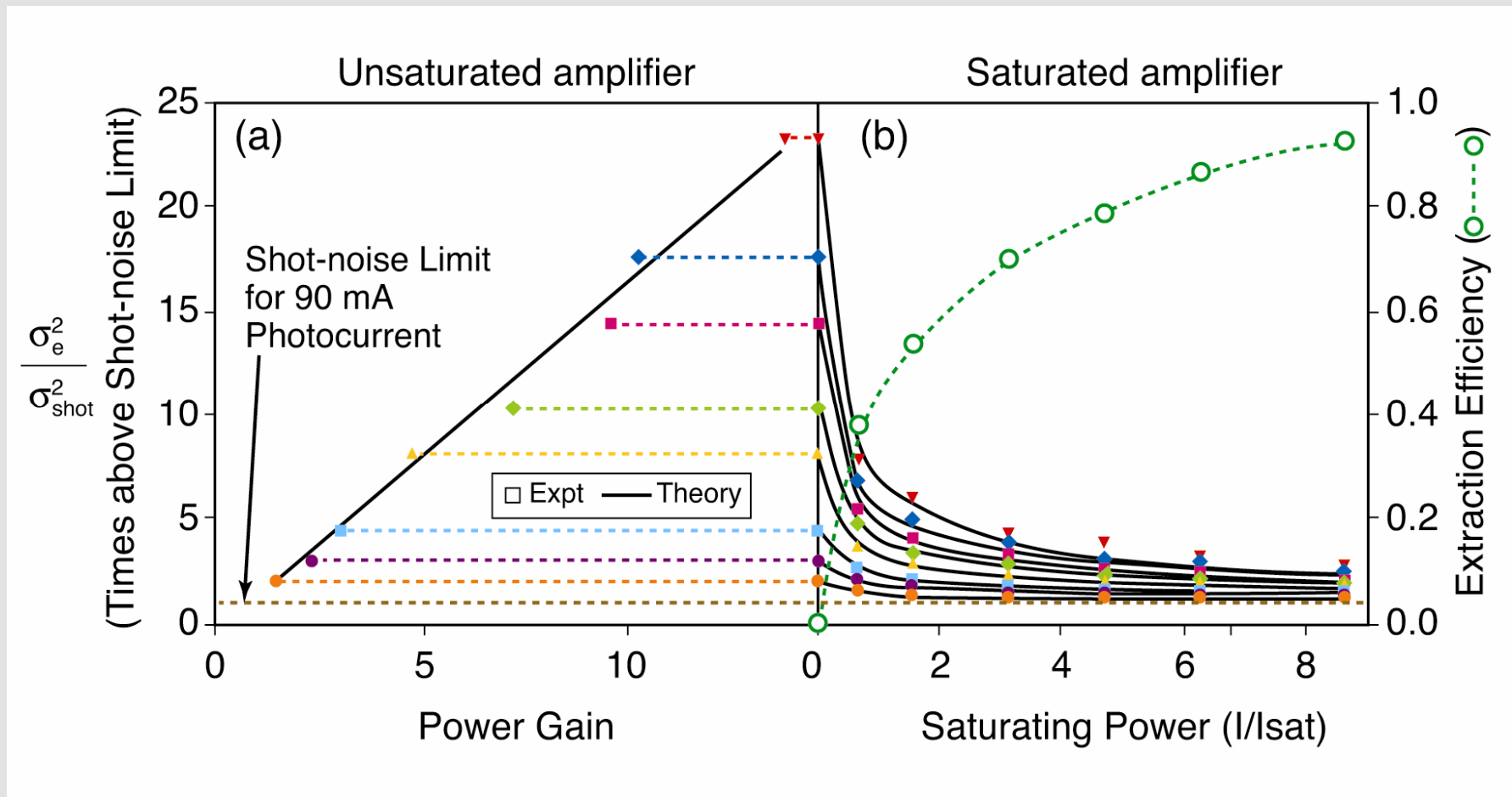

- Extraction efficiency increases and quantum noise decreases as the amplifier is saturated!

RIT Resources

- PI is currently developing a 640 square foot optics laboratory at RIT.
- One master's student is currently working on LIGO research. Anticipate adding a second student soon.
- PI is setting up a coherent optics program at RIT with six professors from physics, imaging science and astrophysics.
- Student pool would include undergraduate and graduate students from EE, physics, imaging science and astrophysics.

Other Resources

- Close working relationship with Nergis's group at MIT and Alan Weinstein at the 40 m interferometer.
- Anticipate forging relationship with quantum optics groups at ANU and AEI.
- Developing collaboration with Jonathan Zigel at the Laboratory for Laser Energetics in Rochester.

Outreach Potential of Proposed Research

- PI presently teaches courses in fields, optics and quantum electronics. LIGO is frequently incorporated into lectures and class assignments.
 - *Enrollment across disciplines in optics is increasing!*
- PI has given LIGO colloquiums in the RIT physics department and at LLE. He has scheduled LIGO seminars in the college of science and engineering.
- RIT has a substantial deaf population and the PI will attempt to incorporate deaf students into research.
- PI expects to direct one master's thesis per year in the immediate future and direct a few Ph.D. students as RIT and LIGO research at RIT grows.