



Commissioning LIGO in 2004

Rana Adhikari
November 8, 2004

Outline

- Sensitivity & Duty Cycle in the last Science Run
- Livingston
 - Active Seismic Isolation
 - Angular Control System (wavefront sensing)
- Hanford
 - High Power Operations
 - Active Thermal Compensation
 - Reduction of several noise sources
- Near term plans

LIGO Interferometers

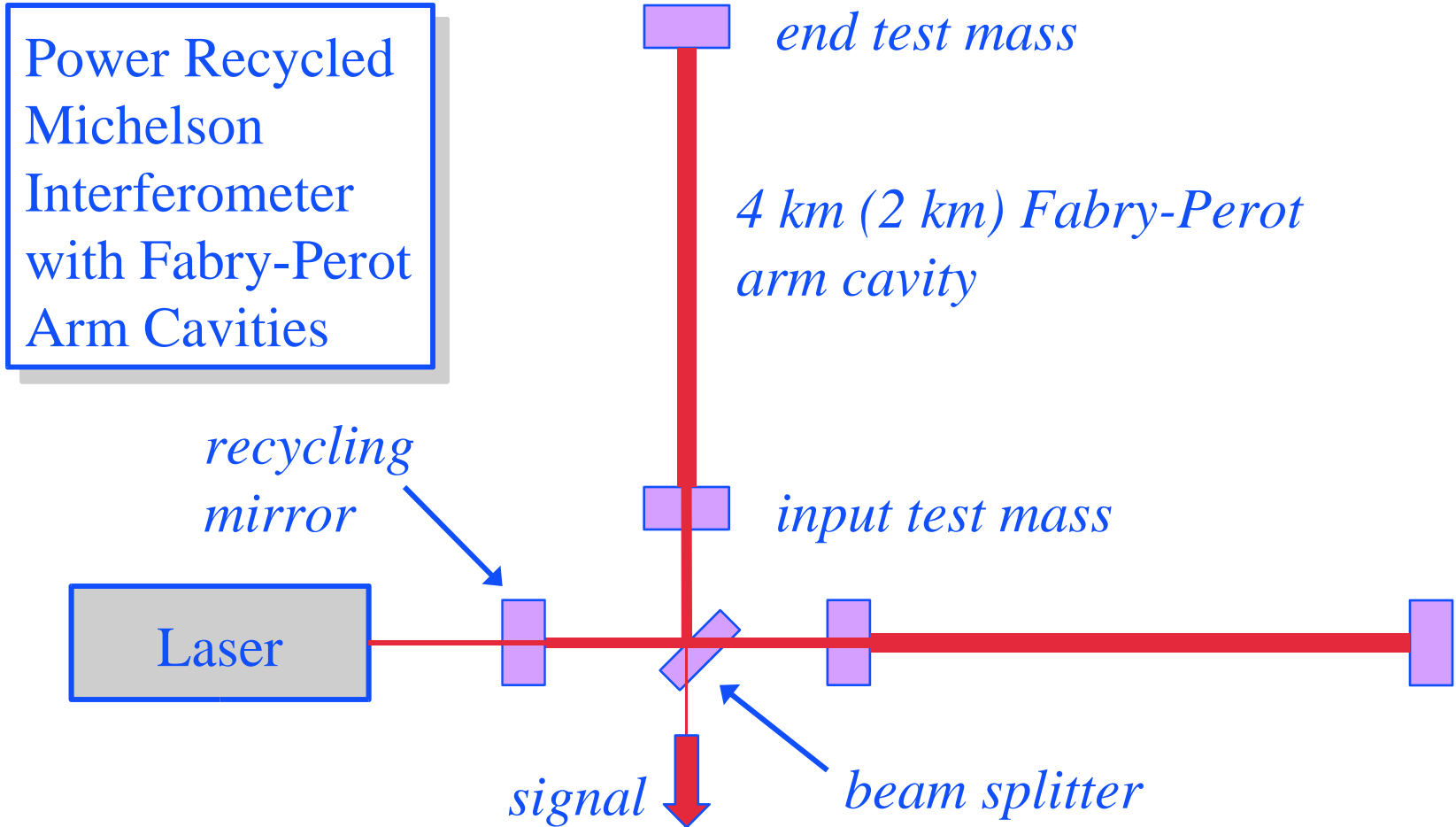

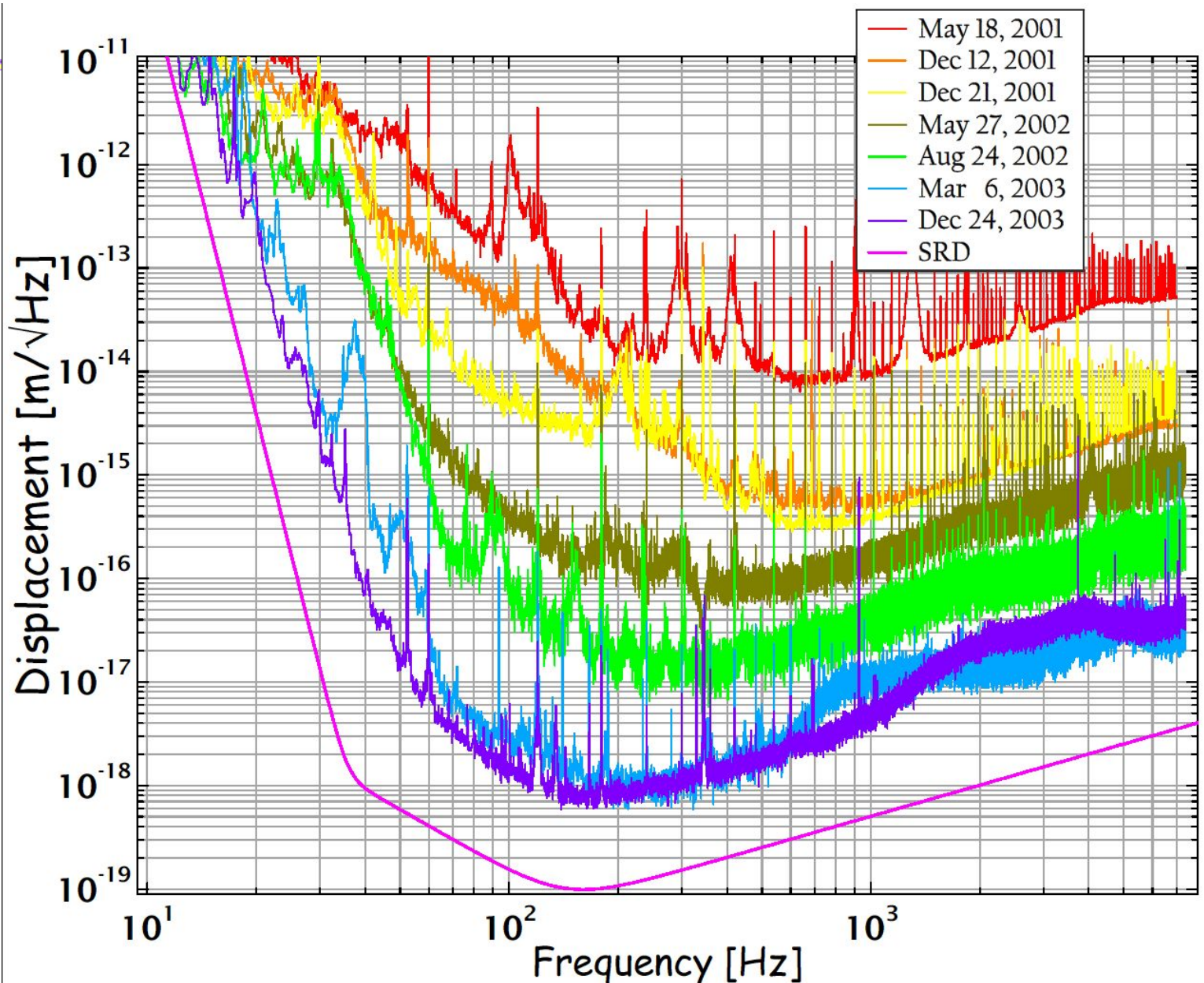

S3: best sensitivities

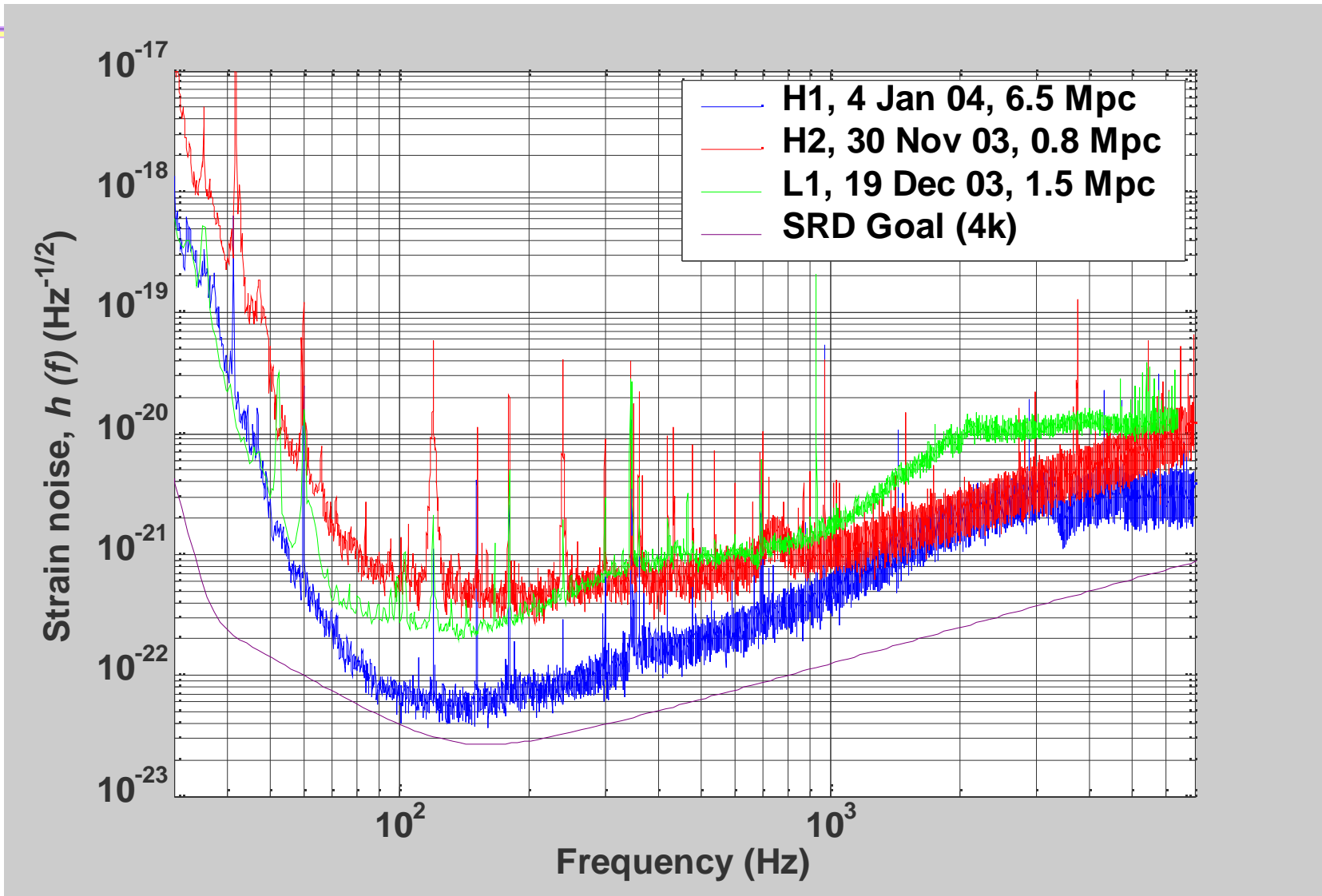

S3: reliability & stability

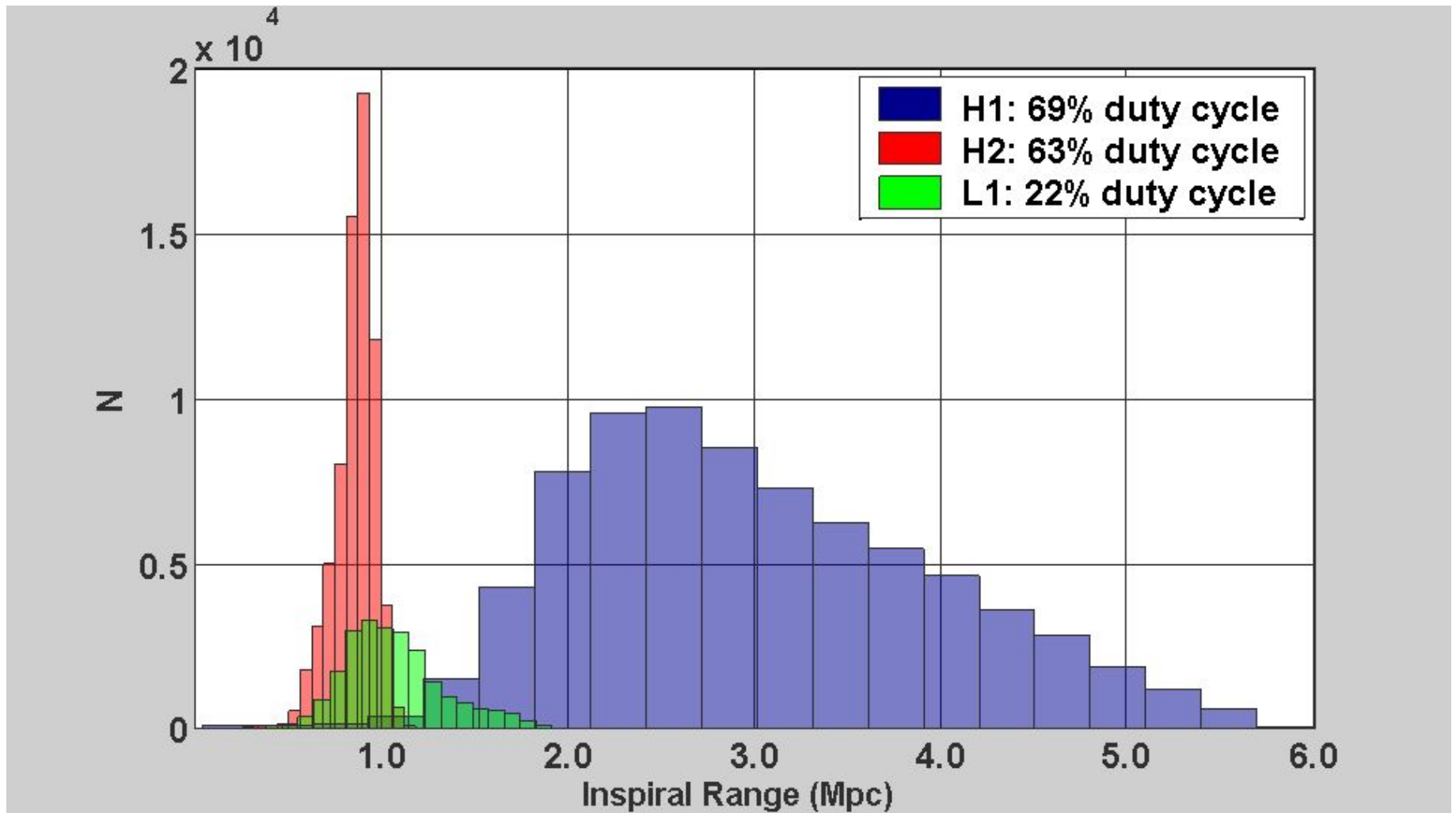

Outline

- Sensitivity & Duty Cycle in the last Science Run
- **Livingston**
 - **Active Seismic Isolation**
 - Angular Control System (wavefront sensing)
- Hanford
 - High Power Operations
 - Active Thermal Compensation
 - **Reduction of several noise sources**
- Near term plans

Seismic Noise

Ocean activity, hurricanes

Caused by human activity:

Cars,
Trains,
Trucks,
Logging,
Drilling

Amplified by
internal isolation
stack resonances

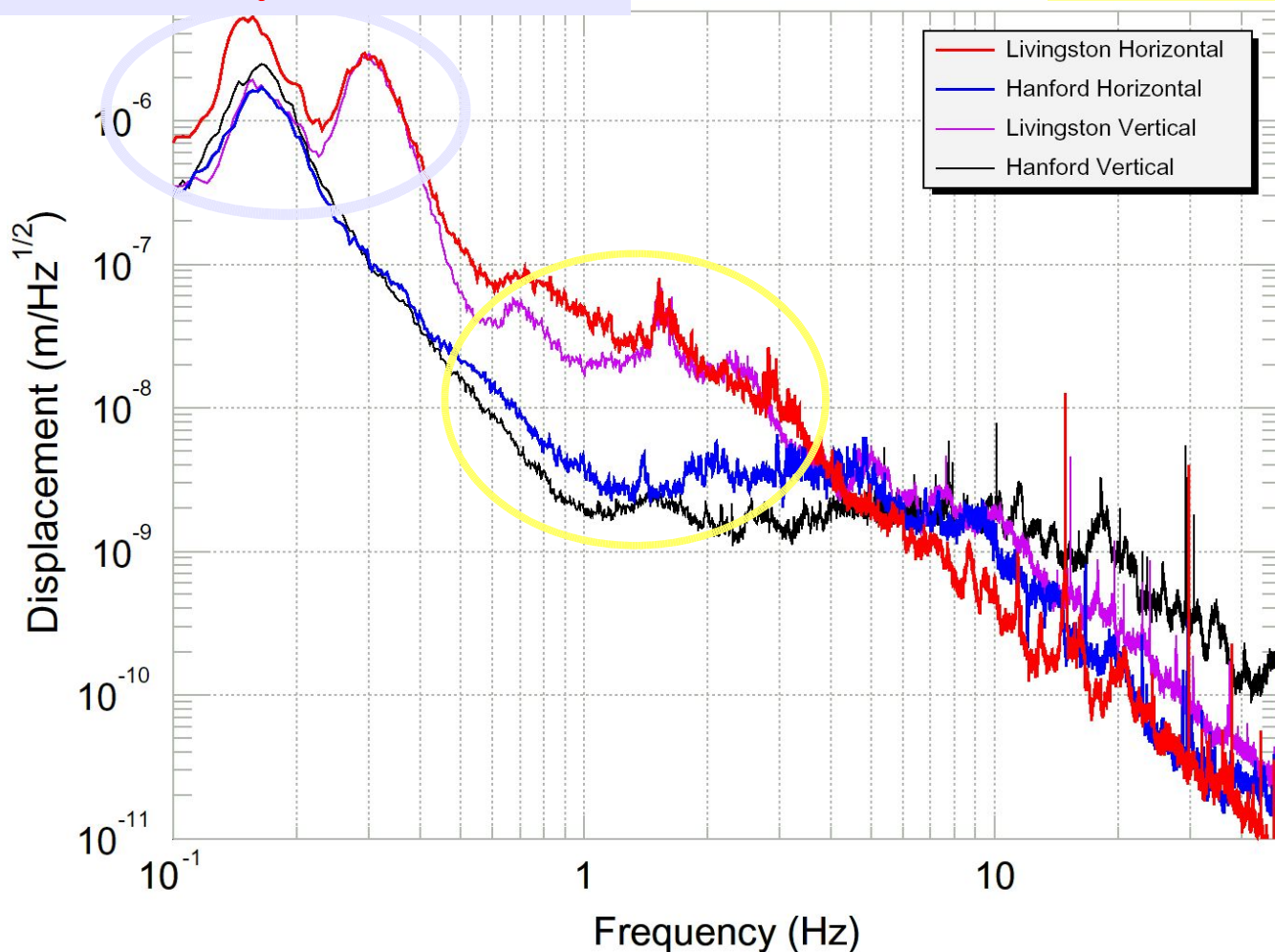

Ground velocity statistics
measured over 600 days

example: 1–3 Hz 90th percentile values

site	chan	90%, $\mu\text{m/s}$	llo/lho
LLO	lvea x	0.31	4.0
	lvea y	0.29	3.6
	ex x	0.34	4.5
	ey y	0.75	7.3
LHO	lvea x	0.078	
	lvea y	0.083	
	mx x	0.077	
	my y	0.10	

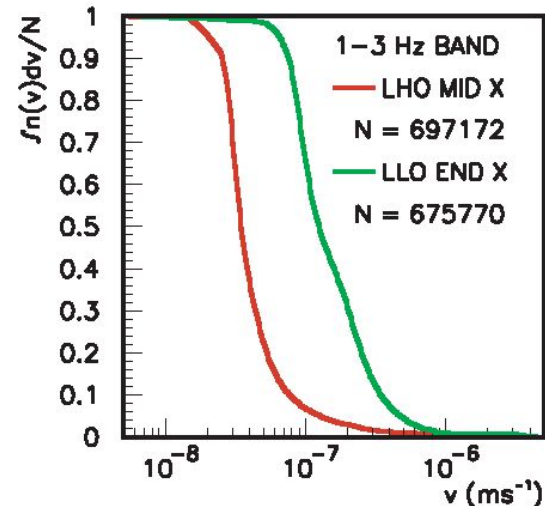
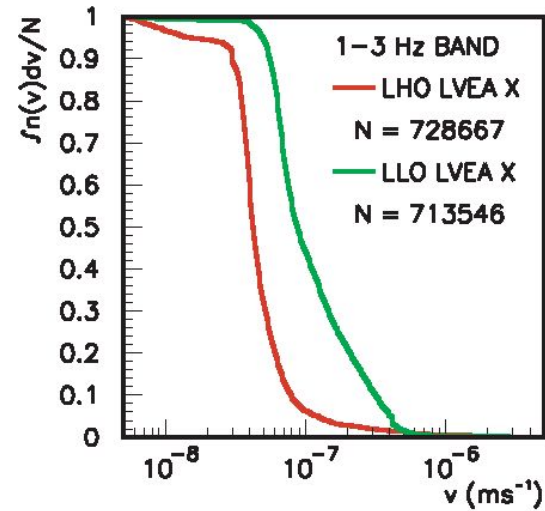

Active Seismic Isolation

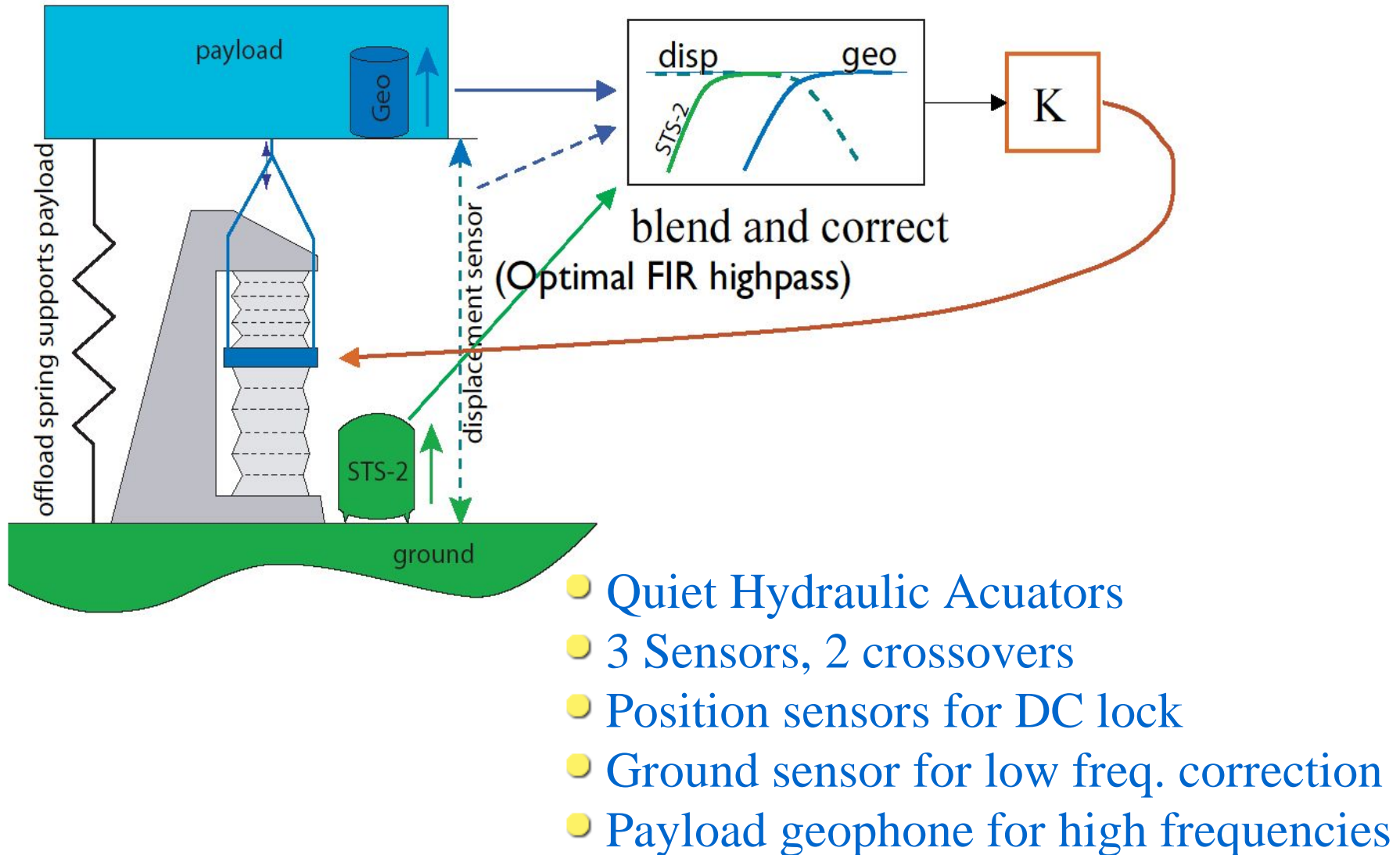

Input Test Mass Chamber

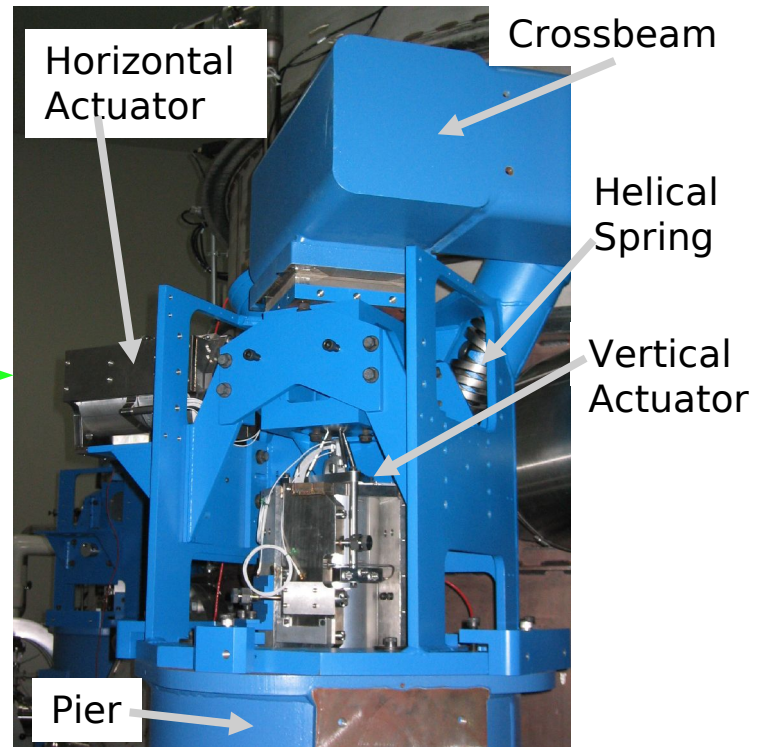
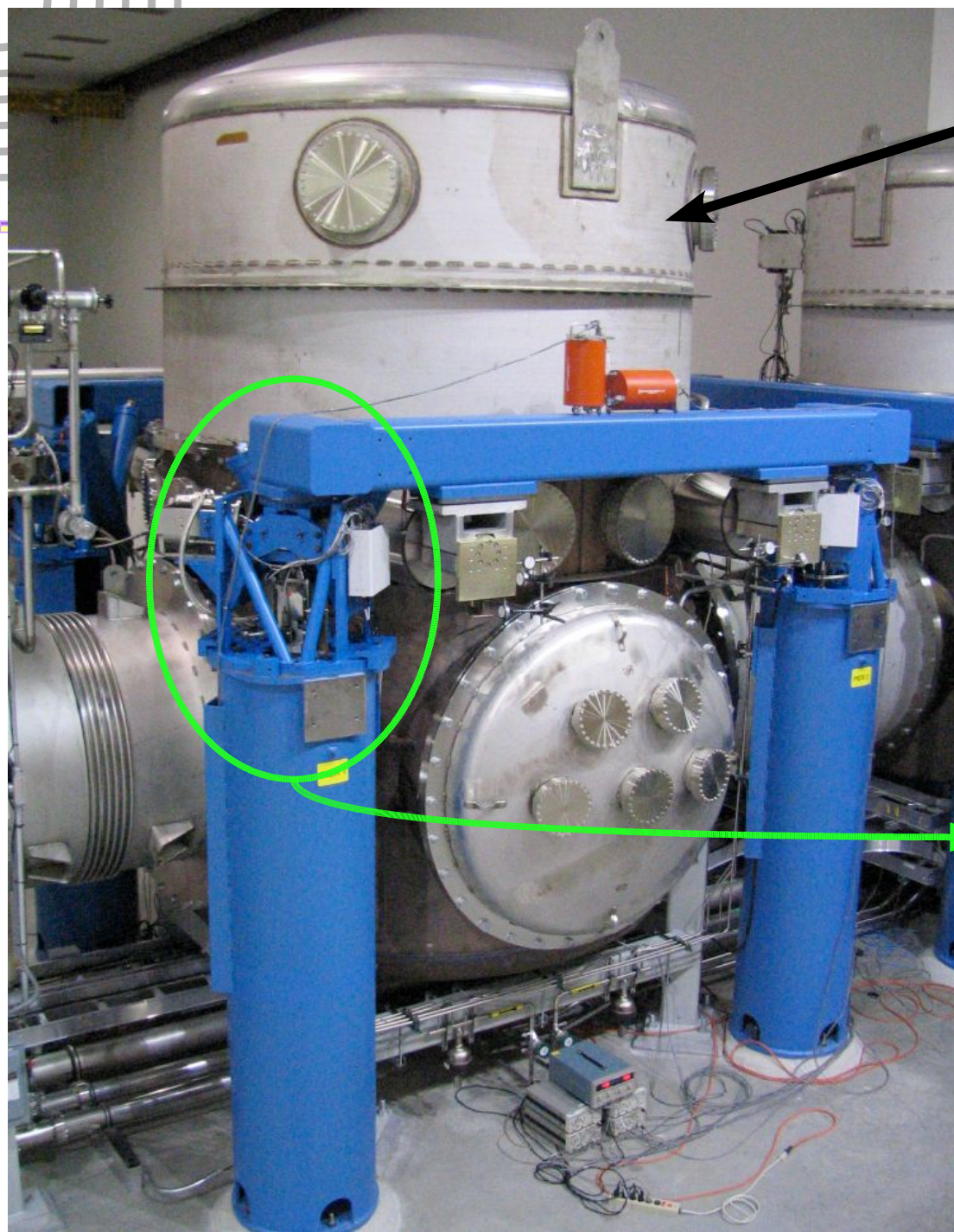

Isolation Performance on a noisy afternoon

Amplification in the earthquake band:
automatic fade-out during earthquakes

10x reduction in the
crucial
frequency
band

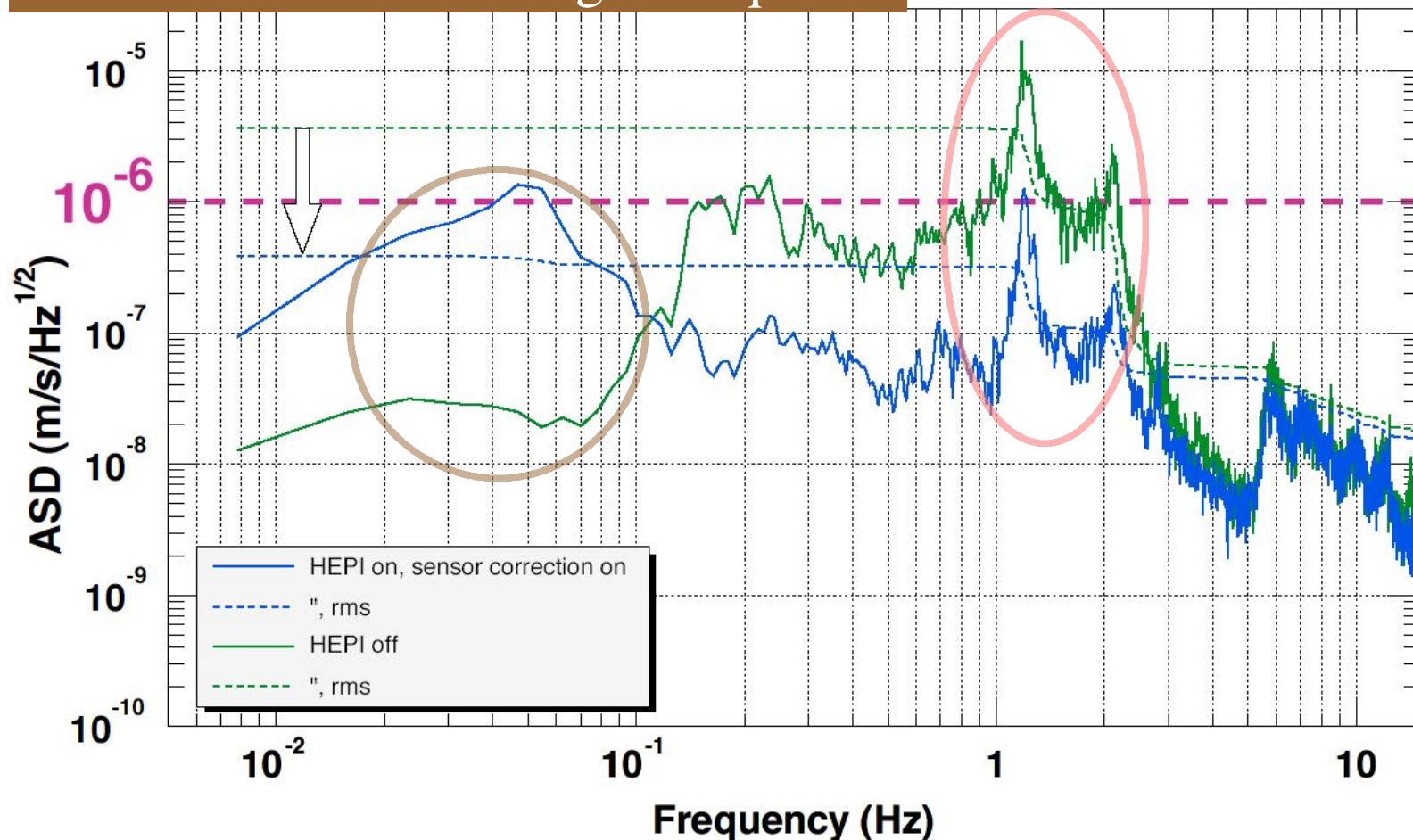



Test of Full Interferometer: First lock through a train

Angular Control Systems engaged

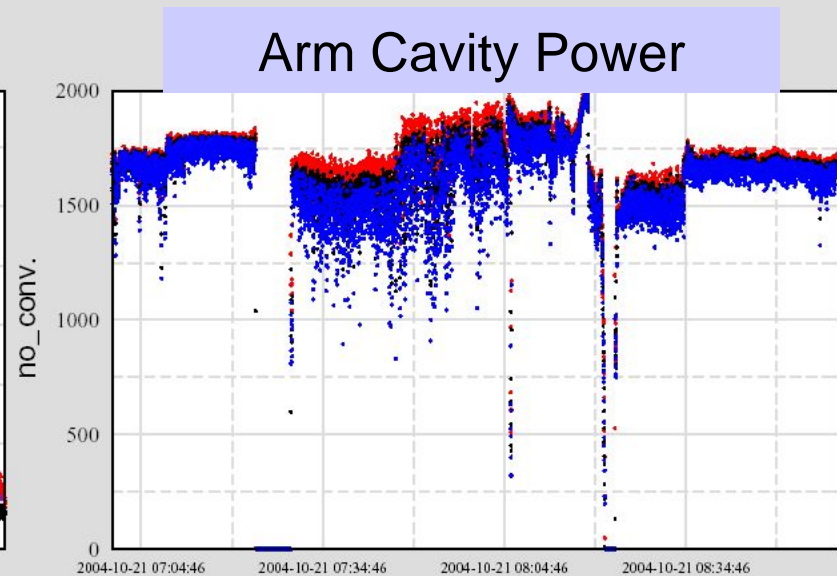
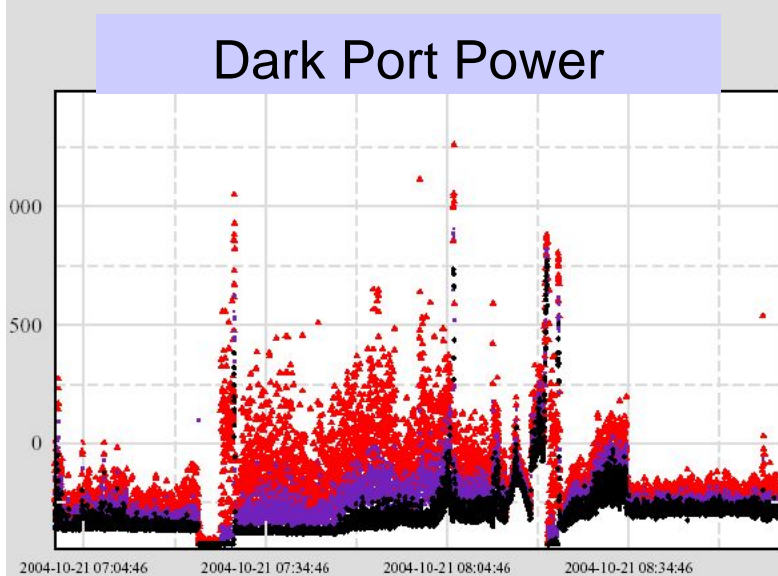
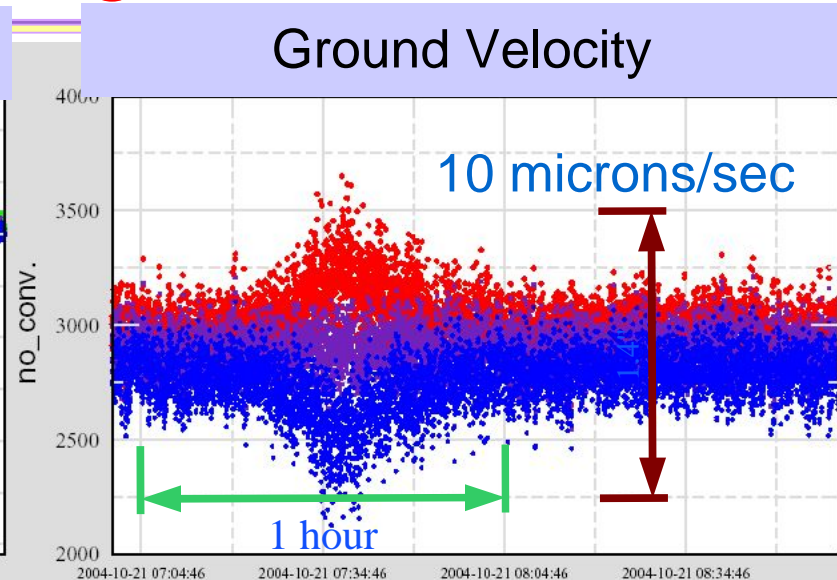
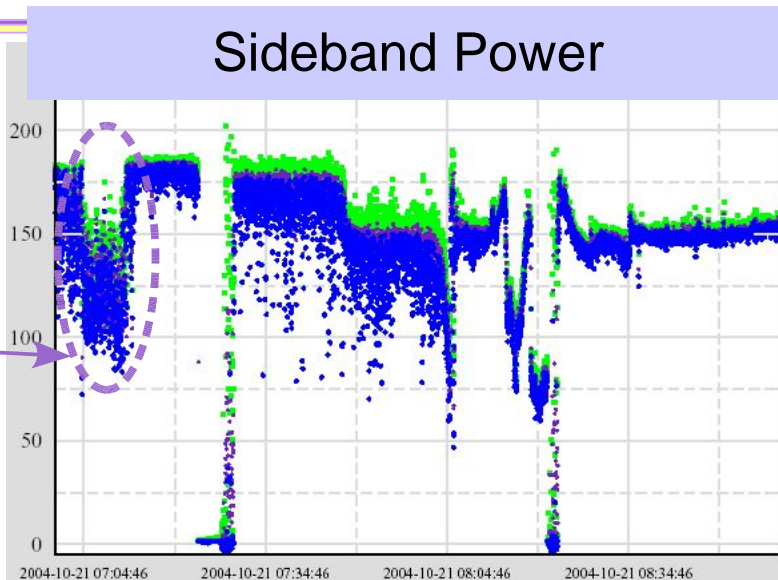

Isolation Status

- All hardware installed
 - 16 sensors + 8 actuators per chamber
 - 9 chambers
 - 3 ground seismometers
- All chambers locked at DC with PS servo loops
 - 3 (test-mass) chambers fully isolated
 - 3 other chambers have limited 1-3 Hz isolation
 - Servo tuning knowledge is being spread
- Some control authority re-allocation done
 - Suspension angle bias relieved (allows lower noise electronics)
 - Earth tide motions (~0.5 mm) (allows uninterrupted locking)

Interferometer can now be worked on in the daytime !!

Outline

- Sensitivity & Duty Cycle in the last Science Run
- Livingston
 - Active Seismic Isolation
 - Angular Control System (wavefront sensing)
- **Hanford**
 - High Power Operations
 - Active Thermal Compensation
 - Reduction of several noise sources
- Near term plans

Optical Schematic

Input field is phase modulated:

$$E_{in} = E_0 \times \exp(i \cdot 2\pi \cdot f_{mod} \cdot t)$$

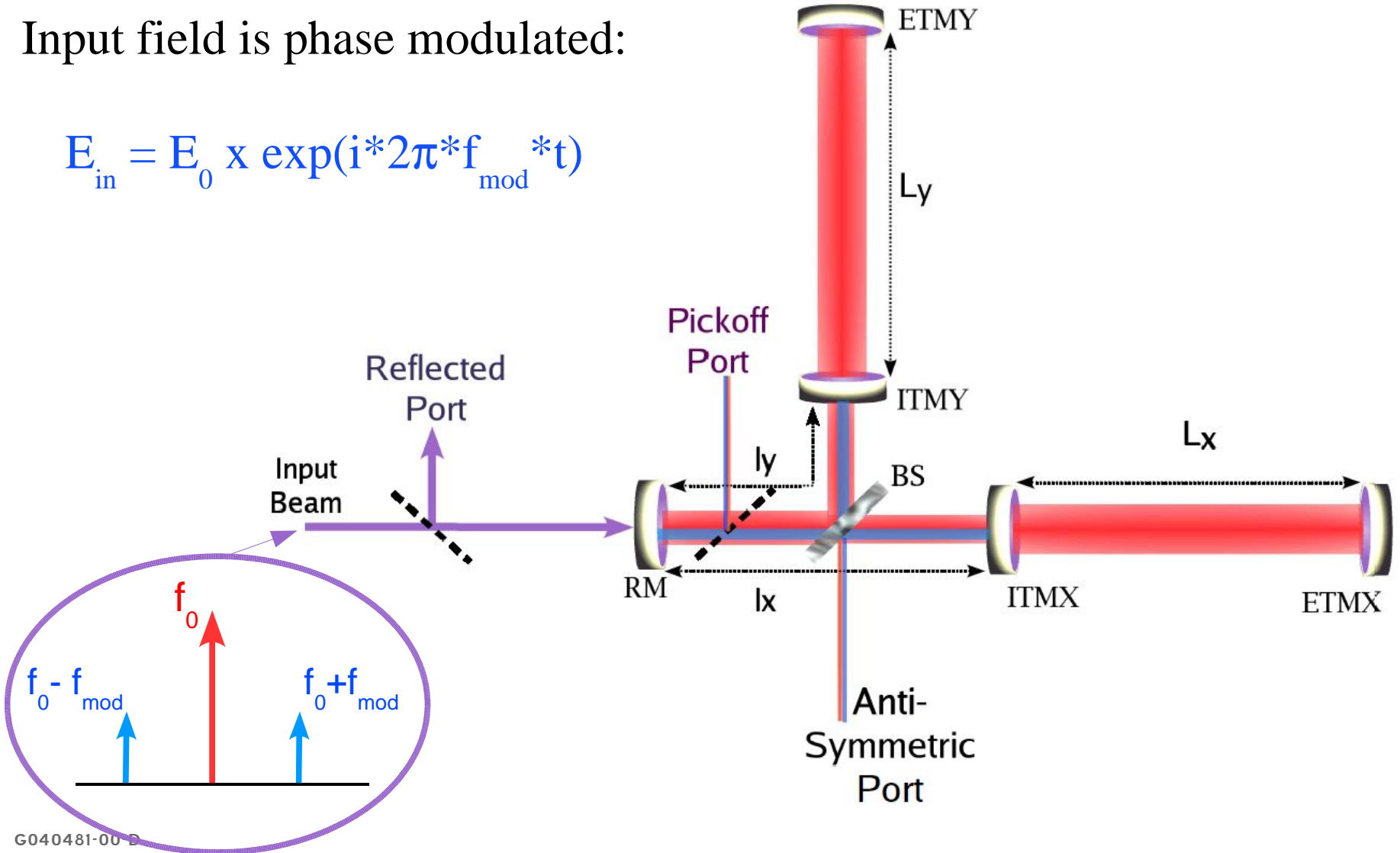

Optical Layout & Control Topology

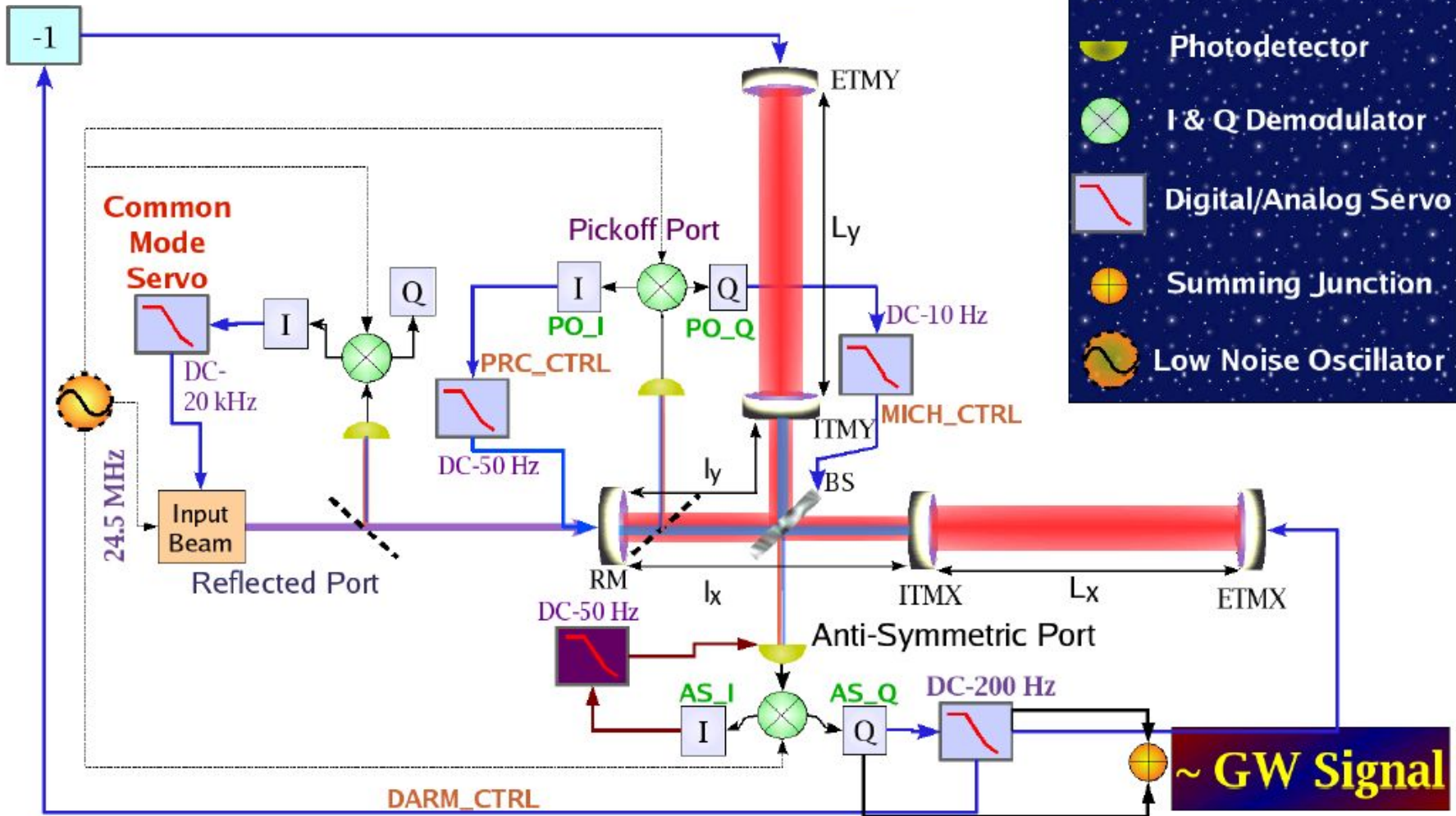

- **Getting High Power**
 - **Laser Power has declined over the 1000's of hrs. of laser life**
 - **Previously could not handle the high power**
 - **Rebuild / Tune up lasers. Diagnose losses in the input optics.**
- **Detecting all the light**
 - **Acquisition/Detection modes: large transients / low noise**
 - **Dark port power split -> 4+1 photodetectors**
 - **Fast Mechanical Shutter to protect diodes from lock loss 'burp'**
 - **New gain ramping software allows smooth PD handoff**
- **Radiation Pressure**
 - **Significant torque from off center beams**
 - **Stage power up: Lock at low power, engage alignment controls, crank up the power**
 - **Software installed to compensate 'optical spring'**
- **Thermal Lensing**
 - **Deposited heat in optics forms a thermal lens ($dn/dT = 10^{-5}$)**
 - **Active curvature correction using an external heating laser**

Laser Power Levels

- Hanford 4km power levels

	S3	Now	<i>Design</i>
Laser output	5 W	11 W	<i>10 W</i>
Mode cleaner input	3.1 (2.2) W	7.5 W	<i>8 W</i>
Recycling mirror input	2.0 (1.4) W	4.8 W	<i>6 W</i>

- Plan

- Tune up other lasers or send back for rebuild
- Diagnose pre-mode cleaner loss (typically 10-15% lost)
- Loss in input electro-optic modulators: reduce number from 3 to 1
- Diagnose suspended mode cleaner loss (20-30% lost)

- **Detecting all the light**
 - **Acquisition/Detection modes: large transients / low noise**
 - Dark port power split -> 4+1 photodetectors
 - Fast Mechanical Shutter to protect diodes from lock loss 'burp'
- **Radiation Pressure**
 - **Significant torque from off center beams**
 - Scripted power up
 - Lock at low power, engage alignment controls, crank up the power
 - Software installed to compensate 'optical spring'
- **Thermal Lensing**
 - **Deposited heat in optics forms a thermal lens** ($dn/dT = 10^{-5}$)
 - Active curvature correction using an external heating laser

Recycling Cavity Degeneracy

- 'Frontal modulation' scheme depends on efficient coupling
 - Local oscillator field generated at laser, coupled into recycling cavity (not co-resonant in arm cavities)
 - Recycling cavity is **nearly degenerate** ($ROC_{[cold]} \sim 15$ km, length ~ 9 m)
 - Original "point design" depends on specific, balanced **thermal lensing**
- RF sideband efficiency found to be very low
 - H1 efficiency: $\sim 6\%$ (anti-symmetric port relative to input)
 - incorrect/insufficient ITM thermal lens makes $g_1 \cdot g_2 > 1$ (unstable resonator) \Rightarrow **Bad mode overlap!**

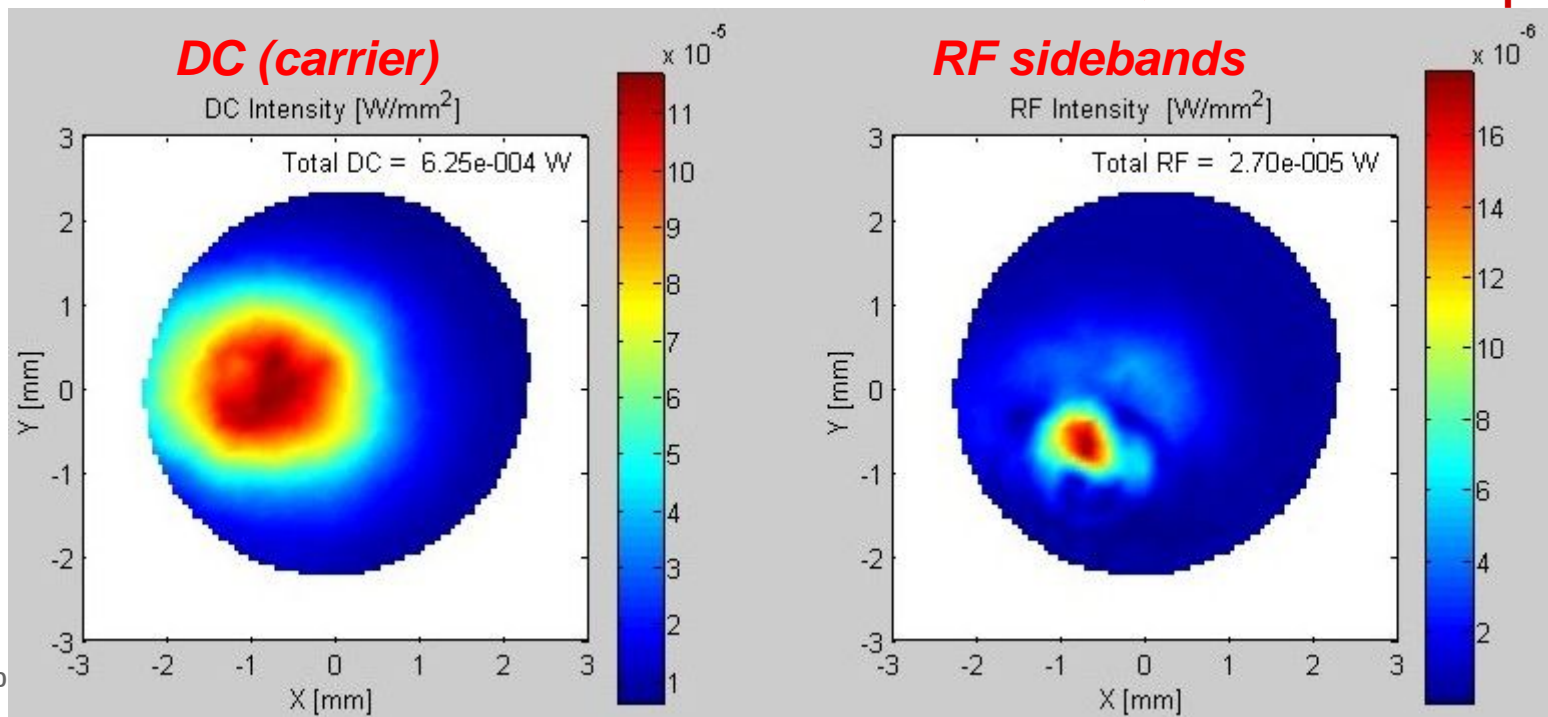

Thermal Compensation

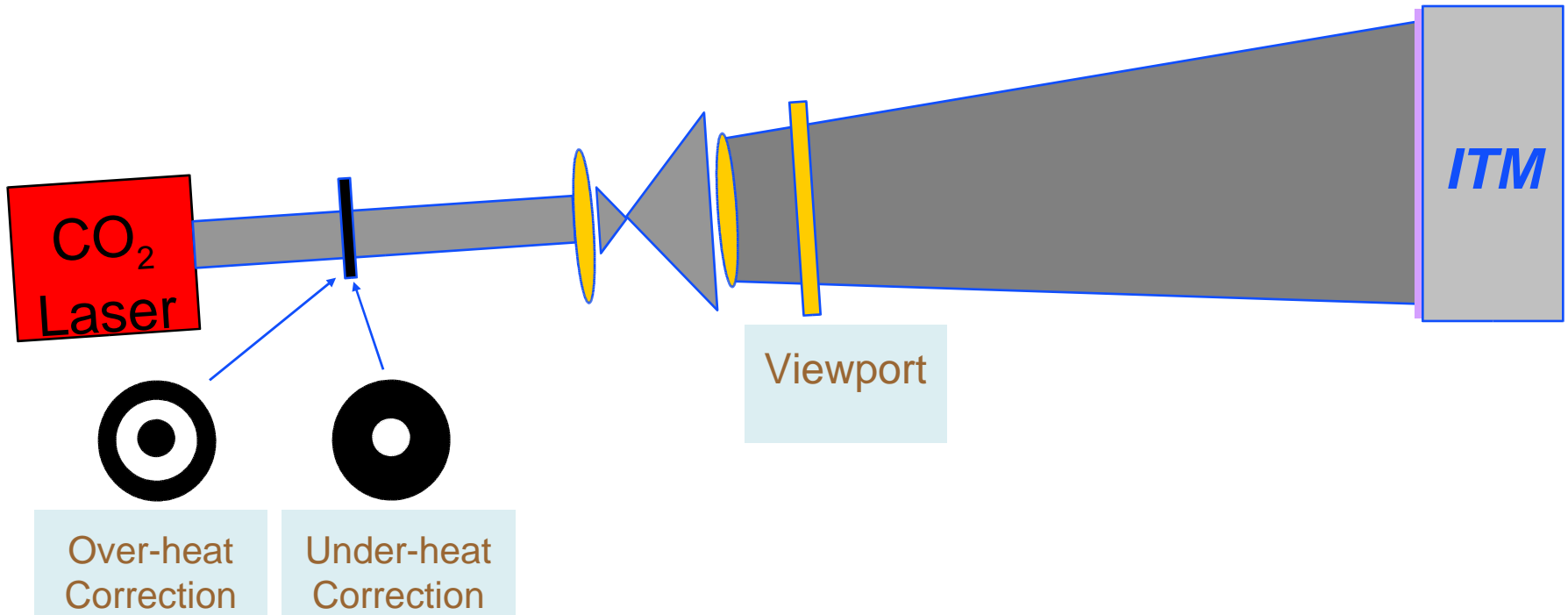

- Heat/'Cool' the Recycling cavity
 - Increase the buildup and correct the mode shape for the RF sidebands
 - Increase the fields' overlap; increase of shot-noise limited sensitivity
- ~100 mW of power required to correct curvature

TCS on the power recycled Michelson: beam images at AS port

No Heating

30 mW

60 mW

90 mW

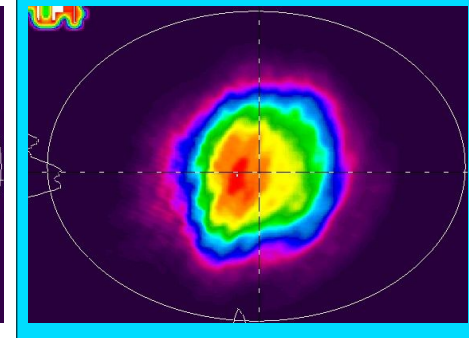
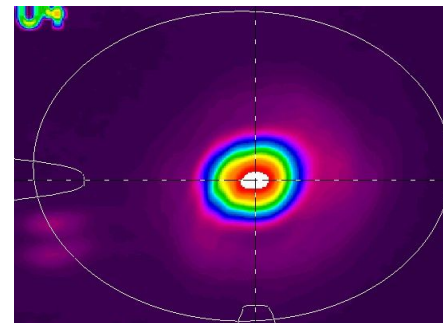
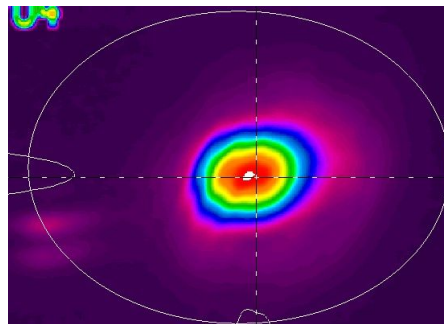
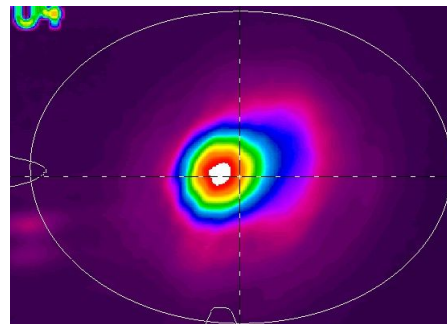
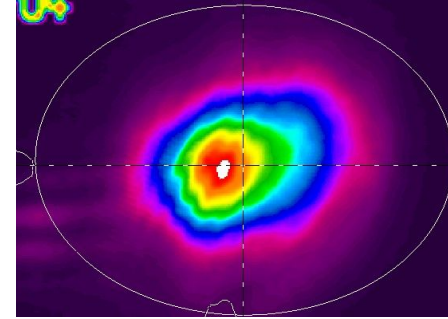
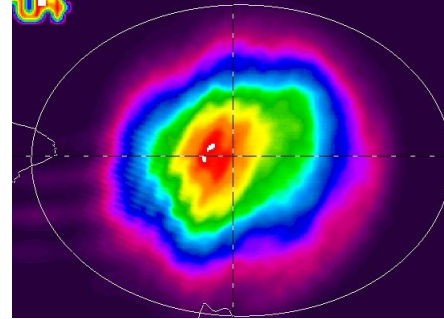
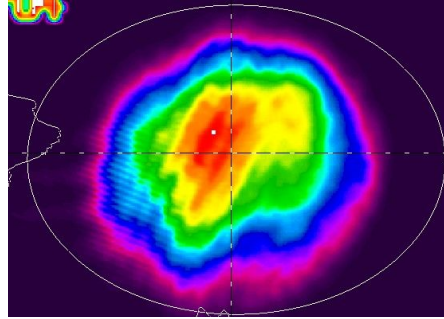
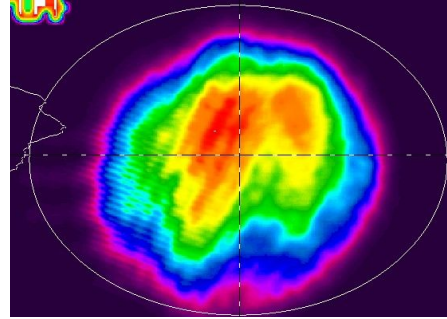

120 mW

150 mW

180 mW

Input beam

Outline

- Sensitivity & Duty Cycle in the last Science Run
- Livingston
 - Active Seismic Isolation
 - Angular Control System (wavefront sensing)
- **Hanford**
 - High Power Operations
 - Active Thermal Compensation
 - Reduction of several noise sources
- Near term plans

Noise Reduction

- **Auxiliary length loops: a change in philosophy**
 - Reduced sensing noise: more power, thermal compensation
 - **High gain -> reduced nonlinear upconversion**
 - **Off-diagonal correction paths (“feed-forward”)**
- **Angular controls noise => apparent cavity length**
 - Coupling: spot mis-centering or coil/magnet gain imbalance
 - Output of software 'lock-in' used to servo coil gains
 - Automated procedure (easy to modify shell scripts)
- **Photodetector saturation at 2 x fmod**
 - Circuit modified with an 'active' notch
- **RF oscillator phase noise**
 - Dedicated crystal oscillator
 - **Coupling reduced through differential thermal lensing**

Auxiliary degrees-of-freedom: small coupling, but very noisy

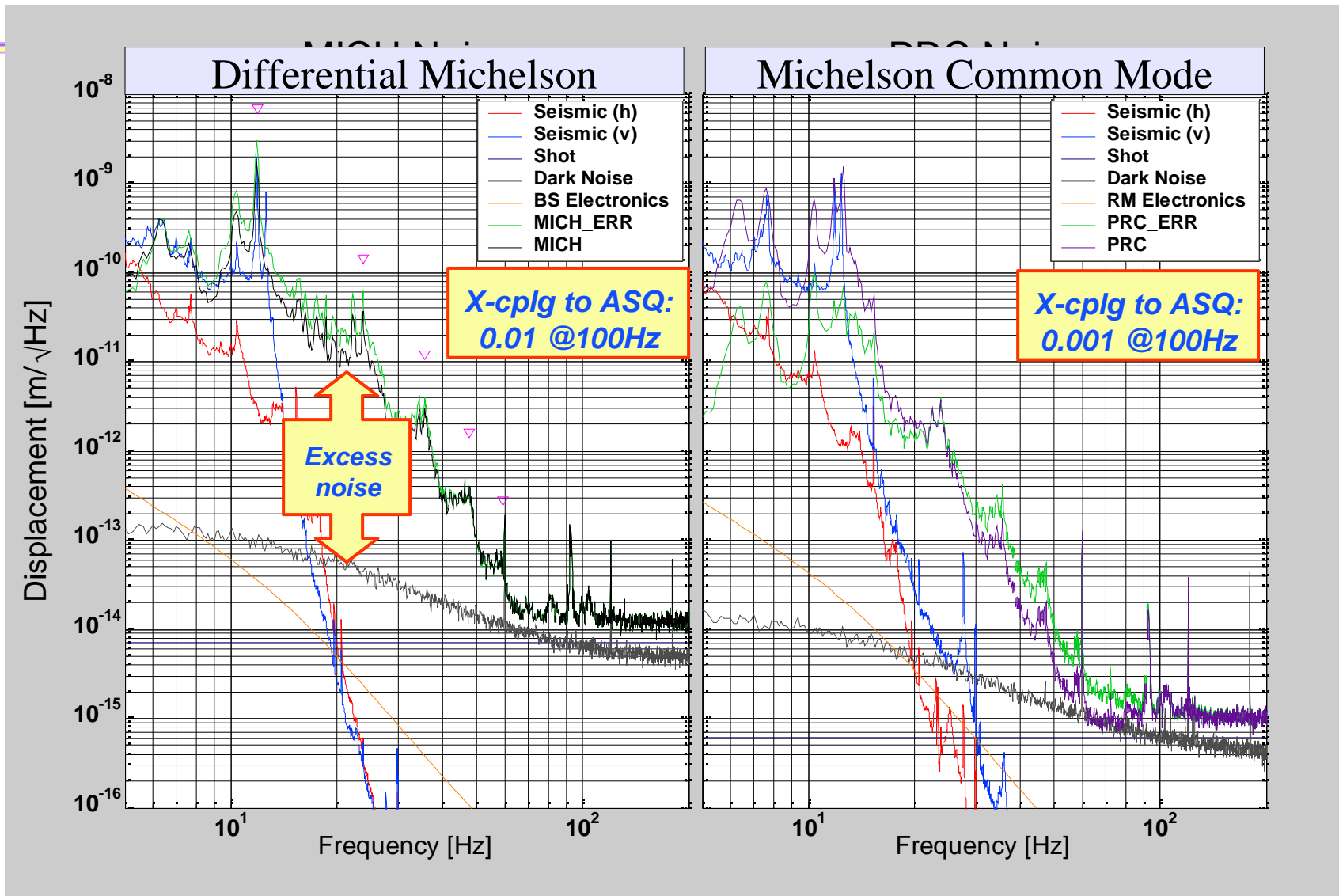

Excess noise: optical gain modulation

→ $Signal \propto (\text{sideband field}) \cdot (\text{length deviation})$

Intermodulation

Reduce these by increasing loop gain

Michelson error signal

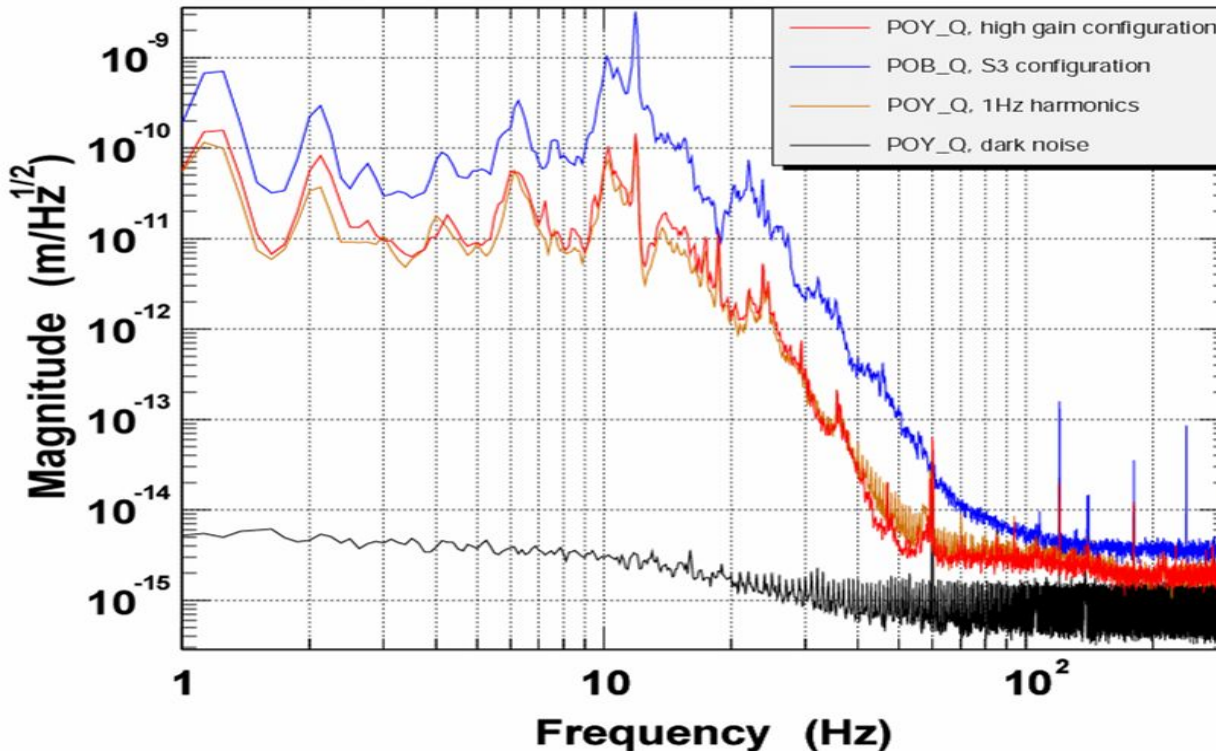

Effects of increased servo gain:

- 10x noise reduction in the recycling cavity loops: MICH, PRC, & WFS
- noise small enough to use the 'high power' PickOff

Noise Reduction

- **Auxillary length loops: a change in philosophy**
 - Reduced sensing noise: more power, thermal compensation
 - **High gain -> reduced nonlinear upconversion**
 - **Off-diagonal correction paths (“feed-forward”)**
- **Angular controls noise => apparent cavity length**
 - Coupling: spot mis-centering or coil/magnet gain imbalance
 - Output of software 'lock-in' used to servo coil gains
 - Automated procedure (easy to modify shell scripts)
- **RF Photodetector saturation at $2 \times f_{\text{mod}}$**
 - Circuit modified with an 'active' notch
- **RF oscillator phase noise**
 - Dedicated crystal oscillator
 - **Coupling reduced through differential thermal lensing**

Mysterious ~kHz noise bumps

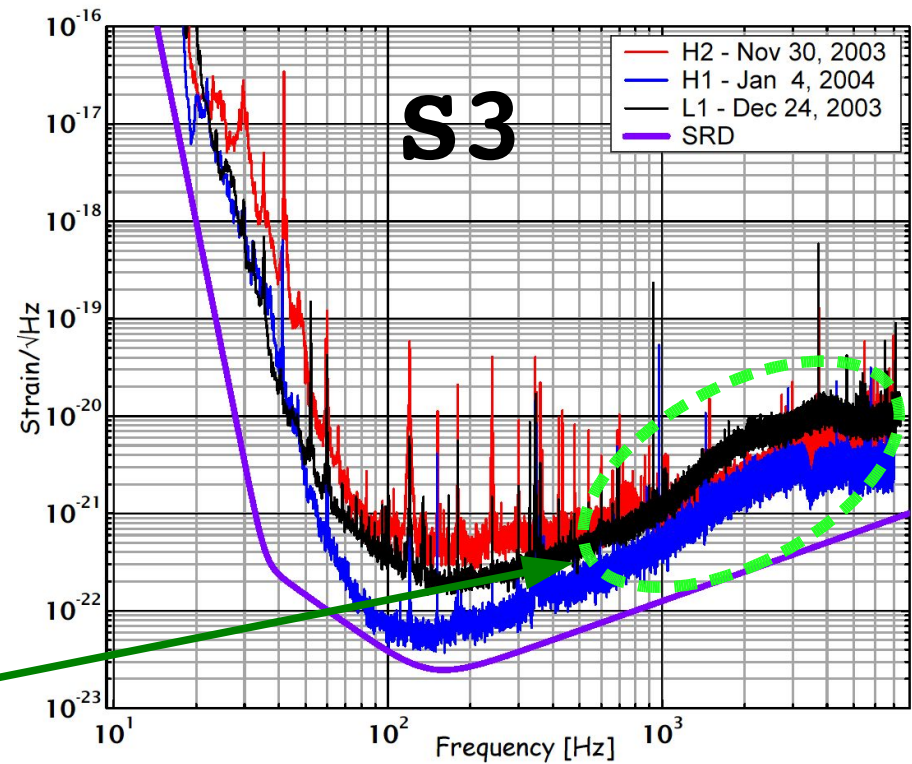
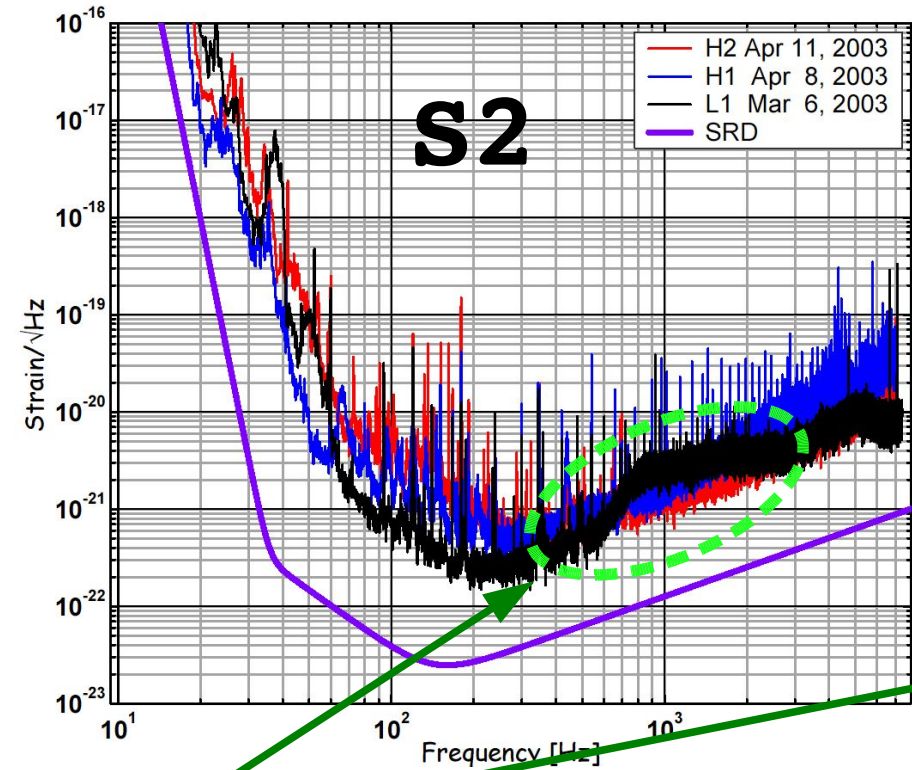

★ Present in noise curves since early '03

★ Does not scale with laser power

RF Oscillator Phase Noise

- Modulation phase noise appears on demodulation signal (LO) too – no big deal

- True at low frequencies, but...
 - mode cleaner shifts phase of modulation fields
 - doesn't cancel out at higher frequencies

Solutions:

- Ultra-low phase noise crystal oscillator (-160 dBc/rHz)
- Differential thermal lensing in the recycling cavity balances the RF sidebands and reduces the coupling

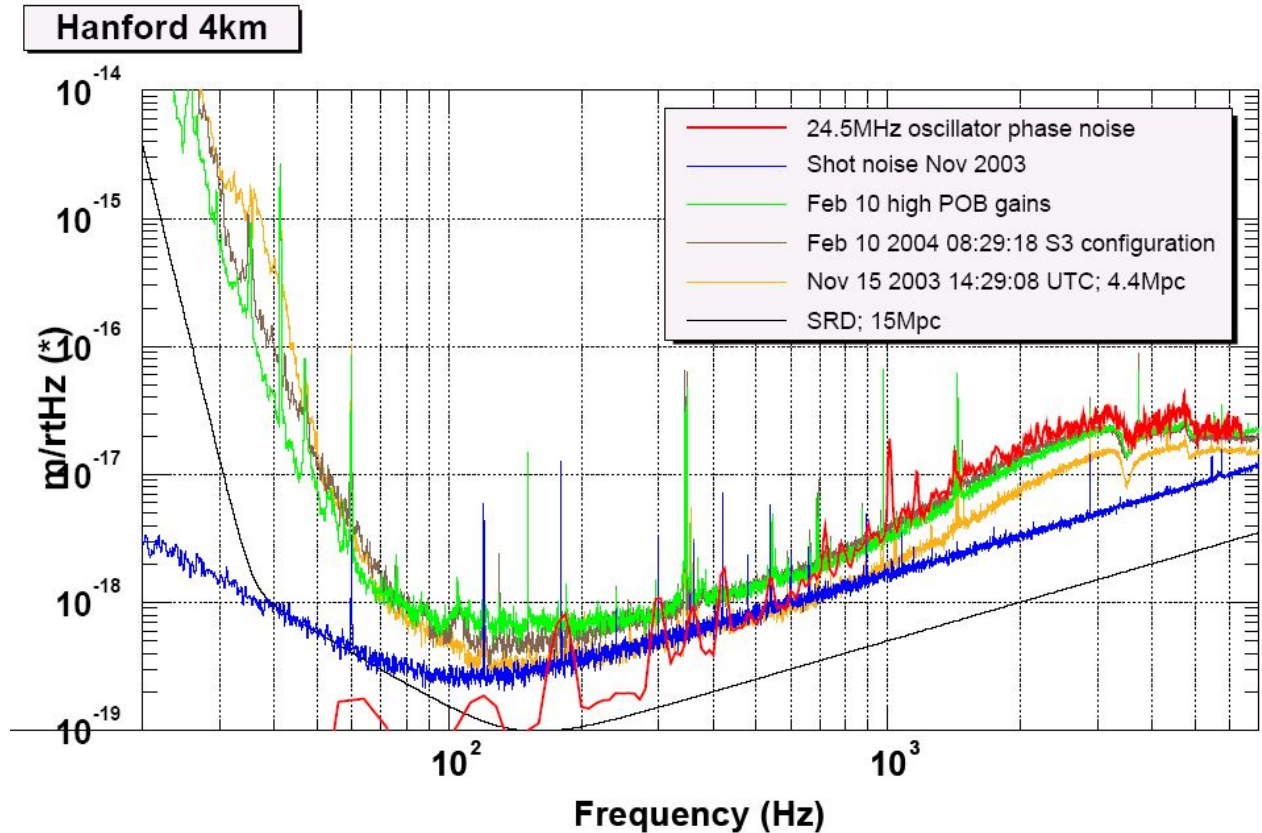

Noise Reduction

- Auxillary length loop noise
- Angular controls noise => apparent cavity length
- RF Photodetector saturation at $2 \times f_{\text{mod}}$
- RF Oscillator Phase Noise

- Many noise sources of comparable level
- Noise reduction only obvious when all of the fixes are in...

Very Good Sensitivity

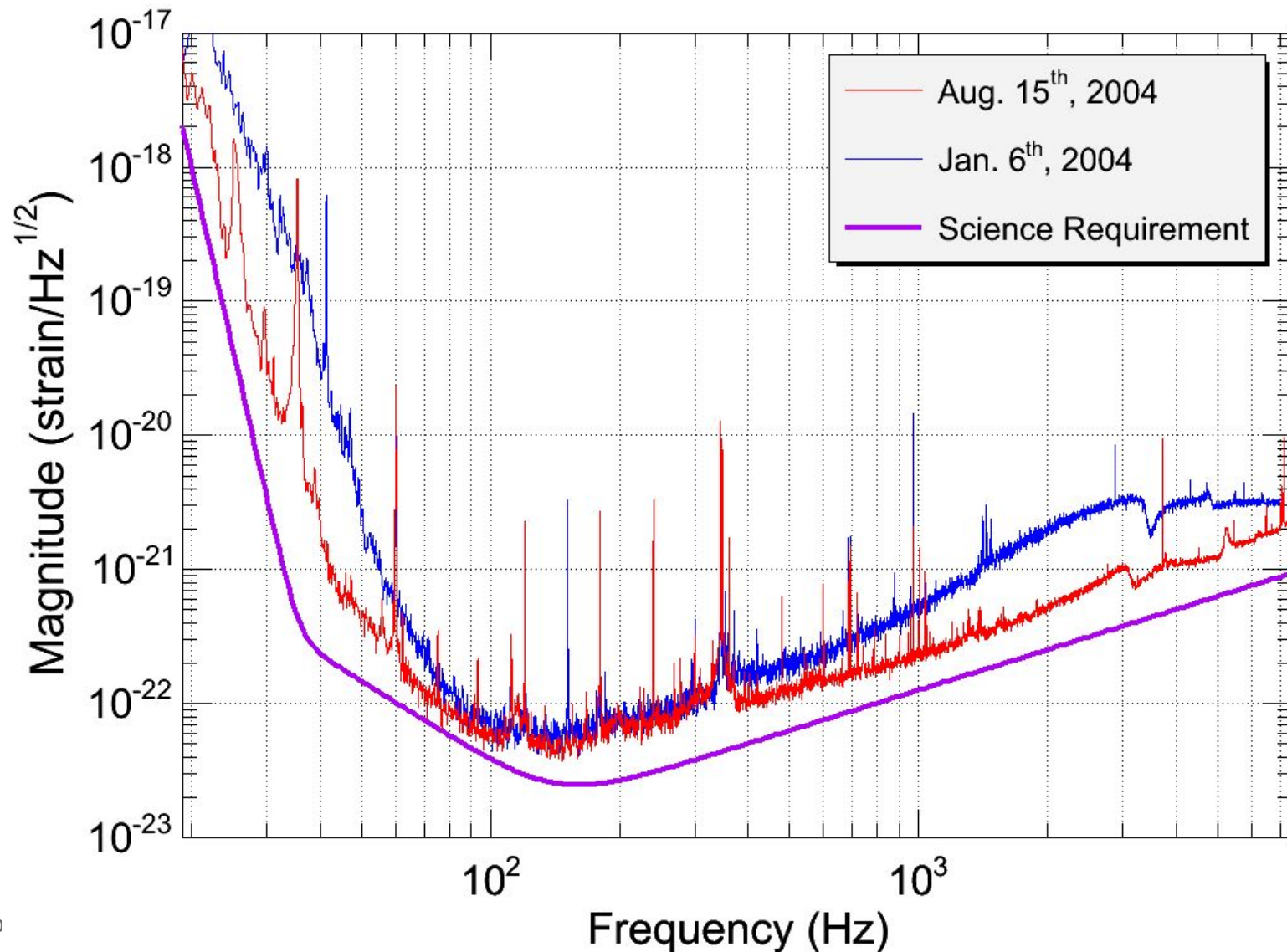

Noise Budget

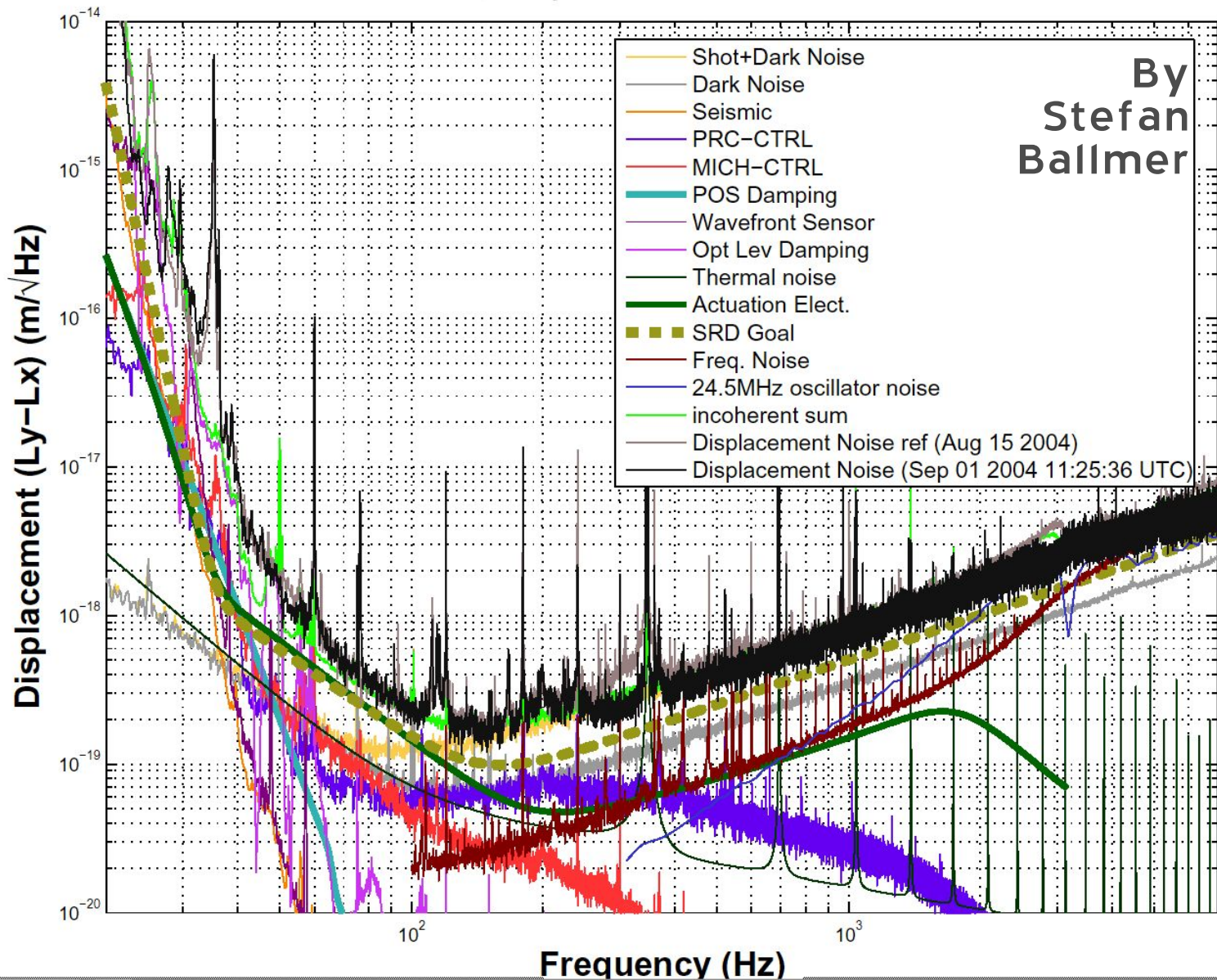

Angular Sensing & Controls

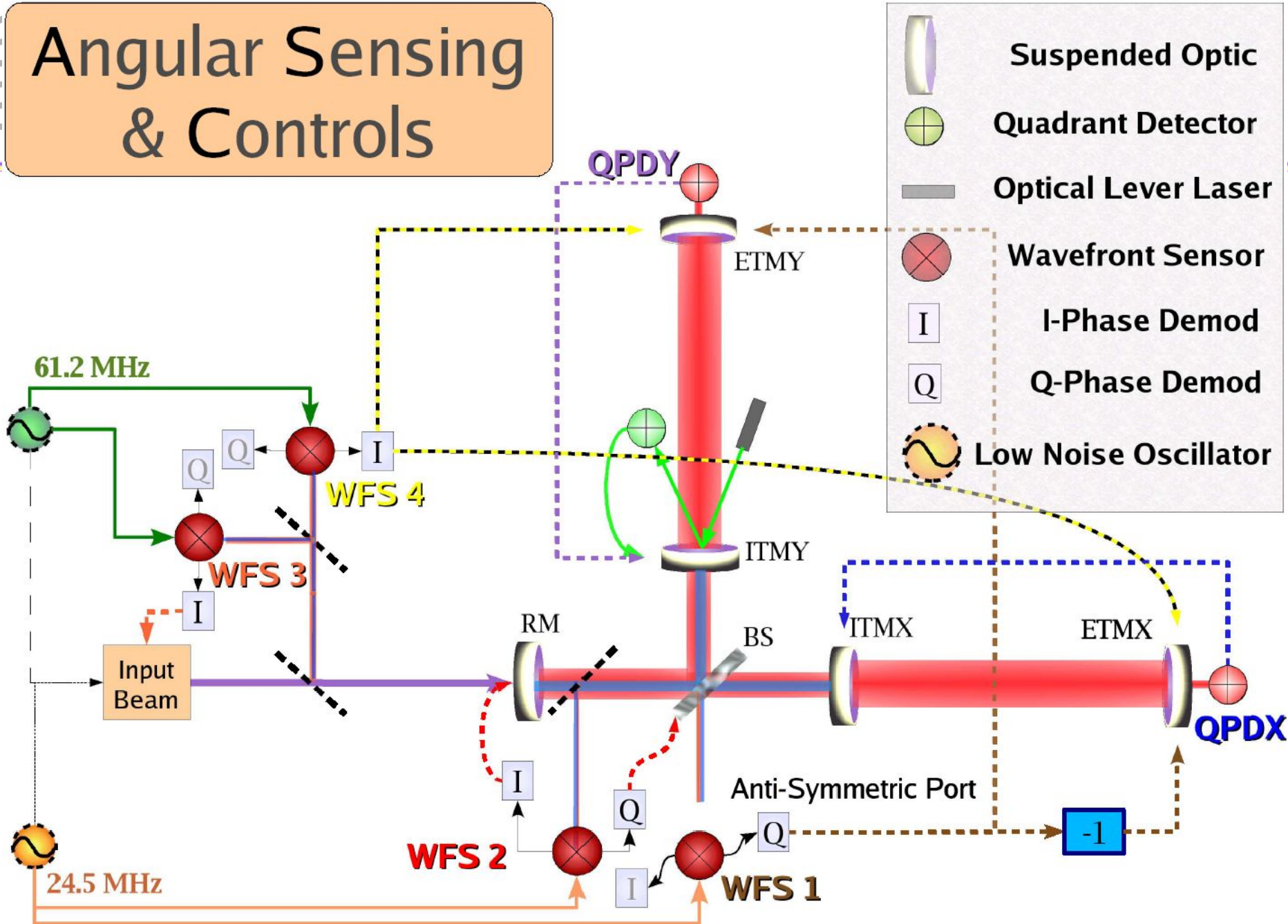

Alignment Control

- Continued incremental progress...
 - **Goals:**
 - Increase gain to reduce power fluctuations to ~1%
 - Manage angular noise & coupling to strain readout
 - **Status:**
 - **H1:** ~few Hz BW for all loops, high power characterization ongoing
 - **H2:** All loops closed, high power characterization ongoing
 - **L1:** Recently closed all angular control loops.
 - **Recent work:**
 - Dynamic input matrix (compensates optical gain fluctuations)
 - Electronics noise reductions
 - More MIMO system => higher bandwidth servos
 - Beam centering ...

Beam Centering

- Transmission QPDs hold the beam position fixed at the ETMs
 - Need to independently find the right spot (w/in 1mm of center)
- WFS control all mirror angles: only DOF left is the beam position in the corner
- New servo:
 - Capture image of beam scatter from BS face
 - Image processing to determine position of beam center
 - Slow feedback to input telescope to fix BS beam position

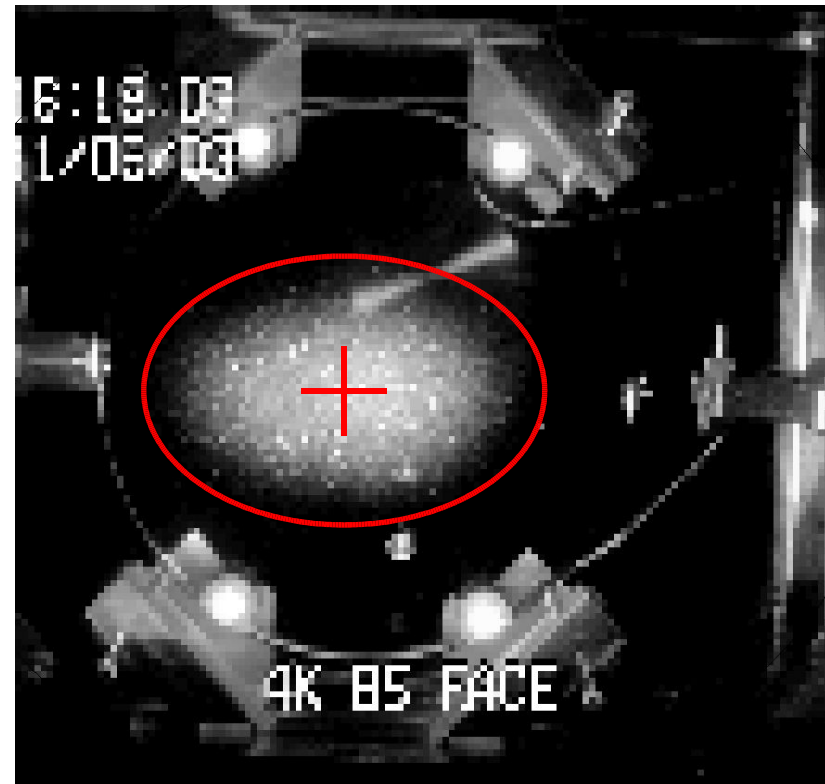
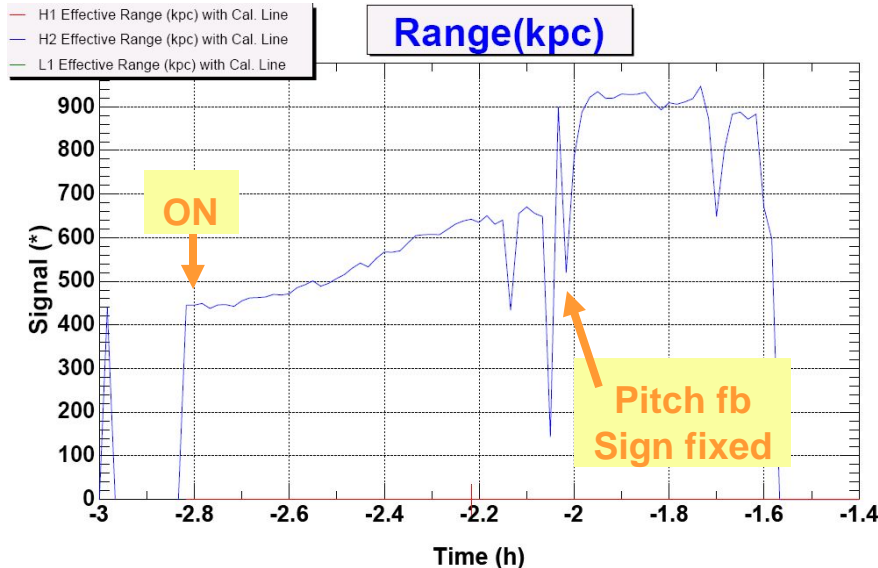

Next *~3 months*

L 4k

- Thermal Lensing compensation
- Seismic isolation commissioning
- Copy noise improvements from Hanford

H 4k

- ▶ Stability and duty cycle studies
 - ▶ Wideband angular control at high power
- ▶ Microseismic feedback and FF

H 2k

- ▶ Wideband angular control
- ▶ Copy sensitivity improvements from H 4K

Conclusions

- All interferometers can now run **all day and night**
- All interferometers have all lengths and angles under control
=> **repeatable, stable operation**
- Sensitivity is very close to the design goal on one interferometer
 - **No show stoppers**
- ''