

Interferometric Detectors on the Earth

5th Amaldi Conference

Rainer Weiss

LIGO MIT

July 7, 2003

Pisa, Italy

LIGO-G030369-00-D



Interferometers

international network

Simultaneously detect signal (within msec)

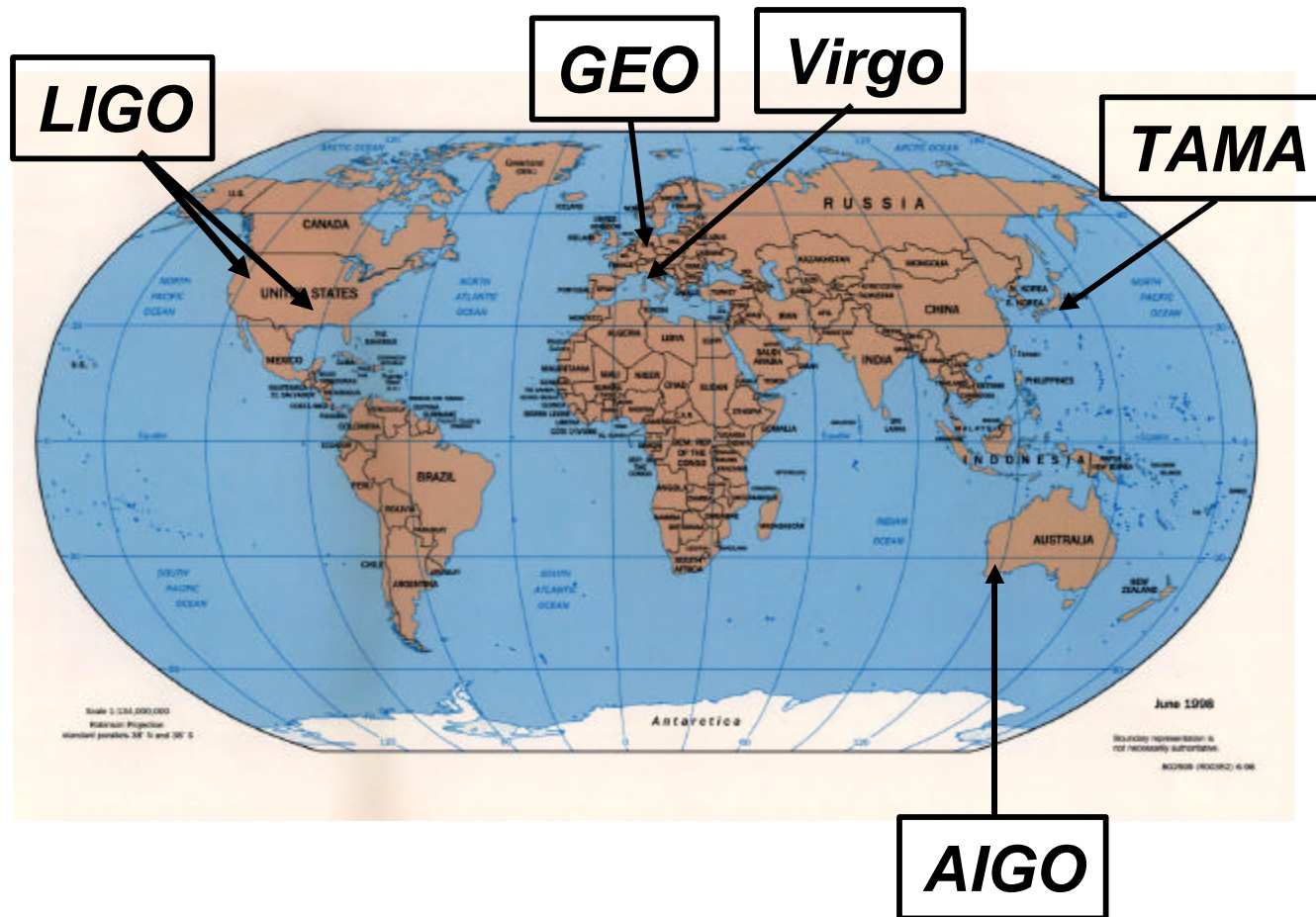

detection
confidence

locate the
sources

decompose the
polarization of
gravitational
waves

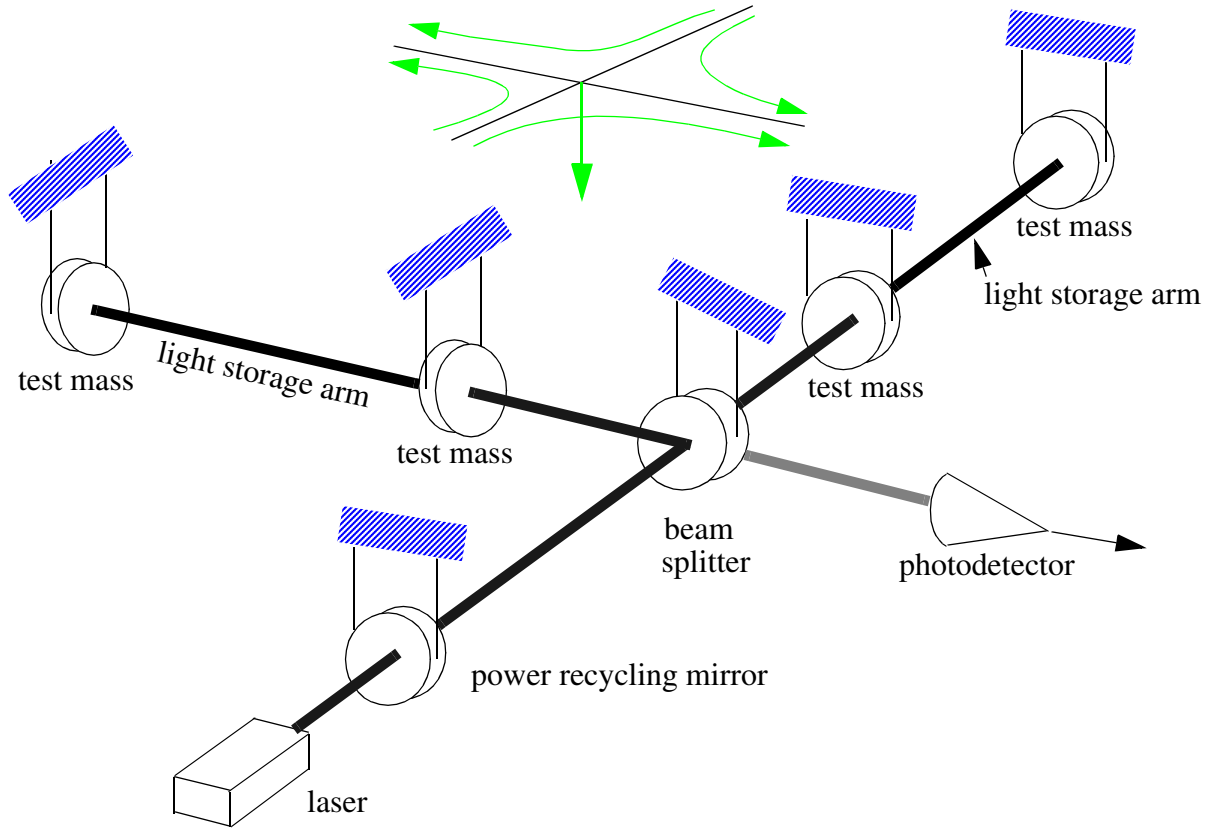

FRINGE SENSING

wavelength $1 \times 10^{-6} \text{ m}$

$$h = \frac{x}{L} \sim \frac{\lambda}{Lb \sqrt{N\tau}}$$

arm length = 4000 m

equivalent # of passes = 100

integration time

number of quanta/second at the beam splitter

300 watts at beam splitter = 10^{21} identical photons/sec

$$h = 6 \times 10^{-22} \quad \text{integration time } 10^{-2} \text{ sec}$$

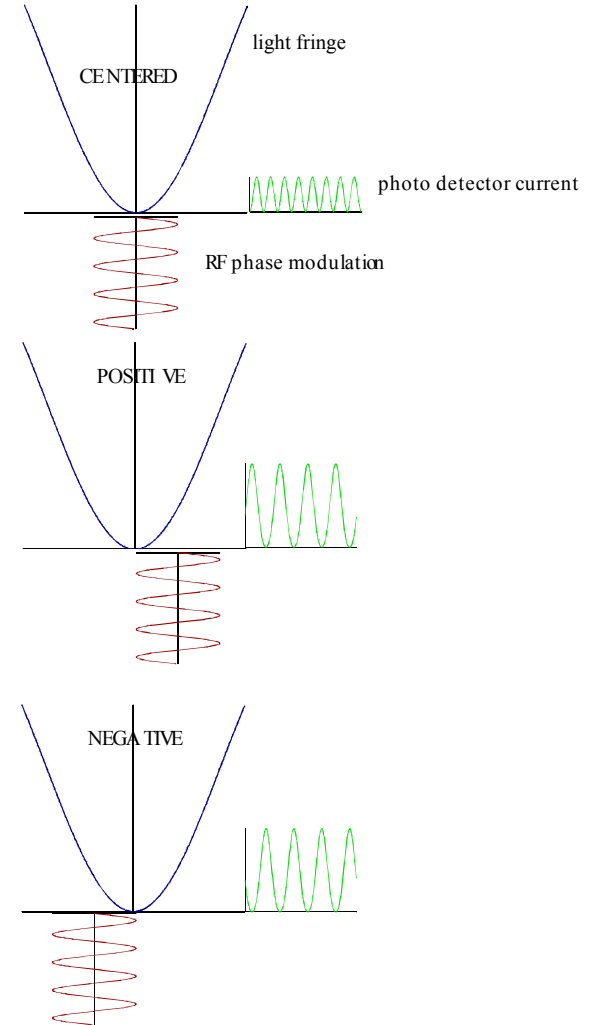

PENDULUM THERMAL NOISE

Pendulum Brownian motion

Dissipation leads to fluctuations

T_c = coherence or damping time
 = $Q \times$ period of oscillator

Exchange with surroundings:

$$E(\text{thermal}) = \frac{kT t}{T_c}$$

Large $T_c \Rightarrow$ smaller fluctuations

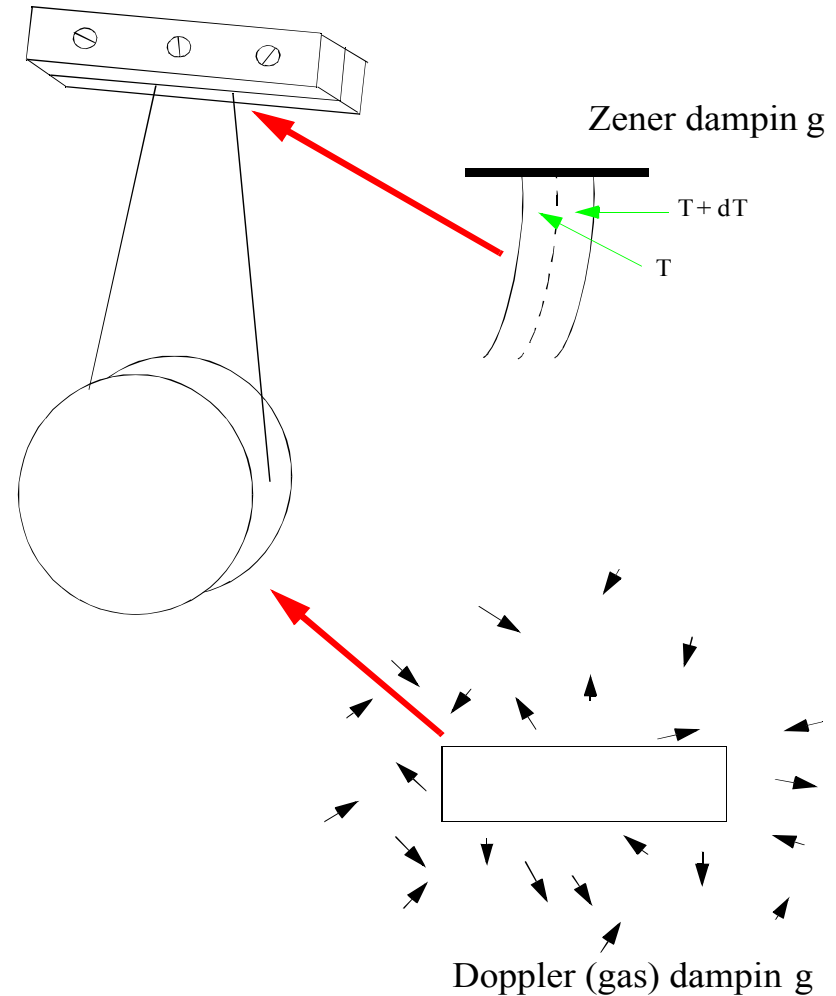

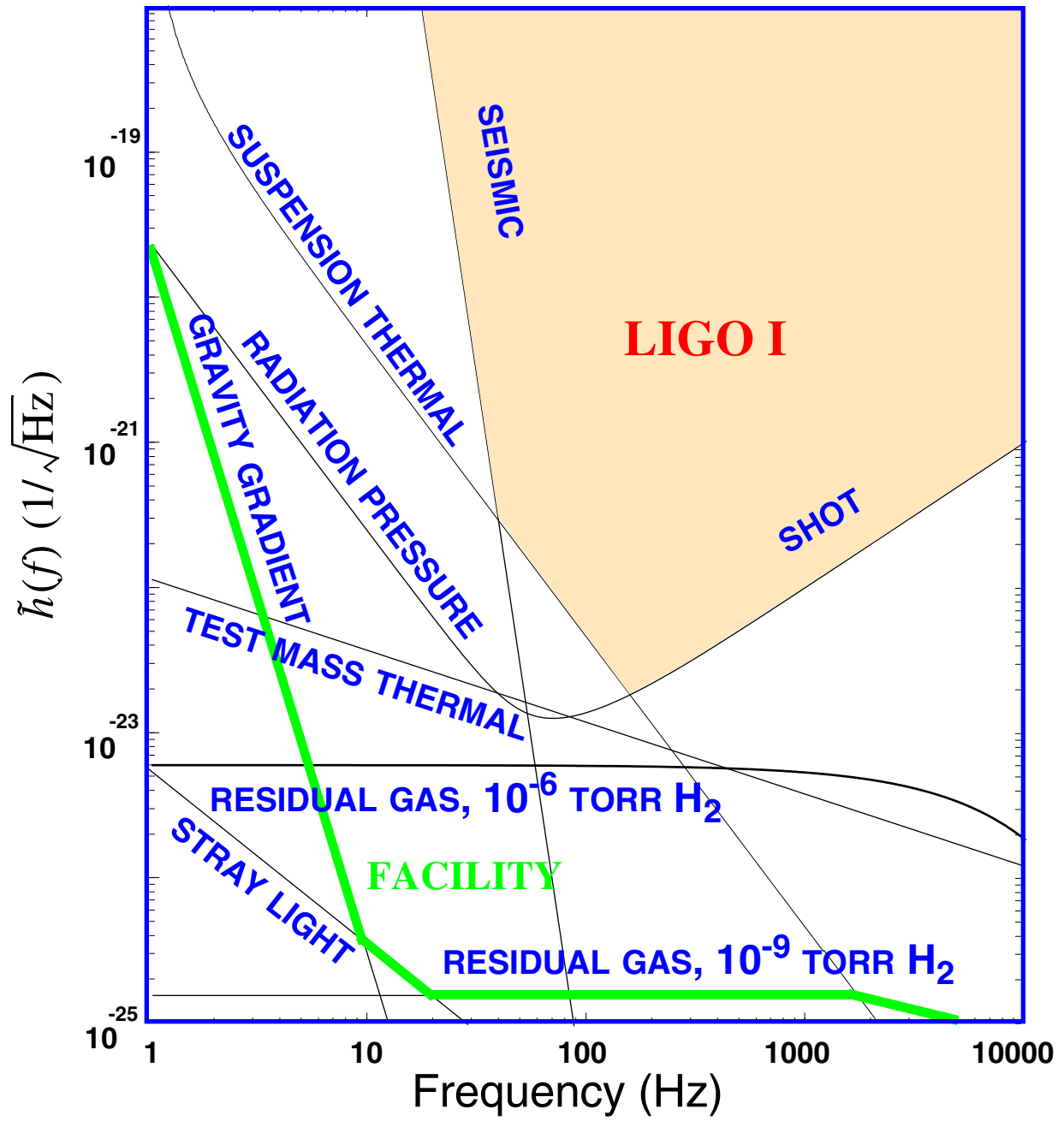

Current State of Interferometers

7/7 F. Frasconi *Status of Virgo*

7/7 R. Takahashi *Status of TAMA 300*

7/7 D. Sigg *Commissioning of LIGO Detectors*

7/7 B. Willke *Status of the GEO 600 detector*



CONGRATULATIONS

VIRGO INAUGURATION

July 23, 2003

- Completion of the vacuum system
- Hanging of all the test masses



CITF main steps

- Vacuum chamber installation in 1999
- Interferometer installation in 1999 and 2000
- Suspensions pre-commissioning in 2000
- Injection system pre-commissioning longer than originally thought
- CITF Commissioning started with small auxiliary laser in February 2001

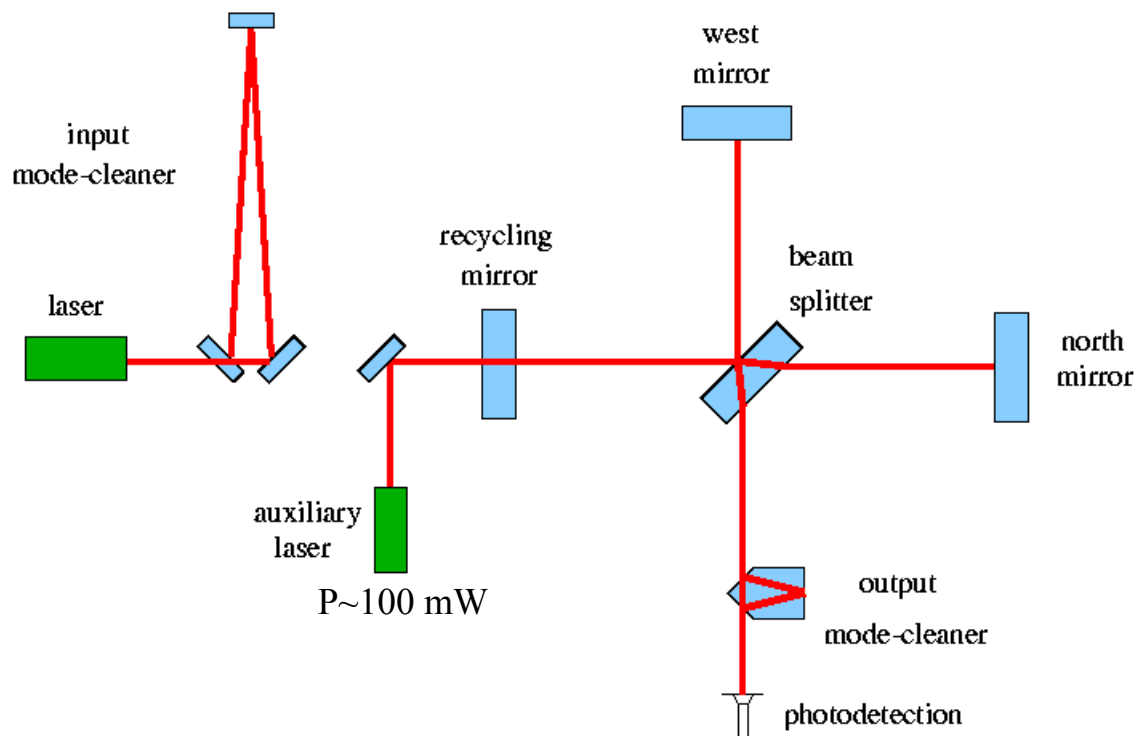

Main CITF commissioning steps

- Interferometer first alignment
- Simple Michelson
- Recycled Michelson
- Recycled Michelson with Injection



- The SA filters off the seismic noise above 4 Hz
- Below 4 Hz the mirror moves at the SA resonances of tens of microns
- ITF locking requires resonance damping

*Zeroth law of vibration isolators:
remove as much energy as you can*

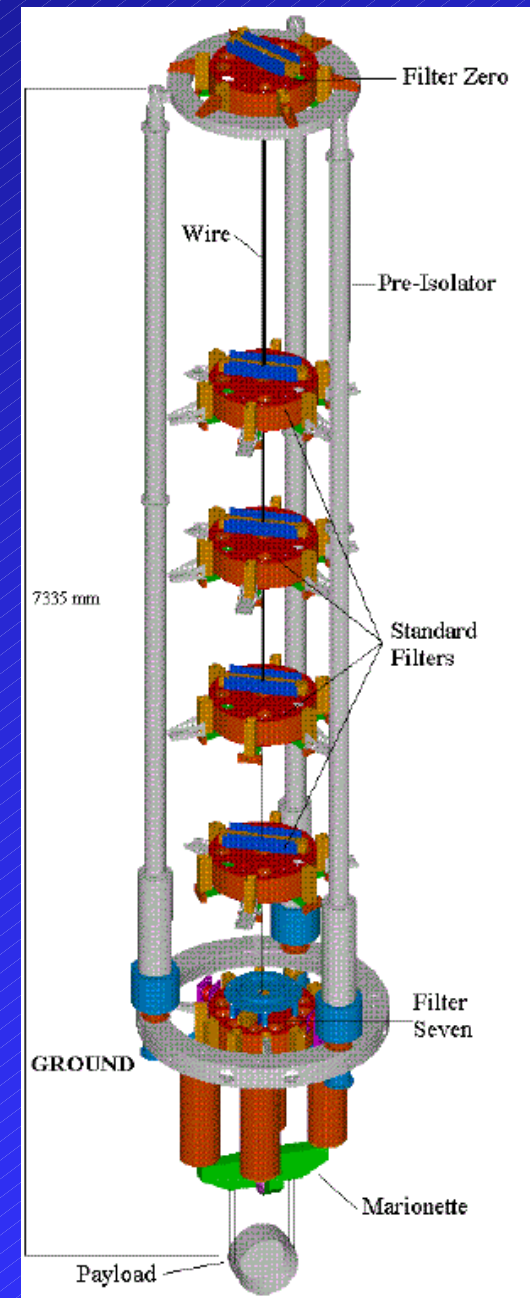
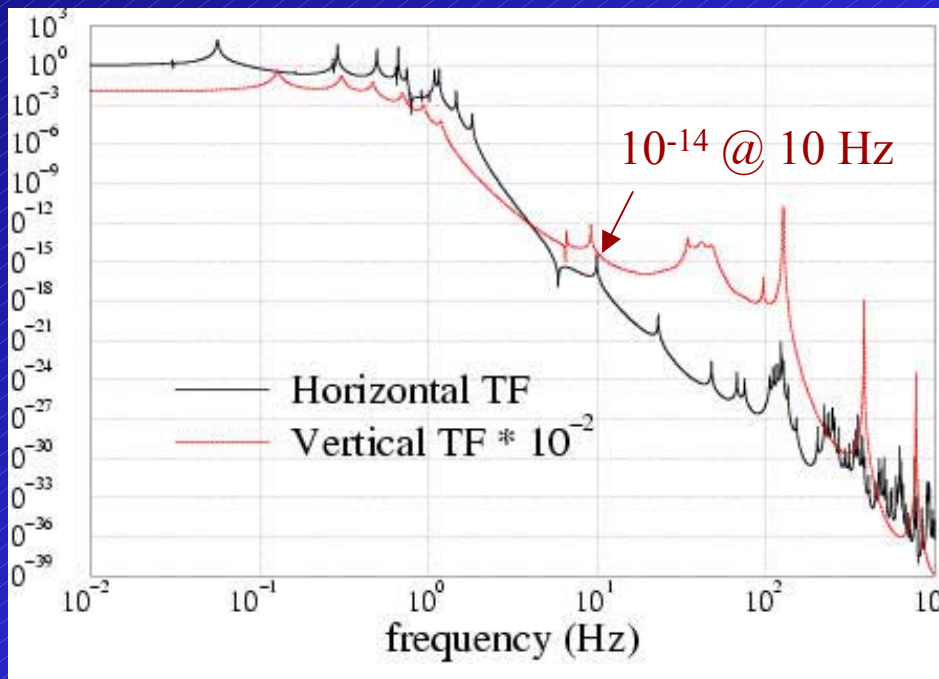



Summary of CITF sensitivity

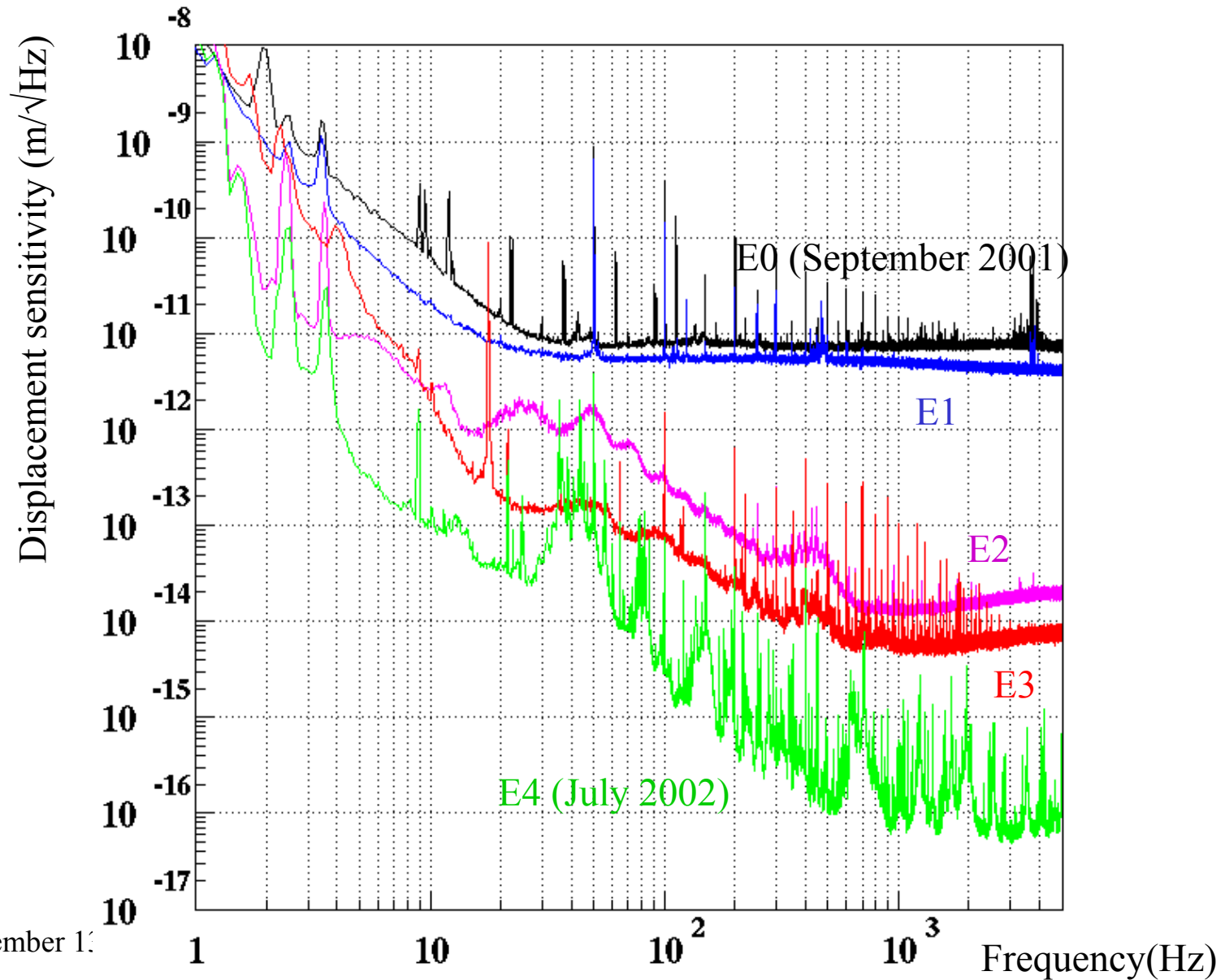

Cascina, November 1:

TAMA (Japanese) $L=300m$

● サイト: 国立天文台三鷹キャンパス(東京)

(E139.32.21 N35.40.25)

West
End
Room

Center
Room

300m

300m

South
End
Room

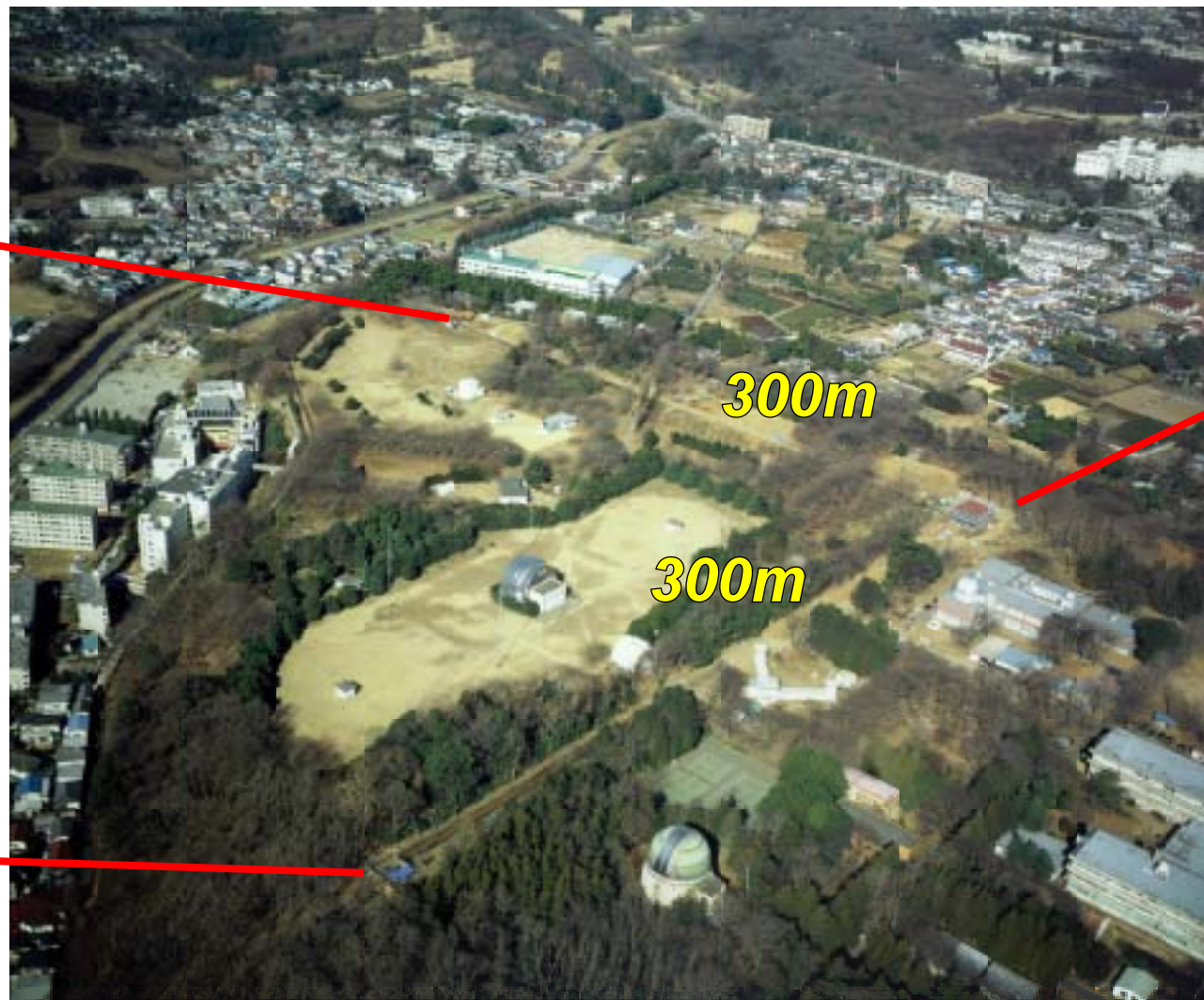

市街地の真っ只中に位置・交通量多し

制御系

光路長制御
アラインメント制御
強度安定化
ドリフト制御

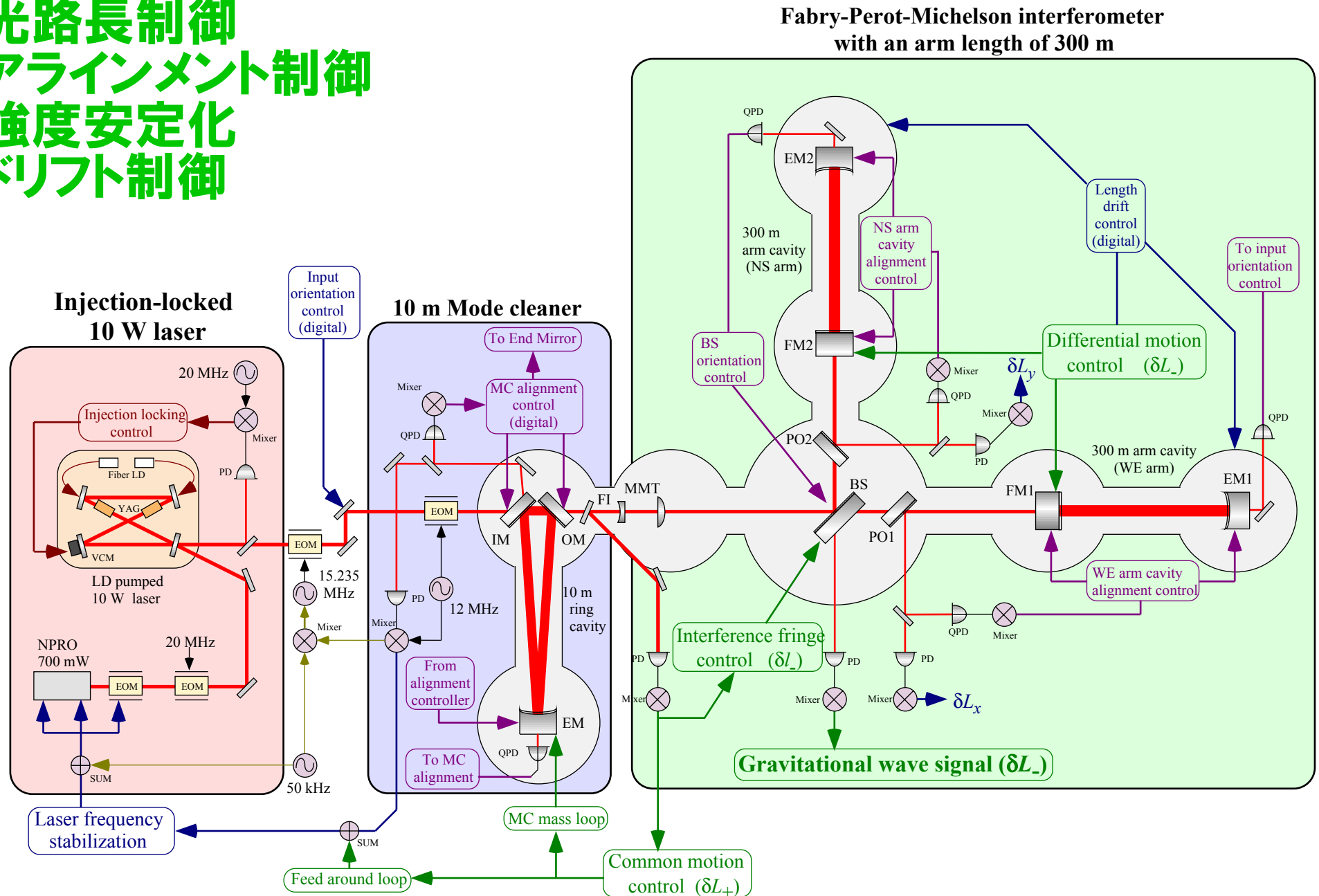

Displacement noise level of TAMA300

(September, 29 2002)

Preliminary

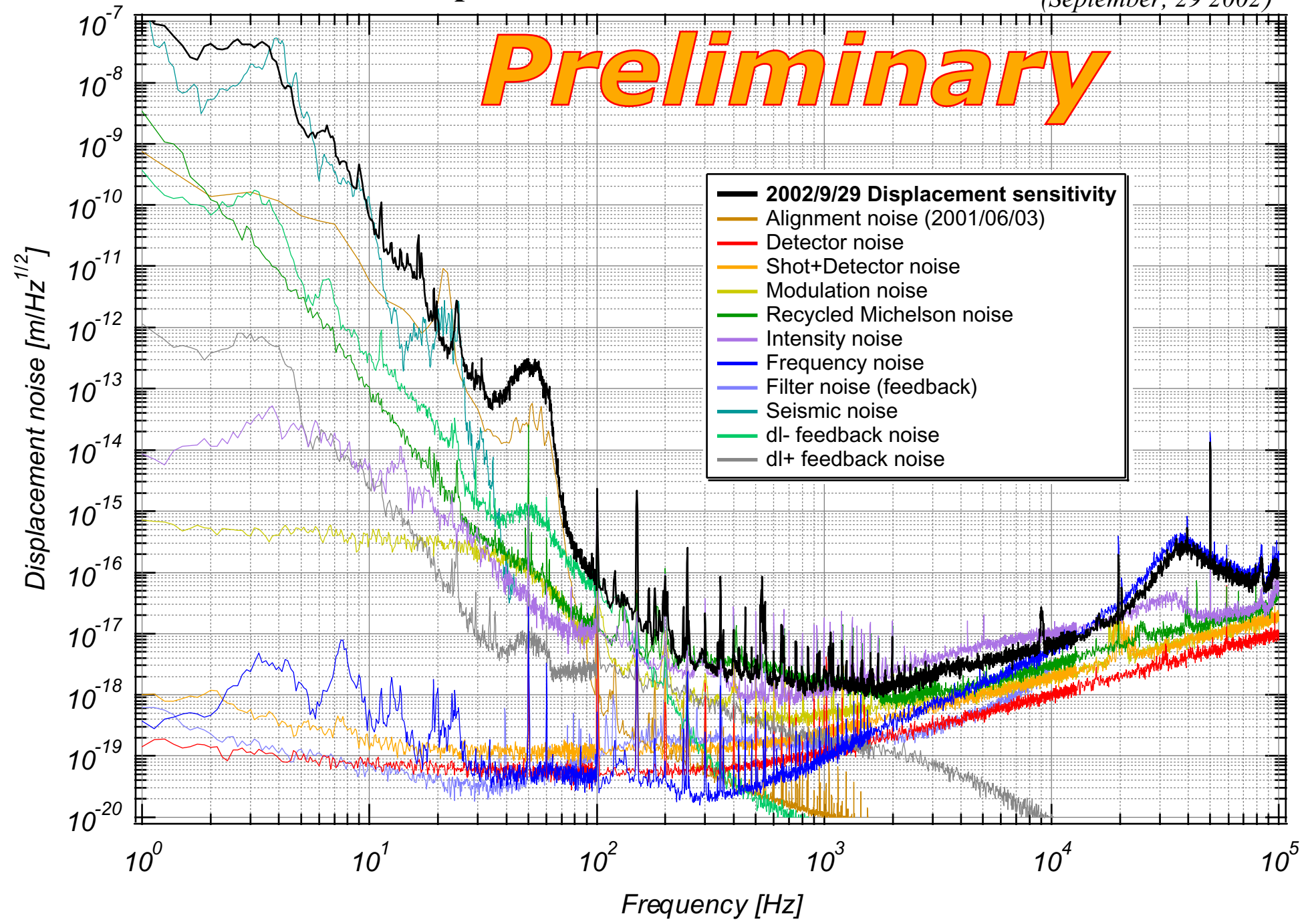

LIGO Observatory Facilities



LIGO Hanford Observatory [LHO]

26 km north of Richland, WA

2 km + 4 km interferometers in same vacuum envelope



LIGO Livingston Observatory [LLO]

42 km east of Baton Rouge, LA

Single 4 km interferometer

Some LLO Noise Sources

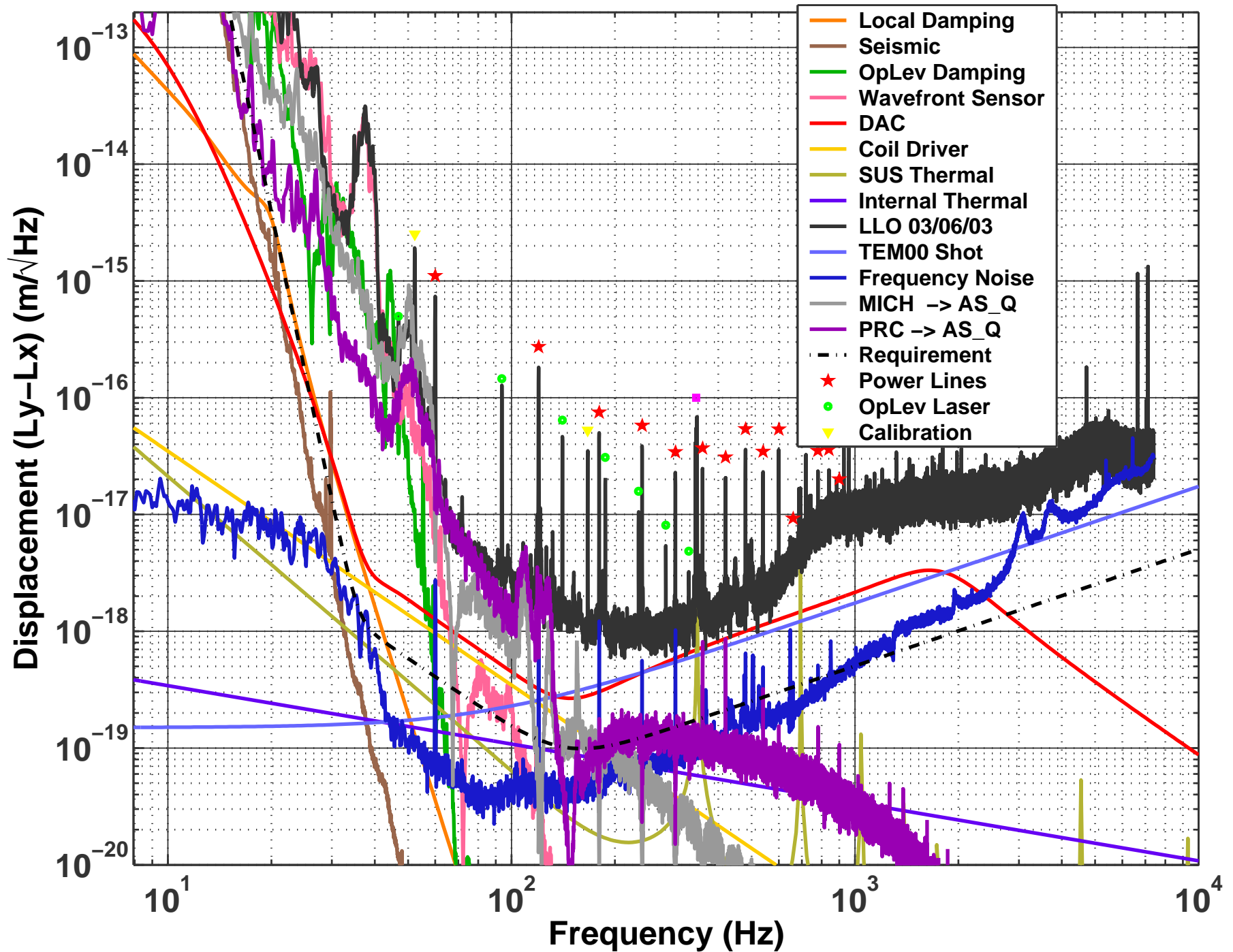

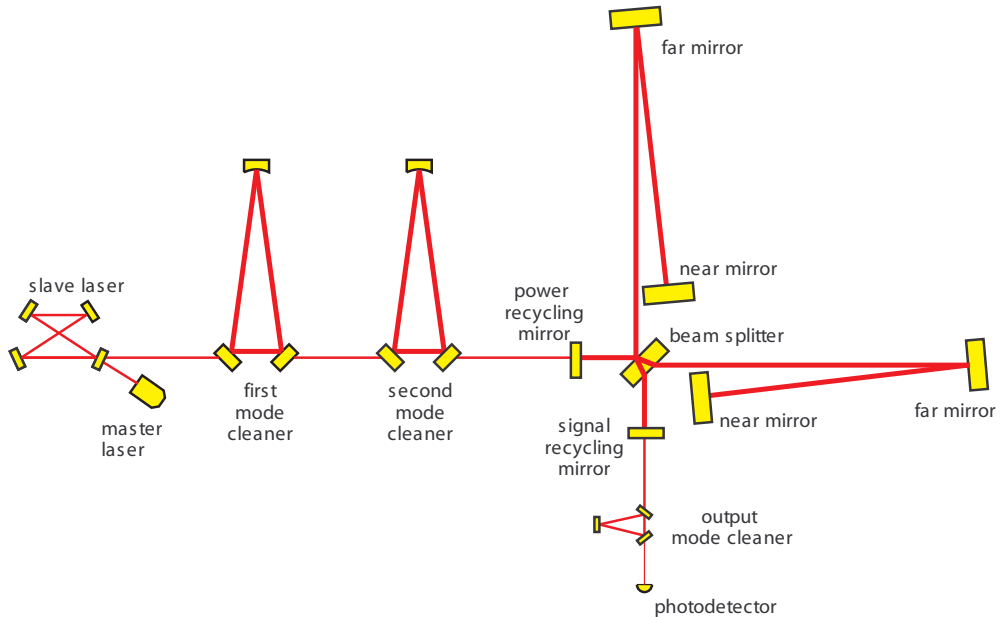



Strain Sensitivity for the LLO 4km Interferometer

31 January 2003

LIGO-G030014-00-E

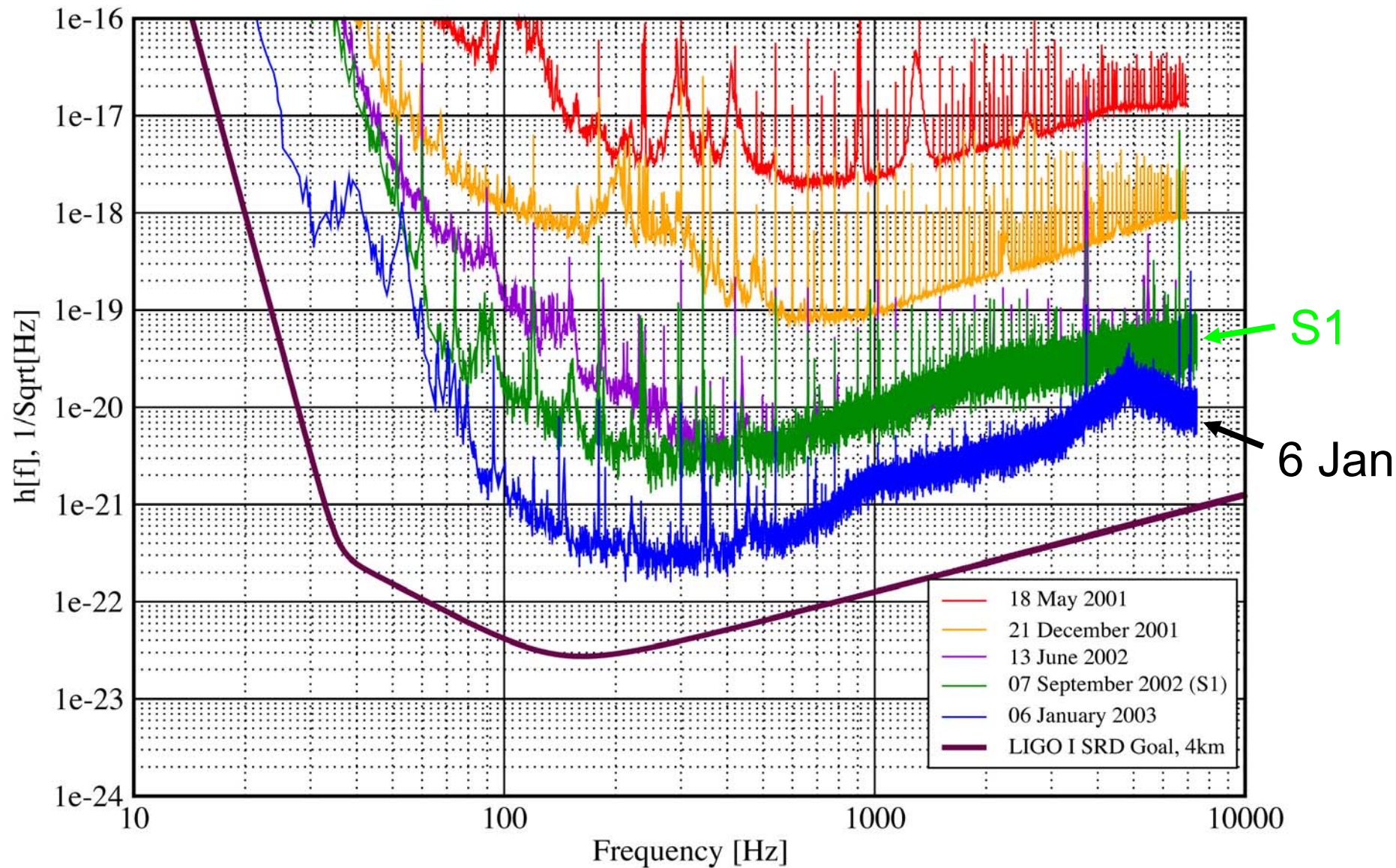



LIGO Scientific Collaboration Member Institutions

University of Adelaide ACIGA
Australian National University ACIGA
Balearic Islands University
California State Dominguez Hills
Caltech CACR
Caltech LIGO
Caltech Experimental Gravitation CEGG
Caltech Theory CART
University of Cardiff GEO
Carleton College
Cornell University
Fermi National Laboratory
University of Florida @ Gainesville
Glasgow University GEO
NASA-Goddard Spaceflight Center
University of Hannover GEO
Hobart – Williams University
India-IUCAA
IAP Nizhny Novgorod
Iowa State University
Joint Institute of Laboratory Astrophysics
Salish Kootenai College

LIGO Livingston LIGOLA
LIGO Hanford LIGOWA
Loyola New Orleans
Louisiana State University
Louisiana Tech University
MIT LIGO
Max Planck (Garching) GEO
Max Planck (Potsdam) GEO
University of Michigan
Moscow State University
NAOJ - TAMA
Northwestern University
University of Oregon
Pennsylvania State University
Southeastern Louisiana University
Southern University
Stanford University
Syracuse University
University of Texas@Brownsville
Washington State University@ Pullman
University of Western Australia ACIGA
University of Wisconsin@Milwaukee

Data Analysis for Sources

7/7 B. Allen *Analysis of data from LIGO and GEO*

7/9 A. Weinstein, M. Ando, P. Sutton, L. Cadonati*Burst limits*

7/9 J. Whelan*Stochastic limits*

7/9 G. Gonzalez, H. Takahashi, L. Bosi*Inspiral limits*

7/9 G. Woan, B. Allen, M. Yvert, A. Vecchio*Periodic source limits*

7/9 Y. Tsunesada .. *Black Hole ringdown limits*

7/9 S. Mohanty *GRB and GW*

Nearer term improvements

7/11 D. Shoemaker Advanced LIGO

7/11 T. Uchiyama Present Status of LCGT

Advanced Interferometer Concept

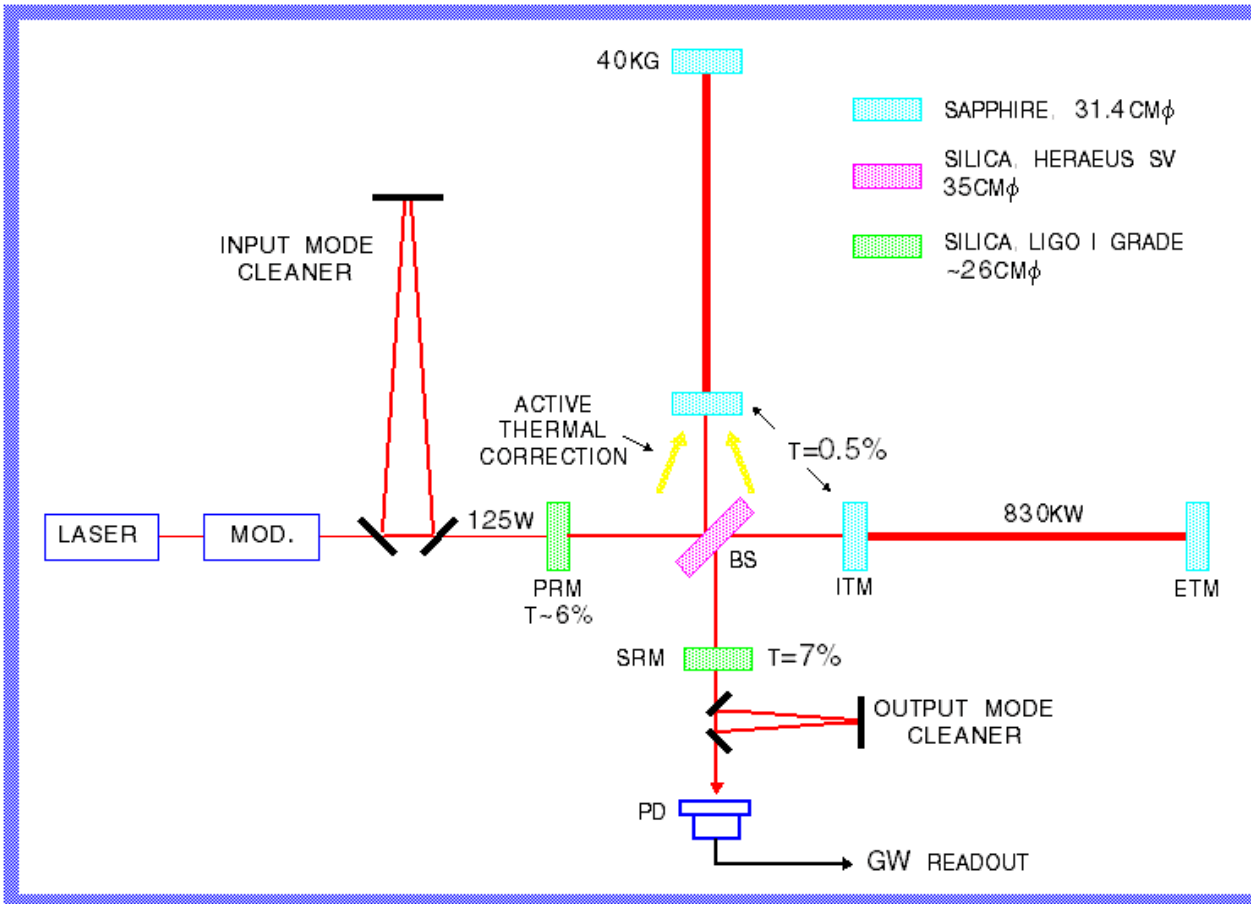

- » Signal recycling
- » 180-watt laser
- » 40 kg Sapphire test masses
- » Larger beam size
- » Quadruple suspensions
- » Active seismic isolation
- » Active thermal correction
- » Output mode cleaner

Projected Performance

- Seismic ‘cutoff’ at 10 Hz
- Suspension thermal noise
- Internal thermal noise
- Unified quantum noise dominates at most frequencies
- ‘technical’ noise (e.g., laser frequency) levels held in general well below these ‘fundamental’ noises

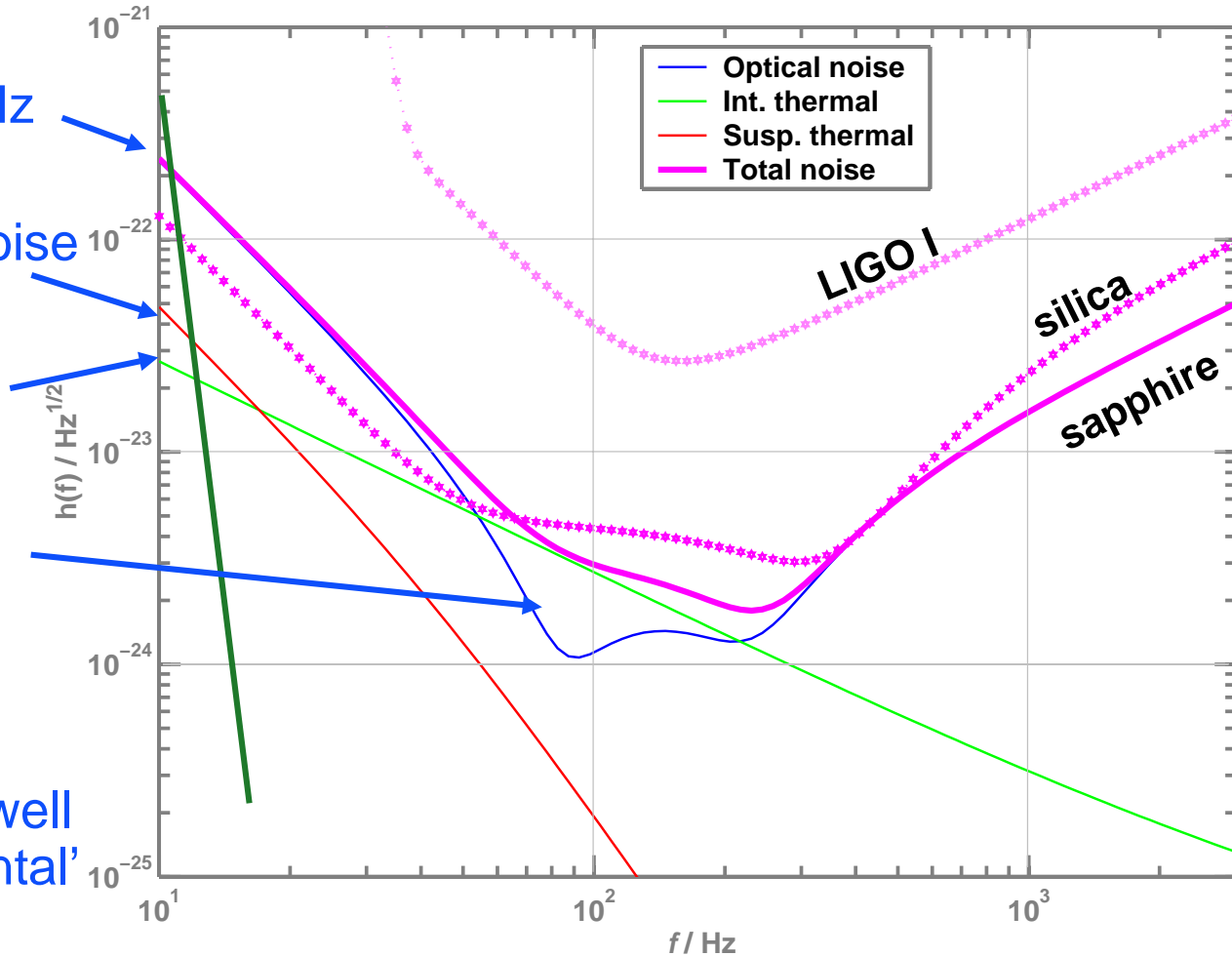

PROJECTED TERRESTRIAL GRAVITATIONAL WAVE DETECTORS

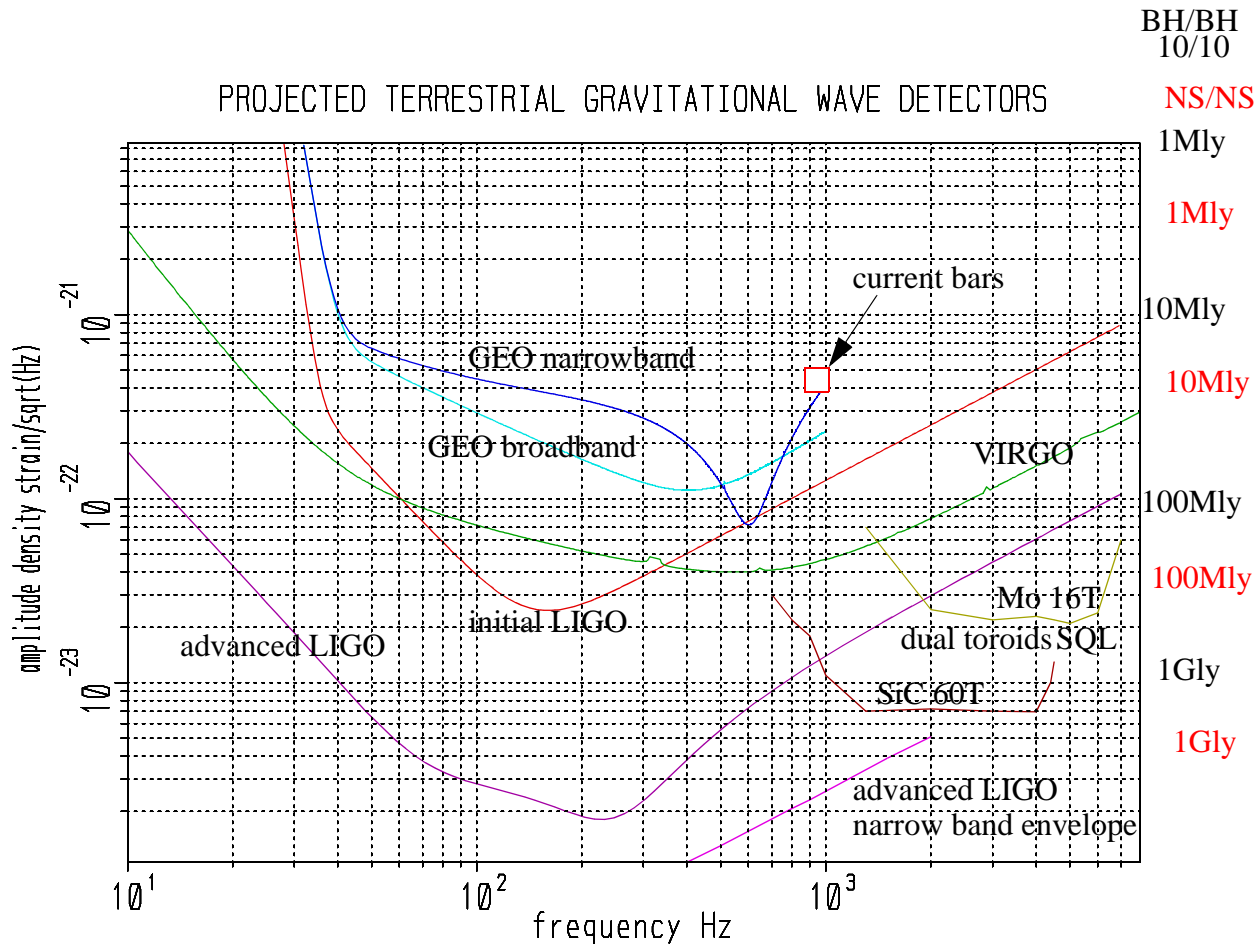

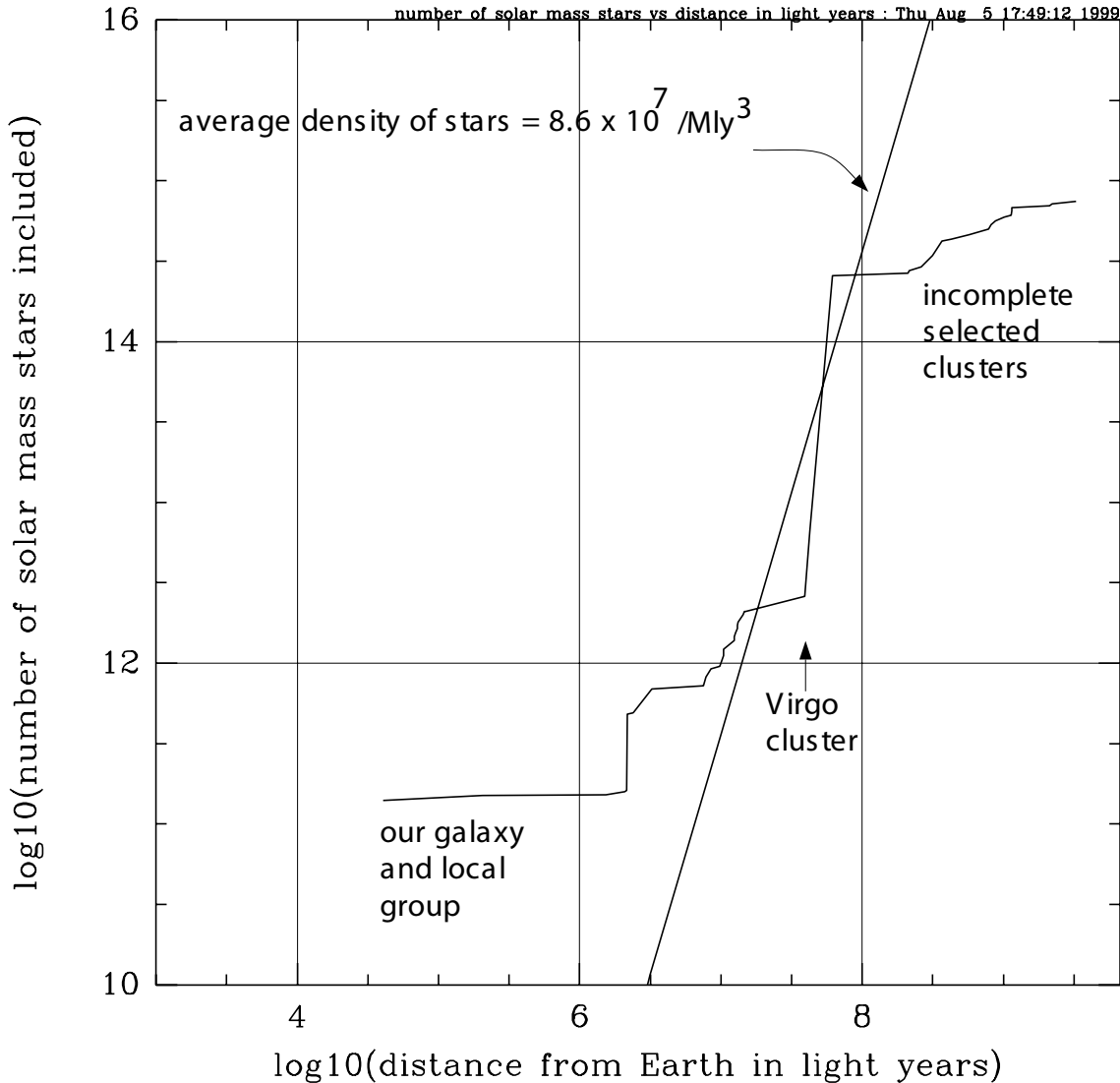

DATA: Cosmology of the Local Group G.Lake
Astrophysical Quantities C.W.Allen

Longer term improvements

- 7/11 S. Miyoki *CLIO Cryogenic Laser Interferometer*
- 7/11 A. Giazotto *Cryogenic Interferometers*
- 7/11 K. McKenzie *Squeezing in GW detector*

THINGS TO THINK ABOUT

DETECTORS:

Matched detection filters

- Time domain optimization: NS/NS binaries - vary amplitude recycling mirror position to follow spectrum
- Frequency domain optimization with multiple cavities and/or time delay at antisymmetric port

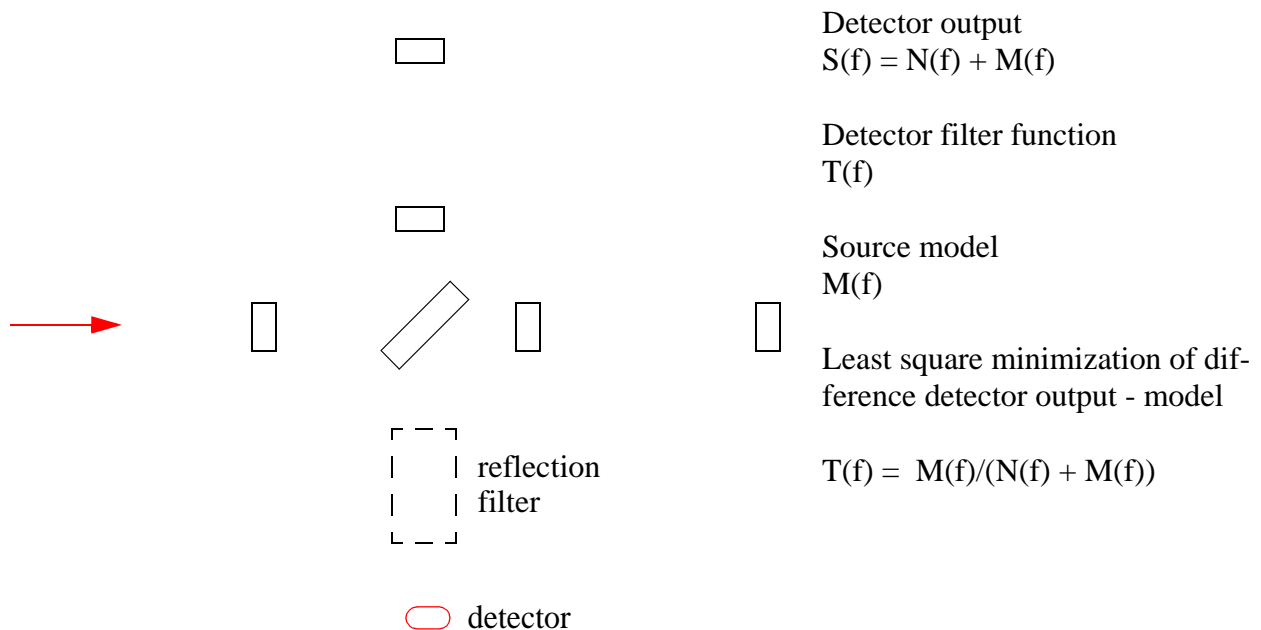

example reflection filter: diffraction grating with multiple cavities

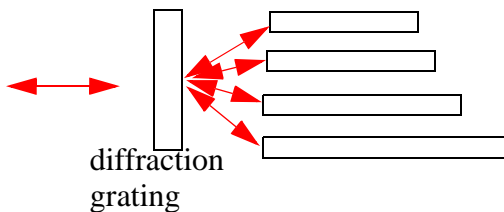

DATA ANALYSIS

- Work on the gravitational waveform inverse problem
 determine the dynamics at the source from the waveform