The search for gravitational waves with the new generation of interferometers

Peter R. Saulson
Syracuse University

LIGO-G030345-00-Z

Outline

1. Gravitational waves and how to detect them
2. The new generation of interferometric detectors
3. Sample of first results

A set of freely-falling test masses

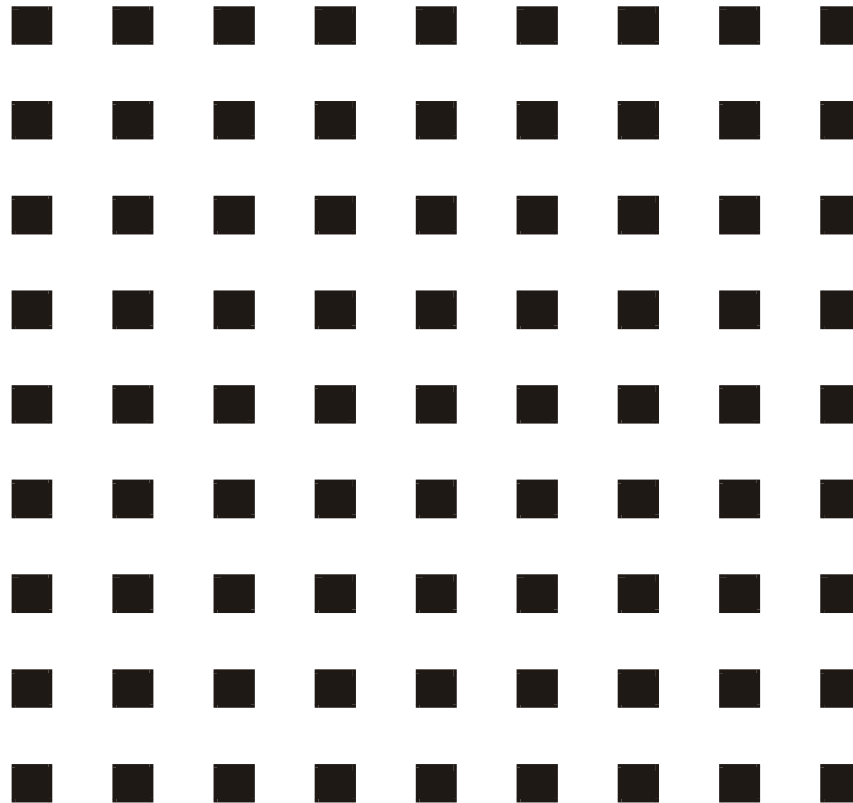

How a gravitational wave affects a set of test masses

- **Transverse**

No effect along direction of propagation

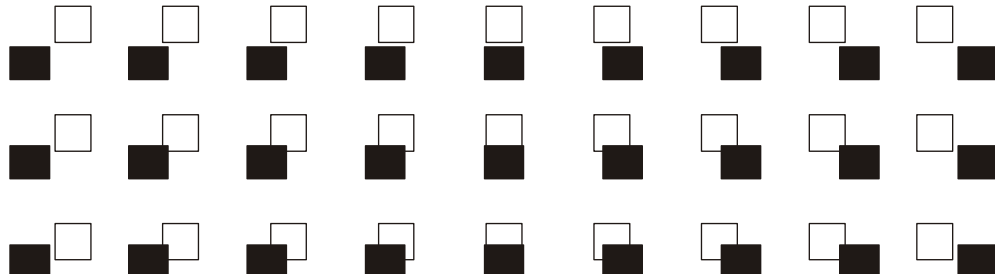
- **Quadrupolar**

Opposite effects along x and y directions

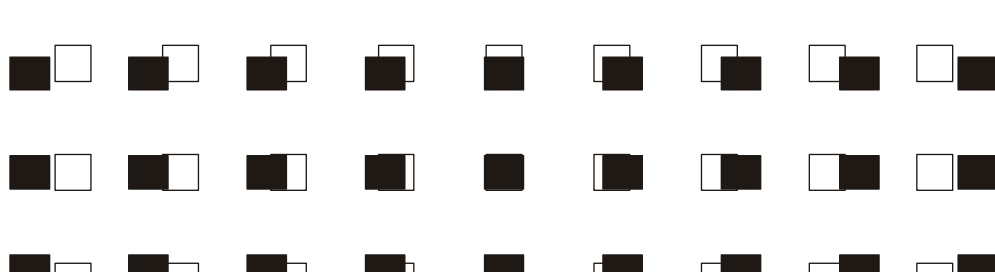

- **Strain**

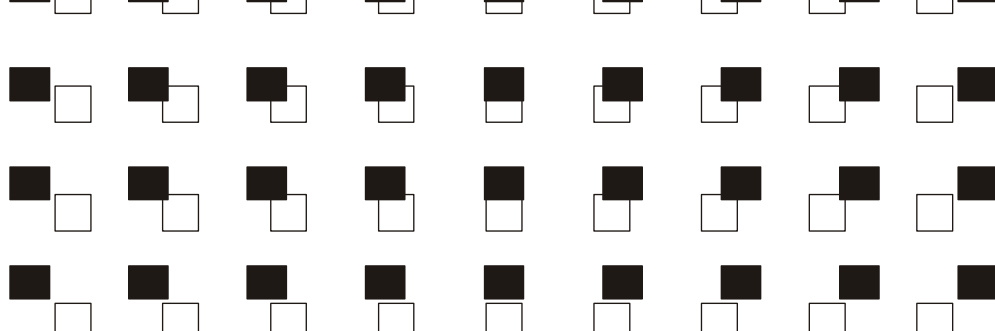
Larger effect on longer separations

$$h \equiv 2 \frac{\Delta L}{L}$$

Generators of gravitational waves

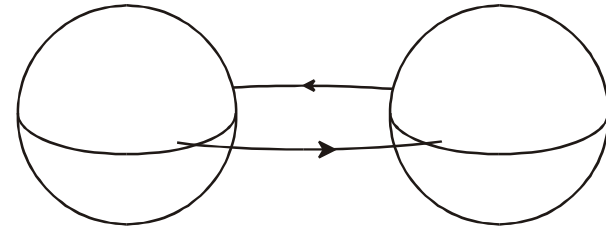
Binary stars (especially compact objects, e.g. neutron stars or black holes.)



Compact objects just after formation from core collapse.

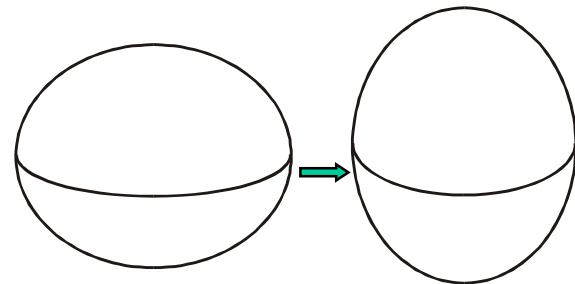

Or anything else with a dramatic variation in its mass quadrupole moment, especially on msec scales.

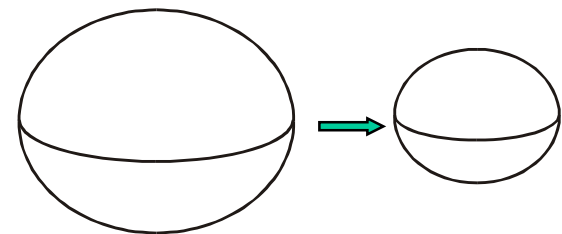

Science Goals

- **Physics**
 - Direct verification of the most “relativistic” prediction of general relativity
 - Detailed tests of properties of grav waves: speed, strength, polarization, ...
 - Probe of strong-field gravity
 - Early universe physics
- **Astronomy and astrophysics**
 - Abundance & properties of supernovae, neutron star binaries, black holes
 - Tests of gamma-ray burst models
 - Neutron star equation of state
 - *A new window on the universe*

Why gravitational wave detection is hard to do

A gravitational wave detector needs

- A set of test masses,
- Instrumentation sufficient to see tiny motions,
- Isolation from other causes of motions.

The challenge:

The best astrophysical estimates predict fractional separation changes of only 1 part in 10^{21} , or less.

Resonant detector

A massive (usually aluminum) cylinder. Vibrating in its gravest longitudinal mode, its two ends are like two test masses connected by a spring.

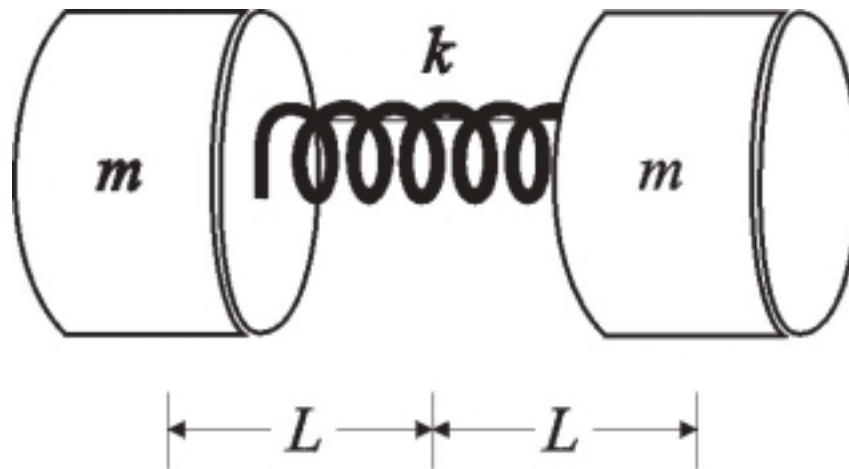

Cooled by liquid He (or dilution refrigerator).
rms sensitivity below 10^{-18} (now around 10^{-19})

An alternative detection strategy using interferometry



Tidal character of wave argues for test masses
as far apart as practicable. Free masses (in the
form of pendulums), kilometers apart.

Sense the motions of distant free masses with an interferometer

Michelson
interferometer

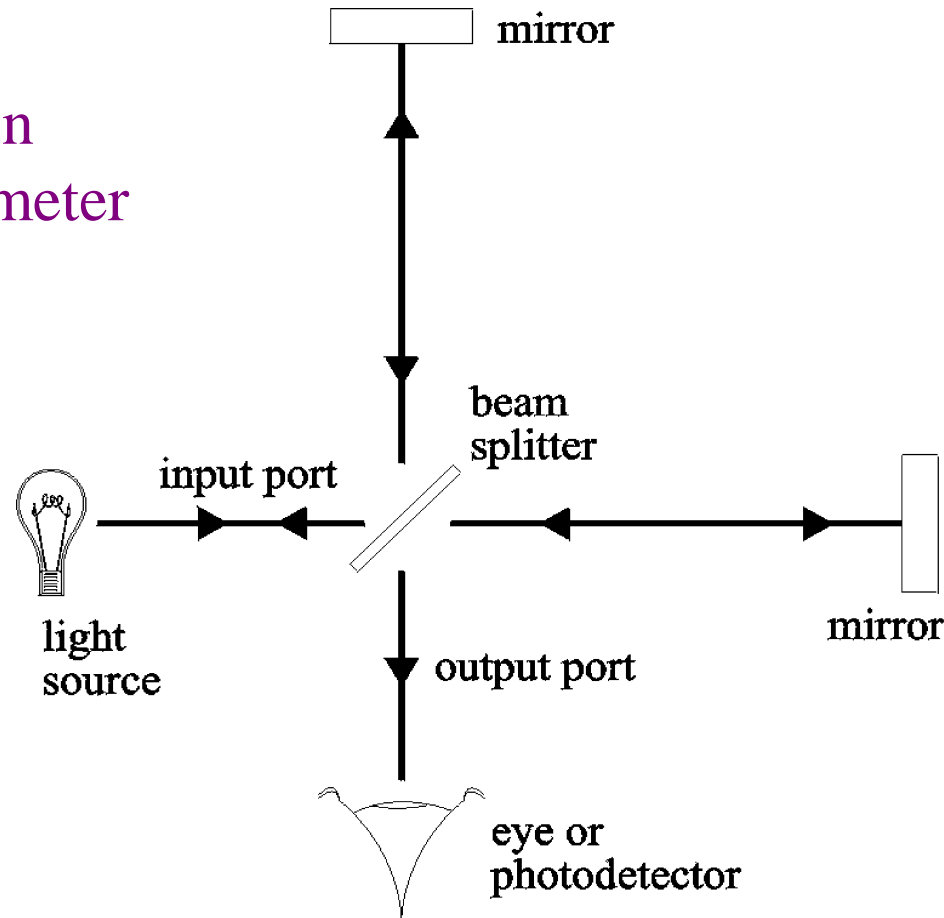

Interferometer: a transducer from length difference to brightness

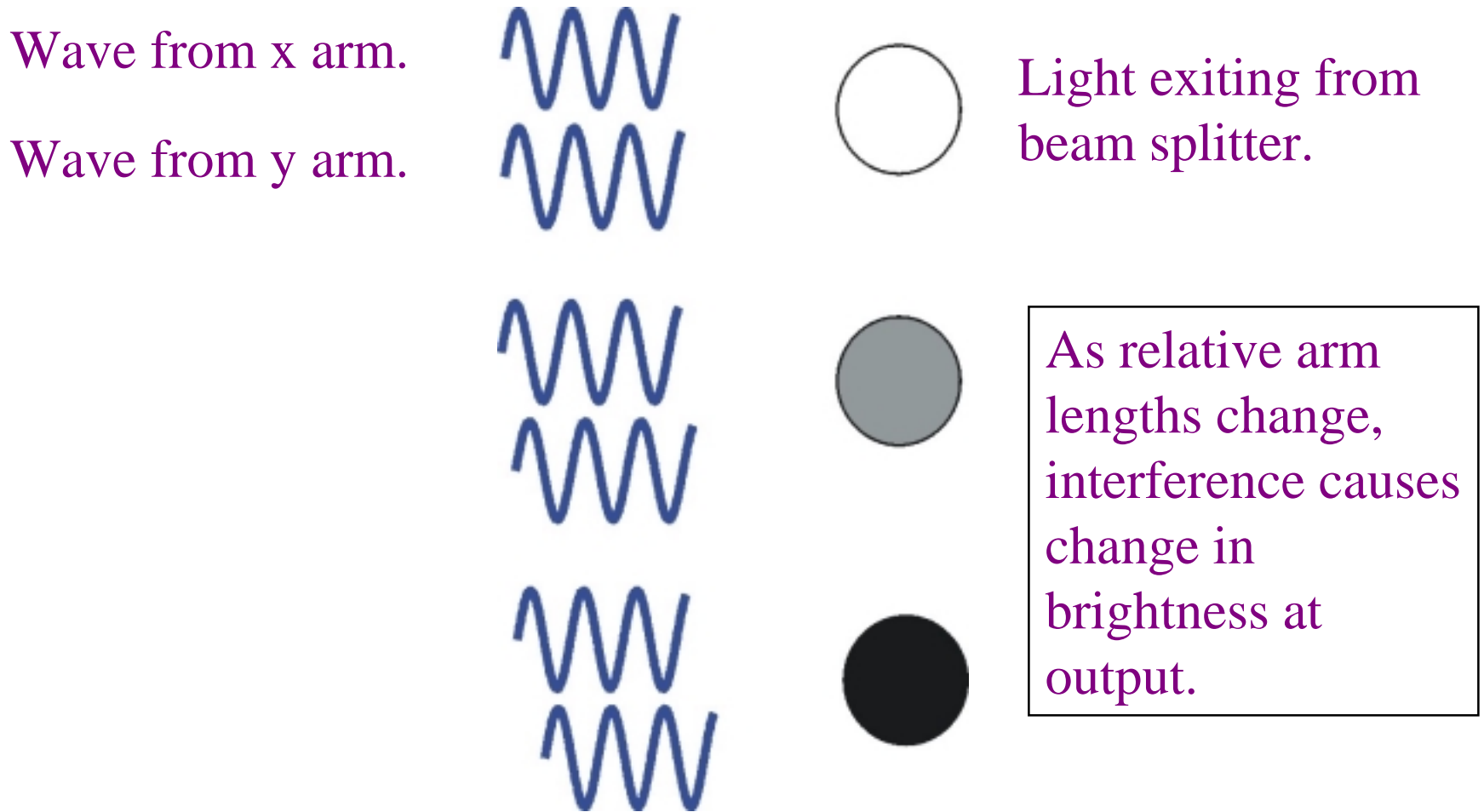

An International Network of Interferometers

Simultaneously detect signal (within msec)

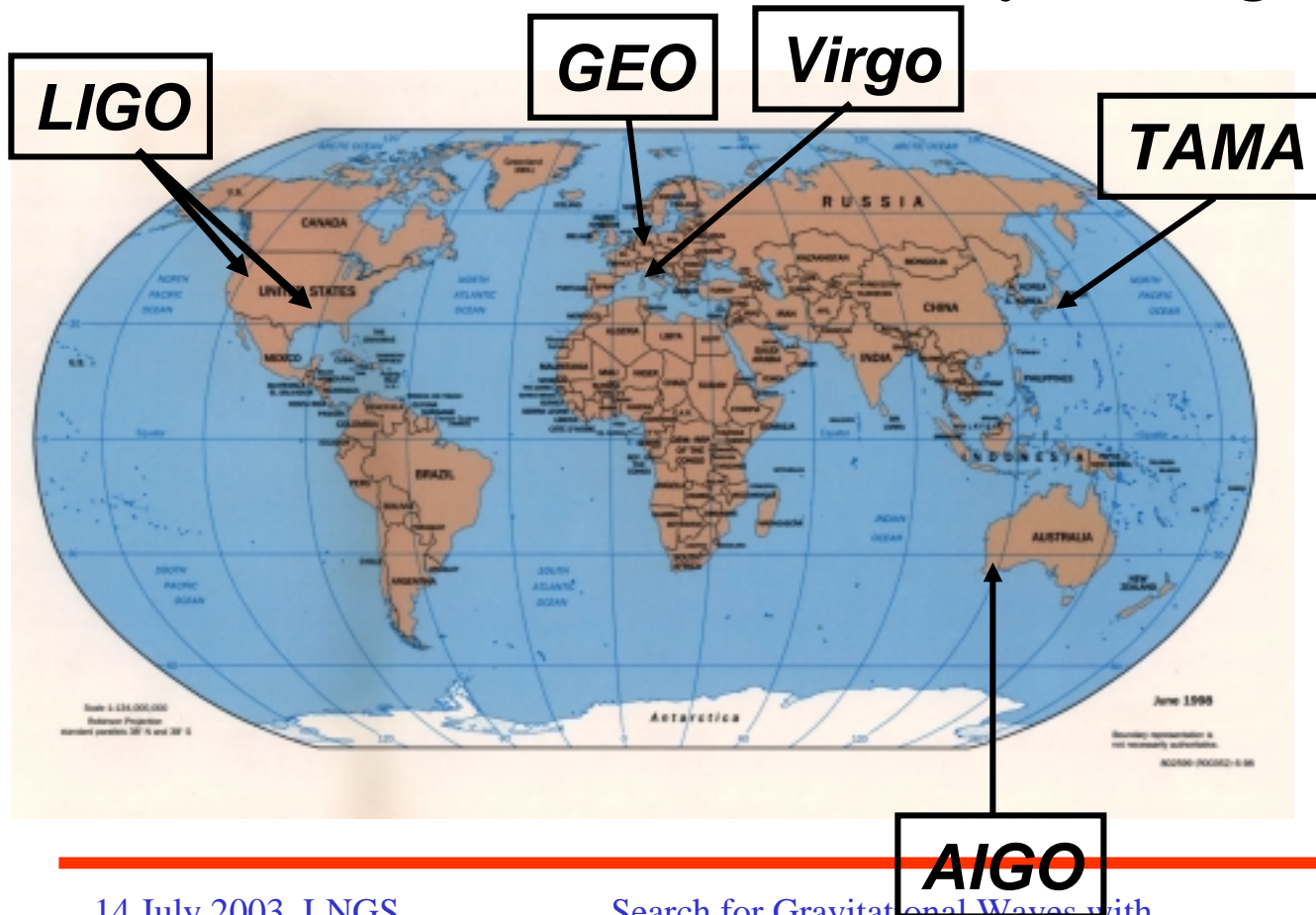

detection
confidence

locate the sources

decompose the
polarization of
gravitational
waves

Status of interferometer projects

Virgo (3 km, Cascina (Pisa), Italy):

Installation complete. Commissioning of full-length interferometer about to begin.

TAMA (300 m, Tokyo, Japan):

In operation, about 10x above design sensitivity.
Excellent stability; coincident analysis with LIGO about to begin.

GEO (600 m, Hannover, Germany):

Taking data with LIGO while commissioning.

LIGO: subject of the rest of this talk

LIGO Laboratory Sites

Laser Interferometer Gravitational-wave Observatory (LIGO)

**Hanford
Observatory**

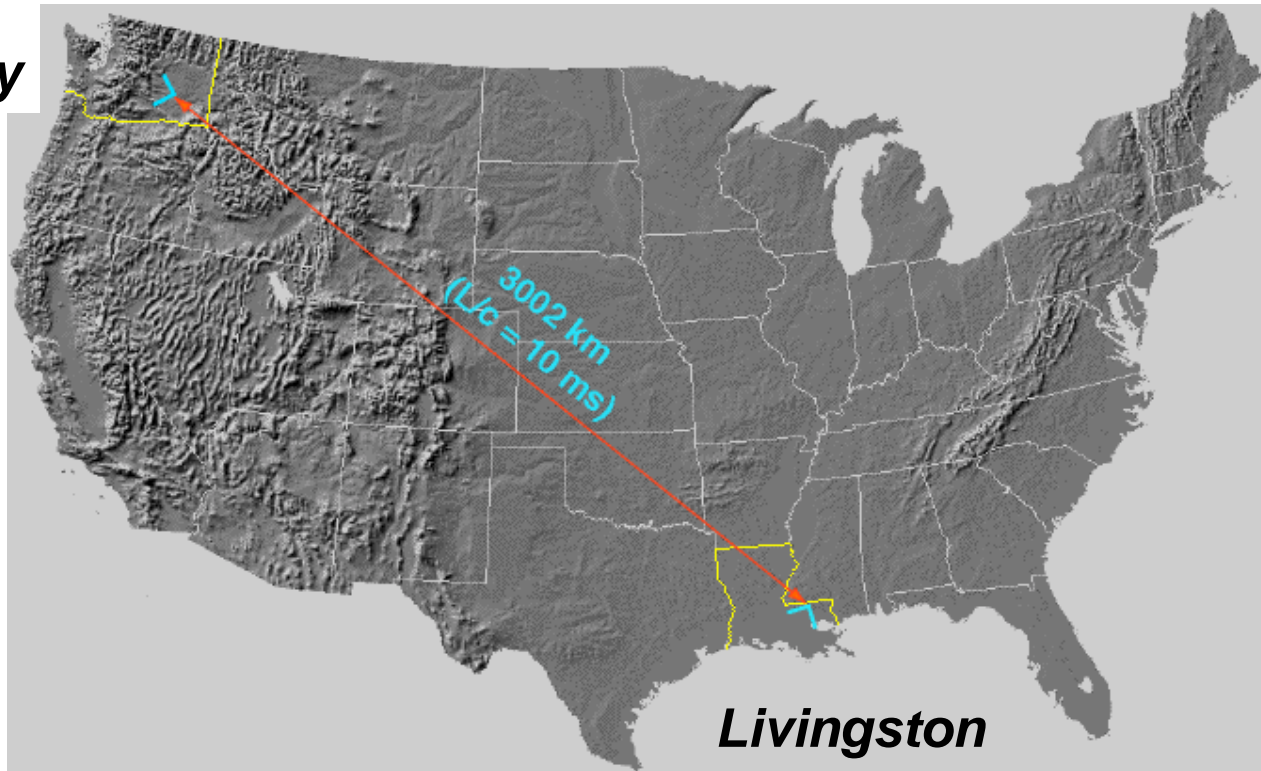

**Livingston
Observatory**

LIGO Livingston Observatory



LIGO Hanford Observatory

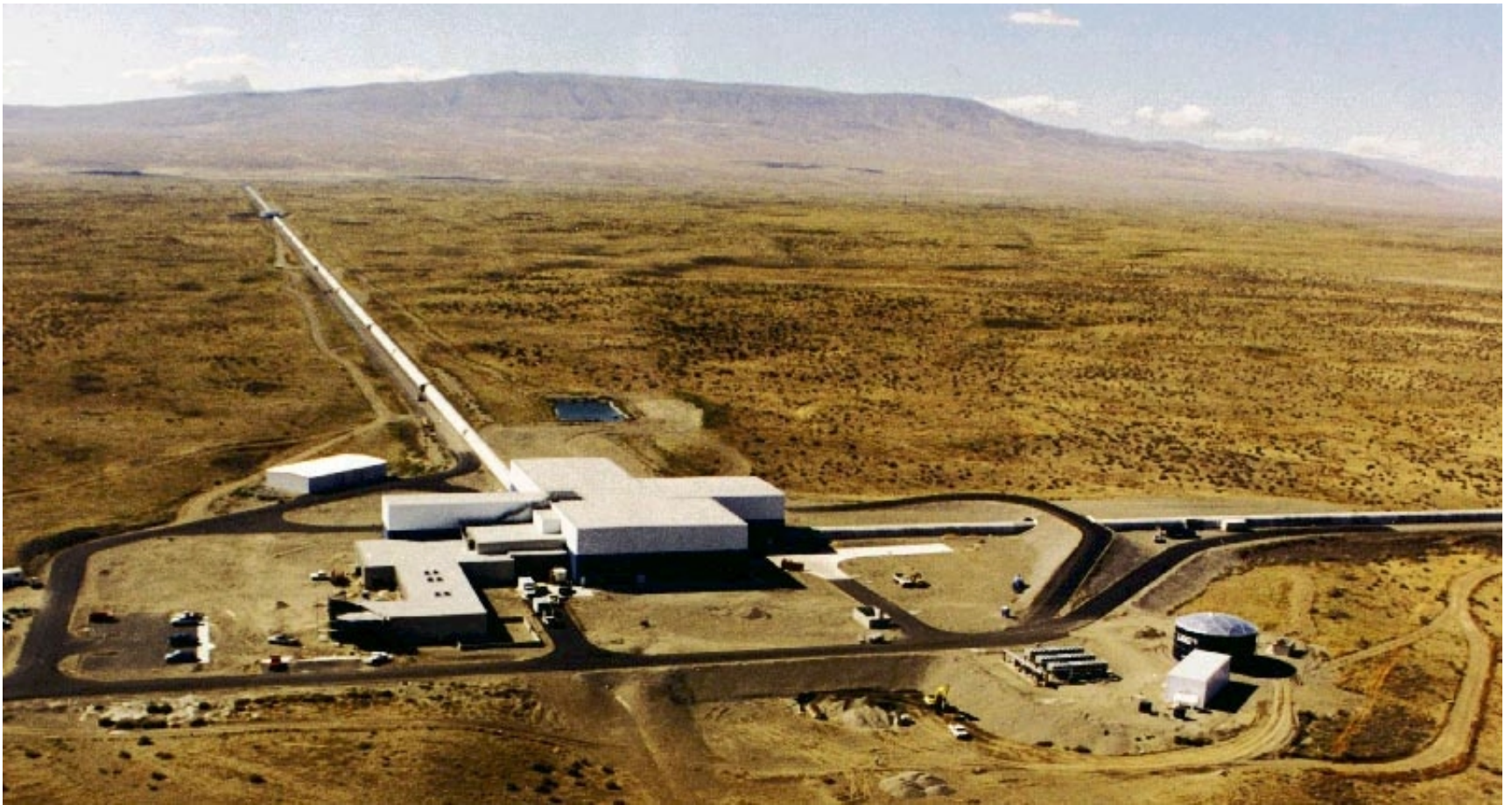

GEO 600



LIGO Beam Tube



**1.2 m diameter - 3mm stainless
50 km of weld**

NO LEAKS !!

- LIGO beam tube under construction in January 1998
- 65 ft spiral welded sections
- girth welded in portable clean room in the field

LIGO Vacuum Equipment



A LIGO Mirror

Substrates: SiO_2

25 cm Diameter, 10 cm thick

Homogeneity $< 5 \times 10^{-7}$

Internal mode Q's $> 2 \times 10^6$

Polishing

Surface uniformity $< 1 \text{ nm rms}$

Radii of curvature matched $< 3\%$

Coating

Scatter $< 50 \text{ ppm}$

Absorption $< 2 \text{ ppm}$

Uniformity $< 10^{-3}$

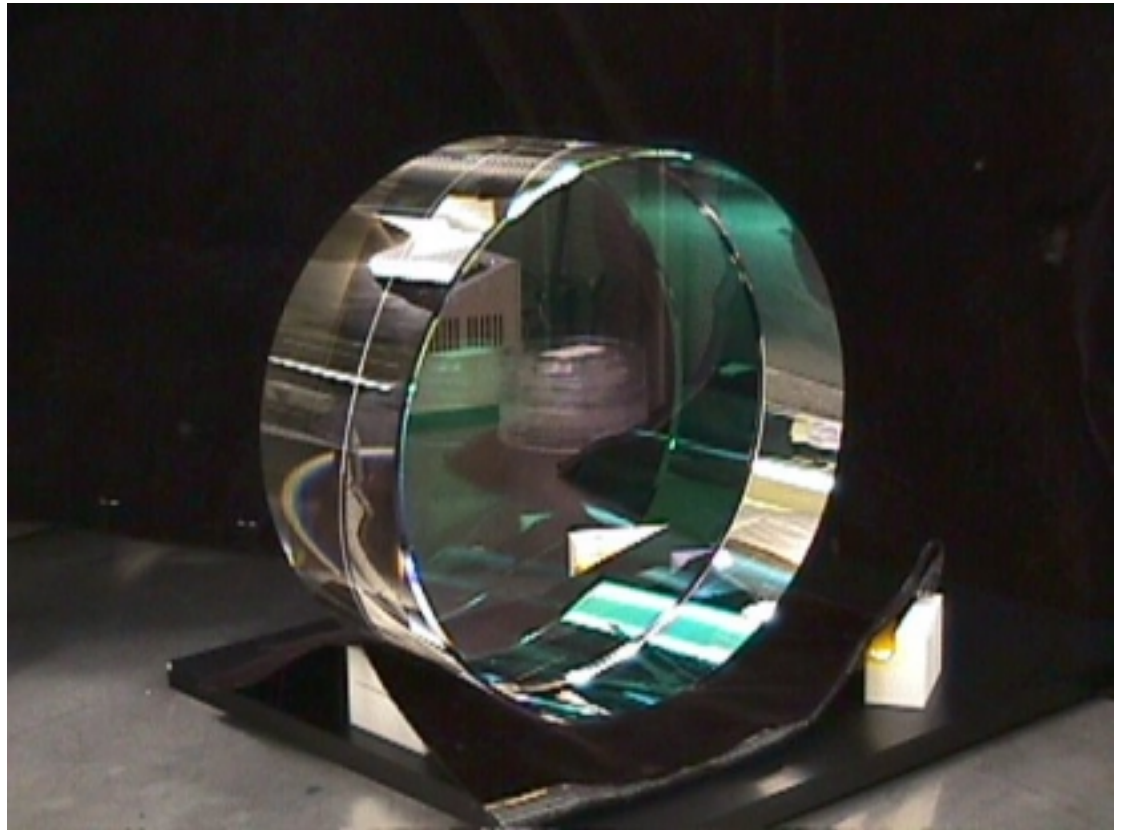

Core Optics installation and alignment



What Limits Sensitivity of Interferometers?

- Seismic noise & vibration limit at low frequencies
- Atomic vibrations (Thermal Noise) inside components limit at mid frequencies
- Quantum nature of light (Shot Noise) limits at high frequencies
- Myriad details of the lasers, electronics, etc., can make problems above these levels

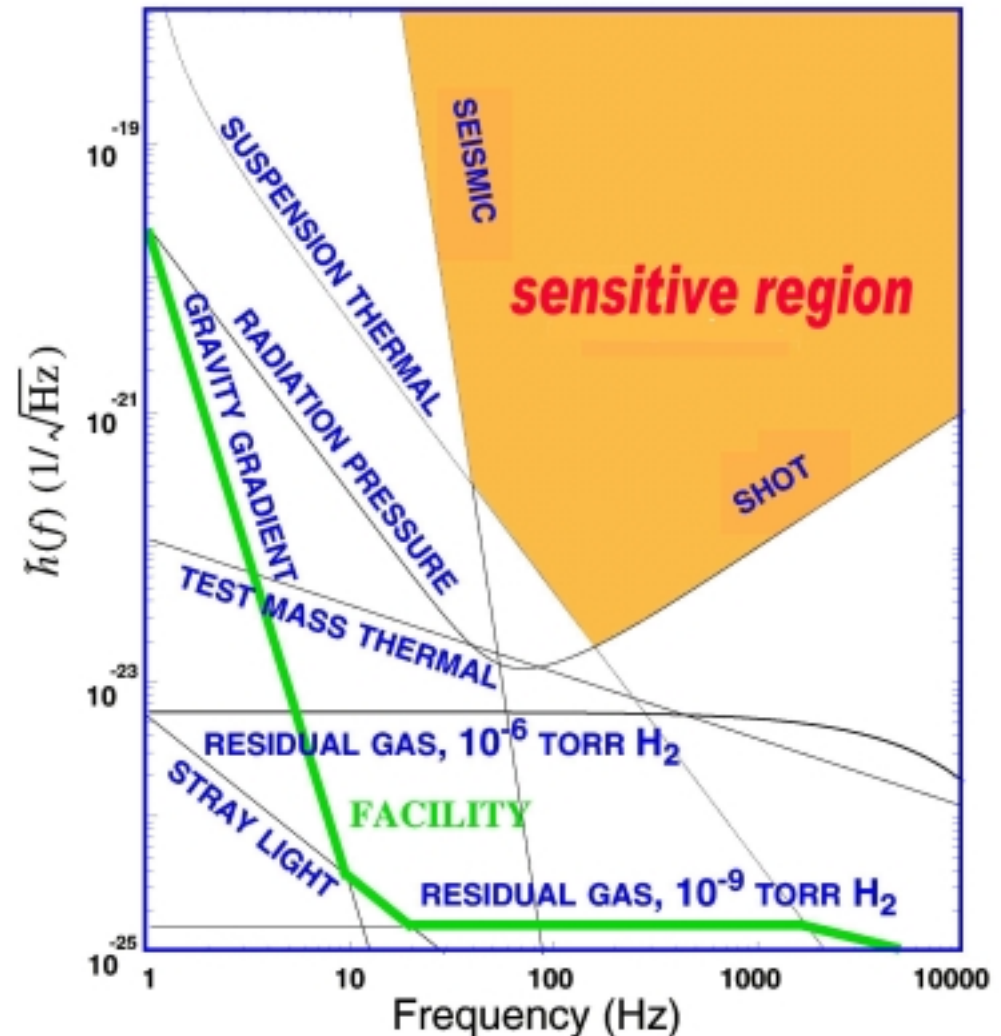

LIGO's Recent History

L4k strain noise @ 150 Hz [$\text{Hz}^{-1/2}$]

10^{-17}

10^{-18}

10^{-19}

10^{-20}

10^{-21}

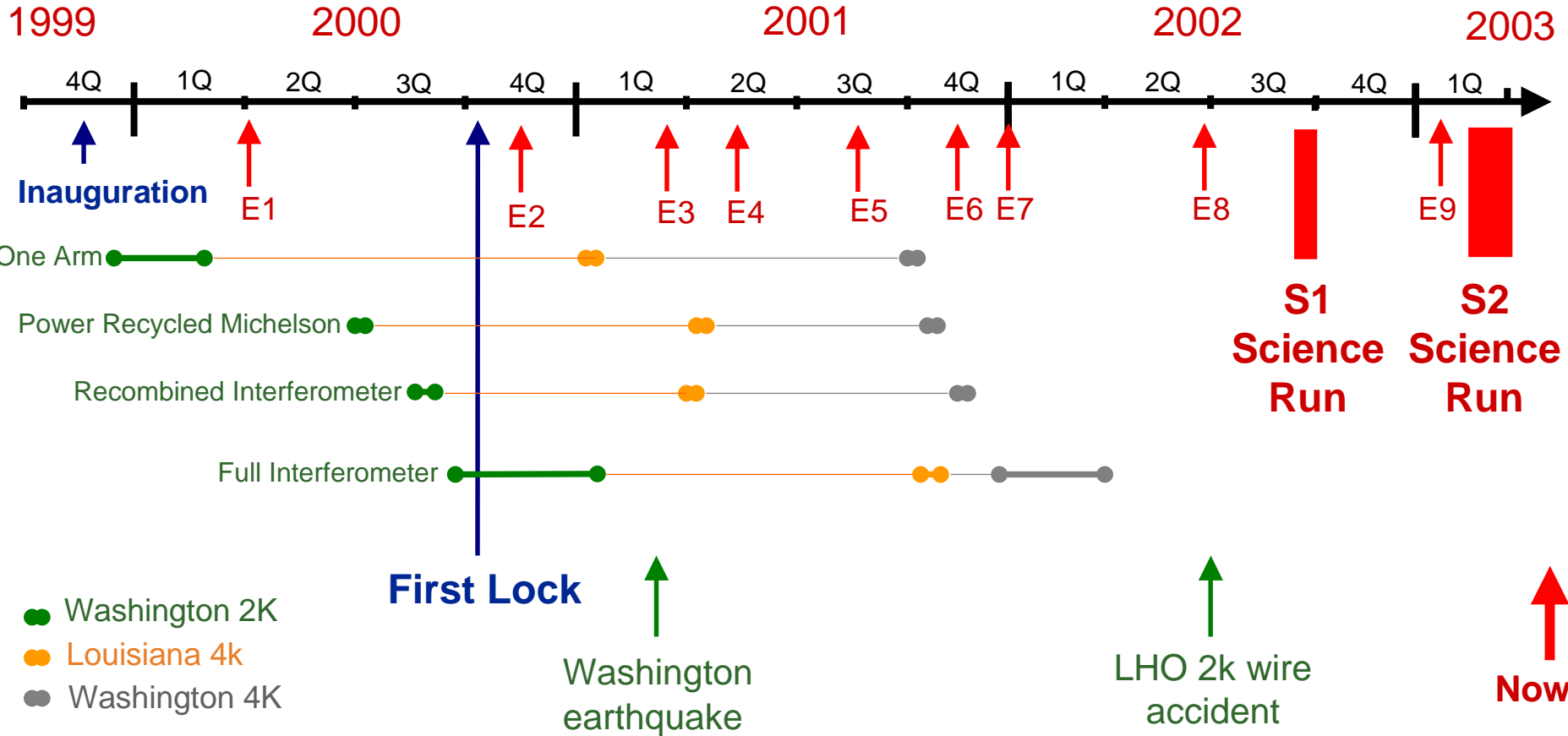

LIGO's First Science Run (S1)

- August 23 - September 9, 2002 (~400 hours)
- Three LIGO interferometers, plus GEO (Europe) and TAMA (Japan)
- Range for binary neutron star inspiral ~ 40-200 kpc
- Hardware reliability good for this stage in the commissioning
 - Longest locked section for individual interferometer: 21 hrs (11 in “Science mode”)

	LLO-4K	LHO-4K	LHO-2K	3x Coinc.
Duty cycle	42%	58%	73%	24%

S1 Sensitivities

Strain Sensitivities for the LIGO Interferometers for S1

23 August 2002 - 09 September 2002 LIGO-G020461-00-E

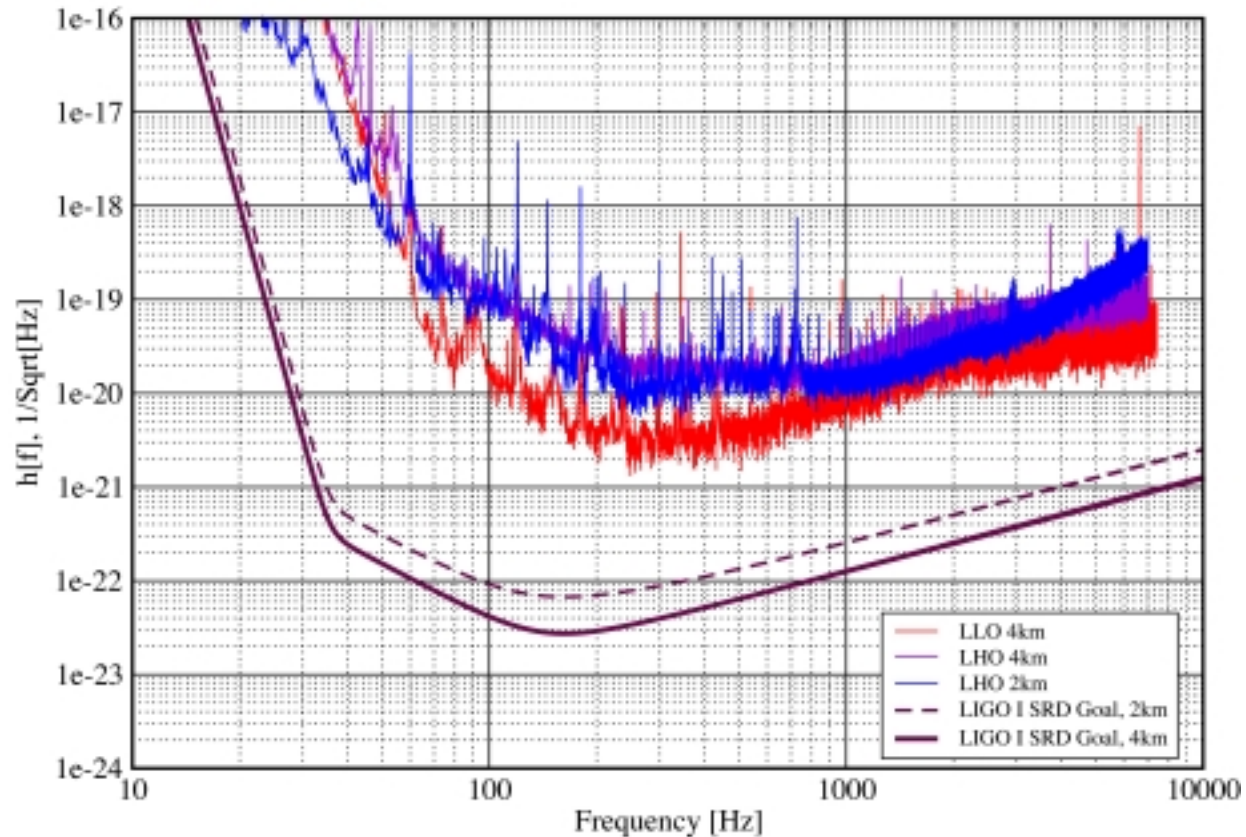

S1 Noise Component Analysis, LLO 4k

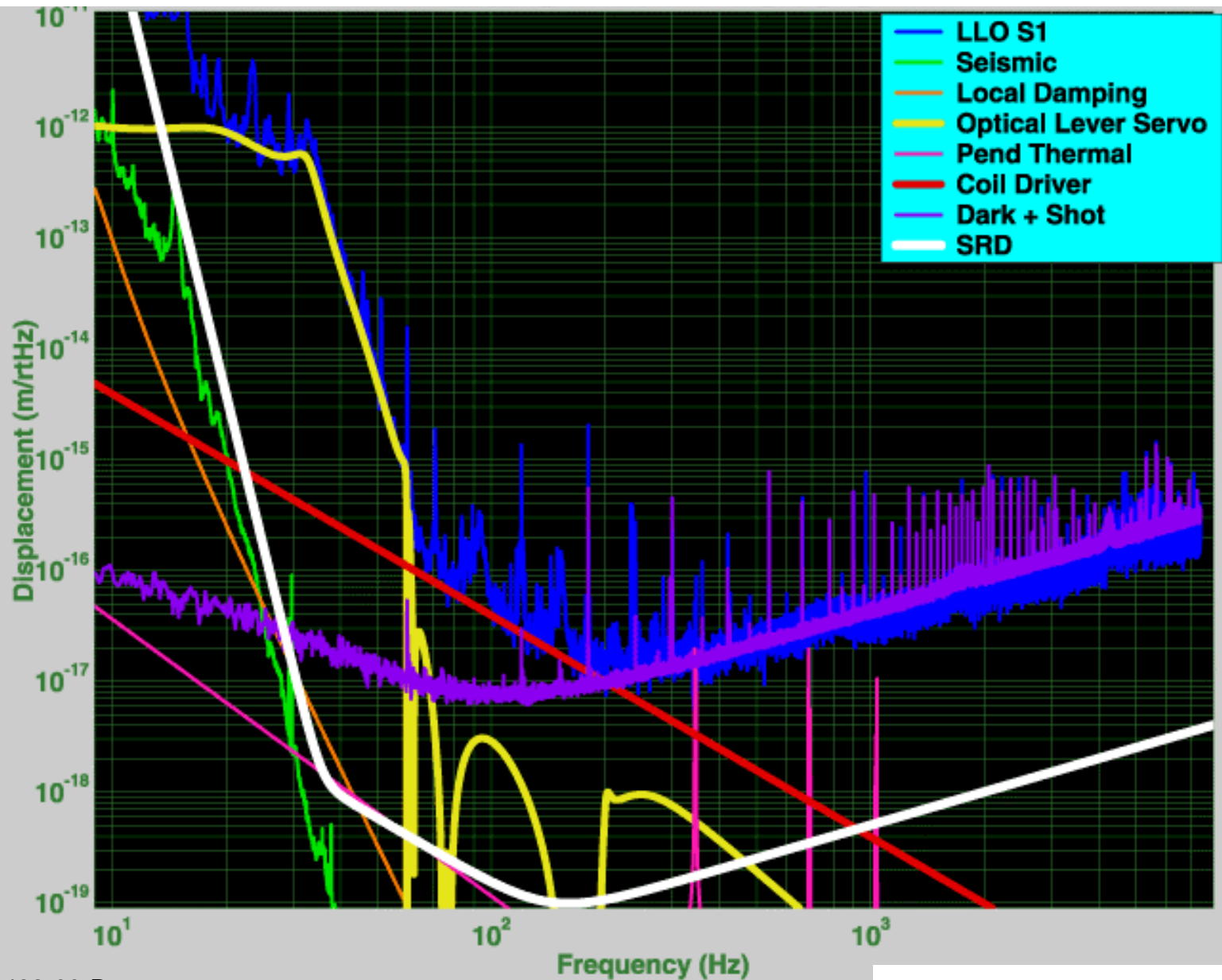

Strain Sensitivity for the LLO 4km Interferometer

31 January 2003

LIGO-G030014-00-E

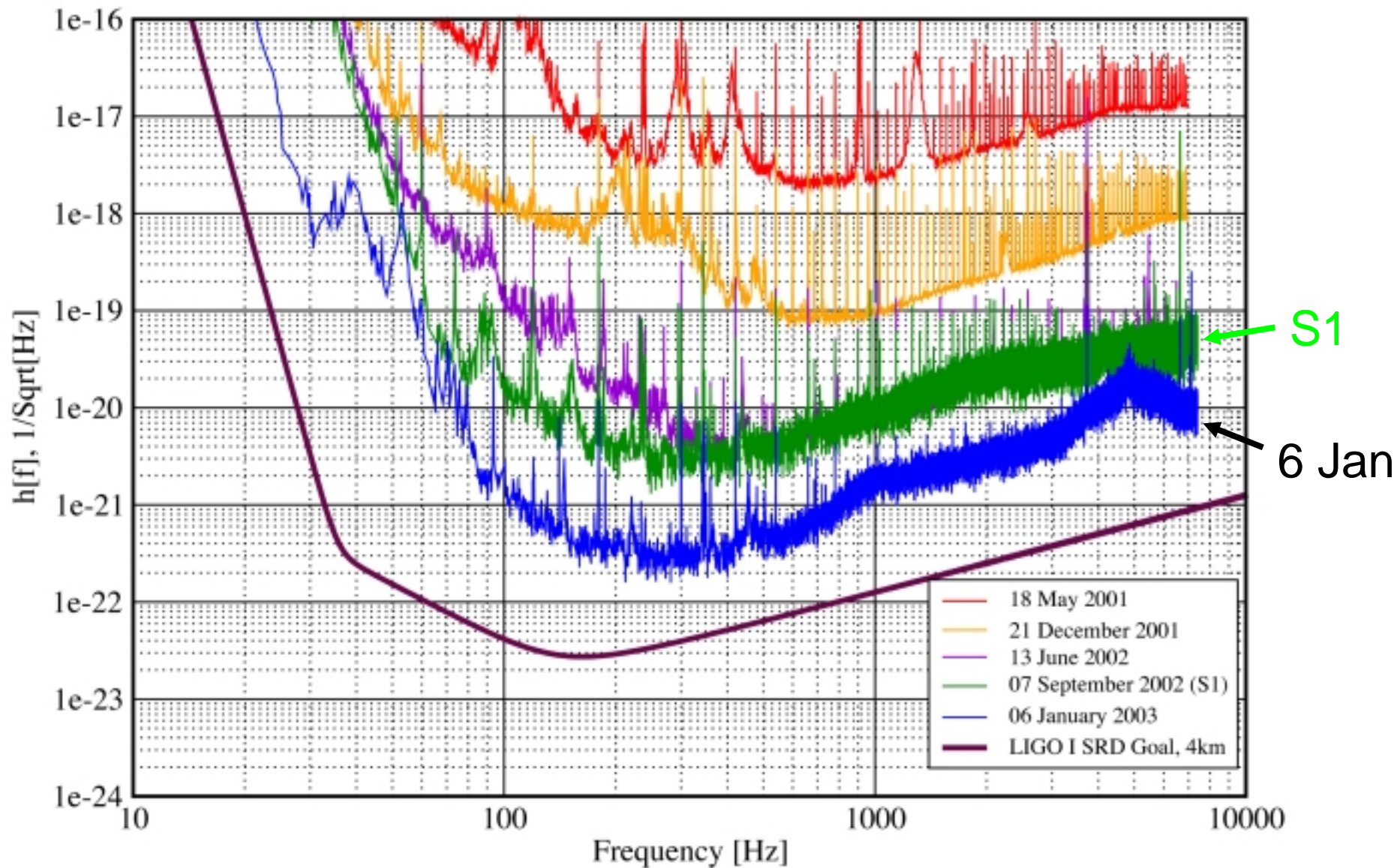

Searching for Astrophysical Gravitational Wave Signals

- **Compact binary inspiral:** *“chirps”*
 - Search technique: matched templates
 - NS-NS waveforms are well described
 - BH-BH need better waveforms
- **Supernovae / GRBs:** *“bursts”*
 - Search for unmodeled bursts
 - Also search in coincidence with signals in electromagnetic radiation
- **Pulsars in our galaxy:** *“periodic signals”*
 - Search for observed neutron stars (vs. frequency, doppler shift)
 - Also, all-sky search (computing challenge)
- **Cosmological Signals** *“stochastic background”*
 - Correlate outputs of multiple interferometers

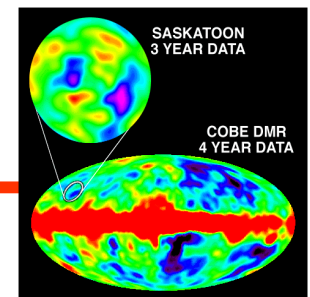
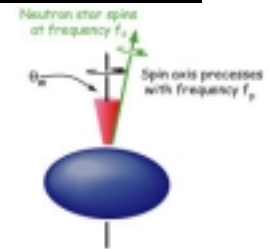
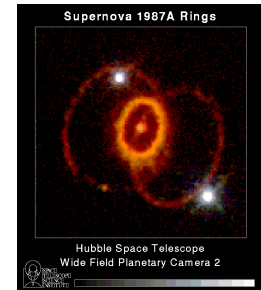
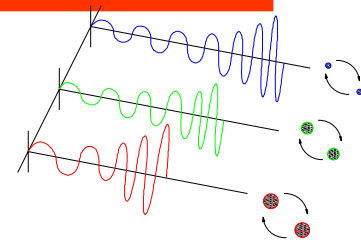

Search for Inspirals

- **Sources:** **Neutron star binaries** known to exist and emit gravitational waves (Hulse&Taylor).
- **Analysis goals:** determine an **upper limit on the rate of binary neutron star inspirals in the universe.**
 - S1 range included Milky Way (our Galaxy) and LMC and SMC
 - S2 range includes Andromeda
 - For setting upper limits, must have (and use!) source distribution model
 - Search for black hole binaries and MACHOs will be pursued in the future
- **Search method:** system can be **modeled**, waveform is calculable:
 - » use optimal **matched filtering**: correlate detector's output with template waveform

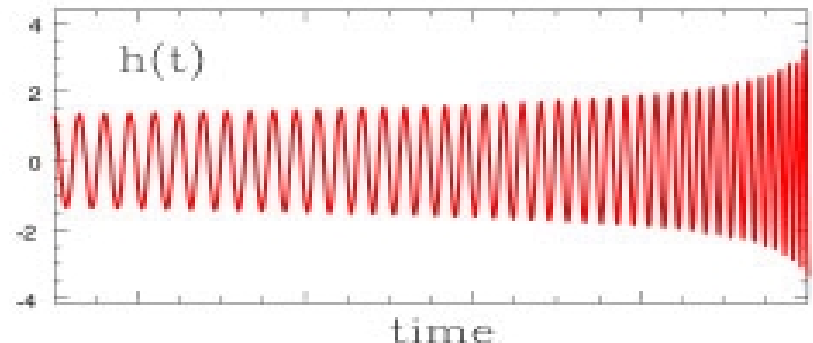

Range for Binary NS

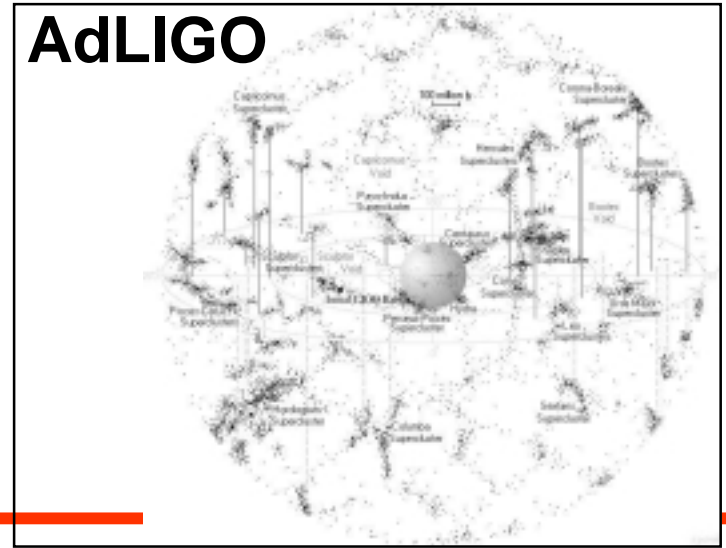
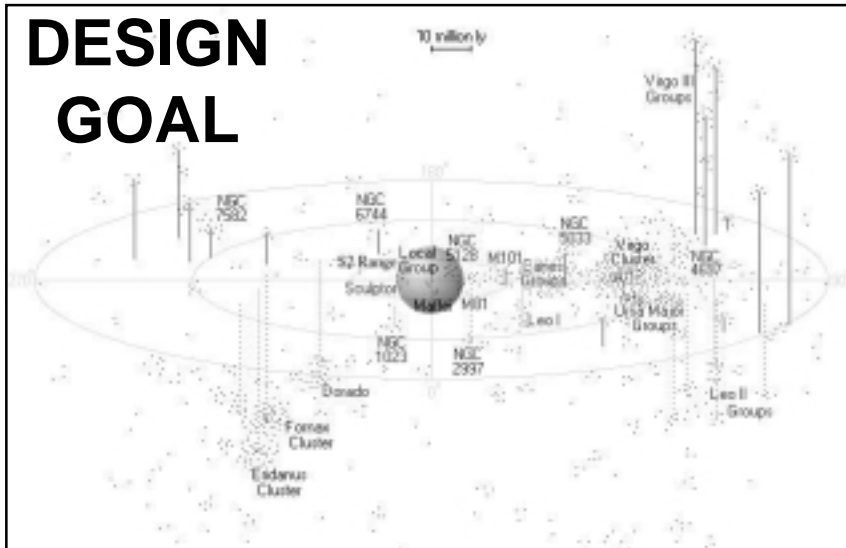
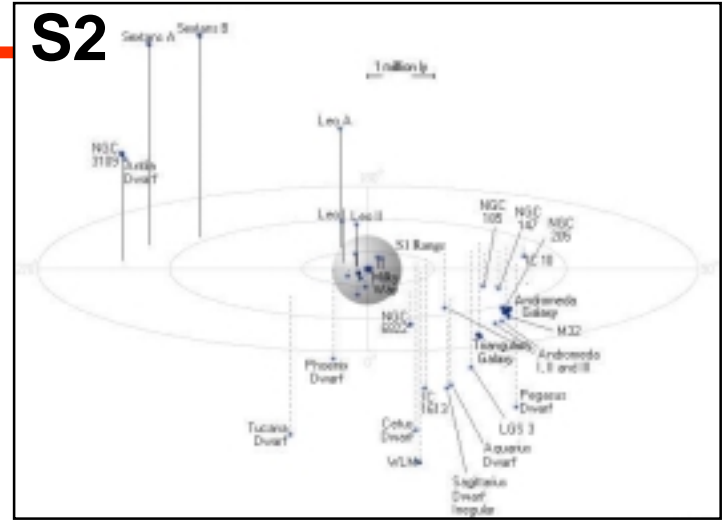
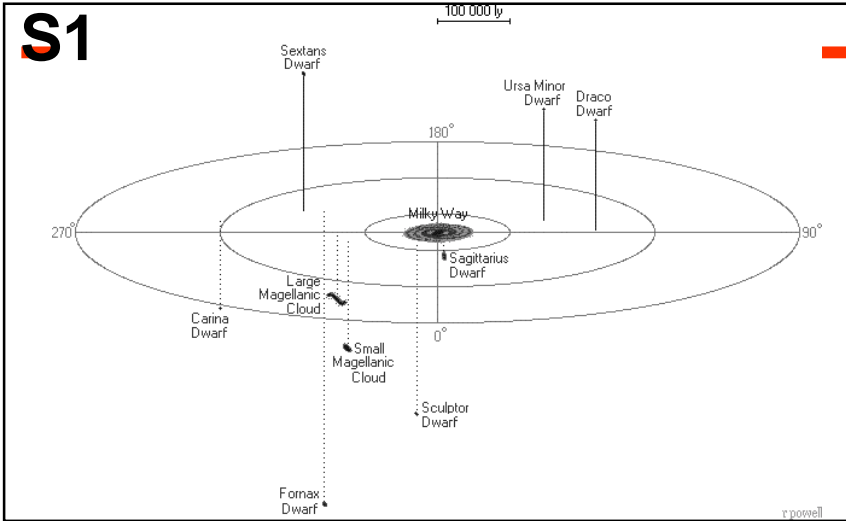

Inspiral Search Result

S1 result:

- No event candidates found in coincidence
- 90% confidence upper limit: **inspiral rate** < **170/year** per Milky Way equivalent galaxy, in the (m_1, m_2) range of 1 to 3 solar masses.

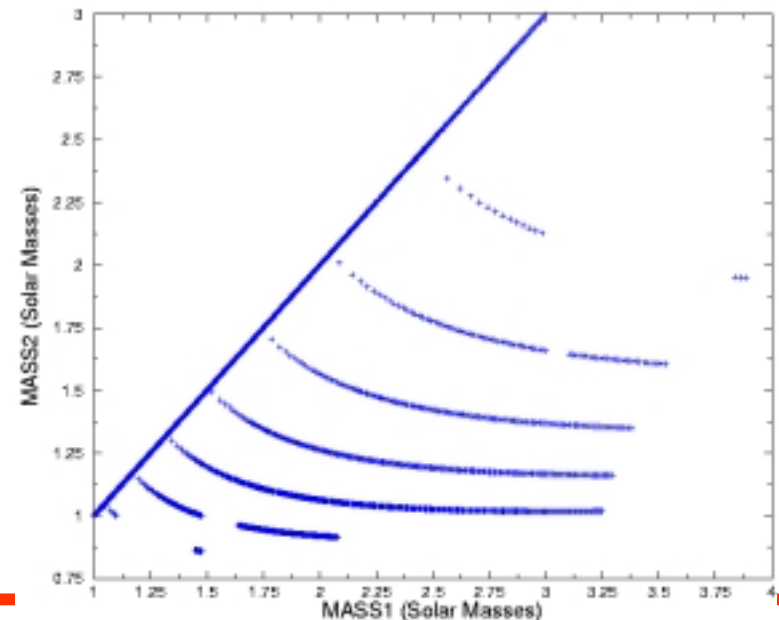
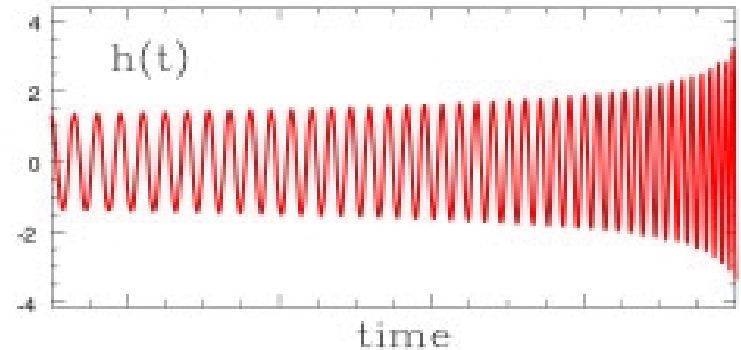

Bursts: A first search without electromagnetic triggers

- **Sources:** phenomena emitting short transients of gravitational radiation of unknown waveform (supernovae, black hole mergers).
- **Analysis goals:**
 - Don't bias search by use of particular signal models.
 - Search in a broad frequency band.
 - Establish bound on rate of instrumental events using triple coincidence techniques.

Bursts

S1 Search methods:

- “**SLOPE**” algorithm (time domain) is an optimal filter for a linear function of time with a $610 \mu\text{sec}$ rise-time.
 - “**TFCLUSTERS**” algorithm identifies regions in the time-frequency plane with excess power (threshold on pixel power and cluster size).
 - Use time-shift analysis to estimate background rates, and Feldman-Cousins to set upper limits or confidence belts
 - Use Monte-Carlo studies to determine detection efficiency as a function of signal strength and model
-

TFCLUSTERS

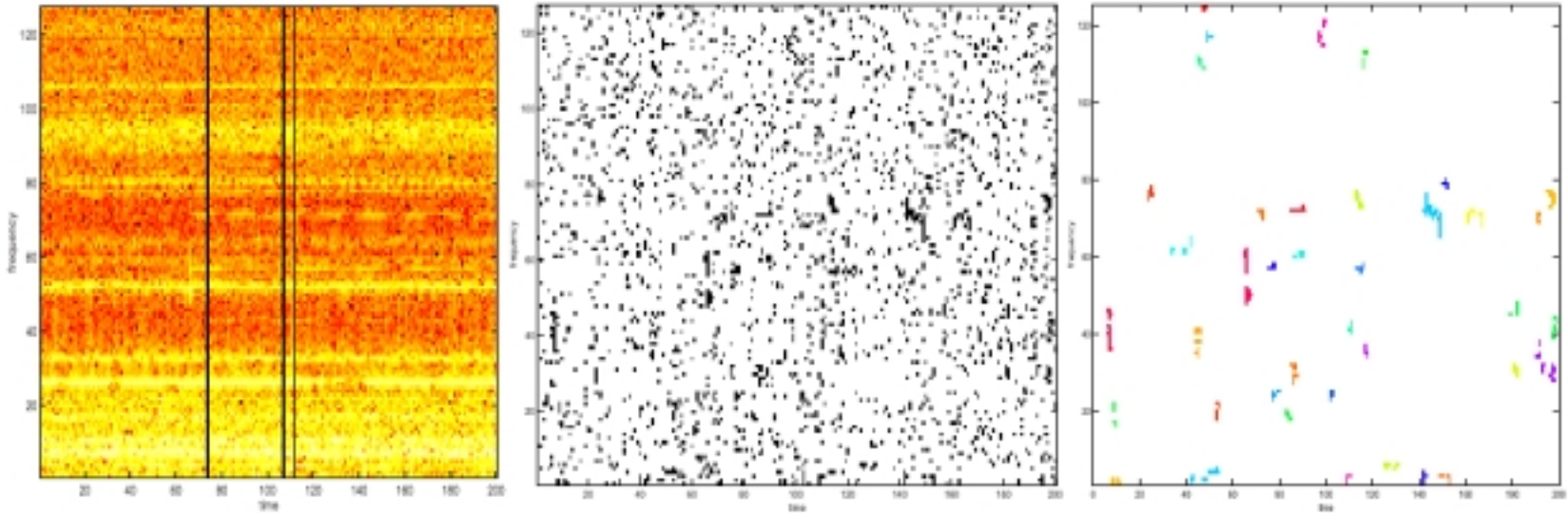

- Compute t-f spectrogram, in 1/8-second bins
- Threshold on power in a pixel; search for clusters of pixels
- Find coincident clusters in outputs of three LIGO interferometers