

Investigation of electric charges on fused silica test mass

V.Mitrofanov, L.Prokhorov, K.Tokmakov

Moscow State University

P.Willems

LIGO Project, California Institute of Technology

LIGO Scientific Collaboration Meeting

Livingstone, Louisiana

March 17-20, 2003

LIGO-G030050-00-Z

Variation of electric charge δq sitting on the mirror in presence other bodies near mirror can be a potential source of excess noise

$$\delta F \sim q \times \delta q.$$

Experimental setup

Vacuum $p < 10^{-7}$ Torr

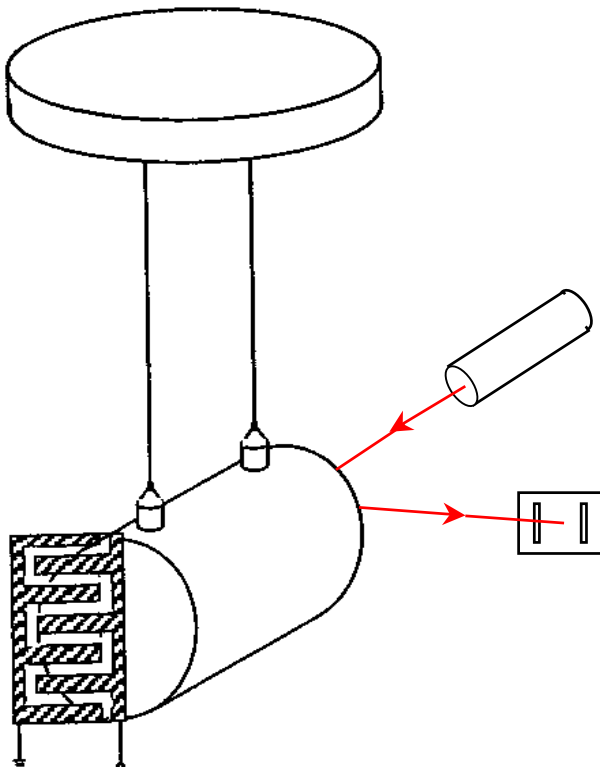

All fused silica bifilar pendulum:

Mass $M = 0.5$ kg,

Torsion mode $f \approx 1.14$ Hz,

Quality factor $Q \approx 8 \times 10^7$

Relaxation time $\tau^* \approx 2.2 \times 10^7$ sec,

Amplitude $A \approx 0.07$ rad

Multistrip capacitive probe
connected to high impedance
amplifier to measure electric charge

$$U = kqA$$

Long-term measurements of U (sampling time 10^{-3} sec,
averaging time 70 sec).

Each run ~ 30 days.

Time dependence of electric charge on the test mass and its amplitude

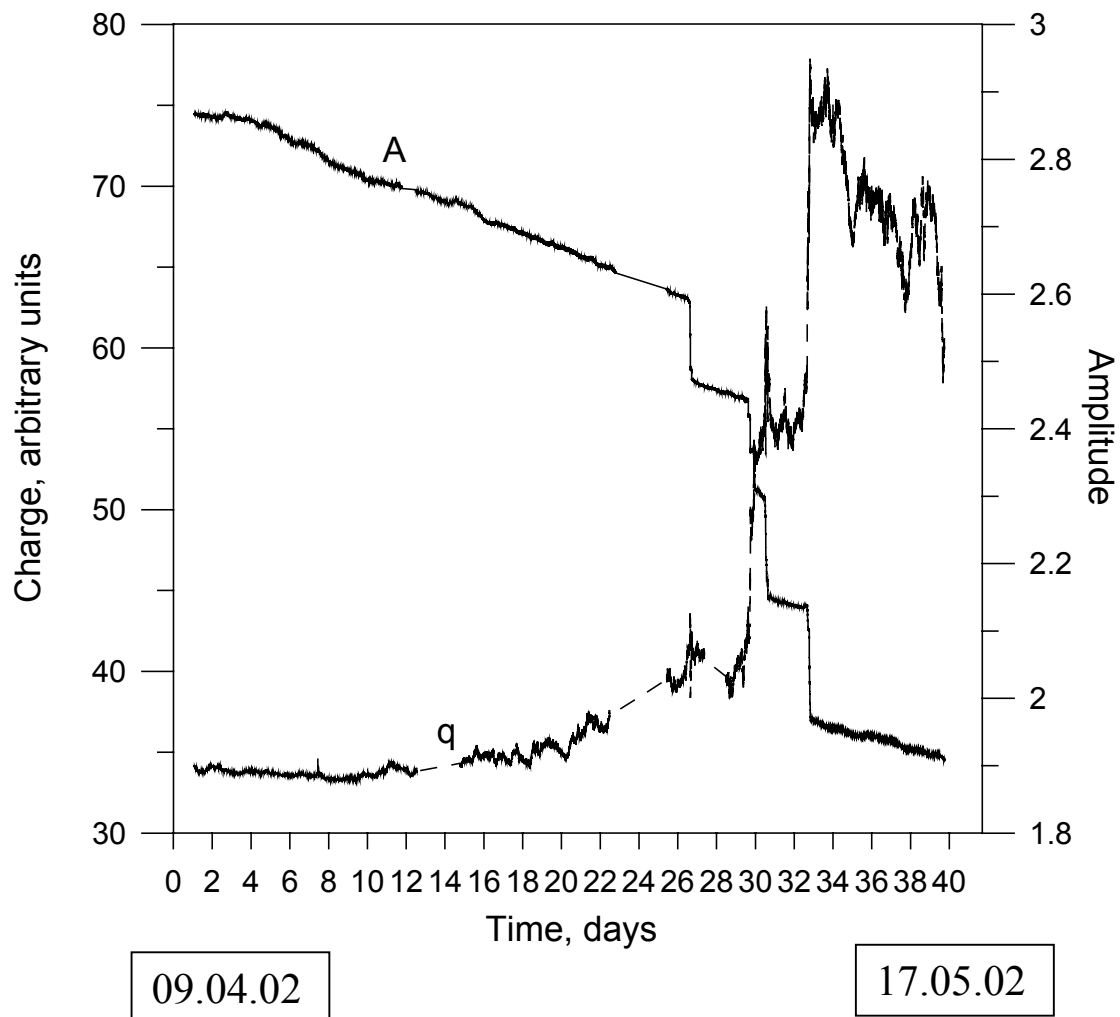

- More than 1 year of observation – about 10 runs of measurement.
- Continuous rise of charge if the initial charge density is not too high
 $\sigma \sim 10^5 \text{ e/cm}^2$
- 3 large jumps of charge up to $\sim 10^8 \text{ e/cm}^2$
 - jumps consisted of several charge step changes
 - jumps were correlated with changes of oscillation amplitude of the cylinder.

Possible charging of dielectric caused by cosmic rays

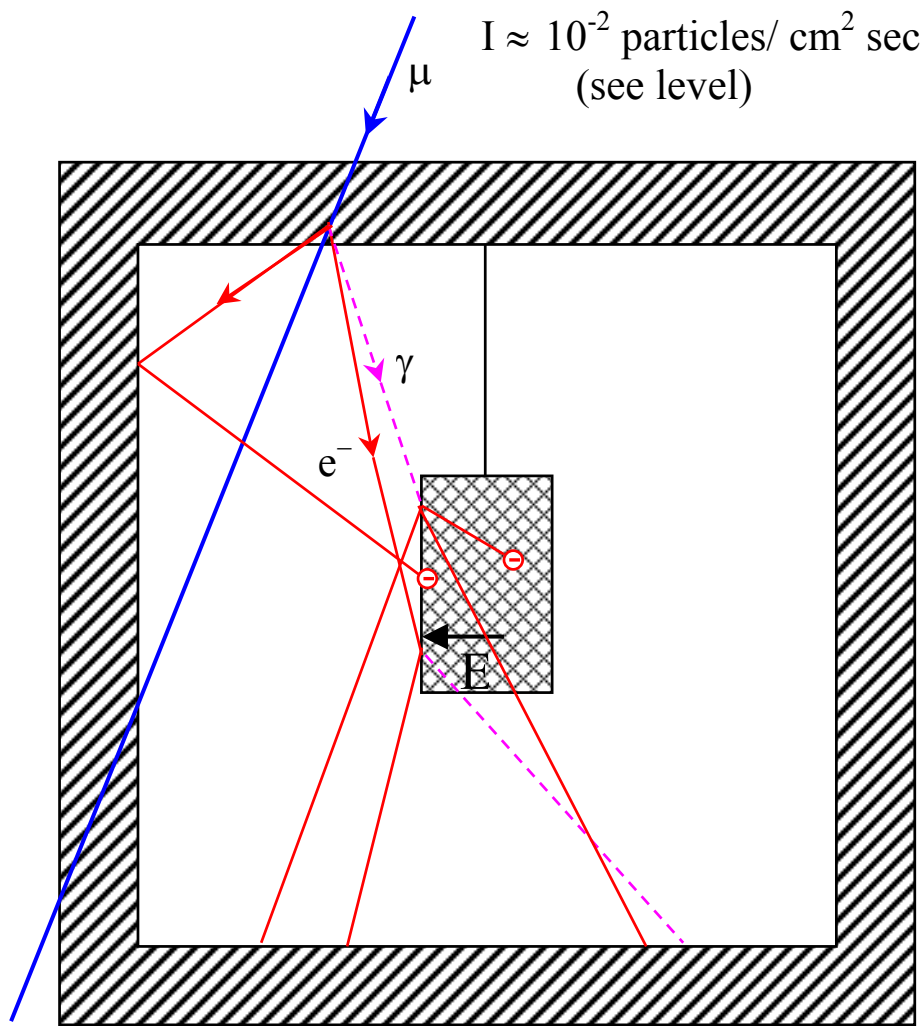

- A piece of dielectric suspended in high vacuum is well isolated electrically and can store charges.
- High energy particles of cosmic rays (muons) passing through the walls of the building and vacuum chamber create electron-photon showers.
- Irradiation of dielectric by electrons and photons leads to the build up of a long lasting space charge and internal electric field due to electron and hole trapping.
- High energy particles can create electron-photon avalanches in the internal electric field of dielectric and emission of electron from the surface.

Main problem: relatively small number of particles.

Cosmic ray detector system

11 particle detectors (plastic scintillator paddles $180 \times 18 \times 0.8 \text{ cm}^3$) supplied by photomultipliers were installed around the vacuum chamber with the pendulum.

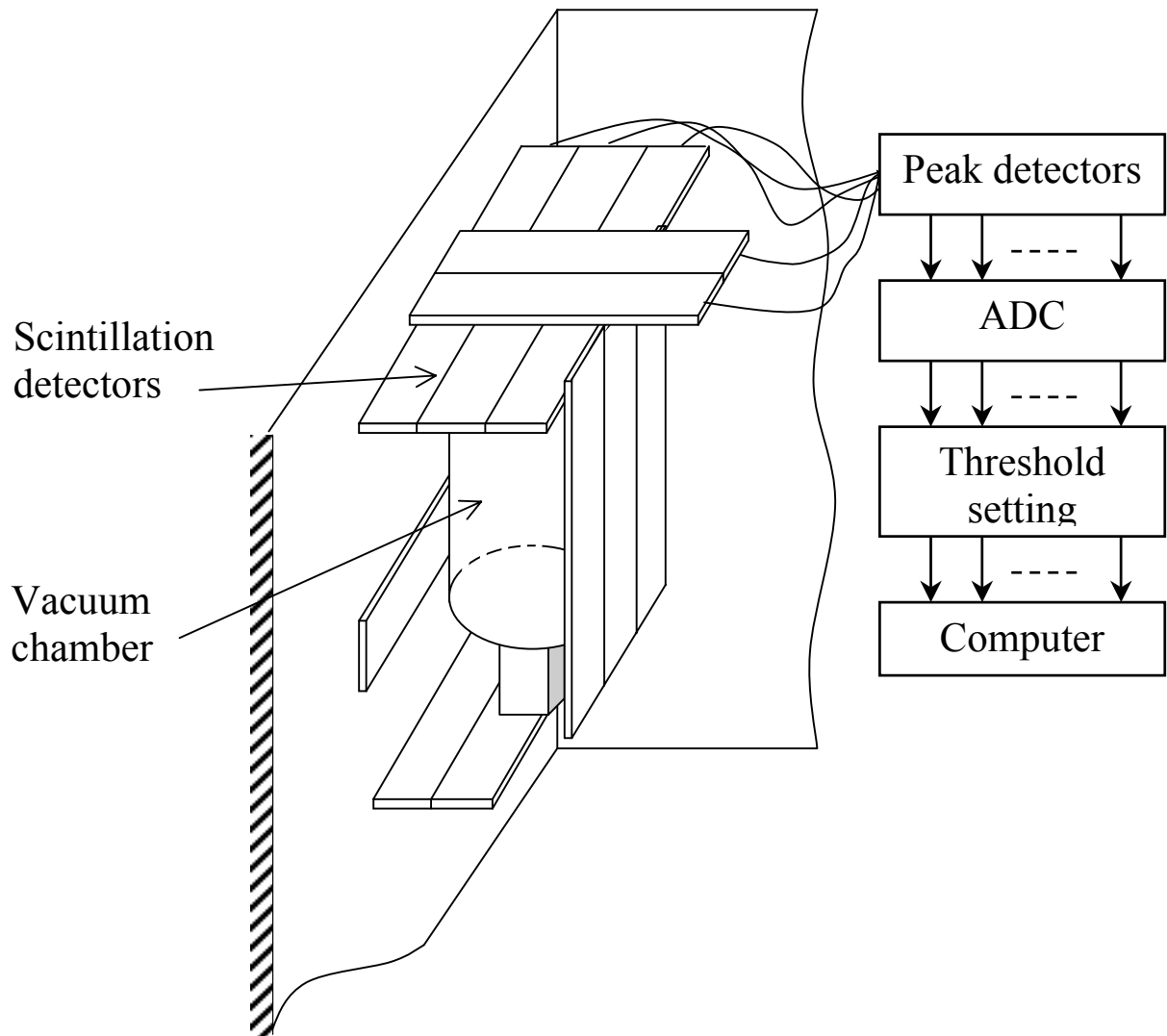

Output voltage is proportional to the number of particles and their energy loss in scintillator.

Selection of events with maximum summarized voltage from all paddles.

Example of distribution of output voltage from scintillation detectors

Time of measurement – 20 hours.

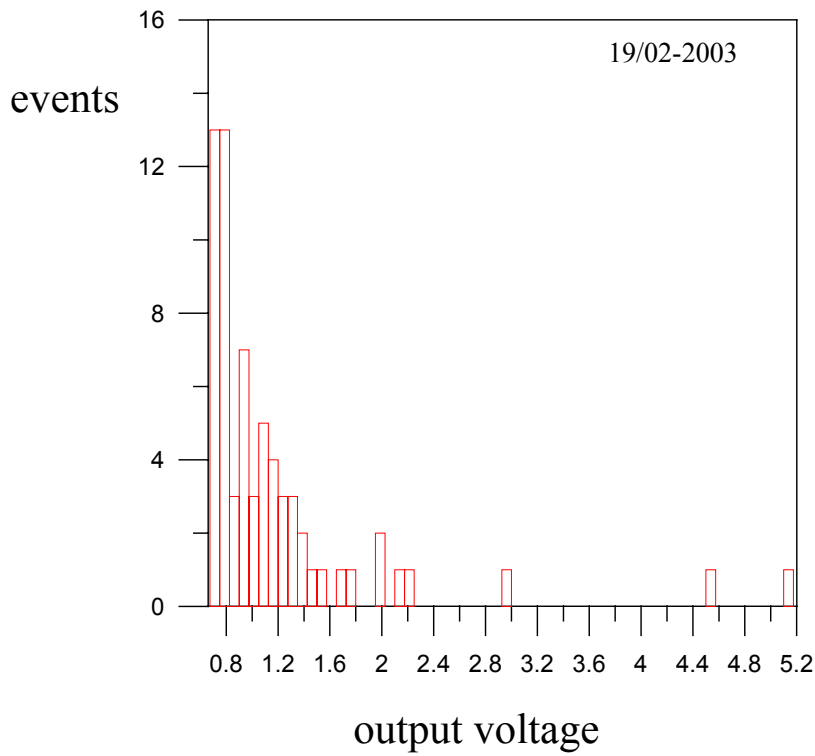

Single paddle

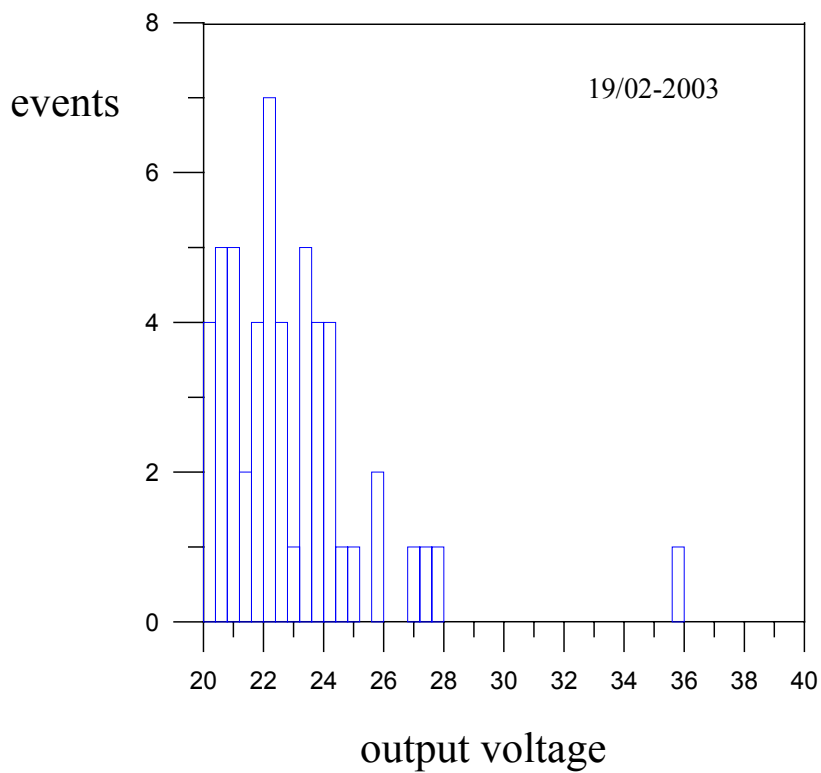

*Summarized
signal from all
paddles*

Relative variation of voltage amplitude from the capacitive probe for different voltage amplitudes corresponding different charges on the test mass

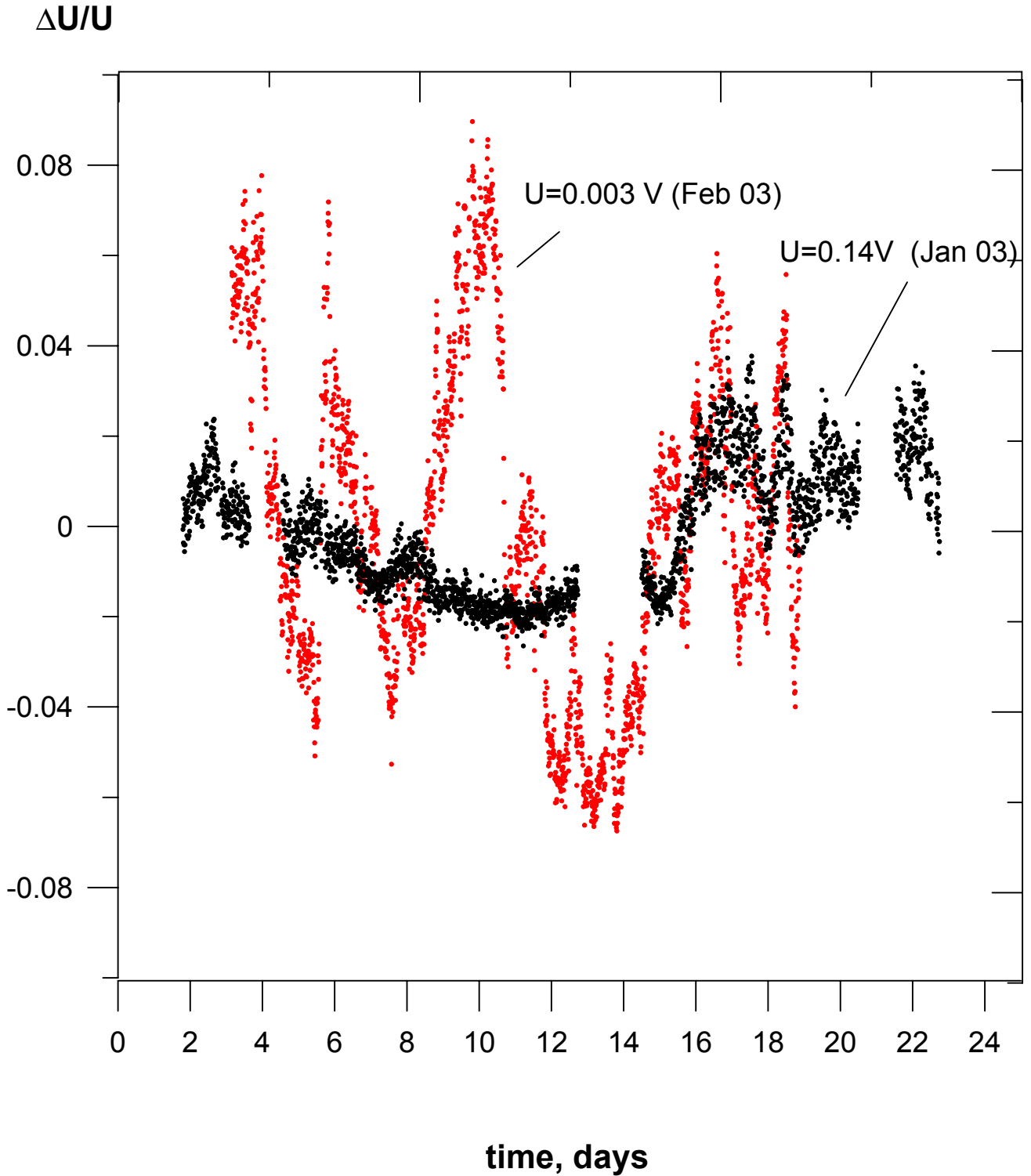

Fragment of record of signals from the probe and scintillation detectors

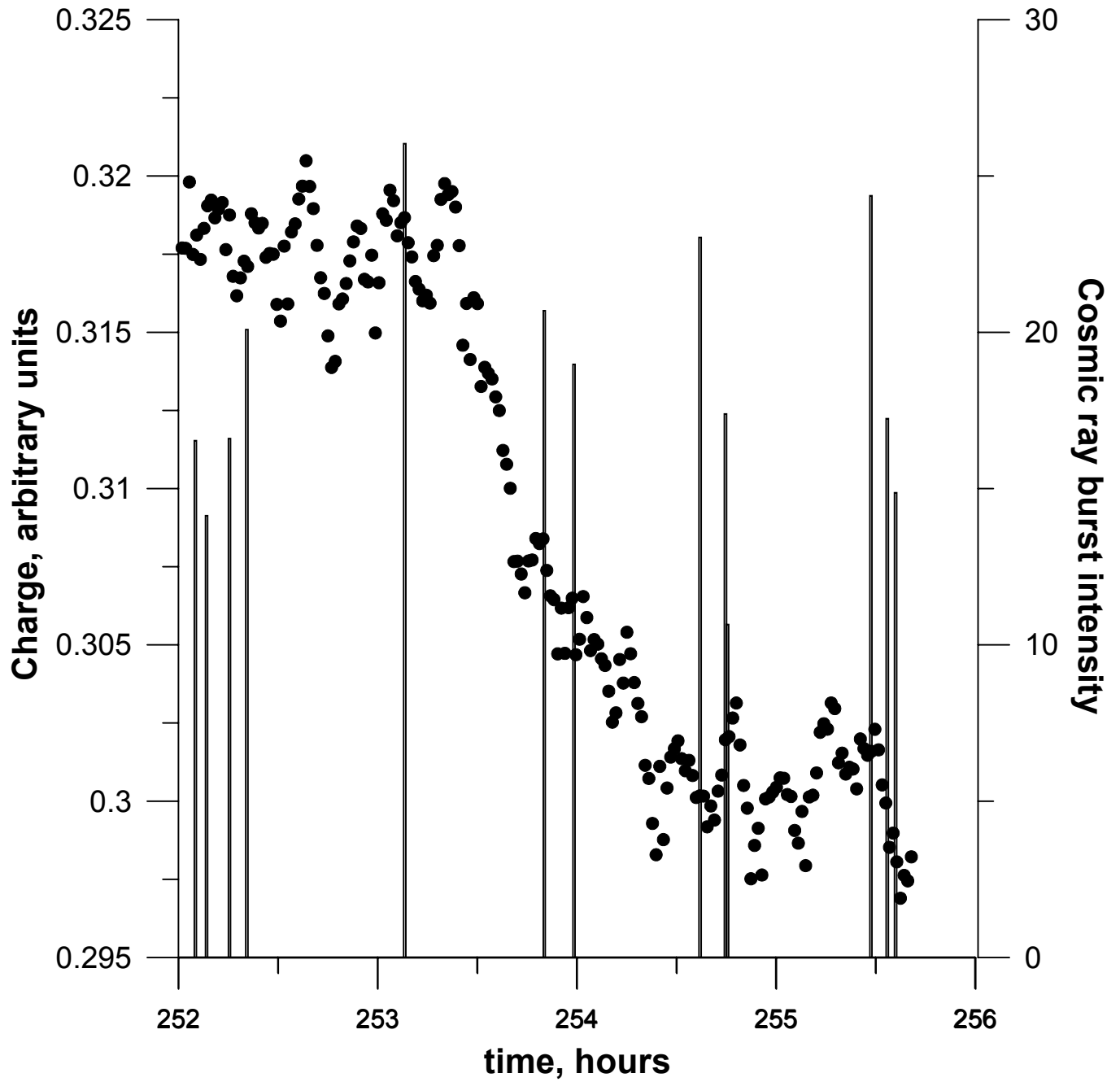

Conclusion

For the time present we have more questions than answers.