

# **SAS / TAMA Collaboration Update**

**Riccardo DeSalvo**

August 16, 2000  
7th LSC Meeting at LHO

LIGO-G000267-00-D

# People

---

---

## University of Tokyo

Prof. Kimio Tsubono

Dr. Masaki Ando

Kenji Numata

Akiteru Takamori

Tatsuo Yoda

## NAO Japan

Prof. Seiji Kawamura

Dr. Ryutaro Takahashi

Mitsuhiro Fukushima

## Caltech

Dr. Riccardo DeSalvo

Dr. Szabolcs Márka

Dr. Virginio Sannibale

Dr. Hiroaki Yamamoto

## University of Pisa

Alessandro Bertolini

Dr. Giancarlo Cella

and supports from other institution

# TAMA SAS Overview

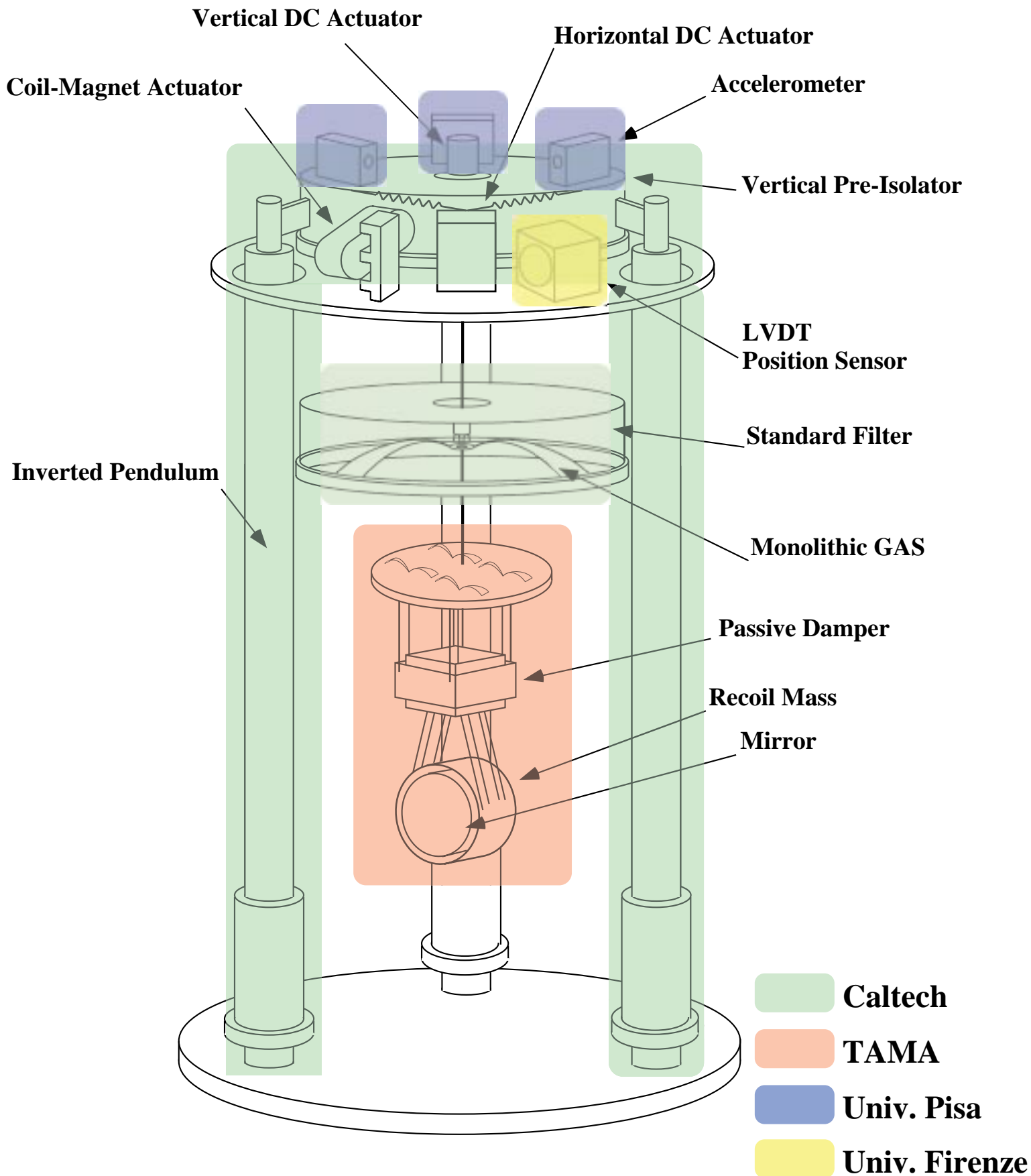

# IP Test Facility

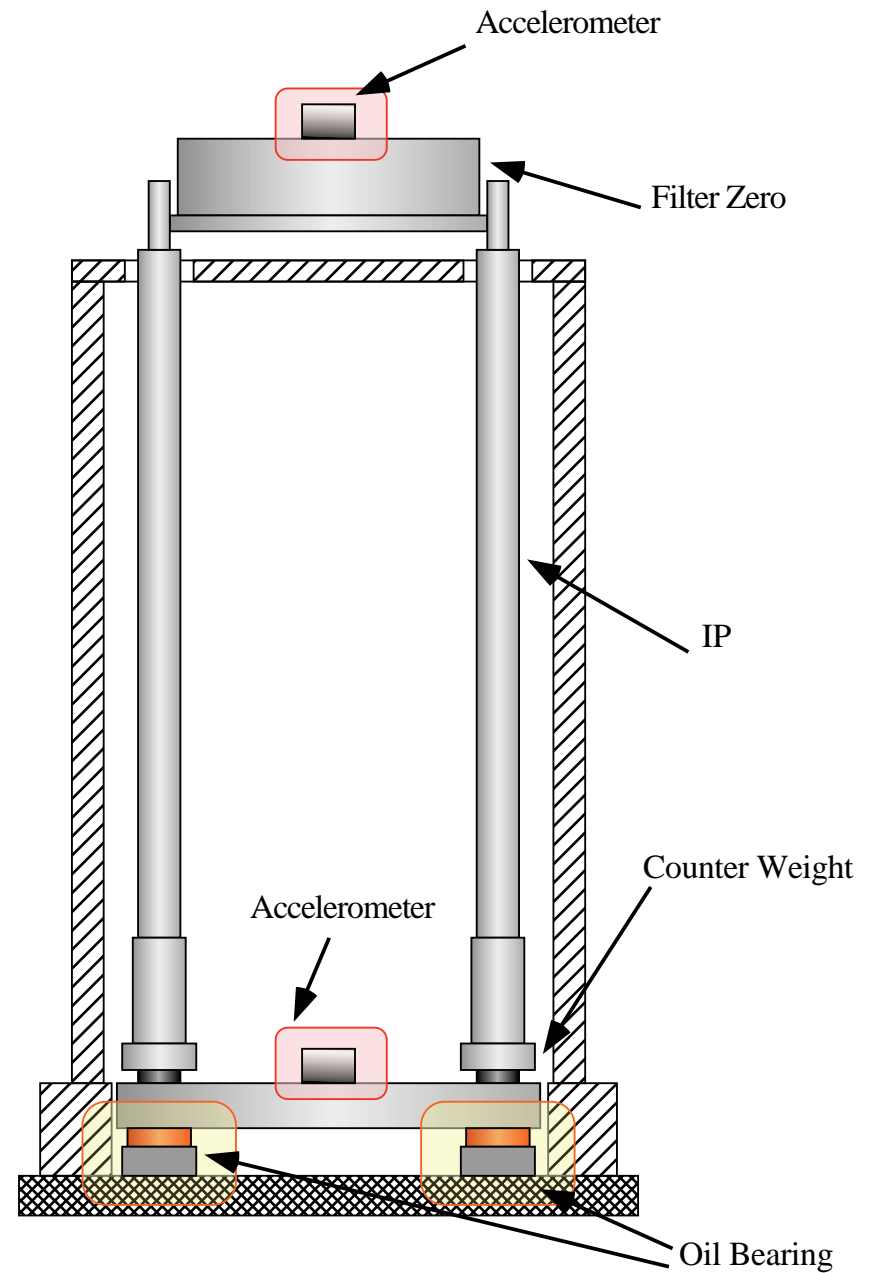

Szabolcs Márka, Riccardo DeSalvo, Hareem Tariq,  
Ryutaro Takahashi, Mitsuhiro Fukushima, Akiteru Takamori

# Horizontal Transfer Function of IP

without Center of Percussion Tuning

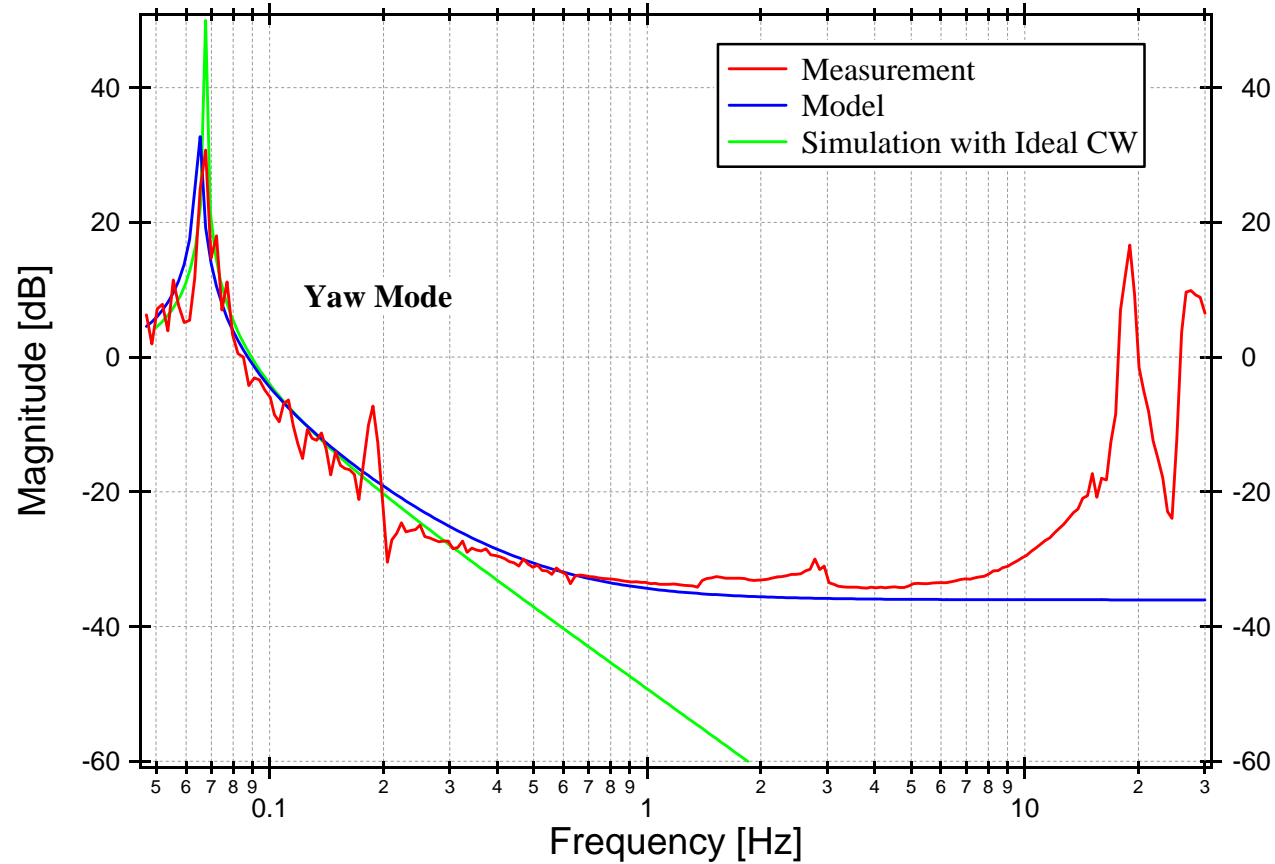

Note: Maximum attenuation is limited by available counter weights.  
Expected improvement with optimized counter weights.

# Vertical Transfer Function of MGASF

## Measurement Setup

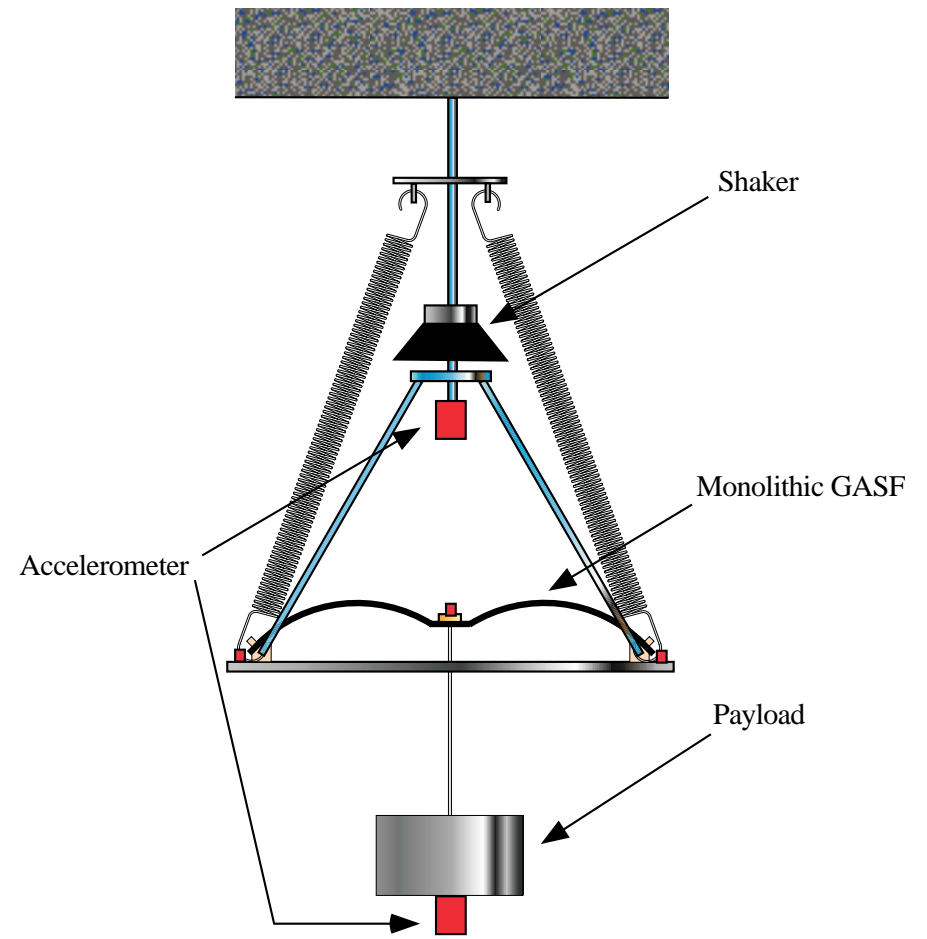
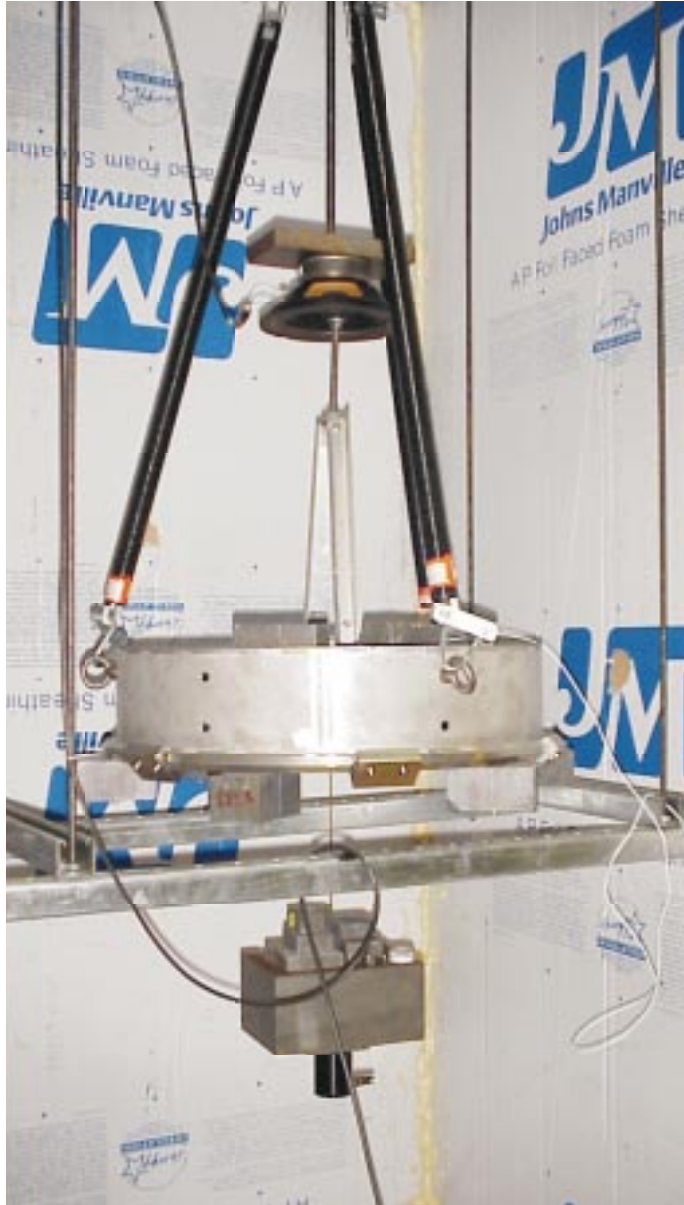



# Monolithic Geometric Anti-Spring (MGAS)

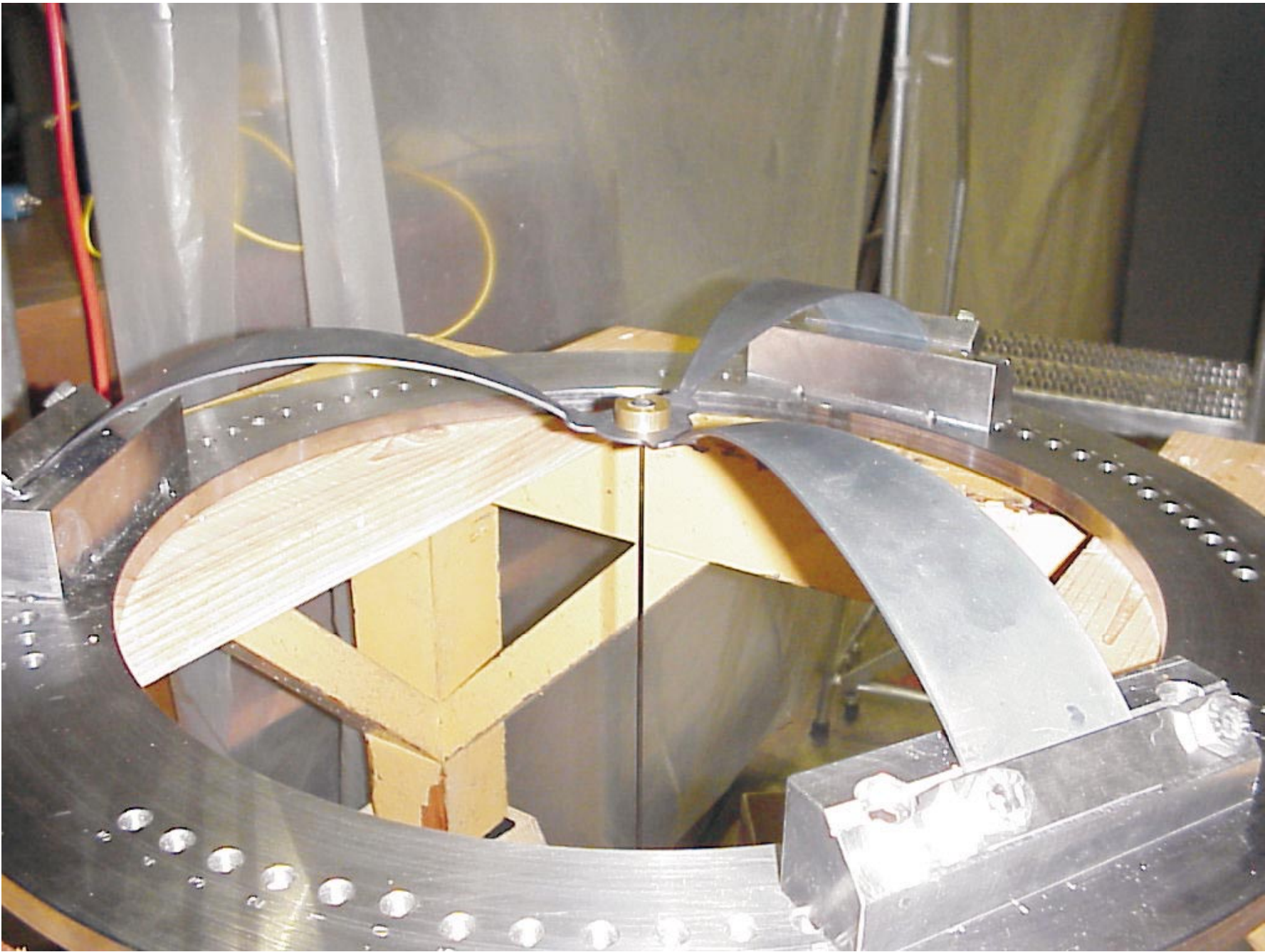

# Vertical Transfer Function of Monolithic GASF

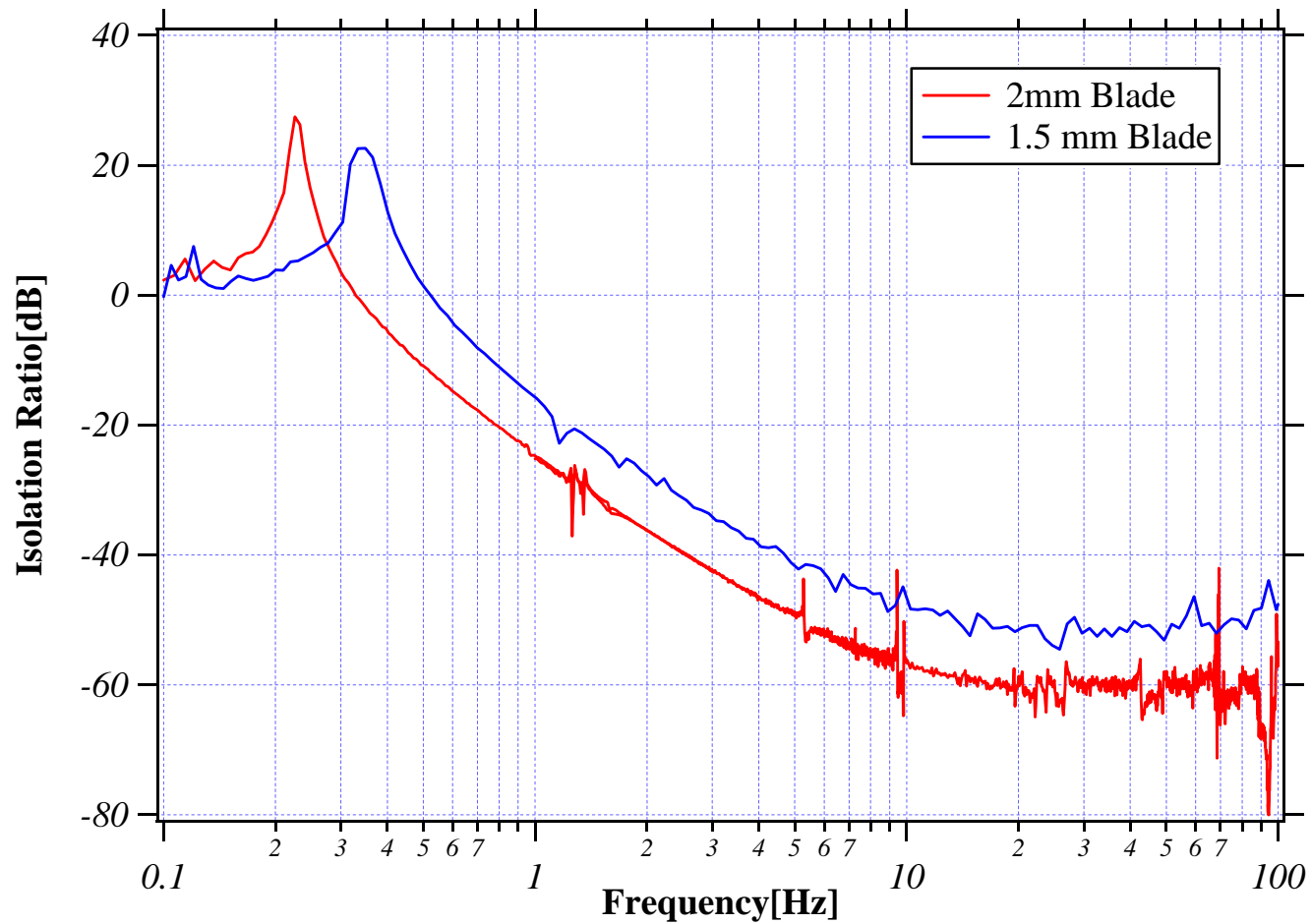

Kenji Numata, James Donald



# TAMA SAS Control Scheme

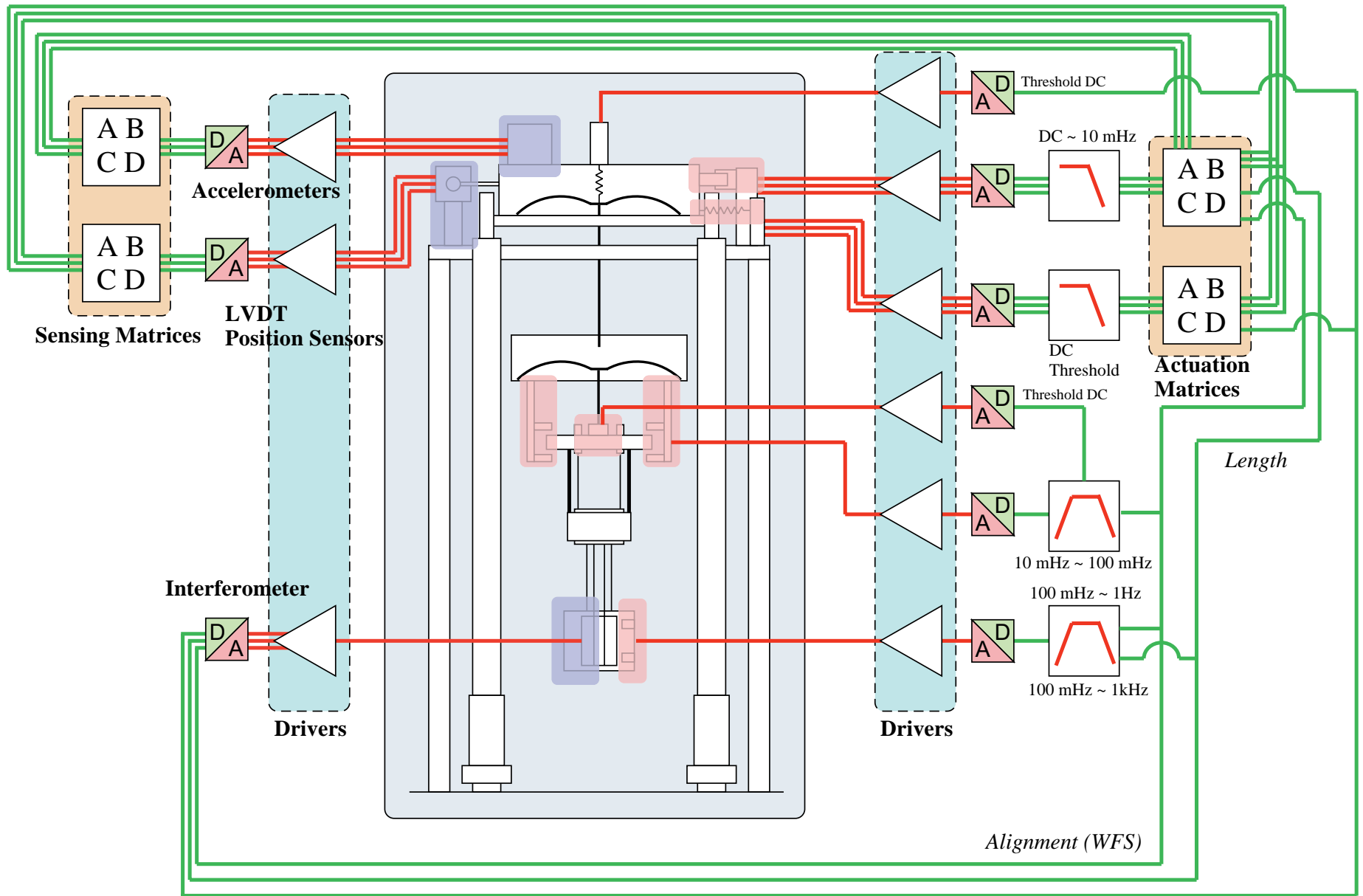

# LVDT Sensors Diagonalization (Direct Transfer Functions)

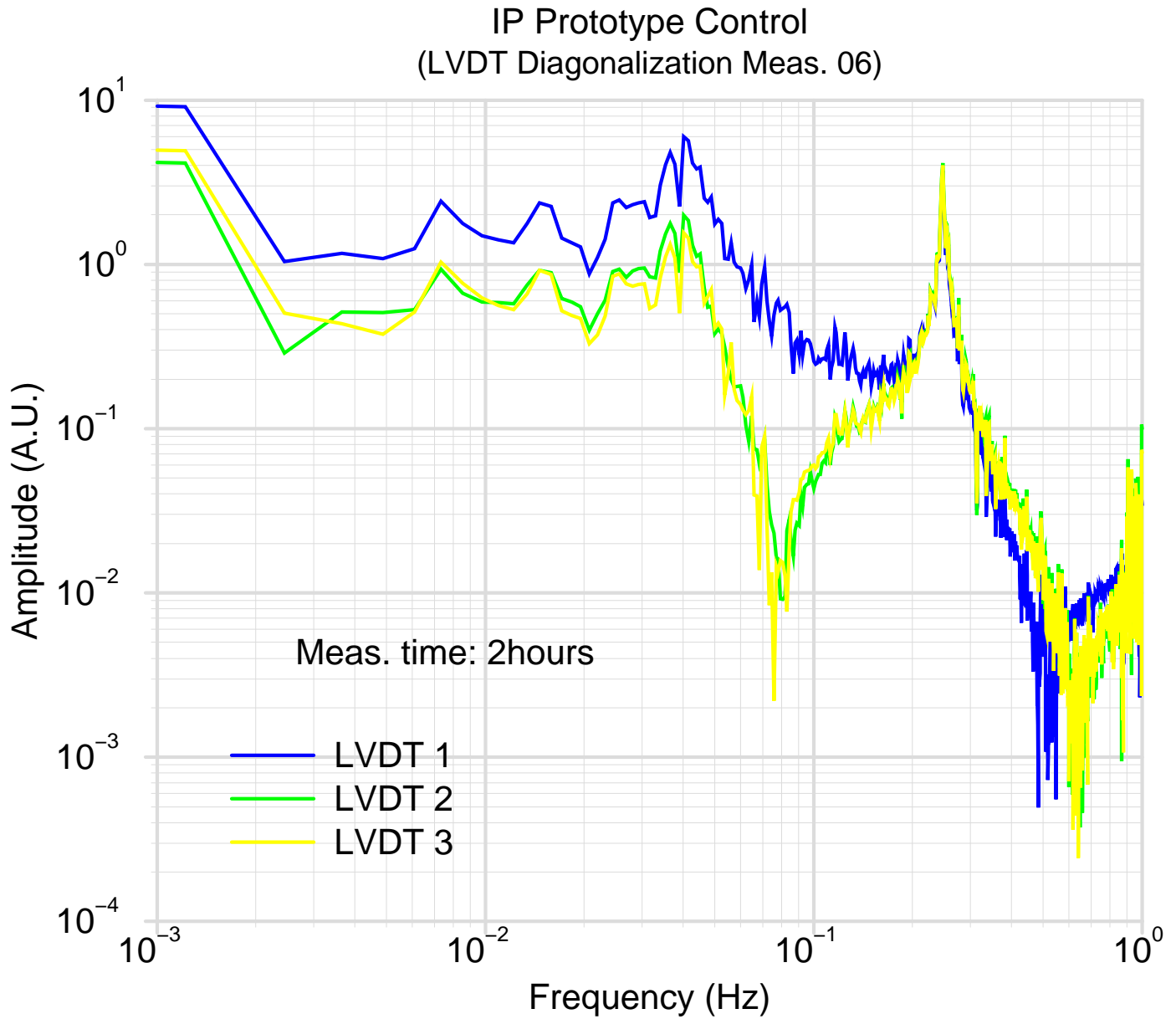

Sun Apr 16 12:26:48 2000

# SAS-SUS LVDT (Diagonalized Transfer Function Degenerate case)

IP Prototype Control  
(LVDT Diagonalization Degen Case Meas 1\_06 2,3\_05)

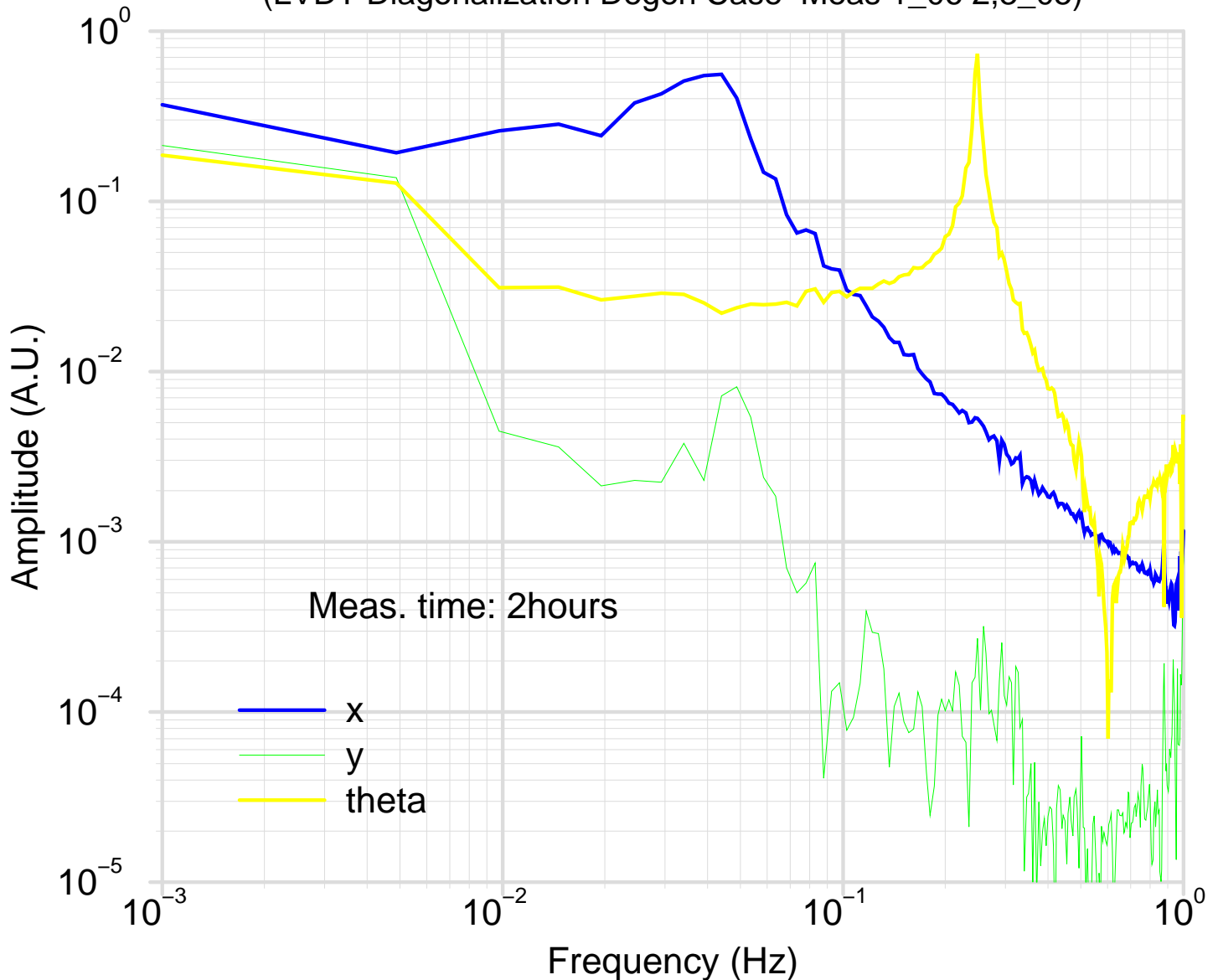

# Normal Mode RingDown (Yaw Mode)

LVTP IP Diagonalization  
(Yaw Mode Ring-Down)

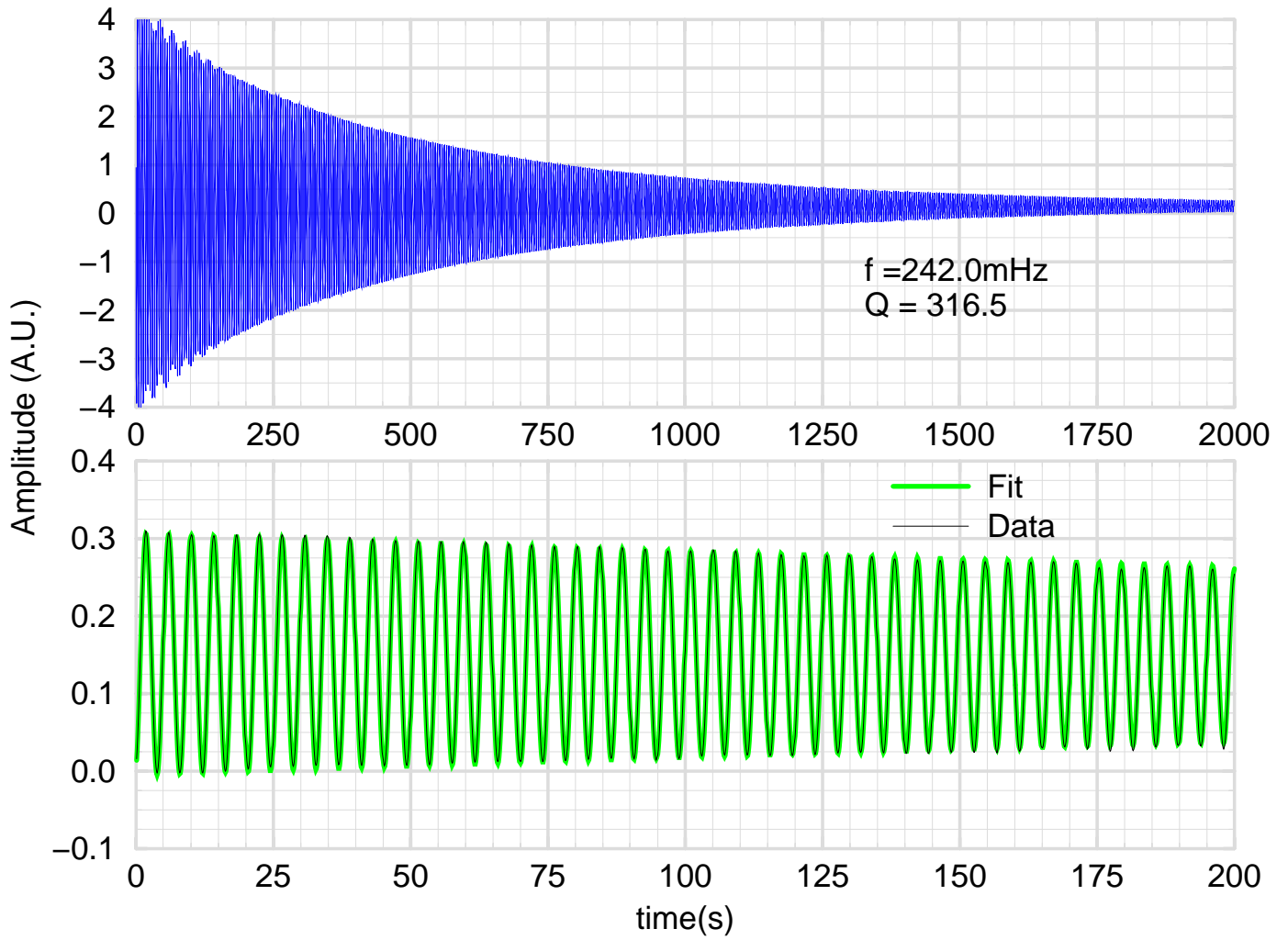

# SAS Control : (Recent Results)

- Position Sensor Diagonalization working
- Actuator Diagonalization Working
- Closed the Loops in the 3 DOF

Example: Residual Seismic Noise Spectral Density DOF :  $y$   
(Very Preliminary Result)

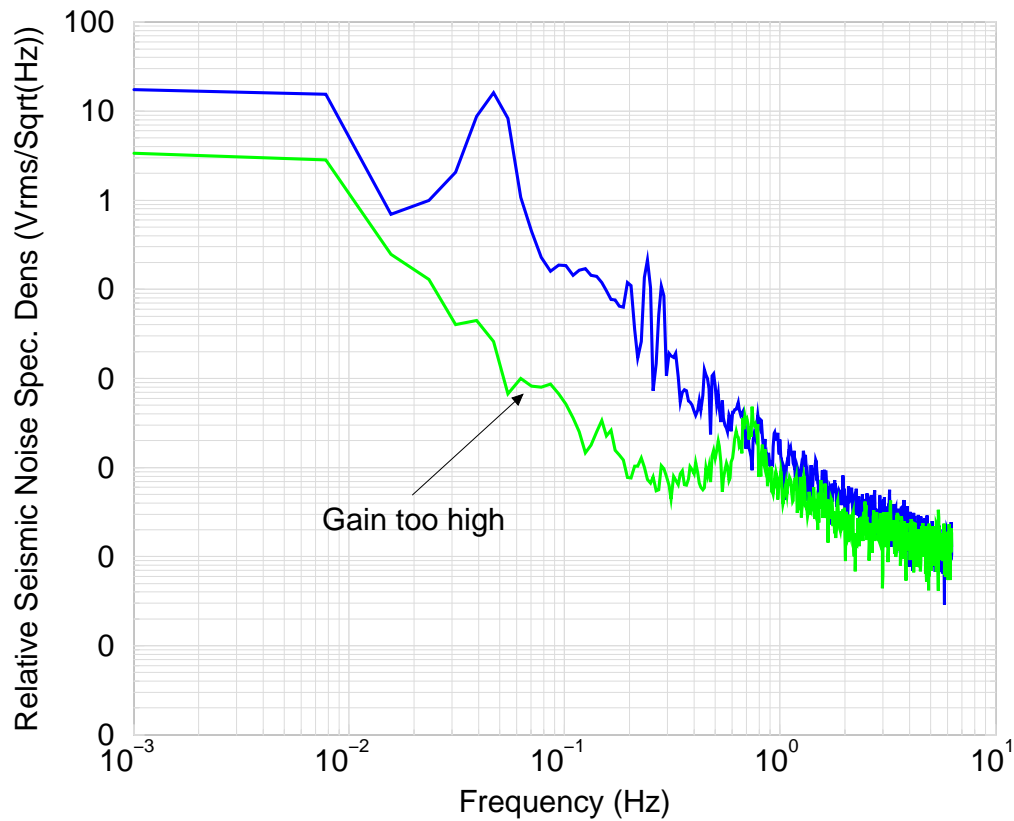



# TAMA SAS

Open loop transfer function for inertial damping

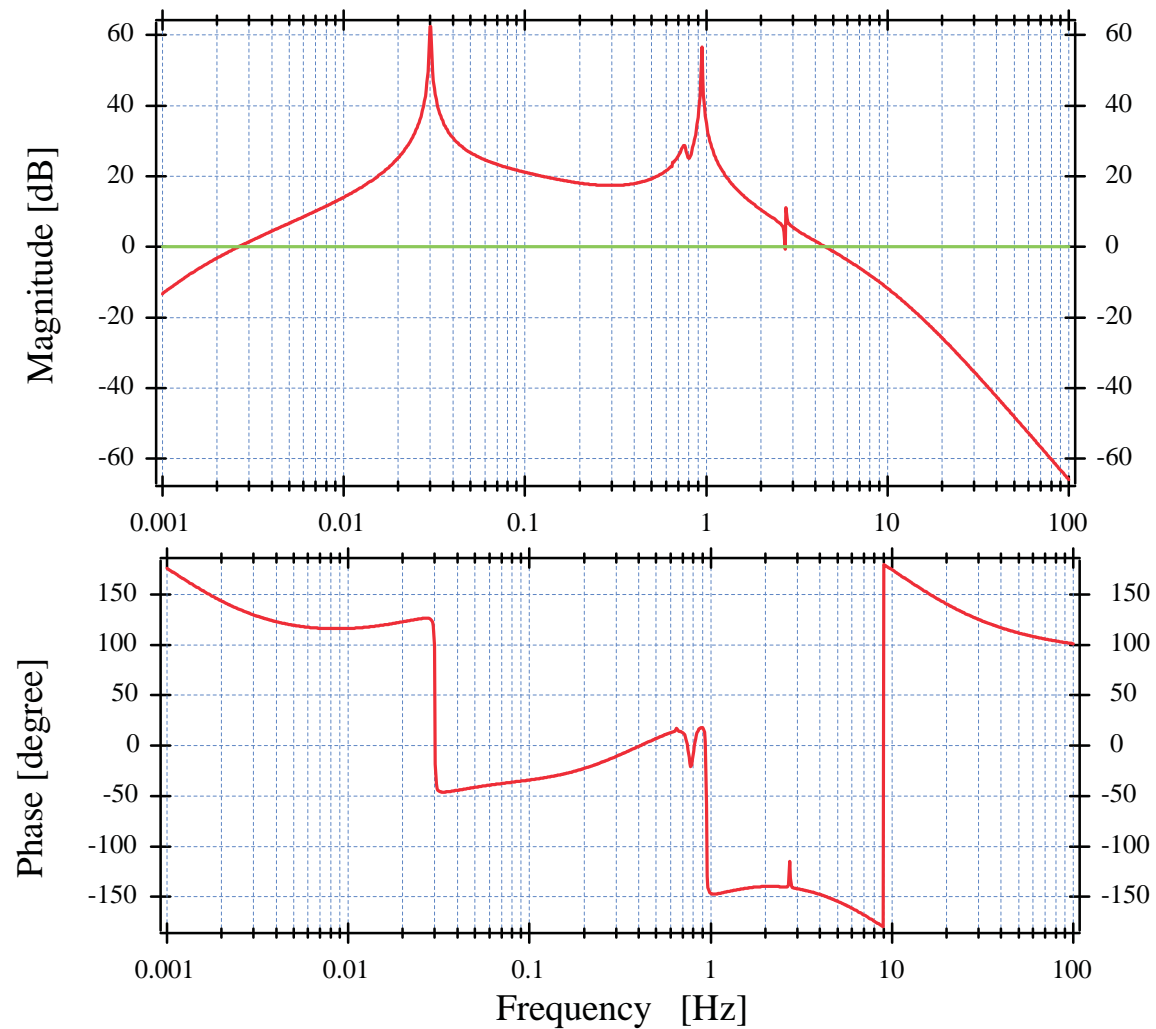

# TAMA SAS

## Horizontal Displacement at IP Stage (Preliminary Simulation)

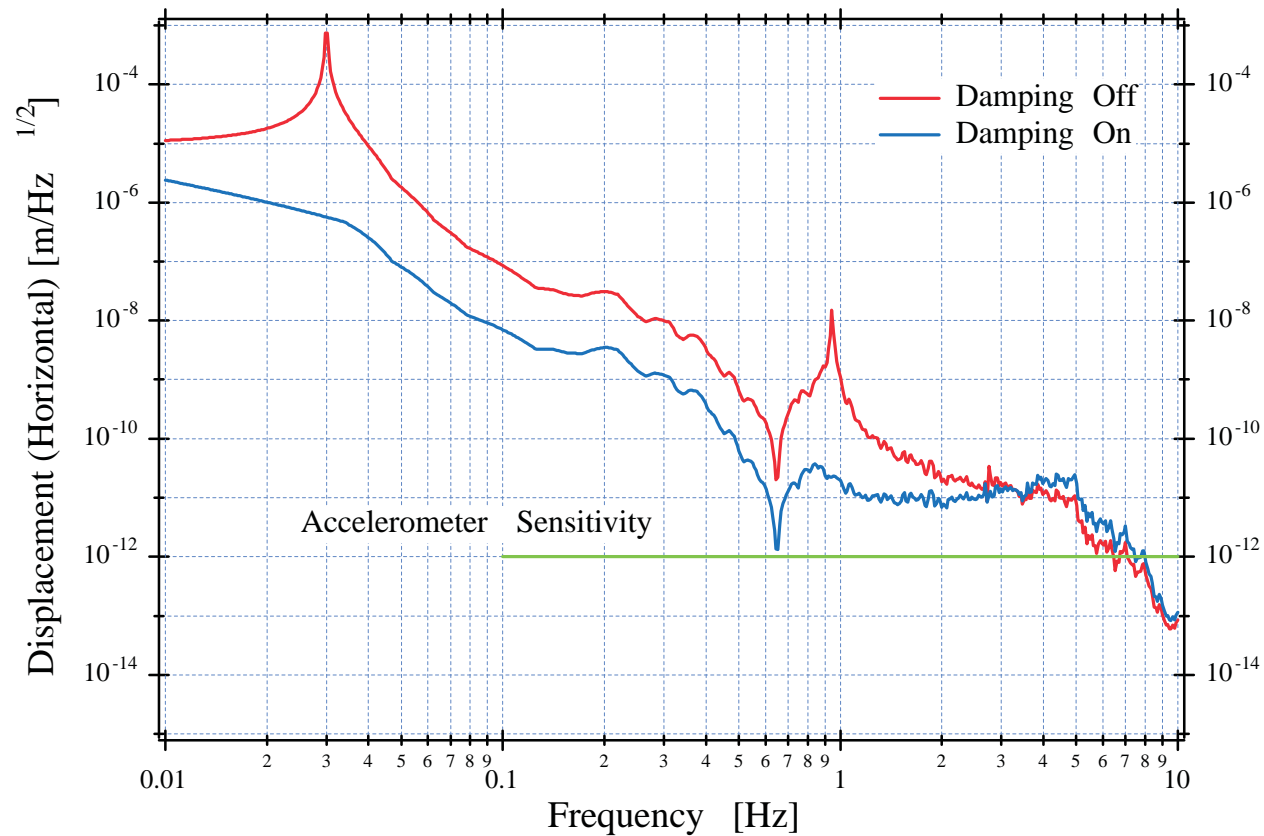

# TAMA SAS

r.m.s. Residual Displacement at IP Stage  
(Preliminary Simulation)

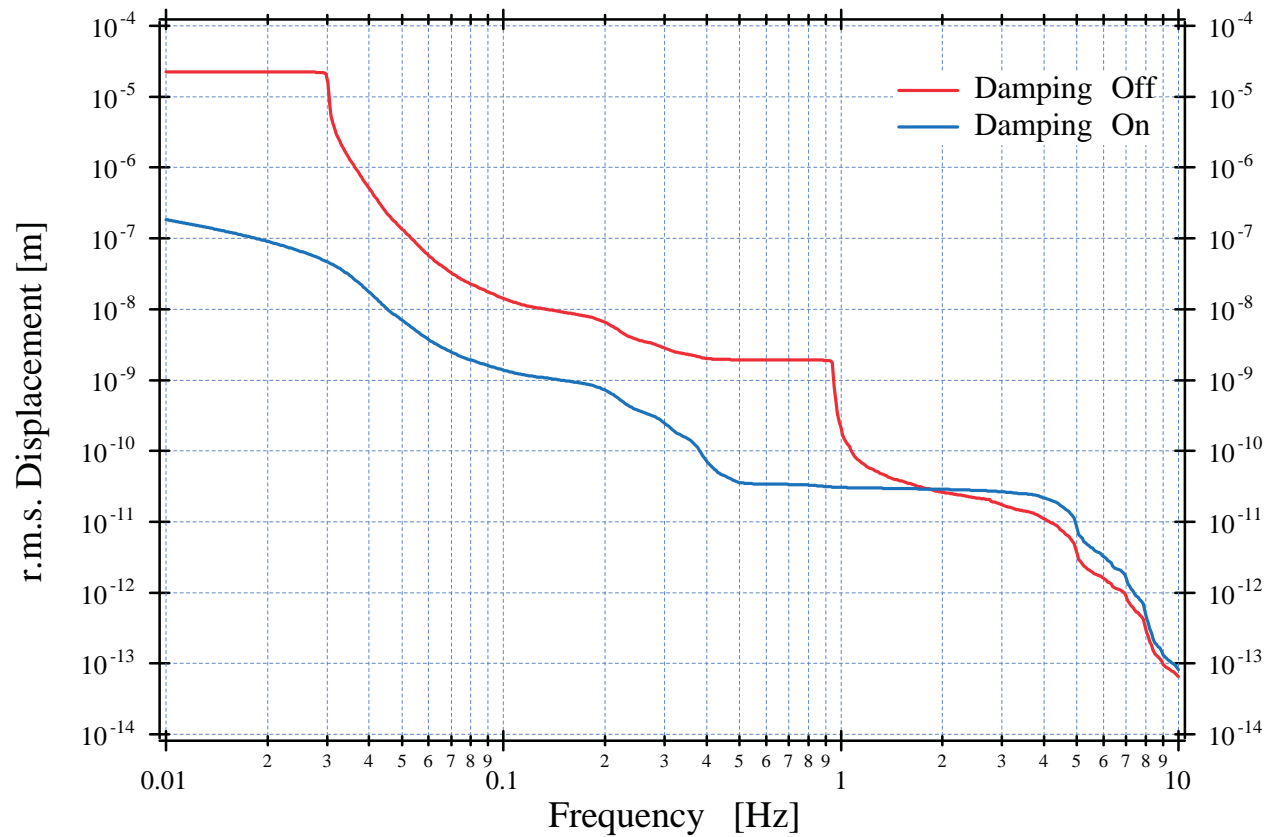

# TAMA SAS

## Horizontal Displacement at Mirror Stage (Preliminary Simulation)

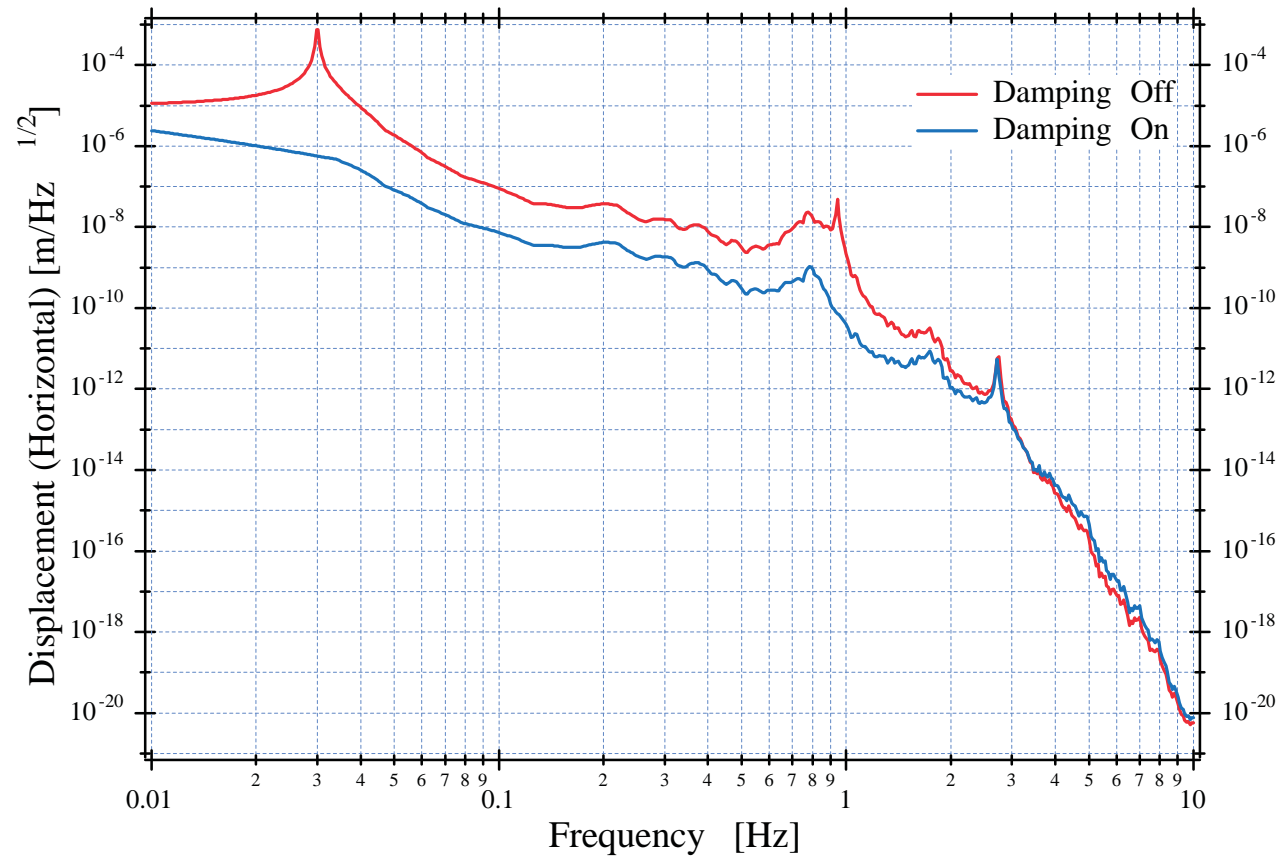

# TAMA SAS

r.m.s. Redidual Displacement at Mirror Stage  
(Preliminary Simulation)

