

CHARACTERIZATION OF THE LHO 2KM CAVITIES

**P Fritschel
LSC meeting
LLO, 16-18 March 2000**

Goals

□ Optical

- ◆ Measure cavity resonant reflectivity (cavity losses)
- ◆ Measure mode-matching; adjust telescope if necessary

□ Environmental influences

- ◆ Length fluctuations: microseism and tides
- ◆ Angle fluctuations

□ Servos

- ◆ lock acquisition
- ◆ test mass resonances
- ◆ alignment servo (digital)
- ◆ test final stage of frequency stabilization (common mode servo)
- ◆ characterize stack fine actuators

2km X-arm

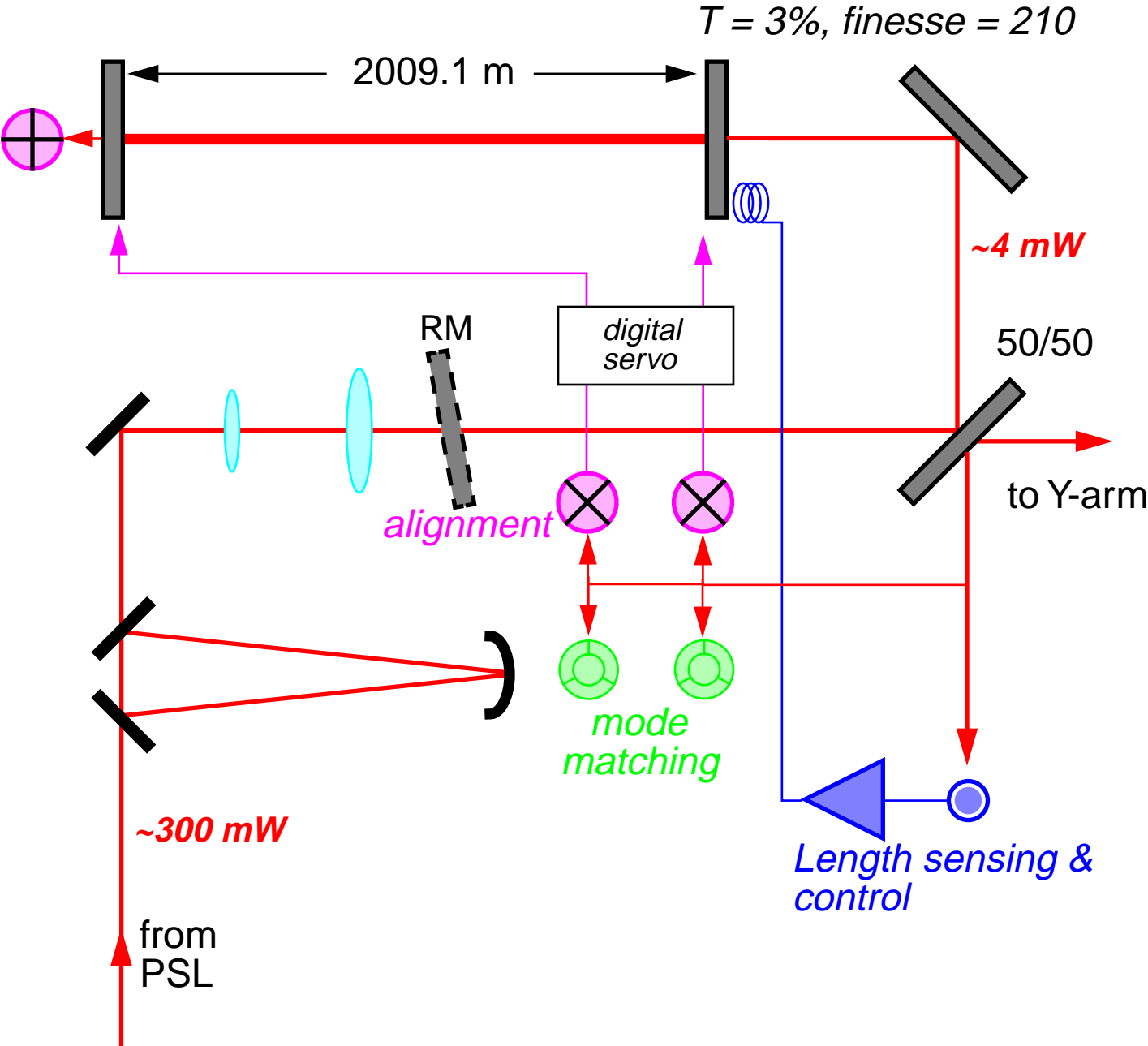

Status

- ❑ Gate valves between corner and mid stations first opened end Nov '99
 - ◆ laser beam scatter off of suspension cage was seen immediately!
- ❑ Most of the effort to date put into acquiring and maintaining a stable lock
 - ◆ since the end of Feb, cavity locks easily, and stably for 1-2 hours
- ❑ Wavefront sensor alignment system implemented in early March
 - ◆ clearly brings the cavity to good alignment
- ❑ Optical and environmental characterizations are underway
 - ◆ characterization will continue through first week of April

Cavity length locking

Cavity free-swinging (optics locally damped) through a resonance:

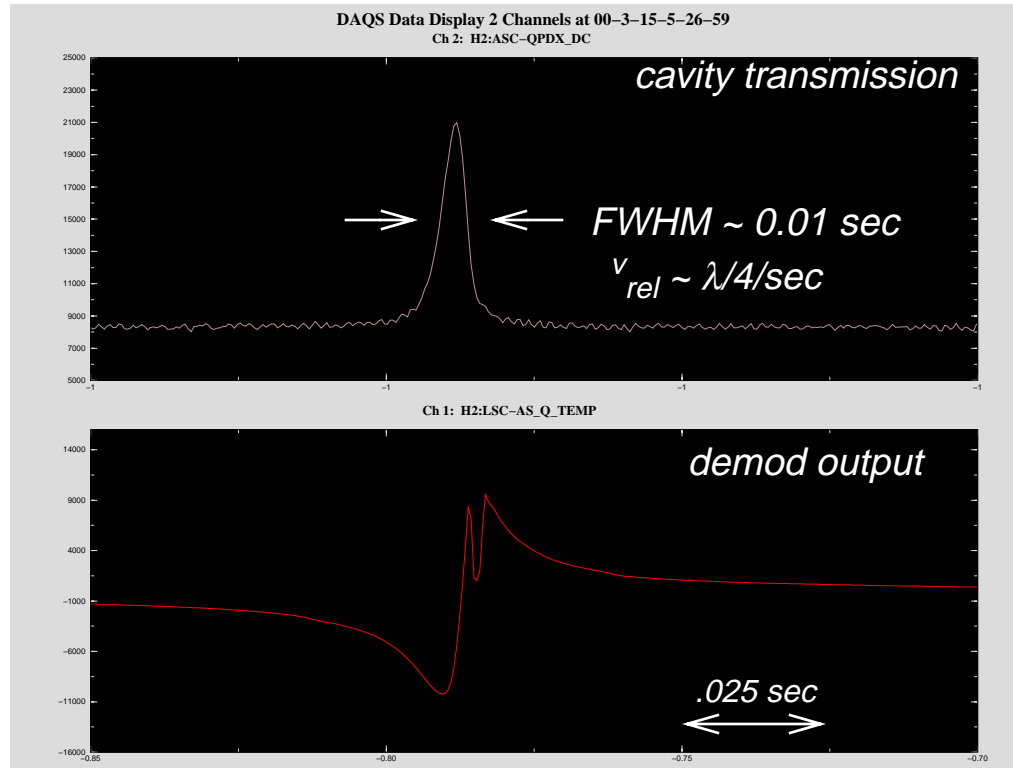

□ Unity gain frequency: ~500 Hz

- $f > 30$ Hz: $1/f$
- 1 Hz $< f < 20$ Hz: $1/f^3$

□ Test mass resonances

- ◆ initial strategy was to notch out the first two axisymmetric modes (9.4 kHz & 14 kHz)
- ◆ didn't work: first non-axisymmetric (6.2 kHz) mode and many higher frequency (>20 kHz) modes rung up
- ◆ solution: notch added at 6.2 kHz; loop roll-off above ~10kHz increased with additional poles

Cavity resonant reflectivity

□ Current measurement: $P_{\text{ref,res}}/P_{\text{ref,nr}} = 96 \%$



$$R_{\text{cav}} \approx 1 - \frac{8L}{T} \Rightarrow L = (1 - R_{\text{cav}})(T/8) = 150 \text{ ppm}$$

□ We expect more like 50 ppm losses

◆ beam centering: an offset of the beam from the center of one of the test masses of 5 cm results in ~50 ppm of aperture loss; initially produced a higher loss, but not since realignment

◆ beam may be clipping in non-cavity optical elements in the vacuum system

□ Mode matching

◆ intend to measure with wavefront sensing, 'bull's-eye' photodetectors

◆ examining the cavity reflected power transient when the input beam is cut off gives a lower limit of ~80%

Drifts

□ PSL Reference cavity temperature

- ◆ initially, 2km cavity length drifts of $\sim 1 \mu\text{m}/\text{min}$ were seen
- ◆ reference cavity chamber was temperature stabilized, to a small fraction of this rate

□ Tidal distortions

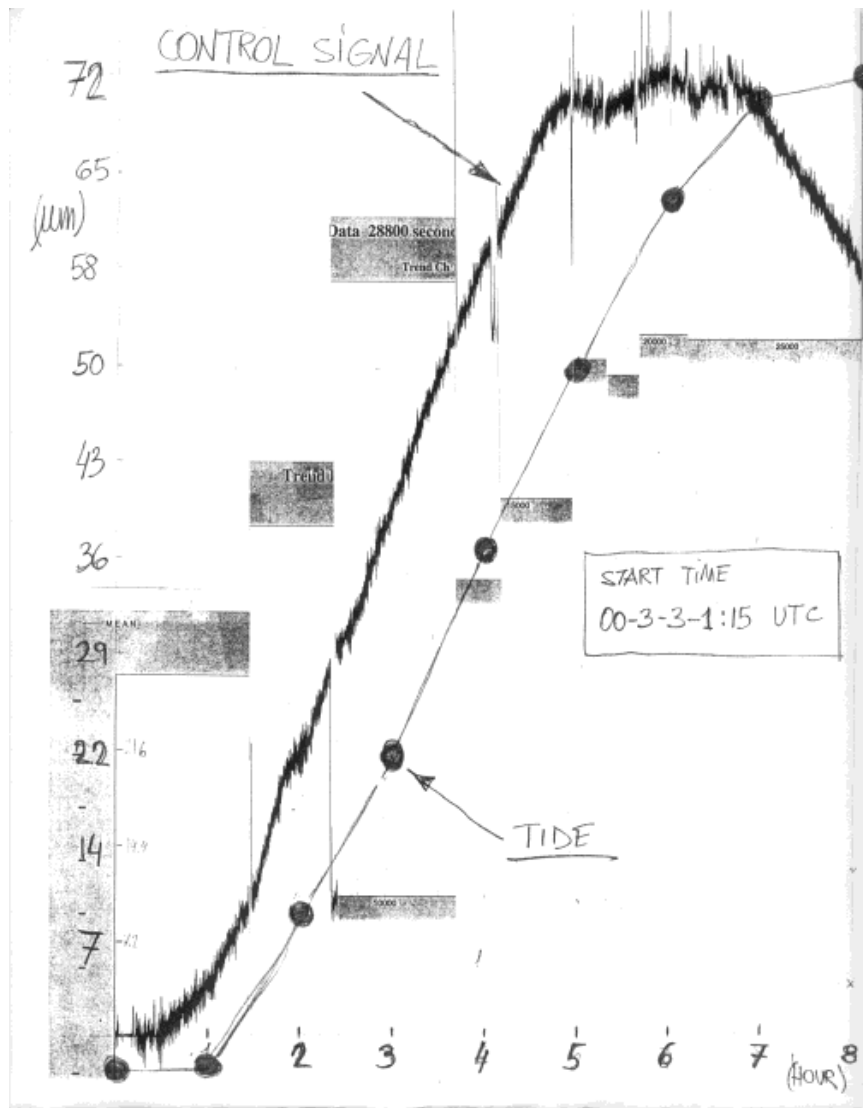

Microseism

Comparison of cavity length control signal with seismometers

◆ 4000 sec of data (continuous lock)

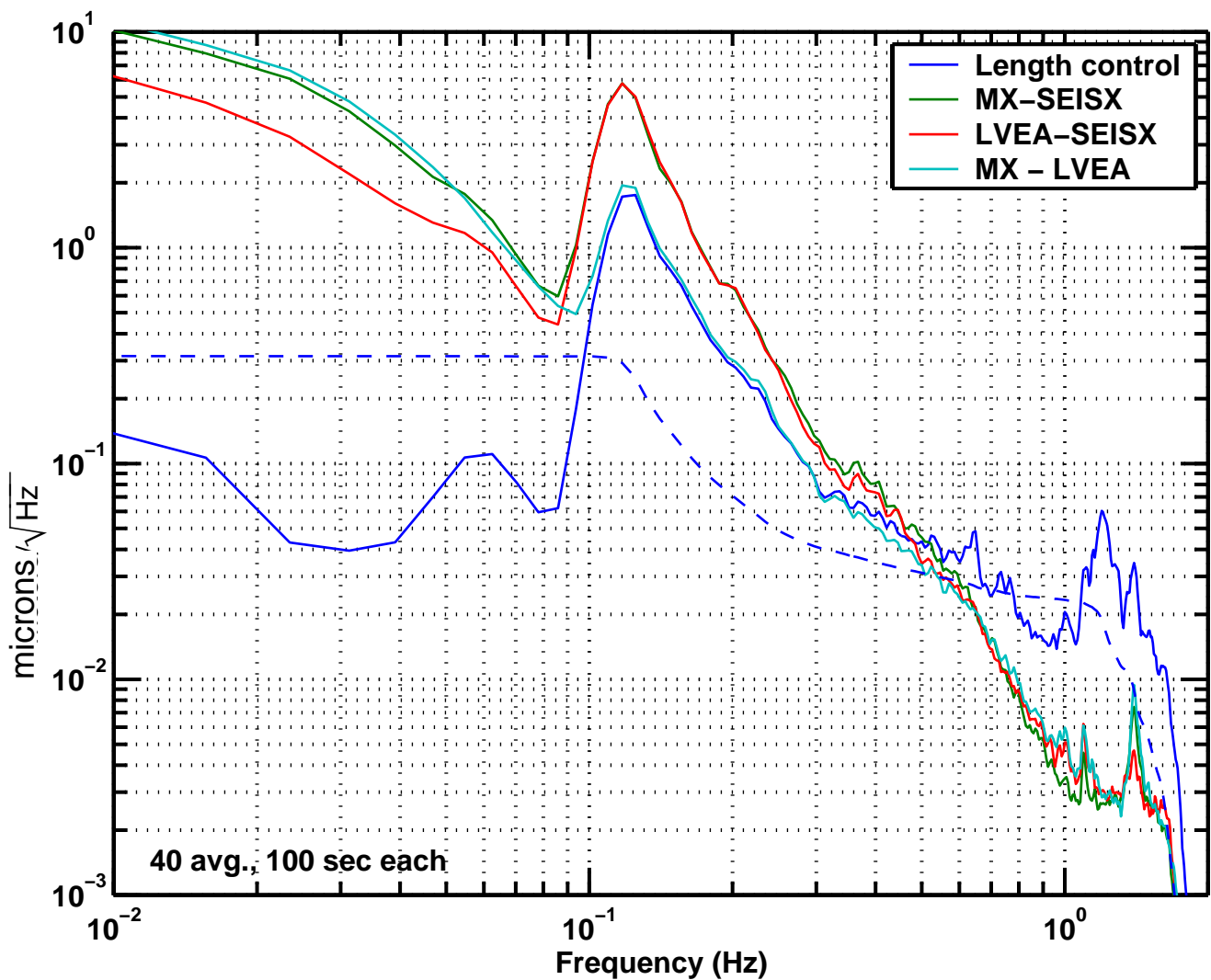

Microseism (cont'd)

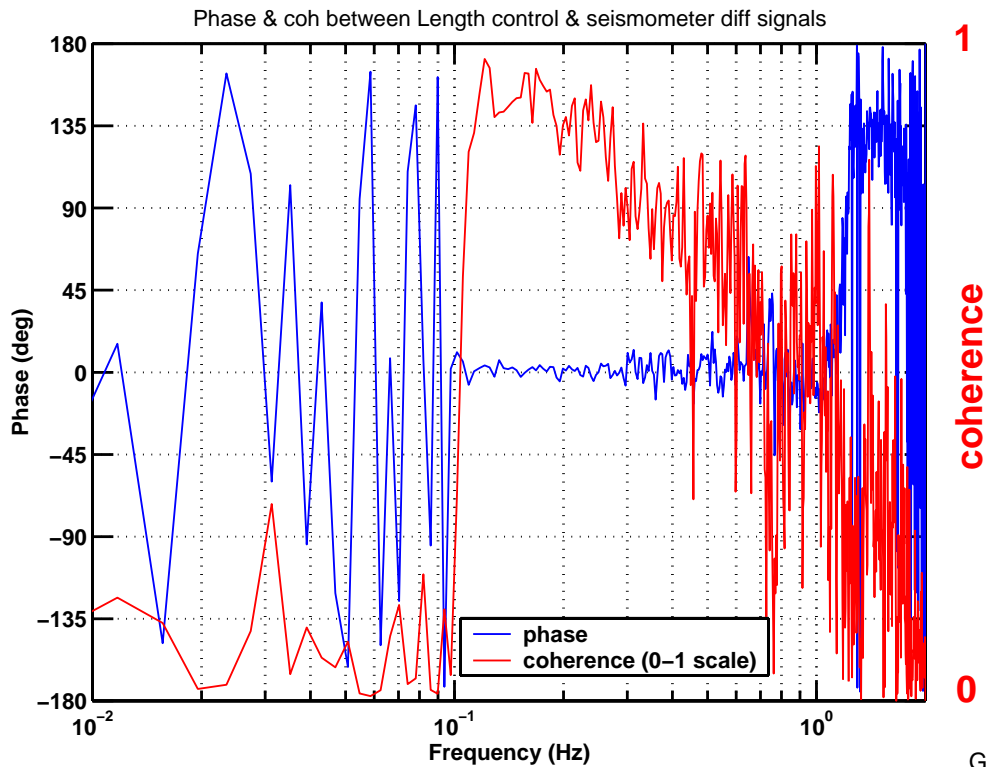
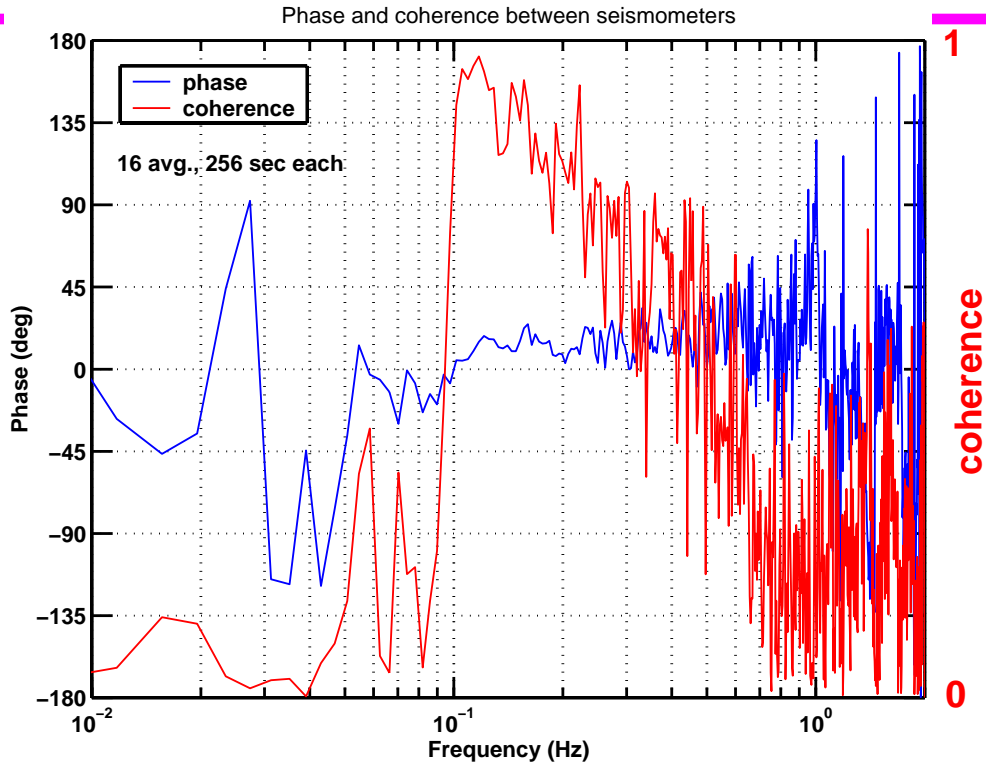

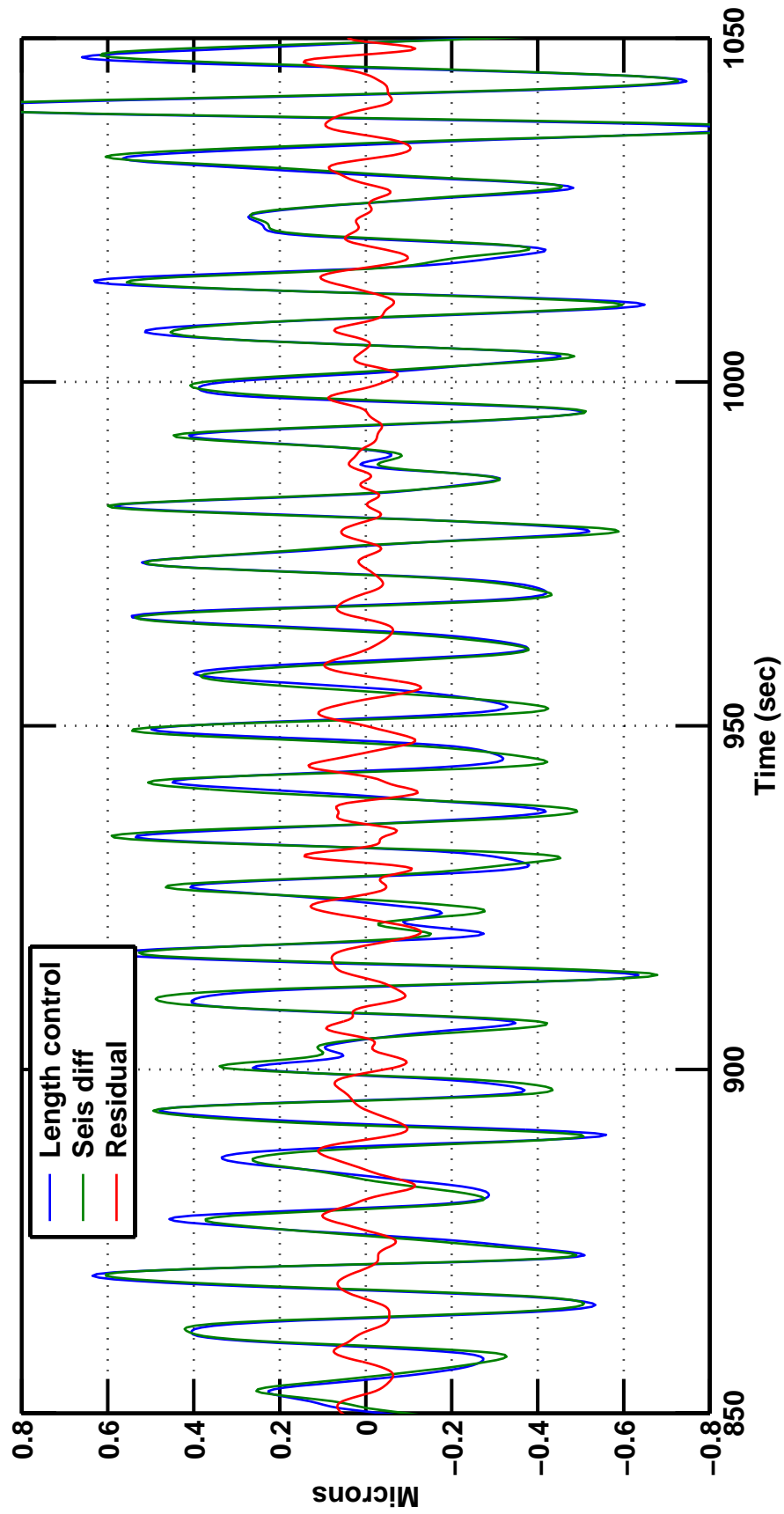

Spectra of error & control signals

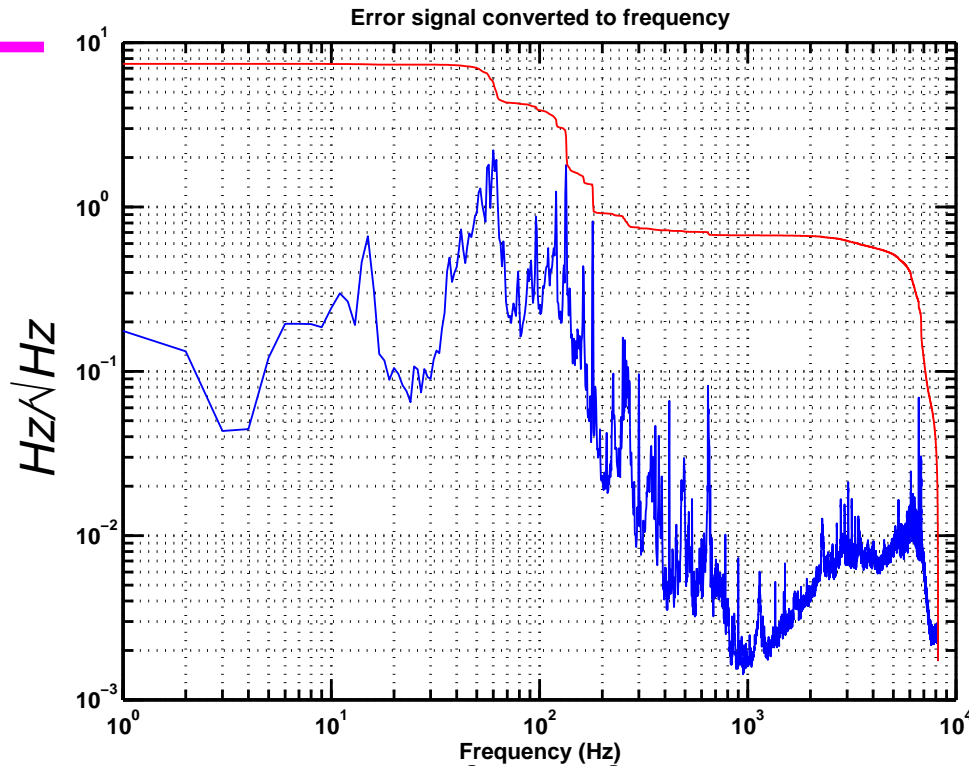

Error signal,
converted to
frequency
units

red = rms vs. f

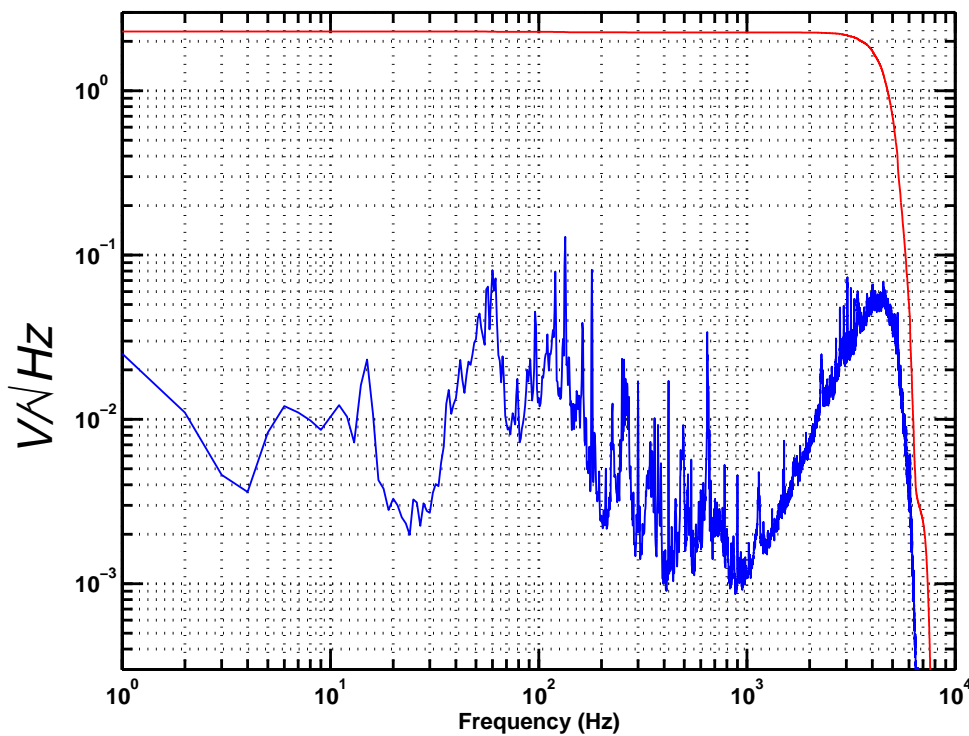

Length control
signal,
 0.4 mN/V

WFS alignment

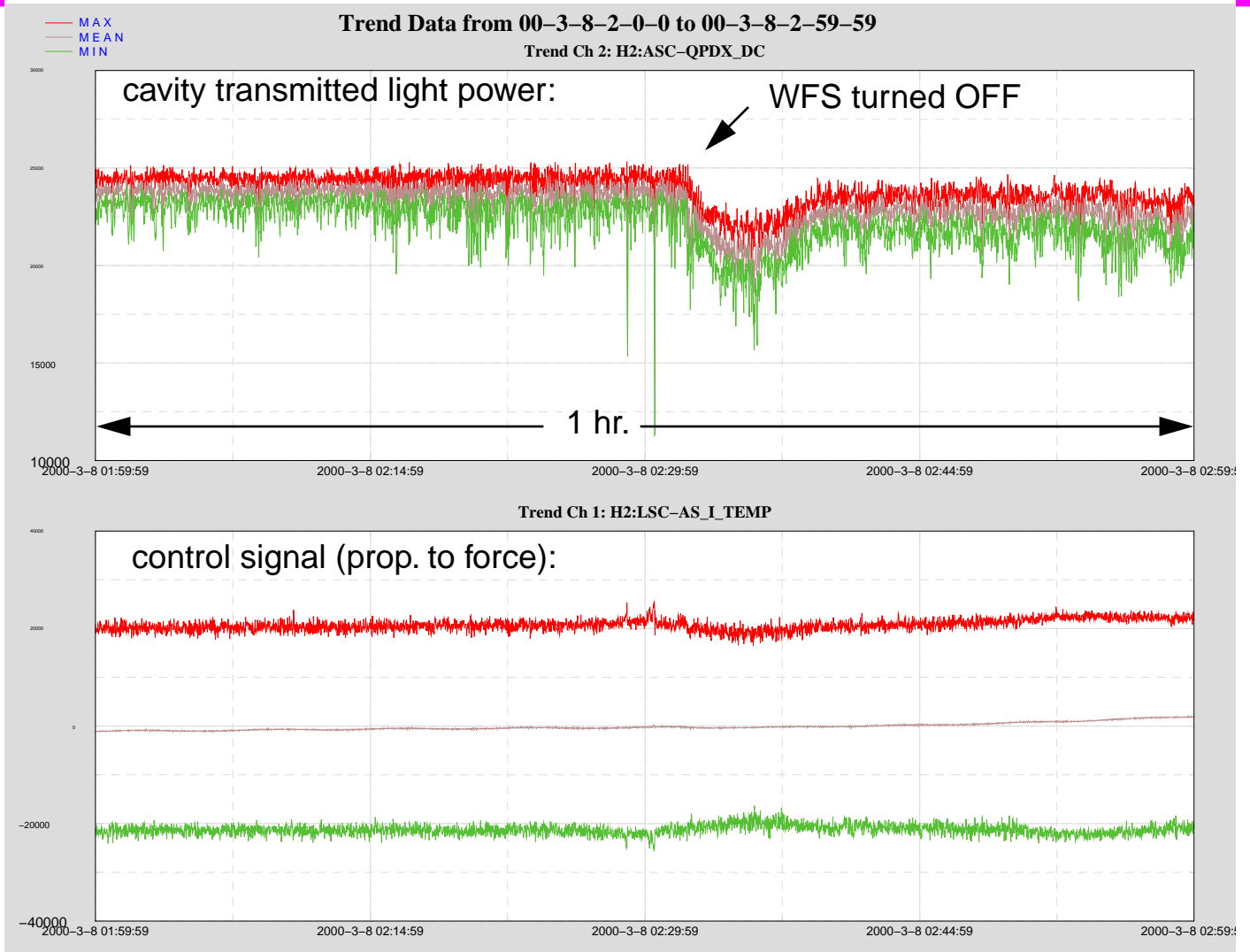

□ Digital filtering

- ◆ $1/f$ overall loop response
- ◆ low bandwidth, for now, u.g.f. < 1 Hz

WFS matrix

- All four TM orientation d.o.f. are modulated through a digital interface
- FFT of each WFS signal (each quadrant, if desired) taken to establish response

