

D1100208\_ALIGO\_AOS\_Output Faraday Isolator Spacer (HAM5-L1), PART PDM REV: X-005, DRAWING PDM REV: X-005

NOTES CONTINUED:  
5. SCRIBE, ENGRAVE, OR MECHANICAL STAMP (NO INK OR DYES) DRAWING PART NUMBER, REVISION, USED, CHAMBER ON NOTED SURFACE OF PART FOLLOWED ON THE LINE WITH A THREE DIGIT SERIAL NUMBER. SERIAL NUMBERS START AT 001 FOR THE FIRST ARTICLE AND PROCEED CONSECUTIVELY. USE MINIMUM 0.12" HIGH CHARACTERS, UNLESS THE SIZE OF THE PART DICTATES SMALLER CHARACTERS. A VIBRATORY TOOL MAY BE USED. EXAMPLE: DXXXXXX-VY, TYPE-XX, S/N XXX, SR2, HAM5-L1.

- 6. APPROXIMATE WEIGHT = 37.72 LB.
- 7. ALL PARTS SHALL BE MANUFACTURED IN ACCORDANCE WITH LIGO SPECIFICATION E0900364.
- 8. ALL MATERIAL IS TO BE VIRGIN MATERIAL (i.e. NO WELD REPAIRS, PLUGS OR RECYCLED MATERIAL), NO REPAIRS SHALL BE MADE UNLESS APPROVED IN ADVANCE, AND IN WRITING, BY LIGO LABORATORY. REFER TO LIGO-E0900364.
- 9. SURFACE FINISH TO BE AS-PROCESSED FROM MILL/SUPPLIER, FREE FROM SCRATCHES OR GOUGES.

REV.	DATE	DCN #	DRAWING TREE #
v1	15 FEB 2011	-	-
v2	25 APR 2011	-	-
-	-	-	-

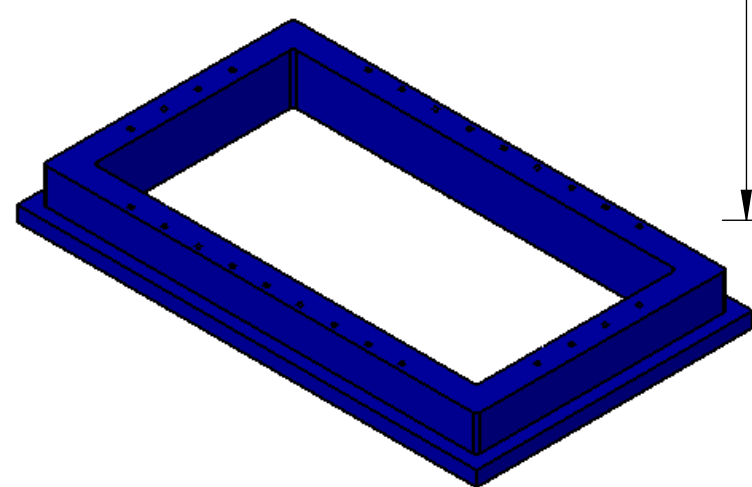
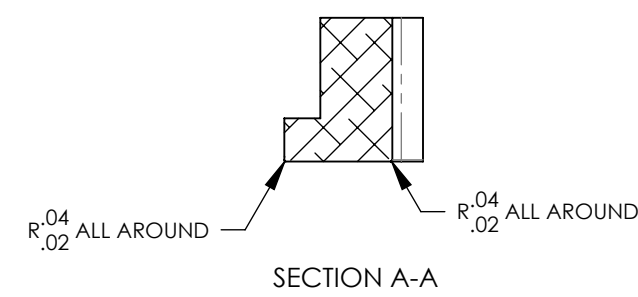
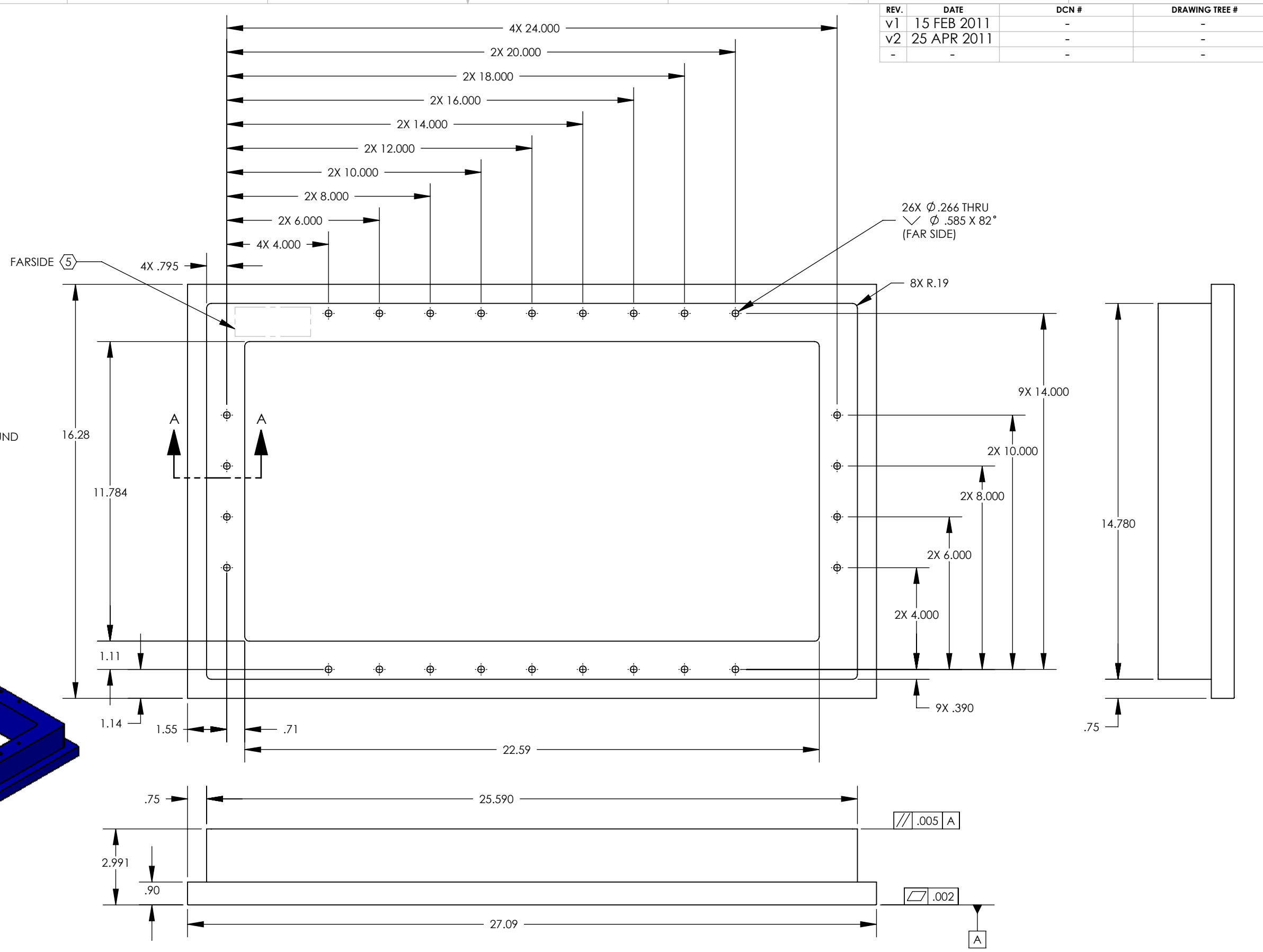

**NOTES AND TOLERANCES: (UNLESS OTHERWISE SPECIFIED)**

DIMENSIONS ARE IN  
TOLERANCES:  
.XX ± .01  
.XXX ± .005  
ANGULAR ± .5°

1. INTERPRET DRAWING PER ASME Y14.5-1994.  
2. REMOVE ALL SHARP EDGES, .005-.015, FOR MACHINED PARTS. ROUND ALL EDGES APPROXIMATELY R.02 FOR SHEET METAL PARTS.  
3. DO NOT SCALE FROM DRAWING.  
4. ALL MACHINING FLUIDS MUST BE FULLY SYNTHETIC, FULLY WATER SOLUBLE AND FREE OF SULFUR, SILICONE, AND CHLORINE.

**MATERIAL** 6061-T6 Al  
**FINISH** 63 μinch

**LIGO** CALIFORNIA INSTITUTE OF TECHNOLOGY  
MASSACHUSETTS INSTITUTE OF TECHNOLOGY

**SYSTEM** ADVANCED LIGO  
**SUB-SYSTEM** AOS  
**NEXT ASSY** D0900456

**PART NAME** Output Faraday Isolator Spacer (HAM5-L1)

<b>DESIGNER</b>	M.RUIZ	04 FEB 2011	<b>SIZE</b>	<b>DWG. NO.</b>	<b>REV.</b>
<b>DRAFTER</b>	M.RUIZ	07 FEB 2011	<b>B</b>	<b>D1100208</b>	<b>v2</b>
<b>CHECKER</b>			<b>SCALE:</b> 1:4	<b>PROJECTION:</b>	<b>SHEET 1 OF 2</b>
<b>APPROVAL</b>					

D1100208\_ALIGO\_AOS\_Output Faraday Isolator Spacer (HAM5-L1), PART PDM REV: X-005, DRAWING PDM REV: X-005

8 7 6 5 4 3 2 1

D  
C  
B  
A

D  
C  
B  
A

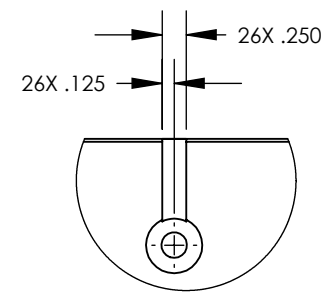
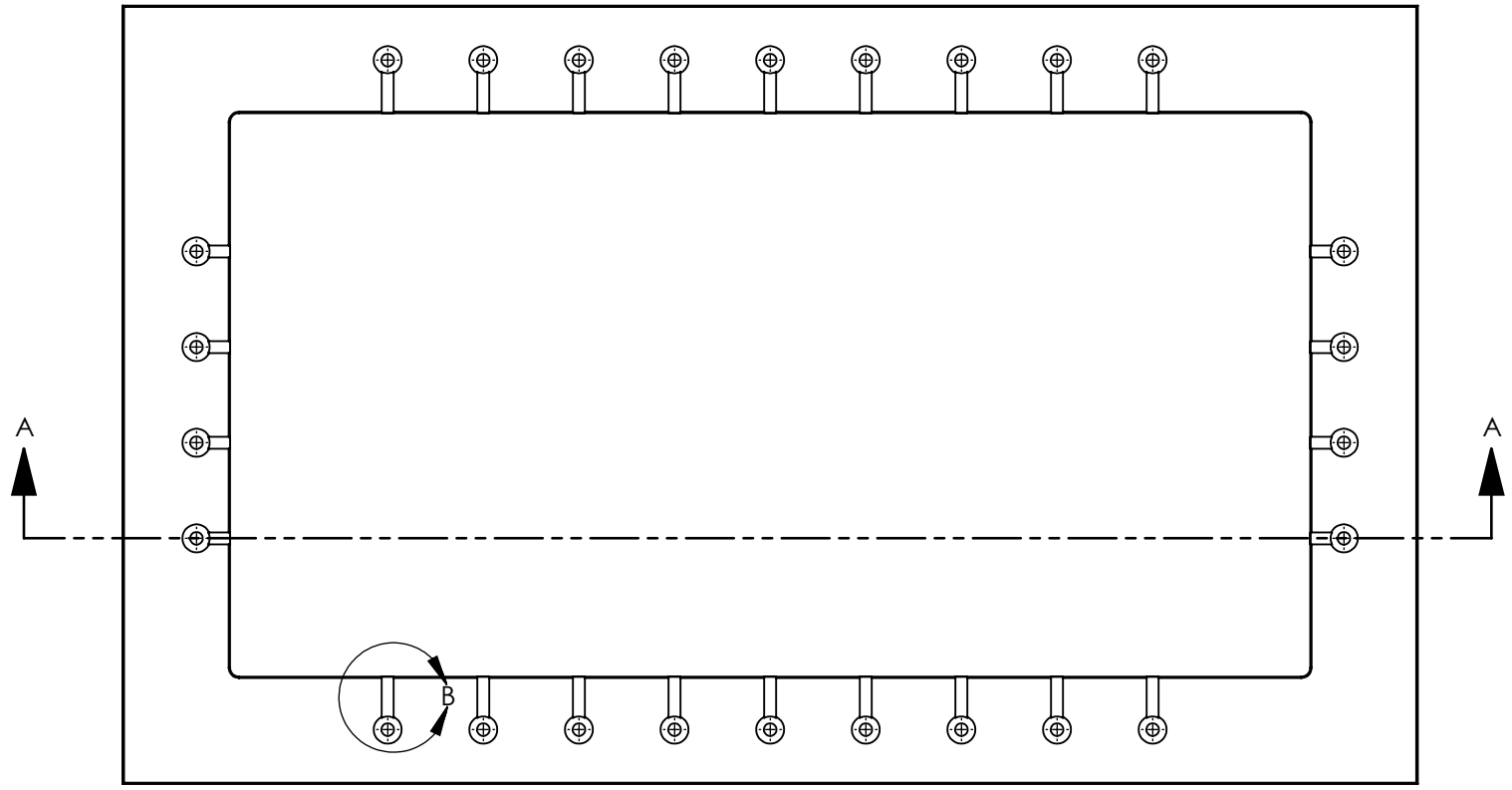

DETAIL B  
SCALE 1 : 2

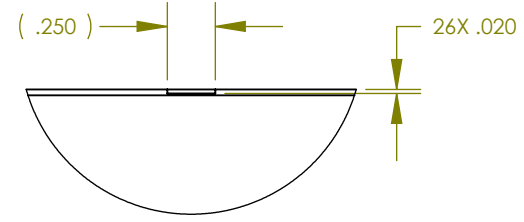

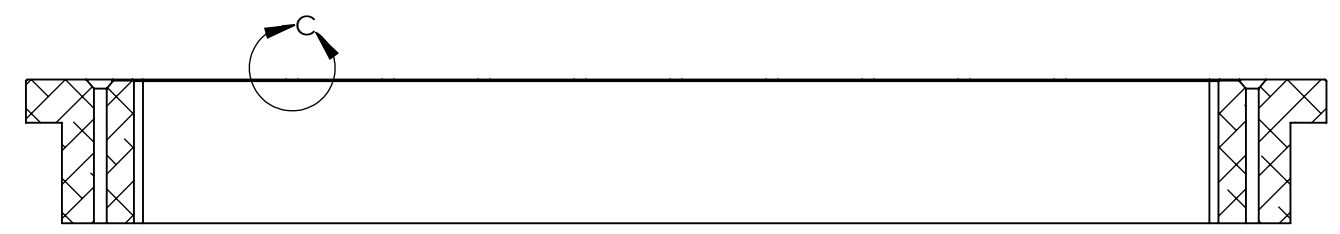

DETAIL C  
SCALE 1 : 1



SECTION A-A

8 7 6 5 4 3 2 1

 CALIFORNIA INSTITUTE OF TECHNOLOGY MASSACHUSETTS INSTITUTE OF TECHNOLOGY	
SIZE <b>B</b>	DWG. NO. D1100208
SCALE: 1:4	PROJECTION:  SHEET 2 OF 2
REV. v2	