

REV: v9 Changes
 ITM-SUS-OP-LV Controls Wiring - REV: v9
 v9 of the system wiring includes ITM and DS Op Lev quad channel signal path along with Laser PWR. Show connections of ITM and RS to the AA channel. (See Sheet 21)

ITMY UIM and PUM Stage Wiring

Vacuum Flange

Seismic Table

Top Mass

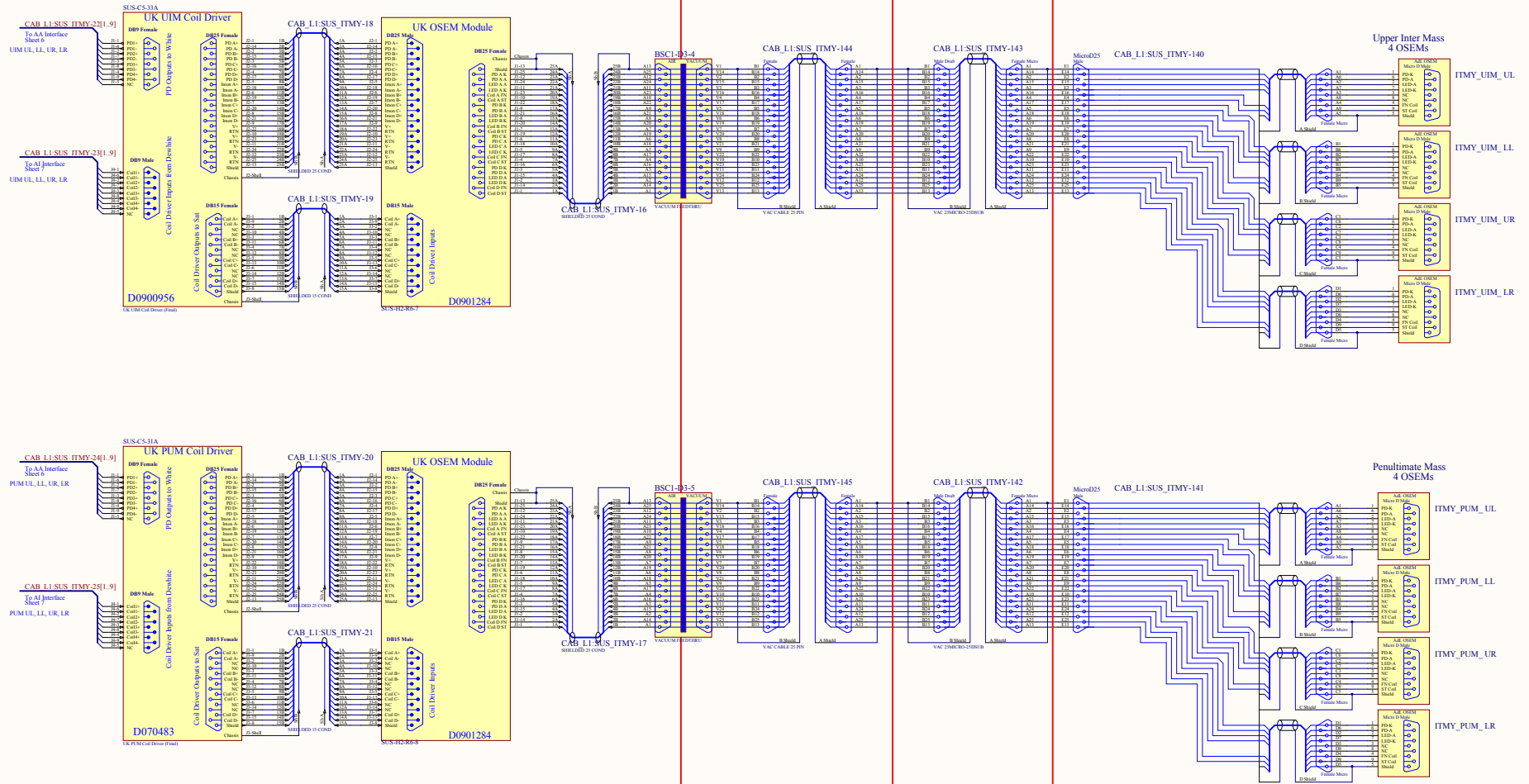

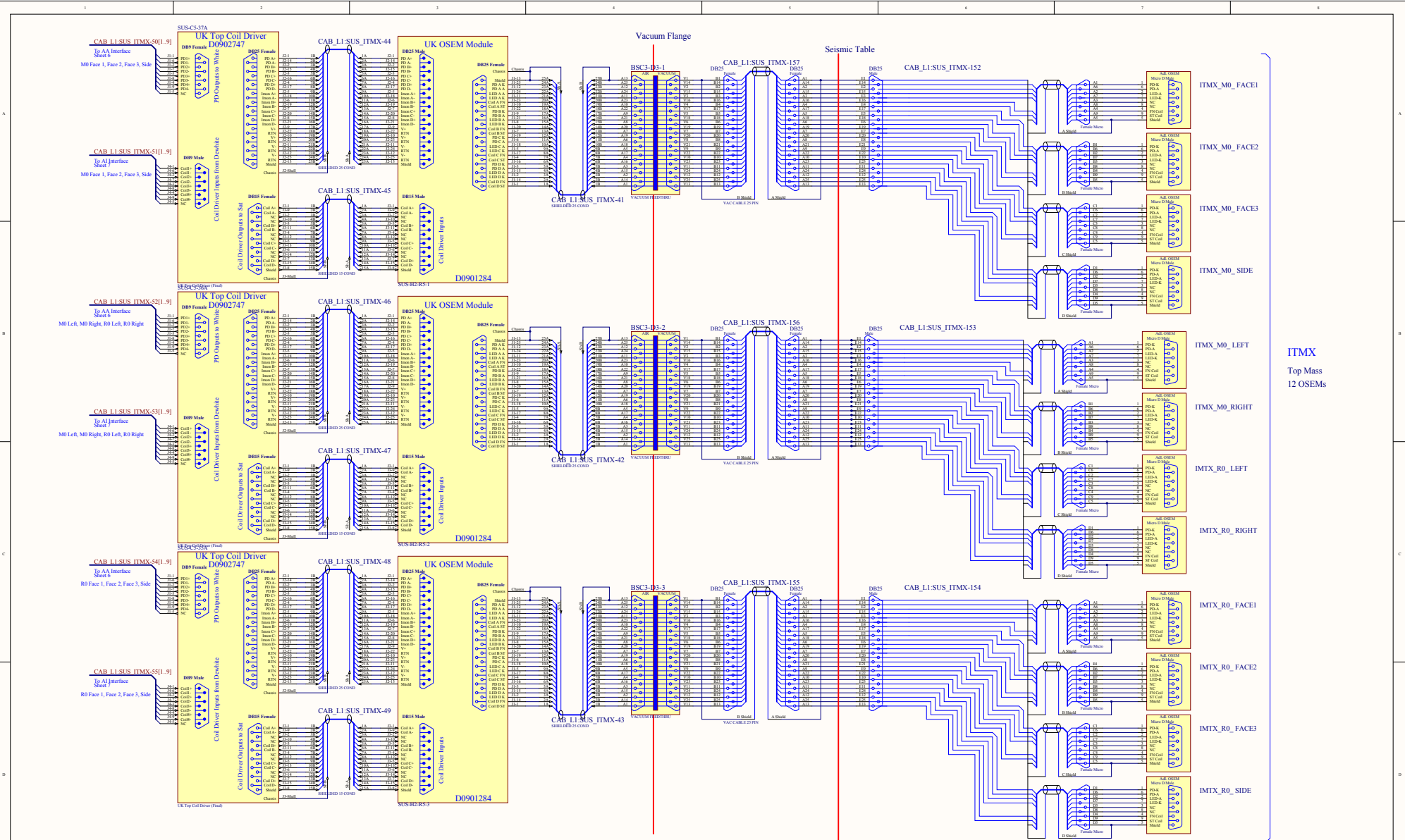

ITMX UIM and PUM Stage Wiring

Vacuum Flange

Seismic Table

Top Mass

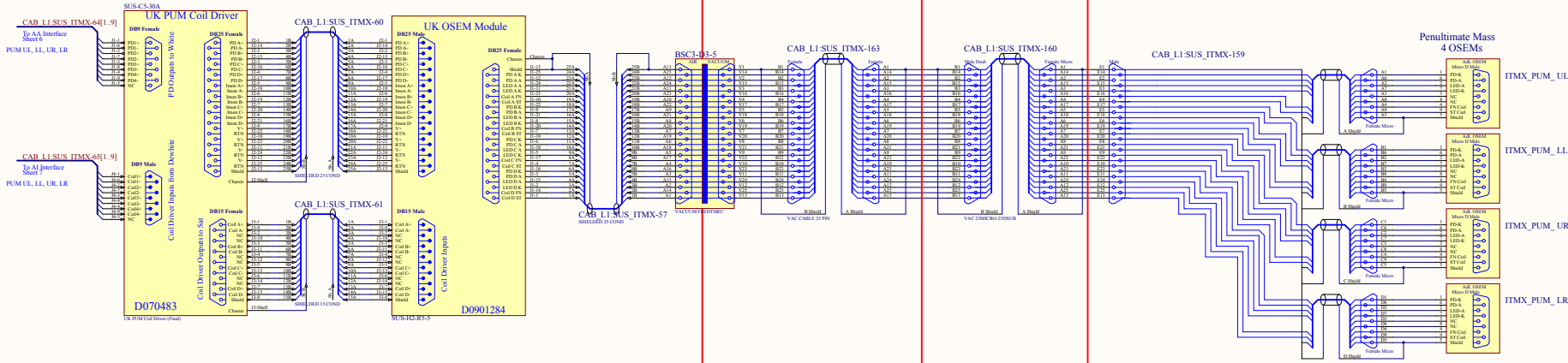
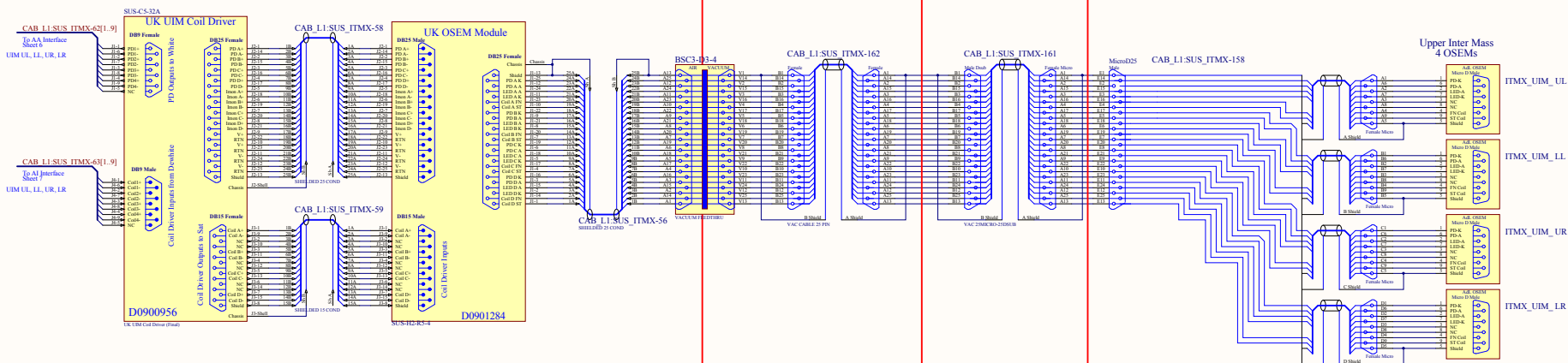

BS SUS Wiring

Vacuum Flange Seismic Table

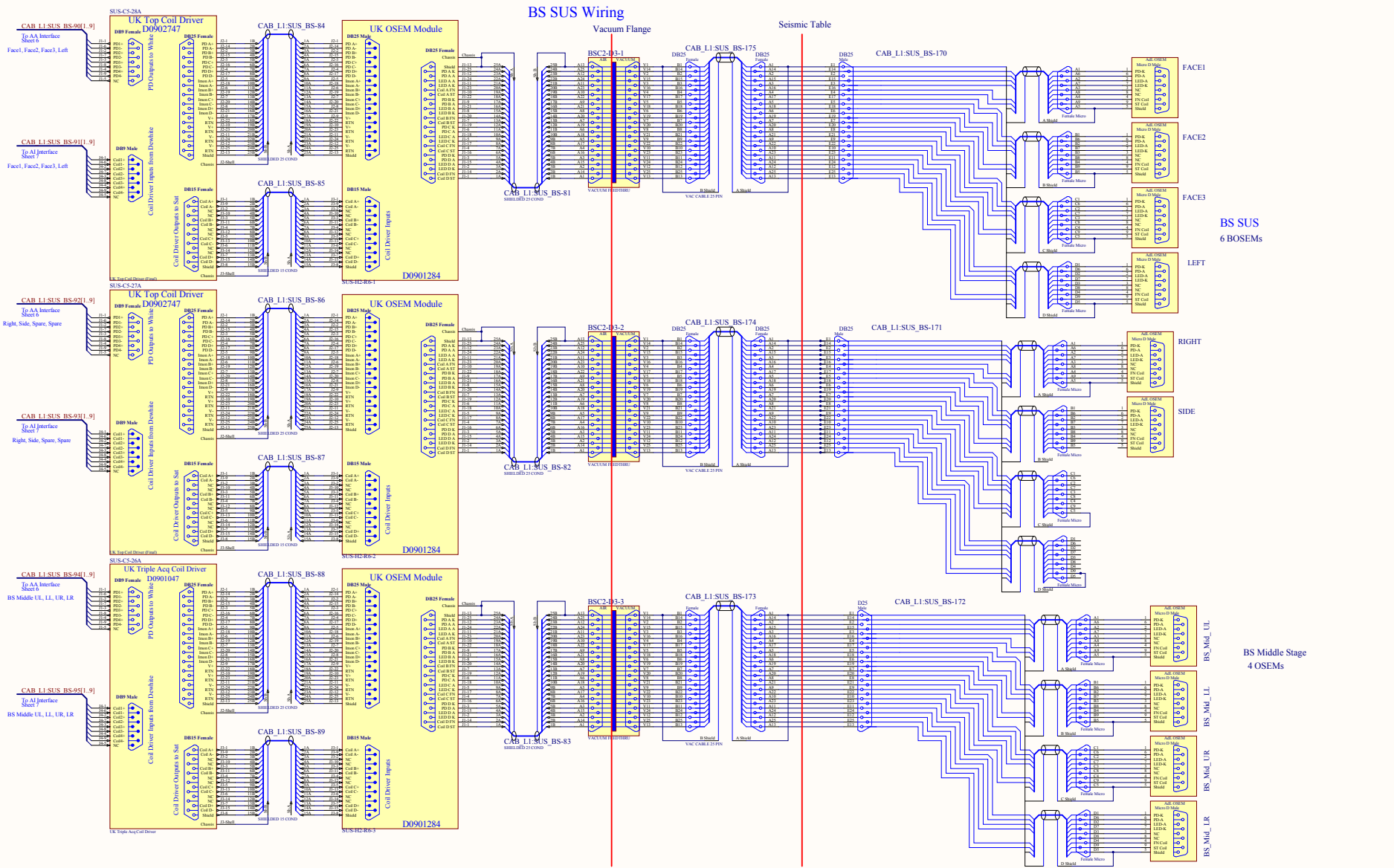

ITM,BS SUS Front End CPU 0 DAC Connections

See Sheet 12 for DAC Binary Connections and Channel Lists

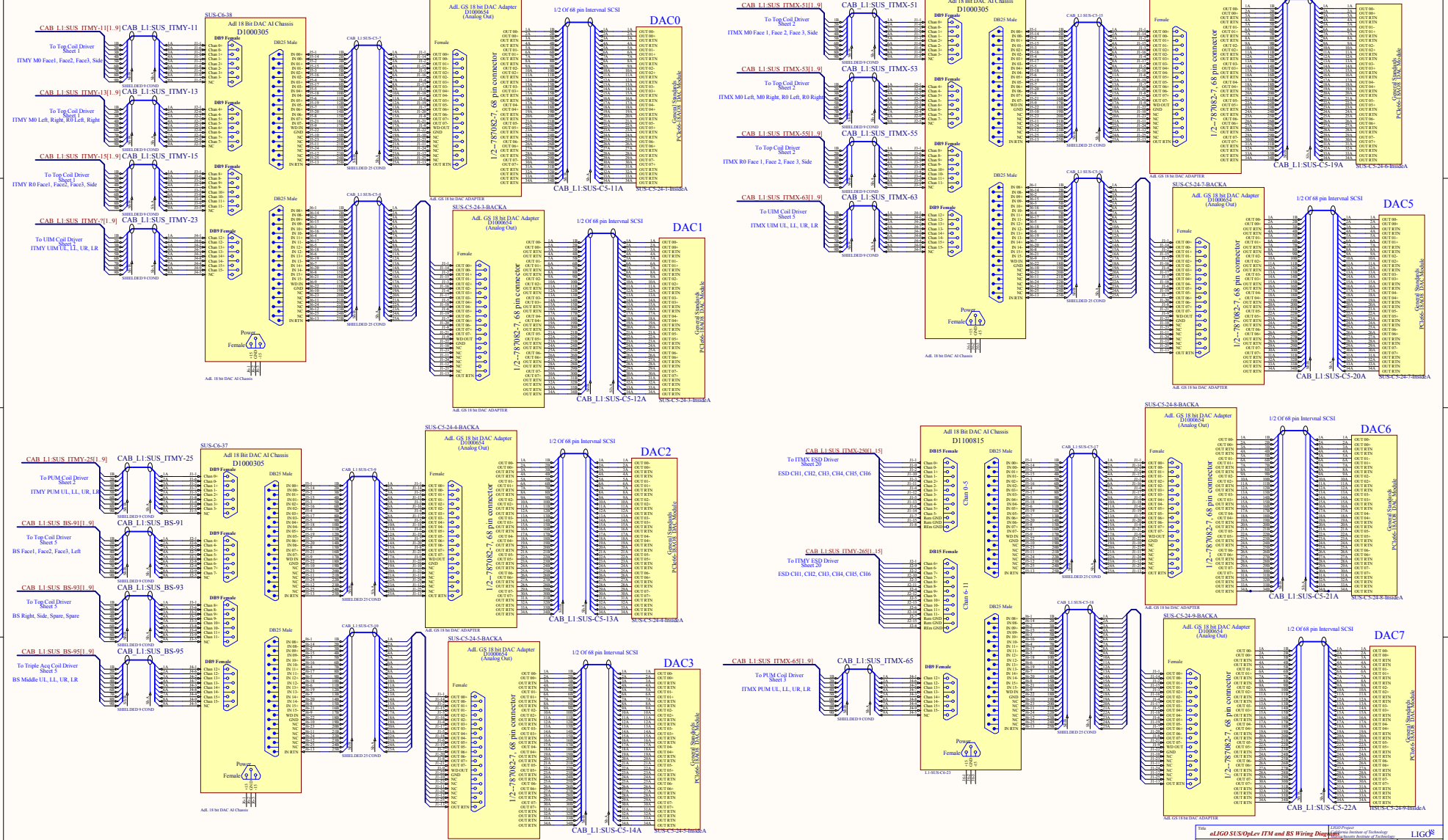

Binary IO Connections for Contec DIO-6464L-PE Module 0

Commands- Binary Outputs

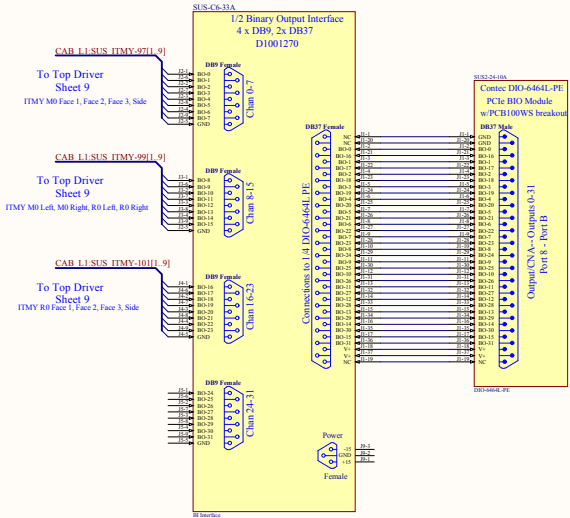

Monitors- Binary Inputs

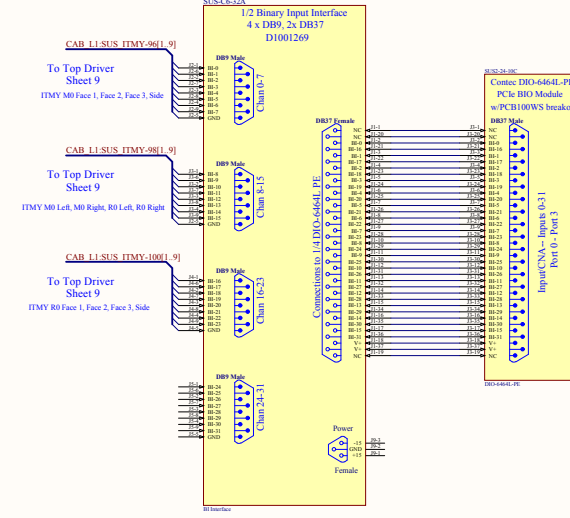

Commands- Binary Outputs

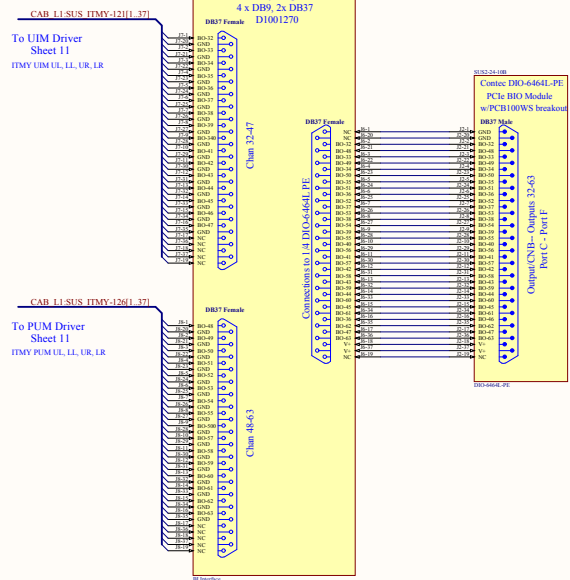

Monitors- Binary Inputs

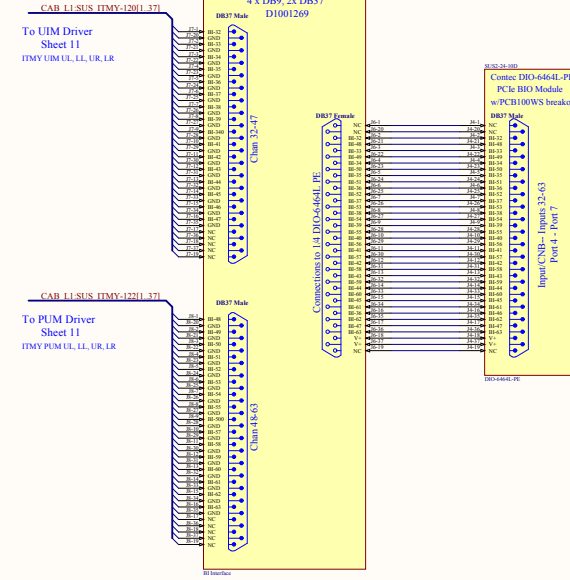

Binary IO Connections for Contec DIO-6464L-PE Module 2

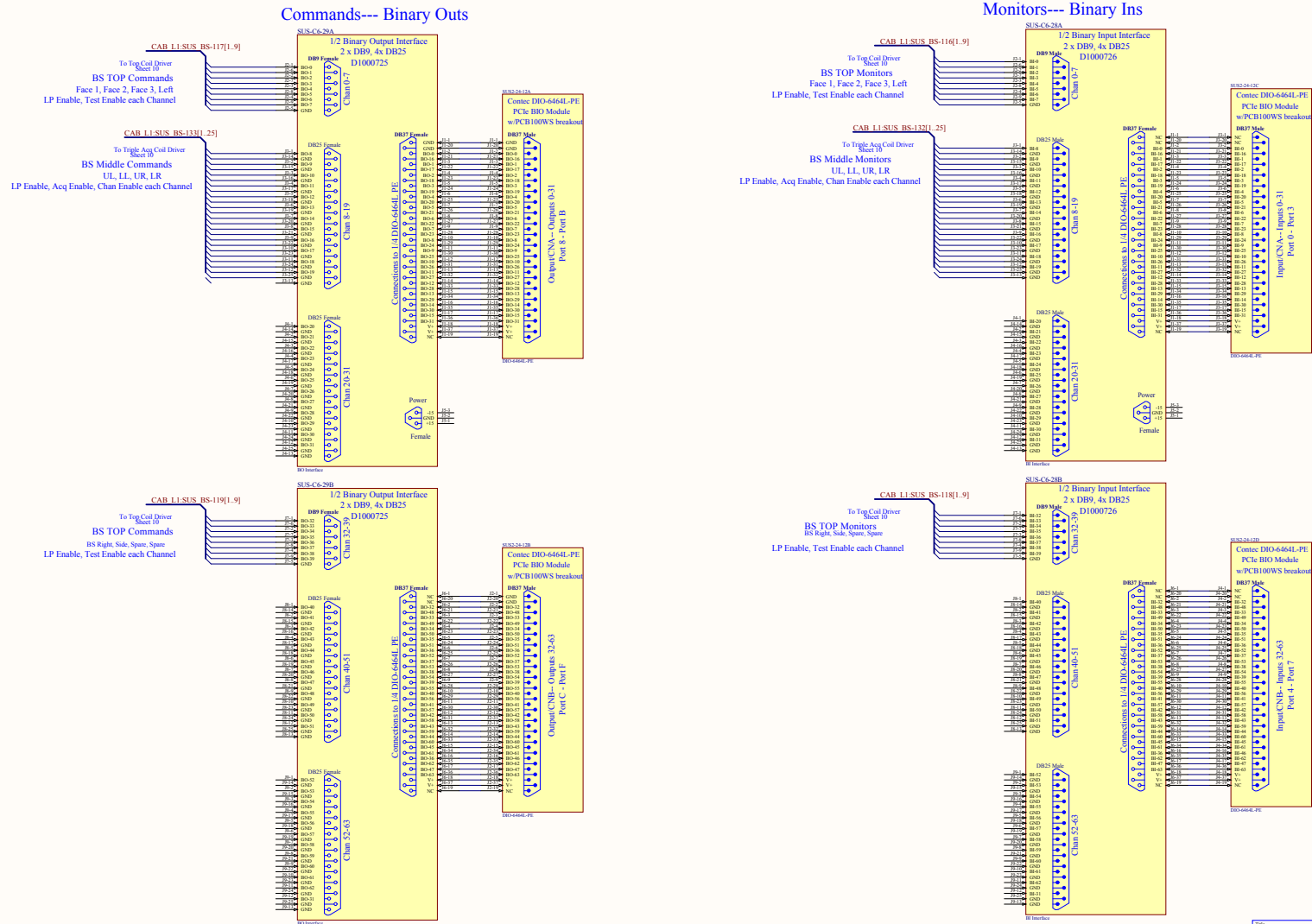

Coil Driver Monitor Connections

ITMY

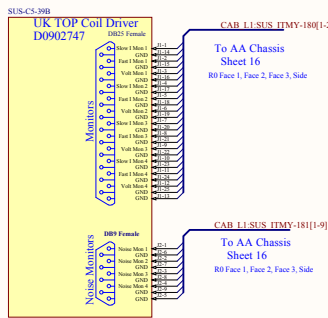
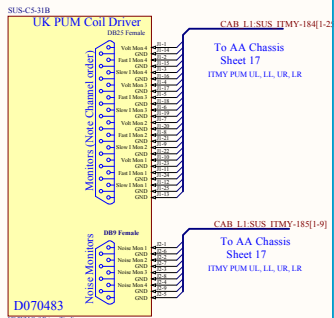
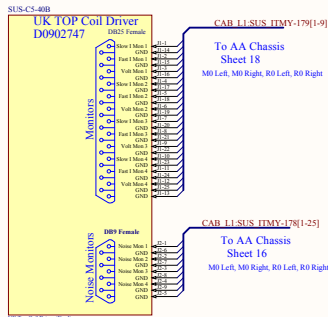
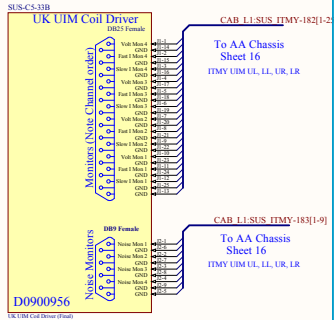
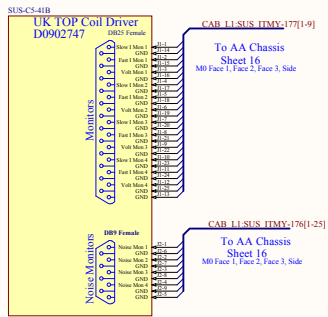

ITMX

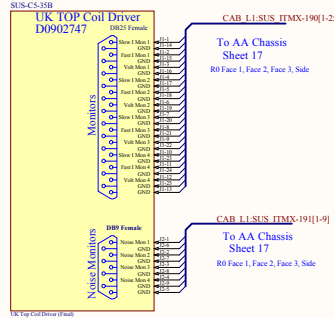
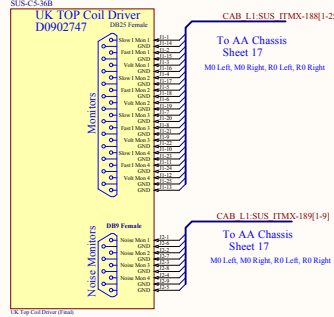
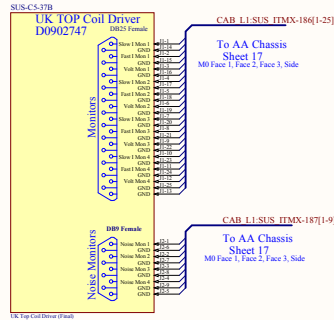

BS

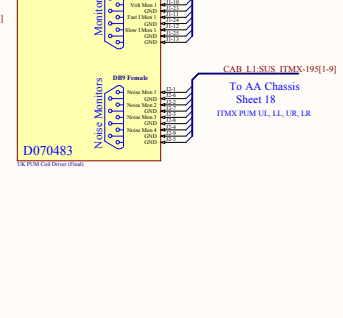
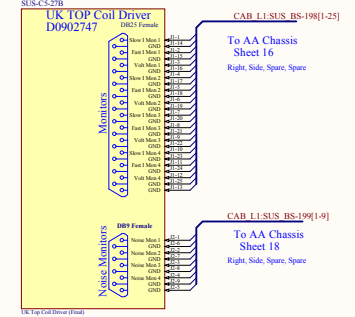
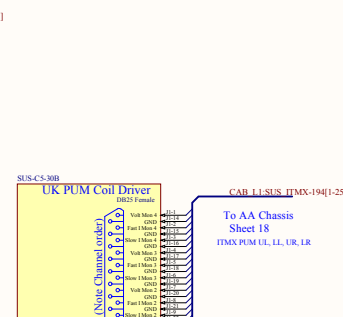
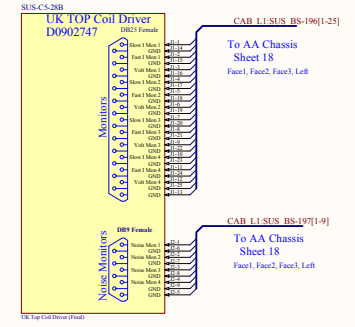
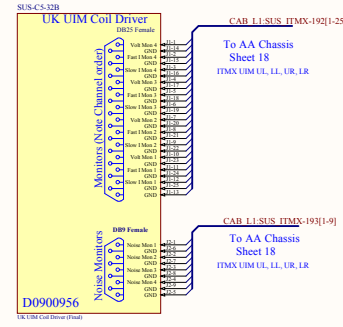

ITM, BS SUS Monitor CPU ADC 2 & 3 Connections

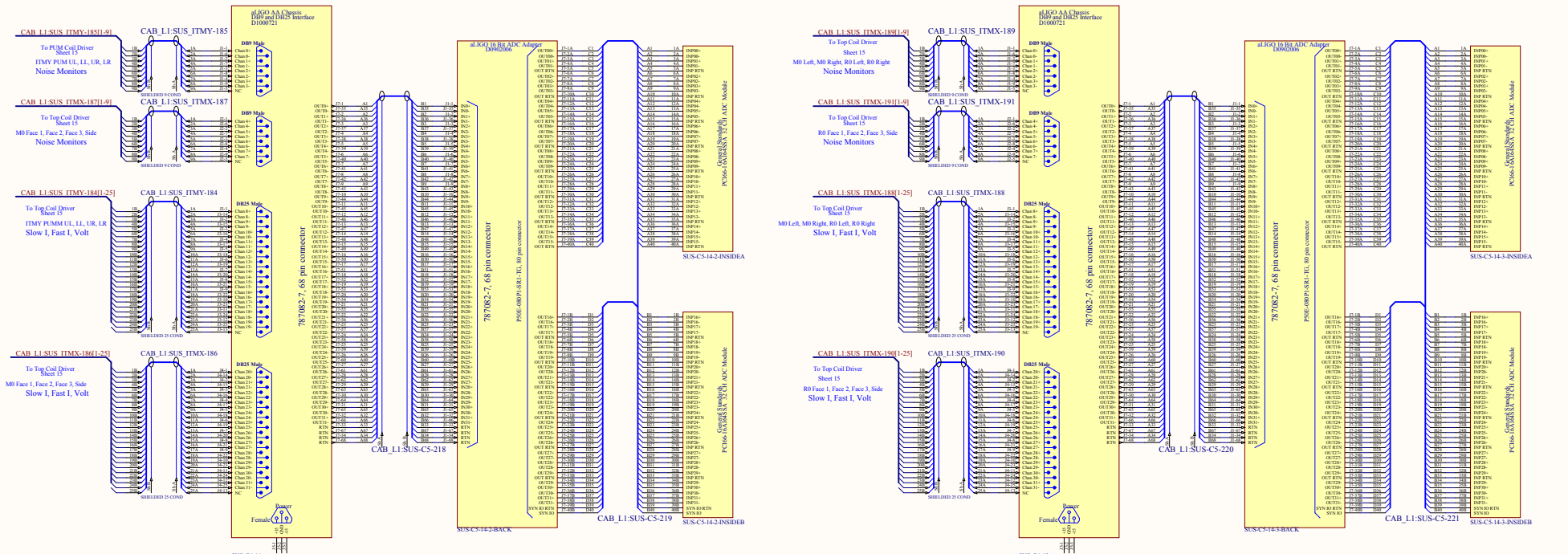

ADC3 Channel Index	
ITM/BS	SUS Monitor
EH0	-ITMX MD Left Noise
EH1	-ITMX MD Right Noise
EH2	-ITMX MD Left Volt
EH3	-ITMX MD Right Volt
EH4	-ITMX MD Left Slow (1mm)
EH5	-ITMX MD Right Slow (1mm)
EH6	-ITMX MD Left Slow (3mm)
EH7	-ITMX MD Right Slow (3mm)
EH8	-ITMX MD Left Slow (5mm)
EH9	-ITMX MD Right Slow (5mm)
EH10	-ITMX MD Left Slow (1mm) Man
EH11	-ITMX MD Right Slow (1mm) Man
EH12	-ITMX MD Left Slow (3mm) Man
EH13	-ITMX MD Right Slow (3mm) Man
EH14	-ITMX MD Left Slow (5mm) Man
EH15	-ITMX MD Right Slow (5mm) Man
EH16	-ITMX MD Left Volt Man
EH17	-ITMX MD Right Volt Man
EH18	-ITMX MD Left Volt Man
EH19	-ITMX MD Right Volt Man
EH20	-ITMX MD Left Slow (1mm) Man
EH21	-ITMX MD Right Slow (1mm) Man
EH22	-ITMX MD Left Slow (3mm) Man
EH23	-ITMX MD Right Slow (3mm) Man
EH24	-ITMX MD Left Slow (5mm) Man
EH25	-ITMX MD Right Slow (5mm) Man
EH26	-ITMX MD Left Slow (1mm) Man
EH27	-ITMX MD Right Slow (1mm) Man
EH28	-ITMX MD Left Slow (3mm) Man
EH29	-ITMX MD Right Slow (3mm) Man
EH30	-ITMX MD Left Slow (5mm) Man
EH31	-ITMX MD Right Slow (5mm) Man

ADC3 Channel Index	
ITM/BS	SUS Monitor
EH32	-ITMX MD Left Noise
EH33	-ITMX MD Right Noise
EH34	-ITMX MD Left Volt
EH35	-ITMX MD Right Volt
EH36	-ITMX MD Left Slow (1mm)
EH37	-ITMX MD Right Slow (1mm)
EH38	-ITMX MD Left Slow (3mm)
EH39	-ITMX MD Right Slow (3mm)
EH40	-ITMX MD Left Slow (5mm)
EH41	-ITMX MD Right Slow (5mm)
EH42	-ITMX MD Left Slow (1mm) Man
EH43	-ITMX MD Right Slow (1mm) Man
EH44	-ITMX MD Left Slow (3mm) Man
EH45	-ITMX MD Right Slow (3mm) Man
EH46	-ITMX MD Left Slow (5mm) Man
EH47	-ITMX MD Right Slow (5mm) Man
EH48	-ITMX MD Left Volt Man
EH49	-ITMX MD Right Volt Man
EH50	-ITMX MD Left Volt Man
EH51	-ITMX MD Right Volt Man

ESD SYSTEM WIRING HAS BEEN MOVED TO

D1400177

BS Table Optical Lever

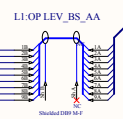
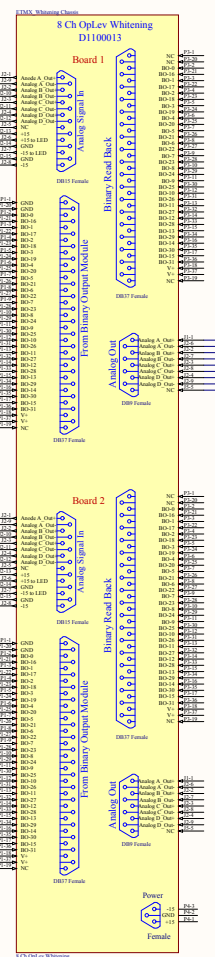
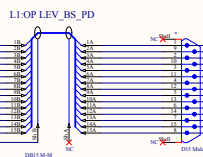
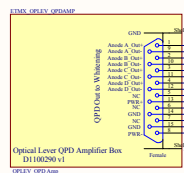
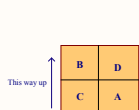

BS TABLE OPTICAL LEVER
To a.LIGO AA Chassis Channels 8-11 L1-SUS-C6-7
(See Sheet 6)

Rack Room Racks

Site:SUS-C5

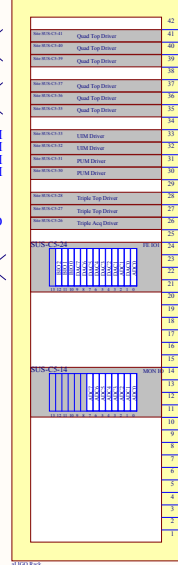

Site:SUS-C6

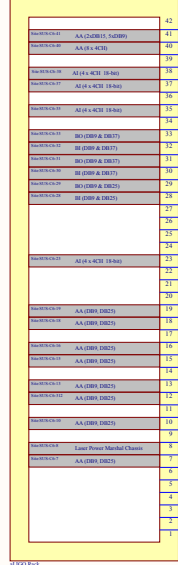

Field Racks Near Chambers

ITMY

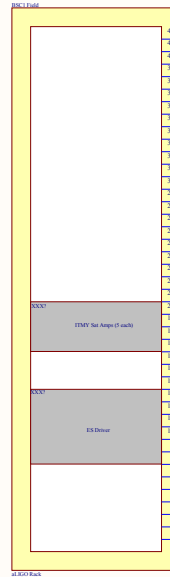

ITMX

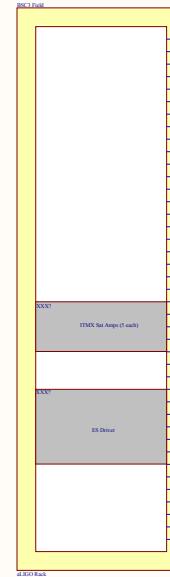

BS

