

AUG 05 1997

PSI DWG # V049-8-737

# Instruction Manual

VENDOR NAME:	<u>LIGO</u>
REVISION NO.:	<u>—</u>
SUBMITTAL NO.:	<u>1</u>
STATUS:	<u>Rev. APP</u>

## 2500 L/S Vaclon Pump

### PROCESS SYSTEMS INTERNATIONAL DOCUMENT REVIEW CHECKLIST

PROJECT NAME: V59049  
PSI DOC. NO. \_\_\_\_\_

CHK	BY / DATE
_____	PROJECT ENG
_____	MECHANICAL
_____	STRESS
_____	ELECTRICAL
_____	PROCESS
_____	MFG. ENG.
_____	MANUF
_____	Q.A.
_____	DRAFTING

### PROCESS SYSTEMS INTERNATIONAL DOCUMENT APPROVAL CHECKLIST

PROJECT NAME: LIGO  
PSI DOC. NO. V049-8-737

NOTE: THIS REVIEW DOES NOT RELIEVE THE SELLER OR CONTRACTOR OF ANY OBLIGATIONS UNDER THE P.O. OR CONTRACT.

- FA = FINAL APPROVAL
- AS = APP'D AS NOTED - REVISE & RESUBMIT
- AF = APPROVED FOR FABRICATION
- NA = NOT APPROVED
- RP = RELEASED FOR PROCUREMENT OF MATERIALS ONLY
- RR = REVISE & RESUBMIT

BY Paul Bay DATE 8/27/97

# SAFETY SUMMARY

Operators and service personnel must be aware of all hazards associated with this equipment. They must know how to recognize hazardous and potentially hazardous conditions, and know how to avoid them. The consequences of unskilled, improper, or careless operation of the equipment can be serious. This product must only be operated and maintained by trained personnel. Every operator or service person must read and thoroughly understand operation/maintenance manuals and any additional information provided by Varian. All warnings and cautions should be read carefully and strictly observed. Address any safety, operation, and/or maintenance questions to your nearest Varian office.

The following format is used in this manual to call attention to hazards:

## WARNING

Warnings are used when failure to observe instructions or precautions could result in injury or death.

## CAUTION

Cautions are used when failure to observe instructions could result in damage to equipment, whether Varian-supplied or other associated equipment.

## NOTE

Information to aid the operator in obtaining the best performance from the equipment.

## 1-1 General

Varian VacIon *Plus* pumps operate in the vacuum range from  $10^{-2}$  to below  $10^{-11}$  Torr (mbar).

The VacIon *Plus* 500 pump (see Fig. 1-1) is suitable for a variety of applications, such as particle accelerators, MBE mass spectrometers and general purpose UHV. They feature high pumping speed for getterable gases, pumping stability for noble gases, and low leakage current.

Varian also provides high voltage coil units with current and pressure indication.

The pump heater option is integrated into the pump/magnet assemblies without changing exterior dimensions.

A unique, non-evaporable getter (NEG) option provides an extra margin of pumping, in order to achieve superior vacuum levels in the UHV range.

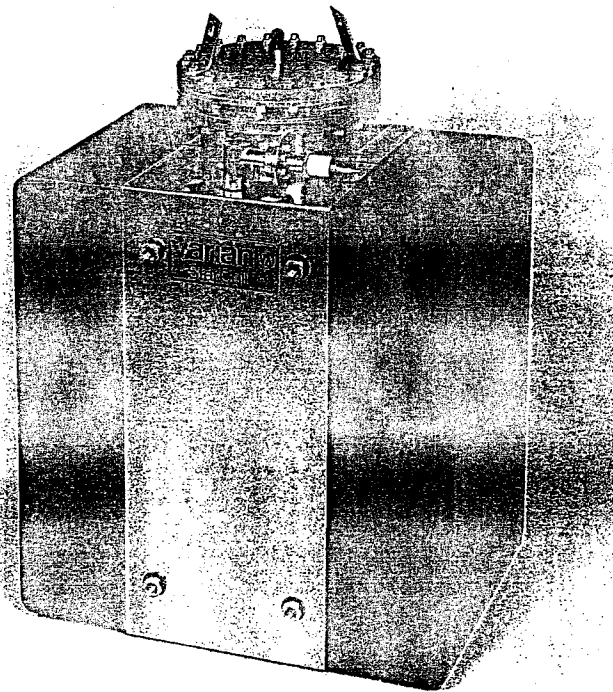

Fig 1-1 - VacIon Plus 500 pump

## 1-2 Specifications

Figures 1-2, 1-3, 1-6, 1-7, 1-10, 1-11 and 1-14 show the pumping speed vs pressure diagrams for saturated and unsaturated pumps.

Figures 1-4, 1-5, 1-8, 1-9, 1-12, 1-13, 1-15, 1-16 show the pressure vs current diagrams. The diagrams are for pumps controlled by means of a MultiVac controller.

### NOTE

The steps on the diagrams are characteristic of the MultiVac step operation: steps occur whenever the current reaches a value at which the MultiVac controller output varies.

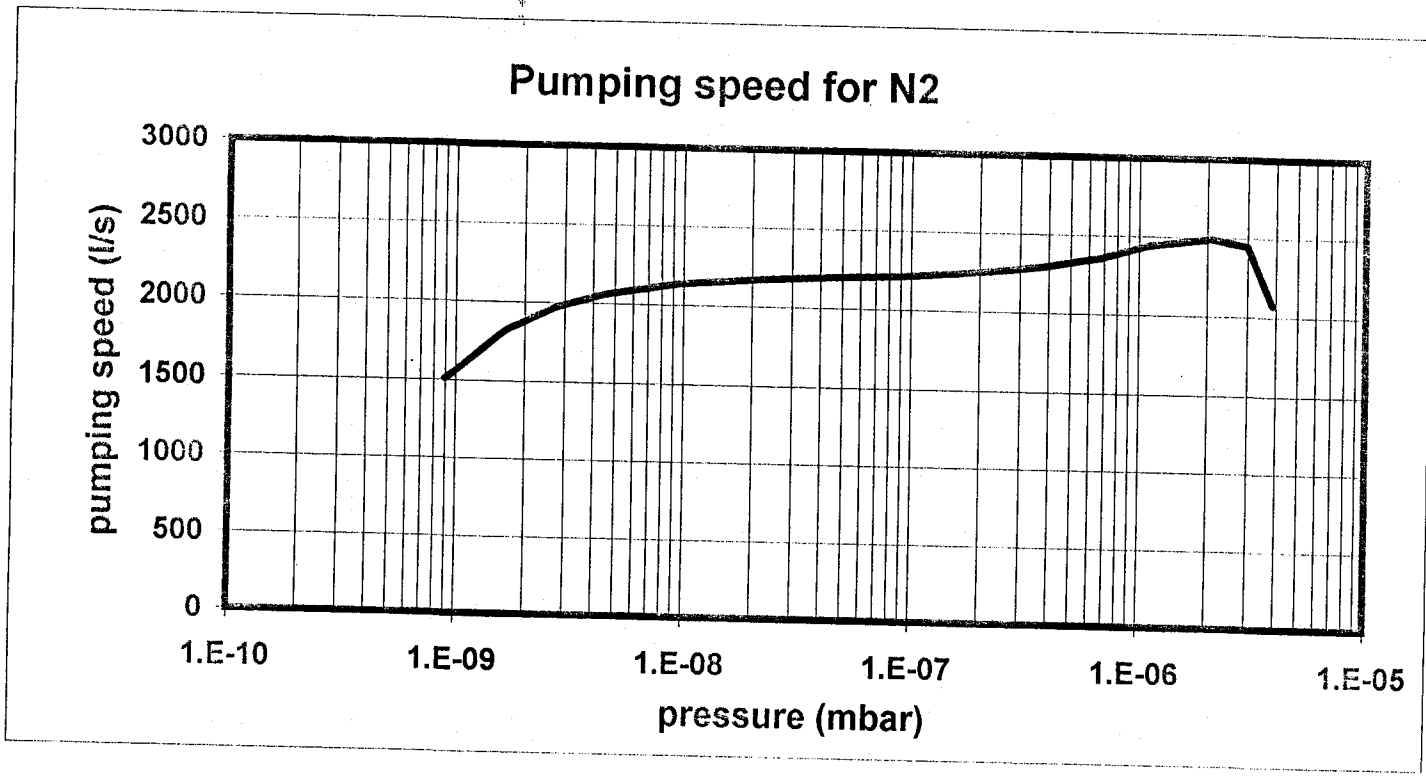

Fig 1- Pumping speed for N2 saturated



Current vs pressure for 2500 L/S ion pump  
( 20 elements )

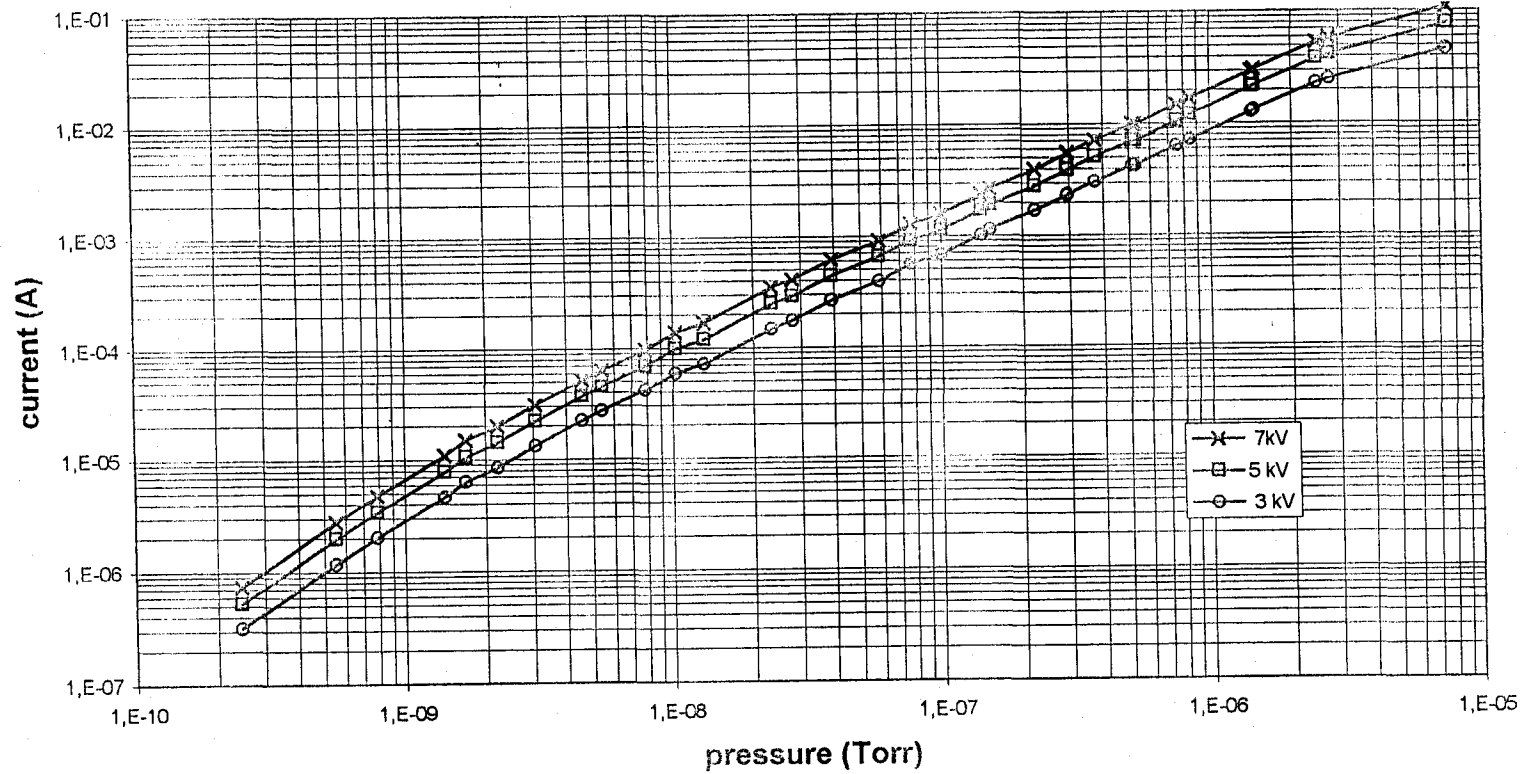
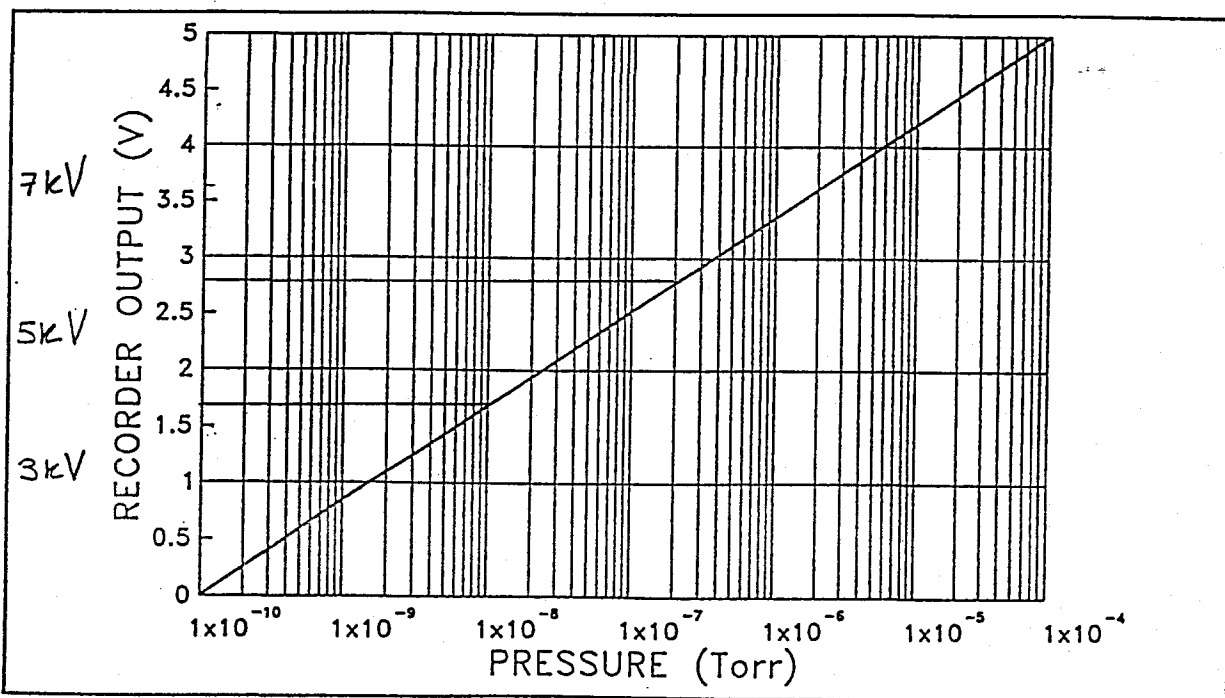
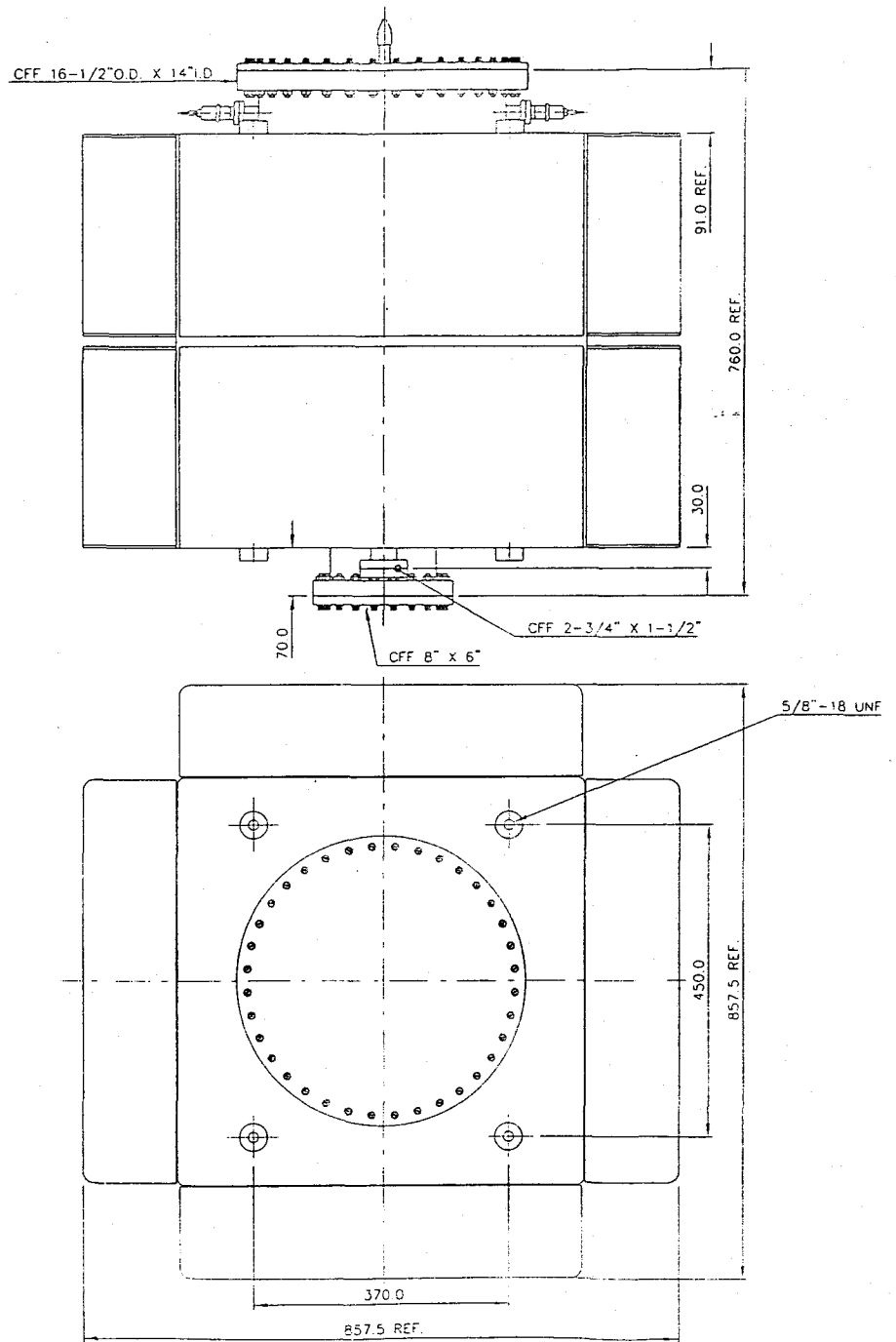

Fig. 2 Voltage change: 3-5 kV at  $1 \times 10^{-8}$  Torr, 5-7 kV at  $2 \times 10^{-7}$  Torr



Recorder output

# OUTLINE DRAWING



## VacIon Plus 2500 ( Noble diode) Specification

Nominal pumping speed (l/s)	2500
Operating life at $1 \times 10^{-6}$ mbar (hours)	40000
Operating Voltage (maximum)	+ 7000 Vdc +/- 10%
Maximum starting pressure (mbar)	$\leq 1 \times 10^{-4}$
Ultimate pressure (mbar)	Below $10^{-10}$
Inlet flange	CFF 16,5" O.D. x 14" I . D.
Maximum baking temperature	300 °C
Material:	
Body	AISI 304 SST
Cathode	Titanium/Tantalum
Anode	AISI 304 SST
Magnet	Ferrite
Net Weight , lbs (kg)	1212 (550)

## 2-1 Inspection procedure

VacIon *Plus* pumps are baked out, sealed, leak-checked and evacuated to the  $1 \times 10^{-10}$  Torr (mbar) range prior to shipping.

The following information and procedures can be used to establish the vacuum integrity of a VacIon *Plus* pump before installation.

### 2-1.1 Visual inspection

Inspect the pump and magnet for physical damage which may have occurred during shipment. Examine, in particular, the brazed joints on the high voltage feedthrough.

#### WARNING

The pinch-off seal is extremely sharp. Be careful.

A VacIon *Plus* pump that has been exposed to atmosphere during shipment, or while in storage, will operate properly if it has not been damaged.

The pump is not harmed by atmospheric exposure, although it is good practice to keep it under vacuum when not in use to exclude dust and the accumulation of water vapour from the environment.

### 2-1.2 Vacuum evaluation

To determine the vacuum level of the unopened pump:

- a) Connect the pump to the control unit as directed in the instruction manual of the control unit.

#### WARNING

The high voltage which is present in the ion pump when it is powered from the power unit can cause severe injury or death.

Be sure the garter spring is mounted on the high voltage feedthrough because the ground connection is brought from the control unit to the pump body through the garter spring. An additional safety ground connection for the pump body is made through the fixing screws of the H.V. cable connector.

- b) With the main power switch in the OFF position, plug the control unit into suitable power source.
- c) Turn the power to ON.
- d) Observe the reading for an indication of one of the following conditions:
  - 1) If the pump is free of leaks and is at a low pressure, the pressure indication shall quickly fall to the  $10^{-8}$  Torr (mbar) range as the volume of gas is pumped.
  - 2) If the pressure inside the pump is at or near atmospheric level, an arc may strike inside the high voltage feedthrough with a popping sound and the pump current will fluctuate. If this occurs, turn the power OFF immediately. Note that pumps at atmosphere may not draw any current.
- e) If the vacuum integrity has been lost, the pump should be leak-checked with a mass spectrometer leak detector before installation on the system.

#### NOTE

To prevent water vapour or dust particles from entering the pump, leave the pinch-off tubulation/tube flange assembly sealed until ready to attach the pump to the vacuum system.

### 2-1.3 Short circuits

If there is a short circuit between the anode and cathodes in the pump, the short-circuit current of the control unit will be drawn and zero voltage will be indicated. If a short circuit exists in the control unit or high voltage cable and connector, zero voltage will also be observed when the high voltage connector is disconnected from the pump (refer to the control unit manuals).

### 2-2 Typical installation

A typical installation is shown in Fig. 2-1 and consists of:

- 1) VacIon Plus pump.
- 2) A Valve to seal off the pump from the rest of the system (if required).
- 3) The control unit.
- 4) A roughing pump.

- 5) A thermocouple gauge capable of indicating pressure from atmosphere to  $10^{-3}$  Torr (mbar) range.
- 6) A valve to seal off the roughing pump from the vacuum chamber. Roughing lines, are usually made of stainless steel or copper tubing, or other low vapour pressure material.
- 7) High voltage cable.
- 8) Baking pump.

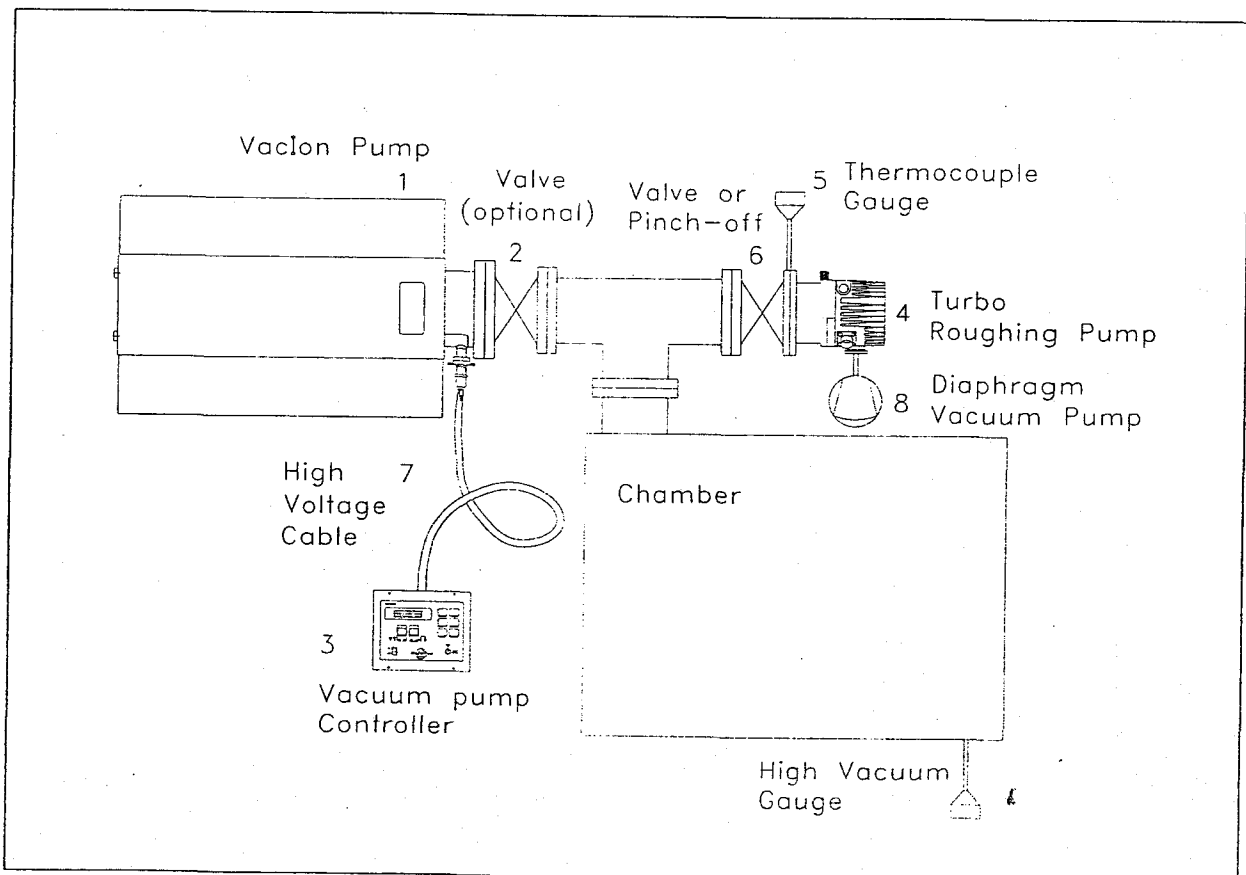

Fig. 2-1 - Typical installation

### 2-3 Pump installation

The pumps can be mounted in any orientation. For mountings other than vertical, the pump should be supported using the mounting feet at the bottom of the pump and the additional 4 mounting feet at the front and backside of the body.

The pump should be kept sealed with its pinch-off tubulation until it is ready for attachment to the vacuum system. This avoids accumulation of dust and other undesirable materials. Before breaking the pinch-off seal, consult the inspection procedure (see paragraph 2-1).

#### CAUTION

Do not open the pinch off-seal with a saw or grinder. These methods will cause metal particles to be drawn into the pump by the inrushing air as the pump is opened.

When ready to install the pump, release the internal vacuum by using pliers to open the copper tube pinch-off (see Fig. 2-2).

#### WARNING

The pinch-off seal is extremely sharp. Be careful when opening. Watch your fingers.

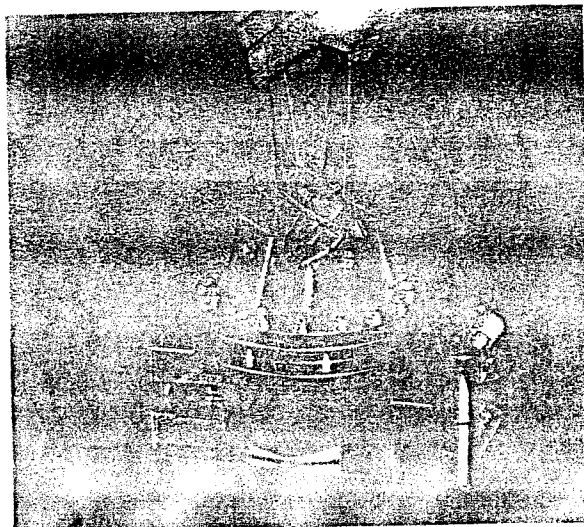

Fig. 2-2 - Opening the copper tube pinch-off

Unscrew the main flange bolts and lift blank flange with the help of a bolt screwed into the threaded hole as shown in Fig. 2-3.

Connect the pump to the vacuum chamber with a short length and large diameter tubulation in order to retain as much of the pumping speed of the pump as possible. Proceed as follows:

- 1) Inspect the mating flanges for cleanliness and absence of scratches on the knife edge.
- 2) Place a new copper gasket between pump flange and vacuum chamber flange.
- 3) Bolt mating flanges of the pump to the chamber with the screws provided with the ion pump. For flanges over NW 35 (2.75" o.d.) also mount washers below the nut and screw head.
- 4) Apply high temperature lubricant to the screw threads. Lubrication simplifies sealing and disassembly. A recommended lubricant is Fel-Pro C-100.

#### NOTE

Lubrication is essential to prevent galling of the nut and screw after bakeout.

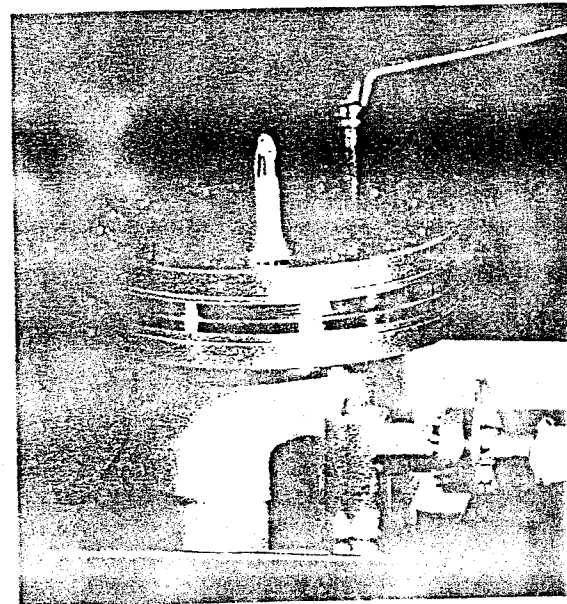

Fig. 2-3 - Removing the blank flange

- 5) Attach the nuts and tighten each one in turn to 4.5 - 8 ft.-lbs (0.6 - 1.1 Kgm) of torque. After tightening a nut, always tighten the opposite nut with respect to the center of the flange. This will partially close the gap between the flange faces.
- 6) Repeat the sequential tightening for two more cycles.
- 7) Continue tightening the bolts until the flange faces meet and a pronounced increase in torque is felt.

Note that it's not possible to fix the screws from lower side, but only from upper side of the flange.

To allow a complete flexibility in the installation, a stud mounting kit is available (see Fig. 2-4). For ordering information please refer to Section V of this manual.

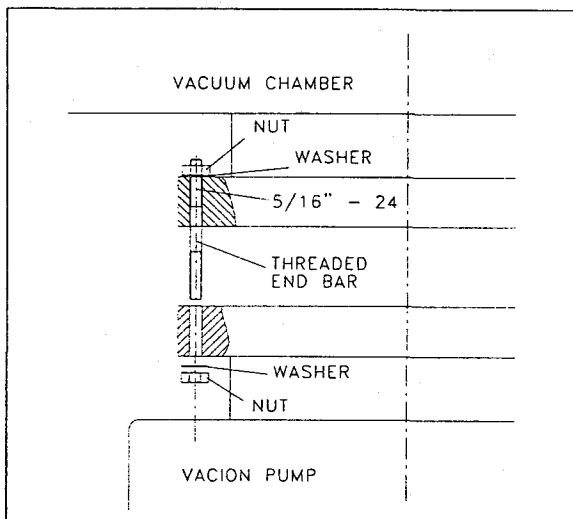

Fig. 2-4 - Flange connection by means of the stud mounting kit

## 2-4 Control unit connection

### WARNING

The high voltage present in the high voltage cable which connects the control unit to the ion pump, can cause severe injury or death. Before mounting the high voltage connector of the cable on the pump high voltage feedthrough, or before removing it, be sure the main power is removed from the control unit.

Connect the control unit to the ion pump with the coaxial high voltage cable assembly as follows:

- 1) Be sure the garter spring is properly mounted on the pump high voltage feedthrough.
- 2) Push the female end of the cable connector over the high voltage feedthrough.
- 3) Lock the connector to the feedthrough brackets with the screws mounted on the high voltage connector.
- 4) Push the male end of the cable connector into the socket on the control unit rear panel. (Refer to the control unit instruction manual).

### WARNING

Before removing the high voltage connector of the cable from the control unit, be sure the main power is removed from the control unit. Wait at least 10 seconds after removing the main power from the control unit, to allow capacitors to discharge completely.

To disconnect the coaxial high voltage cable assembly slide away the safety sleeve (very little sleeve travel is required) from the control unit and at the same time pull on the male end of the cable connector to remove the connector from the socket on the control unit.



## 3-1 General

**WARNING**

The high voltage present in the high voltage cable which connects the control unit to the ion pump, can cause severe injury or death. Before mounting the high voltage connector of the cable on the pump high voltage feedthrough, or before removing it, be sure the main power is removed from the control unit.

Before removing the high voltage connector of the cable from the control unit, be sure the main power is removed from the control unit. Wait at least 10 seconds after removing the main power from the control unit, to allow capacitors to discharge completely.

Rough pumping down to  $1 \times 10^{-4}$  Torr (mbar) is recommended for the most rapid starting. Roughing with an oil-sealed mechanical pump is not desirable, but when used, a trap in the roughing line is recommended to reduce pressure due to water vapor and oils from the mechanical pump. Be careful to minimize the time that this pump is open to the system and ion pump, since mechanical pump vapors will start diffusing into the system at pressures below  $1 \times 10^{-1}$  Torr (mbar) and cause contamination. In systems where oils must be completely eliminated, turbopumps or VacSorb roughing pumps should be used. VacIon Plus pumps can also be used in conjunction with titanium sublimation pumping. In these cases, the primary pumping is accomplished to the deposition of a fresh titanium film on a surface once the ion pump has evacuated the system to high vacuum.

Hygroscopic deposits and hydrogen absorption into titanium may cause starting times to increase with age. During exposure to air, the deposits of titanium compound absorb water vapor. In subsequent start ups, pump heating causes release of the water vapor and some previously pumped hydrogen; thus, the starting time may be lengthened.

## 3-2 Operating procedure

Refer to the relevant pump control unit instruction manual and follow the procedure below when operating the pump:

- 1) With a clean roughing pump, establish a roughing pressure of  $1 \times 10^{-2}$  Torr (mbar), or lower in the vacuum system.
- 2) Plug the control unit into a suitable power source and switch the power ON.
- 3) Observe the voltage, current, and roughing pressure. If started at  $1 \times 10^{-2}$  Torr (mbar), a controller voltage of approximately 300 to 400 volts is typical. A current value near the short-circuit current of the control unit could indicate that an unconfined flow discharge exists in the pump and system. A temporary rise in roughing pressure will usually be noticed during any starting procedure.
- 4) Allow the roughing valve to remain open after turning on the ion pump until an adequate starting pressure is reached. If the ion pump voltage drops after closing the roughing valves, reopen the valve for additional rough pumping. As the pressure decreases, the voltage again will rise.
- 5) When the voltage has increased to 2-3 kV, place the control unit in the PROTECT condition. The system is now automatically protected against pressure increases to  $10^{-4}$  Torr (mbar) when the pump is left unattended. If such an increase should occur, the control unit will be turned off automatically.
- 6) Once in high vacuum, the pressure in the pump can also be determined by reading the current and converting this reading to pressure with the appropriate pressure versus current graph shown in figures of chapter 1.

**NOTE**

*The steps on the charts are a characteristic of the MultiVac step voltage operation. When the current drawn by the VacIon pump reaches the determined values, the controller change the high voltage output.*

- 7) When venting the pump, use dry nitrogen. This will avoid water vapor absorption of the pump walls.

### 3-3 Bakeout operation

For operation below  $10^{-8}$  Torr (mbar), it is necessary to bake the system. This is done by heating the pump and all the components in the system.

- 1) Heat the pump body and the system with a bakeout oven unit or heating strips to temperatures between  $150^{\circ}\text{C}$  and  $250^{\circ}\text{C}$  ( $250^{\circ}\text{C}$  is the maximum allowable for most bakeable high voltage cables). This heat is high enough to degas the pump surfaces without damaging the magnet and high voltage connector. Note that the system components must be compatible with the bakeout temperature.
- 2) Leave the pump control unit on and monitor the pressure. It must never increase above  $6.6 \times 10^{-5}$  Torr ( $8.7 \times 10^{-5}$  mbar); if this value is exceeded, turn the bakeout power off and then on again when low pressure is restored.  
To control the heaters and to monitor the high pressure limit during bakeout in automatic mode, an automatically controlled pressure-sensitive relay may be used.
- 3) Bake the VacIon pump and vacuum system for at least four hours. Longer bakeout periods are recommended when the pump has been used with heavy gas loads or when UHV pressure  $10^{-9}$  Torr (mbar) or less is desired.
- 4) As the pump and system cool down to room temperature, a drop in pressure should be observed.

## 4-1 General

VacIon *Plus* pumps are maintenance free. In case of life time expiry or accidental premature failure of the pump, please contact your nearest sales/service office for repair.

The large VacIon *Plus* 500 pumps are designed with pump-elements and high-voltage feedthrough, both exchangeable.

## 4-2 Exchange of pumping element

- 1) Remove the internal high-voltage connections.
- 2) Remove the element holding brackets (see Fig. 4-1).
- 3) Pull the element out of the pocket and remove it through the inlet flange.
- 4) Clean the internal part of the pump with the appropriate solvent.
- 5) Put in the new element through the inlet flange. Make sure that the element is fixed at its rear by the two press-formed buttons of the element pocket, and at its front by the element holding clamp.
- 6) Reattach the high-voltage connections and test for continuity from the feedthrough.

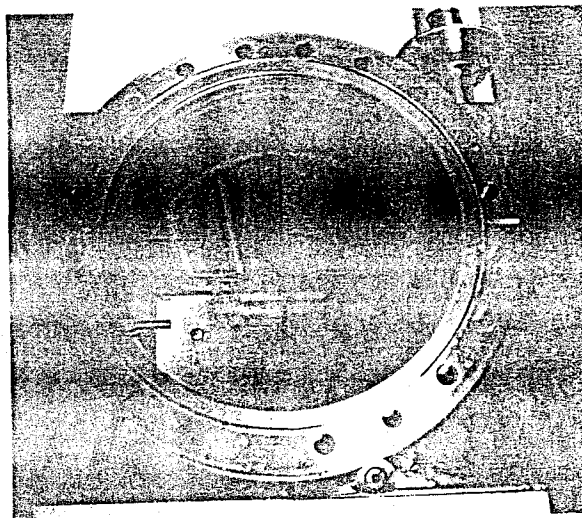

Fig. 4-1 - Inside view of a VacIon *Plus* pump

- 7) Place a blank flange over the pump inlet and leak-check it with a leak detector.
- 8) Bake out the blanked off pump while it is operating, and leave it to cool down; then verify that the base pressure is below  $10^{-9}$  Torr (mbar).

## 4-3 Exchange of the high voltage feedthrough.

- 1) Remove the 6 bolts of the Mini-ConFlat flange connection (see Fig. 4-2).
- 2) Remove the cable connection disc.
- 3) Gently relieve the feedthrough from the metal seal connection and turn the feedthrough counterclockwise until it is completely detached from the internal high voltage threaded connection.
- 4) Replace the feedthrough and the copper gasket.
- 5) Bake out the pump while it is operating and leave it to cool down; then verify that the base pressure is below  $10^{-9}$  Torr (mbar).

## 4-4 Leakage current check

If the pump current reading is to be used as pressure measurement, check the pump leakage currents as follows:

- 1) Turn off the pump control unit.
- 2) Remove the pump magnet.
- 3) Turn on the pump control unit and wait for current stabilization. The current reading should not be higher than  $1 \mu\text{A}$ . Make sure that the control unit and the high voltage cable leakage current is negligible.
- 4) If leakage current comes from the pump, perform the "high-potting"; then recheck the pump and install the magnet.
- 5) If it is not possible to "high-pot" the pump, the pressure reading is biased (the leakage current value).

### 4-5 Hi-potting

A higher than normal pump current when no leak exists is often caused by field emission currents which prevent the use of the pump current as a pressure indicator. To reduce this field emission current, "hi potting" should be performed. "High potting" is the term used to describe the application of higher than normal operating voltage (10-12 KV, 20-50 mA) for the purpose of burning off "whiskers" (sharp edges) on the pump cathode.

The output of an appropriately sized AC transformer (i.e. neon sign type) may be applied to the pump for a period of about 30 seconds. This should effectively remove any "wiskers" or sharp edges on the pump cathode.

#### WARNING

Voltages developed in the High Potter power supply are potentially lethal. Use caution during operation and ensure correct grounding connection.

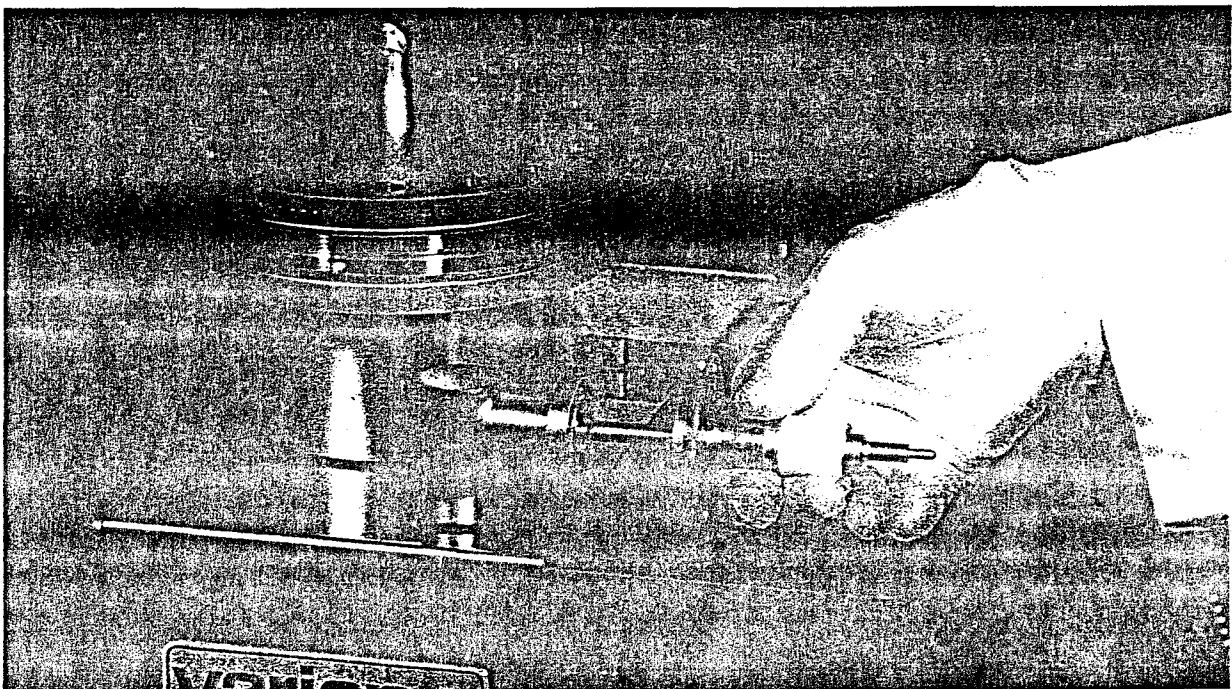

Figure 4-2 - High voltage feedthrough connection

## 4-7 Pump troubleshooting

Symptom	Possible cause	Correction procedure
1) - Slow starting (more than 30 minutes).	<i>Air leaks</i> which limit pressure to above $10^{-6}$ Torr (mbar) and cause longer starting time.	Leak check the vacuum system with a helium leak detector.
2) - Slow pump-down due to long exposure of viton parts to air.	<i>Viton releases considerable gas</i> after long exposure to air. (A bell-jar system which reached $1.5 \times 10^{-8}$ Torr ( $2 \times 10^{-8}$ mbar) in 24 hours after 30 minutes air exposure, will only reach $7.5 \times 10^{-8}$ Torr ( $1 \times 10^{-7}$ mbar) in 24 hours after 20 hours air exposure).	With the system under vacuum, pump for several days, or heat to $100-150^{\circ}\text{C}$ for up to 15 hours.
3) - Slow pump-down due to absorption of vapours on pump and system walls.	<i>Vapours and gases admitted to a system are absorbed</i> on the walls of the system and pump. Subsequent reduction in pressure depends on the rate of depletion of this vapour. Heavy hydrocarbons are most troublesome because of their relative low vapour pressure.	Heat the system walls,, thereby accelerating the desorption process. Baking mobilizes the vapours so they can be cracked and pumped by discharge.
4) - Slow starting or slow pump-down.	High voltage feedthrough is leaking.	Replace the feedthrough.
5) - Current higher than expected at any given pressure.	Ion pump leakage current causing higher pressure reading.	Highpot the pump.

5-2 Vaclon Plus 500 pump controllers

	Part Number			
	StarCell	Triode	Noble Diode	Diode
<b>MultiVac controller</b>				
Base unit with one HV card (120V) (220V)	929-6000 (negative polarity); 929-6004 (positive polarity) 929-6008 (negative polarity); 929-6012 (positive polarity)			
Base unit with two HV card (120V) (220V)	929-6001 (negative polarity); 929-6005 (positive polarity) 929-6009 (negative polarity); 929-6013 (positive polarity)			
Large Vaclon Plus HV card	929-4040	929-4040	929-4050	929-4050
Set Point/Remote Control	929-4110			
RS 232/422 Interface	929-4100			
Base unit with RS 232/422 Interface mounted and one HV card (120V) (220V)	929-6002 (negative polarity); 929-6006 (positive polarity) 929-6010 (negative polarity); 929-6014 (positive polarity)			
Base unit with RS 232/422 Interface mounted and two HV card (120V) (220V)	929-6003 (negative polarity); 929-6007 (positive polarity) 929-6011 (negative polarity); 929-6015 (positive polarity)			
<b>MiniVac controller</b>				
MiniVac (120V) (220V) (24Vdc)	929-0191 929-0290 929-0196			
MiniLink (120V) (220V)	929-0300 929-0301			

For a complete overview of Varian's extensive vacuum product line, please refer to the Varian Vacuum Catalogue.

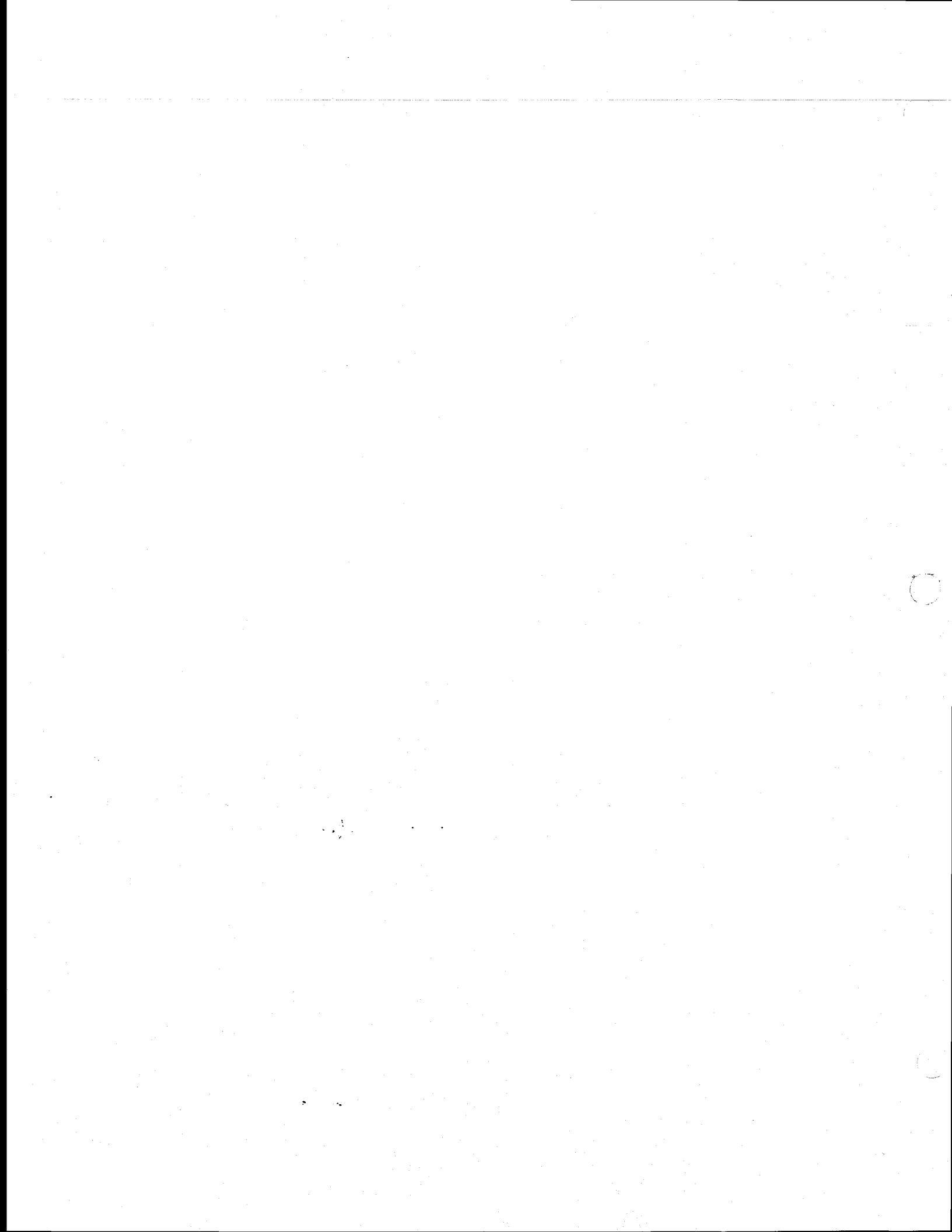

**Varian S.p.A. - Vacuum Products Torino**  
**Via Varian 54**  
**10040 Leini (Torino) - Italy**

**Varian Vacuum Products Lexington**  
**121 Hartwell Avenue**  
**Lexington, Massachusetts 02173 - USA**

**FRANCE**

Varian s.a.  
7, Avenue des Tropiques  
Z.A. de Courtaboeuf B.P.12  
F91941 Les Ulis Cedex - France  
Telephone: (33) 1 69863884  
Fax: (33) 1 69282308

**INDIA**

Varian International AG  
605-606, Vishwadeep. Towers, 4  
District Centre, Janakpuri,  
New Delhi - 110058 - India  
Telephone: (011) 5611442  
Fax: (011) 5524317

**USA, SOUTH & CENTRAL AMERICA**

Varian Vacuum Products  
121 Hartwell Avenue  
Lexington, MA 02173 - USA  
Telephone: (617) 8617200  
Fax: (617) 8605437  
Toll free: 1 800 8827426

**GERMANY, AUSTRIA**

Varian GmbH - Vacuum Products  
Alsfelder Strasse 6  
Postfach 11 14 35  
64289 Darmstadt - Germany  
Telephone: (49) 6151703353  
Fax: (49) 6151703302

**KOREA**

Varian Korea Ltd.  
433-1 Mogok-Dong  
Pyungtaek, Kyungki-Do - Korea  
Telephone: (82) 333 6107227  
Fax: (82) 333 6650115

**CANADA**

Varian Canada Inc.  
6705 Millcreek Drive, Unit 5  
Mississauga, Ontario L5N 5R9  
Canada  
Telephone: (905) 8198188  
Fax: (905) 8198348  
Toll free: 1 800 6632727

**GREAT BRITAIN**

Varian Ltd.  
28 Manor Road  
Walton on Thames  
Surrey KT12 2QF - Great Britain  
Telephone: (44) 1932 898000  
Fax: (44) 1932 228769

**JAPAN**

Varian Japan Ltd.  
Sumitomo Shibaura Bldg.  
4-16-36 Shibaura Minato ku  
Tokyo 108 - Japan  
Telephone: (81) 352321211  
Fax: (81) 352321263

**AUSTRALIA**

Varian Australia Pty Ltd.  
6/81 Frenchs Forest Road  
Frenchs Forest NSW 2086  
Australia  
Telephone: (61) 924519133  
Fax: (61) 924522600

**ITALY**

Varian S.p.A. - VP Sales Office  
Via Varian 54  
10040 Leini (Torino) - Italy  
Telephone: (39) 11 9979111  
Fax: (39) 11 9979344

**ASIAN COUNTRIES**

Varian Pacific Inc.  
Rm. 1018-20 Tower A  
New Mandarin Plaza  
14 Science Museum Road  
Tsimshatsui East, Kowloon  
Hong Kong  
Telephone: (852) 27242836  
Fax: (852) 23694280

**OTHER COUNTRIES**

Varian S.p.A. - VP Sales office  
Via Varian 54  
10040 Leini (Torino) - Italy  
Telephone: (39) 11 9979111  
Fax: (39) 11 9979344



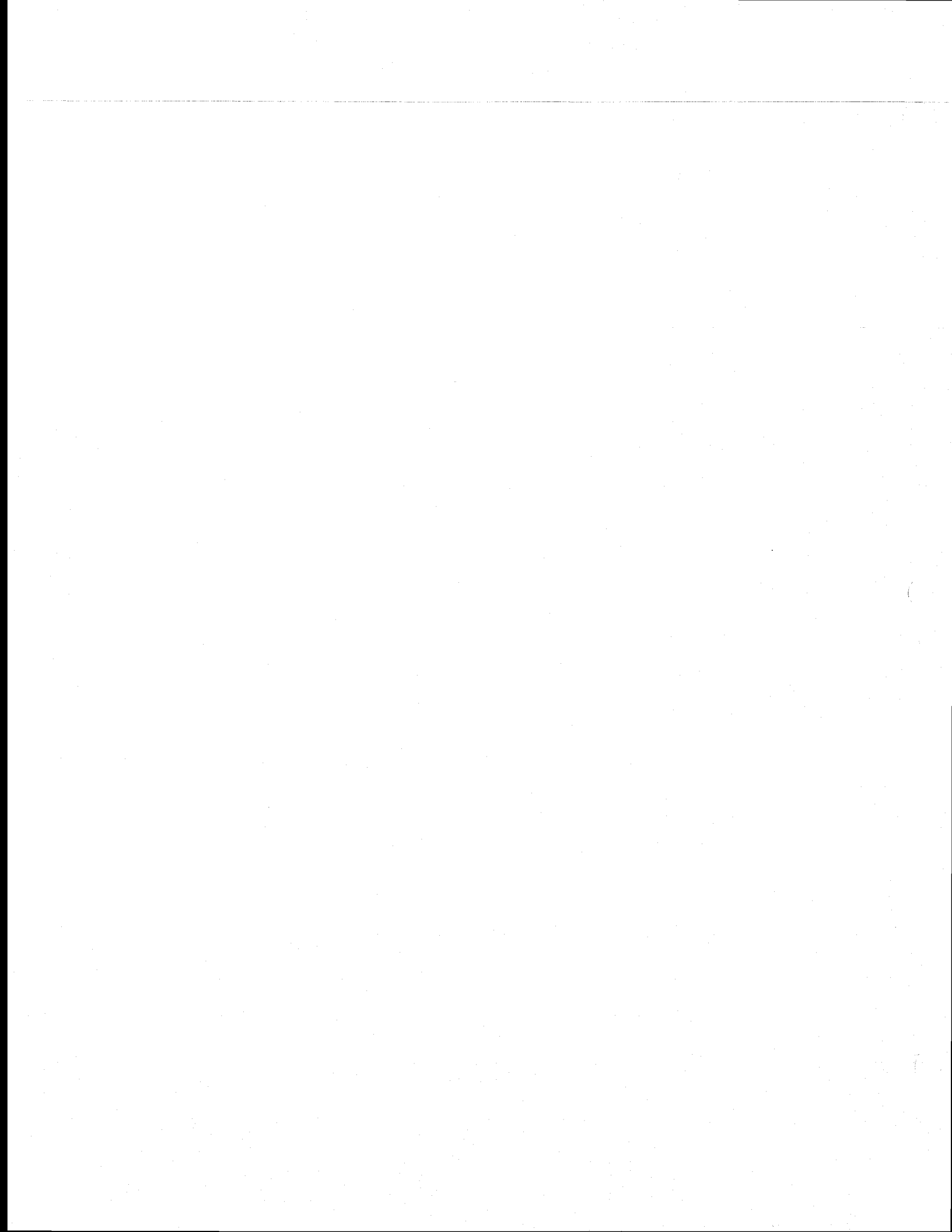

**varian** 

*vacuum products*

Varian S.p.A., Via Varian 54, 10040, Leini' (Torino), Italy

**F A X M E S S A G E**

DATE: 08/07/97 TIME: 4:58 PM  
TO: Jim Mcharg PHONE:  
FAX:  
FROM: Miriam Spagnol PHONE: 011 9979111  
VARIAN VPT FAX: 011 9979350  
RE: Current curve and voltage output  
CC:

---

Jim,

here attached you can find the Recorder output curve, which is the same as for the other pump. The difference is the current value at which you have the voltage change from 3 to 5 kV and from 5 to 7 kV; the pressure of this change is always the same.

PSI should work in stepvoltage, so

0-1.7 volt = 3000 kV

1.7-2.8 volt = 5000 KV

2.8 -5 = 7000 KV

The current value at which you have this change are indicated on the curve that Mauro provide you at a pressure of:

3 to 5 kV at 1e-8 Torr

5 to 7kV at 2e-7 Torr

Let me know if it is what you need.

Miriam Spagnol

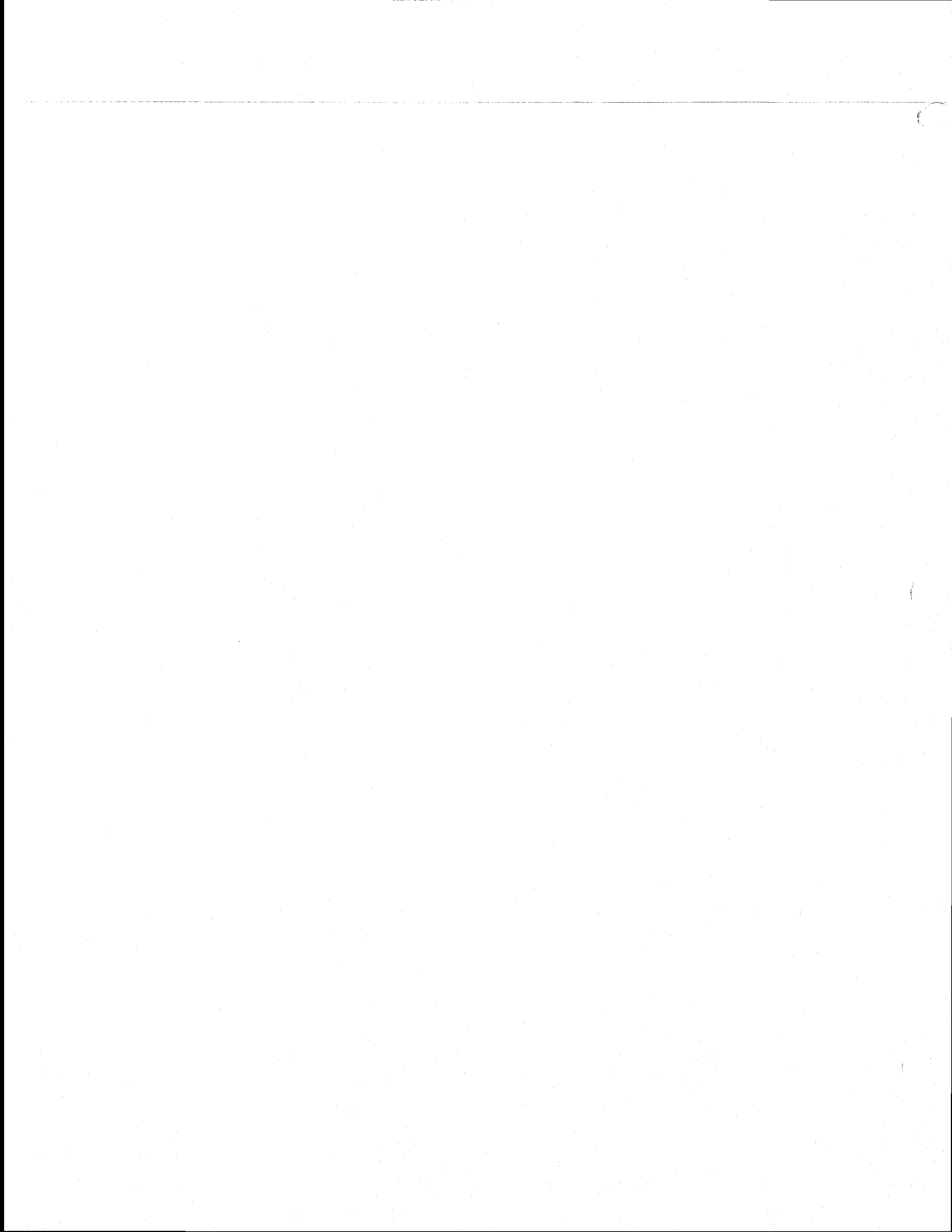

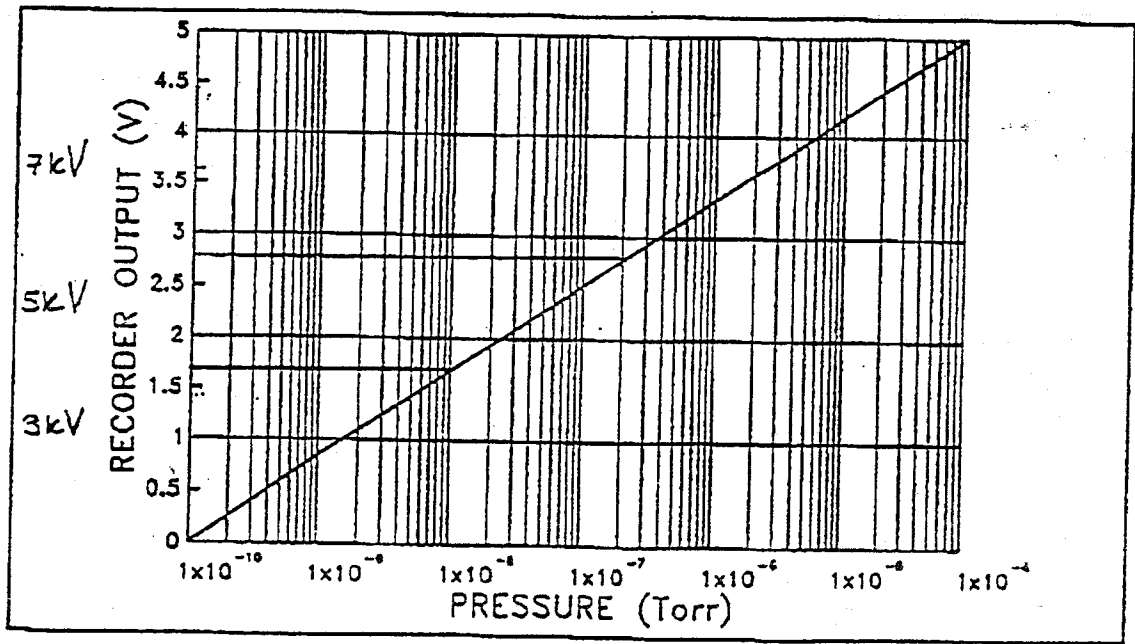

*Recorder output*



Current vs pressure for 2500 L/S ion pump  
(20 elements)

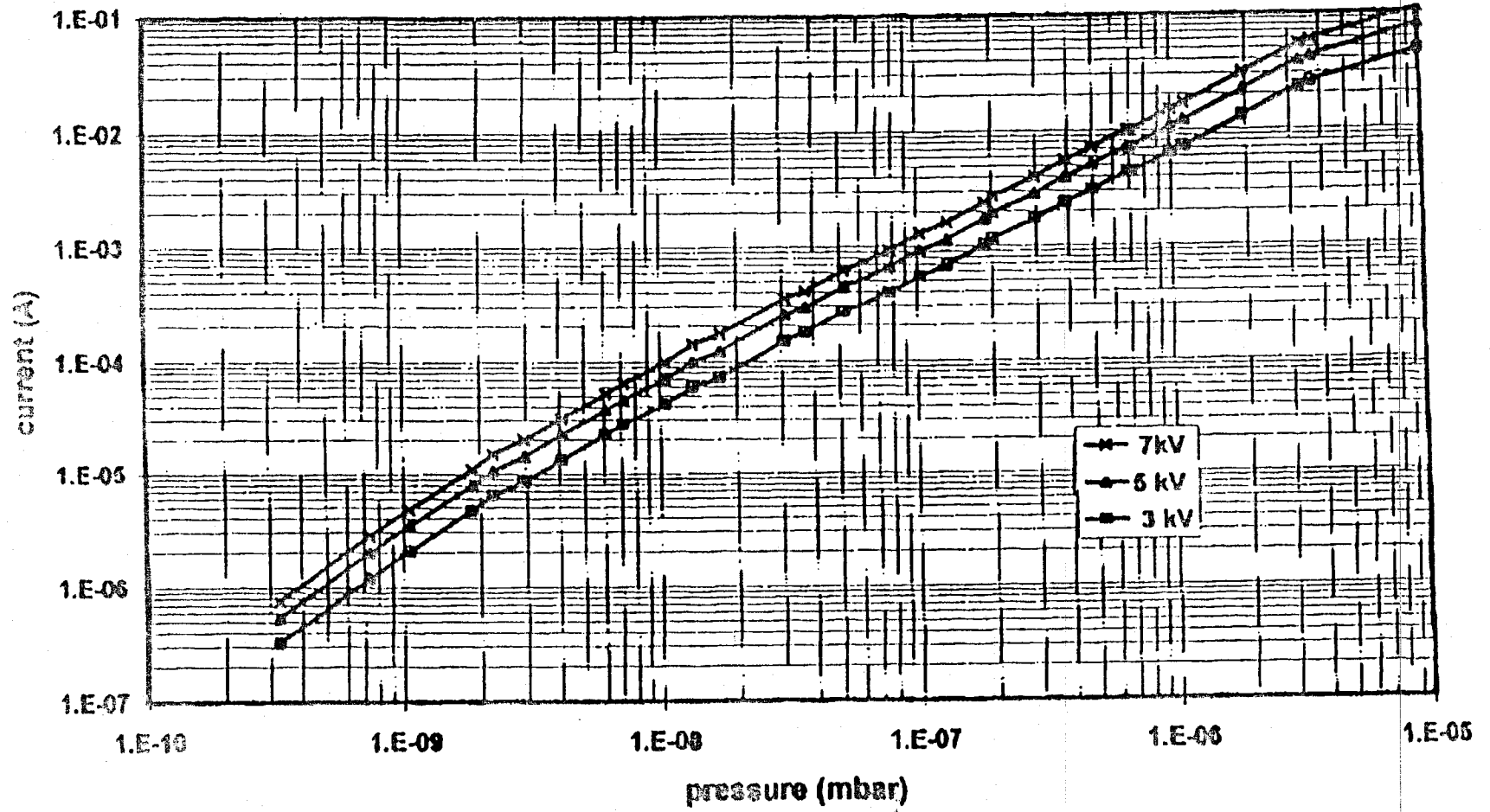

6

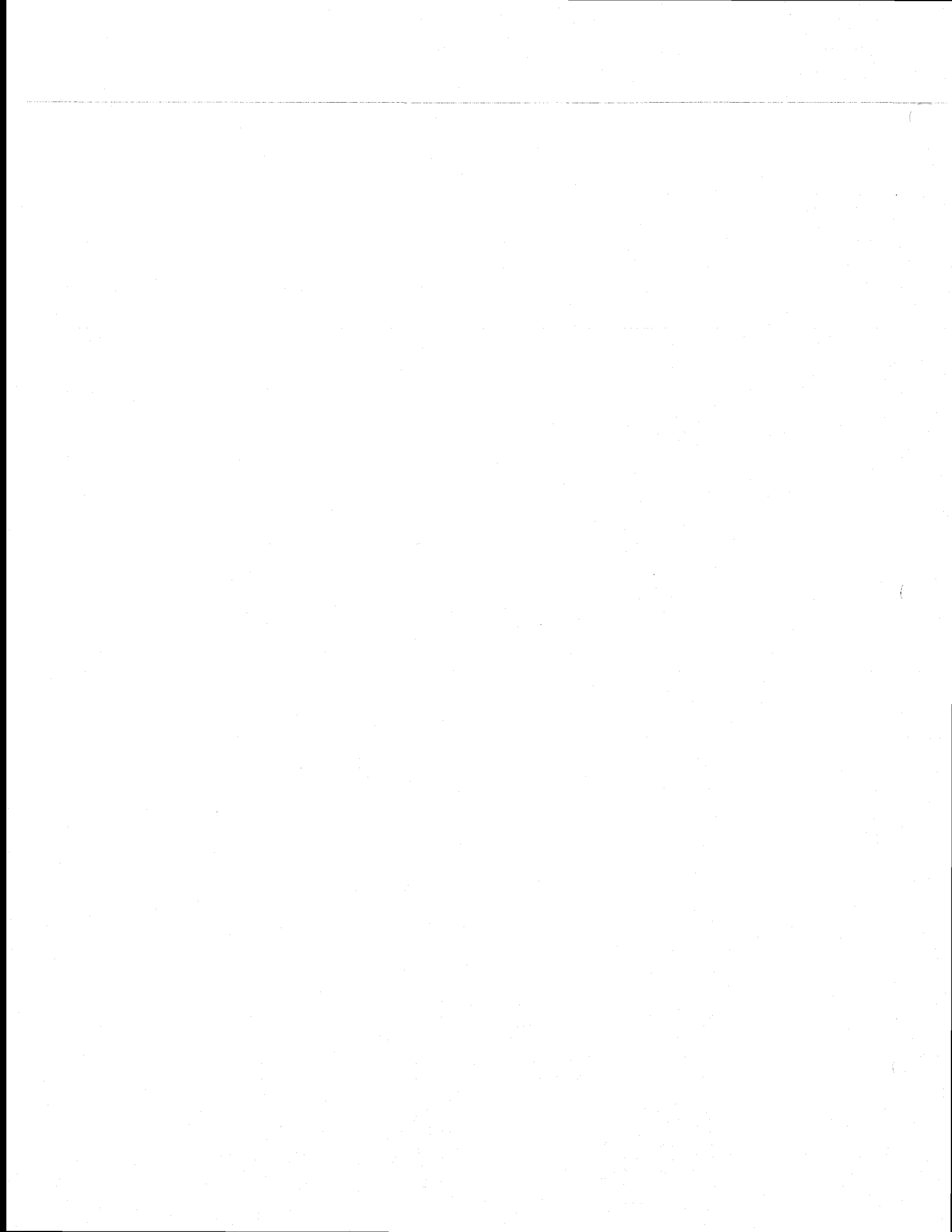

# STD MANUAL

## TECHNICAL INFORMATION

**Note 1:**

When this page is displayed the operator should store the pressure value corresponding to the pump current of 100 nA with 5000 V applied on the pump in use. Store the pressure value for other three pump current values (10  $\mu$ A, 10 mA, 400 mA).

Storing these values allows the MultiVac to convert the pump current into pressure values even if the operating voltage is different from 5000 V.

The correction factor due to the different voltage is automatically applied by the MultiVac software in order to obtain a continuous correct pressure reading.

Note that some pressure values are stored by default.

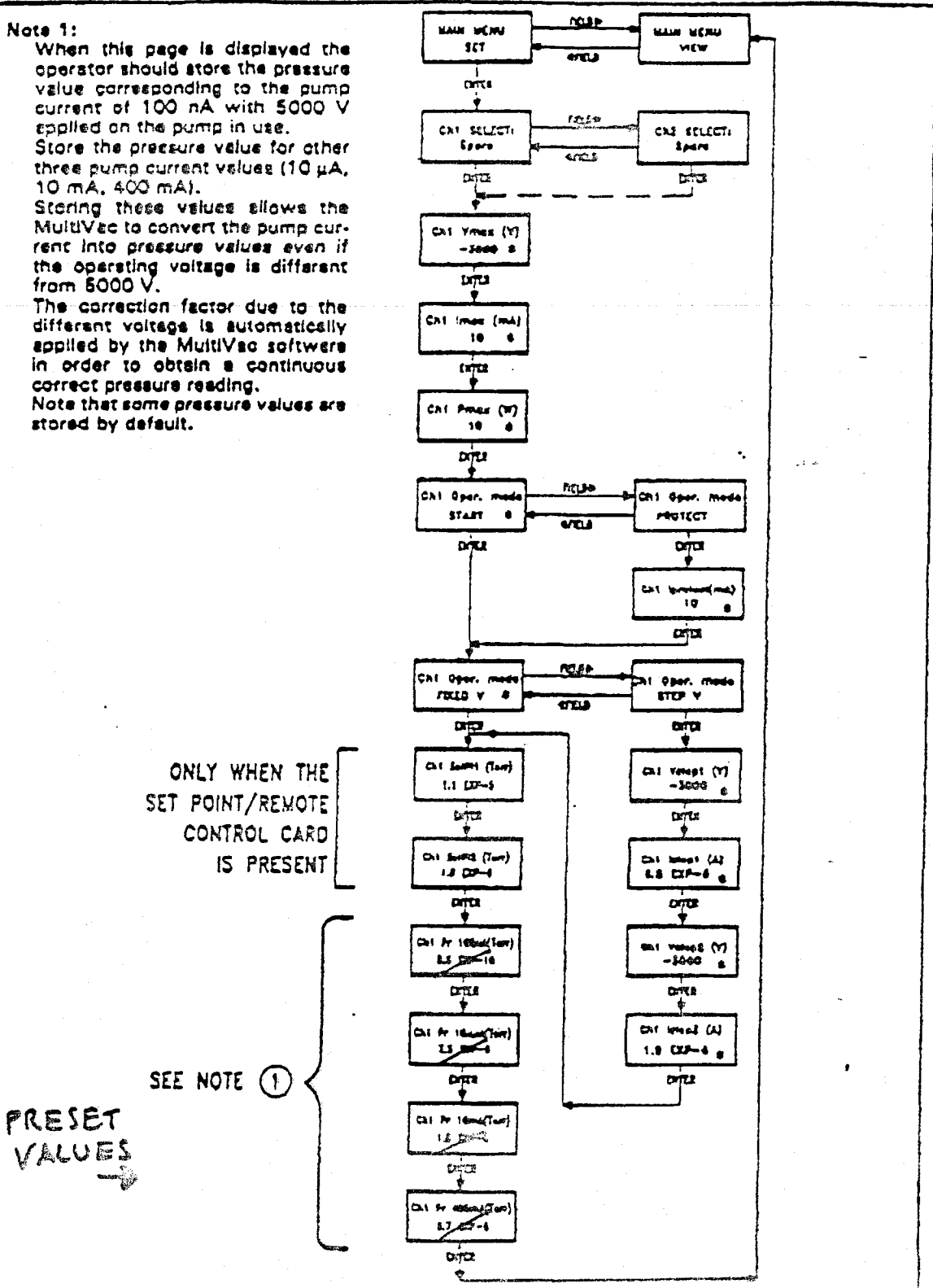

Flow 7 - Spare pump parameters setting

4



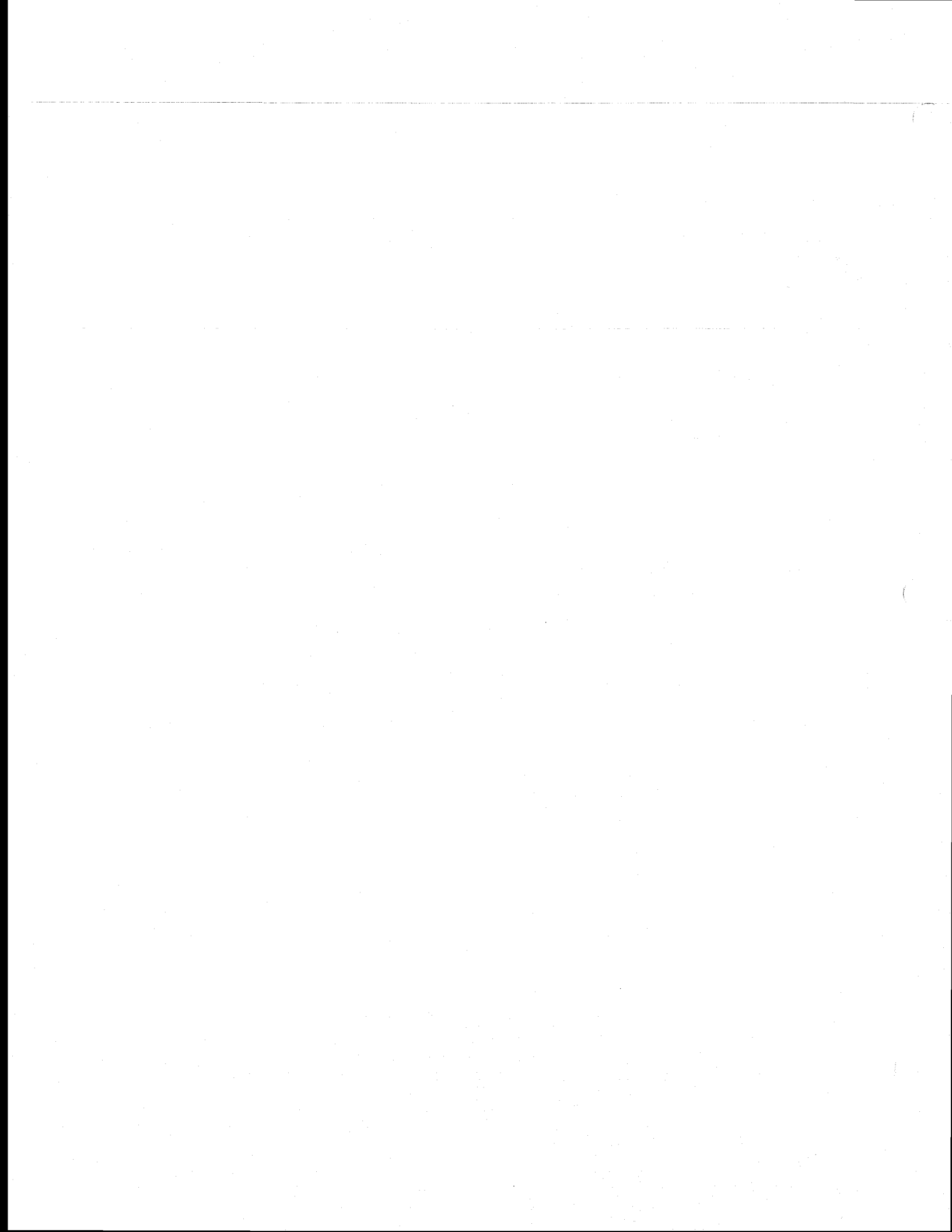

SEE NOTE (1)

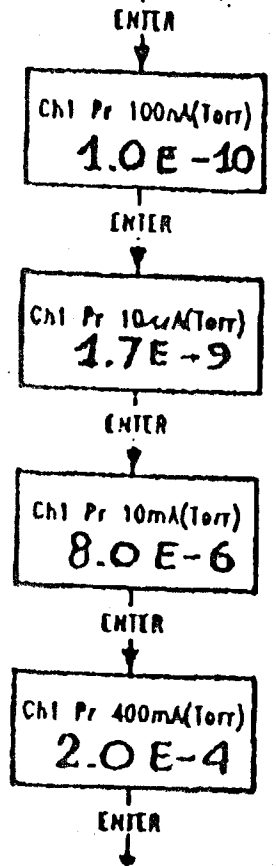

2500 L/S PUMP  
VALUES  
(FOR 20 ELEMENTS)

(5)

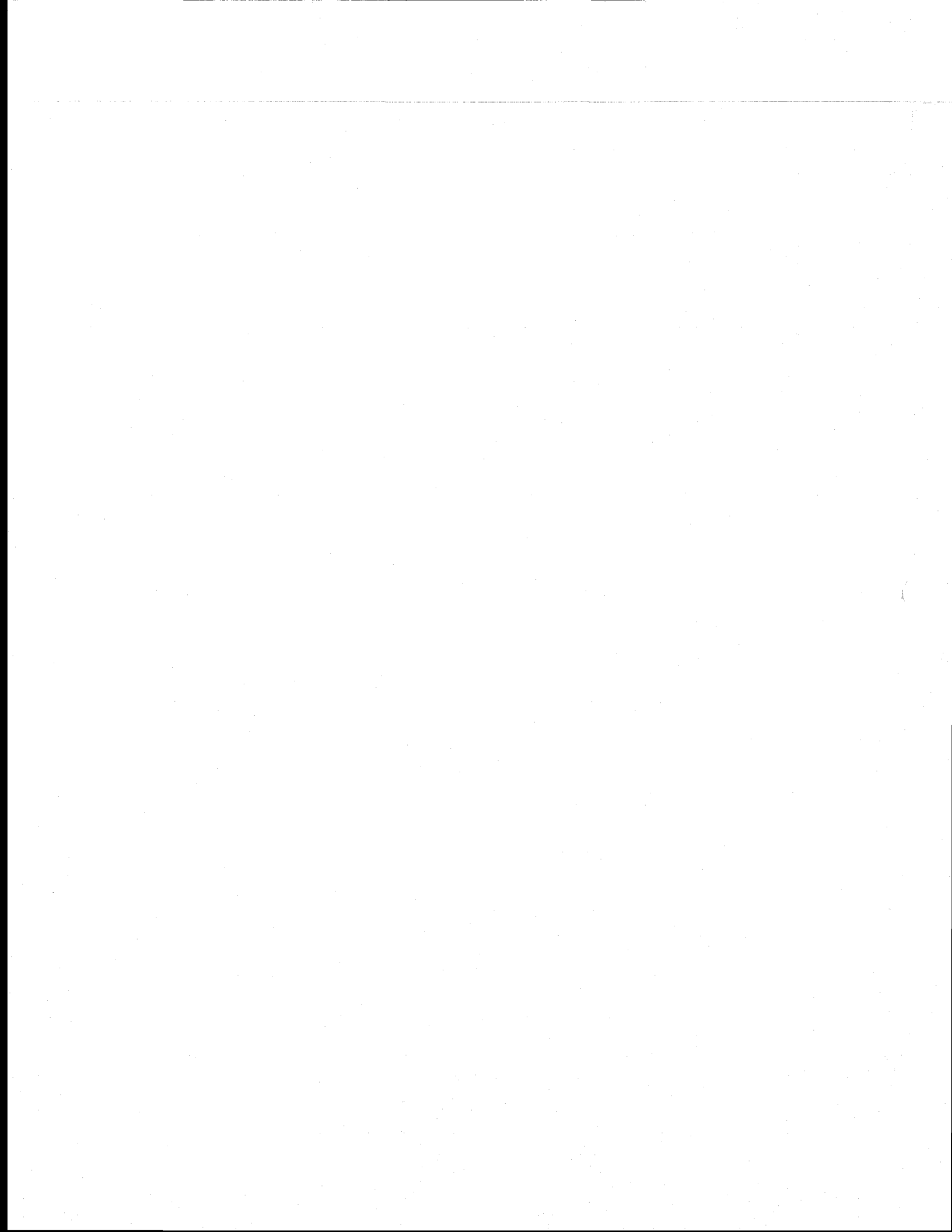

ADDENDUM TO INSTRUCTION MANUAL P/N 87.900.061.01

Please take note of the following change in section 2.4 page 2-5

2.4 RECORDER OUTPUT CONNECTION

An external analog recorder can be connected to the recorder output connector J1 (Fig. 2-9): PIN3 (GROUND) and PIN1 (POSITIVE) for Ion Pump Pressure (0 ÷ 5 V LOG); PIN3 (GROUND) and PIN5 (POSITIVE) for Ion Pump Voltage (0 ÷ 3.9 V LINEAR ; see table 1).

Taking care that the minimum recorder input impedance should be 10 MOHM.

TABLE 1

<u>ION PUMP HIGH VOLTAGE</u>	<u>OUTPUT RECORDER</u>
3000 V	1.16 V
5000 V	1.96 V
6000 V	2.35 V
7000 V	2.75 V

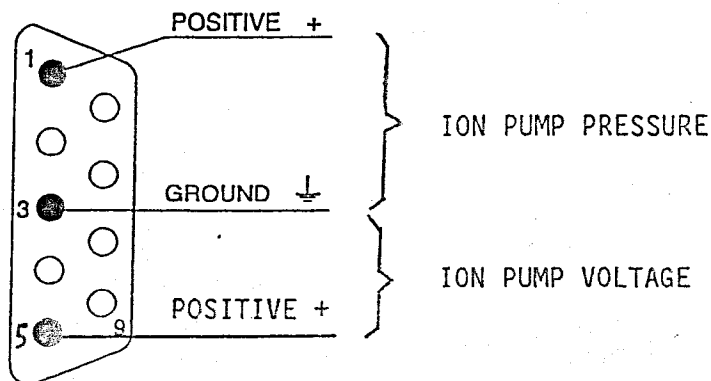
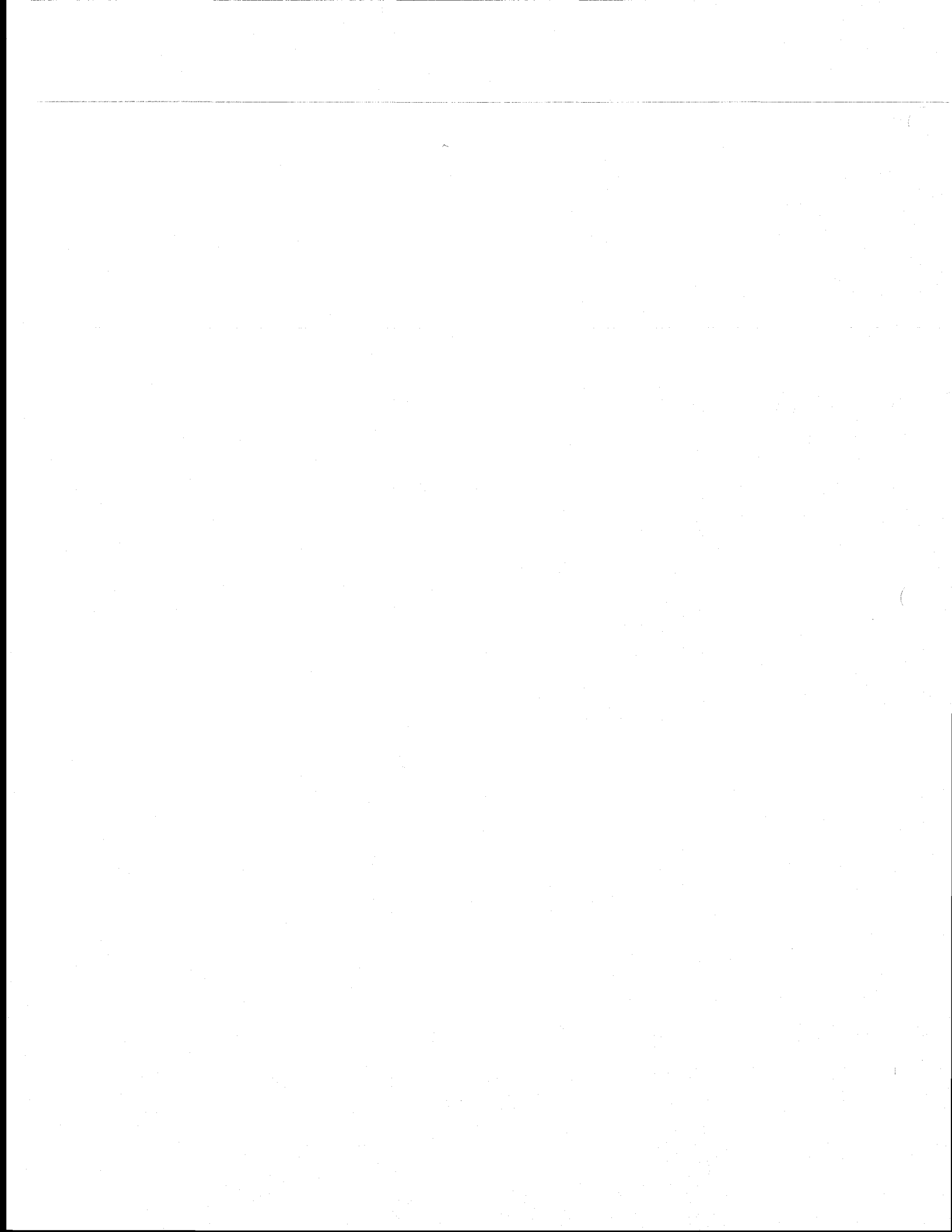

Figure 2-9 - Recorder output connection



**87-900-065-01**

**May 1994**

# **Instruction Manual**

## **Set Point/Remote Control card**

**Model 929-4110**

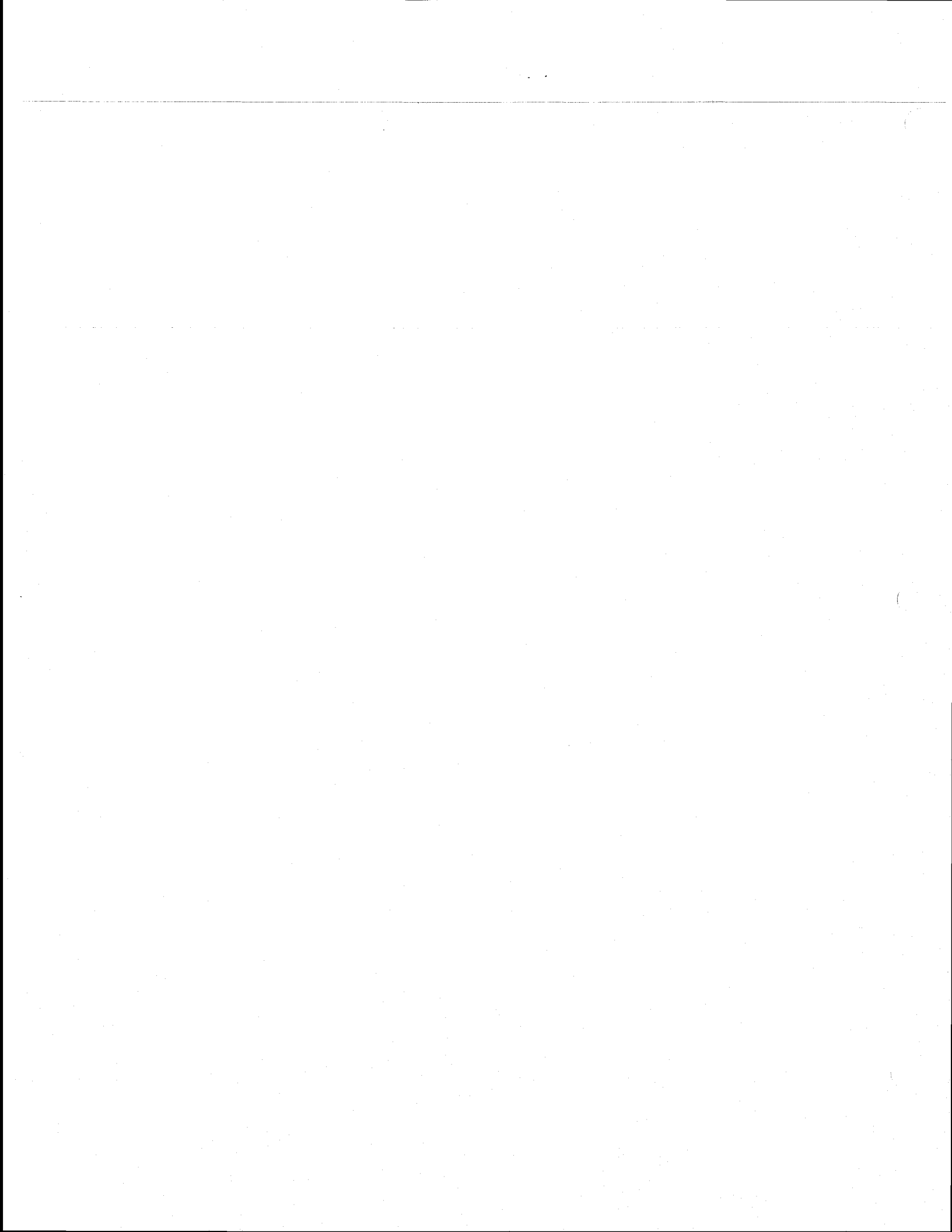

# Table of Contents

Section		Page
-	<b>Safety summary</b>	ii
<hr/>		
<b>I</b>	<b>Description</b>	
<hr/>		
1-1	General . . . . .	.1-1
1-2	Set Point/Remote Control card description . . . . .	.1-2
<hr/>		
<b>II</b>	<b>Installation</b>	
<hr/>		
2-1	General . . . . .	.2-1
2-2	Card Installation . . . . .	.2-1
2-3	Input/Output connector . . . . .	.2-1
2-4	Connection example . . . . .	.2-1
<hr/>		
<b>III</b>	<b>Operation</b>	
<hr/>		
3-1	General . . . . .	.3-1
3-2	Output description . . . . .	.3-1
3-3	Input description . . . . .	.3-2
<hr/>		
<b>IV</b>	<b>Maintenance &amp; Spare parts</b>	
<hr/>		
4-1	General . . . . .	.4-1
4-2	No communication with the card . . . . .	.4-1



# SAFETY SUMMARY

Operators and service personnel must be aware of all hazards associated with this equipment. They must know how to recognize hazardous and potentially hazardous conditions, and know how to avoid them. The consequences of unskilled, improper, or careless operation of the equipment can be serious. This product must only be operated and maintained by trained personnel. Every operator or service person must read and thoroughly understand operation/maintenance manuals and any additional information provided by Varian. All warnings and cautions should be read carefully and strictly observed. Address any safety, operation, and/or maintenance questions to your nearest Varian office.

The following format is used in this manual to call attention to hazards:

## WARNING

**Warnings are used when failure to observe instructions or precautions could result in injury or death.**

## CAUTION

**Cautions are used when failure to observe instructions could result in damage to equipment, whether Varian-supplied or other associated equipment.**

## NOTE

*Information to aid the operator in obtaining the best performance from the equipment.*

### 1-1 General

The Set Point/Remote Control card (Fig. 1-1) is an optional card that can be added to the Varian's MultiVac controller to provide to the user eight input and eight output for each H.V. card.

The card consists of two printed circuit boards (called "base board" and "expansion board") interconnected between them and with two 37 pin connector for connection with external equipment. Each printed circuit board is dedicated to one H.V. card. The two 37 pin "D" type connectors have exactly the same pin out.

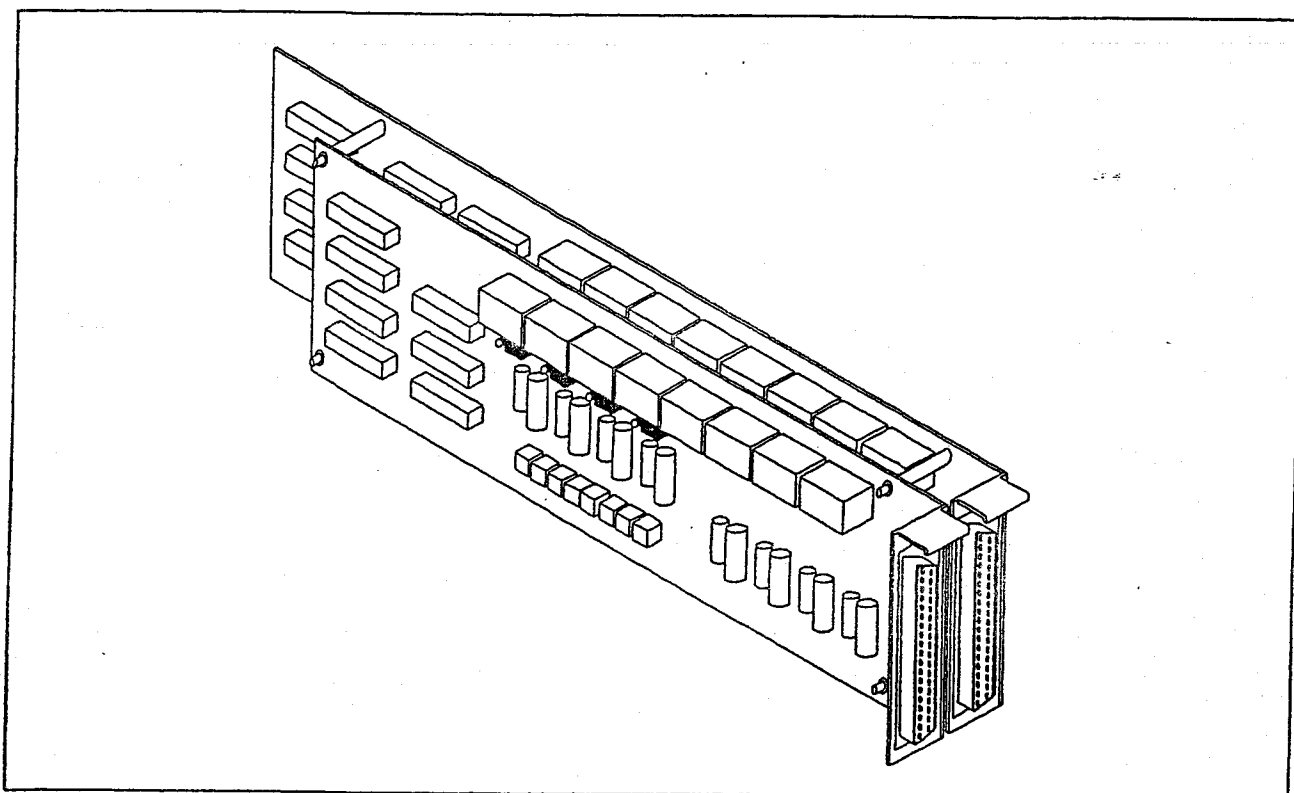

Figure 1-1 - Set Point/Remote Control card

## 1-2 Set Point/Remote Control card description

The card (see Fig. 1-2) is inserted on the base unit bus from which it receives the enabling signals and data, and to which it sends the input data.

The address incoming from the base unit microprocessor board is decoded to select the corresponding register on the base or expansion board. The write signals enable the writing of the output signals on the output register. The read signals enable the reading of one of the two input registers: the first one is dedicated to read-back the output signals, the second one is dedicated to read the input signals from the external.

The output signals are connected to the external connector by means of eight relays activated by the output signals. The normally open and normally closed contacts of relays 5

to 8 are available on the card output connector.

Output signals corresponding to relay 1 to 4 can be taken on the normally open or normally close contacts according to the position of the relevant jumper on the card (W1 to W4). All the jumpers are factory set for normally open contact.

The maximum ratings of the output are the following:

- 0.5 A at 120 Vac or 110 Vdc
- 0.2 A at 250 Vac or 220 Vdc
- 2 A at 30 Vdc.

The inputs are optoisolated and need an external supply (3 to 32 Vdc 20 mA max).

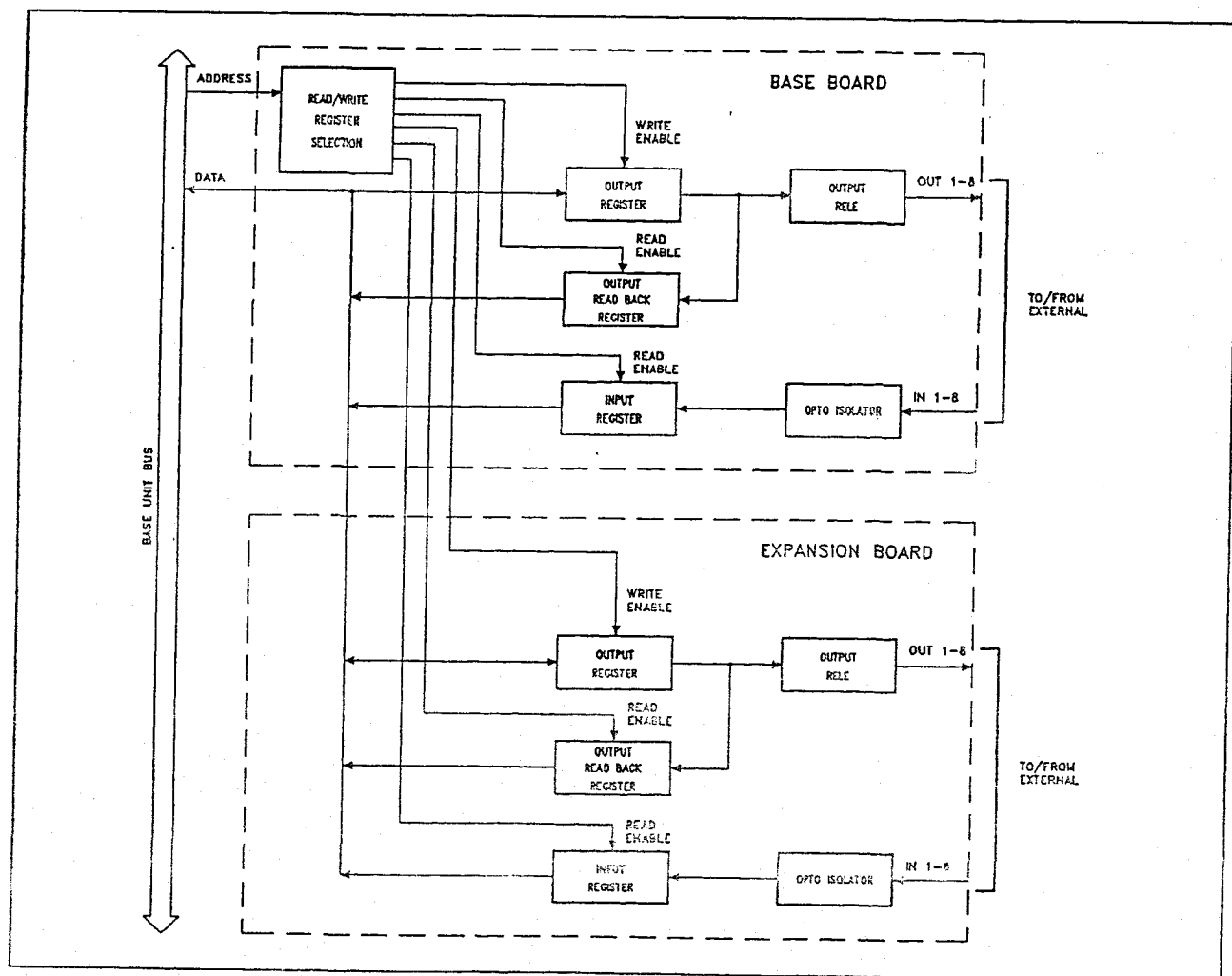

## 2-1 General

Inspect the card for any shipping damage.

### WARNING

High voltage developed in the controller can cause severe injury or death. Before servicing the unit, disconnect the input power cable.

## 2-2 Card Installation

- Open the unit by removing the four screws (1) aside of the unit (see Fig. 2-1)
- Carefully insert the card into its slot (see Fig. 2-2)

### NOTE

*During installation the card must be pushed towards the rear panel.  
After insertion, the hook point must enter into the hole.*

- Verify that there is no loose hardware or metal parts inside the MultiVac base unit. Replace the cover and secure it with screws.

- Before connecting the power cord to the wall socket be sure that the voltage change over is currently set.

## 2-3 Input/Output connector

The input/output connector signals are shown in Fig. 2-3.

## 2-4 Connection example

In Figs. 2-4 and 2-5 are illustrated a typical connection for each input and the output equivalent circuit.

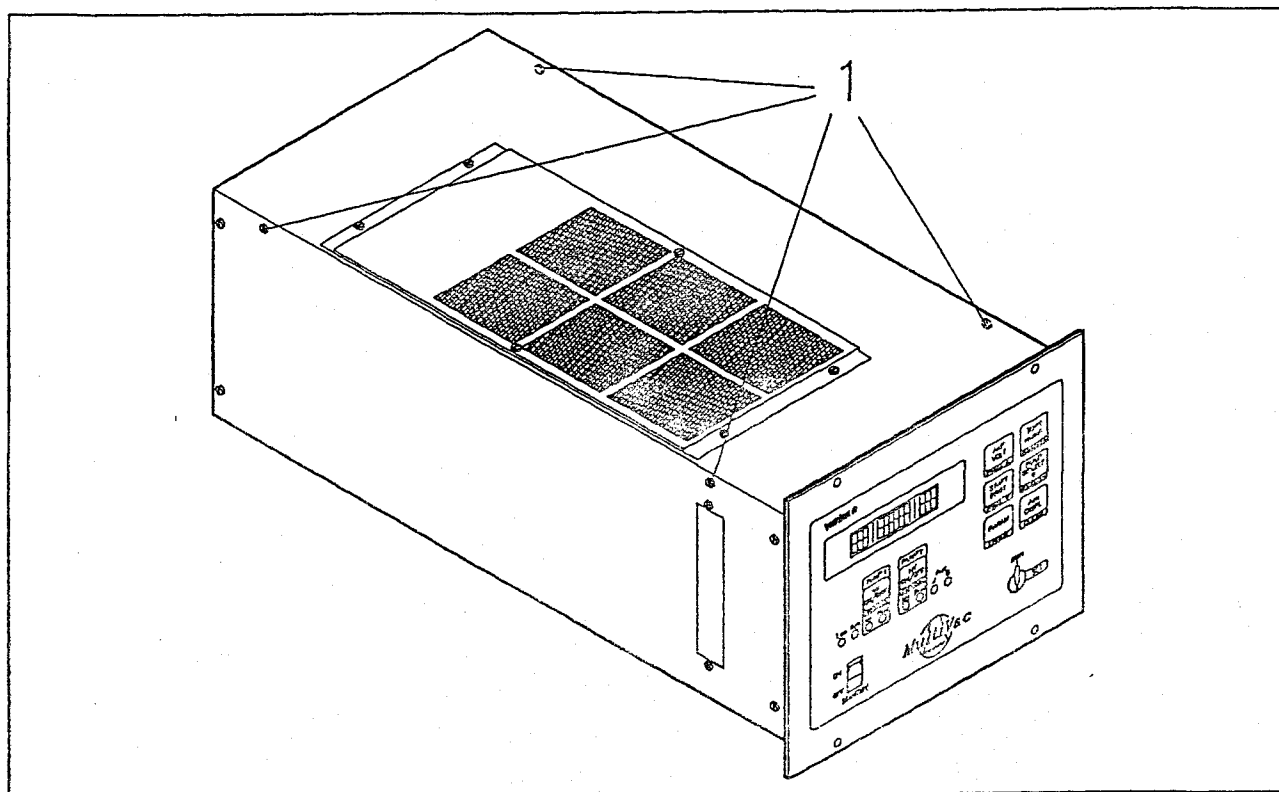

Figure 2-1 - Cover removing

# Installation

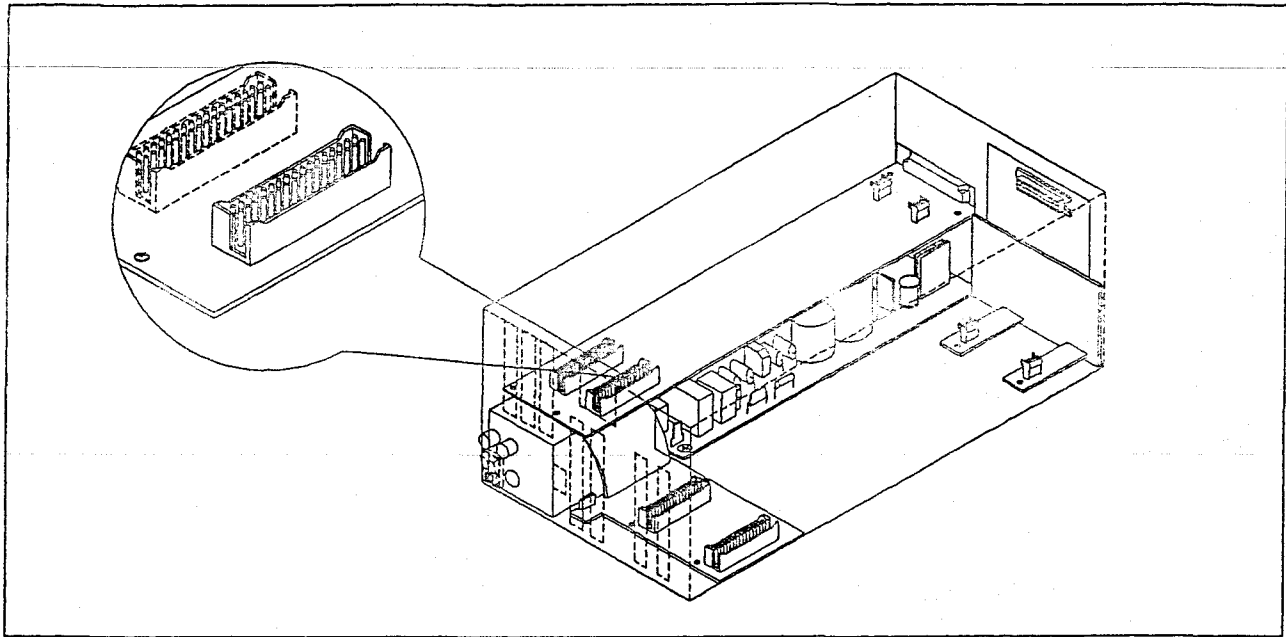

Figure 2-2 - Card installation

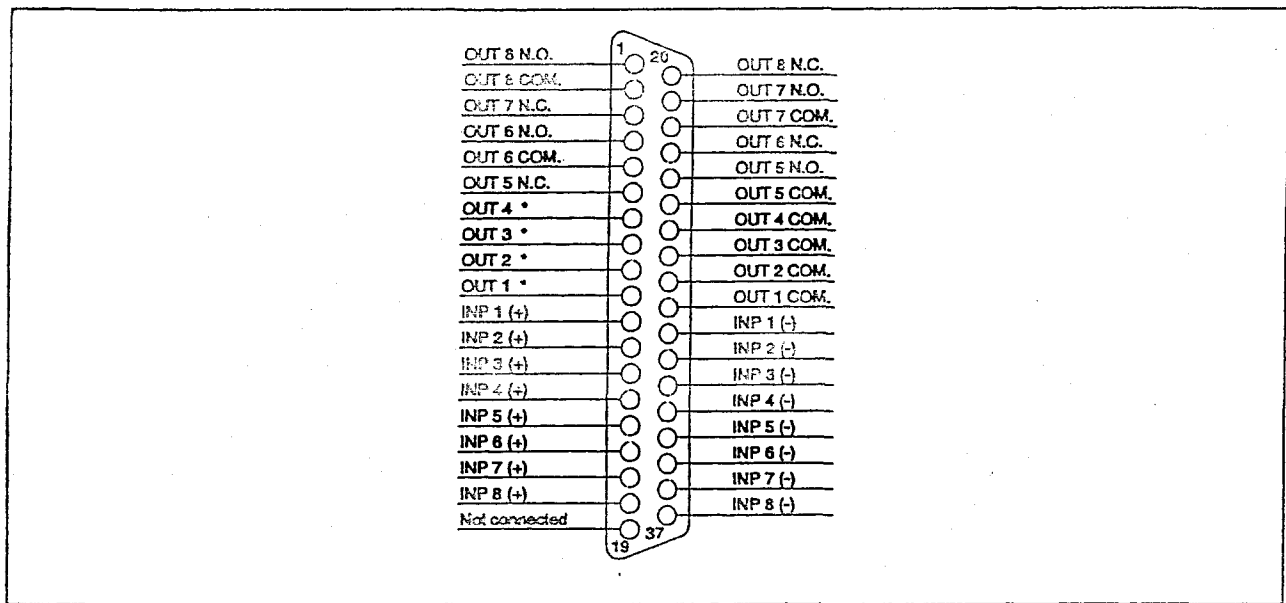

Figure 2-3 - Input/Output connector

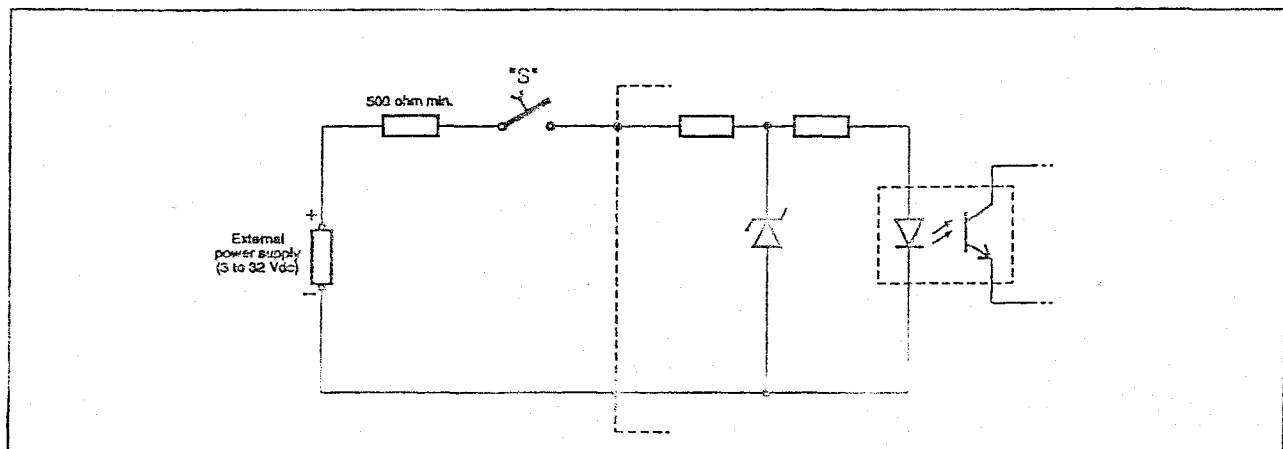

Figure 2-4 - Typical input connection

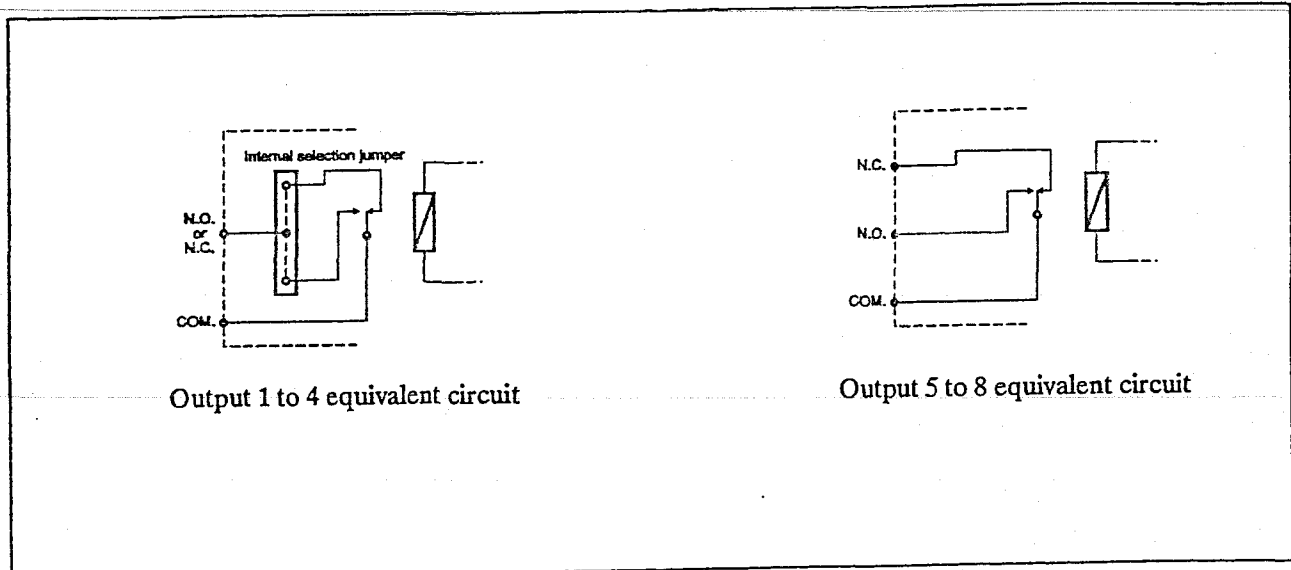

Figure 2-5 - Output equivalent circuit

**This page is intentionally left blank**

### 3-1 General

When the Set Point/Remote Control card is installed, the MultiVac can operate in LOCAL or in REMOTE I/O mode according to the previous selection or to the new one.

At any time it is possible to change the oper-

ating mode: refer to para. 3-2 of MultiVac controller base unit Instruction Manual.

### 3-2 Output description

The following table describes the output signals available on the interface connector.

Output Relay	Pin	Signal	Description
1	10 (N.O. or N.C.) 29 (common)	High Voltage ON	The relay is activated when the corresponding High Voltage card is giving High Voltage at the output.
2	9 (N.O. or N.C.) 28 (common)	Set Point 2	The relay is activated if the pump pressure is "Lower" than the chosen Set Point Level (a $\pm$ 10% hysteresis is provided to avoid oscillations).
3	8 (N.O. or N.C.) 27 (common)	Set Point 1	The relay is activated if the pump pressure is "Lower" than the chosen Set Point Level (a $\pm$ 10% hysteresis is provided to avoid oscillations).
4	7 (N.O. or N.C.) 26 (common)	Polarity	The relay is activated if the chosen High Voltage polarity is "Negative".
5	24 (N.O.) 6 (N.C.) 25 (common)	Interlock OK	The relay is activated if the External Interlock (Input 1) is Low.
6	4 (N.O.) 23 (N.C.) 5 (common)	Fault	The relay is activated if the High Voltage has been switched off by any fault condition.
7	21 (N.O.) 3 (N.C.) 22 (common)	Remote mode	The relay is activated when the Remote Communication operating mode is selected.
8	1 (N.O.) 20 (N.C.) 2 (common)	Protected mode	The relay is activated when Protect operating mode is selected.



### 3-3 Input description

The following table describes the input signals available on the interface connector.

Input N.	Pin	Signal	Description (ref. to Fig. 2-4)
1	11 (positive) 30 (negative)	External Interlock	It requires two stable positions signal. Switch "S" closed: The High Voltage output of the corresponding H. V. card is disabled. Switch "S" open: The H. V. output of the corresponding H.V. card is enabled.
2	12 (positive) 31 (negative)	Confirm	It requires a momentary signal. The transition from switch "S" open to switch "S" closed switches on the High Voltage output of the corresponding H. V. card if the "Output off" input (n. 3) is enabled.
3	13 (positive) 32 (negative)	Output off	It requires two stable positions signal. Switch "S" closed: The High Voltage output of the corresponding H. V. card is enabled, and, if "Confirm" input (n. 2) is momentary fed, the High Voltage output is switched on. Switch "S" open: The High Voltage output of the corresponding H. V. card is switched off.
4	14 (positive) 33 (negative)	Start-Protect mode selection	It requires two stable positions signal. Switch "S" closed: Protect selected Switch "S" open: Start selected.
5	15 (positive) 34 (negative)	Remote I/O - Remote Communication select.	It requires a momentary signal. The transition from switch "S" open to switch "S" closed switches alternatively from Remote Communication (commands taken from RS 232-422 Computer Interface card) operation to Remote I/O (commands taken from Set Point/Remote Control card) operation and viceversa.
6	16 (positive) 35 (negative)	Step V-Fixed V mode selection	It requires two stable positions signal. Switch "S" closed: Step V selected Switch "S" open: Fixed V selected.
7	17 (positive) 36 (negative)	Spare	

Input N.	Pin	Signal	Description (ref. to Fig. 2-4)
8	17 (positive) 36 (negative)	Spare	

**NOTE**

*The Input 1 (External Interlock), if connected, operates independently from the operational mode (Local, Remote Communication, Remote I/O).*

*The activation of this input (switch "S" closure) causes the H.V. output of the corresponding H.V. card to be switched off even if the unit is operating in Local or Remote Communication mode.*

This page is intentionally left blank

#### 4-1 General

Replacement controllers are available on advance exchange basis through Varian Service, but, if necessary, information are provided to aid the operator in determining malfunctions and corrective steps to be taken through minor actions.

#### WARNING

High voltage in the controller can cause severe injury or death. Service must be performed by authorized personnel only.

Before servicing, turn power off and disconnect the power cord.

#### 4-2 No communication with the card

If this occurs, it may be that:

- the Set Point/Remote Control card or the microcomputer board are defective
- the connection cable is defective
- the microcomputer board is blocked.

Try to change the connection cable with a new one and turn off and on again the unit. Should the error still be present, call the maintenance service.

**This page is intentionally left blank**

**Varian S.p.A. - Vacuum Products Torino**  
Via Varian 54  
10040 Leini (Torino) - Italy

**Varian Vacuum Products Lexington**  
121 Hartwell Avenue  
Lexington, Massachusetts 02173 - USA

**FRANCE**

Varian s.a.  
7, Avenue des Tropiques  
Z.A. de Courtaboeuf B. P.12  
F91941 Les Ulis Cedex - France  
Telephone: (33) 1 69863884  
Fax: (33) 1 69282308

**GERMANY, AUSTRIA**

Varian GmbH  
Vacuum Products  
Alsfelderstrasse 6  
64289 Darmstadt - Germany  
Telephone: (49) 61517030  
Fax: (49) 6151703237

**GREAT BRITAIN**

Varian Ltd.  
28 Manor Road  
Walton on Thames  
Surrey KT12 2QF - Great Britain  
Telephone: (44) 1932 898000  
Fax: (44) 1932 228769

**ITALY**

Varian S.p.A. - VP Sales Office  
Via Varian 54  
10040 Leini (Torino) - Italy  
Telephone: (39) 11 9979 111  
Fax: (39) 11 9979 330

**INDIA**

Varian International AG  
605-606, Vishwadeep. Towers, 4  
District Centre, Janakpuri,  
New Delhi - 110058 - India  
Telephone: (011) 5611442  
Fax: (011) 5524317

**KOREA**

Varian Korea Ltd.  
433-1 Mogok-Dong  
Pyungtaek, Kyungki-Do - Korea  
Telephone: (82) 333 6107114  
Fax: (82) 333 6650116

**JAPAN**

Varian Japan Ltd.  
Sumitomo Shibaura Bldg.  
4-16-36 Shibaura Minato ku  
Tokyo 108 - Japan  
Telephone: (81) 3 5232 1211  
Fax: (81) 3 5232 1263

**ASIAN COUNTRIES**

Varian Pacific Inc.  
Rm.1018-20 Tower A  
New Mandarin Plaza  
14 Science Museum Road  
TST East, Kowloon - Hong Kong  
Telephone: (852) 27242836  
Fax: (852) 23694280

**USA, SOUTH & CENTRAL AMERICA**

Varian Vacuum Products  
121 Hartwell Avenue  
Lexington, MA 02173 - USA  
Telephone: (617) 861 7200  
Fax: (617) 860 5437  
Toll free: 1 800 882 7426

**CANADA**

Varian Canada Inc.  
6705 Millcreek Drive, Unit 5  
Mississauga, Ontario L5N 5R9  
Canada  
Telephone: (905) 819 8188  
Fax: (905) 819 8348  
Toll free: 1 800 663 2727

**AUSTRALIA**

Varian Australia Pty Ltd.  
6/81 Frenchs Forest Road  
Frenchs Forest NSW 2086  
Australia  
Telephone: (61) 2451 9133  
Fax: (61) 2452 2600

**OTHER COUNTRIES**

Varian S.p.A. - VP. Sales Office  
Via Varian 54  
10040 Leini (Torino) - Italy  
Telephone: (39) 11 9979 111  
Fax: (39) 11 9979 330

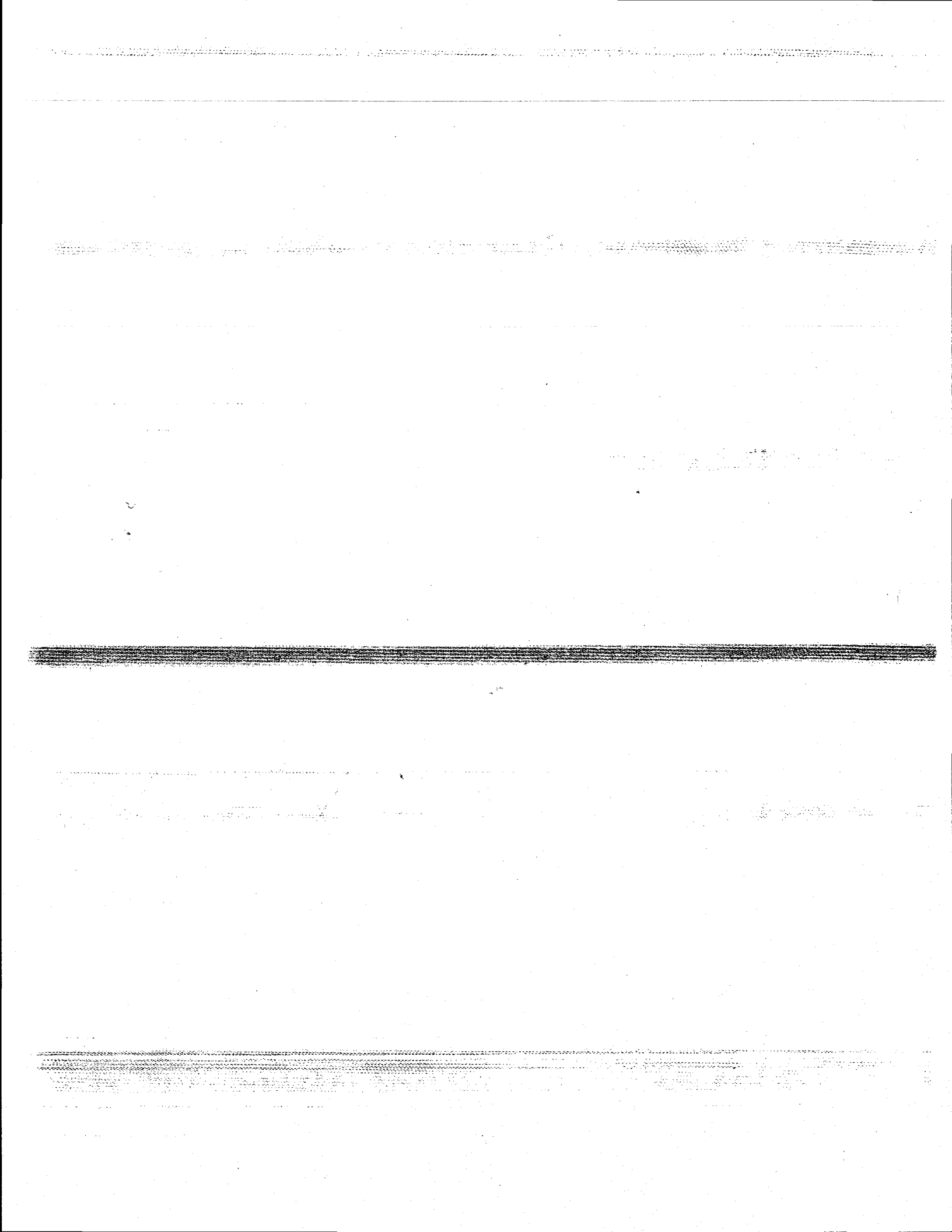

## ***MultiVac controller***

### **Base unit**

**Model 929-4000**

**Model 929-4001**

**Model 929-4010**

**Model 929-4011**

### **High Voltage card**

**Model 929-4025**

**Model 929-4035**

**Model 929-4040**

**Model 929-4050**

*MANUALE ISTRUZIONI*

*BEDIENUNGSHANDBUCH*

*NOTICE DE MODE D'EMPLOI*

*INSTRUCTION MANUAL*



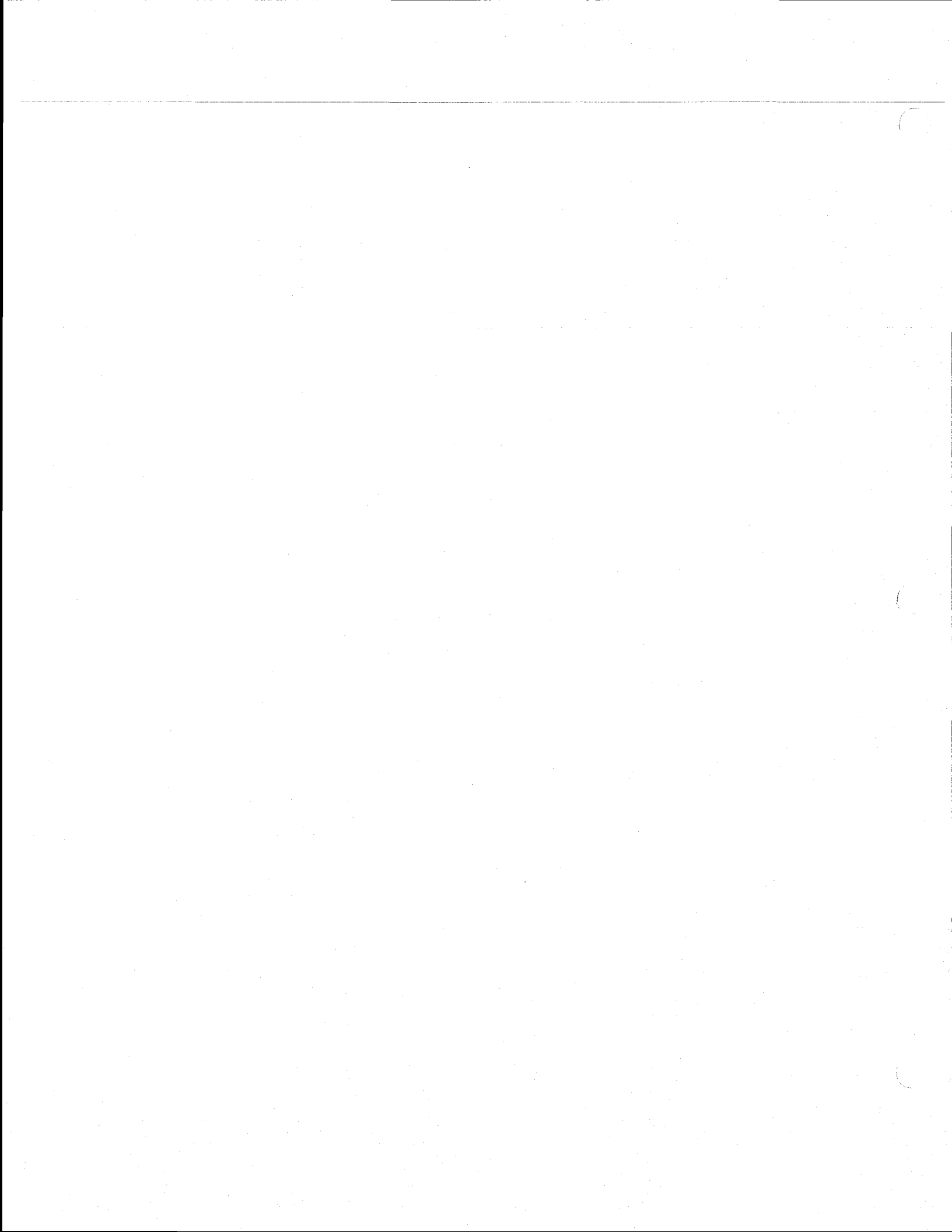

**varian**   
vacuum products

*Dear Customer,*

*Thank you for purchasing a VARIAN vacuum product. At VARIAN Vacuum Products we make every effort to ensure that you will be satisfied with the product and/or service you have purchased.*

*As part of our Continuous Improvement effort, we ask that you report to us any problem you may have had with the purchase or operation of our product. On the back side you find a Corrective Action Request form that you may fill out in the first part and return to us.*

*This form is intended to supplement normal lines of communications and to resolve problems that existing systems are not addressing in an adequate or timely manner.*

*Upon receipt of your Corrective Action Request we will determine the Root Cause of the problem and take the necessary actions to eliminate it. You will be contacted by one of our employees who will review the problem with you and update you, with the second part of the same form, on our actions.*

*Your business is very important to us. Please, take the time and let us know how we can improve.*

*Sincerely,*

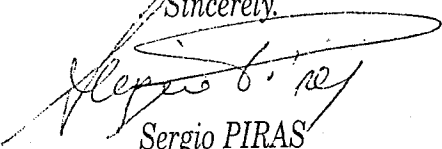

**Sergio PIRAS**

*Vice President and General Manager  
VARIAN Vacuum Products Torino*

Note: Fax or mail the Customer Request for Action (see backside page) to VARIAN Vacuum Products Torino - Quality Assurance or to your nearest VARIAN representative for onward transmission to the same address.

**CUSTOMER REQUEST FOR CORRECTIVE / PREVENTIVE / IMPROVEMENT ACTION**

TO : VARIAN VACUUM PRODUCTS TORINO - QUALITY ASSURANCE  
 FAX N° : XXXX - 11 - 9979350  
 ADDRESS: VARIAN S.p.A. - Via F.lli Varian, 54 - 10040 Leini (Torino) - Italy  
 E-MAIL : lrossi@varian.vol.it

NAME	COMPANY	FUNCTION
_____	_____	_____
ADDRESS : _____		
TEL. N° : _____ FAX N° : _____		
E-MAIL : _____		
PROBLEM / SUGGESTION :		
_____ _____ _____ _____ _____ _____ _____		
REFERENCE INFORMATION (model n°, serial n°, ordering information, time to failure after installation, etc.) :		
_____ _____ _____		
		DATE _____

CORRECTIVE ACTION PLAN / ACTUATION	LOG N° _____
(by VARIAN VPT)	
_____ _____ _____ _____ _____ _____	

XXXX = Code for dialing Italy from your country ( es. 01139 from USA; 00139 from Japan, etc.)



ISTRUZIONI PER L'USO .....	1
GEBRAUCHSANLEITUNG .....	9
MODE D'EMPLOI.....	17
INSTRUCTIONS FOR USE.....	25
TECHNICAL INFORMATION.....	33
MULTIVAC CONTROLLER DESCRIPTION .....	33
MULTIVAC BASE SPECIFICATION .....	34
CONTROLLER OUTLINE .....	35
LARGE VACION PLUS HIGH VOLTAGE CARD .....	36
MEDIUM VACION PLUS HIGH VOLTAGE CARD.....	40
H.V. CARDS OUTLINE .....	44
H.V. CARDS INSTALLATION .....	45
BAYARD ALPERT CARD DESCRIPTION .....	48
UHV CARD DESCRIPTION.....	51
COLD CATHODE BOARD .....	53
THERMOCOUPLE PRINTED CIRCUIT BOARD DESCRIPTION .....	55
MULTIGAUGE CARDS INSTALLATION .....	57
PUMP CONNECTION .....	57
RECORDER OUTPUT CONNECTION.....	58
USE.....	58
Operating Mode Selection.....	58
Using the MultiVac Controller with the RUN/SET Key in RUN Position.....	59
Using the MultiVac Controller with the RUN/SET Key in SET Position.....	60
Spare Pump Parameters .....	60
H.V. Card Switching ON.....	69
Degas Function .....	69
Auto On Function .....	69
Thermocouple Calibration Function .....	69
Pumps Operating Parameters Reading .....	69
Emergency Switch Off of the Two Pumps .....	70
Switch Off of One Pump .....	70
CONTROLLER PARTS .....	73

**INFORMAZIONI GENERALI**

Questa apparecchiatura è destinata ad uso professionale. L'utilizzatore deve leggere attentamente il presente manuale di istruzioni ed ogni altra informazione addizionale fornita dalla Varian prima dell'utilizzo dell'apparecchiatura. La Varian si ritiene sollevata da eventuali responsabilità dovute all'inosservanza totale o parziale delle istruzioni, ad uso improprio da parte di personale non addestrato, ad interventi non autorizzati o ad uso contrario alle normative nazionali specifiche. Nei paragrafi seguenti sono riportate tutte le informazioni necessarie a garantire la sicurezza dell'operatore durante l'utilizzo dell'apparecchiatura. Informazioni dettagliate sono fornite nell'appendice "Technical Informations".

Questo manuale utilizza le seguenti convenzioni:



**PERICOLO!**

I messaggi di pericolo attirano l'attenzione dell'operatore su una procedura o una pratica specifica che, se non eseguita in modo corretto, potrebbe provocare gravi lesioni personali.



**ATTENZIONE!**

I messaggi di attenzione sono visualizzati prima di procedure che, se non osservate, potrebbero causare danni all'apparecchiatura.

**NOTA**

Le note contengono informazioni importanti estrapolate dal testo.

**DESCRIZIONE DEL CONTROLLER**

Il controller MultiVac della Varian è un controller per le pompe ioniche modulare e flessibile. L'unità può essere preconfigurata in fabbrica a seconda delle necessità del cliente, o le parti possono essere ordinate separatamente e l'utente può aggiungere o cambiare le possibilità del controller semplicemente inserendo o rimuovendo schede opzionali.

La configurazione minima del controller MultiVac è la seguente:

- 1 unità base MultiVac
- 1 scheda Vaclon Pump High Voltage

La configurazione minima può essere espansa aggiungendo schede opzionali. La tabella seguente elenca le schede opzionali disponibili.

Nell'installare schede opzionali occorre soddisfare alle seguenti limitazioni:

- un massimo di due schede High Voltage
- un massimo di altre due schede.

**NOTA**

Il controller MultiVac con numero di parte 929-4000/4001/4010/4011 non possono comandare una scheda MultiGage. Per installare una scheda MultiGage il controller deve essere aggiornato tramite un apposito kit. Per maggiori dettagli contattare l'Assistenza Varian.

DESCRIZIONE	NUMERO DI PARTE
<b>Unità Base MultiVac</b>	
Unità Base predisposta per una tensione di alimentazione di 220 Vac	929-4000 929-4001 (con scheda RS-232 installata)
Unità Base predisposta per una tensione di alimentazione di 110 Vac	929-4010 929-4011 (con scheda RS-232 installata)
<b>Schede Opzionali</b>	
Scheda Medium Vaclon Pump High Voltage (H.V.)	929-4025 o 929-4035
Scheda Large Vaclon Pump High Voltage (H.V.)	929-4040 o 929-4050
Scheda Set Point/Remote Control	969-4110
Scheda RS 232-422 Computer Interface	929-4100
Multi Gauge Bayard-Alpert	L6427-301
Multi Gauge UHV	L8321-301
Multi Gauge Cold Cathode	L6433-301
Multi Gauge Thermocouple	L6430-301

Il controller MultiVac in configurazione base ed insieme alle schede H.V. può controllare un massimo di due pompe ioniche dalla 20 l/s alla 500 l/s con polarità positiva o negativa. Permette di eseguire delle letture affidabili di pressione fino a 10<sup>-11</sup> Torr, ottimizzando le prestazioni della pompa sull'intero campo operativo.

Le schede Multi Gauge permettono di eseguire letture di pressione con differenti precisioni e campi di misura. Il controller MultiVac può essere comandato sia in modo LOCAL, sia in modo REMOTE I/O nel caso in cui sia installata la scheda Set Point Remote Control, sia in modo REMOTE COMMUNICATION nel caso in cui sia installata la scheda RS 232-422 Computer Interface.

Nel modo LOCAL tutti i comandi sono dati tramite il pannello frontale. Nel modo REMOTE I/O tutti i comandi sono dati tramite il connettore della scheda Set Point/Remote Control presente sul pannello posteriore. Nel modo REMOTE COMMUNICATION tutti i comandi sono dati tramite un computer principale attraverso la scheda RS 232-422 Computer Interface.

**IMMAGAZZINAMENTO**

Durante il trasporto e l'immagazzinamento del controller devono essere soddisfatte le seguenti condizioni ambientali:

- temperatura: da -20 °C a +70 °C
- umidità relativa: 0 - 95% (non condensante)

**PREPARAZIONE PER L'INSTALLAZIONE**

Il controller viene fornito in un imballo protettivo speciale; se si presentano segni di danni, che potrebbero essersi verificati durante il trasporto, contattare l'ufficio vendite locale.

Durante l'operazione di disimballaggio, prestare particolare attenzione a non lasciar cadere il controller e a non sottoporlo ad urti.

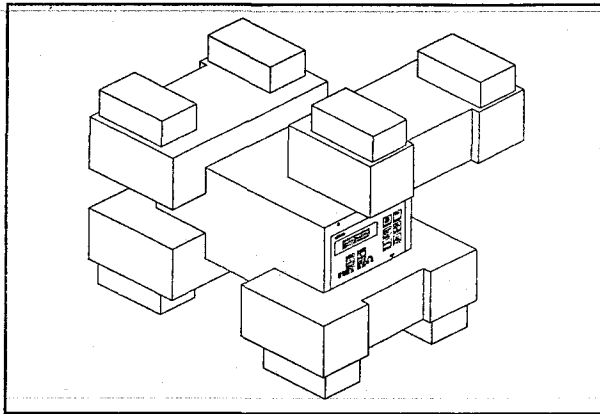

Imballaggio del Controller

Non disperdere l'imballo nell'ambiente. Il materiale è completamente riciclabile e risponde alla direttiva CEE 85/399 per la tutela dell'ambiente.

Il controller MultiVac è predisposto in fabbrica per le seguenti tensioni di alimentazione:

- modelli 929-4000/929-4001 per 220 Vac (tensione di ingresso da 180 a 265 Vac),
- modelli 929-4010/929-4011 per 110 Vac (tensione di ingresso da 90 a 130 Vac).

Nel caso in cui fosse necessario cambiare la tensione di alimentazione, eseguire la seguente procedura:

- Spegnere il controller e staccare il cavo di alimentazione dalla rete.
- Sul fondo del controller, selezionare la tensione di alimentazione desiderata spostando il deviatore sulla posizione 110 Vac o 220 Vac come mostrato nella figura seguente.

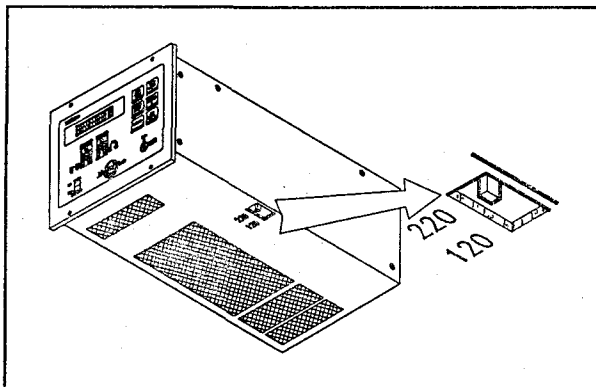

Deviatore di Selezione Tensione di Alimentazione

Se occorre cambiare il cavo di alimentazione, esso va cablato nel seguente modo:

- blu = neutro
- marrone = fase
- giallo-verde = terra

## INSTALLAZIONE



Il controller MultiVac è munito di un cavo di alimentazione a 3 fili con una spina di sicurezza (approvata a livello internazionale). Utilizzare questo cavo di alimentazione e la spina insieme ad una presa munita di collegamento di terra onde evitare folgorazioni. Verificare che il collegamento di terra sia collegato in modo corretto.

All'interno del controller si sviluppano alte tensioni che possono recare gravi danni o la morte. Prima di eseguire qualsiasi operazione di installazione o manutenzione del controller scollegarlo dalla alimentazione.



### ATTENZIONE!

Il controller può essere usato sia come unità da tavolo sia come modulo a rack, in ogni caso deve essere posizionato in modo tale che l'aria possa circolare liberamente attraverso i fori di areazione presenti sulla copertura superiore ed inferiore.

Se il controller viene utilizzato come modulo a rack, DEVE essere inserito in un adattatore alto quattro unità rack per evitare che cada all'interno del rack stesso. Il pannello frontale del MultiVac non è previsto per reggere il peso dell'unità.

Non installare o utilizzare il controller in un ambiente esposto ad agenti atmosferici (pioggia, neve, ghiaccio), polvere, gas corrosivi, o in un ambiente esplosivo o ad alto rischio di infiammabilità.

### NOTA

Se il controller è utilizzato come unità da tavolo, estrarre i due piedini frontali. Se il controller è installato in un rack, rimuovere i quattro piedini e posizionarlo con almeno 30 mm (1.2 pollici) di spazio sopra e sotto.

Durante il funzionamento, occorre che siano rispettate le seguenti condizioni ambientali:

- temperatura: da 0 °C a +45 °C
- umidità relativa: 0 - 90% (senza condensa)

Per collegare il controller alla pompa utilizzare il cavo specifico fornito come opzione.

Vedere l'appendice "Technical Information" per informazioni dettagliate su questi ed altri collegamenti, e sull'installazione delle schede opzionali.

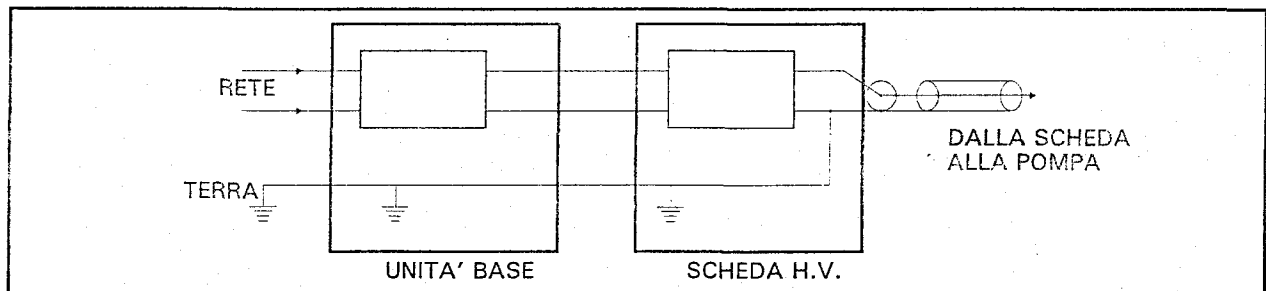

Collegamenti delle Masse

USO

In questo paragrafo sono riportate le principali procedure operative. Per ulteriori dettagli e per procedure che coinvolgono collegamenti o particolari opzionali, fare riferimento al paragrafo "use" dell'appendice "Technical Informations".  
Prima di usare il controller effettuare tutti i collegamenti elettrici e pneumatici e fare riferimento al manuale della pompa collegata.



**PERICOLO!**

Per evitare danni alle persone ed all'apparato, nel caso in cui la pompa sia appoggiata su di un tavolo assicurarsi che sia stabile. Non far funzionare mai la pompa se la flangia di ingresso non è collegata al sistema o non è chiusa con la flangia di chiusura.

Controlli ed Indicatori del Pannello Frontale del MultiVac

La figura seguente illustra il pannello frontale del controller MultiVac.  
Il significato e la funzione dei controlli e degli indicatori è dettagliato nella seguente tabella.



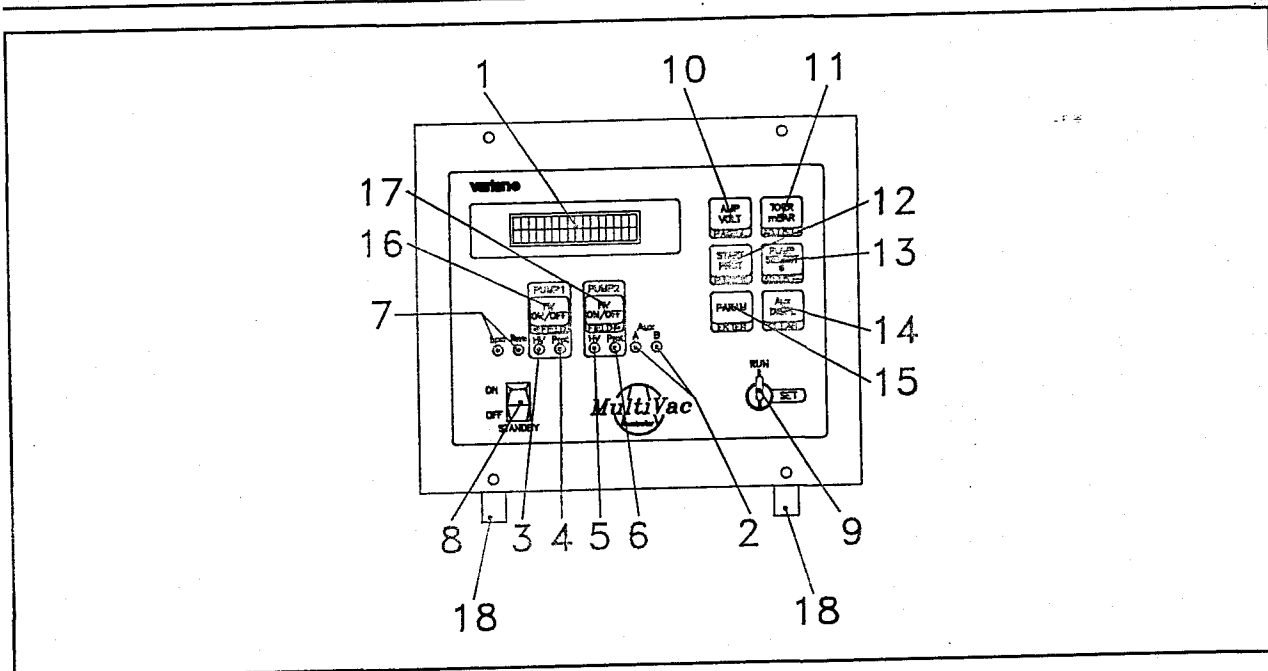

**NOTA**

*Il significato dei pulsanti del pannello frontale del MultiVac cambia a seconda della posizione della chiave RUN-SET.  
Le scritte bianche su sfondo nero sono valide quando la chiave è in posizione RUN.  
Le scritte rosse su sfondo bianco sono valide quando la chiave è in posizione SET.*

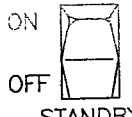

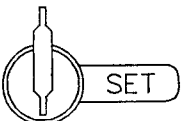
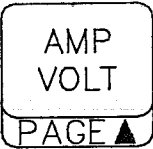

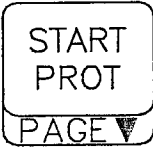
MultiVac front panel controls

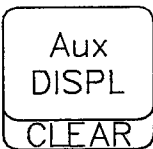
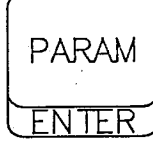
Rif.	Nome del Controllo/Indicatore	Descrizione del Controllo/Indicatore
1		Display LCD a matrice di punti retroilluminato, 16 caratteri, 2 linee.
2	AUX A/B	Due LED verdi accesi se le schede opzionali sono installate (per esempio se la scheda Set Point/Remote Control è installata nello slot #3 all'interno dell'unità, il LED A è acceso).
3	PUMP 1 - HV	LED giallo acceso quando la scheda H.V. della pompa 1 è accesa.
4	PUMP 1 - Prot.	LED verde acceso quando è stato selezionato il modo di funzionamento Protect per la pompa 1.
5	PUMP 2 - HV	LED giallo acceso quando la scheda H.V. della pompa 2 è accesa.
6	PUMP 2 - Prot.	LED verde acceso quando è stato selezionato il modo di funzionamento Protect per la pompa 2.
7	Loc - Rem	Due LED verdi che indicano il modo di funzionamento selezionato: - Loc è acceso quando è selezionato il modo di funzionamento LOCAL; - Rem è acceso quando è selezionato il modo di funzionamento REMOTE I/O o REMOTE COMMUNICATION.
8		Quando è in posizione OFF le Pompe 1 e 2 sono disabilitate; quando è in posizione ON le pompe possono essere accese. Permette di spegnere entrambe le pompe contemporaneamente in condizioni di emergenza.

Rif.	Nome del Controllo/Indicatore	Descrizione del Controllo/Indicatore	
9		<p>Il selettore a chiave RUN/SET permette di cambiare il significato dei pulsanti a doppia funzione del pannello frontale.</p> <p>La posizione RUN è la normale posizione durante il funzionamento della pompa.</p> <p>La posizione SET permette di definire i parametri della pompa.</p>	<p>Chiave in posizione RUN</p> <p>Chiave in posizione SET</p>
10		<p><b>AMP/VOLT</b></p> <p>Quando viene premuto permette di visualizzare sul display LCD la misura di corrente o tensione della pompa selezionata tramite il controllo (13). Se la pompa selezionata è spenta, il pulsante è inattivo.</p>	<p><b>PAGE ▲</b></p> <p>Quando viene premuto passa alla pagina video di predisposizione precedente.</p>
11		<p><b>TORR/mBAR</b></p> <p>Quando viene premuto permette di visualizzare sul display LCD la misura di pressione in Torr o mbar della pompa selezionata tramite il controllo (13). Se la pompa selezionata è spenta, il pulsante è inattivo.</p>	<p><b>ADJUST +</b></p> <p>Quando viene premuto permette di modificare il valore di predisposizione. Permette inoltre di avviare la procedura standard di spegnimento di una sola pompa.</p>
12		<p><b>START/PROTECT</b></p> <p>Quando viene premuto il modo di funzionamento della pompa selezionata con il controllo (13) viene cambiato da START a PROTECT o viceversa. Se viene selezionato il modo PROTECT per una pompa, il corrispondente LED verde Prot (4) o (6) si accende.</p>	<p><b>PAGE ▼</b></p> <p>Quando viene premuto passa alla pagina video di predisposizione seguente.</p>
13		<p><b>PUMP SELECT</b></p> <p>Permette di selezionare, sul display, la pompa sulla quale viene eseguita l'azione successiva (ad esempio il cambio del modo di funzionamento, o la visualizzazione dei parametri pompa). La pompa selezionata viene indicata sul display dal simbolo # seguito dal numero 1 o 2. Se è installato un solo modulo H.V. il pulsante è inattivo.</p>	<p><b>ADJUST -</b></p> <p>Quando viene premuto permette di modificare i valori di predisposizione. Permette inoltre di avviare la procedura standard di spegnimento di una sola pompa.</p>
14		<p><b>Aux DISPL</b></p> <p>Permette di selezionare di quale scheda MultiGauge è da visualizzare sul display la relativa lettura.</p>	<p><b>CLEAR</b></p> <p>Quando viene premuto permette di ritornare alla precedente selezione se il pulsante ENTER non è stato ancora premuto, o, se premuto due volte, di ritornare alla prima pagina del menu selezionato da qualsiasi pagina.</p>
15		<p><b>PARAM</b></p> <p>Quando viene premuto permette di visualizzare i parametri della pompa selezionata sulla scheda H.V. indicata sul display dal simbolo #.</p> <p>I parametri visualizzati sono:</p> <p><b>Pump size:</b> la dimensione della pompa selezionata</p> <p><b>I<sub>max</sub>:</b> la corrente di corto circuito della pompa selezionata</p> <p><b>I<sub>prot</sub>:</b> il valore di corrente al quale interviene la protezione "Overcurrent"</p> <p><b>PWR<sub>max</sub>:</b> la potenza massima della pompa selezionata</p> <p><b>V<sub>max</sub>:</b> La polarità (+ o -) e la tensione massima della pompa selezionata</p> <p><b>Fixed V o Step V:</b> il modo operativo selezionato</p> <p><b>STP1/STP2:</b> i valori dei Set Point 1 e 2, e l'informazione se i set point sono stati superati (il simbolo ^ indica che il corrispondente set point è stato superato o che la H. V. è spenta)</p> <p><b>NOTA:</b> Le indicazioni relative ai set point vengono mostrate solo se la scheda Set point/Remote Control è installata.</p>	<p><b>ENTER</b></p> <p>Quando viene premuto si conferma il parametro visualizzato.</p>



# ISTRUZIONI PER L'USO

Rif.	Nome del Controllo/Indicatore	Descrizione del Controllo/Indicatore	
		Chiave (9) in posizione RUN	Chiave (9) in posizione SET
16		<p><b>PUMP 1 HV ON/OFF</b></p> <p>Quando viene premuto accende o spegne la scheda H.V. della pompa 1. Funziona come interruttore bistabile. La sua azione è indipendente dalla linea selezionata sul display. Per accendere la scheda H. V., l'interruttore STANDBY ON/OFF (8) deve essere in posizione ON.</p>	<p>&lt; FIELD</p> <p>Ha tre funzioni:</p> <ul style="list-style-type: none"> <li>- cambia il menu visualizzato (View, Mode, Set);</li> <li>- seleziona il campo all'interno della pagina durante l'operazione di predisposizione</li> <li>- cambia la pagina in lettura dalla pompa 1 alla pompa 2 e viceversa quando entrambe le pompe sono accese.</li> </ul>
17		<p><b>PUMP 2 HV ON/OFF</b></p> <p>Quando viene premuto accende o spegne la scheda H.V. della pompa 2. Funziona come interruttore bistabile. La sua azione è indipendente dalla linea selezionata sul display. Per accendere la scheda H. V., l'interruttore STANDBY ON/OFF (8) deve essere in posizione ON.</p>	<p>FIELD &gt;</p> <p>Ha tre funzioni:</p> <ul style="list-style-type: none"> <li>- cambia il menu visualizzato (View, Mode, Set);</li> <li>- seleziona il campo all'interno della pagina durante l'operazione di predisposizione</li> <li>- cambia la pagina in lettura dalla pompa 1 alla pompa 2 e viceversa quando entrambe le pompe sono accese.</li> </ul>
18		Piedini frontali estratti solo nel caso di installazione su tavolo.	

## Pannello Posteriore del MultiVac

La figura seguente mostra i controlli e le connessioni del pannello posteriore del controller MultiVac. La configurazione illustrata prevede una scheda H.V., una scheda Set Point/Remote Control card e una scheda RS 232/422 Computer Interface.

## PROCEDURE DI USO

### Modi di Funzionamento

Il controller MultiVac può funzionare nei modi LOCAL, REMOTE input/output (I/O) o REMOTE COMMUNICATION.

Se non è presente alcuna scheda opzionale (Remote I/O and Set-Points o RS232-422), il solo modo di funzionamento disponibile è LOCAL. Nel modo LOCAL tutti i comandi sono dati da pannello frontale.

Se è installata solo la scheda Remote I/O and Set-Points, il MultiVac può funzionare nei modi LOCAL o REMOTE I/O. Nel modo REMOTE I/O tutti i comandi sono dati tramite il connettore di input/output del pannello posteriore. Dopo una interruzione dell'alimentazione il MultiVac ritorna al modo di funzionamento precedentemente selezionato.

Se è installata la scheda RS232-422 ed è stata abilitata dal dip switch 3 (vedere l'appendice Technical Information) sono disponibili i modi di funzionamento LOCAL e REMOTE COMMUNICATION nel quale tutti i comandi sono dati tramite la linea RS 232-422. Dopo una interruzione dell'alimentazione il MultiVac ritorna sempre al modo di funzionamento REMOTE COMMUNICATION anche se il modo precedentemente selezionato era LOCAL.

Se sono installate entrambe le schede RS232-422 e Remote I/O, sono disponibili tutti i tre modi di funzionamento. Dopo una interruzione dell'alimentazione il MultiVac ritorna sempre al modo di funzionamento REMOTE COMMUNICATION anche se il modo precedentemente selezionato era LOCAL o REMOTE I/O.

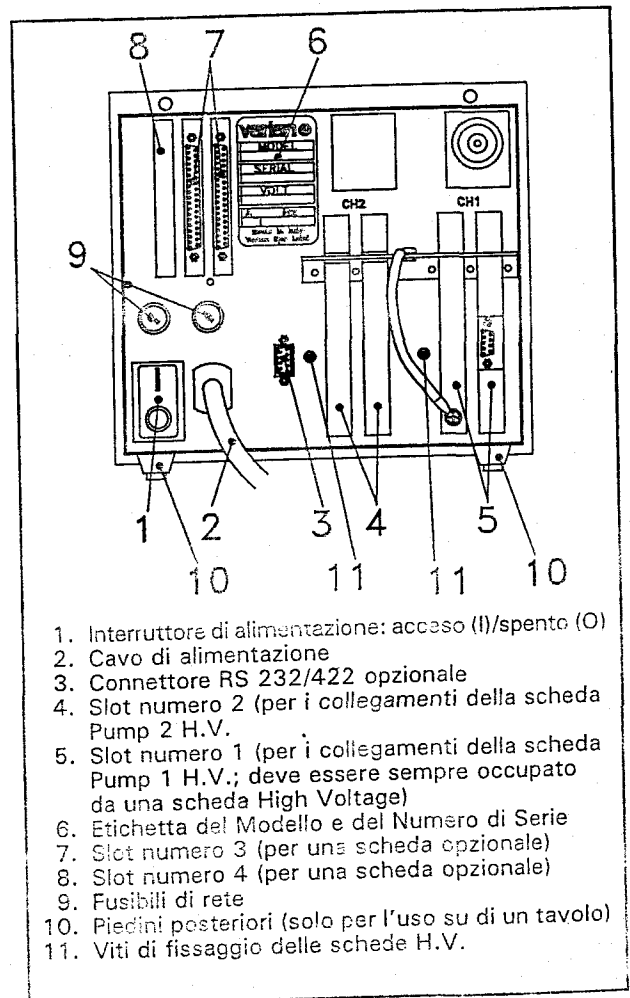

Pannello Posteriore del MultiVac

L'unità è progettata per funzionare in diversi modi:

- modo **START** o **PROTECTED**
- modo **STEP** o **FIXED VOLTAGE**

Nel modo **START** il controller fornisce l'intera potenza, indipendentemente dalle condizioni della pompa, fino alla corrente di corto circuito. Questo modo di funzionamento deve essere usato per avviare la pompa ad alta pressione.

Nel modo **PROTECTED** il controller limita la corrente di uscita e spegne l'alta tensione quando il valore di corrente supera la corrente di soglia per più di 0.2 secondi.

Nel modo **STEP** quando la corrente assorbita dalla pompa raggiunge i valori di soglia, il controller cambia la tensione di uscita.

Nel modo **FIXED VOLTAGE** la tensione di uscita rimane sempre al valore massimo.

#### NOTA

L'unità è predisposta in fabbrica nel seguente modo:

- modo di funzionamento **LOCAL** se la scheda **Computer Interface** non è installata
- modo di funzionamento **REMOTE** se la scheda **Computer Interface** è installata
- chiave **RUN/SET** in posizione **RUN**
- modo di funzionamento: **START, STEP VOLTAGE**

Durante il normale uso del controller la chiave **RUN/SET** DEVE essere in posizione **RUN**.

Informazioni dettagliate sui modi di funzionamento sono contenute nell'appendice "Technical Information".

#### Accensione della Scheda H.V.

Per accendere la scheda H.V. la chiave **RUN/SET** deve essere in posizione **RUN**, l'interruttore **STANDBY** e l'interruttore di alimentazione del pannello posteriore devono essere in posizione **ON**.

#### NOTA

Con una sola scheda H.V. installata entrambe le linee sono dedicate alla pompa numero uno, con due schede installate ogni linea è dedicata ad una pompa diversa.

Il display mostra:

1	#	2	0	S	t	a	r	C	e	l	l		

Premere il pulsante **PUMP 1 HV ON/OFF** (o **PUMP 2 HV ON/OFF** a seconda di quale pompa si vuole accendere), e il display mostra:

1	#	C	u	r	r	e	n	t	(	A	)		

Per visualizzare il valore della tensione premere il pulsante **AMP/VOLT**.

Per visualizzare la pressione premere il pulsante **TORR/mBAR**.

#### NOTA

Il cambio avviene solo nella linea con il simbolo #. Premere il pulsante **PUMP SELECT #** per spostare il simbolo # da una linea all'altra.

Accanto al valore letto, appare uno dei simboli descritti nella tabella seguente.

Simbolo	Descrizione
>	Il valore sta aumentando
<	Il valore sta diminuendo
■	Il valore è stabile

#### NOTA

Nel caso in cui la corrente è troppo bassa (cioè  $< 1 \times 10^7 A$ ), il valore di pressione non viene letto ed appare il messaggio "LOW PRESSURE".

#### Funzionamento dei Ventilatori

Quando il controller viene acceso e le schede H.V. sono spente, i ventilatori ruotano lentamente in modo che sia assicurato un leggero flusso di aria all'interno dell'unità.

Quando viene accesa una scheda H.V., i ventilatori iniziano a ruotare ad alta velocità in modo da assicurare un alto flusso d'aria all'interno dell'unità quando la tensione è maggiore di 5 KV o la potenza di uscita è maggiore di 30 W.

# ISTRUZIONI PER L'USO

## Accensione delle Schede MultiGauge

Per accendere le schede MultiGauge eseguire la seguente procedura:

- Accendere l'interruttore di alimentazione sul pannello posteriore.
- Mettere su ON l'interruttore STAND-BY/INTERLOCK del pannello frontale. Verrà visualizzato il messaggio "MULTIVAC INITIALIZATION" per pochi secondi e quindi i tipi di pompe selezionate sulle schede High Voltage installate nei canali 1 e 2.
- Premere il pulsante AUX DISPL, il display visualizzerà il tipo di scheda installata negli slot A e B (terzo e quarto).
- Portare la chiave in posizione SET, il display visualizzerà il messaggio "MAIN MENU - VIEW".
- Premere ENTER, il display visualizzerà uno dei canali, spostarsi attraverso i 4 canali tramite i due pulsanti FIELD LEFT e FIELD RIGHT fino a vedere visualizzata la scheda che si vuole accendere.
- Premere ENTER; nel caso in cui la scheda fosse stata spenta precedentemente da un guasto, il display mostrerà il motivo del guasto.
- Premere ENTER ed il display richiederà se si vuole accendere la scheda Gauge. La risposta di default è YES, se si vuole scegliere NO premere uno dei pulsanti FIELD.
- Premere ENTER, il MultiVac accenderà il sensore della scheda Gauge ed il display visualizzerà il messaggio "WARM UP" per circa 10 - 20 secondi.

Quando la scheda Gauge è accesa, il display mostra il valore di pressione letto.

## Letture dei Parametri della Pompa

Quando una scheda H.V. è accesa si possono leggere i parametri della pompa premendo il pulsante PARAM. La lettura che si ottiene è tipicamente del seguente tipo:

1	#	20	S	t	a	r	C	e	l	l		
---	---	----	---	---	---	---	---	---	---	---	--	--

1	#	I	m	a	x	1	5	0	m	A		
---	---	---	---	---	---	---	---	---	---	---	--	--

1	#	I	p	r	o	t	2	0	m	A		
---	---	---	---	---	---	---	---	---	---	---	--	--

1	#	P	W	R	m	a	x	1	5	0	W	
---	---	---	---	---	---	---	---	---	---	---	---	--

1	#	V	m	a	x	-	7	0	0	0	V	
---	---	---	---	---	---	---	---	---	---	---	---	--

1	#	S	T	E	P	V						
---	---	---	---	---	---	---	--	--	--	--	--	--

## Spegnimento della Scheda H.V.

Per spegnere una scheda H.V. premere il corrispondente pulsante PUMP HV ON/OFF sul pannello frontale del controller.

Per spegnere contemporaneamente entrambe le pompe in condizioni di emergenza, si può mettere l'interruttore STAND-BY/INTERLOCK del pannello frontale in posizione OFF. In questo caso i LED HV lampeggiano ed il display mostra

S	T	A	N	D	B	Y	/	I	N	T	L	K	
S	E	E	M	A	N	U	A	L					

per circa 5 secondi, quindi ritorna nelle condizioni normali.

## MANUTENZIONE

Il controller MultiVac non richiede alcuna manutenzione. Qualsiasi intervento deve essere eseguito da personale autorizzato. In caso di guasto è possibile usufruire del servizio di riparazione Varian o del "Varian advance exchange service", che permette di ottenere un controller nuovo in sostituzione di quello guasto.



**PERICOLO!**

Prima di effettuare qualsiasi intervento sul controller scollegare il cavo di alimentazione.

Qualora un controller dovesse essere rottamato, procedere alla sua eliminazione nel rispetto delle normative nazionali specifiche.

## MESSAGGI DI ERRORE

Per certi tipi di guasti il controller esegue una auto-diagnostica e visualizza uno dei messaggi mostrati nella tabella seguente.

MESSAGGIO	DESCRIZIONE	AZIONE CORRETTIVA
<b>POLARITY ERROR</b> SEE MANUAL	Non c'è corrispondenza tra la polarità del tipo di pompa selezionata da pannello frontale della scheda e la polarità del modulo Multiplier.	Invertire la polarità del modulo Multiplier (vedere l'appendice "Technical Information").
<b>H.V. CARD FAULT</b> SEE MANUAL	C'è un malfunzionamento nella circuiteria di lettura della corrente della scheda H.V. o nella circuiteria di controllo. Il LED corrispondente del pannello frontale lampeggia.	Spegnere e riaccendere l'unità. Se l'errore si ripresenta chiamare l'assistenza Varian.
<b>PUMP OVERCURRENT</b> SEE MANUAL	Nel modo di funzionamento Protect il valore di corrente supera la corrente di soglia per più di 0,2 secondi. Il LED del pannello frontale corrispondente alla scheda H.V. lampeggia.	Selezionare il modo START affinché il controller possa funzionare fino alla corrente di corto circuito senza soglia.
<b>REMOTE INTERLOCK</b> SEE MANUAL	Quando è presente la scheda Remote I/O e l'ingresso 1 (interlock esterno) è a livello alto (aperto), non si può accendere la scheda High Voltage, o, se è già accesa, viene spenta. Il LED corrispondente del pannello frontale lampeggia.	Rimuovere l'interlock esterno.
<b>STANDBY/INTLK</b> SEE MANUAL	E' stata rimossa la copertura dell'unità con almeno un modulo H.V. acceso, o si è cercato di accendere il modulo H.V. con la copertura aperta. Il LED corrispondente del pannello frontale lampeggia.	Chiudere la copertura.
	E' stato spento il modulo H.V. con l'interruttore Standby ON/OFF del pannello frontale, o si è cercato di accendere il modulo H.V. con lo stesso interruttore in posizione OFF. Il LED corrispondente del pannello frontale lampeggia.	Ripetere correttamente la procedura di spegnimento o di accensione.
<b>OVERTEMPERATURE</b> SEE MANUAL	Si è attivata la protezione termica del modulo H.V.. Il LED corrispondente del pannello frontale lampeggia.	Migliorare la circolazione dell'aria attorno l'unità.
<b>TEST ERROR</b> SEE MANUAL	L'auto test all'accensione ha rilevato un guasto, o non è presente alcuna scheda High Voltage nello slot 1.	Installare la scheda H.V. nello slot 1. Spegnere e riaccendere l'unità. Se l'errore si ripresenta chiamare l'assistenza Varian.
<b>CHECK HV1 CONN.</b> SEE MANUAL	La scheda High Voltage non è installata correttamente.	Spegnere il controller e staccarlo dalla rete di alimentazione. Rimuovere la scheda H.V. ed installarla nuovamente con attenzione.
<b>DEGAS UNDERCURRE</b>	La scheda MultiGauge Bayard-Alpert ha rilevato un errore di corrente di degas troppo bassa.	Spegnere e riaccendere la scheda. Se l'errore si ripresenta chiamare l'assistenza Varian.
<b>OVERCURRENT</b>	La scheda Multi Gauge UHV ha rilevato un errore di sovracorrente del filamento, o la scheda Multi Gauge Cold Cathode ha rilevato un errore di sovracorrente.	Spegnere e riaccendere la scheda. Se l'errore si ripresenta chiamare l'assistenza Varian.
<b>UNDERCURRENT</b>	Le schede Multi Gauge Bayard-Alpert o UHV hanno rilevato un errore di corrente di filamento troppo bassa (il sensore non è collegato, o il filamento del sensore è interrotto).	Verificare il collegamento del sensore e spegnere e riaccendere la scheda. Se l'errore si ripresenta chiamare l'assistenza Varian.
<b>GRID ERROR</b>	Le schede Multi Gauge Bayard-Alpert o UHV hanno rilevato un errore della griglia (la griglia del sensore non è collegata).	Spegnere e riaccendere la scheda. Se l'errore si ripresenta chiamare l'assistenza Varian.
<b>OVERTEMPERATURE</b>	Le schede Multi Gauge Bayard-Alpert o UHV o Cold Cathode hanno rilevato un errore di sovratemperatura.	Spegnere e riaccendere le schede. Se l'errore si ripresenta chiamare l'assistenza Varian.
<b>POWER SUPPLY</b>	Le schede Multi Gauge Cold Cathode o Thermocouple hanno rilevato un errore di alimentazione.	Spegnere e riaccendere le schede. Se l'errore si ripresenta chiamare l'assistenza Varian.
<b>MEAS OUT LIMITS</b>	Le schede Multi Gauge Bayard-Alpert o UHV o Cold Cathode, durante il periodo di riscaldamento, non sono state in grado di fornire una lettura significativa.	Spegnere e riaccendere le schede. Se l'errore si ripresenta chiamare l'assistenza Varian.

# GEBRAUCHSANLEITUNG

## ALLGEMEINES

Dieser Apparat ist für Fachbetriebe bestimmt. Vor Gebrauch sollte der Benutzer dieses Handbuch sowie alle weiteren mitgelieferten Zusatzdokumentationen genau lesen. Bei Nichtbeachtung - auch teilweise - der enthaltenen Hinweise, unsachgemäßem Gebrauch durch ungeschultes Personal, nicht autorisierten Eingriffen und Mißachtung der einheimischen, hier zur Geltung kommenden Bestimmungen übernimmt die Firma Varian keinerlei Haftung.

In den folgenden Abschnitten sind alle erforderlichen Informationen für die Sicherheit des Bedieners bei der Anwendung des Geräts aufgeführt. Detaillierte technische Informationen sind im Anhang "Technical Information" enthalten.

In dieser Gebrauchsanleitung werden Sicherheitshinweise folgendermaßen hervorgehoben:



Die Gefahrenhinweise lenken die Aufmerksamkeit des Bedieners auf bestimmte Vorgänge oder Praktiken, die bei unkorrekter Ausführung schwere Verletzungen hervorrufen können.



Die Warnhinweise vor bestimmten Prozeduren machen den Bediener darauf aufmerksam, daß bei Nichteinhaltung Schäden an der Anlage entstehen können.

### ANMERKUNG

Die Anmerkungen enthalten wichtige Informationen, die im Text hervorgehoben werden.

## BESCHREIBUNG DES CONTROLLERS

Der MultiVac-Controller der Firma Varian ist ein Gerät zur Steuerung von modularen oder flexiblen Ionenpumpen. Das Gerät kann im Werk nach den Angaben des Kunden voreingestellt werden oder in Einzelkomponenten geliefert werden, so daß der Kunde den Controller durch Einsetzen bzw. den Austausch zusätzlicher Karten individuell konfigurieren kann.

Die Standardausführung des MultiVac-Controllers besteht aus:

- 1 MultiVac- Grundeinheit;
- 1 'Vaclon Pump High Voltage'-Karte.

Diese Standardausführung kann durch den Einsatz zusätzlicher Karten erweitert werden. In der nachstehenden Tabelle sind die lieferbaren Karten zur Konfigurationserweiterung aufgeführt.

Für die Installation von Zusatzkarten gelten folgende Grenzen:

- maximal zwei High-Voltage-Karten;
- maximal zwei weitere Karten.

### ANMERKUNG

Die MultiVac-Controller mit der Kennnummer 929-4000/4001/4010/4011 können nicht zur Steuerung einer MultiGauge-Karte verwendet werden. Zur Installation einer MultiGauge-Karte müssen diese Controller mittels eines entsprechenden Bausatzes erweitert werden. Wenden Sie sich für genauere Informationen an den Varian-Kundendienst.

BESCHREIBUNG	TEILENUMMER
<b>MultiVac- Grundeinheit</b>	
Grundeinheit für Versorgungsspannung 220 V Ws	929-4000 929-4001 (bereits mit Karte RS 232 installiert)
Grundeinheit für Versorgungsspannung 110 V Ws	929-4010 929-4011 (bereits mit Karte RS 232 installiert)
<b>Zusatzkarten</b>	
Karte Medium Vaclon Pump High Voltage (H.V.)	929-4025 oder 929-4035
Karte Large Vaclon Pump High Voltage (H.V.)	929-4040 oder 929-4050
Karte Set Point/Remote Control	969-4110
Karte RS 232-422 Computer Interface	929-4100
Multi Gauge Bayard-Alpert	L6427-301
Multi Gauge UHV	L8321-301
Multi Gauge Cold Cathode	L6433-301
Multi Gauge Thermocouple	L6430-301

Der MultiVac-Controller kann in der Grundausführung und zusammen mit Hochspannungs- (HV)-Karten bis zu 2 Ionenpumpen von 20l/s bis 500 l/s mit positiver oder negativer Polung steuern. Er gewährleistet eine zuverlässige Ablesung von Druckwerten bis zu  $10^{-11}$  Torr und verbessert die Leistung der Pumpe innerhalb des Arbeitsbereiches.

Die MultiGauge-Karten ermöglichen eine Ermittlung des Druck mit verschiedenen Feinheiten und Meßbereichen. Der MultiVac-Controller kann LOKAL oder bei Einsatz der Karte 'Set Point Remote Control' über den Modus REMOTE I/O oder über die Karte 'RS 232-422 Computer Interface' im Modus REMOTE COMMUNICATION ferngesteuert werden.

Im Modus LOKALSTEUERUNG werden alle Steuerbefehle über ein frontales Schaltpult eingegeben. Im Modus REMOTE I/O werden die Steuerbefehle über den Steckverbinder der im hinteren Schaltpult installierten Karte 'Set Point/Remote Control' übertragen. In der Betriebsart REMOTE COMMUNICATION können alle Steuerbefehle über einen mittels einer Karte 'RS 232-422 Computer Interface' angeschlossenen Computer eingegeben werden.

## LAGERUNG

Beim Transport und bei der Lagerung der Controller müssen folgende klimatischen Verhältnisse eingehalten werden:

- Temperatur: von -20 °C bis +70 °C
- Relative Luftfeuchtigkeit: 0-95 % (nicht kondensierend)

## VOR DER INSTALLATION

Der Controller wird mit einer speziellen Schutzverpackung geliefert. Eventuelle Transportschäden müssen der zuständigen örtlichen Verkaufsstelle gemeldet werden. Beim Auspacken vorsichtig vorgehen, damit der Controller nicht fällt oder Stößen ausgesetzt wird.

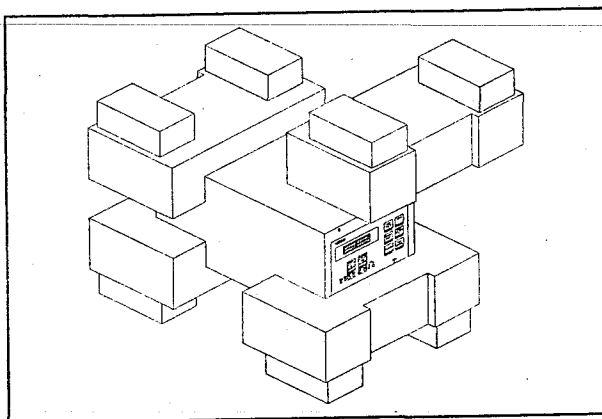

Verpackung des Controllers

Das Verpackungsmaterial muß korrekt entsorgt werden. Es ist vollständig recyclebar und entspricht der EG-Richtlinie 85/399 für Umweltschutz. Die MultiVac-Controller sind werkseitig für folgende Versorgungsspannungen ausgelegt:

- Modelle 929-4000/929-4001 für 220 V Ws (Eingangsspannung von 180 bis 265 V Ws)
- Modelle 929-4010/ 929-4011 für 110 V Ws (Eingangsspannung von 90 bis 130 V Ws)

Soll die Versorgungsspannung geändert werden, so gehen Sie wie folgt vor:

- Schalten Sie den Controller aus, und ziehen Sie das Netzkabel.
- Stellen Sie über den Umschalter auf der Rückseite des Controllers die gewünschte Versorgungsspannung ein (110 V Ws oder 220 V Ws, siehe Zeichnung).

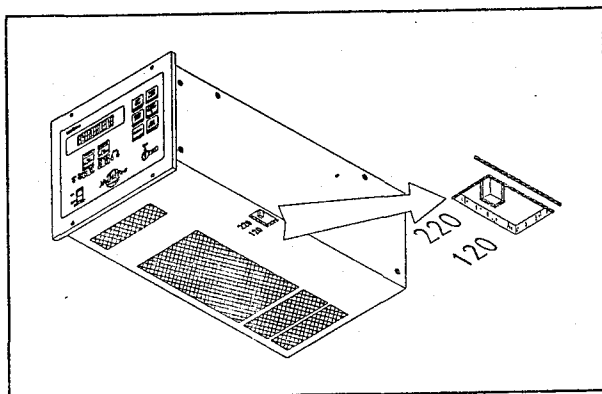

Umschalter zur Einstellung der Versorgungsspannung

Sollte ein Austausch des Netzkabels vorgenommen werden so müssen die Leiter wie folgt angeschlossen werden:  
 blau = neutral  
 braun = Phase  
 grün-gelb = Erde

INSTALLATION



Der MultiVac-Controller wird mit einem Netzkabel mit 3 Leitern und mit einem den internationalen Normen entsprechenden Netzstecker geliefert. Es sollte immer dieses Netzkabel benutzt werden, das an eine vorschriftsmäßig geerdete Steckdose anzuschließen ist, um Stromentladungen zu vermeiden.

Im Inneren des Controllers entstehen hohe Spannungen, die schwere Schäden verursachen und lebensgefährlich sein können. Vor jedem Montage- bzw. Wartungseingriff muß deshalb der Netzstecker gezogen werden.



Der Controller kann auf einen Tisch oder ein Gestell montiert werden. In beiden Fällen muß eine ungehinderte Zirkulation der Kühlluft durch die im Gehäuse vorne und unten eingelassenen Luftöffnungen gewährleistet sein.

Wenn der Controller in einem Gestell montiert wird, MUSS er in einer vier Rackeinheiten hohen Adapter-Einheit installiert werden, um zu vermeiden, daß der Controller nicht in das Gestell fällt. Die vordere Schalttafel des MultiVac-Controllers ist nicht geeignet, das gesamte Gewicht der Einheit zu tragen.

Der Controller darf nicht in Umgebungen installiert u/o benutzt werden, die Witterungseinflüssen (Regen, Frost, Schnee), Staub und aggressiven Gasen ausgesetzt sind und in denen Explosions- und erhöhte Brandgefahr besteht.

ANMERKUNG

Zur Tischaufstellung des Controllers müssen die beiden vorderen Füße ausgezogen werden. Wenn der Controller in einem Gestell installiert werden soll, müssen alle vier Füße abmontiert werden; lassen Sie bei Rack-Installation des Controllers über- und unterhalb einen Raum von wenigstens 30 mm (1,2 Zoll).

Während des Betriebs müssen folgende Umgebungsbedingungen eingehalten werden:

- Temperatur: von +0 °C bis +45 °C
- Relative Luftfeuchtigkeit: 0 - 95 % (nicht kondensierend)

Für den Anschluß des Controllers an die Pumpe muß das zum Controller gehörende Kabel benutzt werden. Detailliertere Hinweise zu weiteren Anschlußarten sowie zum Einsatz von Zusatzkarten finden Sie im Anhang "Technical Information".

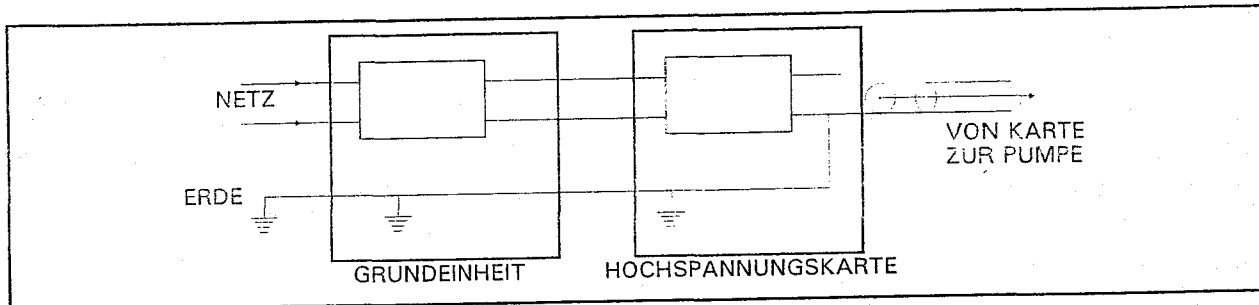

Anschlüsse

**GEBRAUCH**

In diesem Kapitel sind die wichtigsten Betriebsvorgänge aufgeführt. Für weitere Hinweise bezüglich Anschluß und Montage des bestellbaren Zubehörs verweisen wir auf das Kapitel "Use" im Anhang zu "Technical Information". Vor Benutzung des Controllers müssen sämtliche elektrischen und pneumatischen Anschlüsse ausgeführt und die Betriebsanleitung der angeschlossenen Pumpe durchlesen werden.



Steht die Pumpe auf einem Tisch, muß auf den stabilen Stand geachtet werden, da sonst die Gefahr von Personen- und Geräteschäden besteht. Die Pumpe nie einschalten, wenn der Eingangsflansch nicht am System angeschlossen bzw. nicht mit dem Schließflansch abgedeckt ist.

**Schalter und Anzeigen auf der vorderen Schalttafel des MultiVac-Controllers**

Nachstehend wird die vordere Schalttafel des MultiVac-Controllers gezeigt. Die jeweilige Bedeutung und Funktion der Schalter und Anzeigen wird in der nachstehenden Tabelle beschrieben.



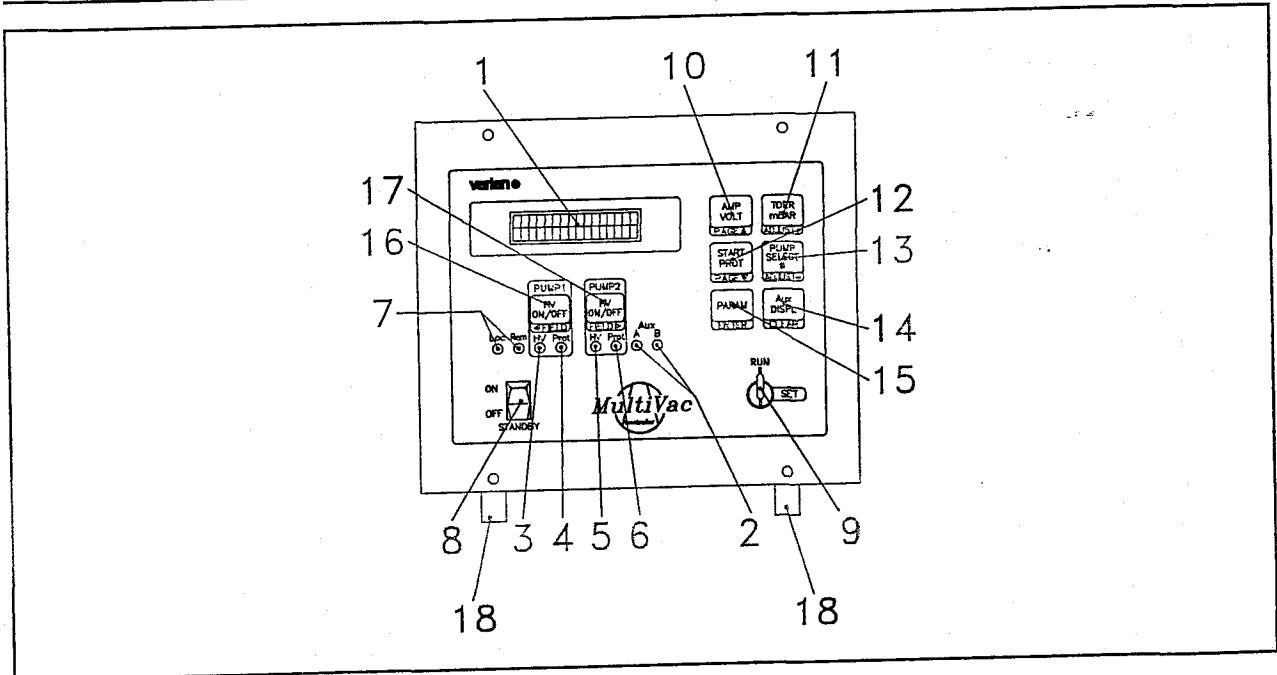

**ANMERKUNG**

Die Funktion der auf der vorderen Schalttafel des MultiVac befindlichen Schalter ist von der jeweiligen Stellung des Schlüsselschalters RUN/SET abhängig. Die negativen Schriften auf schwarzem Grund gelten, wenn der Schlüsselschalter auf RUN steht. Die roten Schriften auf weißem Grund gelten, wenn der Schlüsselschalter auf SET steht.



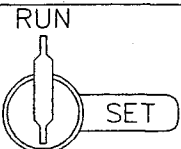
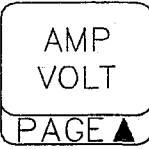

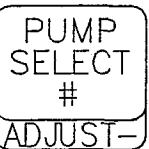
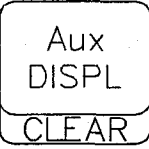
Vordere Schalttafel des MultiVac-Controllers

Pos.	Bezeichnung des Schalters/der Anzeige	Funktion des Schalters / der Anzeige
1		Rückbeleuchtetes LCD-Display, 16 Buchstaben, 2 Zeilen
2	AUX A/B	Die beiden grünen LEDs leuchten auf, wenn Zusatzkarten installiert wurden (z. B. leuchtet das LED A bei Installation der Karte 'Set Point/Remote Control' im Steckplatz Nr. 3 im Inneren der Einheit auf).
3	PUMP 1 - HV	Das gelbe LED leuchtet auf, wenn die HV-Karte der Pumpe Nr. 1 zugeschaltet wurde.
4	PUMP 1 - Prot.	Das grüne LED leuchtet auf, wenn für die Pumpe Nr. 1 die Funktionsart 'Protect' selektioniert wurde.
5	PUMP 2 - HV	Das gelbe LED leuchtet auf, wenn die HV-Karte der Pumpe Nr. 2 zugeschaltet wurde.
6	PUMP 2 - Prot.	Das grüne LED leuchtet auf, wenn für die Pumpe Nr. 2 die Funktionsart 'Protect' selektioniert wurde.
7	Loc - Rem	Die beiden grünen LEDs zeigen die jeweils gewählte Funktionsart an: - Loc steht für LOKALE Steuerung; - Rem steht für die beiden Fernsteuerungsarten REMOTE I/O und REMOTE COMMUNICATION.
8	ON OFF STANDBY	Wenn der Schalter auf OFF steht, sind die Pumpen Nr. 1 und 2 abgeschaltet; in Position ON können beide Pumpen eingeschaltet werden. Der Schalter dient zur gleichzeitigen Notabschaltung beider Pumpen.

Pos.	Bezeichnung des Schalters/der Anzeige	Funktion des Schalters / der Anzeige	
9		Über den Schlüsselschalter RUN/SET kann die Funktion der auf der vorderen Schalttafel befindlichen Schalter mit Doppelfunktion geändert werden. Die Position RUN ist die normale Position für den Pumpenbetrieb. Die Position SET ermöglicht die Eingabe von Parametern zum Pumpenbetrieb.	
		Schlüsselschalter in Position RUN	Schlüsselschalter in Position SET
10		<b>AMP/VOLT</b> Bei Betätigung dieser Taste kann auf dem LCD-Display der Strom- oder Spannungswert der über den Schalter Nr. 13 selektionierten Pumpe angezeigt werden. Ist die selektionierte Pumpe abgeschaltet, so ist die Taste nicht aktiv.	<b>PAGE ▲</b> Taste zum Übergang zur Bildschirmseite der vorigen Einstellung.
11		<b>TORR/mBAR</b> Bei Betätigung dieser Taste kann auf dem LCD-Display der Druck der über den Schalter Nr. 13 selektionierten Pumpe in Torr oder mBar angezeigt werden. Ist die selektionierte Pumpe abgeschaltet, so ist die Taste nicht aktiv.	<b>ADJUST +</b> Taste zur Modifizierung der Einstellungswerte. Die Taste ermöglicht außerdem die Aktivierung der Standardabschaltung einer einzigen Pumpe.
12		<b>START/PROTECT</b> Durch Betätigung dieser Taste wird der Funktionsmodus der über den Schalter Nr. 13 selektionierten Pumpe von START auf PROTECT und umgekehrt geändert. Wurde für eine Pumpe der Modus PROTECT selektioniert, so leuchtet das entsprechende grüne LED (4) oder (6) auf.	<b>PAGE ▼</b> Übergang zur Bildschirmseite der nächstfolgenden Einstellung.
13		<b>PUMP SELECT</b> Über Betätigung dieser Taste wird die für den nächsten Arbeitszyklus einzusetzende Pumpe selektioniert (z.B. bei Umschaltungen der Funktionsart oder zur Abbildung von Parametern zur Pumpeneinstellung). Die selektionierte Pumpe wird auf dem Display durch das Symbol # gefolgt von der Zahl 1 oder 2 angezeigt. Bei Installation eines einzigen H.V.-Moduls ist die Taste nicht aktiv.	<b>ADJUST -</b> Taste zur Modifizierung der Einstellungswerte. Die Taste ermöglicht außerdem die Aktivierung der Standardabschaltung einer einzigen Pumpe.
14		<b>Aux DISPL</b> Ermöglicht die Selektion der Abbildung auf dem Display der abgelesenen Parameter einer bestimmten MultiGauge-Karte.	<b>CLEAR</b> Über diese Taste kommen Sie auf die vorige Selektion zurück, sofern die Taste ENTER noch nicht gedrückt wurde; bei zweimaliger Betätigung kommen Sie von jeder beliebigen Bildschirmseite auf die erste Seite des selektionierten Menüs zurück.
15		<b>PARAM</b> Bei Betätigung dieser Taste werden die Parameter der über die HV-Karte selektionierten Pumpe abgebildet, die auf dem Display durch das #-Symbol identifiziert wird. <b>Pump Size:</b> Abmessungen der selektionierten Pumpe <b>I<sub>max</sub>:</b> Kurzschlußstrom der selektionierten Pumpe <b>I<sub>prot</sub>:</b> Wert der Zuschaltung der Schutzfunktion "Overcurrent". <b>PWR<sub>max</sub>:</b> maximale Leistung der selektionierten Pumpe. <b>V<sub>max</sub>:</b> Polarität (+/-) und maximale Spannung der selektionierten Pumpe. <b>Fixed V oder Step V:</b> selektionierter Betriebsmodus. <b>STP1/STP2:</b> Die Set-Point-Wert 1 und 2 zur Information, ob die Einstellungswerte überschritten wurden (das Symbol 'E' bedeutet, daß der entsprechende Set-Point überschritten wurde oder daß die HV-Karte abgeschaltet ist).  <b>ANMERKUNG:</b> Die Angaben zu den Set-Points werden nur angezeigt, wenn die Karte 'Set Point/Remote Control' installiert ist.	<b>ENTER</b> Taste zur Bestätigung des abgebildeten Parameters.



Pos.	Bezeichnung des Schalters/der Anzeige	Funktion des Schalters / der Anzeige	
		Schlüsselschalter (9) in Position RUN	Schlüsselschalter (9) in Position SET
16		<p><b>PUMP 1 HV ON/OFF</b></p> <p>Über Betätigung dieser Taste kann die HV-Karte der Pumpe Nr. 1 ein- oder ausgeschaltet werden (bistabiler Schalter). Die Taste wirkt unabhängig zur über das Display selektierten Linie. Zur Umschaltung der HV-Karte muß die Taste STANDBY ON/OFF (8) auf ON stehen.</p>	<p><b>&lt; FIELD</b></p> <p>Diese Taste hat folgende drei Funktionen:</p> <ul style="list-style-type: none"> <li>- Wechsel des abgebildeten Menüs (View, Mode, Set);</li> <li>- Selektion eines Feldes auf der Bildschirmseite während des Einstellungsvorgangs;</li> <li>- Wechsel von der Bildschirmseite zur Pumpe Nr. 1 auf die Seite der Pumpe Nr. 2 und umgekehrt, wenn beide Pumpen zugeschaltet sind.</li> </ul>
17		<p><b>PUMP 2 HV ON/OFF</b></p> <p>Über Betätigung dieser Taste kann die HV-Karte der Pumpe Nr. 2 ein- oder ausgeschaltet werden (bistabiler Schalter). Die Taste wirkt unabhängig zur über das Display selektierten Linie. Zur Umschaltung der HV-Karte muß die Taste STANDBY ON/OFF (8) auf ON stehen.</p>	<p><b>FIELD &gt;</b></p> <p>Diese Taste hat folgende drei Funktionen:</p> <ul style="list-style-type: none"> <li>- Wechsel des abgebildeten Menüs (View, Mode, Set);</li> <li>- Selektion eines Feldes auf der Bildschirmseite während des Einstellungsvorgangs;</li> <li>- Wechsel von der Bildschirmseite zur Pumpe Nr. 1 auf die Seite der Pumpe Nr. 2 und umgekehrt, wenn beide Pumpen zugeschaltet sind.</li> </ul>
18		Vordere Standfüße ausgezogen (nur bei Tischaufstellung)	

**Hintere Schalttafel des MultiVac-Controllers**

Die nebenstehende Abbildung zeigt die Schalter und Anschlußstellen der hinteren Schalttafel des MultiVac-Controllers. Die Abbildung zeigt die Auslegung bei Einsatz einer HV-Karte, einer Karte 'Set Point/Remote Control' und einer Karte 'RS 232/422 Computer Interface'.

**BEDIENUNG**

**Bedienungsarten**

Der MultiVac-Controller kann in den Bedienungsarten **LOKALE STEUERUNG** sowie **FERNSTEUERUNG** Eingang/Ausgang (I/O) oder **REMOTE COMMUNICATION** betrieben werden.

Wenn keine Zusatzkarte installiert ist (Remote I/O / Set-Points, RS232-422), kann der Controller nur lokal gesteuert werden. In der Betriebsart **LOKALE STEUERUNG** müssen alle Steuerbefehle über die frontale Schalttafel eingegeben werden.

Wenn nur die Karte 'Remote I/O / Set-Points' installiert ist, kann der Controller in den Bedienungsarten **LOKALE STEUERUNG** und **FERNSTEUERUNG I/O** betrieben werden. In der Bedienungsart Fernsteuerung I/O werden die Steuerbefehle über die Steckverbindungen der Eingänge und Ausgänge auf der hinteren Schalttafel übertragen. Nach einem Ausfall der Versorgungsspannung nimmt der MultiVac-Controller die vorher selektierte Bedienungsart automatisch wieder auf.

Bei Installation der Karte 'RS232-422' und bei Freigabe über entsprechende Einstellung des Dip-Switch-Schalters Nr. 3 (siehe Anhang 'Technical Information') kann der Controller in den Bedienungsarten **LOKALE STEUERUNG** und **REMOTE COMMUNICATION** betrieben werden; bei der Fernsteuerung über Computer werden die Steuersignale über die Schnittstelle RS232-422 übertragen. Nach einem Ausfall der Versorgungsspannung schaltet sich der MultiVac-Controller immer in die Bedienungsart **REMOTE COMMUNICATION**, auch wenn vorher die Bedienungsart **LOKALE STEUERUNG** selektiert war.

Wenn beide Karten (RS232-422 und Remote I/O / Set-Points) installiert sind, kann der Controller in allen drei Bedienungsarten betrieben werden. Nach einem Ausfall der Versorgungsspannung schaltet sich der MultiVac-Controller immer in die Bedienungsart **REMOTE COMMUNICATION**, auch wenn vorher die Bedienungsarten **LOKALE STEUERUNG** oder **FERNSTEUERUNG I/O** selektiert war.

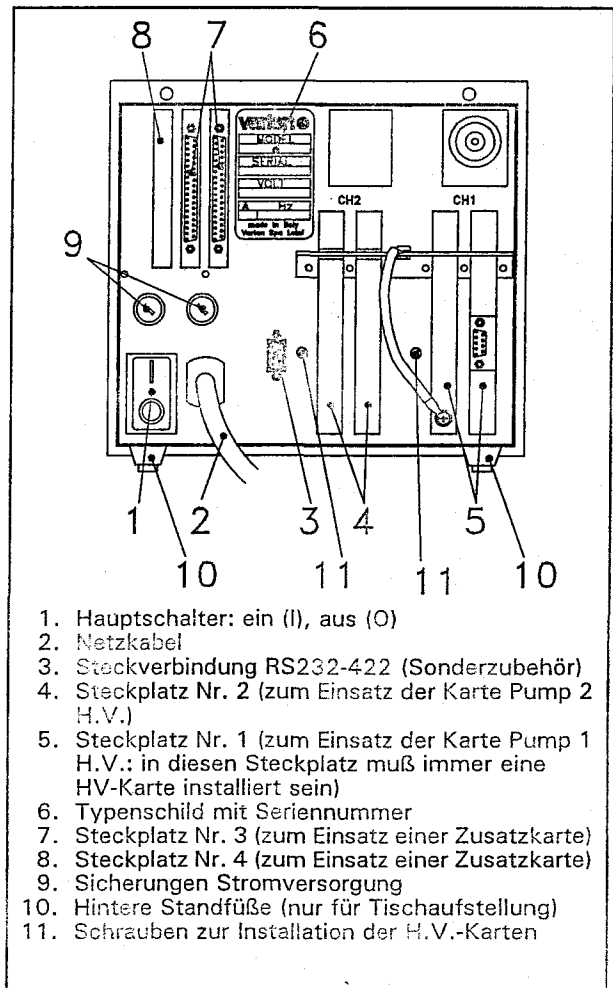

1. Hauptschalter: ein (I), aus (O)
2. Netzkabel
3. Steckverbindung RS232-422 (Sonderzubehör)
4. Steckplatz Nr. 2 (zum Einsatz der Karte Pump 2 H.V.)
5. Steckplatz Nr. 1 (zum Einsatz der Karte Pump 1 H.V.: in diesen Steckplatz muß immer eine HV-Karte installiert sein)
6. Typenschild mit Seriennummer
7. Steckplatz Nr. 3 (zum Einsatz einer Zusatzkarte)
8. Steckplatz Nr. 4 (zum Einsatz einer Zusatzkarte)
9. Sicherungen Stromversorgung
10. Hintere Standfüße (nur für Tischaufstellung)
11. Schrauben zur Installation der H.V.-Karten

*Hintere Schalttafel des MultiVac-Controllers*

Der Controller kann in folgenden Betriebsarten betrieben werden:

- Betriebsart **START** oder **PROTECTED**;
- Betriebsart **STEP** oder **FIXED VOLTAGE**.

In der Betriebsart **START** arbeitet der Controller unabhängig vom Pumpenzustand bei voller Leistung bis zum voreingestellten Kurzschlußstromwert. Diese Betriebsart muß zur Steuerung von Hochdruckpumpen gewählt werden.

In der Betriebsart **PROTECTED** werden der Stromausgangswert des Controllers begrenzt und die Hochspannung abgeschaltet, sobald der Strom den voreingestellten Schwellenwert länger als 0,2 Sekunden überschreitet.

In der Betriebsart **STEP** wird die Ausgangsspannung des Controllers umgeschaltet, sobald der von der Pumpe aufgenommene Strom einen bestimmten Grenzwert erreicht.

In der Betriebsart **FIXED VOLTAGE** bleibt die Ausgangsspannung permanent auf dem voreingestellten Wert.

**ANMERKUNG**

Der Controller ist werkseitig wie folgt eingestellt:

- Bedienungsart **LOCAL** (lokale Steuerung), wenn die Karte 'Computerschnittstelle' nicht installiert ist;
- Bedienungsart **REMOTE** (Fernsteuerung), wenn die Karte 'Computerschnittstelle' installiert ist;
- Schlüsselschalter **RUN/SET** in Stellung **RUN**;
- Betriebsart **START, STEP VOLTAGE**.

Während des normalen Betriebs des Controllers muß der Schlüsselschalter **RUN/SET** auf 'RUN' gestellt sein.

Nähere Informationen können Sie dem Anhang 'Technical Information' entnehmen.

**Zuschaltung der H.V.- (Hochspannungs-)Karte**

Zur Zuschaltung der H.V.-Karte muß der Schlüsselschalter **RUN/SET** auf **RUN** stehen; der **STANDBY**-Schalter und der Hauptschalter auf der hinteren Schalttafel müssen auf **ON** stehen.

**ANMERKUNG**

Wenn nur eine H.V.-Karte installiert ist, beziehen sich beide Kanäle des Controllers auf die Pumpe Nr. 1; bei Installation beider H.V.-Karten beziehen sich die Kanäle des Controllers auf jeweils eine Pumpe.

Auf dem Display erscheint folgende Meldung:

1	#	2	0	S	t	a	r	C	e	l	l		
---	---	---	---	---	---	---	---	---	---	---	---	--	--

Betätigen Sie den Schalter **PUMP 1 HV ON/OFF** (bzw. **PUMP 2 HV ON/OFF**, je nach dem, welche Pumpe gesteuert werden soll); auf dem Display erscheint folgende Meldung:

1	#	C	u	r	r	e	n	t	(	A	)		
---	---	---	---	---	---	---	---	---	---	---	---	--	--

Drücken Sie zur Abbildung des Spannungswertes die Taste **AMP/VOLT**.

Drücken Sie zur Anzeige des Druckwertes die Taste **TORR/mBAR**.

**ANMERKUNG**

Die Umschaltung findet nur für den mit # gekennzeichneten Kanal statt. Durch Betätigung der Taste **PUMP SELECT** kann das #-Symbol auf den jeweils anderen Kanal gebracht werden.

Neben dem auf dem Display angezeigten Wert erscheint eines der in der nachstehenden Tabelle aufgeführten Symbole:

Symbol	Funktion
>	Erhöhung des Wertes
<	Reduzierung des Wertes
■	Der Wert bleibt unverändert

**ANMERKUNG**

Sollte die Spannung unter einem bestimmten Wert liegen ( $1 \times 10^7$  A), so kann der Druck nicht abgelesen werden und auf dem Display erscheint die Meldung 'LOW PRESSURE'.

**Funktion der Gebläse**

Wenn der Controller bei ausgeschalteten HV-Karten eingeschaltet wird, laufen die Gebläse auf einer niedrigen Stufe, so daß ein leichter Luftstrom zur Kühlung der Einheit erzeugt wird.

Sobald eine HV-Karte zugeschaltet wird, rotieren die Gebläse mit maximaler Drehzahl, so daß die Kühlung der Einheit auch bei Spannungswerten über 5 KV und bei einer Ausgangsleistung über 30 KW gewährleistet ist.

# GEBRAUCHSANLEITUNG

## Zuschaltung der MultiGauge-Karten

Gehen Sie zur Zuschaltung der MultiGauge-Karten wie folgt vor:

- Schalten Sie den Controller über den auf der hinteren Schalttafel befindlichen Hauptschalter ein.
- Stellen Sie den auf der vorderen Schalttafel installierten Schalter **STANDBY/INTERLOCK** auf **ON**. Auf dem Display erscheint für einige Sekunden die Meldung **'MULTIVAC INITIALIZATION'** sowie die Angabe der für die Kanäle 1 und 2 installierten HV-Karten.
- Drücken Sie den Schalter **AUX DISPL**; auf dem Display wird die Art der in den Steckplätzen A und B (Steckplatz 3 und 4) installierten Karte angezeigt.
- Stellen Sie den Schlüsselschalter auf **SET**; auf dem Display erscheint die Meldung **'MAIN MENU - VIEW'**.
- Drücken Sie die **ENTER**-Taste; auf dem Display wird einer der Kanäle abgebildet. Über die Tasten **FIELD LEFT** und **FIELD RIGHT** kann die jeweils zu aktivierende Karte abgebildet werden.
- Drücken Sie die **ENTER**-Taste. Sollte die Karte durch eine Störung ausgefallen sein, so wird auf dem Display der Grund der Störung abgebildet.
- Drücken Sie die **ENTER**-Taste; sie werden nun gefragt, ob die Gauge-Karte zugeschaltet werden soll. Die standardmäßige Einstellung ist **YES**; drücken Sie eine der **FIELD**-Tasten, wenn Sie **NO** selektionieren wollen.
- Drücken Sie die **ENTER**-Taste; der Controller aktiviert nun den Sensor der Gauge-Karte; auf dem Display erscheint für etwa 10 - 20 Sekunden die Meldung **'WARM UP'**.

Sobald die Gauge-Karte zugeschaltet ist, wird auf dem Display der abgelesene Druckwert angezeigt.

## Ableseung der Parameter zum Pumpenbetrieb

Bei einer zugeschalteten HV-Karte können auf dem Display über Betätigung der Taste **PARAM** die Parameter zum Betrieb der Pumpe abgebildet werden. Es erscheinen folgende Meldungen:

1	#	20	S	t	a	r	C	e	l	l				

1	#	I	m	a	x	1	5	0	m	A				

1	#	I	p	r	o	t	2	0	m	A				

1	#	P	W	R	m	a	x	1	5	0	W			

1	#	V	m	a	x	-	7	0	0	0	V			

1	#	S	T	E	P	V								

## Abschaltung der HV-Karte

Drücken Sie zur Abschaltung einer der HV-Karten die entsprechende Taste **PUMP HV ON/OFF** auf der vorderen Schalttafel des Controllers.

Stellen Sie zur gleichzeitigen Notabschaltung beider Pumpen die auf der vorderen Schalttafel des Controllers installierte Taste **STANDBY/INTERLOCK** auf **OFF**. Die **LEDS** der HV-Karten blinken auf, und auf dem Display erscheint für die Dauer von etwa 5 Sekunden die Meldung:

S	T	A	N	D	B	Y	/	I	N	T	L	K		
S	E	E	M	A	N	U	A	L						

Danach kehren die Anzeigen des Displays in den normalen Status zurück.

## WARTUNG

Die MultiVac-Controller sind wartungsfrei. Eventuell erforderliche Eingriffe müssen von dazu befugtem Fachpersonal ausgeführt werden.

Bei Störungen kann der Varian-Reparaturdienst bzw. der "Varian advanced exchange service" in Anspruch genommen werden, der für den Austausch defekter Controller sorgt.



Vor jedem Eingriff am Controller muß der Netzstecker gezogen werden.

Eine eventuelle Verschrottung muß unter Einhaltung der einschlägigen landesüblichen Vorschriften erfolgen.

## FEHLERMELDUNGEN

In einigen Störungsfällen zeigt das Selbstdiagnosesystem des Controllers die in der nachstehenden Tabelle zusammengefaßten Meldungen an.

MELDUNG	BESCHREIBUNG	STÖRUNGSBEHEBUNG
POLARITY ERROR SEE MANUAL	Keine Übereinstimmung zwischen der Polarität der über die vordere Schalttafel bzw. die entsprechende Karte selektierten Pumpe und der Polarität des Multiplier-Moduls.	Umkehrung der Polung des Multiplier-Moduls (siehe Anhang 'Technical Information').
H.V. CARD FAULT SEE MANUAL	Störung im Schaltkreis der Ablesung des Stroms der HV-Karte oder Störung im Steuerkreis. Das entsprechende LED auf der vorderen Schalttafel blinkt auf.	Schalten Sie den Controller aus und wieder ein. Sollte die Störung weiterhin vorliegen, so wenden Sie sich an den Varian-Kundendienst.
PUMP OVERCURRENT SEE MANUAL	In der Betriebsart 'Protect' wurde der voreingestellte Stromschwellenwert mehr als 0,2 Sekunden lang überschritten. Das LED der entsprechenden HV-Karte auf der vorderen Schalttafel blinkt auf.	Wählen Sie den Betriebsmodus START, so daß der Controller ohne Kurzschlußstromschwellenwert betrieben werden kann.
REMOTE INTERLOCK SEE MANUAL	Auf dem Eingang Nr. 1 (externe Sperre) der Karte 'Remote I/O ist ein hoher Wert präsent (offen), so daß die HV-Karte nicht aktiviert werden kann. Das entsprechende LED auf der vorderen Schalttafel blinkt auf.	Bauen Sie die externe Sperrvorrichtung aus.
STANDBY/INTLK SEE MANUAL	Das Gehäuse des Controllers wurde bei aktiviertem HV-Modul geöffnet, oder bei geöffnetem Gehäuse wurde der Versuch einer Zuschaltung des HV-Moduls unternommen. Das entsprechende LED auf der vorderen Schalttafel blinkt auf.	Schließen Sie das Gehäuse des Controllers.
	Über den auf der vorderen Schalttafel befindlichen Schalter ON/OFF wurde das HV-Modul abgeschaltet bzw. es wurde der Versuch einer Zuschaltung unternommen, während der ON/OFF-Schalter auf 'OFF' stand. Das entsprechende LED auf der vorderen Schalttafel blinkt auf.	Führen Sie den vorgeschriebenen Vorgang der Ein- und Ausschaltung durch.
OVERTEMPERATURE SEE MANUAL	Der Überhitzungsschutz des HV-Moduls wurde aktiviert. Das entsprechende LED auf der vorderen Schalttafel blinkt auf.	Sorgen Sie für bessere Kühlungsbedingungen.
TEST ERROR SEE MANUAL	Bei Einschaltung des Controllers wurde während des Selbsttests eine Störung angetroffen, oder im Steckplatz Nr. 1 ist keine HV-Karte präsent.	Setzen Sie die HV-Karte in den Steckplatz Nr. 1 ein. Schalten Sie den Controller aus und wieder ein. Sollte die Störung weiterhin vorliegen, so wenden Sie sich an den Varian-Kundendienst.
CHECK HV1 CONN. SEE MANUAL	Die HV-Karte ist nicht vorschriftsmäßig installiert.	Schalten Sie den Controller aus, und ziehen Sie den Netzstecker. Bauen Sie die HV-Karte aus, und setzen Sie sie mit Umsicht wieder in den Steckplatz ein.
DEGAS UNDERCURR	Die Bayard-Alpert-MultiGauge-Karte hat einen zu niedrigen Degas-Stromwert angetroffen.	Schalten Sie die Karte aus und wieder ein. Sollte die Störung weiterhin vorliegen, so wenden Sie sich an den Varian-Kundendienst.
OVERCURRENT	Die UV-MultiGauge-Karte oder die Cold Cathode-MultiGauge-Karte hat einen Überstromfehler in der Verkabelung des Controllers angetroffen.	Schalten Sie die Karte aus und wieder ein. Sollte die Störung weiterhin vorliegen, so wenden Sie sich an den Varian-Kundendienst.
UNDERCURRENT	Die Bayard-Alpert- oder die UV-MultiGauge-Karte hat eine zu niedrige Spannung ermittelt (der Sensor ist nicht angeschlossen oder es liegt eine Unterbrechung der Verkabelung des Sensors vor).	Kontrollieren Sie den vorschriftsmäßigen Anschluß des Sensors; schalten Sie die Karte aus und wieder ein. Sollte die Störung weiterhin vorliegen, so wenden Sie sich an den Varian-Kundendienst.
GRID ERROR	Die Bayard-Alpert- oder die UV-MultiGauge-Karte hat eine Anomalie des Gridkontaktes ermittelt (der Gridkontakt des Sensors ist nicht angeschlossen).	Schalten Sie die Karte aus und wieder ein. Sollte die Störung weiterhin vorliegen, so wenden Sie sich an den Varian-Kundendienst.
OVERTEMPERATURE	Die Bayard-Alpert- oder die UV-MultiGauge-Karte oder die Cold Cathode-Karte hat eine Überhitzungsstörung ermittelt.	Schalten Sie die Karte aus und wieder ein. Sollte die Störung weiterhin vorliegen, so wenden Sie sich an den Varian-Kundendienst.
POWER SUPPLY	Die Cold Cathode-MultiGauge-Karte oder die Thermocouple-Karte hat eine Störung der Versorgungsspannung angetroffen.	Schalten Sie die Karte aus und wieder ein. Sollte die Störung weiterhin vorliegen, so wenden Sie sich an den Varian-Kundendienst.
MEAS OUT LIMITS	Die Bayard-Alpert- oder die UV-MultiGauge-Karte oder die Cold Cathode-Karte konnte in der Beheizungsphase kein signifikantes Signal ermitteln.	Schalten Sie die Karte aus und wieder ein. Sollte die Störung weiterhin vorliegen, so wenden Sie sich an den Varian-Kundendienst.

**INDICATIONS GENERALES**

Cet appareillage a été conçu en vue d'une utilisation professionnelle. Il est conseillé à l'utilisateur de lire attentivement cette notice d'instructions ainsi que toute autre indication supplémentaire fournie par Varian, avant l'utilisation de l'appareillage. Varian décline par conséquent toute responsabilité en cas d'observation totale ou partielle des instructions données, d'utilisation incorrecte de la part d'un personnel non formé, d'opérations non autorisées ou d'un emploi contraire aux réglementations nationales spécifiques.

Les paragraphes suivants donnent toutes les indications nécessaires à garantir la sécurité de l'opérateur pendant l'utilisation de l'appareillage. Des renseignements plus détaillés se trouvent dans l'appendice "Technical Informations".

Cette notice utilise les signes conventionnels suivants:



Les messages de danger attirent l'attention de l'opérateur sur une procédure ou une manoeuvre spéciale qui, si elle n'est pas effectuée correctement, risque de provoquer de graves lésions.



Les messages d'attention apparaissent avant certaines procédures qui, si elles ne sont pas observées, pourraient endommager sérieusement l'appareillage.

**NOTE**

Les notes contiennent des renseignements importants, isolés du texte.

**DESCRIPTION DU CONTROLEUR**

Le contrôleur MultiVac de la société Varian est un contrôleur modulaire et flexible pour les pompes ioniques. Cette unité peut être préconfigurée en usine selon les exigences du client, ou bien les différentes pièces peuvent être commandées séparément et l'utilisateur peut ajouter ou modifier les possibilités du contrôleur, simplement en introduisant ou en enlevant des cartes optionnelles.

La configuration minimum du contrôleur MultiVac est la suivante:

- 1 unité de base MultiVac
- 1 carte Vaclon Pump High Voltage

La configuration minimum peut être étendue par l'adjonction de cartes optionnelles. Le tableau qui suit indique toutes les cartes optionnelles disponibles.

Lors de l'installation de cartes optionnelles, il faut veiller à ajouter:

- un maximum de deux cartes High Voltage
- un maximum de deux autres cartes

**NOTE**

Les contrôleurs MultiVac au numéro de pièce 929-4000/4001/4010/4011 ne peuvent commander une carte MultiGage. Pour installer une carte MultiGage, le contrôleur doit être mis à jour à l'aide d'un kit spécial. Pour plus de détails, contacter le service après-vente Varian.

DESCRIPTION	NUMERO DE PIECE
<b>Unité de Base MultiVac</b>	
Unité de Base pré-équipée pour 9 une tension d'alimentation de 220 Vac	929-4000 929-4001 (à carte RS-232 installée)
Unité de Base pré-équipée pour une tension d'alimentation de 110 Vac	929-4010 929-4011 (à carte RS-232 installée)
<b>Cartes Optionnelles</b>	
Cartes Medium Vaclon Pump High Voltage (H.V.)	929-4025 ou 929-4035
Carte Large Vaclon Pump High Voltage (H.V.)	929-4040 ou 929-4050
Carte Set Point/Remote Control	969-4110
Carte RS 232-422 Computer Interface	929-4100
Multi Gauge Bayard-Alpert	L6427-301
Multi Gauge UHV	L8321-301
Multi Gauge Cold Cathode	L6433-301
Multi Gauge Thermocouple	L6430-301*

Le contrôleur MultiVac, en configuration de base et avec les cartes H.V., peut contrôler un maximum de deux pompes ioniques, de la 20 l/s à la 500 l/s, à polarité positive ou négative. Il permet de procéder à des lectures fiables de pression jusqu'à  $10^{-11}$  Torr, en optimisant les performances de la pompe sur tout le champ opérationnel.

Les cartes Multi Gauge permettent de procéder à des lectures de pression aux précisions et champs de mesure différents.

Le contrôleur MultiVac peut être commandé soit en mode LOCAL soit en mode ELOIGNE E/S en cas d'installation de la carte Set Point Remote Control, soit encore en mode TELEGESTION en cas d'installation de la carte RS 232-422 Computer Interface.

Dans le mode LOCAL, toutes les commandes sont données par l'intermédiaire du tableau frontal. Dans le mode ELOIGNE E/S, toutes les commandes sont données par le connecteur de la carte Set Point/Remote Control présente sur le tableau dorsal. Dans le mode TELEGESTION, toutes les commandes sont données par un ordinateur principal à travers la carte RS 232-422 Computer Interface.

**EMMAGASINAGE**

Pendant le transport et l'emménagement du contrôleur, il faudra veiller à respecter les conditions environnementales suivantes:

- température: de  $-20^{\circ}\text{C}$  à  $+70^{\circ}\text{C}$
- humidité relative: 0 - 95 % (non condensante).

**PREPARATION POUR L'INSTALLATION**

Le contrôleur est fourni dans un emballage de protection spécial; si l'on constate des marques de dommages pouvant s'être produits pendant le transport, contacter aussitôt le bureau de vente local.

Pendant l'opération d'ouverture de l'emballage, veiller tout particulièrement à ne pas laisser tomber le contrôleur et à ne lui faire subir aucun choc.

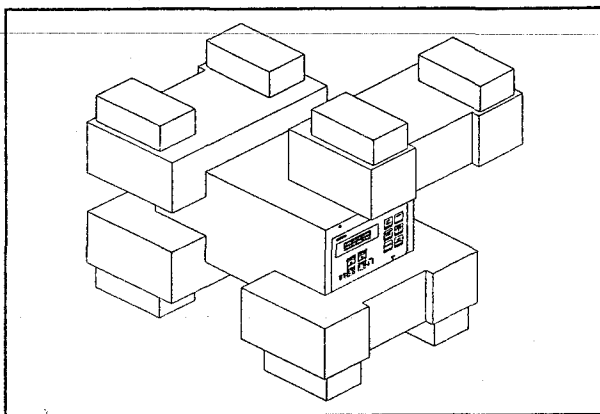

Emballage du contrôleur

Ne pas jeter l'emballage dans la nature. Le matériel est entièrement recyclable et il est conforme aux directives CEE 83/399 en matière de protection de l'environnement.

Le contrôleur MultiVac est pré-équipé en usine pour les tensions d'alimentation suivantes:

- modèles 929-4000/929-4001 pour 220 Vac (tension d'entrée de 180 à 265 Vac)
- modèles 929-4010/929-4011 pour 110 Vac (tension d'entrée de 90 à 130 Vac).

S'il est nécessaire de changer la tension d'alimentation, procéder comme suit:

- Eteindre le contrôleur et débrancher le câble d'alimentation du réseau.
- Sur le fond du contrôleur, sélectionner la tension d'alimentation voulue, en déplaçant le commutateur sur la position 110 Vac ou 220 Vac, comme l'indique la figure ci-dessous.

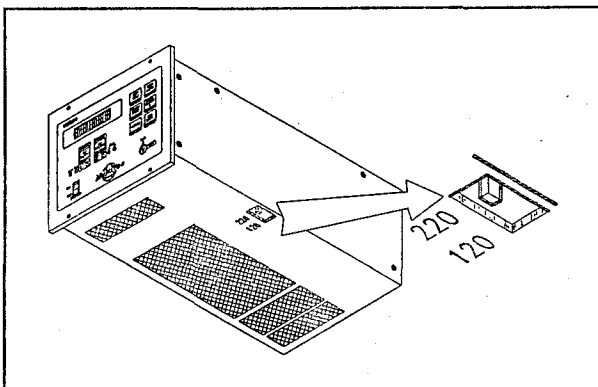

Commutateur de Sélection de la Tension d'Alimentation

S'il est nécessaire de changer le câble d'alimentation, le câblage doit être effectué de la façon suivante:

- bleu = neutre
- marron = phase
- jaune-vert = terre

INSTALLATION



Le contrôleur MultiVac est pourvu d'un câble d'alimentation à 3 fils avec fiche de sécurité (approuvée à l'échelle internationale). Utiliser ce câble d'alimentation ainsi que la fiche avec une prise munie de connexion à la terre, pour éviter tout risque d'électrocution. S'assurer que la connexion à la terre est correctement effectuée.

A l'intérieur du contrôleur se développent de hautes tensions qui peuvent causer de graves dommages et même la mort. Avant d'effectuer toute opération d'installation ou d'entretien du contrôleur, le débrancher de la prise d'alimentation.



Le contrôleur peut être utilisé aussi bien comme unité de table que comme module à rack. Il doit, en tout cas, être placé de façon à ce que l'air puisse circuler librement à travers les trous d'aération situés sur la couverture supérieure et inférieure.

Si le contrôleur est utilisé comme module à rack, il DOIT être inséré dans un adaptateur haut de quatre unités de rack, pour éviter qu'il ne tombe à l'intérieur du rack lui-même. Le tableau frontal du MultiVac n'est pas prévu pour supporter le poids de l'unité.

Ne pas installer ni utiliser le contrôleur dans des milieux exposés à des agents atmosphériques (pluie, gel, neige), à des poussières, à des gaz de combat ainsi que dans des milieux explosifs ou à risque élevé d'incendie.

NOTE

Si le contrôleur est utilisé comme unité de table, extraire les deux pieds frontaux. Si le contrôleur est installé dans un rack, enlever les quatre pieds et le placer de manière à avoir un espace libre d'au moins 30 mm (1,2 pouces) au-dessus et au-dessous.

Pendant le fonctionnement, il est nécessaire de respecter les conditions environnementales suivantes:

- température: de 0°C à +45°C
- humidité relative: 0 - 90% (non condensante).

Pour connecter le contrôleur à la pompe, utiliser le câble spécial fourni en option.

Voir l'appendice "Technical Information" pour toutes informations détaillées sur ces connexions et sur d'autres connexions ainsi que sur l'installation des cartes en option.

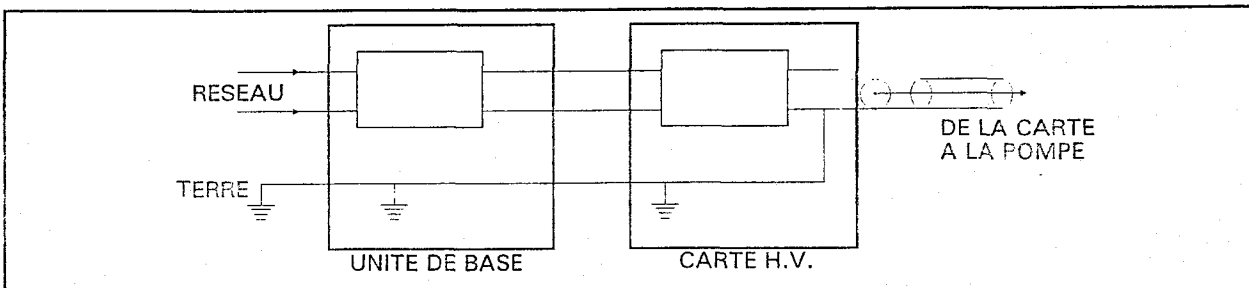

Connexions des Masses

# MODE D'EMPLOI

## UTILISATION

Dans ce paragraphe, on indique les principales procédures opérationnelles. Pour tous autres détails et pour les procédures concernant des connexions ou des éléments en option, se reporter au paragraphe "USE" de l'appendice "Technical Informations".

Avant d'utiliser le contrôleur, effectuer toutes les connexions électriques et pneumatiques et se reporter à la notice de la pompe connectée.



Pour éviter tous dommages aux personnes et à l'appareil, si la pompe est placée sur une table, s'assurer que celle-ci est parfaitement stable. Ne jamais faire fonctionner la pompe si la bride d'entrée n'est pas connectée au système ou n'est pas fermée à l'aide de la bride de fermeture.

## Commandes et Diodes du Tableau Frontal du MultiVac

La figure suivante présente le tableau frontal du contrôleur MultiVac.

La signification et la fonction des commandes et des diodes sont indiquées dans le tableau suivant.

### NOTE

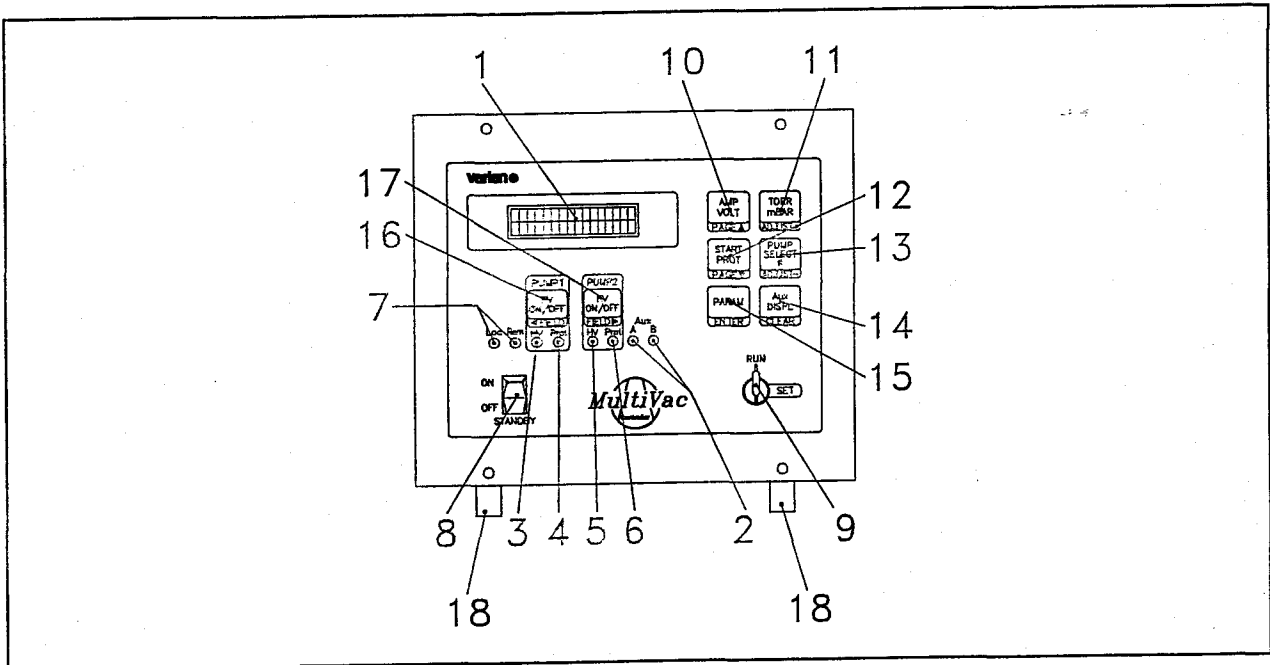

La signification des touches du tableau frontal du MultiVac change en fonction de la position de la clé RUN-SET. Les inscriptions blanches sur fond noir sont valables lorsque la clé est en position RUN.

Les inscriptions rouges sur fond blanc sont valables lorsque la clé est en position SET.



Commandes du Tableau Frontal du MultiVac

Réf.	Nom Commande/Diode	Description de la Commande/Diode
1		Afficheur à cristaux liquides, à matrice de points, éclairé par l'arrière, 16 caractères, 2 lignes.
2	AUX A/B	Deux DEL vertes allumées si les cartes en option sont installées (par exemple, si la carte Set Point/Remote Control est installée dans le slot #3 à l'intérieur de l'unité, la DEL A est allumée).
3	PUMP 1 - HV	DEL jaune allumée lorsque la carte H.V. de la pompe 1 est allumée.
4	PUMP 1 - Prot.	DEL verte allumée lorsque le mode de fonctionnement Protect pour la pompe 1 a été sélectionné.
5	PUMP 2 - HV	DEL jaune allumée lorsque la carte H.V. de la pompe 2 est allumée.
6	PUMP 2 - Prot.	DEL verte allumée lorsque le mode de fonctionnement Protect pour la pompe 2 a été sélectionné.
7	Loc - Rem	Deux DEL vertes qui indiquent le mode de fonctionnement sélectionné: - Loc est allumée lorsque le mode de fonctionnement LOCAL est sélectionné; - Rem est allumée lorsque le mode de fonctionnement ELOIGNE E/S ou TELEGESTION est sélectionné.
8	ON OFF STANDBY	Lorsque la touche est en position OFF, les pompes 1 et 2 sont désactivées; lorsqu'elle est en position ON, les pompes peuvent être allumées. En conditions d'urgence, elle permet d'arrêter les deux pompes en même temps.

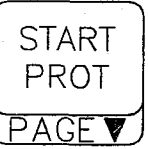
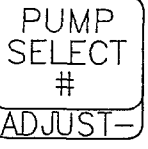
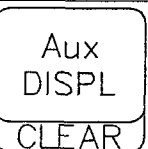
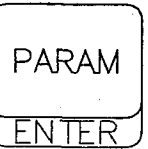
Réf.	Nom Commande/Diode	Description de la Commande/Diode	
9		<p>Le sélecteur à clé RUN/SET permet de changer la signification des touches à deux fonctions du tableau frontal. La position RUN est la position normale pendant le fonctionnement de la pompe. La position SET permet de définir les paramètres de la pompe.</p>	
		Clé en position RUN	Clé en position SET
10		<p><b>AMP/VOLT</b> Sa pression permet d'afficher sur l'écran à cristaux liquides la mesure de courant ou tension de la pompe sélectionnée par la commande (13). Si la pompe sélectionnée est désactivée, la touche est hors service.</p>	<p><b>PAGE ▲</b> Sa pression permet de passer à la page-écran de prédéfinition précédente.</p>
11		<p><b>TORR/mBAR</b> Sa pression permet d'afficher sur l'écran à cristaux liquides la mesure de pression en Torr ou en mbar de la pompe sélectionnée par la commande (13). Si la pompe sélectionnée est désactivée, la touche est hors service.</p>	<p><b>ADJUST +</b> Sa pression permet de modifier la valeur de prédéfinition. Cette touche permet également de mettre en route la procédure standard d'arrêt d'une seule pompe.</p>
12		<p><b>START/PROTECT</b> Sa pression permet de changer le mode de fonctionnement de la pompe sélectionnée par la commande (13) de START en PROTECT ou vice-versa. Si le mode PROTECT est sélectionné pour une pompe, la DEL correspondante verte Prot (4) ou (6) s'allume.</p>	<p><b>PAGE ▼</b> Sa pression permet de passer à la page-écran de prédéfinition suivante.</p>
13		<p><b>PUMP SELECT</b> Sa pression permet de sélectionner sur l'écran la pompe sur laquelle est effectuée l'action suivante (par exemple, le changement du mode de fonctionnement ou l'affichage des paramètres de la pompe). La pompe sélectionnée est indiquée sur l'écran par le symbole # suivi du numéro 1 ou 2. Si un seul module H.V. est installé, la touche est hors fonction.</p>	<p><b>ADJUST -</b> Sa pression permet de modifier les valeurs de prédéfinition. Egalement de mettre en route la procédure standard d'arrêt d'une seule pompe.</p>
14		<p><b>Aux DISPL</b> Sa pression permet de sélectionner la lecture de la carte MultiGauge à afficher sur l'écran.</p>	<p><b>CLEAR</b> Sa pression permet de retourner à la sélection précédente si la ENTER n'a pas encore été touchée; ou bien sa pression par deux fois permet de retourner à la première page du menu sélectionné depuis n'importe quelle page.</p>
15		<p><b>PARAM</b> Sa pression permet d'afficher les paramètres de la pompe sélectionnée sur la carte H.V. indiquée sur l'écran par le symbole #. Les paramètres affichés sont: <b>Pump size:</b> la dimension de la pompe sélectionnée <b>Imax:</b> le courant de court-circuit de la pompe sélectionnée. <b>Iprot:</b> la valeur de courant à laquelle intervient la protection "Overcurrent" <b>PWRmax:</b> la puissance maxi de la pompe sélectionnée <b>Vmax:</b> la polarité (+ ou -) ou la tension maxi de la pompe sélectionnée <b>Fixed V ou Step V:</b> le mode d'exploitation sélectionné <b>STP1/STP2:</b> les valeurs des Set Points 1 et 2 et l'information si les Set Points ont été dépassés (le symbole ^ indique que le set point correspondant a été dépassé ou que la H.V. est éteinte).</p> <p>NOTE: Les indications relatives aux set points ne sont affichées que si la carte Set Point / Remote Control est installée.</p>	<p><b>ENTER</b> Sa pression permet de confirmer le paramètre affiché.</p>

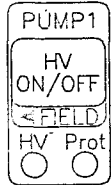
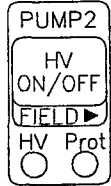

## MODE D'EMPLOI

Réf.	Nom Commande/Diode	Description de la Commande/Diode	
		Clé (9) en position RUN	Clé (9) en position SET
16		<p><b>PUMP 1 HV ON/OFF</b></p> <p>Sa pression fait s'allumer ou s'éteindre la carte H.V. de la pompe 1. Elle fonctionne comme un interrupteur bistable. Son action est indépendante de la ligne sélectionnée sur l'écran. Pour allumer la carte H.V., l'interrupteur STANDBY ON/OFF (8) doit être dans la position ON.</p>	<p>&lt; FIELD</p> <p>Elle a trois fonctions:</p> <ul style="list-style-type: none"> <li>- elle change le menu affiché (View, Mode, Set);</li> <li>- elle sélectionne le champ à l'intérieur de la page pendant l'opération de prédéfinition;</li> <li>- elle change la page en lecture de la pompe 1 à la pompe 2 et vice-versa lorsque les deux pompes sont allumées.</li> </ul>
17		<p><b>PUMP 2 HV ON/OFF</b></p> <p>Sa pression fait s'allumer ou s'éteindre la carte H.V. de la pompe 2. Elle fonctionne comme un interrupteur bistable. Son action est indépendante de la ligne sélectionnée sur l'écran. Pour allumer la carte H.V., l'interrupteur STANDBY ON/OFF (8) doit être dans la position ON.</p>	<p>FIELD &gt;</p> <p>Elle a trois fonctions:</p> <ul style="list-style-type: none"> <li>- elle change le menu affiché (View, Mode, Set);</li> <li>- elle sélectionne le champ à l'intérieur de la page pendant l'opération de prédéfinition;</li> <li>- elle change la page en lecture de la pompe 1 à la pompe 2 et vice-versa lorsque les deux pompes sont allumées.</li> </ul>
18		Pieds frontaux à extraire uniquement en cas d'installation sur une table.	

### Tableau Dorsal du MultiVac

La figure suivante indique les commandes et les connexions du tableau dorsal du contrôleur MultiVac. La configuration représentée prévoit une carte H.V., une carte Set Point/Remote Control card et une carte RS 232/422 Computer Interface.

### UTILISATION

#### Modes de Fonctionnement

Le contrôleur MultiVac peut fonctionner dans les modes LOCAL, ELOIGNE entrée/sortie (E/S) ou TELEGESTION.

Si aucune carte optionnelle (Remote I/O and Set-Points ou RS232-422) n'est présente, le seul mode de fonctionnement disponible est le mode LOCAL. Dans le mode LOCAL, toutes les commandes sont données depuis le tableau frontal.

Si seule la carte Remote I/O and set-Points est installée, le MultiVac peut fonctionner dans les modes LOCAL ou ELOIGNE E/S. Dans le mode ELOIGNE E/S, toutes les commandes sont données par le connecteur d'entrée/sortie du tableau dorsal. Après une coupure d'alimentation, le MultiVac retourne au mode de fonctionnement précédemment sélectionné.

Si la carte RS232-422 est installée et si elle a été activée par l'interrupteur à positions multiples 3 (voir l'appendice "Technical Informations"), le MultiVac peut fonctionner dans les modes LOCAL et TELEGESTION où toutes les commandes sont données par la ligne RS 232-422. Après une coupure d'alimentation, le MultiVac retourne toujours au mode de fonctionnement TELEGESTION, même si le mode précédemment sélectionné était LOCAL.

Si les deux cartes RS 232-422 et Remote I/O sont installées, le MultiVac peut fonctionner dans les trois modes. Après une coupure d'alimentation, le MultiVac retourne toujours au mode de fonctionnement TELEGESTION, même si le mode précédemment sélectionné était LOCAL ou ELOIGNE E/S.



Tableau Dorsal du MultiVac

L'unité a été conçue pour fonctionner dans les modes suivants:

- mode **START** ou **PROTECTED**
- mode **STEP** ou **FIXED VOLTAGE**

Dans le mode **START**, le contrôleur fournit toute la puissance, indépendamment des conditions de la pompe, jusqu'au courant de court-circuit. Ce mode de fonctionnement doit être utilisé pour mettre la pompe en marche à haute pression.

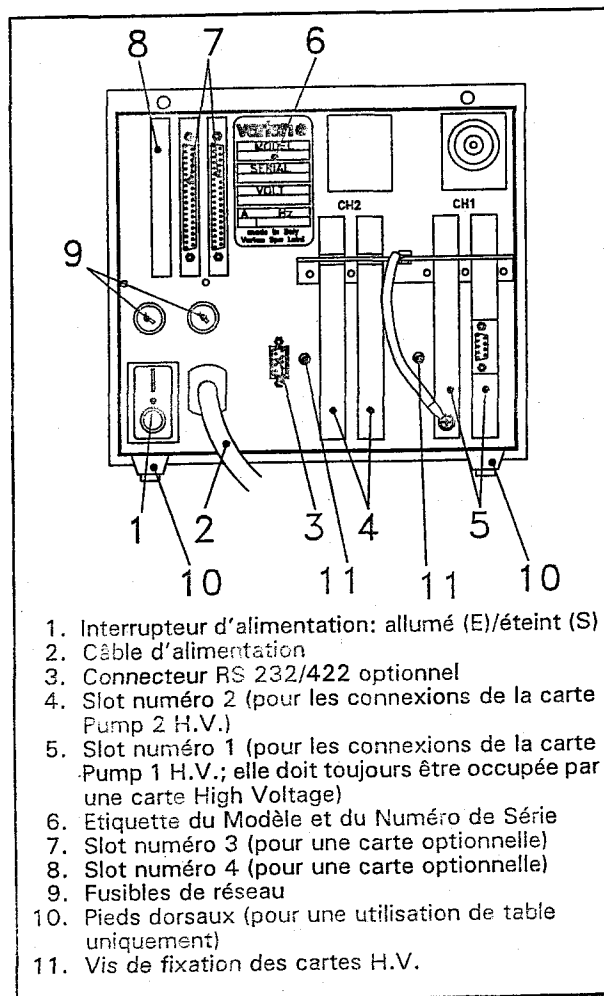
Dans le mode **PROTECTED**, le contrôleur limite le courant de sortie et éteint la haute tension lorsque la valeur de courant dépasse le courant de seuil pendant plus de 0,2 secondes.

Dans le mode **STEP**, lorsque le courant absorbé par la pompe atteint les valeurs de seuil, le contrôleur change la tension de sortie.

Dans le mode **FIXED VOLTAGE**, la tension de sortie reste toujours à sa valeur maximale.

**NOTE**

L'unité est pré-réglée en usine comme suit:

- dans le mode de fonctionnement **LOCAL** si la carte *Computer Interface* n'est pas installée
- dans le mode de fonctionnement **ELOIGNE** si la carte *Computer Interface* est installée
- avec la clé **RUN/SET** dans la position **RUN**
- dans le mode de fonctionnement **START, STEP VOLTAGE**

Pendant l'utilisation normale du contrôleur, la clé **RUN/SET** DOIT être dans la position **RUN**.

Pour toutes informations plus détaillées sur les modes de fonctionnement, consulter l'appendice "Technical Informations".

**Pour allumer la Carte H.V.**

Pour allumer la carte H.V. la clé **RUN/SET** doit être dans la position **RUN**, l'interrupteur **STANDBY** et l'interrupteur d'alimentation du tableau dorsal doivent être dans la position **ON**.

**NOTE**

Si une seule carte est installée, les deux lignes sont consacrées à la pompe numéro un; si deux cartes sont installées, chaque ligne est consacrée à une pompe différente.

L'écran affiche:

1	#	2	0	S	t	a	r	C	e	l	l		

Presser la touche **PUMP 1 HV ON/OFF** (ou bien **PUMP 2 HV ON/OFF**, selon la pompe que l'on veut activer), et l'écran affiche:

1	#	C	u	r	r	e	n	t	(	A	)		

Pour afficher la valeur de la tension, presser la touche **AMP/VOLT**.

Pour afficher la pression, presser la touche **TORR/mBAR**.

**NOTE**

Le changement ne se produit que dans la ligne ayant le symbole #. Presser la touche **PUMP SELECT #** pour déplacer le symbole # d'une ligne à l'autre.

A côté de la valeur lue, apparaît l'un des symboles indiqués dans le tableau suivant:

Symbole	Description
>	La valeur augmente
<	La valeur diminue
■	La valeur est stable

**NOTE**

Si le courant est trop faible (c'est-à-dire  $1 \times 10^7$  A), la valeur de pression n'est pas lue et le message "LOW PRESSURE" est affiché.

**Fonctionnement des Ventilateurs**

Lorsque le contrôleur est allumé et que les cartes H.V. sont éteintes, les ventilateurs tournent lentement, de manière à assurer un léger flux d'air à l'intérieur de l'unité.

Lorsqu'une carte H.V. est allumée, les ventilateurs commencent à tourner à grande vitesse, de manière à assurer un flux d'air élevé à l'intérieur de l'unité lorsque la tension dépasse 5 KV ou que la puissance de sortie dépasse 30 W.

## MODE D'EMPLOI

### Pour allumer les Cartes MultiGauge

Pour allumer les cartes MultiGauge, procéder comme suit:

- Allumer l'interrupteur d'alimentation situé sur le tableau dorsal.
- Mettre sur ON l'interrupteur STAND-BY/INTERLOCK du tableau frontal: le message "MULTIVAC INITIALIZATION" sera alors affiché pendant quelques secondes, puis seront affichés les types de pompes sélectionnées sur les cartes High Voltage installées dans les slots 1 et 2.
- Presser la touche AUX DISPL: l'écran affichera le type de carte installée dans les slots A et B (troisième et quatrième).
- Tourner la clé dans la position SET: l'écran affichera le message "MAIN MENU - VIEW".
- Presser ENTER: l'écran affichera l'un des slots; se déplacer à travers les 4 slots à l'aide des deux touches FIELD LEFT et FIELD RIGHT jusqu'à ce que soit affichée la carte que l'on souhaite allumer.
- Presser ENTER; si une panne a précédemment éteint la carte, l'écran indiquera la raison de la panne.
- Presser ENTER: l'écran demandera si l'on souhaite allumer la carte Gauge. La réponse implicite est YES; si l'on veut choisir NO, presser l'une des touches FIELD.
- Presser ENTER: le MultiVac allumera le capteur de la carte Gauge et l'écran affichera le message "WARM UP" pendant 10 à 20 secondes.

Lorsque la carte Gauge est allumée, l'écran affiche la valeur de pression lue.

### Lecture des Paramètres de la Pompe

Lorsqu'une carte H.V. est allumée, il est possible de lire les paramètres de la pompe en pressant la touche PARAM. La lecture obtenue est généralement la suivante:

1	#	20	S	t	a	r	C	e	l	l		

1	#	I	m	a	x	1	5	0	m	A		

1	#	I	p	r	o	t	2	0	m	A		

1	#	P	W	R	m	a	x	1	5	0	W	

1	#	V	m	a	x	-	7	0	0	0	V	

1	#	S	T	E	P	V						

### Pour éteindre la Carte H.V.

Pour éteindre une carte H.V., presser la touche correspondante PUMP HV ON/OFF située sur le tableau frontal du contrôleur.

Pour éteindre les deux pompes à la fois, en état d'urgence, il est possible de mettre l'interrupteur STAND-BY/INTERLOCK du tableau frontal dans la position OFF. Dans ce cas-là, les DEL HV clignotent et l'écran affiche

S	T	A	N	D	B	Y	/	I	N	T	L	K	
S	E	E		M	A	N	U	A	L				

pendant 5 secondes environ, puis retourne aux conditions normales.

### ENTRETIEN

Le contrôleur MultiVac n'exige aucun entretien. Toute opération doit être effectuée par un personnel agréé. En cas de panne, il est possible de s'adresser au Service de réparation Varian ou bien au "Varian advance exchange service" qui permet d'obtenir un contrôleur neuf à la place du contrôleur détraqué.



Avant d'effectuer toute opération sur le contrôleur, débrancher le câble d'alimentation.

En cas de mise au rebut du contrôleur, procéder à son élimination conformément aux réglementations nationales en la matière.

### MESSAGES D'ERREUR

Pour certains types de panne, le contrôleur procède à un autodiagnostic et affiche l'un des messages d'erreur indiqués dans le tableau suivant.

MESSAGE	DESCRIPTION	INTERVENTION
<b>POLARITY ERROR</b> SEE MANUAL	La polarité du type de pompe sélectionnée depuis le tableau frontal de la carte ne correspond pas à la polarité du module Multiplier.	Inverser la polarité du module Multiplier (voir l'appendice "Technical Informations").
<b>H.V. CARD FAULT</b> SEE MANUAL	Il existe un dysfonctionnement des circuits de lecture du courant de la carte H.V. ou des circuits de commande. La DEL du tableau frontal correspondant à la carte H.V. clignote.	Eteindre et rallumer l'unité. Si l'erreur se présente à nouveau s'adresser au service après-vente Varian.
<b>PUMP OVERCURRENT</b> SEE MANUAL	Dans le mode de fonctionnement Protect, la valeur de courant dépasse le courant de seuil pendant plus de 0,2 secondes. La DEL du tableau frontal correspondant à la carte H.V. clignote.	Sélectionner le mode START, afin que le contrôleur puisse fonctionner jusqu'au courant de court-circuit sans seuil.
<b>REMOTE INTERLOCK</b> SEE MANUAL	Lorsque la carte Remote I/O est présente et que l'entrée 1 (interlock extérieur) est au niveau haut (ouverte), il est impossible d'allumer la carte High Voltage ou, si elle est déjà allumée, elle est éteinte. La DEL correspondante du tableau frontal clignote.	Enlever l'interlock extérieur.
<b>STANDBY/INTLK</b> SEE MANUAL	On a enlevé la couverture de l'unité avec au moins un module H.V. allumé, ou on a essayé d'allumer le module H.V. avec la couverture ouverte. La DEL correspondante du tableau frontal clignote.	Fermer la couverture.
	Le module H.V. a été éteint à l'aide de l'interrupteur Standby ON/OFF du tableau frontal ou bien on a essayé d'allumer le module H.V. avec le même interrupteur en position OFF. La DEL correspondante du tableau frontal clignote	Répéter correctement la procédure de mise hors tension ou de mise sous tension.
<b>OVERTEMPERATURE</b> SEE MANUAL	La protection thermique du module H.V. s'est activée. La DEL correspondante du tableau frontal clignote.	Améliorer la circulation de l'air autour de l'unité.
<b>TEST ERROR</b> SEE MANUAL	L'auto-test à l'allumage a détecté une panne, ou bien aucune carte High Voltage n'est présente dans le slot 1.	Installer la carte H.V. dans le slot 1. Eteindre et rallumer l'unité. Si l'erreur se présente à nouveau s'adresser au Réseau Après-vente Varian.
<b>CHECK HV1 CONN.</b> SEE MANUAL	La carte High Voltage n'est pas correctement installée.	Eteindre le contrôleur et le débrancher du réseau d'alimentation. Enlever la carte H.V. et l'installer à nouveau avec attention.
<b>DEGAS UNDERCURR</b>	La carte MultiGauge Bayard-Alpert a détecté une erreur de courant de degas trop bas.	Eteindre et rallumer la carte. Si l'erreur se présente à nouveau s'adresser au Service après-vente Varian.
<b>OVERCURRENT</b>	La carte Multi Gauge UHV a détecté une erreur de surintensité du filament ou bien la carte Multi Gauge Cold Cathode a détecté une erreur de surintensité.	Eteindre et rallumer la carte. Si l'erreur se présente à nouveau s'adresser au Service après-vente Varian.
<b>UNDERCURRENT</b>	Les cartes Multi Gauge Bayard-Alpert ou UHV ont détecté une erreur de courant de filament trop bas (le capteur n'est pas connecté ou le filament du capteur est coupé).	Vérifier la connexion du capteur et éteindre et rallumer la carte. Si l'erreur se présente à nouveau, s'adresser au Service après-vente Varian.
<b>GRID ERROR</b>	Les cartes Multi Gauge Bayard-Alpert ou UHV ont l'erreur détecté une erreur de la grille (la grille du capteur n'est pas connectée)	Eteindre et rallumer la carte. Si l'erreur se présente à nouveau s'adresser au Service après-vente Varian.
<b>OVERTEMPERATURE</b>	Les cartes Multi Gauge Bayard-Alpert ou UHV ou Cold Cathode ont détecté à une erreur de surtempérature.	Eteindre et rallumer les cartes. Si l'erreur se présente nouveau, s'adresser au Service après-vente Varian.
<b>POWER SUPPLY</b>	Les cartes Multi Gauge ou Thermocouple ont détecté une erreur d'alimentation.	Eteindre et rallumer les cartes. Si l'erreur se présente à nouveau, s'adresser au Service après-vente Varian.
<b>MEAS OUT LIMITS</b>	Les cartes Multi Gauge Bayard-Alpert ou UHV Cold Cathode, pendant la période de chauffage, n'ont pas été à même de fournir une lecture significative.	Eteindre et rallumer les cartes. Si l'erreur se présente à nouveau, s'adresser au Service après-vente Varian.

# INSTRUCTIONS FOR USE

## GENERAL INFORMATION

This equipment is destined for use by professionals. The user should read this instruction manual and any other additional information supplied by Varian before operating the equipment. Varian will not be held responsible for any events occurring due to non-compliance, even partial, with these instructions, improper use by untrained persons, non-authorized interference with the equipment or any action contrary to that provided for by specific national standards.

The following paragraphs contain all the information necessary to guarantee the safety of the operator when using the equipment. Detailed information is supplied in the appendix "Technical Information".

This manual uses the following standard protocol:



**WARNING**

The warning messages are for attracting the attention of the operator to a particular procedure or practice which, if not followed correctly, could lead to serious injury.



**CAUTION**

The caution messages are displayed before procedures which, if not followed, could cause damage to the equipment.

### NOTE

The notes contain important information taken from the text.

## CONTROLLER DESCRIPTION

Varian's MultiVac controller is a half-rack modular and flexible ion pumps controller. The unit can be factory configured according to the customer's needs, or the parts can be ordered separately and the user can add or change the process control capability in the field by simply inserting or moving option cards.

The MultiVac controller minimum configuration is:

- 1 MultiVac base unit
- 1 Vaclon Pump High Voltage card

The minimum configuration can be expanded adding optional cards. The available optional cards are detailed in the following table.

The optional cards can be installed with the following limitations:

- a maximum of two high voltage cards
- a maximum of two other cards.

### NOTE

MultiVac controller with part number 929-4000/4001/4010/4011 cannot control a MultiGage card. To install a MultiGage card the controller must be updated by means of a suitable kit. Call Varian Service for more information.

DESCRIPTION	PART NUMBER
<b>MultiVac Base Unit</b>	
Base Unit set for 220 Vac input voltage	929-4000 929-4001 (with RS-232 card installed)
Base Unit set for 110 Vac input voltage	929-4010 929-4011 (with RS-232 card installed)
<b>Optional cards</b>	
Medium Vaclon Pump High Voltage (H.V.) card	929-4025 or 929-4035
Large Vaclon Pump High Voltage (H.V.) card	929-4040 or 929-4050
Set Point/Remote Control card	969-4110
RS 232-422 Computer Interface card	929-4100
Multi Gauge Bayard-Alpert	L6427-301
Multi Gauge UHV	L8321-301
Multi Gauge Cold Cathode	L6433-301
Multi Gauge Thermocouple	L6430-301

The MultiVac controller base unit in conjunction with the H.V. cards can operate a maximum of two ion pumps with positive or negative polarity from 20 l/s to 500 l/s. It allows a reliable pressure reading down to  $10^{-11}$  Torr range, while optimising the pumping performance throughout the entire operating range.

The Multi Gauge cards allow pressure readings with different precision and measurement range.

The MultiVac controller can be operated in LOCAL mode, in REMOTE I/O mode when the Set Point Remote Control card is installed, or in REMOTE COMMUNICATION mode when the RS 232-422 Computer Interface card is installed.

In LOCAL mode all controls are given on front panel. In REMOTE I/O mode all controls are given on the rear panel connector of the Set Point/Remote Control card. In REMOTE COMMUNICATION mode all controls are given by a host computer through the RS 232-422 Computer Interface card.

## STORAGE

When transporting and storing the controllers, the following environmental requirements should be satisfied:

- temperature: from -20 °C to +70 °C
- relative humidity: 0 - 95% (without condensation)

## PREPARATION FOR INSTALLATION

The controller is supplied in a special protective packing. If this shows signs of damage which may have occurred during transport, contact your local sales office. When unpacking the controller, ensure that it is not dropped or subjected to any form of impact.

Do not dispose of the packing materials in an unauthorized manner. The material is 100% recyclable and complies with EEC Directive 85/399.

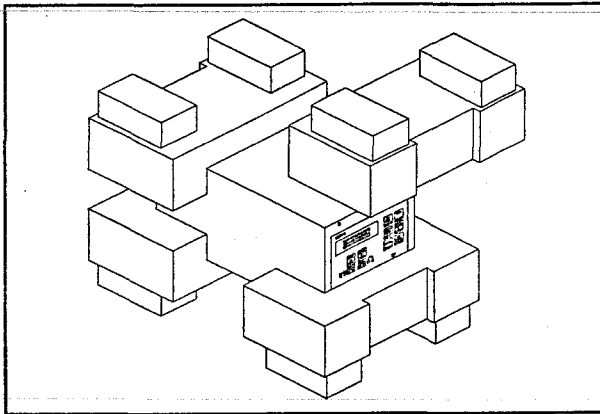

Controller packing

The MultiVac controller base unit is factory set for:

- model 929-4000/929-4001 set to 220 Vac (input 180 to 265 Vac),
- model 929-4010/929-4011 set to 110 Vac (input 90 to 130 Vac).

If a change in line voltage operation is desired, proceed as follows:

- Switch off the controller and unplug the power cord from the wall socket.
- On bottom cover of the controller, select the desired operating voltage by moving the switch to either 110 Vac or 220 Vac position as shown in the following figure.

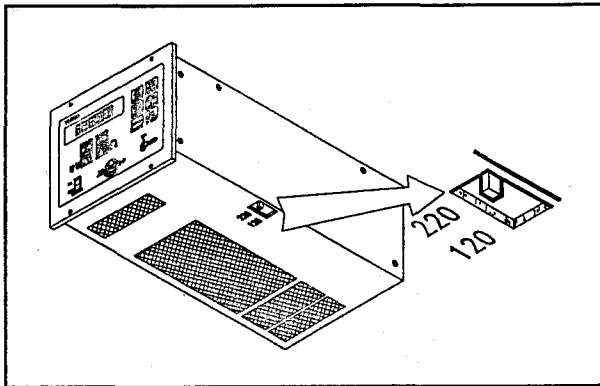

Operating voltage switch

If the power cord plug must be changed, rewire as follows:

- blue = neutral
- brown = phase
- yellow-green = ground

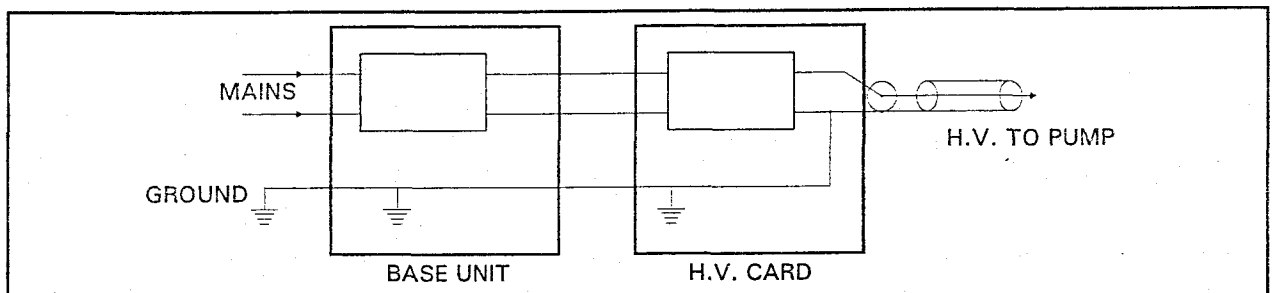

Ground connections

INSTALLATION



**WARNING**

The MultiVac controller base unit is equipped with a 3-wire power cord and plug (internationally approved) for user's safety. Use this power cord and plug in conjunction with a properly grounded power socket to avoid electrical shock.

Verify that the ground connections are properly connected.

High voltage developed in the controller can cause severe injury or death. Before servicing the unit, disconnect the input power cable.



**CAUTION**

The controller can be used as a bench unit or as a rack module, but it must be positioned so that free air can flow through the holes of the top and bottom cover.

If the controller is used as a rack module, it **MUST** be inserted in a 4 unit height rack adapter chassis to avoid the controller to fall inside the rack.

The MultiVac front panel is not designed to support the MultiVac weight.

Do not install or use the controller in an environment exposed to atmospheric agents (rain, snow, ice), dust, aggressive gases, or in explosive environments or those with a high fire risk.

**NOTE**

If the controller is used as a bench unit, pull out the two front legs.

If the controller is installed on a rack, remove the four feet and position it with at least 30 mm (1.2 inches) of clearance on top and bottom.

During operation, the following environmental conditions must be respected:

- temperature: from 0 °C to +45 °C
- relative humidity: 0 - 90% (without condensation)

To connect the controller to the pump use the specific cable supplied as an option.

See the appendix "Technical Information" for detailed information about the above mentioned and the other connections, and about the optional cards installation.

# INSTRUCTIONS FOR USE

## USE

This paragraph describes the fundamental operating procedures. Detailed information and operating procedures that involve optional connections or options are supplied in the paragraph "USE" of the appendix "Technical Informations".

Make all vacuum manifold and electrical connections and refer to Turbo-V pump instruction manual prior to operating the controller.



**WARNING**

To avoid injury to personnel and damage to the equipment, if the pump is laying on a table make sure it is steady.

Never operate the Turbo-V pump if the pump inlet is not connected to the system or blanked off.

## MultiVac Front Panel Controls and Indicators

The MultiVac controller base front panel is shown in the following figure.

The controls and indicators meaning and function is detailed in the following table.

### NOTE

The meaning of push buttons of the MultiVac front panel changes according to the RUN-SET selection key position.





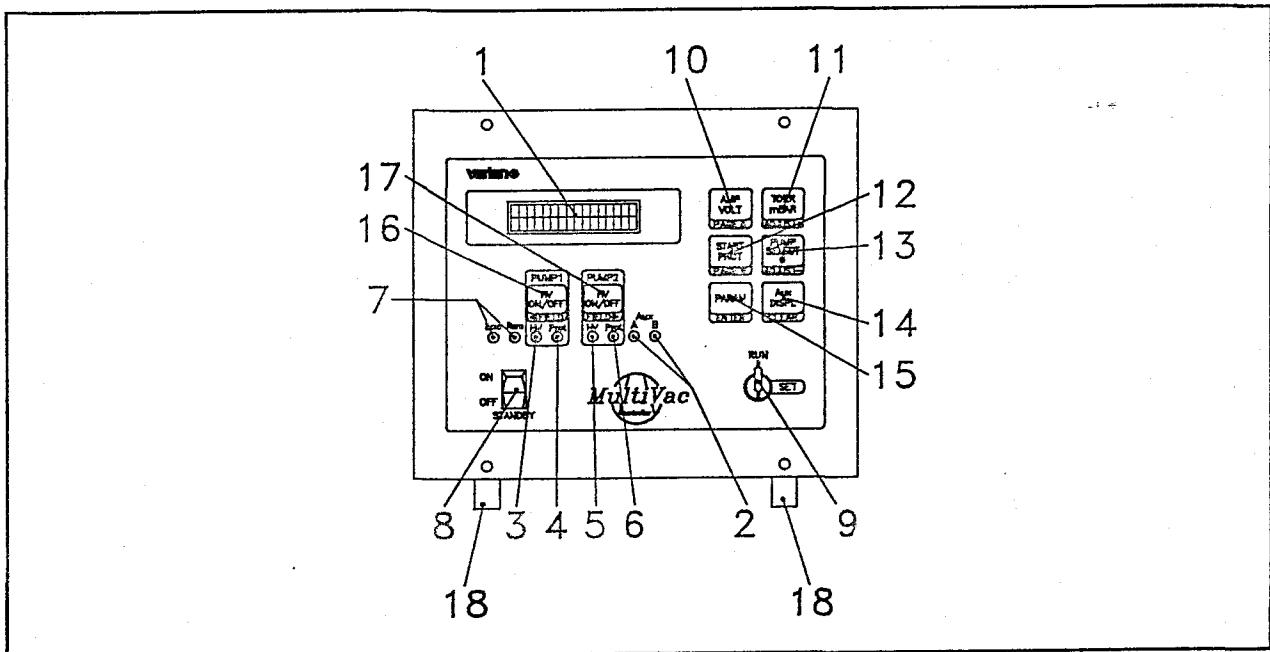

The white writings on black background are valid when the key is in RUN position.

The red writings on white background are valid when the key is in SET position.

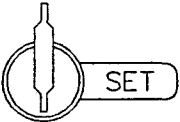



MultiVac front panel controls

Ref.	Control/indicator Name	Control/Indicator Description
1		LCD back lighted alphanumeric display dot matrix, 16 characters, 2 lines.
2	AUX A/B	Two green LEDs that are on if additional cards are installed (for example if the Set Point/Remote Control card is installed in slot #3 inside the unit, the LED A will be on).
3	PUMP 1 - HV	A yellow LED that is ON when the H. V. on Pump 1 is ON.
4	PUMP 1 - Prot.	A green LED that is ON when the Protect mode of operation has been selected for Pump 1.
5	PUMP 2 - HV	A yellow LED that is ON when the H. V. on Pump 2 is ON.
6	PUMP 2 - Prot.	A green LED that is ON when the Protect mode of operation has been selected for Pump 2.
7	Loc - Rem	Two green LEDs that show which operating mode is selected: - Loc is ON when the LOCAL mode of operation is selected; - Rem is ON when the REMOTE I/O or the REMOTE COMMUNICATION mode is selected.
8	ON OFF STANDBY	When in OFF position the Pump 1 and Pump 2 are disabled; when in ON position the pumps can be switched ON. It allows to switch off both pumps at the same time in emergency condition.

Ref.	Control/Indicator Name	Control/Indicator Description	
9		<p>The RUN/SET key selector allows to change the meanings of the double function front panel push buttons.</p> <p>The RUN position is the normal position during the pump functioning.</p> <p>The SET position allows to set the pump parameters.</p>	
		Key in RUN position	Key in SET position
10		<p><b>AMP/VOLT</b></p> <p>When pressed it allows to display on the LCD display the current or voltage measurements of the pump selected by means of control (13). If the selected pump is off, the push button is inoperative.</p>	<p><b>PAGE ▲</b></p> <p>When pressed it changes the displayed setting page to the previous one.</p>
11		<p><b>TORR/mBAR</b></p> <p>When pressed it allows to display on the LCD display the pressure measurement in Torr or in mBAR of the pump selected by means of control (13). If the selected pump is off, the push button is inoperative.</p>	<p><b>ADJUST +</b></p> <p>When pressed it allows to modify the setting values. It also allows to access to the standard switch off routine for the single pump.</p>
12		<p><b>START/PROTECT</b></p> <p>When pressed it switches from START to PROTECT or viceversa the operational mode for the pump selected by means of control (13). If the PROTECT mode has been selected for a pump the corresponding green LED Prot (4) or (6) is ON.</p>	<p><b>PAGE ▼</b></p> <p>When pressed it changes the displayed setting page to the following one.</p>
13		<p><b>PUMP SELECT</b></p> <p>It allows to select, on the display, the pump subject to the following action (for example to change the operating mode or to display the pump parameters). The selected pump is indicated on the display by the # symbol followed by the number 1 or 2. If only one H. V. module is installed, the push button is inactive.</p>	<p><b>ADJUST -</b></p> <p>When pressed it allows to modify the setting values. It also allows to access to the standard switch off routine for the single pump.</p>
14		<p><b>Aux DISPL</b></p> <p>It allows to select the Multi Gauge card reading to be displayed on the LCD display.</p>	<p><b>CLEAR</b></p> <p>When pressed it reverts to the previous selection if the ENTER push button has not been pressed, or, if pressed twice, goes back to the menu first page from any page of the selected menu.</p>
15		<p><b>PARAM</b></p> <p>When pressed it allows to display the parameters of the pump selected on the H. V. card that is indicated on the display by the symbol #.</p> <p>The displayed parameters are:</p> <ul style="list-style-type: none"> <li><b>Pump size:</b> the selected pump size</li> <li><b>Imax:</b> the short circuit current for the selected pump size</li> <li><b>Iprot:</b> the current value at which the "Overcurrent" protection intervenes</li> <li><b>PWRmax:</b> the maximum power for the selected pump size</li> <li><b>Vmax:</b> The polarity (+ or -) and the maximum voltage for the selected pump size</li> <li><b>Fixed V or Step V:</b> the selected operating mode</li> <li><b>STP1/STP2:</b> the set Set Point 1 and 2, and the information if the set points are passed (a ^ mark indicates that the corresponding set point has been passed or that the H. V. is OFF)</li> </ul> <p><b>NOTE:</b> The indications of the set points will be shown only if the Set point/Remote Control card is installed.</p>	<p><b>ENTER</b></p> <p>When pressed it confirms the displayed parameters.</p>



**INSTRUCTIONS FOR USE**

Ref.	Control/Indicator Name	Control/Indicator Description	
		Key (9) in RUN position	Key (9) in SET position
16		<p><b>PUMP 1 HV ON/OFF</b></p> <p>When pressed it directly switches ON and OFF the H. V. of the pump 1. It works in toggle mode. Its operation is independent from the selected line on the display. To switch ON the H. V., the STANDBY ON/OFF rocker switch (8) must be in ON position.</p>	<p><b>&lt; FIELD</b></p> <p>It allows three functions:</p> <ul style="list-style-type: none"> <li>- to change the displayed menu (View, Mode, Set);</li> <li>- to select the field within the page during the setting operation</li> <li>- to change the reading page from pump 1 to pump 2 and viceversa when both pumps are ON.</li> </ul>
17		<p><b>PUMP 2 HV ON/OFF</b></p> <p>When pressed it directly switches ON and OFF the H. V. of the pump 2. It works in toggle mode. Its operation is independent from the selected line on the display. To switch ON the H. V., the STANDBY ON/OFF rocker switch (8) must be in ON position.</p>	<p><b>FIELD &gt;</b></p> <p>It allows three functions:</p> <ul style="list-style-type: none"> <li>- to change the displayed menu (View, Mode, Set);</li> <li>- to select the field within the page during the setting operation</li> <li>- to change the reading page from pump 1 to pump 2 and viceversa when both pumps are ON.</li> </ul>
18		Front legs extracted for bench operation only	

**MultiVac Rear Panel**

The MultiVac controller base rear panel controls and connections are shown in the following figure where a configuration with one H. V. card, one Set Point/Remote Control card and one RS 232/422 Computer Interface card is shown.

**USE PROCEDURE**

**Operating Modes**

The MultiVac controller can be operated in the LOCAL, REMOTE input/output (I/O) or REMOTE COMMUNICATION mode.

If no optional card (Remote I/O and Set-Points card or RS232-422 card) is installed, the only available operating mode is LOCAL. In the LOCAL mode all controls are given on front panel.

If only the Remote I/O and Set-Points card is installed, the MultiVac can operate in the LOCAL or REMOTE I/O mode. In the REMOTE I/O all controls are given via the I/O connector. After a power failure the MultiVac will return to the previously selected operating mode.

If the communication card RS232-422 is installed and enabled by the dip switch 3 (see the appendix Technical Information) the available operating modes are LOCAL and REMOTE COMMUNICATION in which all controls are given via the RS 232-422 line. After a power failure the MultiVac will always return to REMOTE COMMUNICATION mode also if the previous selection was LOCAL.

If both RS232-422 and Remote I/O cards are installed, the three operational modes are available. After a power failure the MultiVac will always return to REMOTE COMMUNICATION mode also if the previous selection was LOCAL or REMOTE I/O.

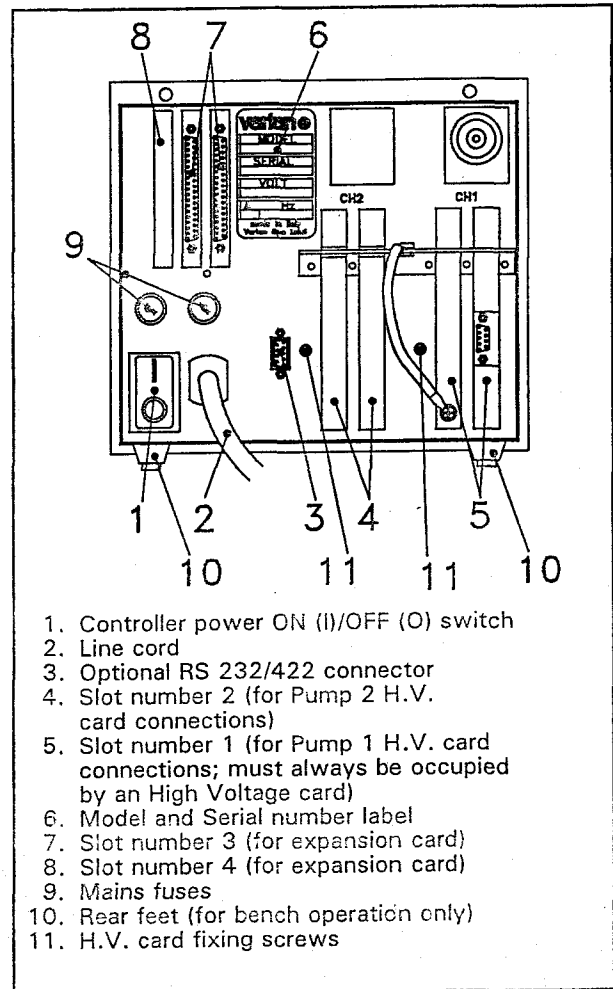

1. Controller power ON (I)/OFF (O) switch
2. Line cord
3. Optional RS 232/422 connector
4. Slot number 2 (for Pump 2 H.V. card connections)
5. Slot number 1 (for Pump 1 H.V. card connections; must always be occupied by an High Voltage card)
6. Model and Serial number label
7. Slot number 3 (for expansion card)
8. Slot number 4 (for expansion card)
9. Mains fuses
10. Rear feet (for bench operation only)
11. H.V. card fixing screws

*MultiVac base rear panel*

The unit is designed to operate in different modes:

- **START** or **PROTECTED** mode
- **STEP** or **FIXED VOLTAGE** mode

In the **START** mode of operation the controller supplies full power, disregarding the pump condition, up to the short circuit current. This operating mode should be used to start the pump at high pressure.

In the **PROTECTED** mode of operation the controller limits the output current and it turns off the high voltage when the current value exceeds the trip current for more than 0.2 seconds.

In the **STEP** mode of operation when the current drawn by the pump reaches the threshold values, the controller changes the voltage output.

In the **FIXED VOLTAGE** mode of operation the output voltage remains always at the maximum value.

**NOTE**

The unit is factory set for:

- LOCAL mode operation if the computer interface is not installed
- REMOTE mode operation if the computer interface is installed
- RUN/SET key in RUN position
- Operating mode: START, STEP VOLTAGE

For normal use of the controller the RUN/SET key MUST be in RUN position.

Detailed information about the operating modes are contained in the appendix "Technical Information".

**H.V. Card Switching ON**

To switch ON the H.V. card the RUN/SET key must be in RUN position, the **STANDBY** rocker switch and the power switch on rear panel must be set to ON position.

**NOTE**

With one H.V. card installed both lines are dedicated to the pump number one, with two card installed each line is dedicated to different pump.

The display shows:

1	#		2	0		S	t	a	r	C	e	l	l		

Then press the **PUMP 1 HV ON/OFF** pushbutton (or **PUMP 2 HV ON/OFF** according to the pump to be switched ON), and the display shows:

1	#		C	u	r	r	e	n	t		(	A	)		

To display the voltage value press the **AMP/VOLT** pushbutton.

To display pressure press the **TORR/mBAR** pushbutton.

**NOTE**

Changes will occur only in the line with the # symbol. Press the **PUMP SELECT #** pushbutton to move the # symbol from one line to the other.

Close to the read-out value, one of the symbols described in the following table can appear.

Symbol	Description
>	The value is increasing
<	The value is decreasing
■	The value is stable

**NOTE**

Should the current value be very low (i.e.  $< 1 \times 10^{-7} A$ ), the pressure value is not read and appear the message "LOW PRESSURE".

**Fan Operation**

When the controller is switched ON and the H.V. cards are OFF, the fans rotate slowly so that a low air flow is assured inside the unit.

When one H.V. card is switched ON, the fans start rotating at higher speed to assure a high air flow inside the unit when the voltage is greater than 5 KV or the output power is greater than 30 W.

# INSTRUCTIONS FOR USE

## Switching On of the MultiGauge Cards

To switch on the MultiGauge cards execute the following procedure:

- Switch on the Mains switch on the rear panel.
- Switch on the STAND-BY/INTERLOCK switch on the front panel. The display will show the message "MULTIVAC INITIALIZATION" for few seconds and then the Pump Size selection of the High Voltage cards installed in channels 1 and 2.
- Press the pushbutton AUX DISPL, the display will show the type of the card installed in the slots A and B (3rd and 4th).
- Turn the key to SET position, the display will show the message "MAIN MENU - VIEW".
- Press ENTER, the display will show one of the channels, move through the 4 channels by means of the two pushbuttons FIELD LEFT and FIELD RIGHT until you find the indication of the card you want to switch on.
- Press ENTER; if the card has been previously switched off by a fault, the display will indicate the reason of the fault.
- Press ENTER and the display will ask you if you want to switch on the gauge card. The default is YES, if you want to choose NO press one of the pushbuttons FIELD.
- Press ENTER, the MultiVac will switch on the gauge head and the display will show the message "WARM UP" for about 10 - 20 seconds.

When the gauge is on, the display shows the pressure value.

### Pumps Parameters Reading

When a H.V. card is switched ON you can read the pump preset parameters by pressing the PARAM pushbutton.

The read-out is typically of the following type:

1	#	2	0	S	t	a	r	C	e	I	I		

1	#	I	m	a	x	1	5	0	m	A			

1	#	I	p	r	o	t	2	0	m	A			

1	#	P	W	R	m	a	x	1	5	0	W		

1	#	V	m	a	x	-	7	0	0	0	V		

1	#	S	T	E	P	V							

## H.V. Card Switching OFF

To switch OFF one H.V. card press the corresponding PUMP HV ON/OFF pushbutton on the controller front panel.

To switch off both the pumps at the same time in an emergency condition, you can turn the front panel rocker switch to the OFF position. In this case the HV Led flashes and the display shows

S	T	A	N	D	B	Y	/	I	N	T	L	K	
S	E	E	M	A	N	U	A	L					

for about 5 seconds, then resume the normal condition.

## MAINTENANCE

The MultiVac controller does not require any maintenance. Any work performed on the controller must be carried out by authorized personnel.

When a fault has occurred it is possible to use the Varian repair service. Replacement controllers are available on an advance exchange basis through Varian.



**WARNING**

Before carrying out any work on the controller, disconnect it from the supply.

If a controller is to be scrapped, it must be disposed of in accordance with the specific national standards.

## ERROR MESSAGES

For a certain type of failure, the controller will self-diagnose the error and the messages described in the following table are displayed.

MESSAGE	DESCRIPTION	REPAIR ACTION
<b>POLARITY ERROR</b> SEE MANUAL	There is a mismatch between the polarity of the pump type selected by front panel card and the actual polarity of the multiplier module.	Reverse the polarity of the multiplier module (see the appendix "Technical Information").
<b>H.V. CARD FAULT</b> SEE MANUAL	There is a malfunction in the HV card current reading circuitry or in the control circuitry. The corresponding front panel LED is blinking.	Turn off and on again the unit. Should the error still be present, call Varian offices.
<b>PUMP OVERCURRENT</b> SEE MANUAL	In the Protect mode of operation the current value exceeds the trip current for more than 0.2 seconds. The corresponding H.V. card front panel LED is blinking.	Select START mode to allow the controller to work up to the short circuit current without trip-off.
<b>REMOTE INTERLOCK</b> SEE MANUAL	When the Remote I/O card is present and the input 1 (external interlock) is at high (open) level, you can't turn on the High Voltage card, or, if it is already on, it is switched off. The corresponding front panel LED is blinking.	Remove the external interlock.
<b>STANDBY/INTLK</b> SEE MANUAL	The unit cover is removed with at least one HV module on, or you tried to turn on the HV module with the cover opened. The corresponding front panel LED is blinking.	Close the cover.
	You turned off the HV module with the front panel Standby ON/OFF switch, or you tried to turn on the HV module with the front panel ON/OFF switch in OFF position. The corresponding front panel LED is blinking.	Repeat correctly the switching off or the switching on procedure.
<b>OVERTEMPERATURE</b> SEE MANUAL	The HV module thermal protections have been activated. The corresponding front panel LED is blinking.	Improve the air circulation around the unit.
<b>TEST ERROR</b> SEE MANUAL	The power on auto test has failed or no High Voltage card is installed on slot 1.	Install the H.V. card on slot 1. Turn off and on again the unit. Should the error still be present, call the Varian offices.
<b>CHECK HV1 CONN.</b> SEE MANUAL	The High Voltage card is not properly installed.	Turn off the controller and unplug the mains. Remove the H.V. card and carefully reinstall it.
<b>DEGAS UNDERCURRE</b>	The MultiGauge Bayard-Alpert card has detected a degas undercurrent error.	Turn off and on again the card. Should the error still be present, call the Varian offices.
<b>OVERCURRENT</b>	The Multi Gauge UHV card detected a filament overcurrent error, or the Multi Gauge Cold Cathode card detected an overcurrent error.	Turn off and on again the card. Should the error still be present, call the Varian offices.
<b>UNDERCURRENT</b>	The Multi Gauge Bayard-Alpert or UHV cards detected a filament undercurrent error (the gauge head is not connected, or the filament of the gauge head is broken).	Check the head connection and turn off and on again the cards. Should the error still be present, call the Varian offices.
<b>GRID ERROR</b>	The Multi Gauge Bayard-Alpert or UHV cards detected a grid error (the grid of the gauge head is not connected).	Turn off and on again the cards. Should the error still be present, call the Varian offices.
<b>OVERTEMPERATURE</b>	The Multi Gauge Bayard-Alpert or UHV or Cold Cathode cards detected an overtemperature error.	Turn off and on again the cards. Should the error still be present, call the Varian offices.
<b>POWER SUPPLY</b>	The Multi Gauge Cold Cathode or Thermocouple cards detected a power supply error.	Turn off and on again the cards. Should the error still be present, call the Varian offices.
<b>MEAS OUT LIMITS</b>	The Multi Gauge Bayard-Alpert or UHV or Cold Cathode cards, during the warm-up time, has not be able to give a meaningful reading.	Turn off and on again the cards. Should the error still be present, call the Varian offices.

# TECHNICAL INFORMATION

## MULTIVAC CONTROLLER DESCRIPTION

The MultiVac controller base is available in two versions which differ only in the factory set input voltage.

- Model 929-4000/929-4001 set for 220 Vac 50/60 Hz
- Model 929-4010/929-4011 set for 110 Vac 50/60 Hz

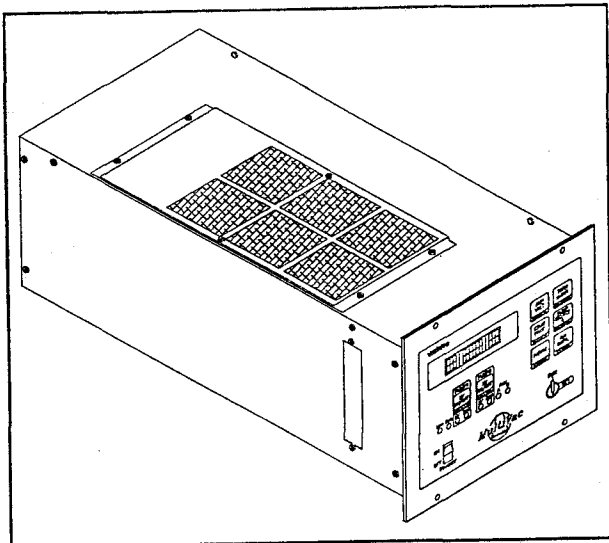

*MultiVac Controller*

It consists of various boards. The following figure shows the minimum configuration.

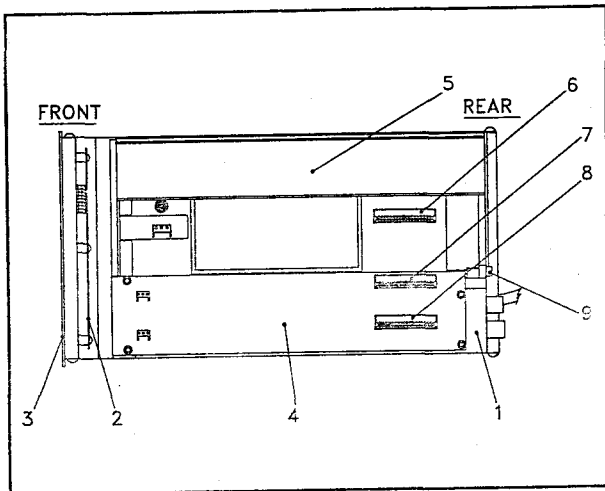

*MultiVac controller boards (Top view)*

- 1) DC power supply and bus connection board: it contains the line voltage change over and the EMI filter.

The ac input voltage is rectified and the needed DC output voltages are generated. The bus allows communication between the microprocessor and the cards located in the 4 slots and supplies the cards with the needed DC voltages. It consists of 36 lines.

- 2) Microprocessor board (located on front panel): it is based on a single chip microprocessor (Motorola 68 HC 11) with a large input/output capability. It manages commands coming from the front panel keyboard and from the various cards and drives the front panel display and all output card functions.

On the upper side of the board there are dip switches used for selection of different functions (see the following figure and the following table).

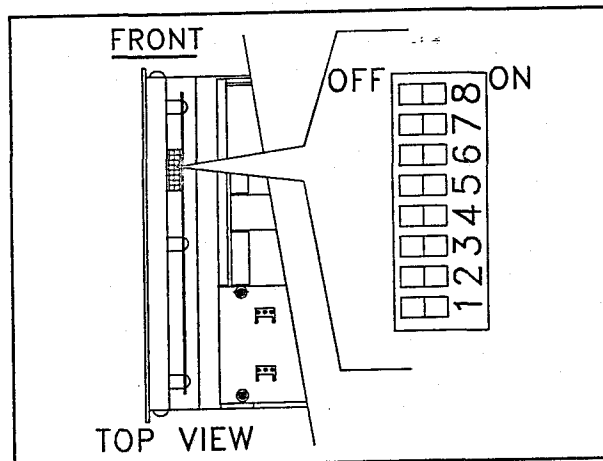

*Dip switches*

### NOTE

*Dip switches position do not need to be changed unless the operating conditions must be different from default settings*

The "standby" ON/OFF rocker switch is located at the bottom side of the board.

Sw.	Selection	Function/Description
1, 2	Sw1 Sw2 OFF OFF ON OFF OFF ON ON ON	Serial computer interface speed communication baud rate: = 1200 (default value) = 2400 = 4800 = 9600
3	OFF  ON	Serial computer interface inoperative (default for unit without computer interface) Serial computer interface operative (default for unit with computer interface)
4	OFF  ON	Autostart H.V. after line failure (default) Not autostart after line failure
5	OFF  ON	Used when the Serial Computer Interface card is installed: Standard serial protocol ASCII serial protocol
6	OFF ON	Base unit in normal operation Base unit self test
7	OFF ON	Base unit in normal operation Non volatile memory reset
8	OFF ON	Base unit in normal operation Base unit manufacturing diagnostic and software revision check

**NOTE**

*Dip switches 6, 7 and 8 are for service purpose only. DO NOT move them.*

- 3) Display and front panel keyboard: it contains the functional push buttons, the key to select the operating mode, the LEDs indicating the operating channels and the active mode of operation, and the LCD display.
- 4) Internal expansion board: it allows the housing of the Auxiliary cards.
- 5) Slot #1: it contains the 1st H.V. card (controlling the pump n. 1) and must always be present
- 6) Slot #2: it can contain the 2nd H.V. card (controlling the pump n.2) (optional).
- 7) Slot #3 (located on the Internal Expansion board): it can contain an expansion card (Remote I/O Card or MultiGauge Card).
- 8) Slot #4 (located on the Internal Expansion board): it can contain a MultiGauge Card.

- 9) The mother board base location for accepting the RS 232-422 optional card.
- 10) Interlock cover switch (not shown in the figure).
- 11) Cooling fans: they are on the top cover to force the air into the unit for cooling purpose.

**NOTE**

*Leave at least 30 mm (1.2 inches) of free air circulation on top and bottom of the unit for an efficient cooling of the cards. Blind with the provided covers the unused slots. on rear panel*

**MULTIVAC BASE SPECIFICATIONS**

Input:	
- Voltage (selectable at the bottom of the case)	90 to 130 Vac - 1 phase (use setting 110) 180 to 265 Vac - 1 phase (use setting 220)
- Frequency	47 to 63 Hz
- Power	1200 W (for maximum configuration)
- Fuse	15A slow blow (qty 2)
Operating:	
- Temperature	0 to + 45° C
- Humidity	90% maximum non condensing humidity
Radio interference suppression	Conforms to: EN 55011 class A group 1 IEC 1000-4-2/3/4
Disturbances limit	IEC 555 - 1,2,3
Safety requirements	Conforms to: CEI66-3 IEC 348 CSA C 22.2/0 and CSA C 22.2/151
Cables	Mains (2 meter long, 3 wires)
Weight (base unit)	8.5 kg (18.7 lbs)

# TECHNICAL INFORMATION

## CONTROLLER OUTLINE

The outline dimensions for the MultiVac controller base unit are shown in the following figure.

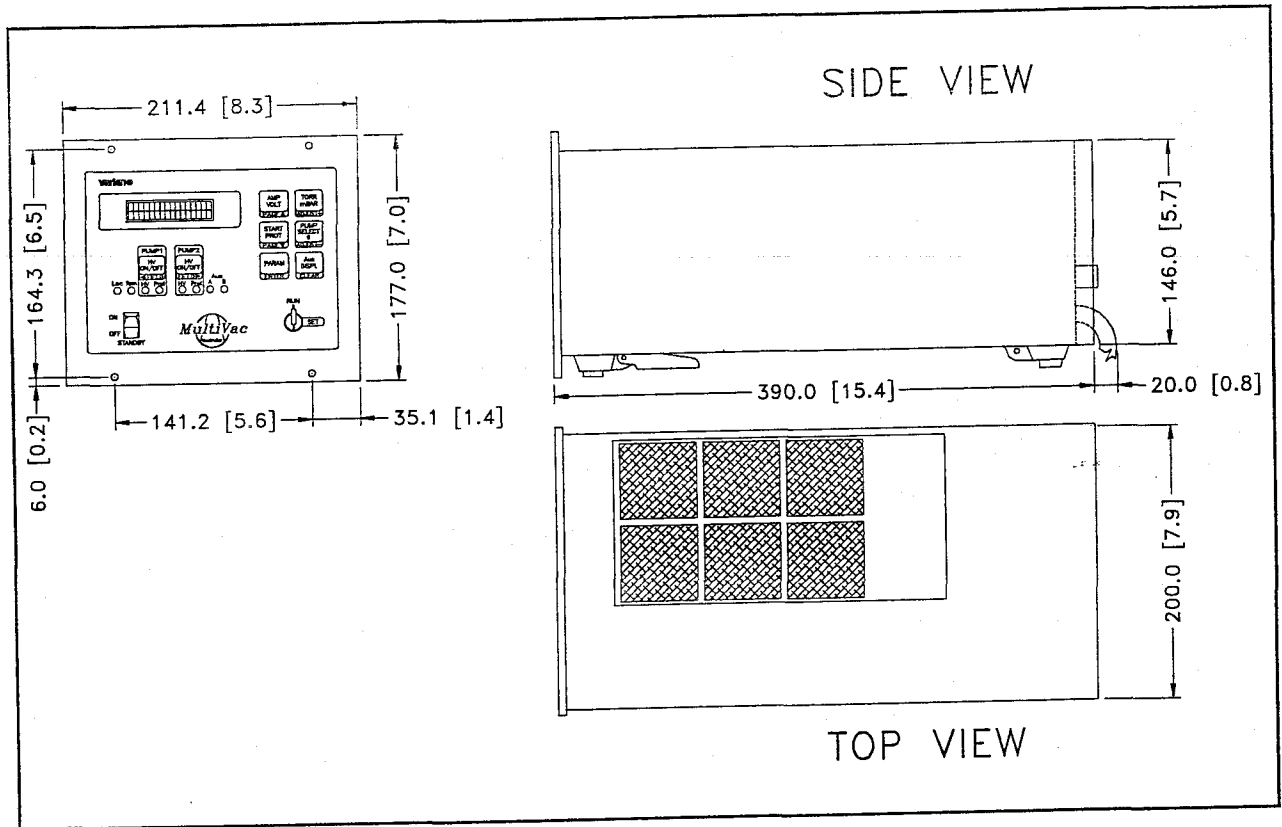

Controller outline

**LARGE VACION PLUS HIGH VOLTAGE CARD**

**Card Description**

The Large Vaclon Plus High Voltage (H.V.) card is a power supply designed to meet a wide range of requirements when used in conjunction with the MultiVac controller base unit.

It is a compact and light card, specifically designed to operate ion pumps with both positive and negative polarity from 20 l/s to 500 l/s and up to 400 W output power.

The card is programmed with 15 pre-defined pump settings and the user can tailor for his purpose the polarity, voltage, short circuit current, maximum power, pressure versus current curve for one more pump not included in the pre-defined type of pumps. Using a patented operation principle, the controller is capable of reading pressure down to the  $10^{-11}$  Torr range, while optimizing the pumping speed in the entire operating range.

The card is basically composed of 3 parts (see the following block diagram):

- a) High frequency switching PCB for high voltage generation and control. The ac voltage from base unit is rectified and feeds a group of power MOSFETS. A power wave modulator (PWM) generates a high frequency square wave with a variable duty-cycle.

This wave is then applied to the gates of the power MOSFETS making them commute between conduction and interdiction. The output is applied to a transformer whose secondary winding is connected to a high voltage multiplier. The resulting output voltage and current are continuously measured and compared with the desired values set by the microprocessor. The PWM changes its output proportionally to maintain the desired values.

- b) High voltage multiplier module. This is composed of a multiplier ladder made by capacitors and diodes that rectify and multiply the voltage coming from the secondary of the transformer and then sent to the output connector.
- c) Read-out circuitry. The output voltage and the current drawn by the pump are continuously updated. This information is sent to the PWM controller closing the output regulation loop and also converted into a digital signal and sent to the microprocessor in the base unit.

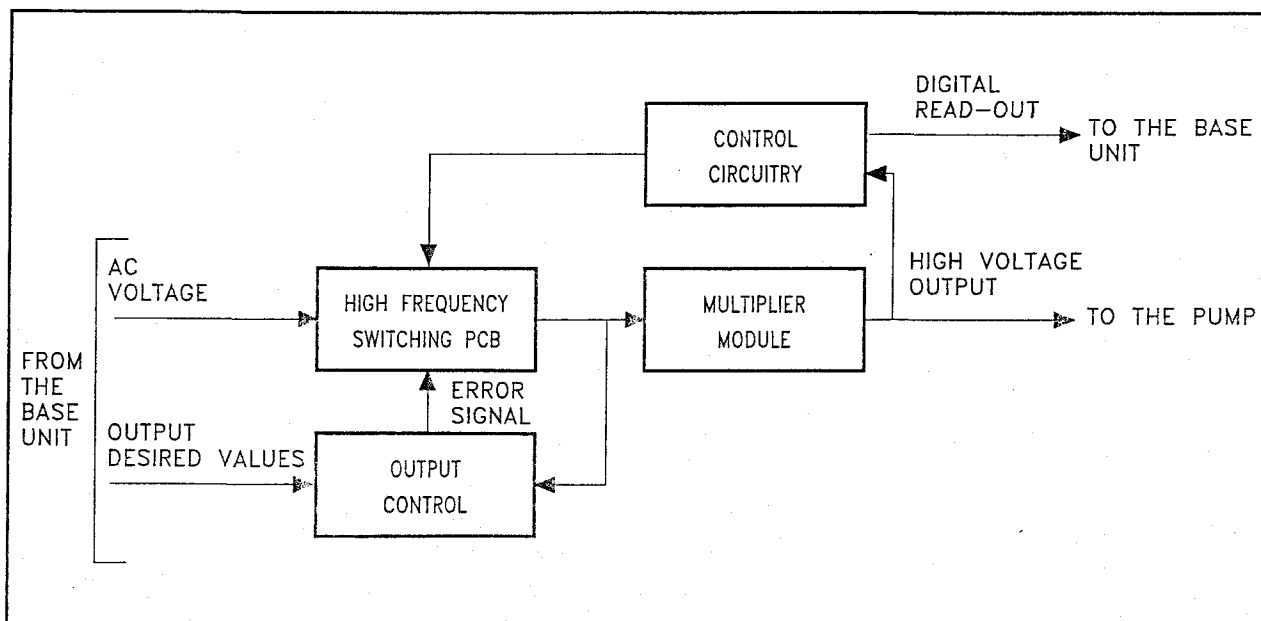

Block diagram



# TECHNICAL INFORMATION

## Card Specifications

(See the table in the following page for the different pump models)

Output (max):	
- Voltage	$\pm 7000 \text{ Vdc} + 2\% -10\%$ (see the output voltage vs current curve)
- Current	400 mA maximum
- Power	400 W maximum
- Polarity	Positive or negative selected through internal module
- Recorder	Analog signal 0 to + 5 Vdc (see the recorder output diagram) (Minimum recorder input impedance 1 M $\Omega$ ) Logarithmic, proportional to pressure
- For Protect and Step mode of operation see the following tables.	
Weight	2,5 kg (5.5 lbs)

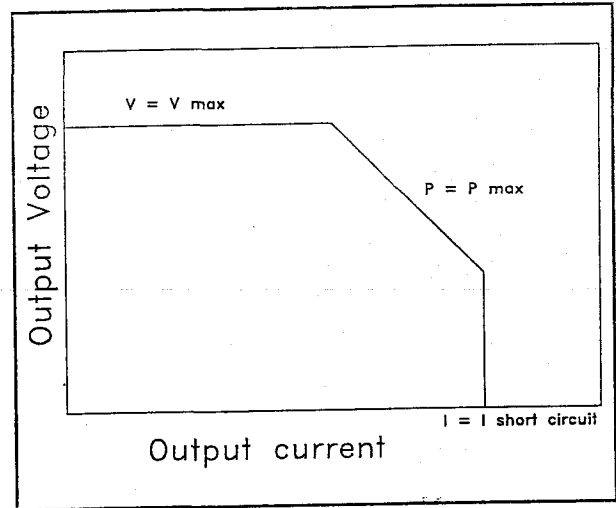

Output voltage vs current curve

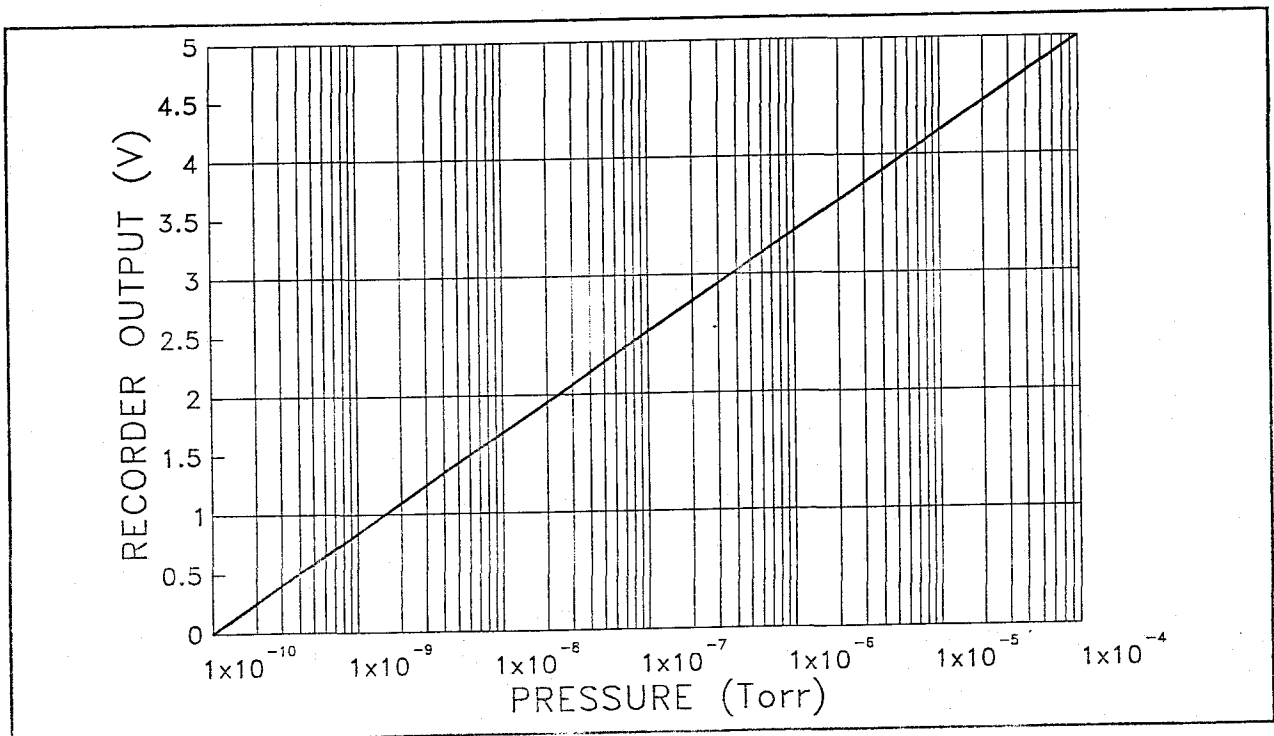

Recorder output

Start mode of operation

Pump size/type	Model number	Maximum voltage and polarity	Short circuit current	Maximum power
500 StarCell® / Triode	919-0106 919-0206	-7000V	400 mA	400 W
300 StarCell/ Triode	919-0105 919-0205	-7000V	400 mA	400 W
150 StarCell/ Triode	919-0104 919-0204	-7000V	300 mA	400 W
75, 55, 40 StarCell Triode	919-0103 919-0102 919-0101 919-0203 919-0202 919-0201	-7000V	250 mA	200 W
20 StarCell	919-0235 919-0236	-7000V	150 mA	150 W
400 l/s Triode	912-7022	-7000V	400 mA	400 W
220 l/s Triode	912-7014	-7000V	400 mA	400 W
110 l/s Triode	912-7006	-7000V	300 mA	400 W
30, 60 l/s Triode	911-5032 911-5034	-7000V	250 mA	200 W
25 Triode	911-5030	-5000V	150 mA	150 W
500 Diode Noble Diode	919-0406 919-0306	+ 7000V	400 mA	400 W
300 Diode Noble Diode	919-0405 919-0305	+ 7000V	400 mA	400 W
150 Diode Noble Diode	919-0404 919-0304	+ 7000V	300 mA	400 W
75 Diode Noble Diode 55 Diode Noble Diode 40 Diode Noble Diode	919-0403 919-0303 919-0402 919-0302 919-0401 919-0301	+ 7000V	250 mA	200 W
25 Diode Noble Diode	911-5036 911-5050	+ 5000V	150 mA	150 W
Spare	-	± 7000V	400 mA	400 W

Protect mode of operation

When the current value exceeds the trip current for more than 0.2 seconds, the power supply turns off the high voltage, and an error message is displayed.

Pump size/type	Protect trip current
500 StarCell/Triode	100 mA
300 StarCell/Triode	100 mA
150 StarCell/Triode	50 mA
40 - 55 - 75 StarCell/Triode	30 mA
20 StarCell	20 mA
400 l/s Triode	100 mA
220 l/s Triode	100 mA
110 l/s Triode	50 mA
30 - 60 l/s Triode	30 mA
25 Triode	20 mA
500 Diode/Noble Diode	100 mA
300 Diode/Noble Diode	100 mA
150 Diode/Noble Diode	50 mA
40 - 55 - 75 Diode/Noble Diode	30 mA
25 Diode/Noble Diode	20 mA
Spare	400 mA

# TECHNICAL INFORMATION

## Step mode of operation

When the current reaches the value listed in the table, the controller changes the voltage output.

Pump size/type	Current value for switching from 7.0 to 5 KV		Current value for switching from 5 to 3 KV
500 StarCell Triode	$9.0 \times 10^{-4}$ A	see also Fig. 1	$2.5 \times 10^{-5}$ A
300 StarCell Triode	$5.5 \times 10^{-4}$ A		$1.6 \times 10^{-5}$ A
150 StarCell Triode	$3.0 \times 10^{-4}$ A		$8.5 \times 10^{-6}$ A
40, 55, 75 StarCell Triode	$1.3 \times 10^{-4}$ A		$3.8 \times 10^{-6}$ A
20 StarCell	$6.5 \times 10^{-5}$ A		$1.9 \times 10^{-6}$ A
400 l/s Triode	$2.0 \times 10^{-3}$ A		$4.4 \times 10^{-5}$ A
220 l/s Triode	$1.1 \times 10^{-3}$ A		$2.5 \times 10^{-5}$ A
110 l/s Triode	$6.2 \times 10^{-4}$ A		$1.2 \times 10^{-5}$ A
30, 60 l/s Triode	$2.7 \times 10^{-4}$ A	$6.7 \times 10^{-6}$ A	
25 Triode	-	see also Fig. 2	$2.8 \times 10^{-6}$ A
500 Diode Noble Diode	$1.4 \times 10^{-3}$ A	see also Fig. 1	$3.9 \times 10^{-5}$ A
300 Diode Noble Diode	$7.2 \times 10^{-4}$ A		$2.1 \times 10^{-5}$ A
150 Diode Noble Diode	$3.6 \times 10^{-4}$ A		$9.5 \times 10^{-6}$ A
40, 55, 75 Diode Noble Diode	$2.2 \times 10^{-4}$ A		$6.7 \times 10^{-6}$ A
25 Diode Noble Diode	-	see also Fig. 2	$2.7 \times 10^{-6}$ A
Spare	User selection	-	User selection

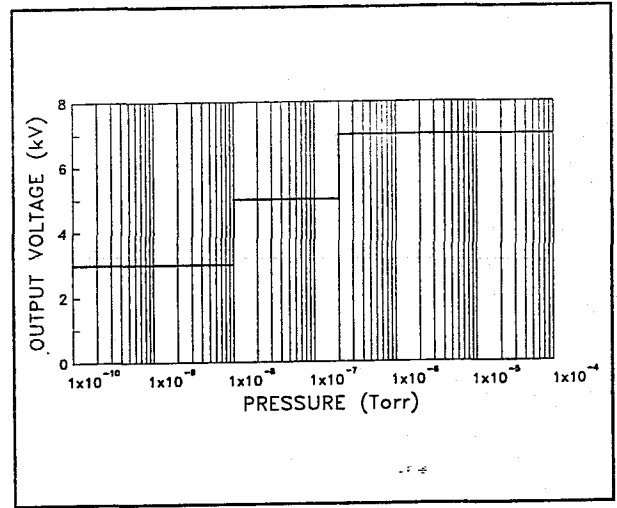

Fig. 1 - Output voltage change-over vs pressure

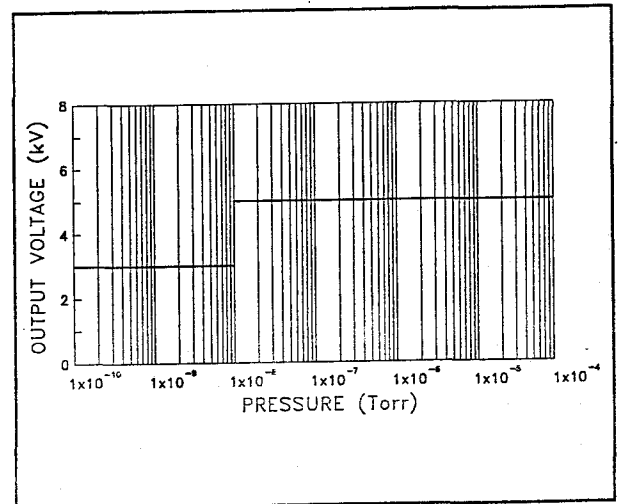

Fig. 2 - Output voltage change-over vs pressure

**MEDIUM VACION PLUS HIGH VOLTAGE CARD**

**Card Description**

The Medium Vaclon Plus High Voltage (H.V.) card is a power supply designed to meet a wide range of requirements when used in conjunction with the MultiVac controller base unit.

It is a compact and light card, specifically designed to operate ion pumps with both positive and negative polarity from 20 l/s to 75 l/s and up to 200 W output power.

The card is programmed with 6 pre-defined pump settings. Using a patented operation principle, the controller is capable of reading pressure down to the  $10^{-11}$  Torr range, while optimizing the pumping speed in the entire operating range.

The card is basically composed of 3 parts (see the following block diagram):

- a) High frequency switching PCB for high voltage generation and control. The ac voltage from base unit is rectified and feeds a group of power MOSFETS. A power wave modulator (PWM) generates a high frequency square wave with a variable duty-cycle.

This wave is then applied to the gates of the power MOSFETS making them commutate between conduction and interdiction. The output is applied to a transformer whose secondary winding is connected to a high voltage multiplier. The resulting output voltage and current are continuously measured and compared with the desired values set by the microprocessor. The PWM changes its output proportionally to maintain the desired values.

- b) High voltage multiplier module. This is composed of a multiplier ladder made by capacitors and diodes that rectify and multiply the voltage coming from the secondary of the transformer and then sent to the output connector.
- c) Read-out circuitry. The output voltage and the current drawn by the pump are continuously updated. This information is sent to the PWM controller closing the output regulation loop and also converted into a digital signal and sent to the microprocessor in the base unit.

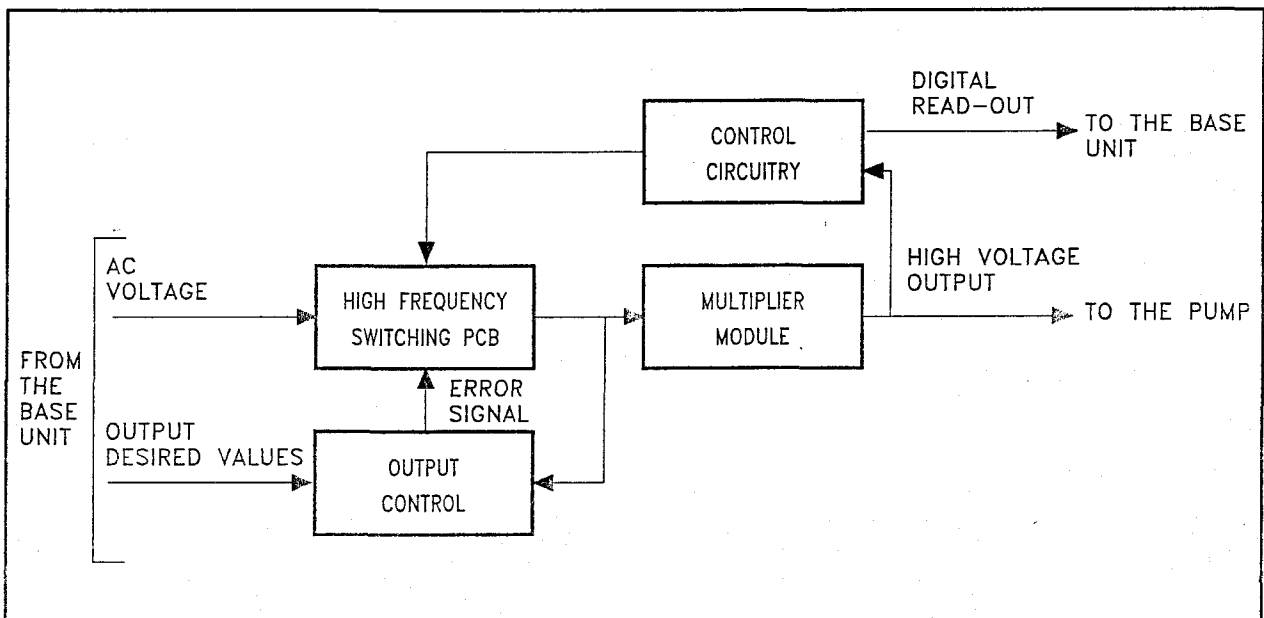

Block diagram

**TECHNICAL INFORMATION**

**Card Specifications**

(See the table in the following page for the different pump models)

Output (max):	
- Voltage	$\pm 7000$ Vdc + 2% -10% (see the output voltage vs current curve)
- Current	200 mA maximum
- Power	200 W maximum
- Polarity	Positive or negative selected through internal module
- Recorder	Analog signal 0 to + 5 Vdc (see the recorder output diagram) (Minimum recorder input impedance 1 M $\Omega$ ) Logarithmic, proportional to pressure
- For Protect and Step mode of operation see the following tables.	
Weight	2,5 kg (5.5 lbs)

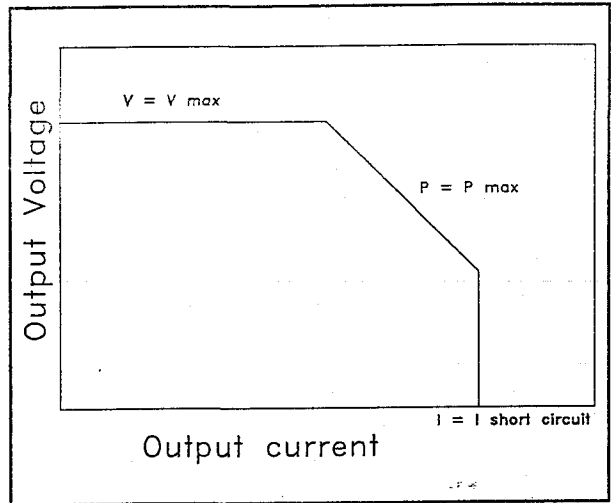

*Output voltage vs current curve*

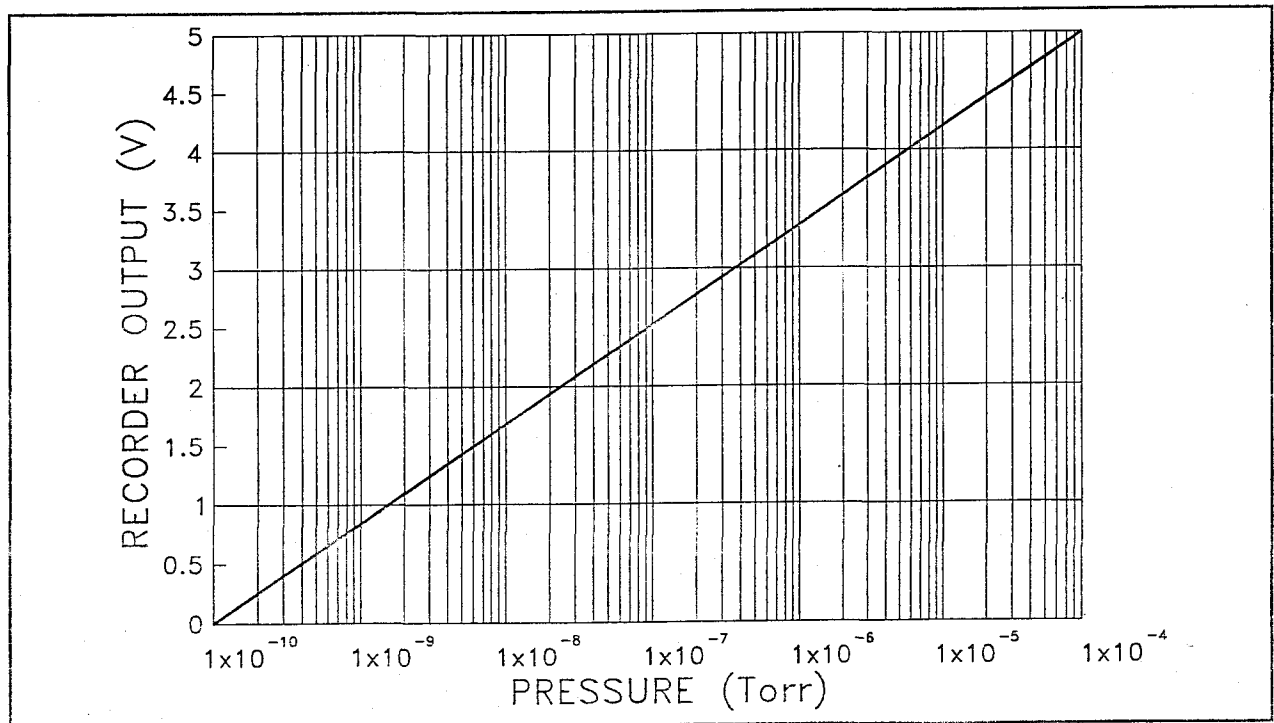

*Recorder output*

Start mode of operation

Pump size/type	Model number	Maximum voltage and polarity	Short circuit current	Maximum power
75, 55, 40 StarCell Triode	919-0103 919-0102 919-0101 919-0203 919-0202 919-0201	-7000V	250 mA	200 W
20 StarCell	919-0235 919-0236	-7000V	150 mA	150 W
30, 60 l/s Triode	911-5032 911-5034	-7000V	250 mA	200 W
25 Triode	911-5030	-5000V	150 mA	150 W
75 Diode Noble Diode 55 Diode Noble Diode 40 Diode Noble Diode	919-0403 919-0303  919-0402 919-0302  919-0401 919-0301	+ 7000V	250 mA	200 W
25 Diode Noble Diode	911-5036 911-5050	+ 5000V	150 mA	150 W

Protect mode of operation

When the current value exceeds the trip current for more than 0.2 seconds, the power supply turns off the high voltage, and an error message is displayed.

Pump size/type	Protect trip current
40 - 55 - 75 StarCell/Triode	30 mA
20 StarCell	20 mA
30 - 60 l/s Triode	30 mA
25 Triode	20 mA
40 - 55 - 75 Diode/Noble Diode	30 mA
25 Diode/Noble Diode	20 mA

**TECHNICAL INFORMATION**

**Step mode of operation**

When the current reaches the value listed in the table, the controller changes the voltage output.

Pump size/type	Current value for switching from 7.0 to 5 KV		Current value for switching from 5 to 3 KV
40, 55, 75 StarCell Triode	$1.3 \times 10^{-4}$ A	see also Fig. 3	$3.8 \times 10^{-6}$ A
20 StarCell	$6.5 \times 10^{-5}$ A		$1.9 \times 10^{-6}$ A
30, 60 l/s Triode	$2.7 \times 10^{-4}$ A		$6.7 \times 10^{-6}$ A
25 Triode	-	see also Fig. 4	$2.8 \times 10^{-6}$ A
40, 55, 75 Diode Noble Diode	$2.2 \times 10^{-4}$ A	see also Fig. 3	$6.7 \times 10^{-6}$ A
25 Diode Noble Diode	-	see also Fig. 4	$2.7 \times 10^{-6}$ A

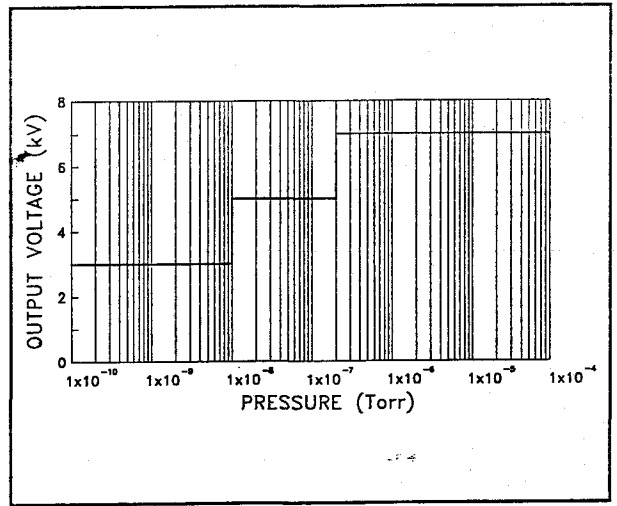

*Fig. 3 - Output voltage change-over vs pressure*

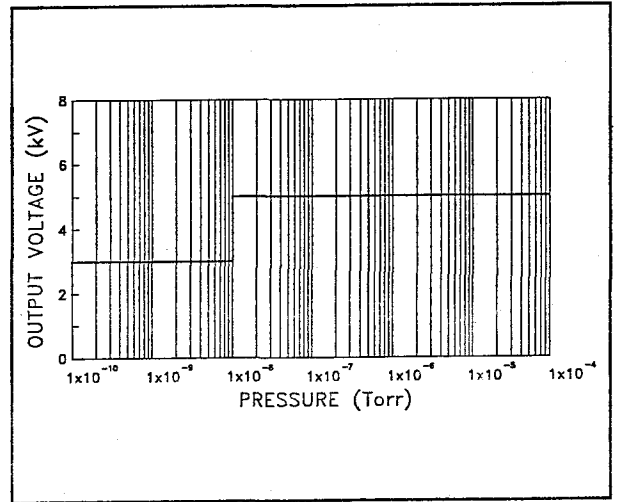

*Fig. 4 - Output voltage change-over vs pressure*

H.V. CARDS OUTLINE

The outline dimensions for the H.V. cards are shown in the following figure.

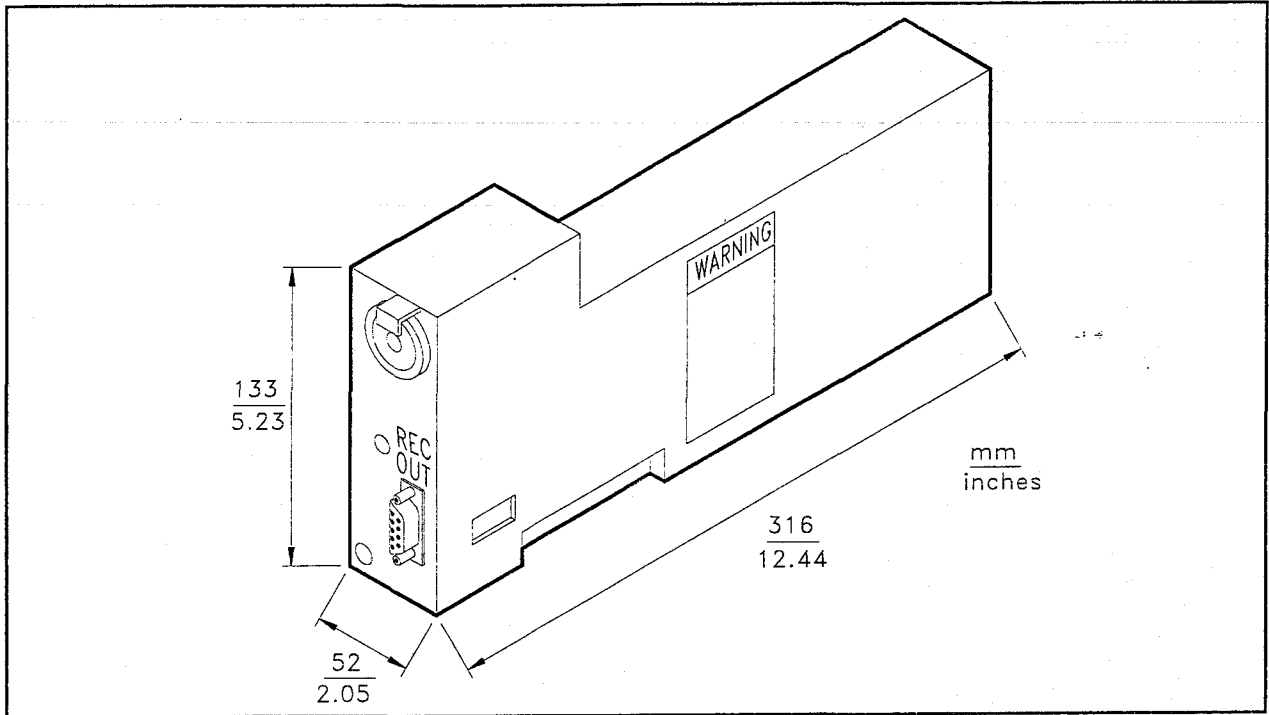

H.V. card outline drawing



H.V. CARD INSTALLATION

General

Inspect the VIP HV card for any shipping damage. The HV card is factory set to:

- models 929-4040 (Large Vaclon Plus H.V. card) and 929-4025 (Medium Vaclon Plus H.V. card) set to Negative polarity
- models 929-4050 (Large Vaclon Plus H.V. card) and 929-4035 (Medium Vaclon Plus H.V. card) set to Positive polarity



**WARNING**

High voltage developed in the card can cause severe injury or death. Before servicing the card disconnect the input power cable of the MultiVac controller base unit.

Polarity Change Over

If there is a need to change the output polarity, proceed as follows:

- Be sure that no power is applied to the MultiVac controller base unit (remove the power cable).
- Unscrew the two H.V. card fixing screws on the MultiVac rear panel and the ground braid then remove the card from the base unit.
- On the HV card undo the 5 screws, indicated by the arrows in the following figure and open in two parts the card.
- Undo the screws 1, 2, 3 and remove the multiplier module.
- Select the desired polarity according to the pump in operation by turning the module and reinstall it.
- Reinsert the Vaclon Plus HV card following the following paragraph instructions.

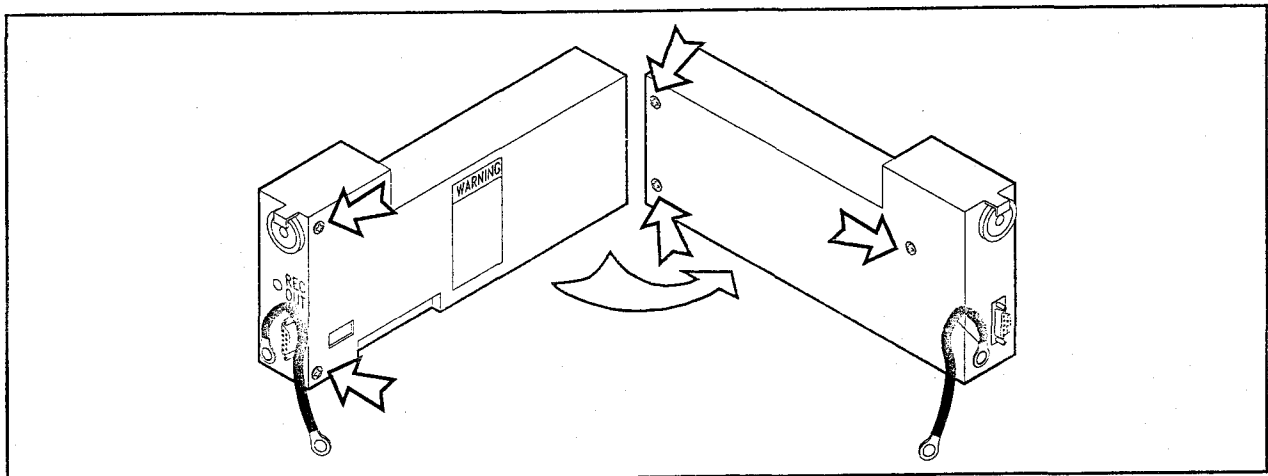

H.V. card

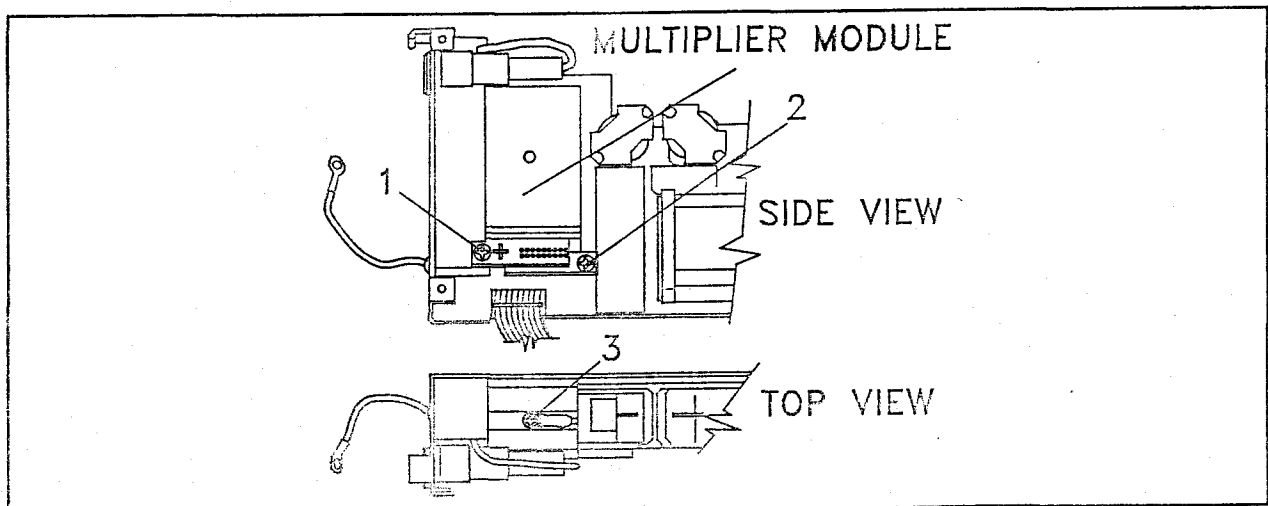

Multiplier module

**Card Installation**

If the MultiVac has not been ordered in the final configuration, the following procedure must be executed for H.V. card insertion into the slots of the base unit.

- Open the unit by removing the four screws on the sides of the unit.
- Remove the fixing screw from the card and insert the H.V. card as showed in the following figures.

- After the H.V. card has been inserted, fix it with the screws on the rear panel and on the bottom side of the base unit, and connect the external ground wire.
- Be sure that the provided blank filler plates are installed in any open rear panel locations.
- Verify that there is no loose hardware or metal parts inside the unit; replace the cover and secure it with the 4 screws.

**NOTE**

*During installation the card side must slide on the reference pin and must be pushed towards the rear panel.  
After the insertion, the hook point must enter into the hole.*

**NOTE**

*Slot number 1 must always be occupied by an High Voltage card. If not a "Test Error" will be displayed.*

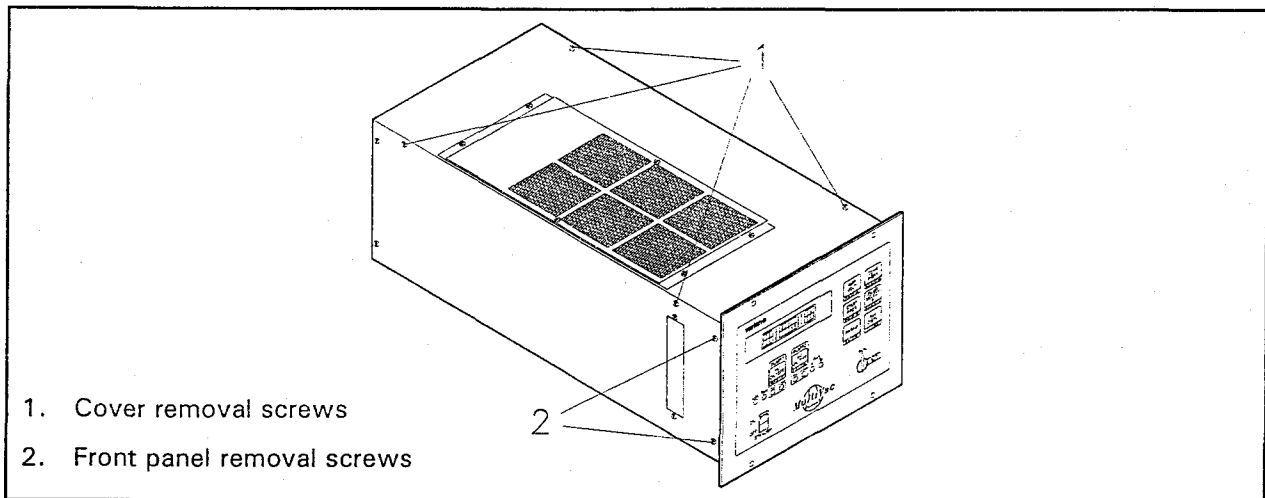

*Cover and front panel fixing screws*

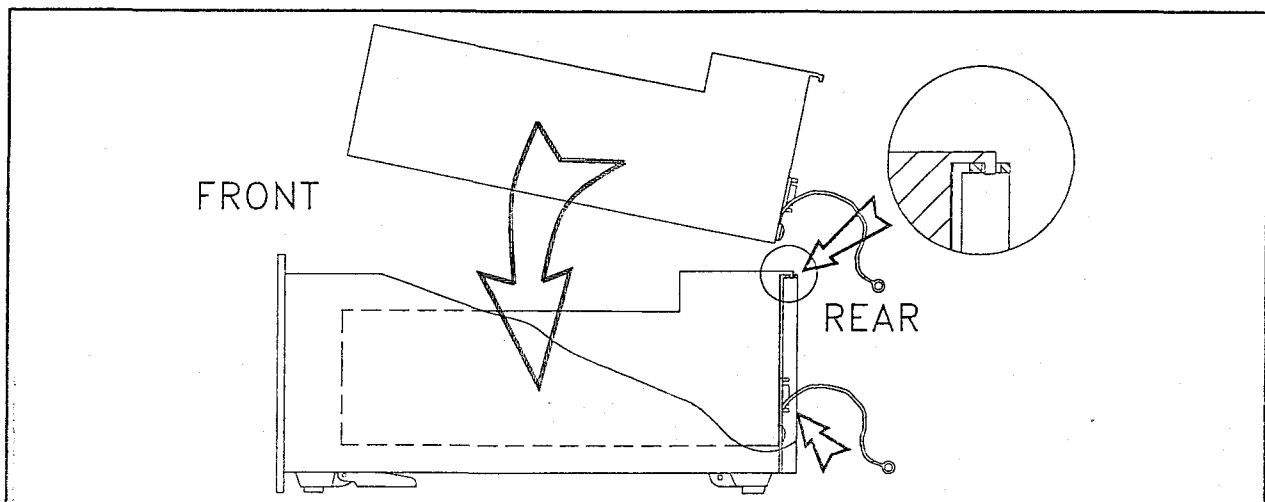

*Card insertion*

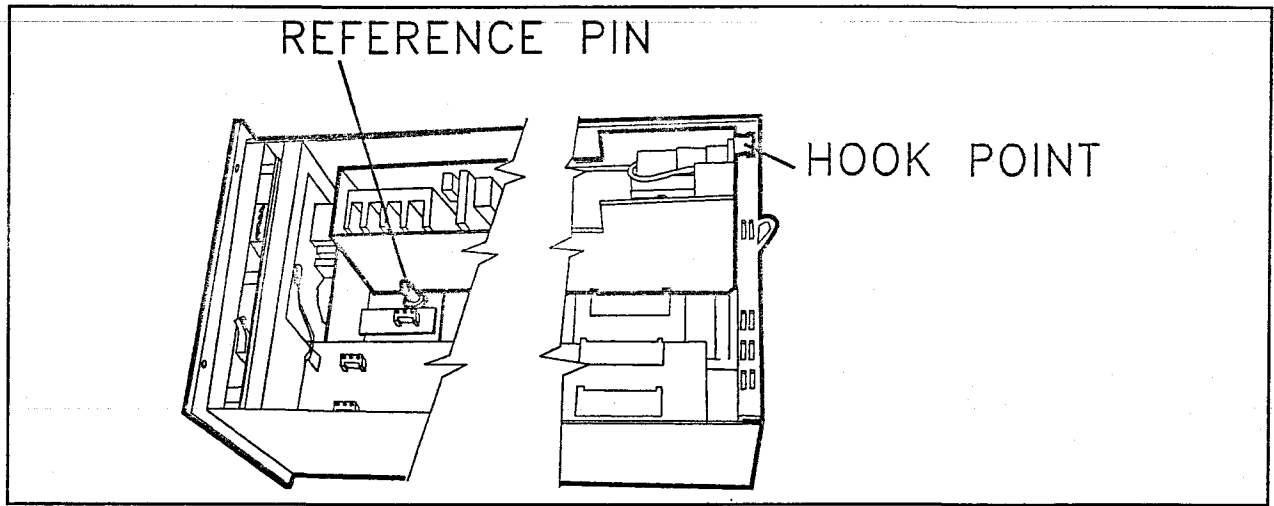

*Installing the H.V. card*

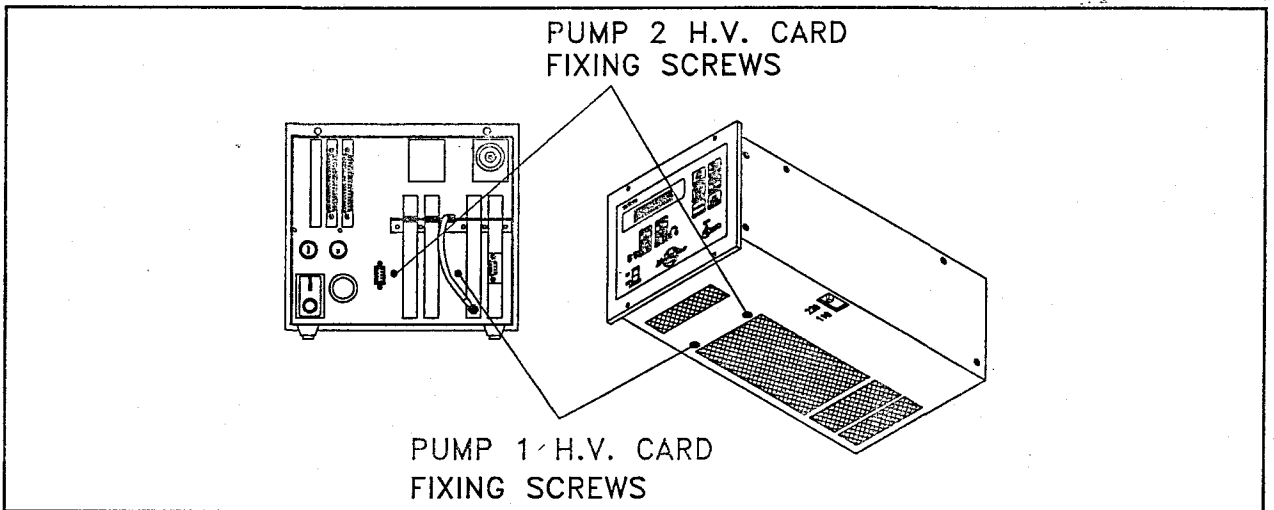

*H.V. card fixing screws*

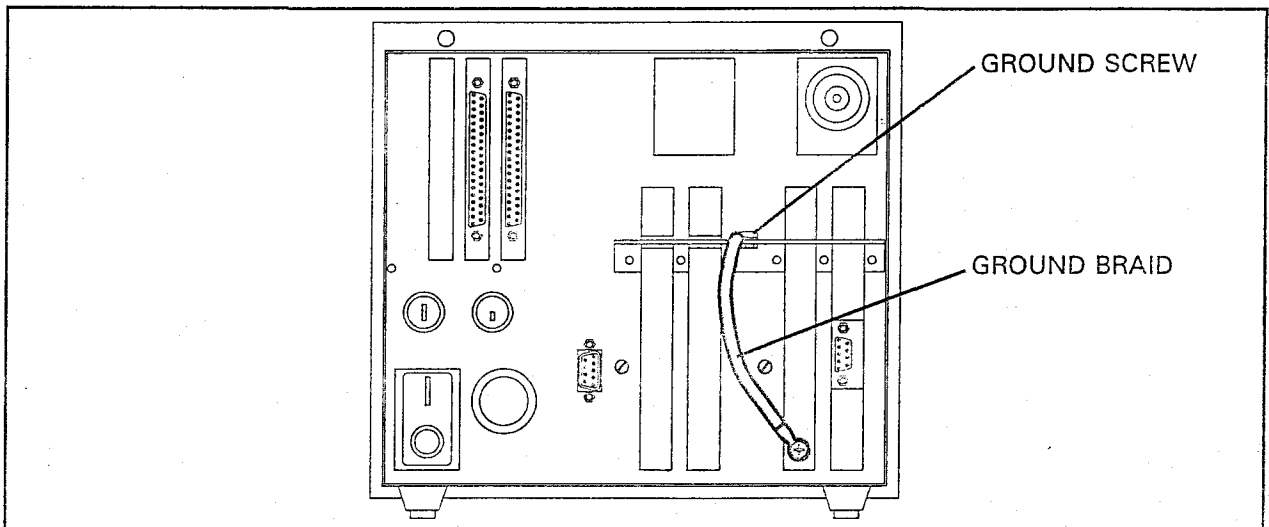

*Ground connection*

**BAYARD ALPERT CARD DESCRIPTION**

The Bayard-Alpert (B/A) control printed circuit board, when used with a MultiVac unit, contains all required circuitry to operate a 563, 564, 571, 572, 580, or similar ion gauge. It is necessary to set a jumper on the B/A board to identify the type of B/A type being used. To operate a standard B/A tube (563, 571 or 572), position the jumper as shown in the following figure where the connector plate has been removed for illustration clarity.

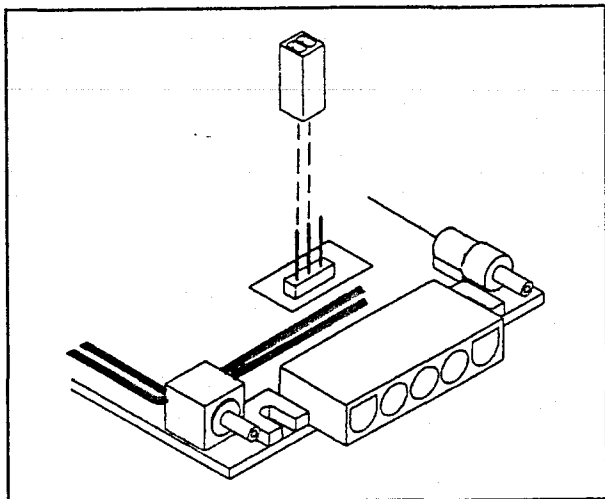

*Jumper position, standard tube*

To operate a broad range B/A tube (564 or 580), position the jumper as shown in the following figure where the connector plate has been removed for illustration clarity.

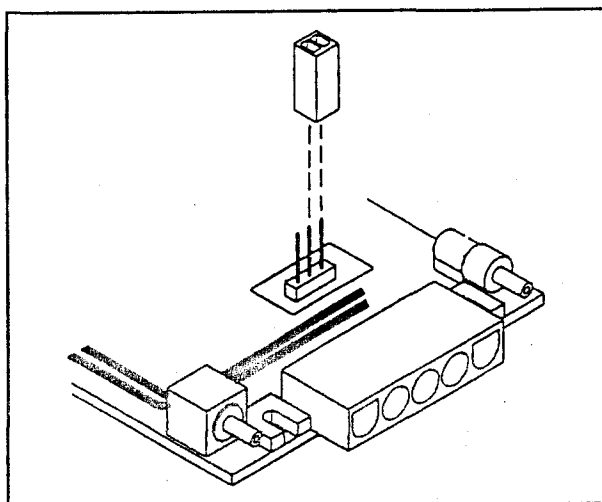

*Jumper position, standard tube*

The jumper is set at the factory to the standard B/A tube position.

**CAUTION**

When using the B/A card to operate a Varian 580 nude gauge, it is necessary to cut the grid support pin flush with the standoff as shown in the following figure. Failure to do so may cause the grid error message to be displayed and/or result in erratic operation of the B/A card. **WEAR EYE PROTECTION WHILE CUTTING THE PIN.**

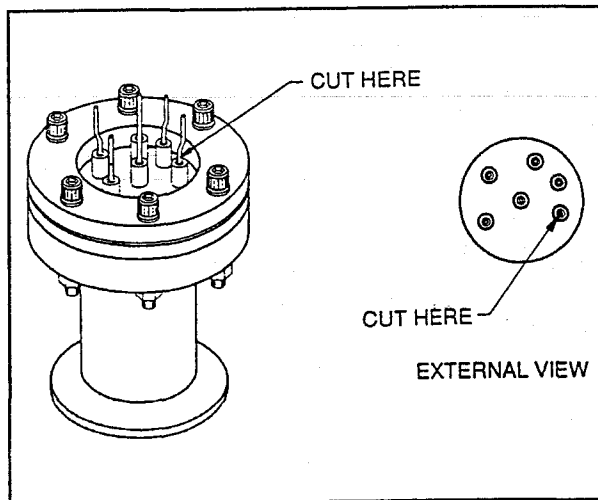

*The grid support*

# TECHNICAL INFORMATION

## Bayard Alpert Card Specifications

Electrometer Accuracy	<p><math>&gt; 10^{-10}</math> Torr <math>\pm 5\%</math> of ion current reading (ion current <math>\geq 10</math> pA)</p> <p><math>&lt; 10^{-10} \pm 20\%</math> of ion current reading (ion current <math>\leq 10</math> pA, <math>I &gt; 4</math> pA)</p>
Emission Current Range	<p>Set to 4.00 mA as a default, currents can be set from 10 <math>\mu</math>A to 9.99 mA through the keypad on the front panel of the MultiVac unit. The emission current will remain constant as long as the pressure is <math>&lt; 1 \times 10^{-5}</math> Torr or the emission current is set to <math>\leq 1.00</math> mA. The MultiVac automatically reduces the current by a factor of 10 when the pressure is <math>&gt; 5 \times 10^{-5}</math> Torr and the emission current is set to <math>\geq 1.01</math> mA.</p>
Alternate Filament Selection	Automatic for a dual filament gauge.
Overpressure Protection	Automatic gauge tube turn-off when pressure equals or exceeds $1 \times 10^{-3}$ Torr for standard B/A tubes (563, 571 and 572) or $1 \times 10^{-1}$ Torr for broad range B/A tubes (564 and 580).
Degas	Resistive, 25 W. Can activate only if pressure is $< 10^{-5}$ Torr and no other ion gauge card is degassing. Automatic time-out of approximately one hour.
Recorder Output	1V/decade log-linear output (two-conductor Micro Jax connector plug supplied with board). Recorder output reflects changes in sensitivity and gas correction factors.
Fault Detections	<p>No ion current;</p> <p>Emission current or amplifier fault;</p> <p>Low grid voltage (low degas voltage when in Degas mode);</p> <p>Open filament or no filament current;</p> <p>Filament circuit/cable short;</p> <p>Over temperature shutdown - gauge power shuts off when internal temperature reaches <math>\geq 65</math> °C.</p>

Cable Length	Standard cables with lengths of 10, 25, 50, 75 and 100 feet are available from stock. Non-standard length cables (up to 500 feet) are available on special order (see the following table). Connections are made at the rear of the card (see the following figure).
Sensitivity	The default setting is 10.0 per Torr for standard B/A tubes (563, 571 and 572) and 8.0 per Torr for broad range B/A tubes (564 and 580). Can be set from 0.1 to 99.9 per Torr through the keypad.
Gas Correction	Set to 1.00 (N <sub>2</sub> ) as a default, can be set from 0.01 to 9.99 through the keypad.

### NOTE

*Measurements in the high vacuum range may be inaccurate or impossible due to increased leakage currents and other effects due to long cable lengths. It is recommended that teflon low-capacitance cable be used and that it be rigidly mounted to avoid triboelectric and leakage effects.*

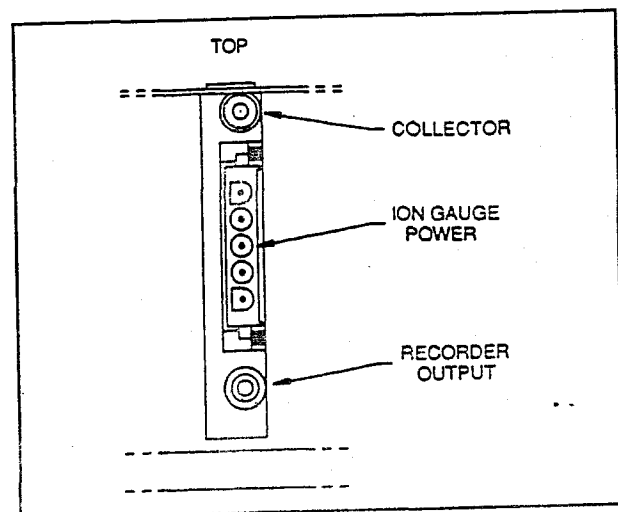

Card connections

Non Standard Cables

Length (feet)	Wire size (AWG) each wire
Up to 50	18
75	16
100	14
200	12
500	8

control card. Varian strongly recommends using a coaxial cable to maintain compliance with FCC regulations. Refer to the following figure for instructions on assembling the cable.

Any recorder with an input impedance greater than 2,000 ohms and which has a full scale input range of +10 V can be used.

The output characteristics are shown in the following figure.

The recorder output reflects the reading on the display and does not require adjustments to compensate for different emission or sensitivity settings. When the gauge is off, the output is 0 V.

Using the Recorder Output

To use the recorder output feature, assemble a cable to the Micro Jax plug supplied with the B/A

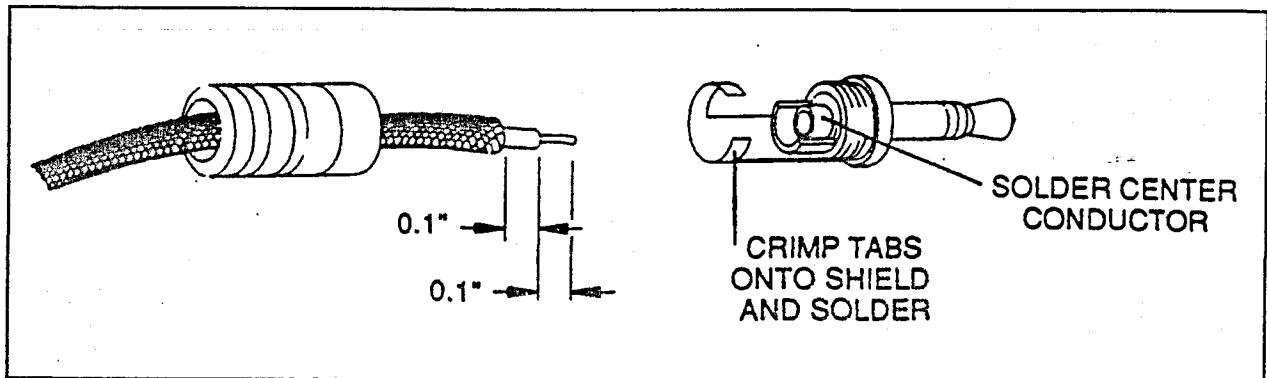

Assembling the Cable/Plug

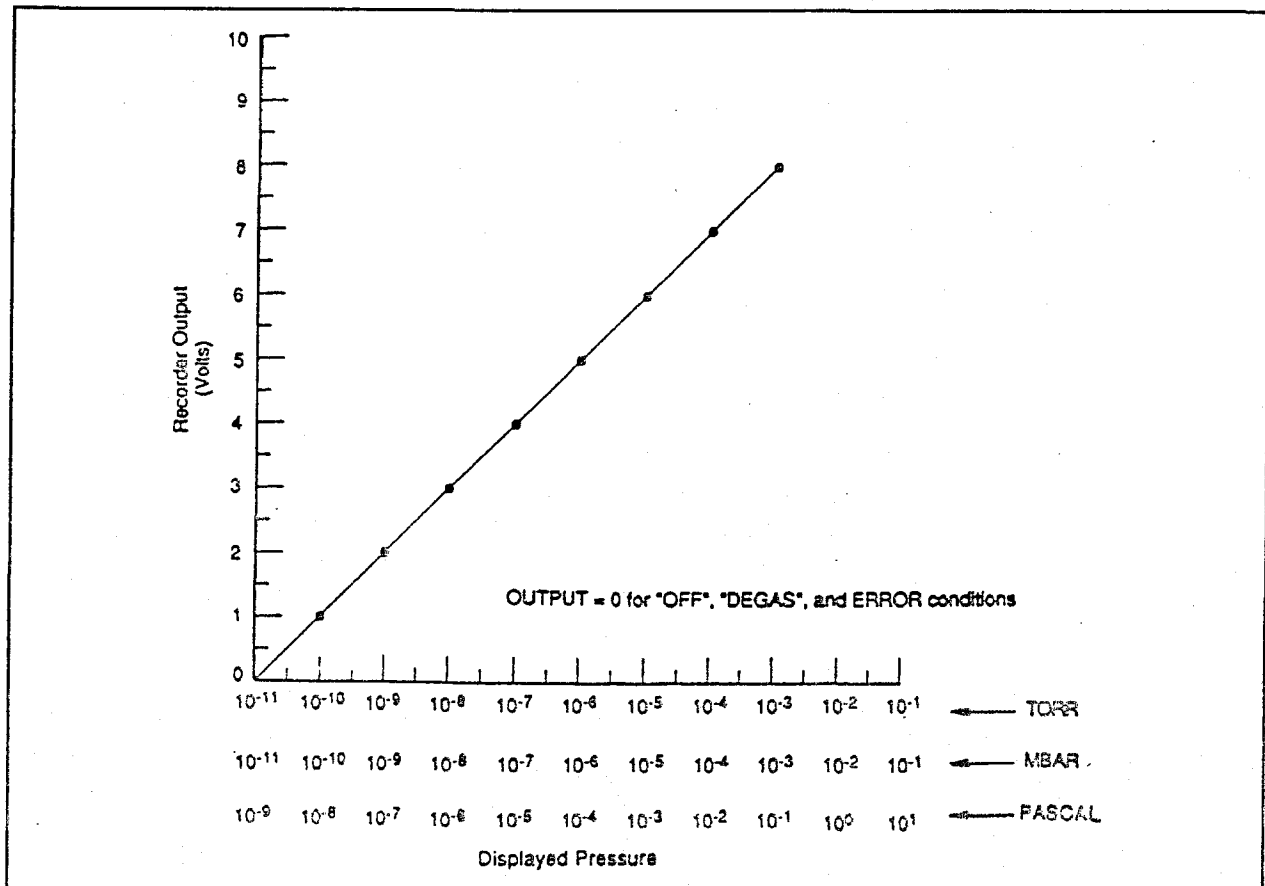

Recorder Output Characteristics

**UHV CARD DESCRIPTION**

The UHV control printed circuit board, when used with a MultiVac unit, contains all required circuitry to operate a UHV-24 or similar ion gauge. It can be installed in any one of the two slots in the unit.

**Specifications**

Electrometer Accuracy	<p><math>&gt; 10^{-10}</math> Torr <math>\pm 5\%</math> of ion current reading (ion current <math>\geq 10</math> pA)</p> <p><math>&lt; 10^{-10} \pm 20\%</math> of ion current reading (ion current <math>\leq 10</math> pA, <math>I &gt; 4</math> pA)</p>
Emission Current Range	<p>Set to 4.00 mA as a default, currents can be set from 10 <math>\mu</math>A to 9.99 mA through the keypad on the front panel of the MultiVac unit. The emission current will remain constant as long as the pressure is <math>&lt; 1 \times 10^{-5}</math> Torr or the emission current is set to <math>\leq 1.00</math> mA. The MultiVac automatically reduces the current by a factor of 10 when the pressure is <math>&gt; 5 \times 10^{-5}</math> Torr and the emission current is set to <math>\geq 1.01</math> mA.</p>
Alternate Filament Selection	Automatic for a dual filament gauge.
Overpressure Protection	Automatic gauge tube turn-off when pressure equals or exceeds $1 \times 10^{-3}$ Torr.
Degas	<p>Electron beam bombardment, including the collector lead: 400 V at 65 mA.</p> <p>Can activate only if pressure is <math>&lt; 10^{-5}</math> Torr and no other board is degassing. Automatic time-out of approximately 15 minutes.</p>
Recorder Output	<p>1V/decade log-linear output (two-conductor Micro Jax connector plug supplied with board).</p> <p>Recorder output reflects changes in sensitivity and gas correction factors.</p>
Fault Detections	<p>No ion current;</p> <p>Emission current or amplifier fault;</p> <p>Low grid voltage (low degas voltage when in Degas mode);</p> <p>Open filament or no filament current;</p> <p>Filament circuit/cable short;</p> <p>Over temperature shutdown - gauge power shuts off when internal temperature reaches <math>\geq 65</math> °C.</p>

Cable Length	Standard cables with lengths of 10, 25, 50, 75 and 100 feet are available from stock. Longer cables are available on special order (see the following table). Connections are made at the rear of the card as shown in the following figure.
Sensitivity	Set to 25 per Torr as a default, can be set from 0.1 to 99.9 per Torr through the keypad.
Gas Correction	Set to 1.00 (N <sub>2</sub> ) as a default, can be set from 0.01 to 9.99 through the keypad.

**NOTE**

*Measurements in the high vacuum range may be inaccurate or impossible due to increased leakage currents and other effects due to long cable lengths. It is recommended that teflon low-capacitance cable be used and that it be rigidly mounted to avoid triboelectric and leakage effects.*

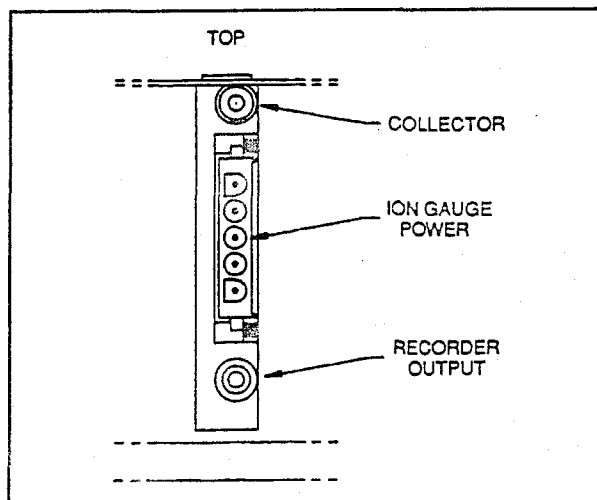

Card connections

Non Standard Cables

Length (feet)	Wire size (AWG) each wire
Up to 50	18
75	16
100	14
200	12
500	8

Using the Recorder Output

To use the recorder output feature, assemble a cable to the Micro Jax plug supplied with the UHV

control card. Varian strongly recommends using a coaxial cable to maintain compliance with FCC regulations. Refer to the following figure for instructions on assembling the cable.

Any recorder with an input impedance greater than 2,000 ohms and which has a full scale input range of +10 V can be used.

The output characteristics are shown in the following figure.

The recorder output reflects the reading on the display and does not require adjustments to compensate for different emission or sensitivity settings. When the gauge is off or degassing, the output is 0 V.

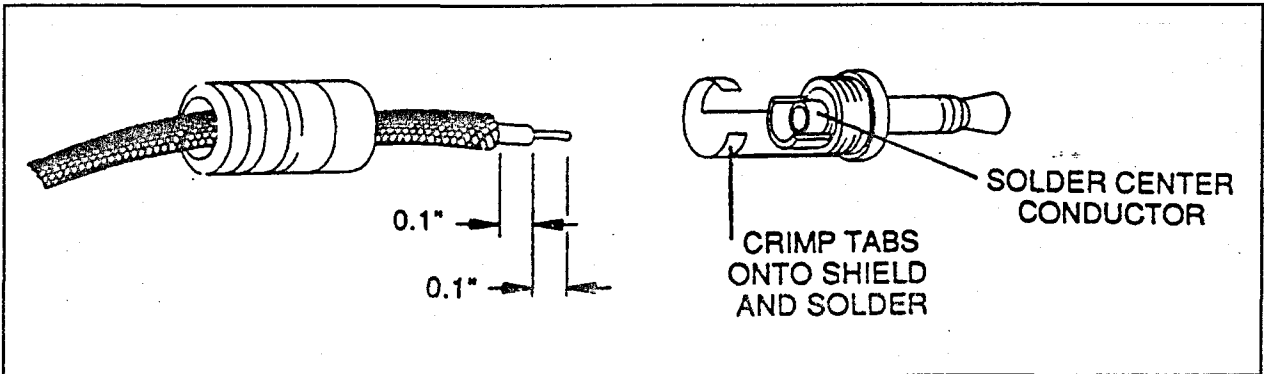

Assembling the Cable/Plug

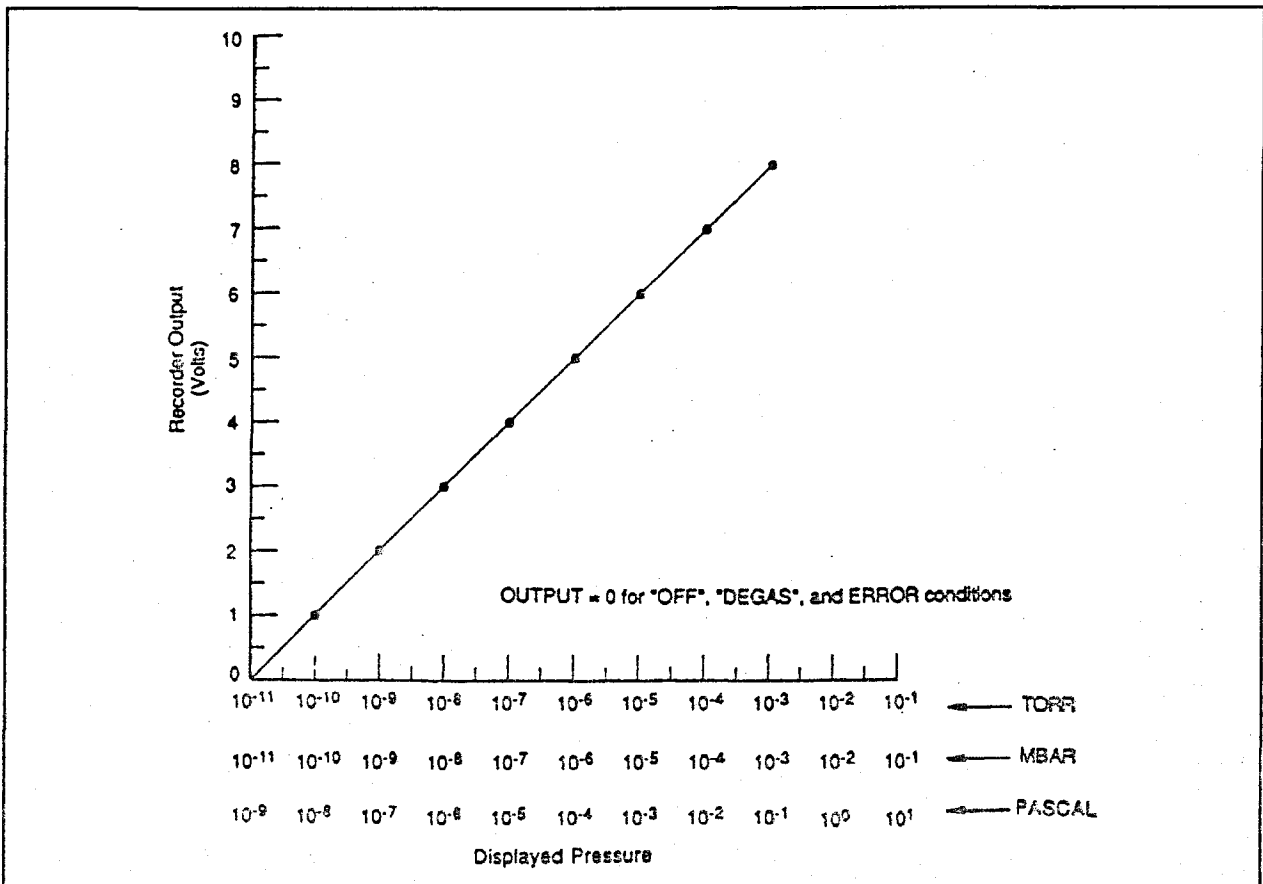

Recorder Output Characteristics



**COLD CATHODE BOARD DESCRIPTION**

The Cold Cathode Board is designed to operate the Varian 524 (bakeable) and 525 (non-bakeable) gauge heads with cable lengths up to 500 feet. Its operating voltage is -2 kV. The use of software linearization and dynamic power modulation allows a useful range exceeding  $1 \times 10^{-2}$  to  $1 \times 10^{-7}$  Torr.



Cold Cathode Gauges require the use of a HIGH-VOLTAGE source which can be LETHAL. Proper grounding of the MultiVac unit and the gauge head are necessary. USE EXTREME CAUTION when working with these instruments; the instrument must be operated only by properly trained personnel. DO NOT OPERATE THE MULTIVAC WITH THE COVER OFF.

**Specifications**

Electrometer Accuracy	$> 10^{-6}$ Torr $\pm 5\%$ of ion current reading (ion current $\geq 5$ mA)
Overpressure Protection	Automatic gauge tube turn-off when pressure equals or exceeds $2 \times 10^{-2}$ Torr.
Recorder Output	1V/decade log-linear output (two-conductor Micro Jax connector plug supplied with board). Recorder output reflects changes in sensitivity and gas correction factors.
Cable Length	Standard cables with lengths of 10, 25, 50, 75 and 100 feet are available from stock. Longer cables (up to 500 feet long) are available on special order. Connections are made at the rear of the card as shown in the following figure.
Gas Correction	Set to 1.00 ( $N_2$ ) as a default, can be set from 0.01 to 9.99 through the keypad second function F GAS CORR.

**NOTE**

*Measurements in the high vacuum range may be inaccurate or impossible due to increased leakage currents and other effects due to long cable lengths. It is recommended that teflon low-capacitance cable be used and that it be rigidly mounted to avoid triboelectric and leakage effects.*

**Using the Recorder Output**

To use the recorder output feature, assemble a cable to the Micro Jax plug supplied with the Cold Cathode Board. Varian strongly recommends using a coaxial cable to maintain compliance with FCC regulations. Refer to the figure in the following page for instructions on assembling the cable.

Any recorder with an input impedance greater than 2,000 ohms and which has a full scale input range of +10 V can be used.

The output characteristics are shown in the figure of the following page.

The recorder output reflects the reading on the display and does not require adjustments to compensate for different emission or sensitivity settings. When the gauge is off, the output is 0 V.

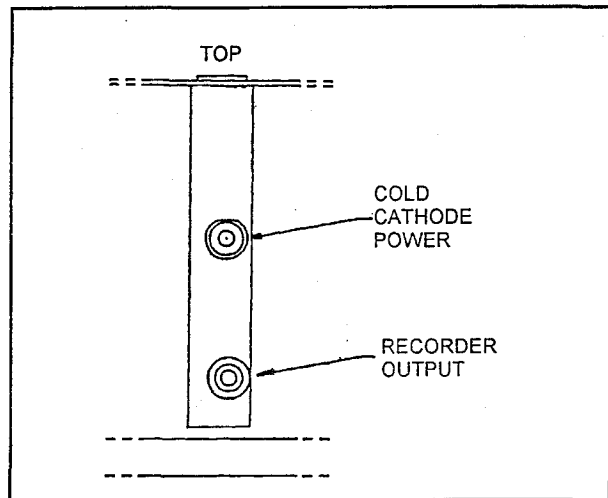

*Card connections*

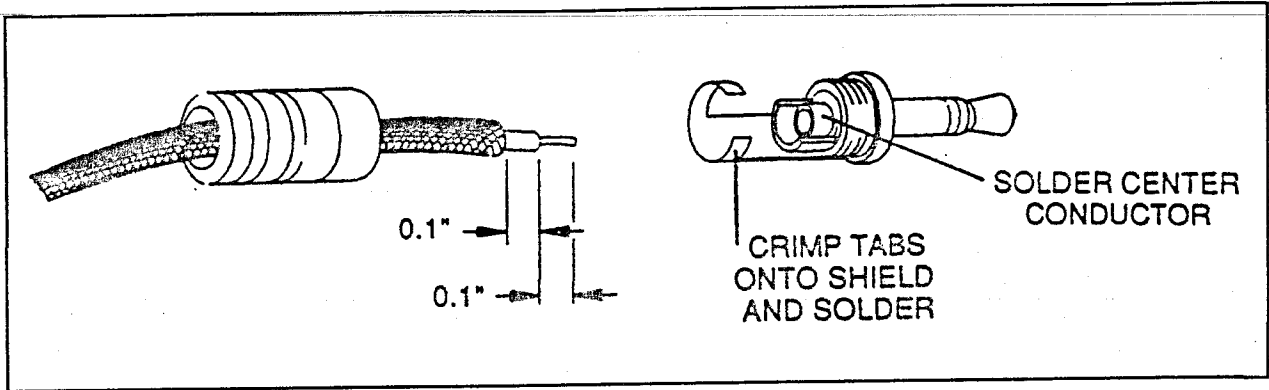

Assembling the Cable/Plug

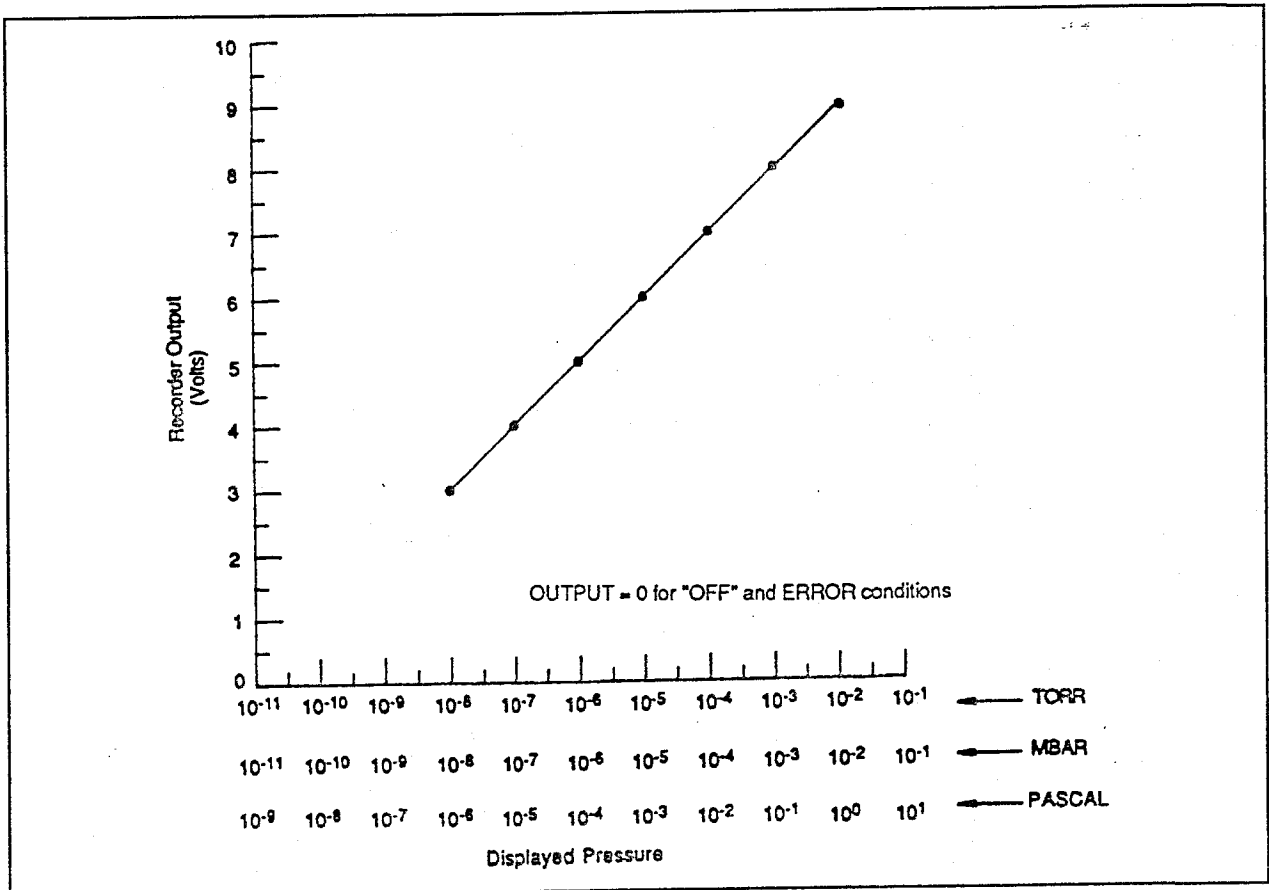

Recorder Output Characteristics

**THERMOCOUPLE PRINTED CIRCUIT BOARD DESCRIPTION**

The Thermocouple Printed Circuit Board, when used with a MultiVac unit, contains all the circuitry required to operate four Model 531 thermocouple gauge tubes. It can be installed in any one of the two slots in the MultiVac unit. After installation, the TC label should be placed on the area provided to help in identifying the card after the cover is installed. Up to two TC cards may be installed for a total of eight available thermocouples.

**Specifications**

Pressure range	2 Torr to $1 \times 10^{-3}$ Torr
TC heater current	165 mA $\pm 10\%$
Recorder Output	0 to 10 V non-linear; see the following figure for connections of user-supplied wiring. Varian recommends the use of shielded wiring to maintain compliance with FCC regulations for radiated emissions. The recorder output does not reflect ATM or VAC settings.
Fault Detections	No cable or open TC circuit; TC power supply fault.

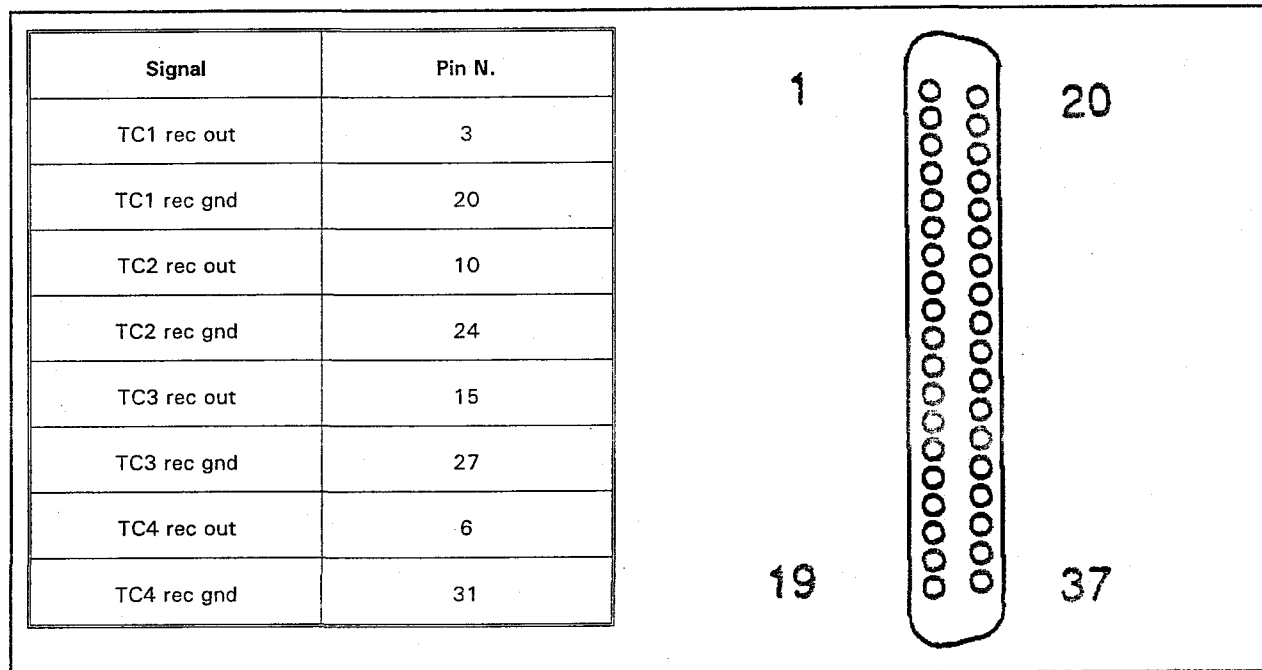

*Pin connector*

Recorder Output

The following figure shows a plot of nominal thermocouple response versus pressure for various common gases as available at the recorder output terminal. Since the recorder output does not reflect the result of using the ATM or VAC functions, use of these outputs should be restricted to providing an indication of changes in pressure levels as opposed to absolute measurements.

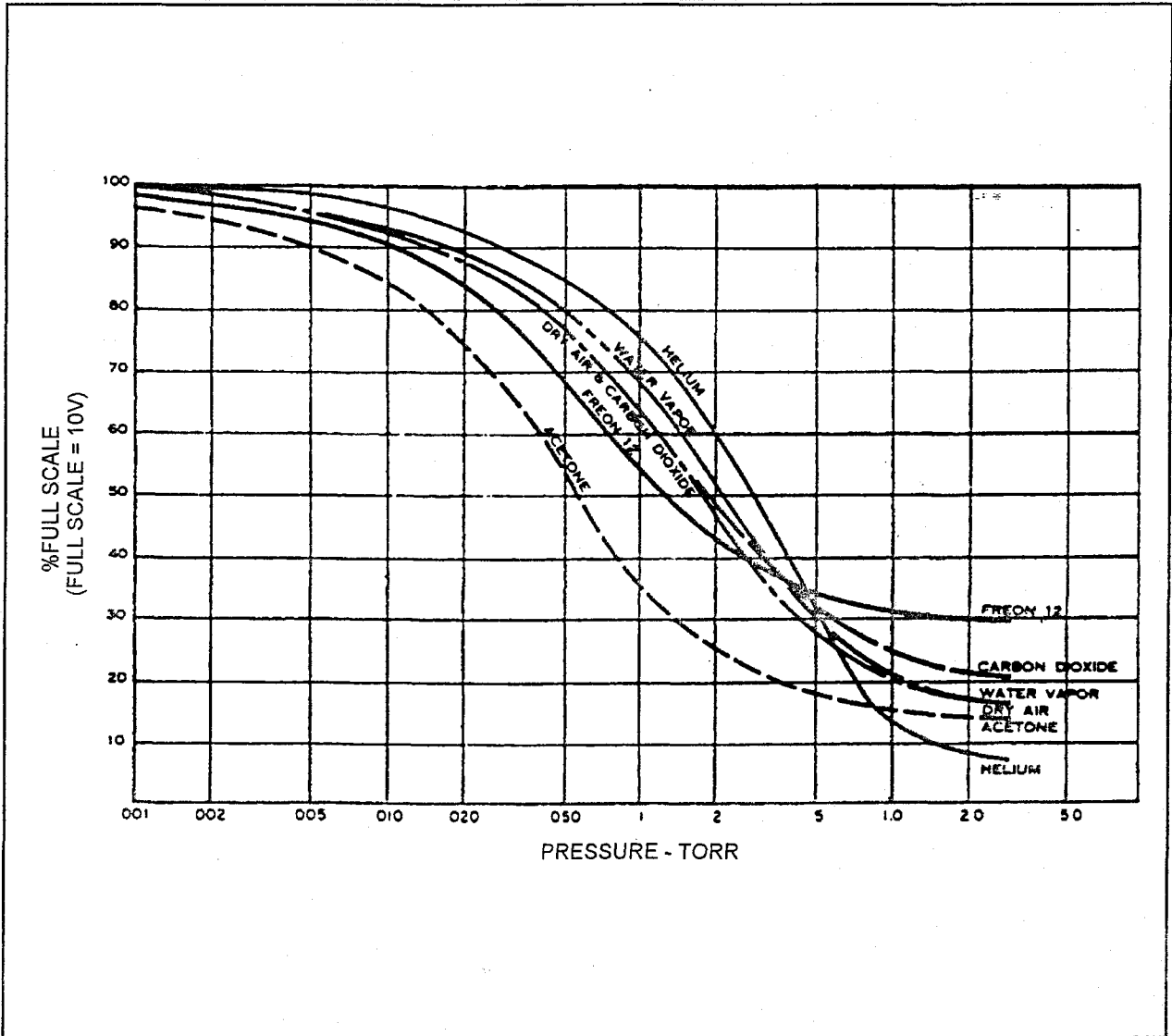

Response vs pressure curves

MULTI GAUGE CARDS INSTALLATION



**WARNING**

Before servicing the unit, check that the line cord is not plugged into a power source.



**CAUTION**

The MultiGauge Cards can be installed into the base unit only if the software revision level is 3.7 or higher.

Before install the cards make sure that the software revision level is correct.

**Software revision check**

To check the current software revision operate as follows:

- 1) Turn the MultiVac controller to OFF (rear panel)
- 2) Unplug the MultiVac controller, remove the cover and be sure that the ON/OFF rocker switch on front panel is in OFF position.
- 3) On microprocessor board put the dip switch number 8 to ON.
- 4) Install cover, plug the power cord and switch on (rear panel) the MultiVac controller. The front panel display will show:

D	E	B	U	G		O	P	E	R	A	T	I	O	N	.
---	---	---	---	---	--	---	---	---	---	---	---	---	---	---	---

for about 5 seconds, and then changes automatically to:

			M	A	I	N		M	E	N	U				
			V	I	E	W									

Press the push button FIELD to select

			M	A	I	N		M	E	N	U				
			M	O	D	E									

then press ENTER. The display shows:

P	R	E	S	S	U	R	E		U	N	I	T	:		
			X	X	X	X									*

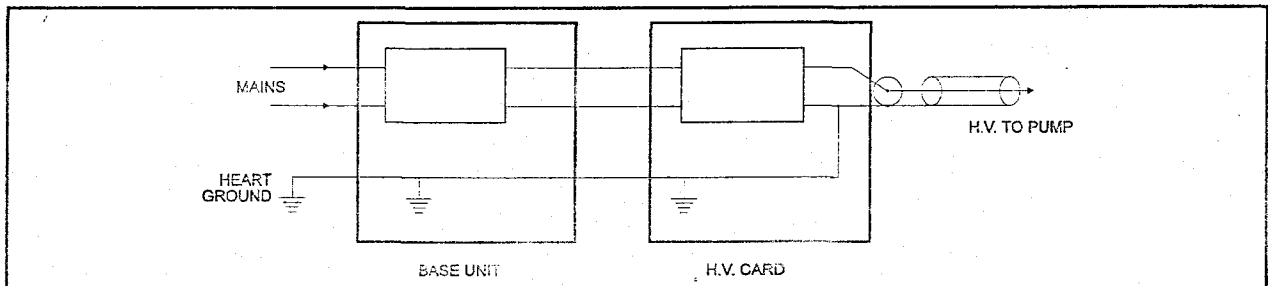

Ground connections

where XXXX may be TORR or mBAR and \* define the selection made.

Press ENTER once again. The display shows:

V	E	R	S	I	O	N	:								
#	X	.	X					d	d	/	m	m	/	y	y

where X.X shows the current software revision (two digits with a decimal point between them; dd/mm/yy indicates the software revision date: day/month/year).

If the software revision level is not correct call the Varian Service.

**Card installation procedure**

1. Open the MultiVac base cover.
2. Install the gauge controller card in one of the two slots at the right side of the unit (channel 3 and 4).
3. Replace the cover.
4. Make all the external connections (Gauge head cable, recorder output connection).

**PUMP CONNECTION**

The pump is connected to the controller rear panel via the Fischer connector of the H.V. card, by a coaxial high voltage cable assembly.



**WARNING**

High voltage can cause severe injury or death. When installing the high voltage cable:

- Turn the power off.
  - On the Pump feedthrough make sure that the ground spring is in place.
  - Install the pump connector and secure it with the screws (for 929-0770 cable).
  - Plug the controller connector.
- When removing the connector make sure that power is off.

**RECORDER OUTPUT CONNECTION**

An external analog recorder can be connected to the recorder output connector J1 pin 3 (ground) and pin 1 (positive) taking care that the minimum recorder input impedance should be 1 MΩ.

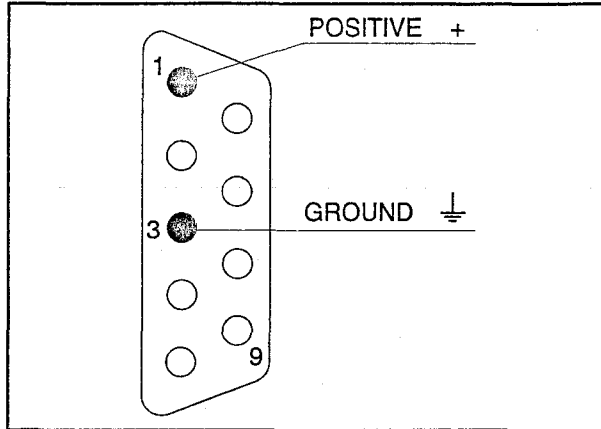

Recorder output connection

**USE**

**Operating Mode Selection**

**NOTE**

The unit is factory set for:

- LOCAL mode operation if the computer interface is not installed
- REMOTE mode operation if the computer interface is installed
- RUN/SET key in RUN position
- Operating mode: START, STEP VOLTAGE

To modify the pressure measurement unit and the operating mode procede as follows.

**NOTE**

Before switching on power be sure that the Stand by ON/OFF switch on the front panel is in OFF position

The following procedure is valid when both the Remote I/O and the RS232-422 cards are installed and enabled by the dip-switch number 3. If one of the two cards is not installed, the relevant pages will not appear on the display.

On rear panel, switch on the power, and on front panel put the RUN/SET key switch to SET. The display shows:

			M	A	I	N		M	E	N	U			
						V	I	E	W					

Press **FIELD** to select on the display:

			M	A	I	N		M	E	N	U			
						M	O	D	E					

Press **ENTER**.

If the RS 232-422 card is installed and enabled, the display shows directly the operating mode selection message, otherwise the display shows the pressure unit selection previously done: e.g.

P	R	E	S	S	U	R	E		U	N	I	T	:	
					T	o	r	r						*

where \* always indicates the previous selection. To change the pressure units press **FIELD**, and the display shows:

P	R	E	S	S	U	R	E		U	N	I	T	:	
					m	b	a	r						

To select this pressure unit press **ENTER**. After **ENTER** is pressed the display shows the page where the operating mode can be selected:

O	P	E	R	A	T	I	O	N		M	O	D	E	:
					L	O	C	A	L					*

Press **FIELD** and the display shows:

O	P	E	R	A	T	I	O	N		M	O	D	E	:
					R	E	M	O	T	E		I	/	O

Press **FIELD** and the display shows:

O	P	E	R	A	T	I	O	N		M	O	D	E	:
					R	E	M	O	T	E		C	O	M

Press **ENTER** when the operating mode you want is displayed and this mode will be selected.

**NOTE**

If the selected operating mode is LOCAL, the "Loc" LED on the front panel will be ON. If the selected operating mode is REMOTE I/O or REMOTE COMMUNICATION, the "Rem" LED on the front panel will be ON.

It is always possible to change the operating mode by the front panel following the procedure described above.

To change the operating condition from STEP VOLTAGE to FIXED VOLTAGE set the RUN/SET key in SET position and follow the flow chart of Flow 1, Flow 2 or Flow 3. At the end of the operation turn the RUN/SET key in RUN position.

Using the MultiVac Controller with RUN/SET Key in RUN Position

Verifying the pump type

Make all vacuum manifold and electrical connections and refer to the Ion Pump instruction manual prior to operate the MultiVac controller. Plug the controller power cable into a suitable power source. At the first installation must be verified that the MultiVac controller is correctly set for the desired pump type and mode of operation.

To verify the pump type switch on the controller on the rear panel. The display shows e.g.:

1	#	2	0	S	t	a	r	C	e	l	l		

if only one H.V. card is installed. If the pump is not of the desired type, it must be selected according to the flow chart of the following figure.

If two H.V. cards are installed it will show:

1	#	2	0	S	t	a	r	C	e	l	l		
2	#	2	5	D	i	o	d	e	/	N	D		

To switch from START to PROTECT mode of operation, press the START/PROTECT pushbutton of the MultiVac front panel. When the PROTECT mode of operation is selected for a pump, the corresponding "Prot" LED lights.

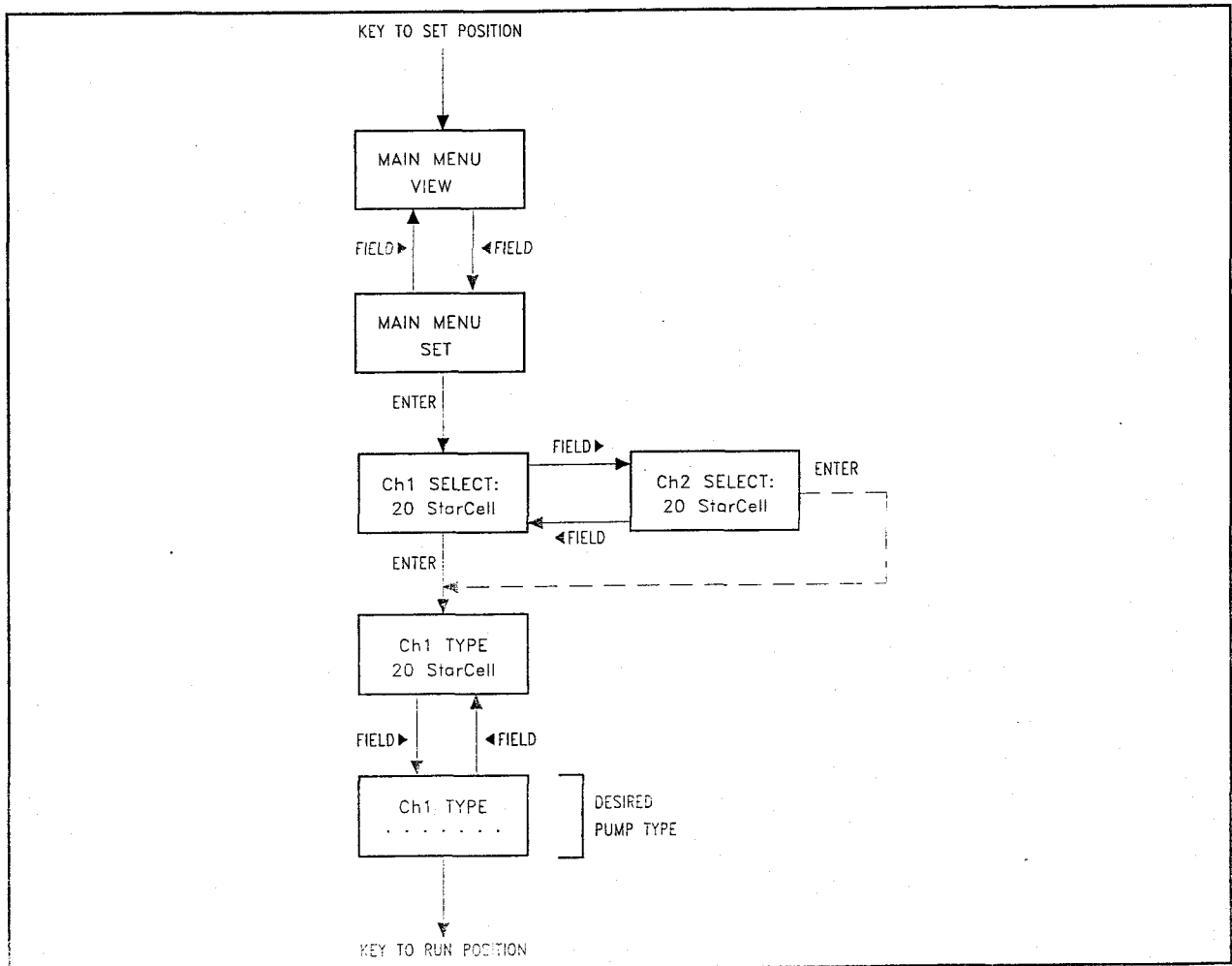

Pump type selection

**Using the MultiVac Controller with RUN/SET Key in SET Position**

Controller start-up and pump type selection  
For different controller configurations follow the related flow charts according to the following table to select the desired pump type and operating mode:

Controller configuration	Figure
H.V. card installed	Flow 1
H.V. card and Set Point/Remote Control card installed	Flow 2
H.V. card, RS232-422 Computer Interface card installed and enabled	Flow 3
H.V. card and Bayard Alpert or UHV MultiGauge card installed	Flow 4
H.V. card and Cold Cathode MultiGauge card installed	Flow 5
H.V. card and Thermocouple MultiGauge card installed	Flow 6

**NOTE**

*The asterisk close to a value or other messages in the display indicates the actually selected value.*

To change the displayed pump type when you are in the corresponding display page, you must press the **FIELD** pushbuttons until the desired pump is displayed, and then press **ENTER** to select and make it the actual pump type.

Note that for the Large Vaclon Plus H.V. card the displayed pump types are 16, while for a Medium Vaclon Plus H.V. card the pump types are 6 (see tables in paras. Large Vaclon Plus H.V. card specifications and Medium Vaclon Plus H.V. card specifications).

**Spare Pump Parameters**

To operate the controller with a pump listed in para. Large Vaclon Plus H.V. card specifications as "SPARE" you must set the pump parameters. Follow flow chart of Flow 7 figure to select and store the pump parameter when the OPERATION MODE is LOCAL or REMOTE I/O.

Use the front panel pushbuttons + and - to increase and decrease the values and the pushbuttons **FIELD** to change between negative and positive values.

The default values and the adjustable range of SPARE pump parameter is listed in the following table.

Parameter	Default values	Adjustable range
V max =	- 3000	± 3000 V to ± 7000 V
I max =	10	10 to 400 mA
P max =	10	10 to 400 W
If the PROTECT mode is selected:		
I protect =	10 mA	10 to 400 mA
If the STEP voltage is selected:		
V step 1 =	- 3000	± 3000 V to ± V max
I step 1 =	$6.5 \times 10^{-5} A$	$1 \times 10^{-7} A$ to 1 A
V step 2 =	- 3000	± 3000 V to V step 1
I step 2 =	$1.9 \times 10^{-6} A$	$1 \times 10^{-5} A$ to I step 1 setting

The operating mode is factory set to START and STEP V.



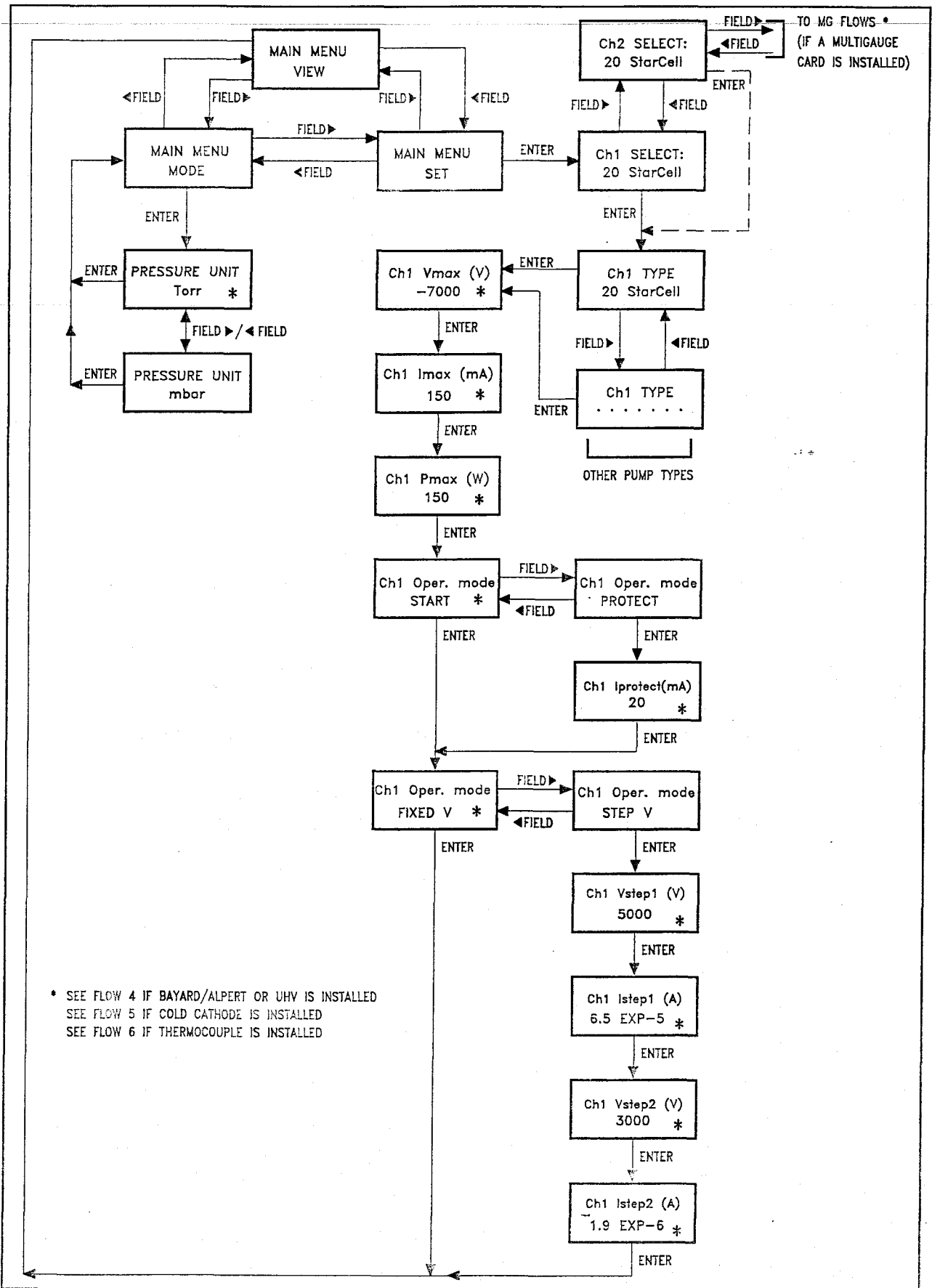

Flow 1 - MultiVac start-up: only H.V. card installed

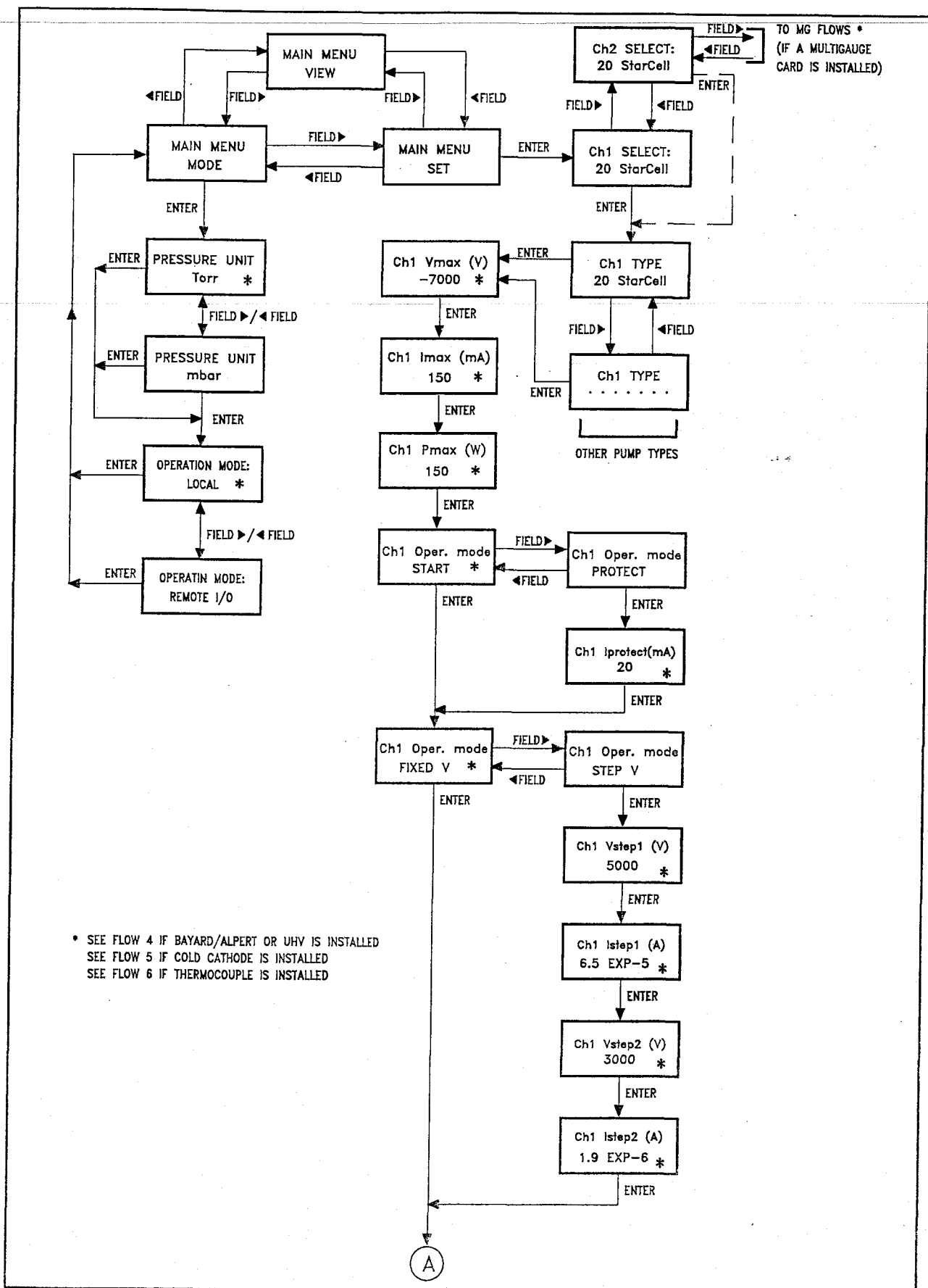

Flow 2 - MultiVac start-up: H.V. card and Set Point/Remote Control card installed (Sheet 1 of 2)

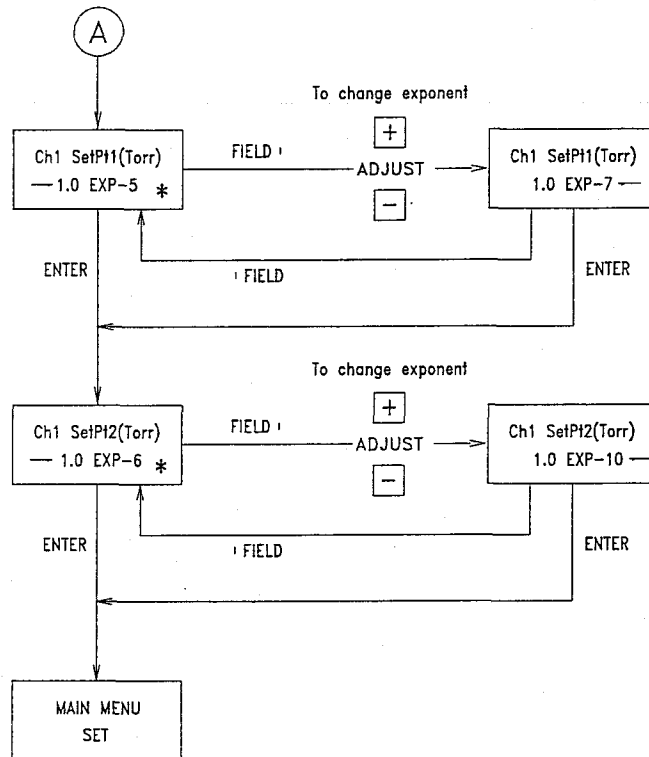

Flow 2 - MultiVac start-up: H.V. card and Set Point/Remote Control card installed (Sheet 2 of 2)

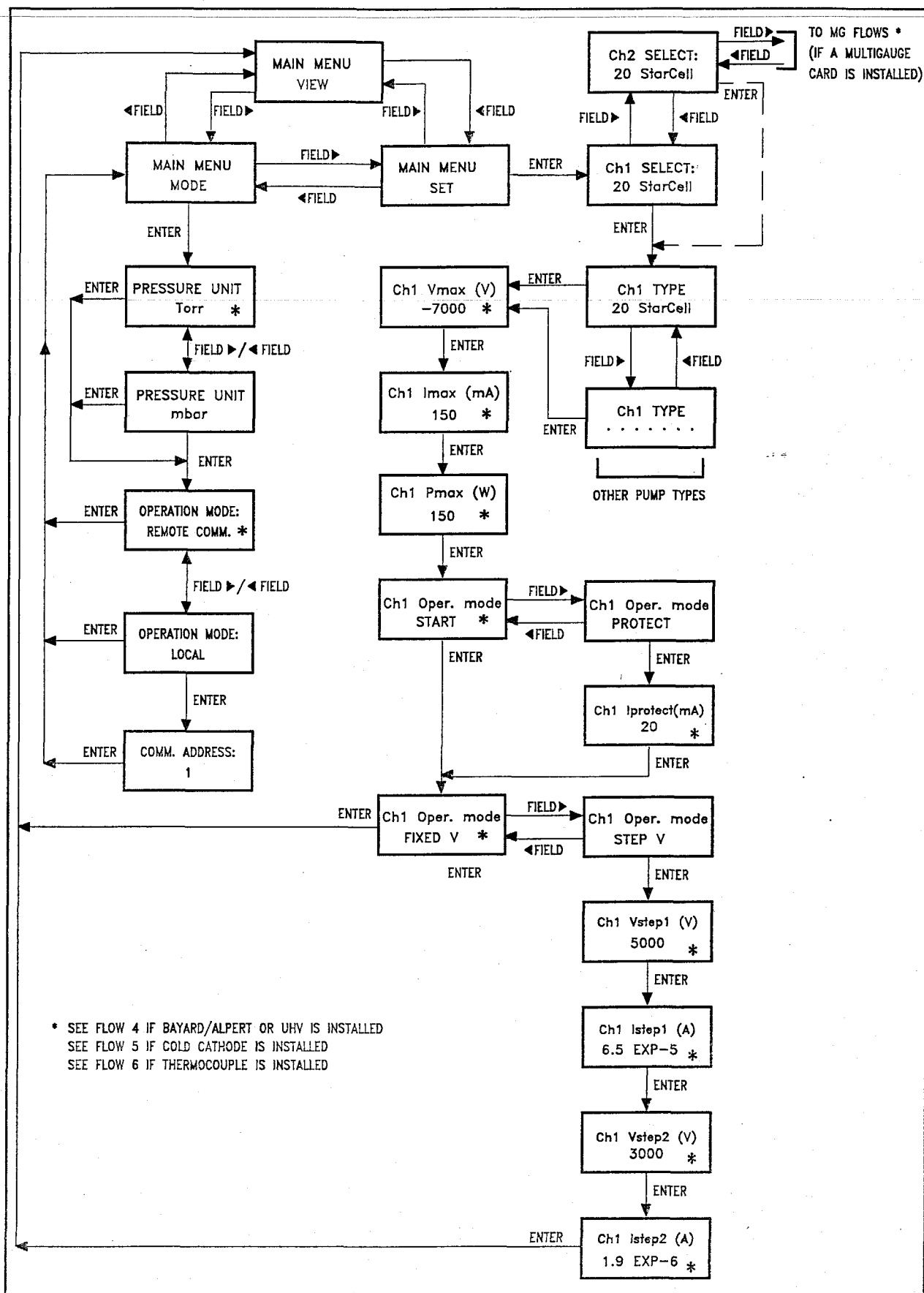

Flow 3 - MultiVac start-up: H.V. card and RS232-422 Computer Interface card installed

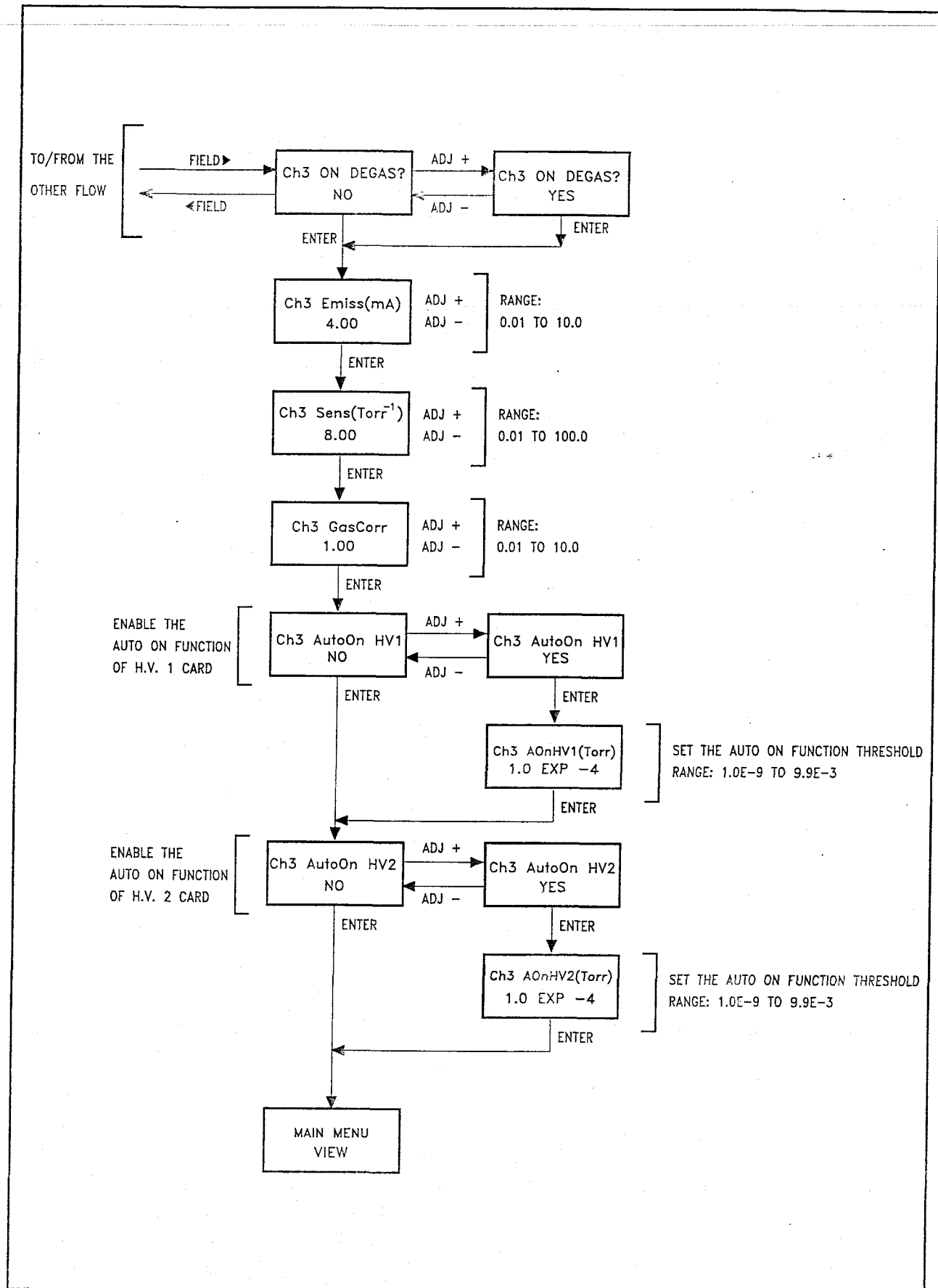

Flow 4 - MultiVac start-up: H.V. card and Bayard/Alpert or UHV MultiGauge card installed

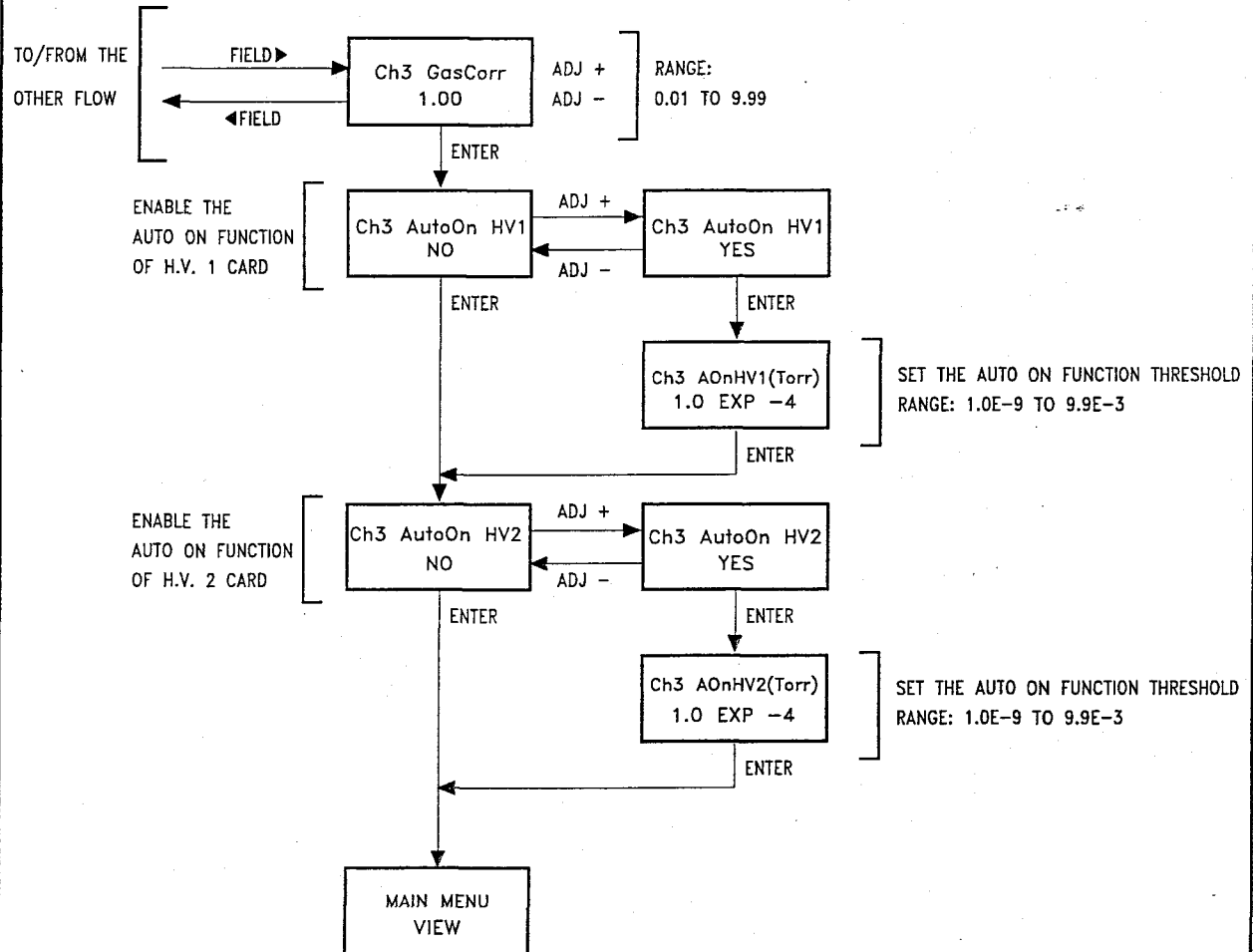

Flow 5 - MultiVac start-up: H.V. card and Cold Cathode MultiGauge card installed

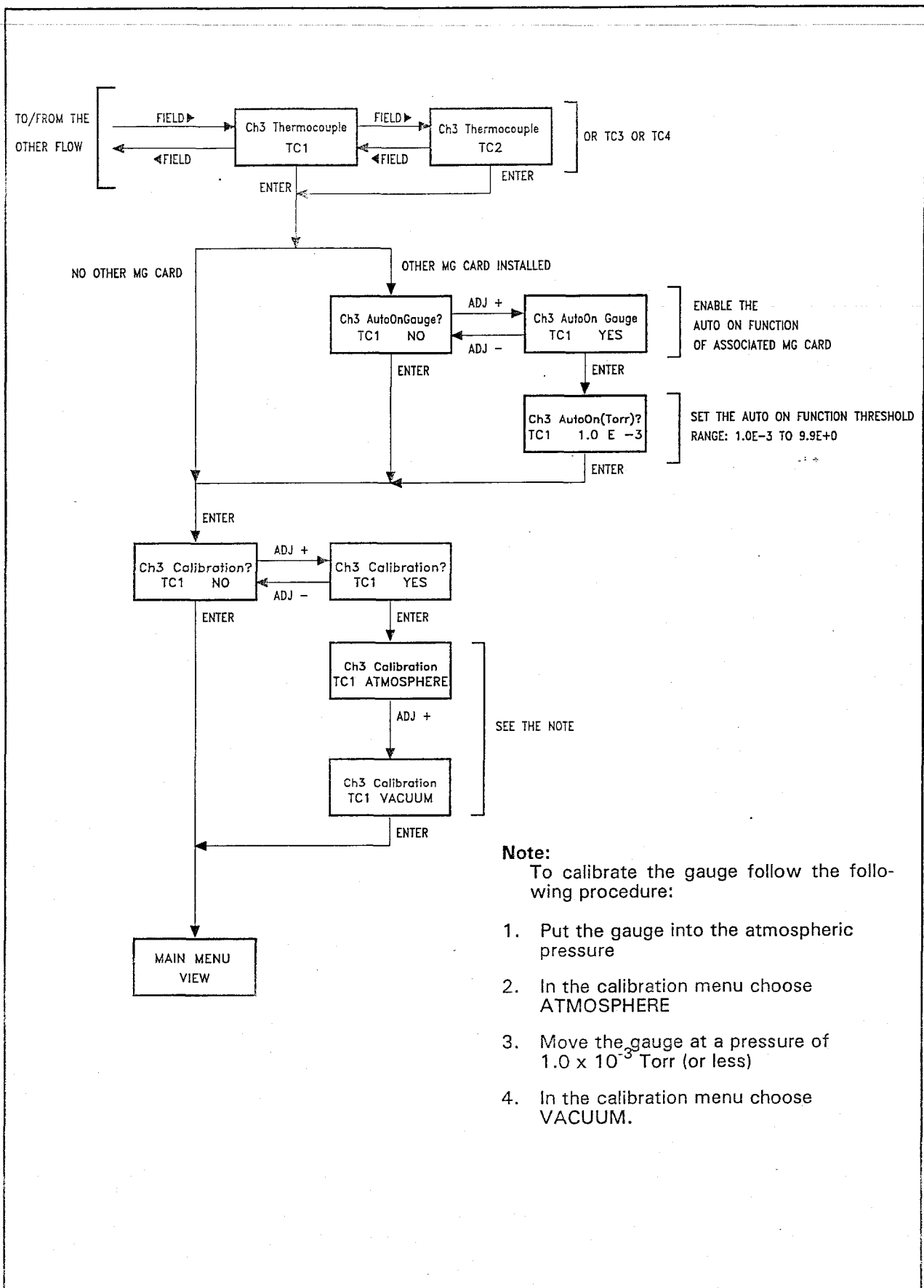

Flow 6 - MultiVac start-up: H.V. card and Thermocouple MultiGauge card installed

**Note 1:**

When this page is displayed the operator should store the pressure value corresponding to the pump current of 100 nA with 5000 V applied on the pump in use.

Store the pressure value for other three pump current values (10  $\mu$ A, 10 mA, 400 mA).

Storing these values allows the MultiVac to convert the pump current into pressure values even if the operating voltage is different from 5000 V.

The correction factor due to the different voltage is automatically applied by the MultiVac software in order to obtain a continuous correct pressure reading.

Note that some pressure values are stored by default.

ONLY WHEN THE SET POINT/REMOTE CONTROL CARD IS PRESENT

SEE NOTE ①

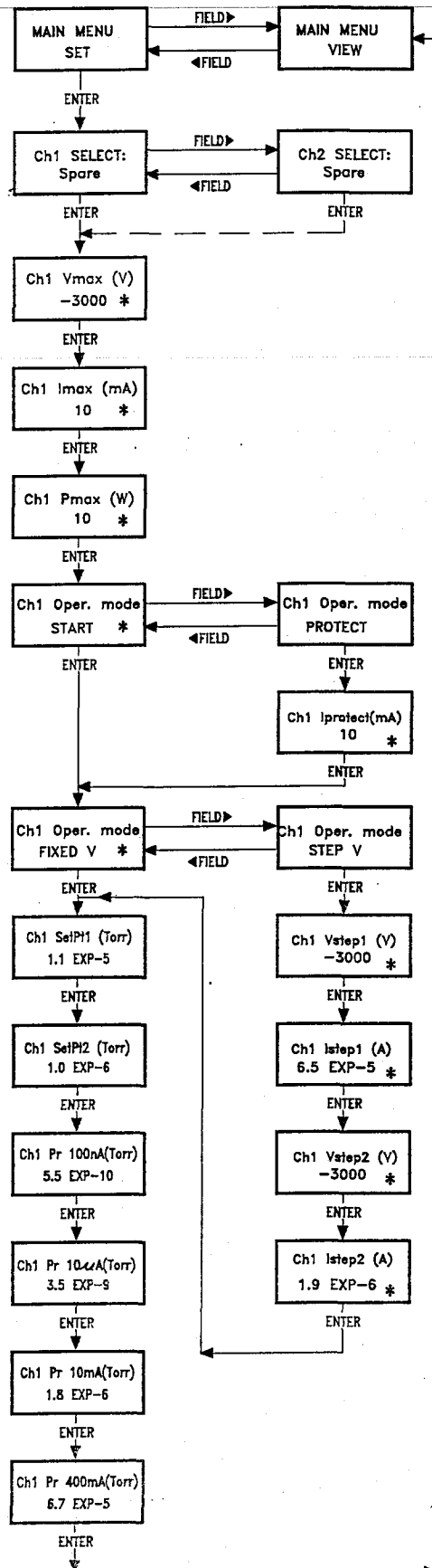

Flow 7 - Spare pump parameters setting



**H. V. Card Switching ON**

To switch on the H.V. card you must set the front panel rocker switch to ON position, switch ON the controller and then follow the steps detailed in the flow chart of Flow 8 figure.

Note that when the H.V. is switched on, the fans can start running faster as detailed in the related paragraph.

**Degas Function**

The DEGAS function can be enabled for the Bayard/Alpert and the UHV MultiGauge Cards.

The DEGAS function can be enabled setting to YES the YES/NO parameter shown on the display when the message "Ch3 ON DEGAS?" of the Menu SET is displayed.

To enable the function the Card must be activated (EMIS\_ON), and the pressure must be less or equal to  $10^{-5}$  Torr.

The DEGAS function is automatically disabled after a preset time from the enabling (60 minutes for the Bayard/Alpert Card, or 10 minutes for the UHV Card), or when the card is disactivated.

**Auto On Function**

The two H.V. cards can be automatically switched ON when a Bayard/Alpert or a UHV or a Cold Cathode Card is installed.

The Auto On function can be enabled setting to YES the YES/NO parameter shown on the display when the message "Ch3 AutoOn HV1 (or HV2)" of the Menu SET is displayed.

To enable the function the gauge must be in OFF state and the Auto On function of the second MultiGauge Card (if installed) must be disabled.

The function is active for once H.V. card switching on only.

When the Auto On function is enabled, the switching on pressure threshold must be set (the message displayed is "Ch3 AQnHV1(Torr)"). The threshold range is from  $1 \times 10^{-9}$  to  $9.9 \times 10^{-3}$  Torr; the default value is  $1 \times 10^{-4}$  Torr.

The Auto On function of the Thermocouple card, when enabled, activates the Auto On function of the associated MultiGauge Card.

In this case the pressure threshold range is from  $1 \times 10^{-3}$  to 9.9 Torr.

**Thermocouple Calibration Function**

When a Thermocouple Card is installed the associated Gauge can be calibrated by means of the Calibration function.

The Calibration function can be enabled setting to YES the YES/NO parameter shown on the display when the message "Ch3 Calibration" of the Menu SET is displayed.

To activate the calibration function the selected thermocouple must be in ON state.

When the Calibration function is activated, the thermocouple must be put into the atmospheric pressure when the display shows the message:

C	h	3		C	a	l	i	b	r	a	t	i	o	n	
T	C	2		A	T	M	O	S	P	H	E	R	E		

and the ENTER key must be pressed to store the first calibration value.

Then the thermocouple must be put into a pressure of  $1 \times 10^{-3}$  Torr (or less) and the value VACUUM (instead of ATMOSPHERE) must be set in the preceding message. Then the ENTER key must be pressed to store the second calibration value.

**Pumps Operating Parameters Reading**

The last three blocks of flow chart in Flow 8 figure are the pump operating parameters reading.

In these pages you can read the pump current, voltage and pressure actual values.

The read-out is typically of the following type:

C	h	1		V	o	l	t	a	g	e		(	V	)	
				-	3	0	0	0							

C	h	1		C	u	r	r	e	n	t		(	A	)		
				0	.	0		E	X	P		-	8	=	=	=

C	h	1		P	r	e	s	s		(	T	o	r	r	)	
				L	O	W		P	R	E	S	S	U	R	E	

Close to the read-out value, one of the symbols described in the following table can appear.

Symbol	Description
+ >	The value is increasing at a slow rate
+ >>	The value is increasing at a medium rate
+ >>>	The value is increasing at a fast rate
< -	The value is decreasing at a slow rate
<< -	The value is decreasing at a medium rate
<<< -	The value is decreasing at a fast rate
= =	The value is stable

**NOTE**

Should the current value be very low (i.e.  $< 1 \times 10^{-7} A$ ), the pressure value is not read and appear the message "LOW PRESSURE".

**Emergency Switch Off of the Two Pumps**

To switch off both the pumps at the same time, you can turn the front panel rocker switch to the OFF position.

In this case the HV Led flashes.

If you try to switch on the pumps, the message

S	T	A	N	D	B	Y	/	I	N	T	L	K		
S	E	E		M	A	N	U	A	L					

is displayed. In this case it is necessary to press **ENTER** and then the High Voltage can be switched on.

**Switch Off of One Pump**

To switch off one pump, you must follow the flow chart of Flow 9 figure when you are in one of the pump parameter reading pages.

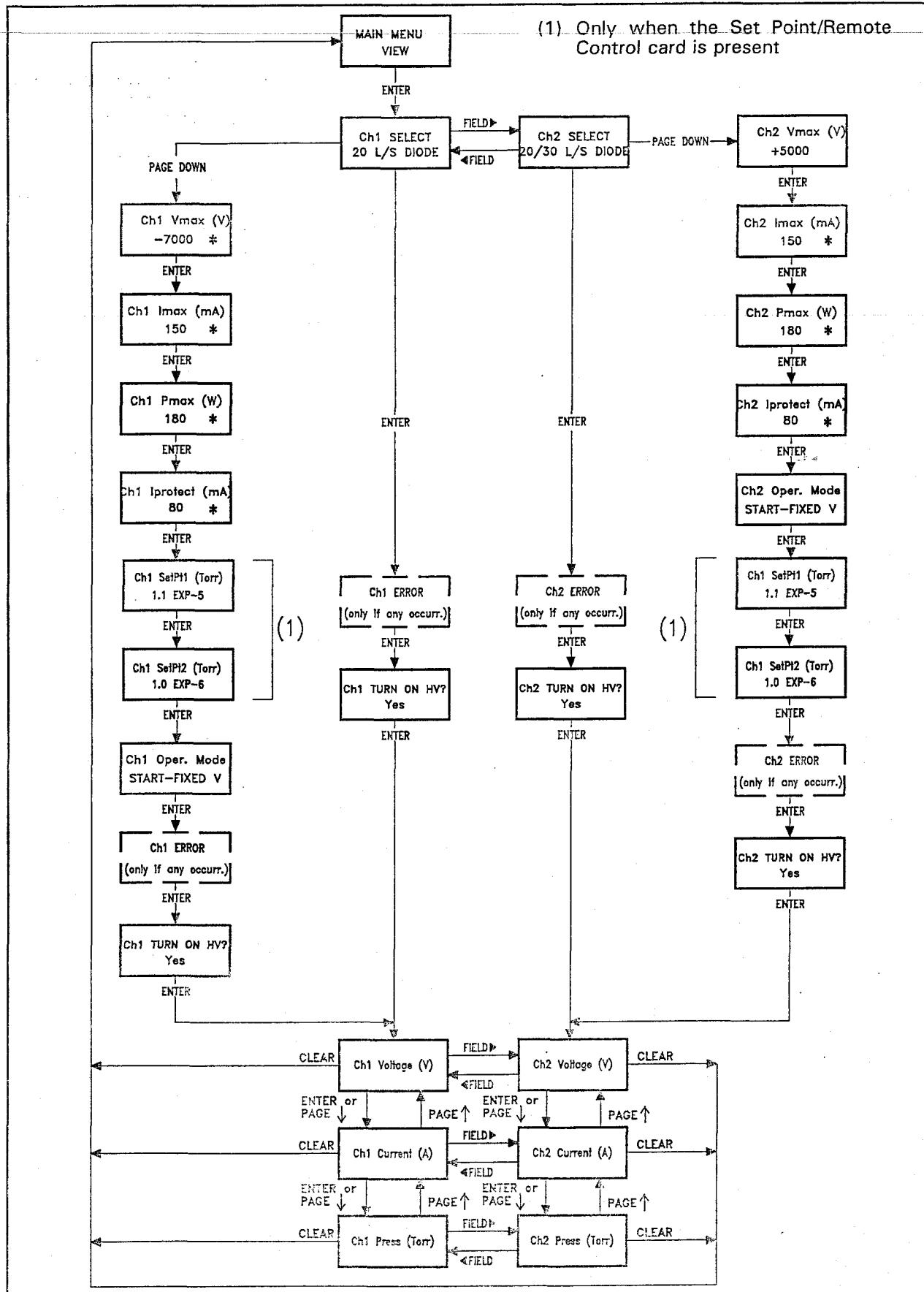

Flow 8 - H.V. card switching on procedure:  
RUN/SET key in SET position

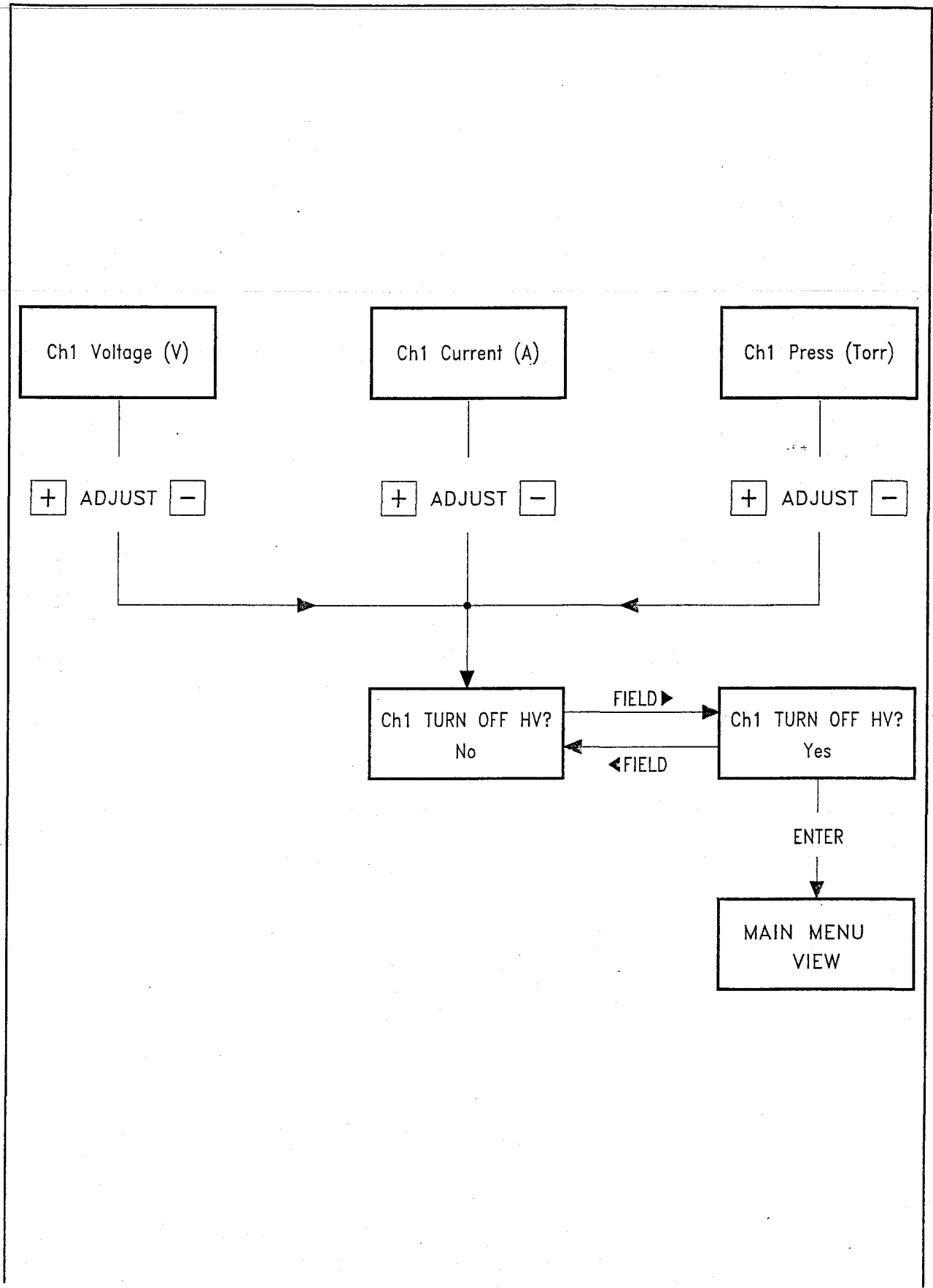

Flow 9 - H.V. card switching off procedure

CONTROLLER PARTS

The MultiVac Controller parts are listed in the following table.

Part Number	Description
<b>HV Cards</b>	
929-4025	Medium Vaclon Pumps HV Card, negative output preset (for Vaclon <i>Plus</i> pumps up to 75)
929-4035	Medium Vaclon Pumps HV Card, positive output preset (for Vaclon <i>Plus</i> pumps up to 75)
929-4040	Large Vaclon Pumps HV Card, negative output preset (for Vaclon <i>Plus</i> pumps up to 500)
929-4050	Large Vaclon Pumps HV Card, positive output preset (for Vaclon <i>Plus</i> pumps up to 500)
<b>Options</b>	
929-4100	RS 232-422 Computer Interface card
929-4110	Set Point/Remote Control card
929-0064	Rack adapter
<b>Cables</b>	
929-0770	HV bakeable cable, 4 m long to be used with all Vaclon <i>Plus</i> pumps except the Vaclon <i>Plus</i> 25.
929-0780	HV bakeable cable, 4 m long to be used with Vaclon <i>Plus</i> 25.



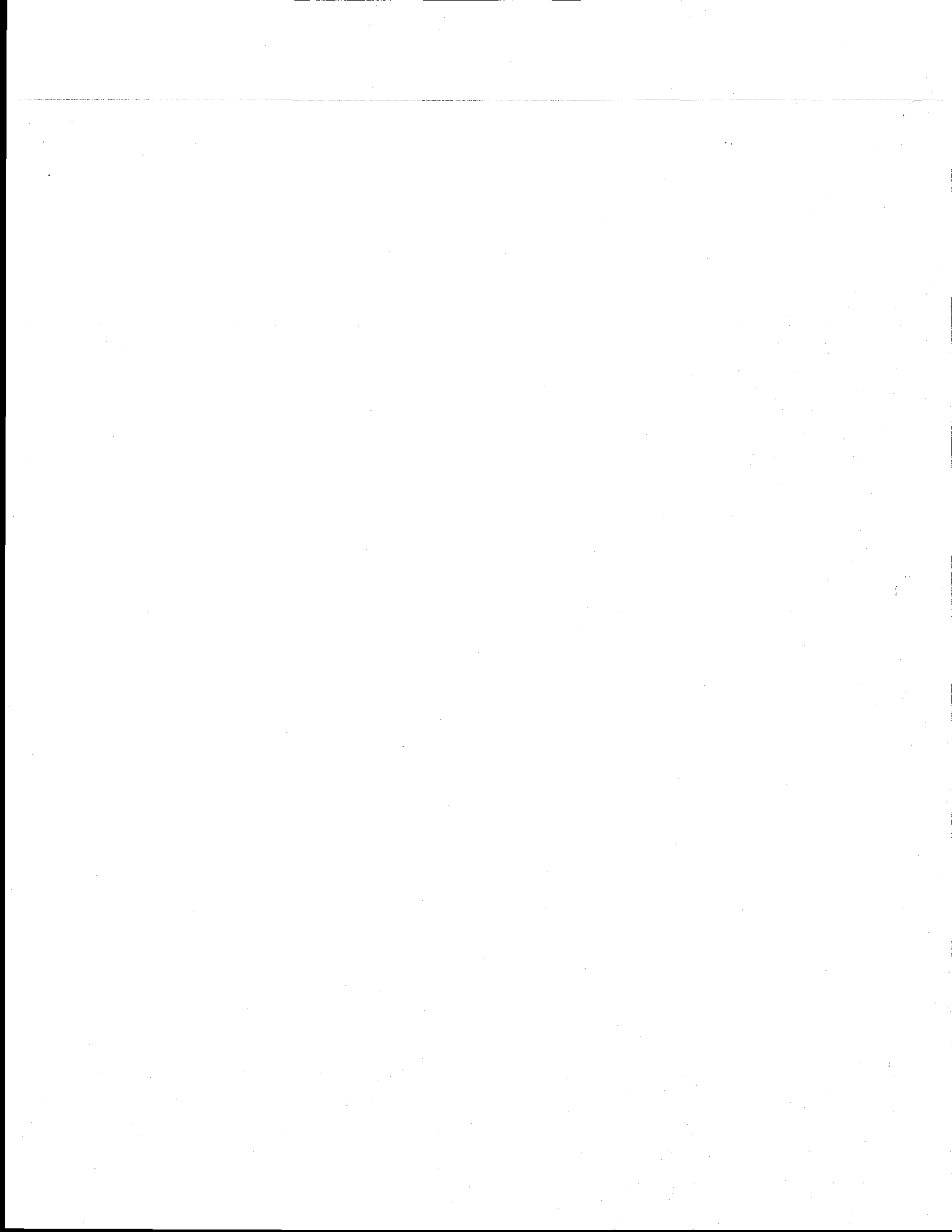

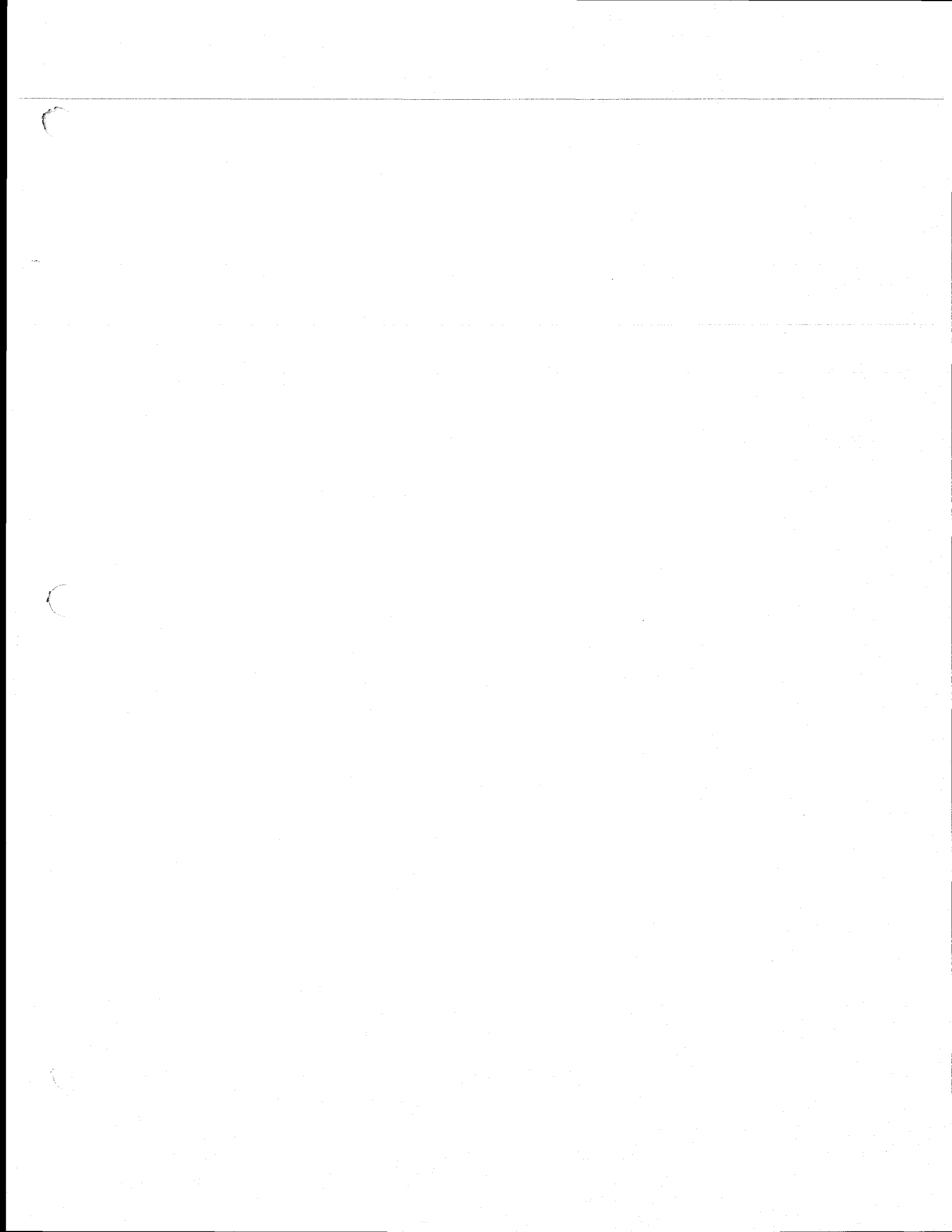



**Varian S.p.A. - Vacuum Products Torino**  
**Via Varian 54**  
**10040 Leini (Torino) - Italy**

**Varian Vacuum Products Lexington**  
**121 Hartwell Avenue**  
**Lexington, Massachusetts 02173 - USA**

**FRANCE**

Varian s.a.  
7, Avenue des Tropiques  
Z.A. de Courtaboeuf B.P.12  
F91941 Les Ulis Cedex - France  
Telephone: (33) 1 69863884  
Fax: (33) 1 69282308

**INDIA**

Varian International AG  
605-606, Vishwadeep. Towers, 4  
District Centre, Janakpuri,  
New Delhi - 110058 - India  
Telephone: (011) 5611442  
Fax: (011) 5524317

**USA, SOUTH & CENTRAL AMERICA**

Varian Vacuum Products  
121 Hartwell Avenue  
Lexington, MA 02173 - USA  
Telephone: (617) 8617200  
Fax: (617) 8605437  
Toll free: 1 800 8827426

**GERMANY, AUSTRIA**

Varian GmbH - Vacuum Products  
Alsfelder Strasse 6  
Postfach 11 14 35  
64289 Darmstadt - Germany  
Telephone: (49) 6151703353  
Fax: (49) 6151703302

**KOREA**

Varian Korea Ltd.  
433-1 Mogok-Dong  
Pyungtaek, Kyungki-Do - Korea  
Telephone: (82) 333 6107227  
Fax: (82) 333 6650115

**CANADA**

Varian Canada Inc.  
6705 Millcreek Drive, Unit 5  
Mississauga, Ontario L5N 5R9  
Canada  
Telephone: (905) 8198188  
Fax: (905) 8198348  
Toll free: 1 800 6632727

**GREAT BRITAIN**

Varian Ltd.  
28 Manor Road  
Walton on Thames  
Surrey KT12 2QF - Great Britain  
Telephone: (44) 1932 898000  
Fax: (44) 1932 228769

**JAPAN**

Varian Japan Ltd.  
Sumitomo Shibaura Bldg.  
4-16-36 Shibaura Minato ku  
Tokyo 108 - Japan  
Telephone: (81) 352321211  
Fax: (81) 352321263

**AUSTRALIA**

Varian Australia Pty Ltd.  
6/81 Frenchs Forest Road  
Frenchs Forest NSW 2086  
Australia  
Telephone: (61) 924519133  
Fax: (61) 924522600

**ITALY**

Varian S.p.A. - VP Sales Office  
Via Varian 54  
10040 Leini (Torino) - Italy  
Telephone: (39) 11 9979111  
Fax: (39) 11 9979344

**ASIAN COUNTRIES**

Varian Pacific Inc.  
Rm. 1018-20 Tower A  
New Mandarin Plaza  
14 Science Museum Road  
Tsimshatsui East, Kowloon  
Hong Kong  
Telephone: (852) 27242836  
Fax: (852) 23694280

**OTHER COUNTRIES**

Varian S.p.A. - VP Sales office  
Via Varian 54  
10040 Leini (Torino) - Italy  
Telephone: (39) 11 9979111  
Fax: (39) 11 9979344