

LASER INTERFEROMETER GRAVITATIONAL WAVE OBSERVATORY

- LIGO -

CALIFORNIA INSTITUTE OF TECHNOLOGY
MASSACHUSETTS INSTITUTE OF TECHNOLOGY

Technical Note LIGO-E990230-01 - L 5/27/99

SPECIFICATION
for ELECTRICAL CONTRACTOR SERVICES
for the BEAM TUBE BAKEOUT
at the LIGO LIVINGSTON OBSERVATORY

W. Althouse

Release A DCN: E990xxx-00-L

California Institute of Technology
LIGO Project - MS 51-33
Pasadena CA 91125
Phone (818) 395-2129
Fax (818) 304-9834
E-mail: info@ligo.caltech.edu

Massachusetts Institute of Technology
LIGO Project - MS 20B-145
Cambridge, MA 01239
Phone (617) 253-4824
Fax (617) 253-7014
E-mail: info@ligo.mit.edu

WWW: <http://www.ligo.caltech.edu/>

TABLE OF CONTENTS

1.	Purpose	3
2.	Applicable Documents	3
3.	Description	3
3.1.	Overview	3
3.2.	Location of work	4
3.3.	Site Conditions	4
3.4.	Work Plan and Schedule	5
3.5.	Description of Beam Tube Bakeout Temporary Power Equipment	5
3.5.1.	‘A1’ Power Assembly	5
3.5.2.	‘A2’ Power Assembly	5
3.5.3.	‘A3’ Power Assembly	6
3.5.4.	‘B2’ DC Power Supply Trailer Assembly	6
3.5.5.	‘E’ – 15 kV Transition Box Assembly	6
3.5.6.	‘D’ – DC Tube Connection Assembly	6
3.5.7.	DC Supply and Return Cables	7
4.	Requirements	7
4.1.	Statement of Work	7
4.2.	Materials	8
4.3.	Installation	8
4.3.1.	General Requirements	8
4.3.2.	A1/A3 Power Assembly Installation	8
4.3.3.	A2 Power Assembly Installation	9
4.3.4.	B2 DC Power Supply Trailer Installation	9
4.3.5.	DC Tube Connection Assembly Installation	9
4.3.6.	DC Supply and Return Cable Installation	10
4.3.7.	Beam Tube Grounding	11
5.	Clean Up	11
6.	Safety	11
Appendix A:	SITE LAYOUT AND MAP (not to scale)	12
Appendix B:	CONCEPTUAL SCHEMATICS	13
Appendix C:	SCHEDULE	14
Appendix D:	TASK SEQUENCE	16
Appendix E:	REFERENCE DOCUMENTATION	17

LIGO-DRAFT

1. PURPOSE

This document defines the requirements for installing, connecting and moving temporary AC and DC power equipment in support of the bakeout of beam tube modules at the Laser Interferometer Gravitational-Wave Observatory (LIGO) Livingston Observatory (LLO). The equipment provides DC power for heating the modules one at a time to 150 °C (300 °F), along with AC power for pumps, instrumentation and heating jackets.

2. APPLICABLE DOCUMENTS

Content	LIGO Drawing No.
Overall layout and equipment configuration: module X1	LIGO-D980094-C-W
X2	LIGO-D980095-C-W
Y1	LIGO-D980096-C-W
Y2	LIGO-D980097-C-W
Assembly 'A1' - 120/208 Volt 3 Phase Service Riser Diagram - Assembly 'A1'	LIGO-D980047-E-W
Assembly 'A2' - 120/208 Volt 3 Phase Service	LIGO-D980048-B-W
Assembly 'A3' - 120/208 Volt 3 Phase Service	LIGO-D980053-C-W
Riser Diagram - Assembly 'A3'	LIGO-D980059-E-W
Riser Diagram - Assembly 'B2'	LIGO-D980060-B-W
15 kV Transition Box - Assembly 'E'	LIGO-D980087-D-W
DC Tube Connection (Assembly 'D')	LIGO-D980072-A-W
Drawing List - Beam Tube Bakeout Electrical Equipment Assemblies	LIGO-D980077-C-W
	LIGO-E980094-01-W

3. DESCRIPTION

3.1. Overview

The LIGO beam tube modules are stainless steel tubes under vacuum, approximately 49 inches (1.2 m) in diameter by approximately 6,500 feet (2 km) long. There are four such modules at the LLO site. Each module consists of 50 sections of stainless steel tube with $\frac{1}{8}$ inch (3 mm) wall thickness, each approximately 130 feet (40 m) long, joined by stainless steel expansion joints (bellows) designed to accommodate the thermal expansion of the 40 m sections during a bakeout at 300 °F (150 °C). The tube sections are supported by structures designed to accommodate the thermal expansion and to minimize heat loss through the mechanical connections. The support structures are electrically insulated from the tube sections. The tube sections and expansion joints are welded together to form a continuous vacuum-tight tube. The ends of the 2 km long modules are terminated by large gate valves. There are seven 10 inch (25 cm) diameter pumping ports distributed at approximately 800 feet (250 m) intervals along the module. The beam tube is enclosed in a concrete protective cover with access doors at each pump port location and near the module ends. There are also smaller emergency access doors midway between the pump ports. A road

parallels the beam tube enclosure.

Each beam tube module is thermally insulated to reduce heat loss during the bakeout (the insulation also provides long-term thermal and acoustic insulation for the beam tube during LIGO operation). The beam tube is also electrically insulated from each of its supports. During bakeout, the beam tube is heated by passing DC current through the beam tube walls, using the electrical resistance of the wall material as the heating element. Approximately 1750 Amperes are required to heat the tube to 150 °C. The current is supplied by two DC power supplies located at the $1/4$ and $3/4$ points of the module, connected as illustrated in the conceptual schematics provided in Appendix B.

Power for vacuum pumps and instrumentation used to support the bakeout is provided by temporary installations of AC power transformer/distribution panel units at the seven pump ports between the module ends (Appendix B). Power for pumps and instrumentation at the module ends is furnished from temporary transformer/panel units which plug into existing 480 V outlets.

The equipment for the beam tube bakeout was designed, built and operated successfully at the LIGO Hanford Observatory (Hanford, WA) before being shipped for use at LLO.

3.2. Location of work

All work described in this specification shall be performed on site at the LIGO Livingston Observatory. See Appendix A for site layout and location map.

3.3. Site Conditions

Laydown area: Unenclosed space is available for parking contractor vehicles and storing materials and equipment during performance of this work. The contractor should coordinate needs with the LIGO staff, which will designate areas reserved for the contractor's use.

Electrical Service: No electrical service will be available along the beam tube until installation of power assemblies by the contractor. The contractor shall be responsible for providing any electrical service required for the work prior to assembly installation. It shall be the contractor's responsibility to arrange with LIGO access to the electrical equipment that may be available inside the corner, mid and end stations. Any modifications to the existing electrical service determined necessary by the Contractor shall be approved by LIGO. Upon completion of the contract, any modified electrical equipment shall be returned to a satisfactory state as required by LIGO.

Lighting: There is no permanent lighting inside the beam tube enclosure. The contractor shall be responsible for providing temporary lighting as needed to perform contractor's work.

Confined space: LIGO considers the beam tube enclosure to be a confined space. The contractor shall be responsible for furnishing adequate lighting and ventilation in the enclosed work areas and providing for other safety considerations as needed in the performance of the contractor's work.

Coordination of activities: The contractor is required to coordinate activities with other contractors on site and with LIGO staff. The contractor shall not block the roadways at any time.

All activities which may physically modify the facilities shall be coordinated with LIGO to prevent inadvertent damage or compromise in the function of the project.

3.4. Work Plan and Schedule

The beam tube bakeout will be conducted one module at a time. The work called for in this specifications involves the following:

1. Unpacking and initial set up of electrical equipment for the first bakeout
2. Assisting LIGO staff during a module bakeout
3. Coordination and moving of equipment between bakeouts
4. Partial disassembly and packaging for shipment to storage

The schedule for bakeout of the four modules at LLO is shown in Appendix C. There is only one set of DC supply and return cables, and their associated junction boxes, so their movement from one module to the next between bakeouts is time-critical. In contrast, there are two sets of AC power transformer/distribution panel assemblies and DC power supply assemblies, and two sets of DC tube connection assemblies, so there is more time available for moving these items between bakeouts. The sequence of equipment movement is illustrated schematically in Appendix D.

3.5. Description of Beam Tube Bakeout Temporary Power Equipment

3.5.1. 'A1' Power Assembly

The A1 power assembly is a complete, portable, weatherproof power source for up to 150 A of 120 V or 208 V 3 ϕ power, when connected to a 13.2 kV source. It is for temporary outdoor use at the port locations along the beam tube enclosures, where vaults to access the 13.2 kV primary power have been installed. The A1 assembly consists of a 45 kVA power transformer (13.2 kV primary), 120 V 1 ϕ /208 V 3 ϕ 225 A panel, and integrated weatherproof 120 V and 208 V outlets. The A1 power assembly is further described in specification E980023 and illustrated in drawing D980047, and the installed locations are shown in the equipment arrangement drawings, D980094, D980095, D980096, and D980097.

There are six free-standing A1 assemblies, which together with the four A1 assemblies mounted on the DC power supply trailers and the four A3 power assemblies, is sufficient quantity to furnish temporary power at two beam tube modules simultaneously.

3.5.2. 'A2' Power Assembly

The A2 power assembly is a complete, portable power source for up to 125 A of 120 V or 208 V 3 ϕ power, when connected to a 480 V source. It is for temporary indoor use at the corner and end stations, and midpoint enclosures along the beam tube. It plugs any of the standard 480 V outlets provided in these locations. The A2 assembly consists of a 45 kVA power transformer (480 V primary), 120 V 1 ϕ /208 V 3 ϕ 225 A panel, and integrated 120 V and 208 V outlets. The A2 power assembly is further described in specification E980024 and illustrated in drawing D980053.

There are four A2 power assemblies, sufficient to furnish temporary power at two beam tube modules simultaneously.

3.5.3. 'A3' Power Assembly

The A3 power assembly is identical to the A1 power assembly except that it includes a 50 A 208 V 2 ϕ outlet for the portable trailer housing the RGA controls and computer. The A3 power assembly is further described in specification E980025 and illustrated in drawing D980059, and the installed locations are shown in the equipment arrangement drawings, D980094, D980095, D980096, and D980097.

There are four A3 power assemblies, sufficient to furnish temporary power at two beam tube modules simultaneously.

3.5.4. 'B2' DC Power Supply Trailer Assembly

The B2 DC power supply trailer includes an A1 power assembly and a 100 V, 5000 A DC power supply housed inside a weatherproof enclosure, with supporting 500 kVA power transformer (13.2 kV primary) and water cooling heat exchanger unit, all mounted atop a 40' flatbed trailer. The DC power supply provides up to 450 kW of DC heating power to one half of a beam tube module. The B2 assembly is designed so that the trailer can be parked next to the beam tube enclosure, and temporary grounding and primary power connections are all that are needed to establish operation. Once DC supply and return cables are connected from the DC power supply shunt cabinet to the beam tube, the unit is ready for heating. The B2 DC power supply assembly is further described in specification E980026 and illustrated in drawings D980079 and D980087, and the installed locations are shown in the equipment arrangement drawings, D980094, D980095, D980096, and D980097.

There are four B2 DC power trailers, which can furnish AC and DC power at two modules simultaneously.

3.5.5. 'E' – 15 kV Transition Box Assembly

The E transition box is a purchased 15 kV fiberglass utility box which is temporarily staked to the ground to cover the loop of 13.2 kV primary wire leaving the vault conduit and entering the conduit to the beam tube enclosure. The installation is illustrated in drawing D980072.

There are 14 E transition boxes, enough to cover the high voltage wire loops at all A1/A3 and DC power trailer locations.

3.5.6. 'D' – DC Tube Connection Assembly

The DC tube connection assembly includes multiple clamp-on connectors which distribute the DC current around the tube and which accommodate the wide temperature range of the tube wall. The assembly includes 16 connectors (Assembly D-1) which clamp onto a designated stiffener ring on the beam tube, 16 high temperature #4/0 cables with high temperature lugs for the tube connector end, and a junction box (Assembly D-2) where the 16 high temperature cables and the supply or return cables from the DC power supplies are joined together. A 17th clamp-on connector connects the tube connection point to the tube voltage monitor inputs of the bakeout data acquisition system. The DC tube connection assembly is further described in specification E980028 and the installation is illustrated in drawing D980077. The installation locations (five connection points per module - see conceptual schematic in Appendix B) are identified in the equipment arrangement drawings, D980094, D980095, D980096, and D980097.

There are ten sets of D-1 connectors and high-temperature cables, enough to permit installation on two beam tube modules simultaneously. There are five D-2 junction boxes, enough to support one bakeout.

3.5.7. DC Supply and Return Cables

Current is delivered from the DC supplies to the tube connection assemblies through multiple parallel portable power cables (NEC Type W, 500 MCM). Eight parallel cables connect the positive terminal of each DC power supply to the tube, while four parallel cables provide the return paths from the tube to the negative terminal of each supply (see upper figure, Appendix B). Each cable is pre-designated for a particular location, identified in the equipment arrangement drawings, D980094, D980095, D980096, and D980097. The cables terminate in the shunt cabinet at the DC power supply ends, and in the D-2 junction boxes at the tube connection ends.

There is one set of DC supply and return cables.

4. REQUIREMENTS

4.1. Statement of Work

The contractor shall furnish all labor, materials, tools, and transportation and handling equipment needed to support the following activities (refer to Appendix D for an illustration and summary of these activities):

Equipment ID (qty)			
	A1/A3 assys (5) DC PS trailers (2) E transition boxes (7) DC tube connects (5x17)	A1/A3 assys (5) DC PS trailers (2) E transition boxes (7) DC tube connects (5x17)	DC supply cables, short (16) DC return cables, long (16) D-2 junction boxes (5)
Task	Activity		
1	Unpack and inspect		
2	Install at X2		Unreel and install at X2
3		Install at X1	
4			Move to X1
5	Move to Y1		
6			Move to Y1
7		Move to Y2	
8			Move to Y2
9	Deinstall and pack for storage		Return to reels

The contractor shall assist LIGO during start-up and operation of the beam tube bakeout equipment. For purposes of planning, the contractor should assume that such assistance will amount to 20 manhours of licensed electrician services per bakeout.

LIGO will furnish the above listed bakeout equipment, and a hydraulic cable reeling mechanism which can be mounted on the contractor's cable reel trailer. The LIGO outdoor forklifts on site may also be available from time to time. The contractor shall be responsible for furnishing tools and other transportation and handling equipment.

4.2. Materials

All non-consumable materials shall be supplied by LIGO except for materials required to ground the equipment. The contractor shall furnish all consumable materials and all materials necessary for proper grounding, including bonding jumpers and wire, grounding bushings, clamps, etc. The contractor may use existing ground rods if suitable, otherwise the contractor shall supply and install the ground rods.

4.3. Installation

4.3.1. General Requirements

All equipment and materials shall be installed in accordance with the best industry practices by skilled workers regularly engaged in this type of work.

All materials shall be installed in accordance with manufacturer's recommendations, applicable building codes and industry standards.

The contractor shall be responsible for obtaining any required permits and arranging any required inspections.

4.3.2. A1/A3 Power Assembly Installation

4.3.2.1 The contractor shall place the LIGO-furnished A1 or A3 transformer/panel assemblies next to the beam tube enclosure entry doors as shown on the configuration drawings D980094, D980095, D980096 and D980097. Locations for A1 and A3 assemblies are designated on the drawings. The transformer shall be leveled to within 1.5 degrees, as specified in section 7.1 of the manufacturer's instruction manual, which is furnished as LIGO-T980012-00-W.

4.3.2.2 The contractor shall connect the flexible watertight conduit and fittings as indicated on the riser diagram, D980048, between the transformer and the beam tube enclosure wall. The 15 kV conductors shall be installed by the serving utility, after the transformer has been properly grounded (next paragraph).

4.3.2.3 The contractor shall properly ground the transformer/panel assembly. Provide all materials, including bonding jumpers and wire, grounding bushings, clamps, etc. required for complete grounding. The contractor may use existing ground rods if suitable, otherwise the contractor shall supply and install the ground rods. Route conductors to provide the shortest and most direct path to grounding electrodes.

4.3.2.4 The contractor shall coordinate the primary connection with the serving utility.

4.3.2.5 After the primary connection has been established and verified (contractor shall check phase rotation at cryopump outlet), the contractor shall install the 'E' transition box covers over the free 15 kV conductor loops as indicated in drawing D980072.

4.3.3. A2 Power Assembly Installation

4.3.3.1 The contractor shall place the LIGO-furnished A2 transformer/panel assemblies at a location to be designated by LIGO, near the ends of the beam tube modules inside the corner/end stations and the midpoint enclosure, within reach of an existing 480 V outlet. Corner and end station areas are maintained as a clean room environment. Any activity that may produce dust or other contaminants such as drilling, grinding, sawing in the clean room environment shall be avoided. Unavoidable activities which could produce contaminants in the clean room environment shall be coordinated with LIGO and shall conform to the requirements and procedures established by LIGO for that activity.

4.3.3.2 The contractor shall properly ground the transformer/panel assemblies by bonding to the existing grounding grid points designated by LIGO. Contractor shall provide all bonding jumpers and wire, grounding bushings, clamps, etc. required for complete grounding. Route grounding conductors to provide the shortest and most direct path to the grounding electrode system.

4.3.3.3 The contractor shall plug the installed and grounded assembly into existing 480 Volt, 60 Ampere, 4 wire outlet. Location of existing outlets and source panel for each installation shall be coordinated with LIGO. Make and break all 480 Volt plug type connections cold with source breaker or disconnect in the "OFF" position.

4.3.3.4 The contractor shall verify phase rotation at cryopump outlet.

4.3.4. B2 DC Power Supply Trailer Installation

4.3.4.1 The contractor shall place a LIGO-furnished DC power supply trailer assembly next to the beam tube enclosure entry doors as shown on the configuration drawings D980094, D980095, D980096 and D980097. The contractor shall level the trailers to ensure that both transformers are leveled to within 1.5 degrees, as specified in section 7.1 of the manufacture's instruction manual, which is furnished as LIGO-T980012-00-W.

4.3.4.2 The contractor shall connect the flexible watertight conduit and fittings as indicated on the riser diagram, D980087, between the transformer and the beam tube enclosure wall. The 15 kV conductors shall be installed by the serving utility, after the transformer has been properly grounded (next paragraph).

4.3.4.3 The contractor shall properly ground the transformer/panel assembly. Provide all materials, including bonding jumpers and wire, grounding bushings, clamps, etc. required for complete grounding. The contractor may use existing ground rods if suitable, otherwise the contractor shall supply and install the ground rods. Route conductors to provide the shortest and most direct path to grounding electrodes.

4.3.4.4 The contractor shall coordinate the primary connection with the serving utility.

4.3.4.5 After the primary connection has been established and verified (contractor shall check phase rotation at cryopump outlet), the contractor shall install the 'E' transition box covers over the free 15 kV conductor loops as indicated in drawing D980072.

4.3.5. DC Tube Connection Assembly Installation

4.3.5.1 The contractor shall install 16 D-1 DC clamp-type connectors with integrated high-temperature #4/0 cables, distributed radially around the tube as illustrated in drawing D980077, at the

stiffener rings designated in the equipment arrangement drawings D980094, D980095, D980096, and D980097. A 17th D-1 connector with the high-temperature #12 AWG voltage monitor wire (which connects to the data acquisition system) shall be located near the 12 o'clock position, as illustrated in D980077. The clamping bolts shall be torqued to 40 ft. lbs.

4.3.5.2 There may be bakeout monitoring equipment, instruments, heater blankets, wiring, thermocouples, or beam tube insulation in the area of the cable connections. The contractor shall take care to prevent damage to this equipment during the connector and cable installation. If any of these items interferes with the contractor's work, the contract shall notify LIGO promptly so that the interfering condition can be cleared away.

4.3.5.3 The contractor shall use extreme care to prevent damage to the $\frac{1}{8}$ " thick stainless steel beam tube. The stainless steel is subject to long-term stress-induced corrosion due to chemical attack. No glues, adhesives or adhesive tape shall be applied to the tube wall without prior LIGO approval. The contractor shall take measures to ensure that activities inside the beam tube enclosure, particularly the use of any tools, shall not damage the beam tube wall. The use of power tools, flame torches or welding equipment inside the beam tube enclosure must be coordinated with and approved in advance by LIGO.

4.3.5.4 The contractor may elect to use the LIGO-furnish cable supports illustrated in drawing D980077 if the contractor so chooses.

4.3.6. DC Supply and Return Cable Installation

4.3.6.1 The contractor shall place the 500 MCM DC cables along the outside of the beam tube enclosure as shown in the equipment arrangement drawings D980094, D980095, D980096, and D980097. The cables shall be laid on the ground between the paved roadway and the enclosure. Where the cable pass in front of enclosure doors, the cable shall be laid so that it doesn't interfere with opening the doors, which serve as either primary or emergency exits.

4.3.6.2 Cables shall be handled with reasonable care to prevent excessive damage to the insulation or conductor. Cables shall not be dragged on the ground or pulled through their developed length as a means of installation.

4.3.6.3 Supply and return cables shall be terminated at the DC power supply shunt cabinets on the DC power supply trailers and at the D-2 junction boxes inside the enclosure. The #4/0 high-temperature cables from the DC tube connection assemblies shall also be terminated at the D-2 junction boxes. All $\frac{1}{2}$ " connection bolts shall be torqued to 40 ft. lbs. The cables shall penetrate the beam tube enclosure wall at the core holes designated for this purpose by LIGO.

4.3.6.4 Cable lengths have been carefully matched and trimmed to balance the bridge circuits formed by the cable and tube resistances, and to function in the longest locations. Excess cable shall be laid out on the ground outside the beam tube enclosure, spread out so that the cables don't become too hot from self-heating due to the current flow. Excess cable shall not occupy the roadway or block access to the bakeout equipment. Avoid coiling the cable under or near the RGA trailer, where the magnetic field is known to interfere with the instrumentation displays.

4.3.6.5 At the corner station connections, the DC return cables penetrate sheet metal panels which isolate the clean building environment from the beam tube enclosure. The contractor shall coordinate these penetrations with LIGO to ensure that the penetrations are open for minimal time to prevent contamination or critters from entering the clean area, and that the penetrations are suit-

ably packed with non-shedding material both to prevent damage to the cables and to prevent contamination from passing into the clean areas during the bakeout.

4.3.7. Beam Tube Grounding

4.3.7.1 The contractor shall disconnect existing ground connections at the tube at ports xx2, xx3, xx4, xx6, xx7, and xx8. The grounds shall be disconnected near the time the DC supply and return cables are laid out and connected to the tube. The existing grounding cables shall be tied back and protected from damage during the bakeout activities.

4.3.7.2 At the module ends and at port xx5, the grounding is retained but the connection at the tube must be replaced with LIGO-furnished high-temperature cable. The existing ground connections shall be broken at the tube end and a length of LIGO-furnished high-temperature cable shall be connected to the tube in the same location, and the free end bolted to the existing ground wire.

4.3.7.3 After the bake is completed, the original ground connections shall be restored.

5. CLEAN UP

The contractor shall remove all debris and scraps of material from the job site.

6. SAFETY

The contractor shall deliver a Safety Plan and safety procedures which the contractor shall comply with during the performance of this work. The contractor shall use the LIGO Lockout/Tagout procedure for all work performed on site.

LIGO-DRAFT

APPENDIX A: SITE LAYOUT AND MAP (NOT TO SCALE)

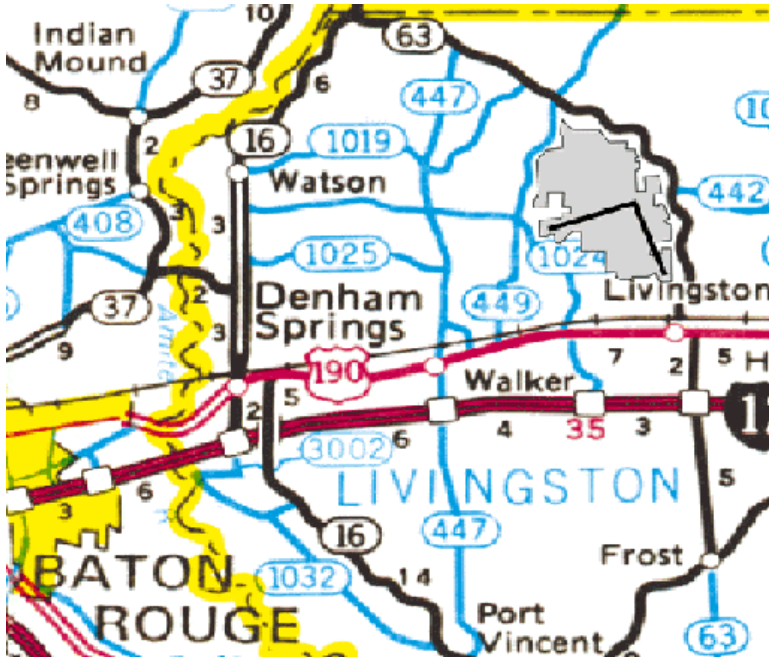
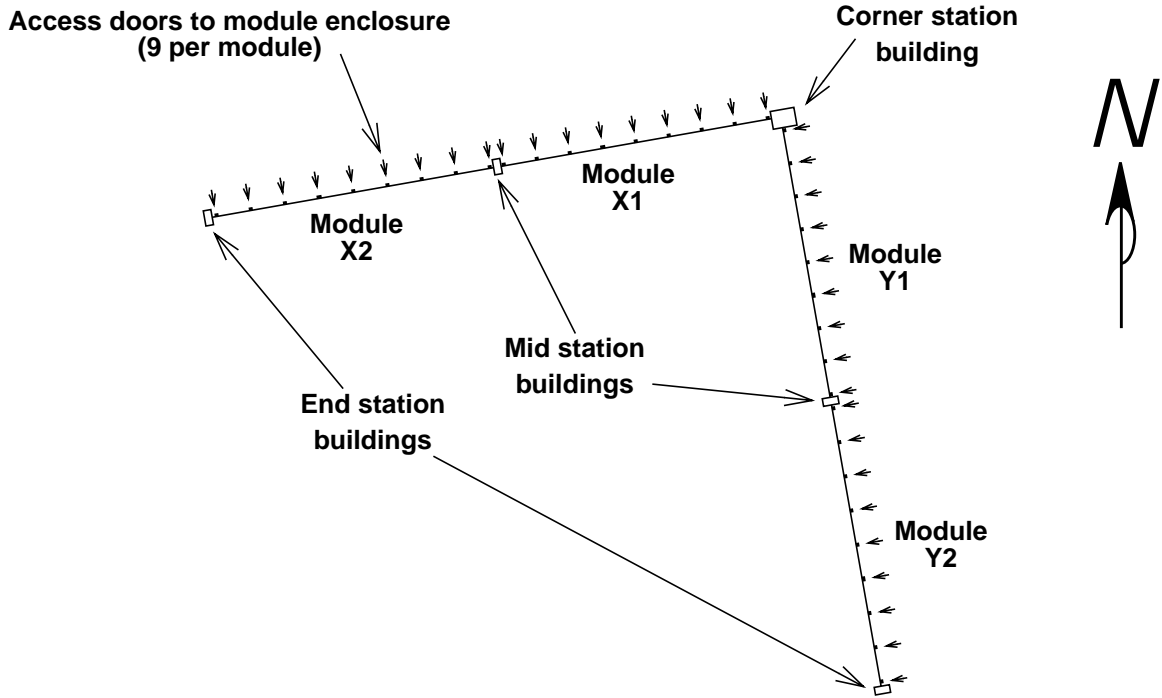

DIRECTIONS

From I-12, approximately 25 miles east of Baton Rouge

- Exit at Livingston/Frost, Exit 22
- North on SR 63 to US 190
- West on US 190 ~.25 mi to SR 63
- North on SR 63 ~3 mi to LIGO sign
- Left on LIGO road, ~1.5 mi to Corner Station

LIGO DRAFT

APPENDIX B: CONCEPTUAL SCHEMATICS

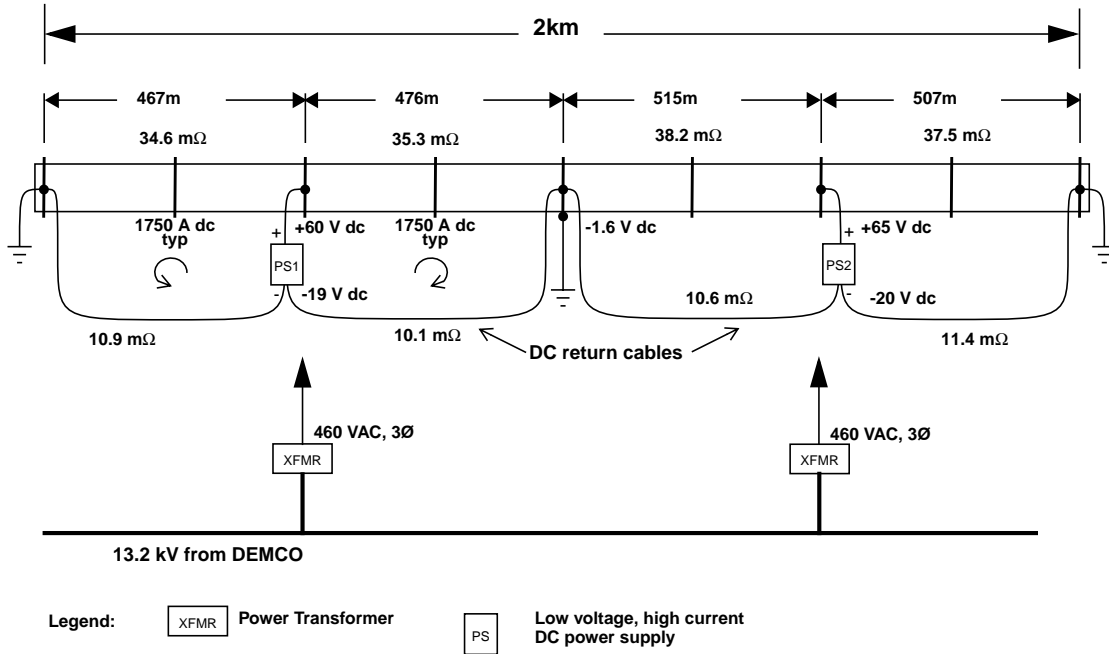

BEAM TUBE BAKEOUT ELECTRICAL POWER FOR PUMPS AND INSTRUMENTATION

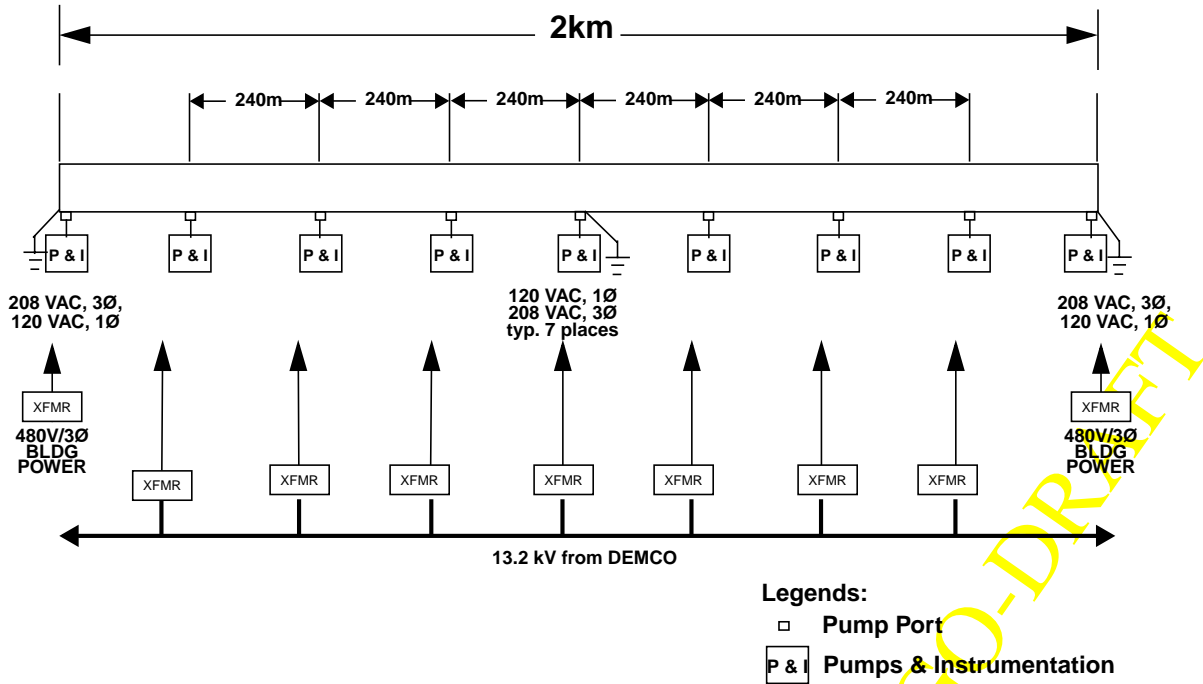

DC power supply layout (top); AC power distribution for heater jackets, pumps and instrumentation (bottom)

APPENDIX C: SCHEDULE

LIGO-DRAFT

LIGO Hardware Installation and Commissioning Summary Schedule

ID	Task Name	Duration	Start	Finish	Q3 '99			Q4 '99			Q1 '00			Q2 '00		
					Jul	Aug	Sep	Oct	Nov	Dec	Jan	Feb	Mar	Apr	May	Jun
1	BEAM TUBE BAKEOUT - LIGO LIVINGSTON OBSERVATOI	207 days	7/15/99	4/28/00												
2																
3	Electrical Services for Bakeout	207 days	7/15/99	4/28/00												
4																
5	Award Electrical Services Contract	1 day	7/15/99	7/15/99												
6	Install and Connect DC Power at X2	10 days	7/16/99	7/29/99												
7	Checkout setup and verify all equipment ready for bakeout	20 days	7/30/99	8/26/99												
8	Bakeout X2	20 days	8/27/99	9/23/99												
9	Evaluate X2 bake	10 days	9/24/99	10/7/99												
10	Install AC/DC Power, DC tube connections at X1	15 days	7/30/99	8/19/99												
11	Move DC Cables to X1	5 days	10/1/99	10/7/99												
12	Bakeout X1	20 days	11/1/99	11/26/99												
13	Evaluate X1 bake	10 days	11/29/99	12/10/99												
14	Move AC/DC Power set 1 to Y1	15 days	10/22/99	11/11/99												
15	Move DC Cables to Y1	5 days	12/6/99	12/10/99												
16	Bakeout Y1	20 days	1/10/00	2/4/00												
17	Evaluate Y1 bake	10 days	2/7/00	2/18/00												
18	Move AC/DC Power set 2 to Y2	15 days	12/27/99	1/14/00												
19	Move DC Cables to Y2	5 days	2/14/00	2/18/00												
20	Bakeout Y2	20 days	3/6/00	3/31/00												
21	Evaluate Y2 bake	10 days	4/3/00	4/14/00												
22	Pack AC/DC Power set 1, ship to storage	10 days	4/3/00	4/14/00												
23	Pack AC/DC Power set 2 and other equip, ship to storage	10 days	4/17/00	4/28/00												

APPENDIX D: TASK SEQUENCE

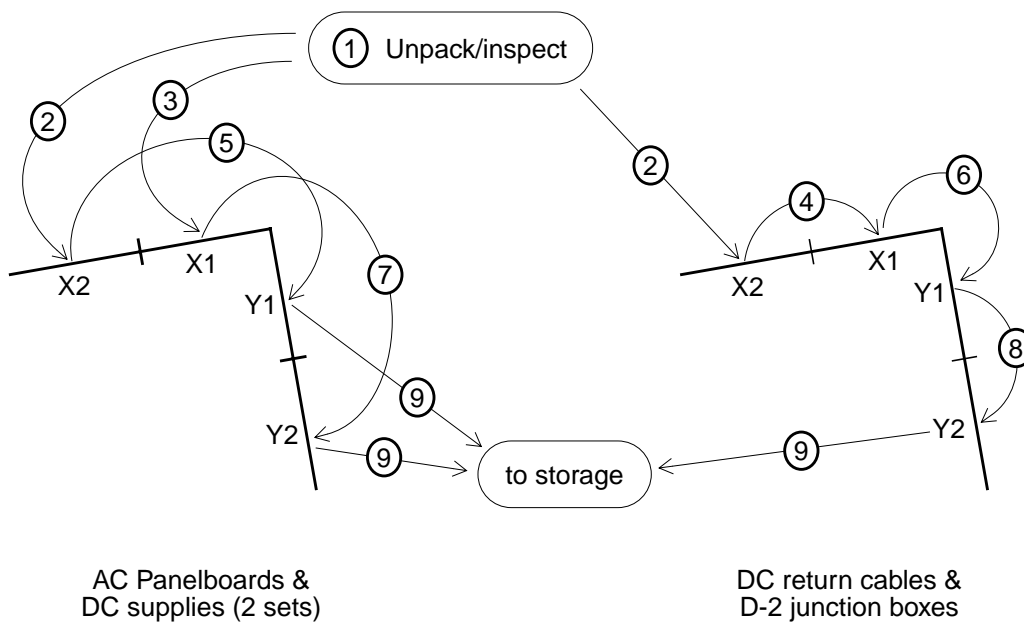

TASK NO.	TASK DESCRIPTION
1	Unpack and inspect equipment
2	Install 1st set of equipment at X2
3	Install 2nd set of AC/DC power supplies at X1
4	Move DC cables to X1
5	Move 1st set of AC/DC power supplies from X2 to Y1
6	Move DC cables to Y1
7	Move 2nd set of AC/DC power supplies from X1 to Y2
8	Move DC cables to Y2
9	Prepare equipment for shipment to storage

LIGO-DRAFT

APPENDIX E: REFERENCE DOCUMENTATION

LIGO-E980094-01-W	Drawing List - As-built specifications and drawings for bakeout electrical equipment used at Hanford
LIGO-D980094-C-W	Overall layout and equipment configuration: module X1
LIGO-D980095-C-W	module X2
LIGO-D980096-C-W	module Y1
LIGO-D980097-C-W	module Y2
LIGO-D980047-E-W	Assembly 'A1' - 120/208 Volt 3 Phase Service
LIGO-D980048-B-W	Riser Diagram - Assembly 'A1'
LIGO-D980053-C-W	Assembly 'A2' - 120/208 Volt 3 Phase Service
LIGO-D980059-E-W	Assembly 'A3' - 120/208 Volt 3 Phase Service
LIGO-D980060-B-W	Riser Diagram - Assembly 'A3'
LIGO-D980087-D-W	Riser Diagram - Assembly 'B2'
LIGO-D980072-A-W	15 kV Transition Box - Assembly 'E'
LIGO-D980077-C-W	DC Tube Connection (Assembly 'D')

LIGO-DRAFT



CALIFORNIA INSTITUTE OF TECHNOLOGY
 MASSACHUSETTS INSTITUTE OF TECHNOLOGY

E980094-01-W

DRWG NO. REV. GID

SHEET 1 OF 3

ASSY NO. E980031

PROJECT DRAWING LIST

TITLE

Beam Tube Bakeout Electrical Equipment Assemblies

APPROVALS:	DATE	REV	DCN NO	BY	CHK	DCC	DATE
DRAWN: W. Althouse	5/14/98	01		wea			4/26/99
CHECKED:							
APPROVED:							
DCC RELEASE:							

DRWG NO.	TITLE	DCN
	Portable AC Power Assemblies	
E980022-C	Specification for Electrical Contractor Services	E980093-00
E980031-C	Assembly Summary	E980093-00
D980097-C	Plan view - Bakeout Equipment Arrangement - Y2 Module	E980099-00
D980096-C	Plan view - Bakeout Equipment Arrangement - Y1 Module	E980099-00
D980094-C	Plan view - Bakeout Equipment Arrangement - X1 Module	E980099-00
D980095-C	Plan view - Bakeout Equipment Arrangement - X2 Module	E980099-00
D980098-B	Bakeout Equipment Details	E980098-00
E980030-A	Beam Tube Grounding During Bakeout - Assembly 'I'	E980032-00
E970193-B	Portable Power Cable - NEC Type W	E980002-00
E980006-A	Heater Relay Panel Assemblies	E980007-00
E980008-A	Portable Power Panelboard Assemblies	E980007-00
E980023-B	Specification for Electrical Panelboard Assembly 'A1'	E980093-00
D980047-E	Assembly 'A1' - 120/208 Volt 3 Phase Service	E980098-00
D980048-B	Riser Diagram - Assembly 'A1'	E980093-00
D980049-C	Bill of Materials - Assembly 'A1'	E980093-00
D980050-B	Subassembly 'A1-1' - Panel 'A1' (part of E980008)	E980093-00
D980051-C	Panel Schedule for Panel 'A1' (part of E980008)	E980098-00
D980052-B	Bill of Materials - Subassembly 'A1-1' (part of E980008)	E980093-00
E980024-A	Specification for Electrical Panelboard Assembly 'A2'	E980032-00
D980053-C	Assembly 'A2' - 120/208 Volt 3 Phase Service	E980098-00
D980055-C	Bill of Materials - Assembly 'A2'	E980093-00
D980056-C	Subassembly 'A2-1' - Panel 'A2' (part of E980008)	E980093-00
D980057-D	Panel Schedule for Panel 'A2' (part of E980008)	E980098-00
D980058-C	Bill of Materials - Subassembly 'A2-1' (part of E980008)	E980093-00
E980025-B	Specification for Electrical Panelboard Assembly 'A3'	E980093-00
D980059-E	Assembly 'A3' - 120/208 Volt 3 Phase Service	E980098-00
D980060-B	Riser Diagram - Assembly 'A3'	E980093-00
D980061-C	Bill of Materials - Assembly 'A3'	E980093-00
D980062-B	Subassembly 'A3-1' - Panel 'A3' (part of E980008)	E980093-00
D980063-C	Panel Schedule for Panel 'A3' (part of E980008)	E980098-00
D980064-B	Bill of Materials - Subassembly 'A3-1' (part of E980008)	E980093-00



PROJECT DRAWING LIST

TITLE

Beam Tube Bakeout Electrical Equipment Assemblies

DRWG NO.

TITLE

DC Power Supply and Tube Connection Assemblies

E980026-B	Specification for DC Power Supply Assembly 'B2'	E980093-00
D980079-C	Portable DC Power Supply with 277/480 V, 3 ϕ Metered Service	E980098-00
D980087-D	Riser diagram - Assembly 'B2'	E980098-00
D980088-C	Panel 'B2' Metering cabinet	E980098-00
D980089-C	Bill of Materials - Assembly 'B2'	E980093-00
D980090-B	Subassembly B2-1 Schematic Diagram (part of E980008)	E980098-00
D980080-C	DC Shunt Cabinet - Assembly 'G'	E980098-00
D980081-B	DC Shunt Cabinet - Splice Plate Item #212	E980093-00
D980101-A	DC Shunt Cabinet - Splice Plate Item #213	E980093-00
D980082-B	DC Shunt Cabinet - Splice Plate Item #214	E980093-00
D980054-C	Bill of materials - Assembly 'G'	E980098-00
D980066-B	120/240 V, 50 A Weatherproof Power Cord Set Assembly 'C1'	E980093-00
D980065-B	Bill of Materials - Assembly 'C1'	E980093-00
D980067-B	Bill of Materials - Misc. Cord Sets and Adapters 'C2-C12'	E980014-00
E980027-A	Specification for 15 kV Transition Box Assembly 'E'	E980032-00
D980072-A	15 kV Transition Box - Assembly 'E'	E980032-00
D980073-A	Bill of Materials - Assembly 'E'	E980032-00
E980028-A	Specification for Beam Tube DC Connections Assembly 'D'	E980032-00
D980077-C	Tube Bakeout DC Tube Connection (Assembly 'D')	E980098-00
D980078-A	Bill of Materials - Assembly 'D'	E980032-00
D980068-B	Tube Bakeout DC Connector - Subassembly 'D-1'	E980098-00
D980069-A	Tube Bakeout DC Connection Ring Extension - 306T	E980032-00
D980070-A	Tube Bakeout DC Connection Ring Extension - 306B	E980032-00
D980071-A	Bill of Materials - Subassembly 'D-1'	E980032-00
D980083-B	Tube Bakeout DC Connection Box (Subassembly 'D-2')	E980098-00
D980084-A	Splice plate	E980032-00
D980085-B	Bill of Materials	E980098-00



PROJECT DRAWING LIST

TITLE

Beam Tube Bakeout Electrical Equipment Assemblies

DRWG NO.

TITLE

Heater Blanket Relay Panel Assemblies

E980029-B	Heater Blanket Relay Panel Installation - Assembly 'H'	E980093-00
D980021-B	Heating Blanket Relay Panel Box 'H1' Ass'y (part of E980006)	E980093-00
D980022-B	Assembly 'H1' Connection Diagram (part of E980006)	E980093-00
D980023-B	Assembly 'H1' Schematic Diagram (part of E980006)	E980093-00
D980038-A	Bill of Materials - Assembly 'H1' (part of E980006)	E980007-00
D980024-A	Heating Blanket Relay Panel Assembly 'H2'	E980093-00
D980039-A	Bill of Materials - Assembly 'H2'	E980093-00
D980025-A	Subass'y 'H2-1' Heating Blanket Panel 'H2' (part of E980006)	E980007-00
D980026-B	Subass'y 'H2-1' Connection Diagram (part of E980006)	E980093-00
D980027-B	Subass'y 'H2-1' Schematic Diagram (part of E980006)	E980093-00
D980091-A	Controller Display & Equip. Connector Details (part of E980006)	E980007-00
D980040-A	Bill of Materials - Subass'y 'H2-1' (part of E980006)	E980007-00
D980028-A	Heating Blanket Relay Panel Assembly 'H3'	E980093-00
D980041-A	Bill of Materials - Assembly 'H3'	E980093-00
D980029-A	Subass'y 'H3-1' Heating Blanket Panel 'H2' (part of E980006)	E980007-00
D980030-B	Subass'y 'H3-1' Connection Diagram (part of E980006)	E980093-00
D980031-B	Subass'y 'H3-1' Schematic Diagram (part of E980006)	E980093-00
D980091-A	Controller Display & Equip. Connector Details (part of E980006)	E980007-00
D980042-A	Bill of Materials - Subass'y 'H3-1' (part of E980006)	E980007-00
D980032-A	Heating Blanket Relay Panel Assembly 'H4'	E980093-00
D980043-A	Bill of Materials - Assembly 'H4'	E980093-00
D980033-A	Subass'y 'H4-1' Heating Blanket Panel 'H2' (part of E980006)	E980007-00
D980034-B	Subass'y 'H4-1' Connection Diagram (part of E980006)	E980093-00
D980035-B	Subass'y 'H4-1' Schematic Diagram (part of E980006)	E980093-00
D980091-A	Controller Display & Equip. Connector Details (part of E980006)	E980007-00
D980044-A	Bill of Materials - Subass'y 'H4-1' (part of E980006)	E980007-00
D980036-A	Heating Blanket Cord Set Assembly 'HC' (part of E980006)	E980007-00
D980045-A	Bill of Materials - Assembly 'HC' (part of E980006)	E980007-00
D980099-A	Heating Blanket-Junction Box Cord Set 'HC1' (part of E980006)	E980093-00
D980100-A	Bill of Materials - Assembly 'HC1' (part of E980006)	E980093-00
D980037-A	6-Way Junction Box Assembly 'HJ1' (part of E980006)	E980007-00
D980046-A	Bill of Materials - Assembly 'HJ1' (part of E980006)	E980007-00
D980092-A	2-Way Junction Box Assembly 'HJ2' (part of E980006)	E980007-00
D980093-A	Bill of Materials - Assembly 'HJ2' (part of E980006)	E980007-00

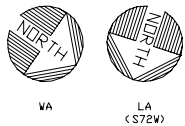

NOTES

- PULL DC CABLES THROUGH ACCESS ROAD BRIDGE.
- INSIDE SINGLE DOORS ADJACENT TO MID AND END STATIONS. POWER WILL BE SUPPLIED FROM INSIDE MID OR END STATION THROUGH ACCESS HOLES IN SHEET METAL PARTITION.

- DC - DIRECT CURRENT
- HC - BLK END HTR CABLE
- HC1 - YEL END HTR CABLE
- HJ1 - 6-WAY DISTRIBUTION BOX
- HJ2 - 2-WAY DISTRIBUTION BOX
- H1 - CONTROL BOX
- LS - PORTABLE NIGHT STAND
- LST - PORTABLE LIGHT STRING
- - PRIMARY POWER VAULT
- PS - POWER SUPPLY
- RET. - DC CABLE RETURN CONNECTION
- POS. - DC CABLE POSITIVE CONNECTION
- STA - PORT & STIFFENER RING STATION #'S
- WA, LA (<IN METERS)
- ↑ - PUMP PORT
- I - FIXED BEAM TUBE SUPPORT RING FOR DC CABLE CONNECTION

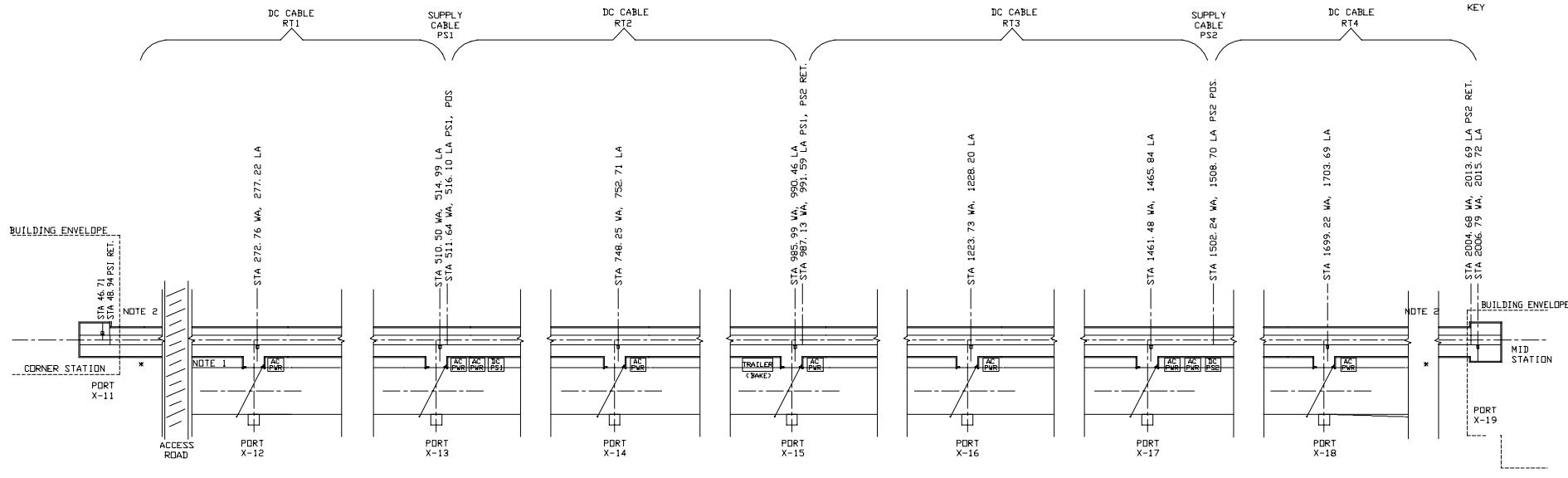
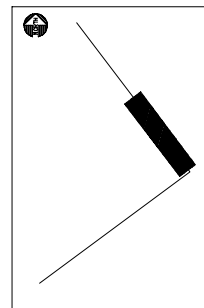

ASSEMBLY	QTY	#ASSEMBLY	QTY	ASSEMBLY	QTY	ASSEMBLY	QTY	ASSEMBLY	QTY	ASSEMBLY	QTY	ASSEMBLY	QTY	ASSEMBLY	QTY	ASSEMBLY	QTY
A2	1	C8	2	A1	1	A1	1	A3	1	A1	1	A1	1	A1	1	A1	1
C5	15	C10	2	C2	6	B8	1	C1	1	B2	1	C2	11	C2	6	C8	14
C7	1	LS	1	C4	1	C2	10	C4	1	C4	1	C4	1	C4	1	LS	1
C8	2	LST	1	C5	1	C5	1	C5	1	C5	1	C5	1	C5	1	LST	1
C10	4			C8	2	C8	2	C8	6	C8	2	C8	2	C8	2	C8	3
C11	4			C9	2	C9	2	C10	4	C10	2	C10	2	C10	2	C10	3
D	1			C10	3	C10	3	E	1	E	1	E	1	E	1	D	1
H1	6			F	1	F	1	H1	4	H1	4	H1	4	H1	4	H1	6
H2	1			H1	4	H1	4	H1	13	H1	10	H1	10	H1	10	H2	1
H3	1			HC	10	HC	10	HC	23	HC	3	HC	3	HC	3	H3	1
H4	1			HC1	3	HC1	3	HC1	6	HC1	3	HC1	3	HC1	3	H4	1
HC	64			HJ1	3	HJ1	3	HJ1	6	HJ1	3	HJ1	3	HJ1	3	HC	1
HC1	36			LS	1	LS	1	HJ2	4	LS	1	LS	1	LS	1	HC1	65
HJ1	6			LST	1	LST	1	I	2	I	1	I	1	I	1	HJ1	36
HJ2	15							LST	1	HJ2	1	HJ2	1	HJ2	1	HJ2	7
I	1									LS	1	LS	1	LS	1	HJ2	14
										LST	1	LST	1	LST	1	I	1
																LS	1



 DEPTX ASSOCIATES, INC. Engineers and Consultants	LIGO HANFORD, WA AND LIVINGSTON, LA		PLAN VIEW - BAKEOUT EQPT. ARRANGEMENT X-1 MODULE LIGO-D 980094-C-W	
	DWN BY: GLM	DSN BY: GW	CHK BY: JAS	DATE: 4/99

SCALE: 1"=20' 0"

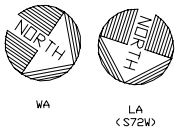

NOTE:
 INSIDE SINGLE DOORS ADJACENT TO MID AND END STATIONS.
 POWER WILL BE SUPPLIED FROM INSIDE MID OR END STATION
 THROUGH ACCESS HOLES IN SHEET METAL PARTITION.

- DC - DIRECT CURRENT
- HC - BLK END HTR CABLE
- HC1 - YEL END HTR CABLE
- HJ1 - 6-WAY DISTRIBUTION BOX
- HJ2 - 2-WAY DISTRIBUTION BOX
- H1 - CONTROL BOX
- LS - PORTABLE NIGHT STAND
- LST - PORTABLE LIGHT STRING
- - PRIMARY POWER VAULT
- PS - POWER SUPPLY
- RET. - DC CABLE RETURN CONNECTION
- POS. - DC CABLE POSITIVE CONNECTION
- STA - PORT & STIFFENER RING STATION #'S
- WA, LA (IN METERS)
- ↑ - PUMP PORT
- ⌋ - FIXED BEAM TUBE SUPPORT RING FOR DC CABLE CONNECTION

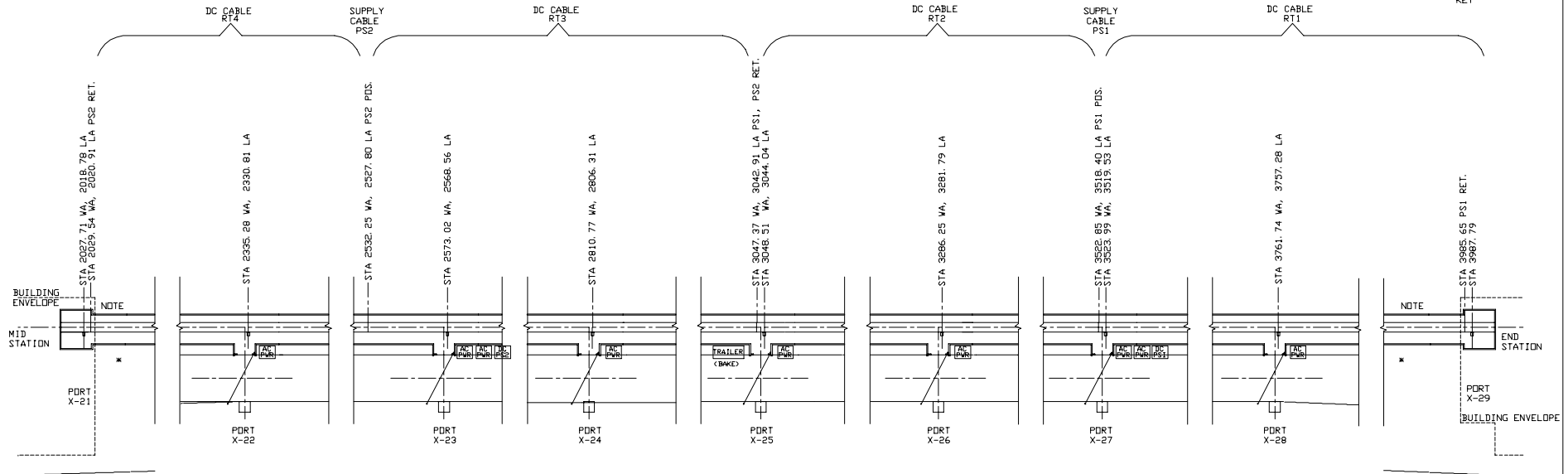
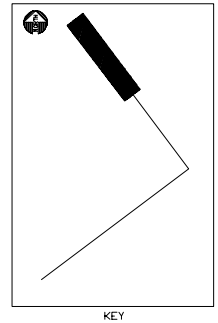

ASSEMBLY	QTY	*ASSEMBLY	QTY	ASSEMBLY	QTY	ASSEMBLY	QTY	ASSEMBLY	QTY	ASSEMBLY	QTY	ASSEMBLY	QTY	ASSEMBLY	QTY	ASSEMBLY	QTY
A2	1	C8	2	A1	1	A1	1	A3	1	A1	1	A1	1	C8	2	A2	1
C5	14	C10	2	C2	6	C2	6	C2	6	B2	1	C2	6	C2	2	C5	15
C7	1	LS	1	C4	1	C4	1	C4	1	C4	1	C4	1	LS	1	C7	1
C8	3	LST	1	C5	1	C5	1	C5	2	C5	1	C5	1	LST	1	C8	2
C10	4			C8	2	C8	2	C8	6	C8	2	C8	2			C10	4
C11	3			C10	2	C10	2	C10	4	C10	1	C10	3			C11	4
D	1			E	1	E	1	D	1	E	1	C10	3			D	1
H1	6			H1	4	H1	4	E	1	H1	4	H1	4			H1	6
H2	1			HC	10	HC	10	H1	1	HC	10	HC	10			H2	1
H3	1			HC1	3	HC1	3	HC	10	HC1	3	HC1	3			H3	1
H4	1			HJ1	3	HJ1	3	HC1	3	HC	11	HJ1	3			H4	1
HC	65			LS	1	LS	1	HJ1	3	LS	1	LS	1			HC	64
HC1	36							HJ2	2	HJ1	2	HJ2	1			HC1	36
HJ1	7							L	1	HJ2	1	LS	1			HJ1	6
HJ2	14							LST	1	L	1	LST	1			HJ2	15
L	1															L	1
LS	1																



	LIGO HANFORD, WA AND LIVINGSTON, LA		PLAN VIEW - BAKEOUT EQPT. ARRANGEMENT X-2 MODULE LIGO-D 980095-C-W	
	DWN BY: GLM	DSN BY: GW	CHK BY: JAS	DATE: 4/99
			FILE: D980095-C-W	SCALE: 1"=20' 0"

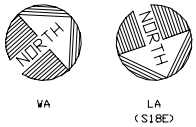

NOTE:
INSIDE SINGLE DOORS ADJACENT TO MID AND END STATIONS.
POWER WILL BE SUPPLIED FROM INSIDE MID OR END STATION
THROUGH ACCESS HOLES IN SHEET METAL PARTITION.

- DC - DIRECT CURRENT
- HC - BLK END HTR CABLE
- HC1 - YEL END HTR CABLE
- HJ1 - 6-WAY DISTRIBUTION BOX
- HJ2 - 2-WAY DISTRIBUTION BOX
- H1 - CONTROL BOX
- LS - PORTABLE LIGHT STAND
- LST - PORTABLE LIGHT STRING
- - PRIMARY POWER VAULT
- PS - POWER SUPPLY
- RET. - DC CABLE RETURN CONNECTION
- PDS. - DC CABLE POSITIVE CONNECTION
- STA - PORT & STIFFENER RING STATION # S
- WA, LA < IN METERS
- ↑ - PUMP PORT
- ↓ - FIXED BEAM TUBE SUPPORT RING FOR DC CABLE CONNECTION

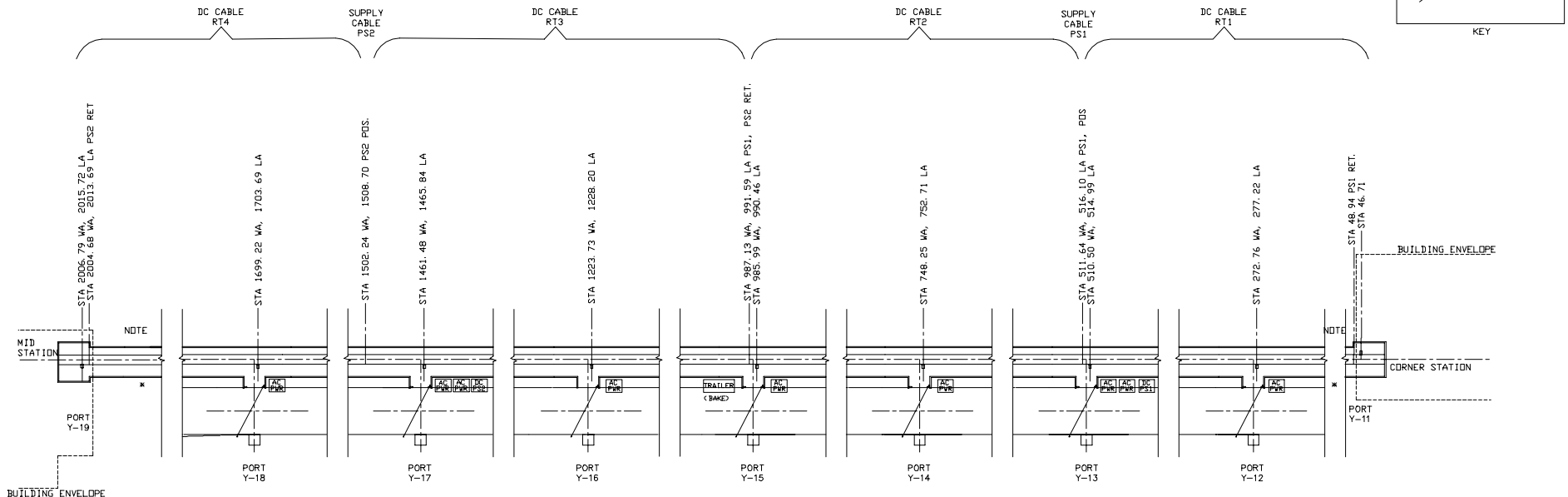
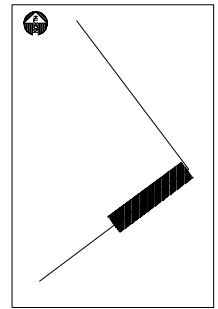

ASSEMBLY	QTY	*ASSEMBLY	QTY	ASSEMBLY	QTY	ASSEMBLY	QTY	ASSEMBLY	QTY	ASSEMBLY	QTY	ASSEMBLY	QTY	*ASSEMBLY	QTY	ASSEMBLY	QTY
A2	1	C8	2	A1	1	A1	1	A3	1	A3	1	A1	1	C8	2	A2	1
C5	14	C10	2	C2	6	B2	1	C1	1	C2	6	C2	6	C10	2	C5	15
C7	1	LS	1	C4	1	C4	11	C2	10	C4	1	C2	10	C4	1	C7	1
C8	3			C5	1	C5	1	C5	2	C5	1	C4	1	C5	1	C8	2
C10	4	LST	1	C8	2	C8	2	C8	2	C8	2	C8	2	C8	2	C10	4
C11	3			C10	2	C10	2	C10	4	C9	2	C9	1	C10	3	C11	4
D	1			E	1	E	1	D	1	E	1	E	1	E	1	D	1
H1	1			H1	4	H1	4	H1	13	H1	4	H1	4	H1	4	H1	6
H2	1			HC	10	HC	10	HC	10	HC	10	HC	10	HC	10	H2	1
H3	1			E	1	E	1	HC1	3	HC1	3	HC1	3	HC1	3	H3	1
H4	1			H1	5	H1	5	HC1	6	H1	5	H1	5	H4	1	H4	1
HC	65			HC	11	HC	11	HJ1	4	HC1	3	HC1	3	HC	64	HC	64
HC1	36			LS	3	LS	3	HJ2	2	HJ1	3	HJ1	3	HC1	96	HC1	96
HJ1	7			HC1	2	HC1	2	I	1	HJ2	1	HJ2	1	HJ1	6	HJ1	6
HJ2	14			HJ1	1	HJ1	1	LS	1	LS	1	LS	1	HJ2	15	HJ2	15
I	1			LS	1	LS	1	LST	1	LST	1	LST	1	I	1	I	1
LS	1			LST	1	LST	1										



	LIGO HANFORD, WA AND LIVINGSTON, LA		PLAN VIEW - BAKEOUT EQPT. ARRANGEMENT Y-1 MODULE LIGO-D 980096-C-W	
	DWN BY: GLM	DSN BY: GW	CHK BY: JAS	DATE: 4/99
FILE: D980096-C-W			SCALE: 1"=20'0"	



WA



LA
(S18E)

NOTE:

INSIDE SINGLE DOORS ADJACENT TO MID AND END STATIONS.
POWER WILL BE SUPPLIED FROM INSIDE MID OR END STATION
THROUGH ACCESS HOLES IN SHEET METAL PARTITION.

- DC - DIRECT CURRENT
- HC - BLK END HTR CABLE
- HC1 - YEL END HTR CABLE
- HJ1 - 6-WAY DISTRIBUTION BOX
- HJ2 - 2-WAY DISTRIBUTION BOX
- HI - CONTROL BOX
- LS - PORTABLE NIGHT STAND
- LST - PORTABLE LIGHT STRING
- - PRIMARY POWER VAULT
- PS - POWER SUPPLY
- RET - DC CABLE RETURN CONNECTION
- POS - DC CABLE POSITIVE CONNECTION
- STA - PORT & STIFFENER RING STATION #'S
WA, LA (IN METERS)
- ↑ - PUMP PORT
- ↑ - FIXED BEAM TUBE SUPPORT
RING FOR DC CABLE CONNECTION

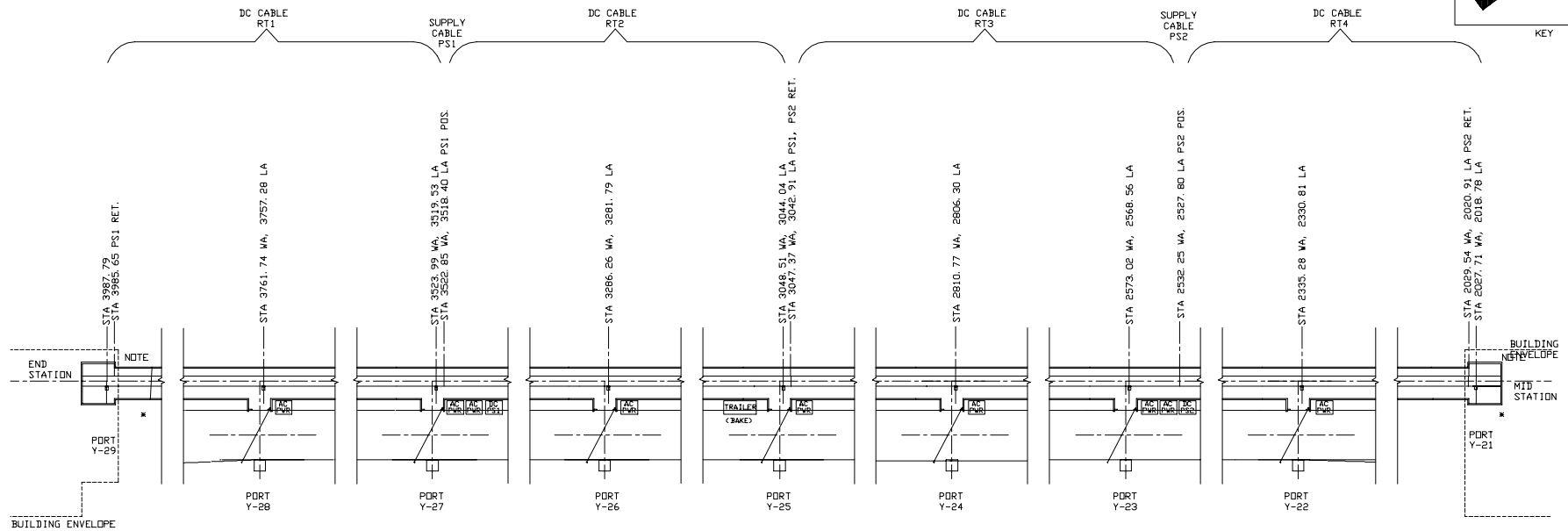
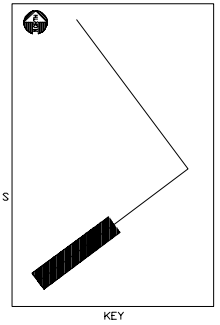

ASSEMBLY	QTY	ASSEMBLY	QTY	ASSEMBLY	QTY	ASSEMBLY	QTY	ASSEMBLY	QTY	ASSEMBLY	QTY	ASSEMBLY	QTY	ASSEMBLY	QTY	ASSEMBLY	QTY	ASSEMBLY	QTY		
A2	1	C8	2	A1	1	A3	1	A1	1	A1	1	A1	1	A1	1	A1	1	A2	1		
C5	15	C10	2	B6	1	C2	6	C1	1	C2	6	C2	6	C2	6	C2	6	C2	6	C5	14
C7	1	LS	1	C4	1	C4	1	C4	1	C4	1	C4	1	C4	1	C4	1	C4	1	C7	1
C8	2	LST	1	C5	1	C5	1	C5	2	C5	1	C5	1	C5	1	C5	1	C5	1	C8	3
C10	4			C8	2	C8	6	C8	4	C8	2	C8	2	C8	2	C8	2	C8	2	C10	4
C11	4			C10	3	C10	2	C10	1	C10	1	C10	2	C10	2	C10	2	C10	2	C11	3
D	1			E	1	E	1	D	1	D	1	D	1	D	1	D	1	D	1		
H1	6			H1	4	H1	4	H1	4	H1	4	H1	4	H1	4	H1	4	H1	4	H1	6
H2	1			HC	10	HC	10	H1	13	HC	10	HC	10	HC	10	HC	10	HC	10	H2	1
H3	1			HC1	9	HC1	9	HC	23	HC1	9	HC1	9	HC1	9	HC1	9	HC1	9	H3	1
H4	1			HC1	3	HC1	3	HC1	6	HC1	3	HC1	3	HC1	3	HC1	3	HC1	3	H4	1
HC	64			LS	1	LS	1	HJ1	4	LS	1	LS	1	LS	1	LS	1	LS	1	HC	65
HC1	36							HJ2	2											HC1	36
HJ1	6							HJ2	1											HJ1	7
HJ2	15							LST	1											HJ2	14
I	1																			I	1
																				LS	1



LIGO
HANFORD, WA AND LIVINGSTON, LA

PLAN VIEW - BAKEOUT EQPT. ARRANGEMENT
Y-2 MODULE
LIGO-D 980097-C-W

DWN BY: GLM	DSN BY: GDW	CHK BY: JAS	DATE: 4/99	FILE: D980097-C-W	SCALE: 1"=20'0"
-------------	-------------	-------------	------------	-------------------	-----------------

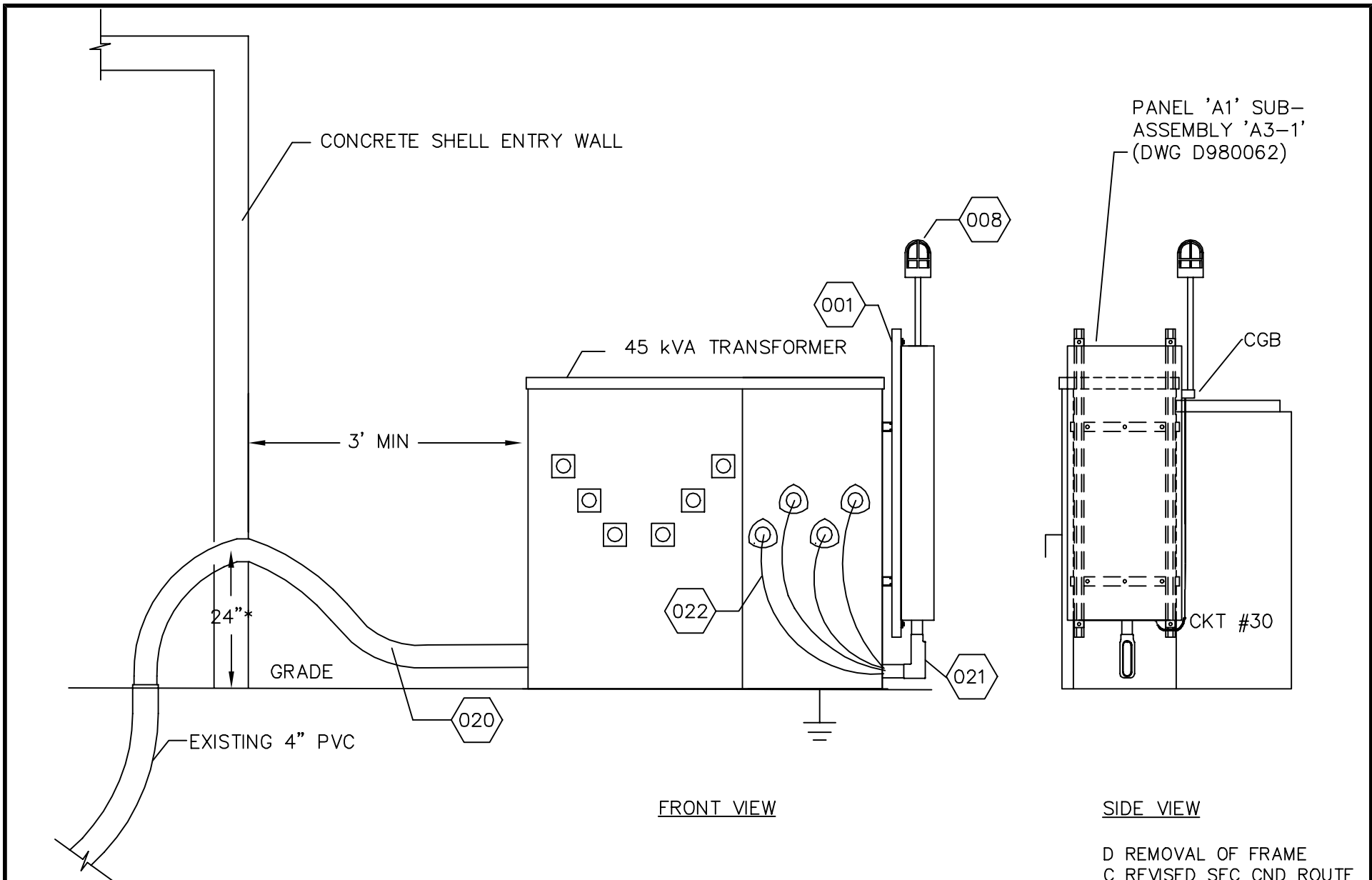

SCALE: 1/2"=1'-0"

* CORE DRILL 6" HOLE 24" ABOVE FLOOR

- D REMOVAL OF FRAME
- C REVISED SEC CND ROUTE
- B ADDED CORE DRILL NOTE
- A INITIAL ISSUE

DEITTLE AND ASSOCIATES, INC.
 FILE: 980047-E-W DATE: APR 1999

ASSEMBLY 'A1'
 120/208 VOLT, 3 PHASE SERVICE

LIG0-0980047-E-W

NOTES:

- 1) 15 kV CABLE SHALL BE SUPPLIED, INSTALLED AND TERMINATED BY SERVING UTILITY. 15 kV CONDUITS SHALL BE SUPPLIED AND INSTALLED BY CONTRACTOR.
- 2) SERVICE CONDUCTORS SHALL BE SUPPLIED AND INSTALLED BY CONTRACTOR. TERMINATION AT TRANSFORMER SHALL BE BY SERVING UTILITY.
- 3) CONTRACTOR SHALL INSTALL OWNER FURNISHED TRANSFORMER.

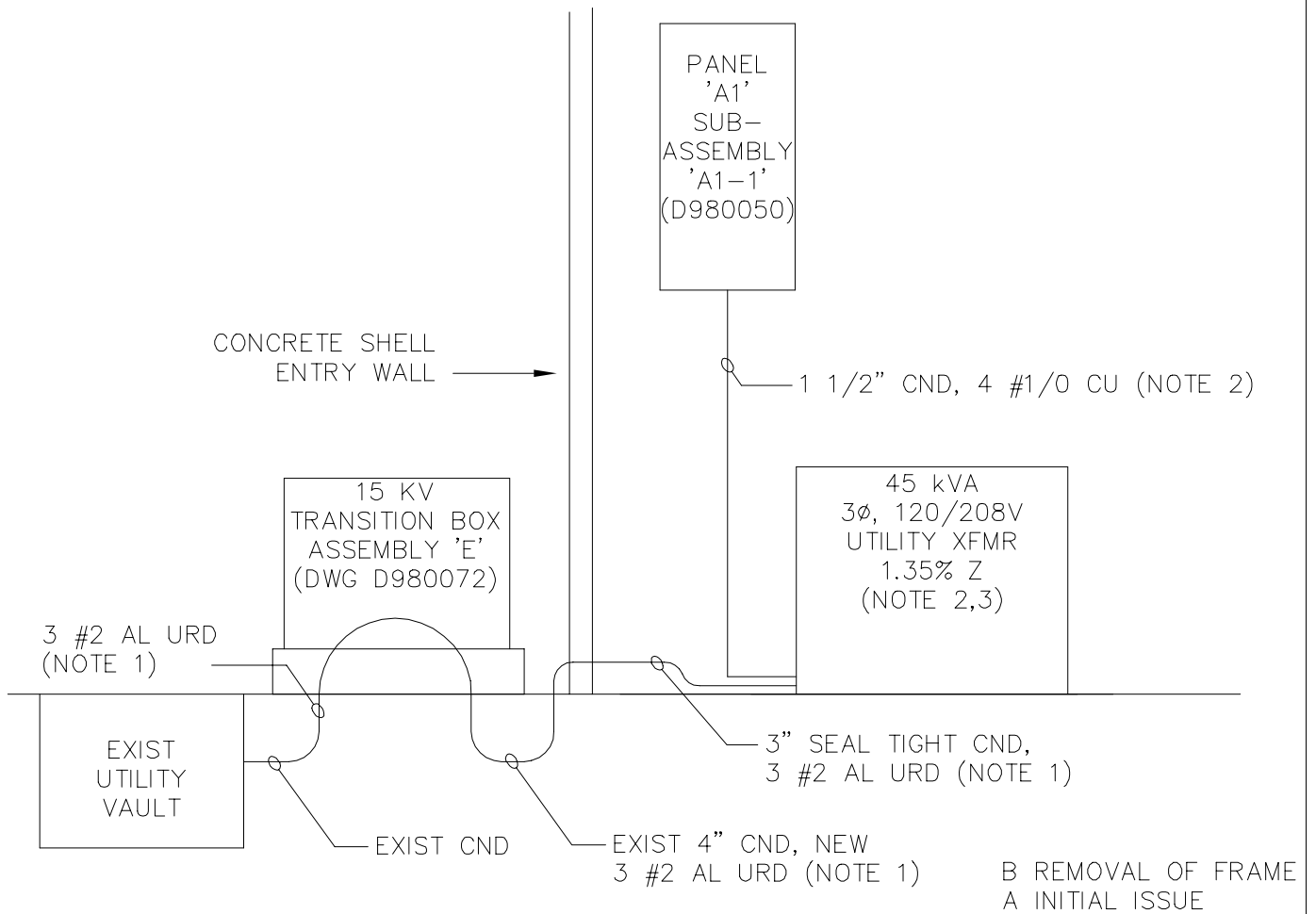

LIGO-D980048-B-W

DEITTLE AND ASSOCIATES, INC.

FILE: RISERA1 DATE: MAY 1998

**RISER DIAGRAM
ASSEMBLY 'A1'**

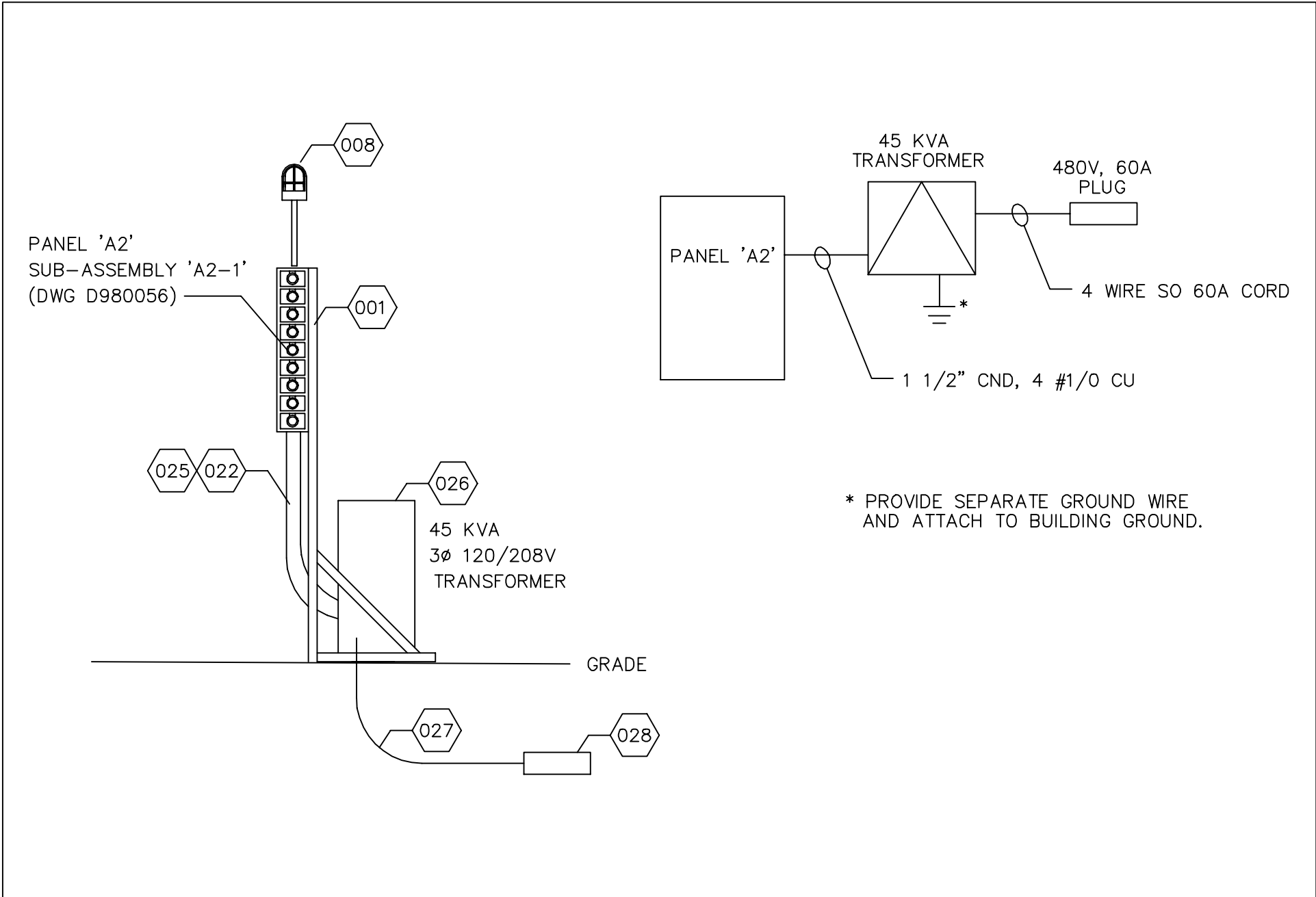

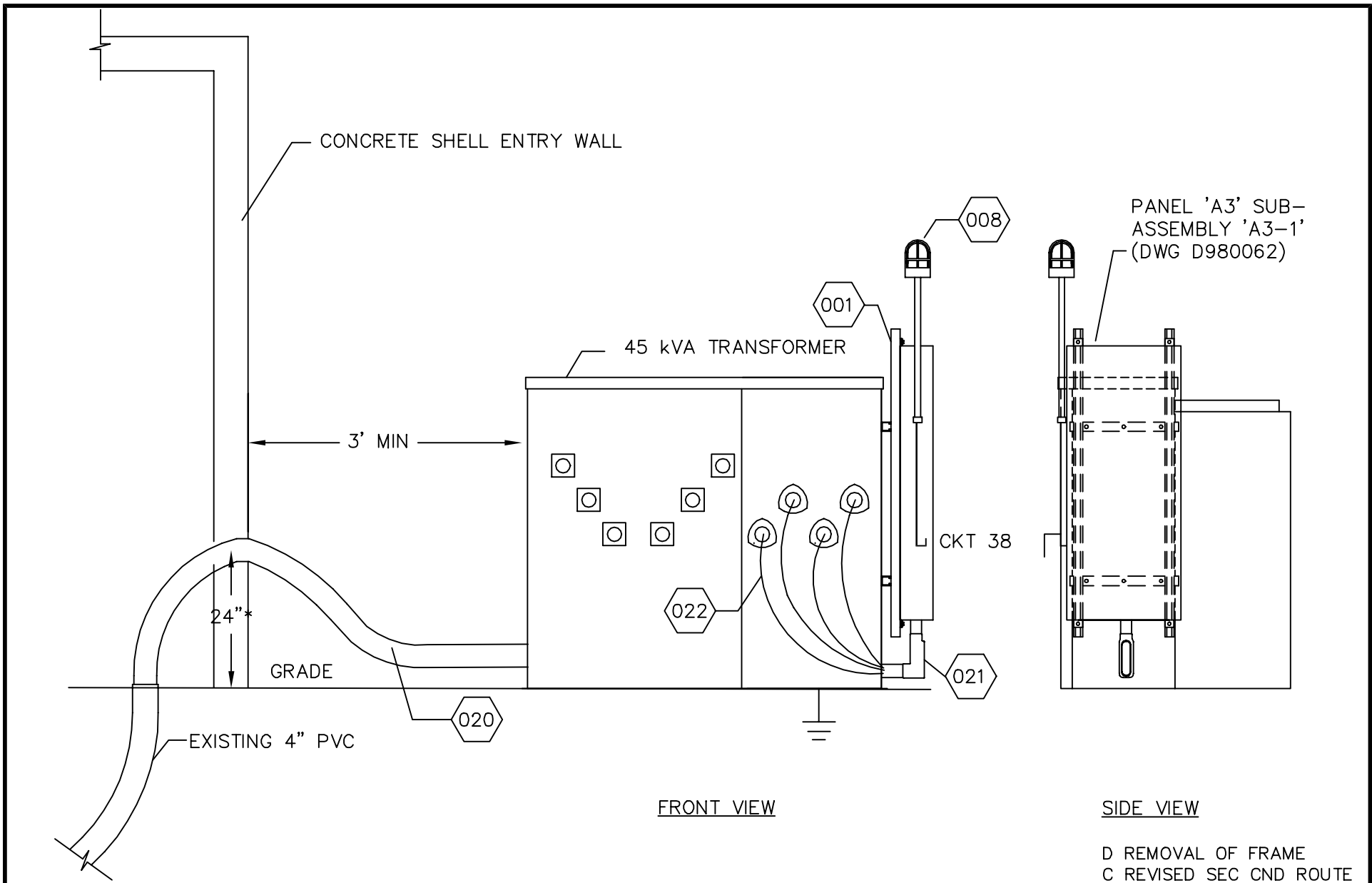

FRONT VIEW

SIDE VIEW

- D REMOVAL OF FRAME
- C REVISED SEC CND ROUTE
- B ADDED CORE DRILL NOTE
- A INITIAL ISSUE

* CORE DRILL 6" HOLE 24" ABOVE FLOOR

SCALE: 1/2"=1'-0"

DEITTLE AND ASSOCIATES, INC.

FILE: 980059-E-W DATE: APR 99

ASSEMBLY 'A3'
120/208 VOLT, 3 PHASE SERVICE

LIGO-0980059-E-W

NOTES:

- 1) 15 kV CABLE SHALL BE SUPPLIED, INSTALLED AND TERMINATED BY SERVING UTILITY. 15 kV CONDUITS SHALL BE SUPPLIED AND INSTALLED BY CONTRACTOR.
- 2) SERVICE CONDUCTORS SHALL BE SUPPLIED AND INSTALLED BY CONTRACTOR. TERMINATION AT TRANSFORMER SHALL BE BY SERVING UTILITY.
- 3) CONTRACTOR SHALL INSTALL OWNER FURNISHED TRANSFORMER.

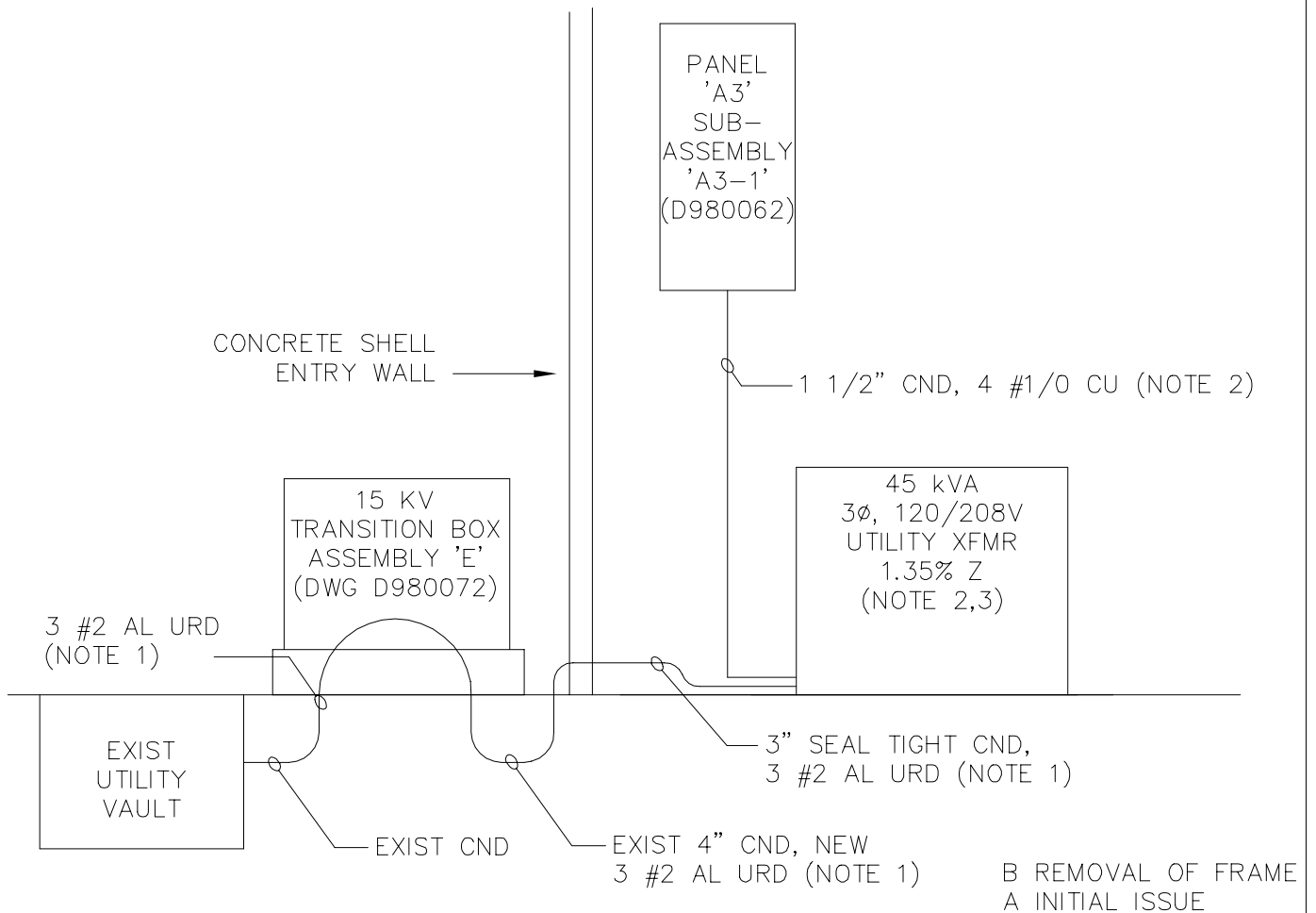

LIGO-D980060-B-W

NOTES:

- 1) 15 kV CABLE SHALL BE SUPPLIED, INSTALLED AND TERMINATED BY SERVING UTILITY. 15 kV CONDUITS SHALL BE SUPPLIED AND INSTALLED BY ELECTRICAL CONTRACTOR.
- 2) SERVICE CONDUCTORS SHALL BE SUPPLIED AND INSTALLED BY ELECTRICAL CONTRACTOR. TERMINATION AT TRANSFORMER SHALL BE BY SERVING UTILITY.
- 3) FAULT CURRENT = $45,000 \text{ VA} / (208\text{V} \times 1.7321 \times 1.35\%) = 9,252 \text{ AMPS}$.
- 4) FAULT CURRENT = $500,000 \text{ VA} / (480\text{V} \times 1.7321 \times 1.35\%) = 44,547 \text{ AMPS}$.

D DCN EP80096-00-W
 CONSTRUCTION RECORD
 C REMOVAL OF FRAME
 B ADD PSIO CABINET
 A INITIAL ISSUE

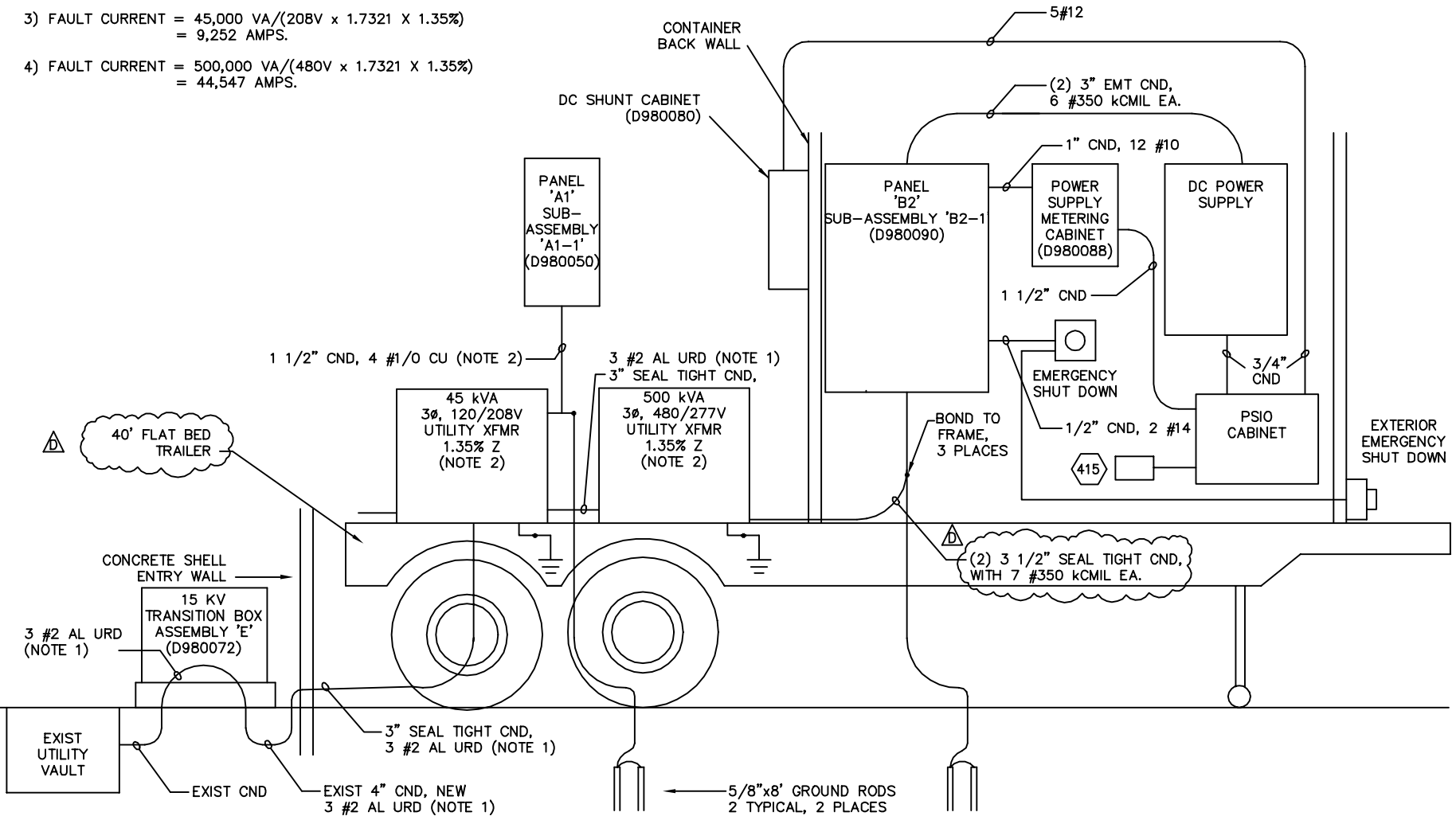

LIGO-D980087-D-W

RISER DIAGRAM
 ASSEMBLY 'B2'

DEITZ
 AND ASSOCIATES, INC.

DRAWN BY: CDW
 SCALE: DATE: 4/99
 FILE: D980087-D-W

NOTES:

- 1) CONTRACTOR SHALL ANCHOR TRANSFORMER BOX PAD ITEM #031 TO ASPHALT SURFACE WITH (8) 1/2" MIN. DIA. ANCHORS. IF TRANSFORMER IS INSTALLED ON GRAVEL SURFACE SUBSTITUTE (8) 1/2" X 16" STEEL STAKES FOR ITEM #033.
- 2) CONTRACTOR SHALL SUPPLY AND INSTALL TRANSFORMER BOX PAD ITEM #031 WITH COVER ITEM #032.
- 3) CONTRACTOR SHALL SUPPLY AND INSTALL ADHESIVE REFLECTIVE TAPE ON ALL SIDES OF BOX 2" BELOW TOP.

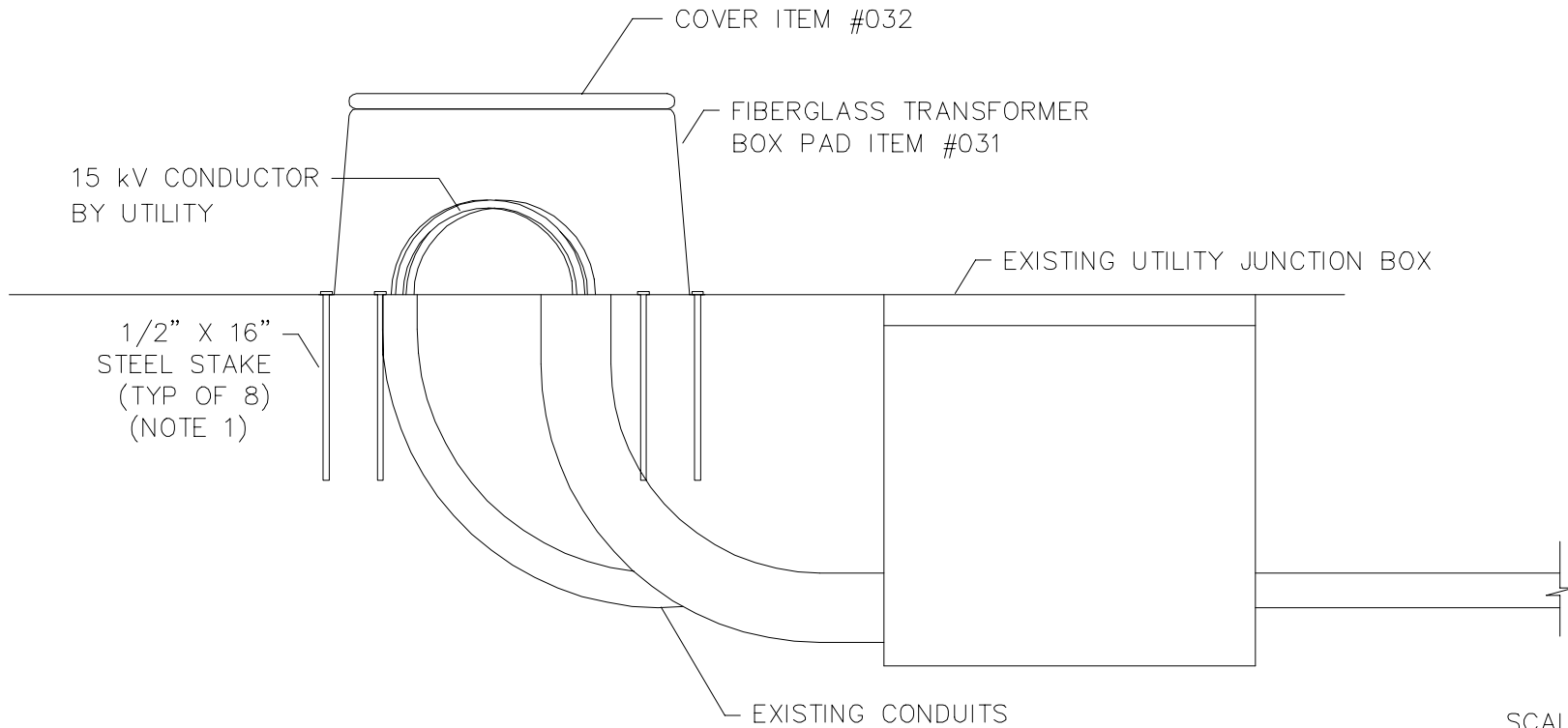
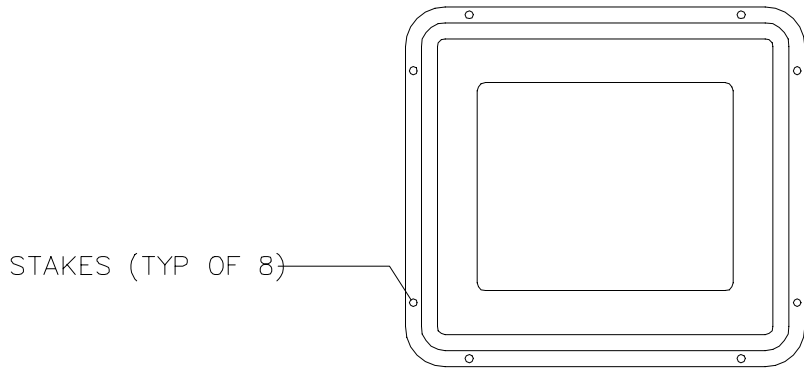

SCALE: 1/2"=1'0"

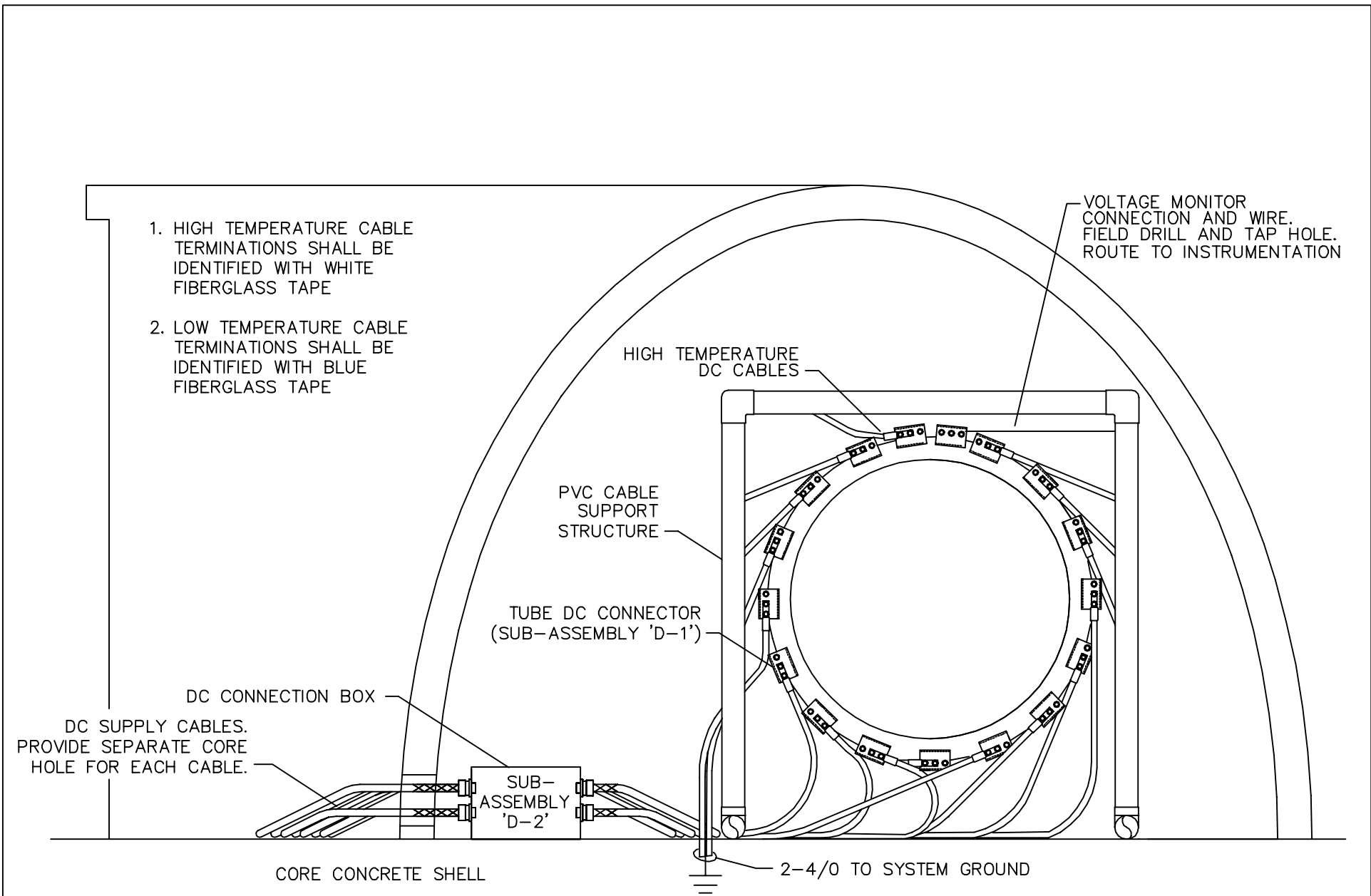

1. HIGH TEMPERATURE CABLE TERMINATIONS SHALL BE IDENTIFIED WITH WHITE FIBERGLASS TAPE
2. LOW TEMPERATURE CABLE TERMINATIONS SHALL BE IDENTIFIED WITH BLUE FIBERGLASS TAPE

SCALE: 1/2"=1'0"