

This document provides details about the LLO electronics racks. It may be examined through four separate but interconnected methods: racks may be found searching MAPS of the observatory, or for AREAS in which they reside, or by searching SUBSYSTEMS that they service., or through the DocDB references to their D-numbers or S-numbers.

[Search by LOCATION](#)

[Search by AREA](#)

[Search by SUBSYSTEM](#)

[Search by DocDB](#)

[Search by Chamber](#)

[Search by Aerial Photo](#)



Electronics Rack (LSE)	200 Electronics Rack (LSE)	LLO Electronics Rack (LSE)	200 Electronics Rack (LSE)
200 Electronics Rack (LSE)	200 Electronics Rack (LSE)	200 Electronics Rack (LSE)	200 Electronics Rack (LSE)

Audio-Video 200 AV (LSE) 200 AV (LSE) 200 AV (LSE) 200 AV (LSE) 200 AV (LSE)	Pre-amplified Laser 200 PL (LSE) 200 PL (LSE) 200 PL (LSE) 200 PL (LSE) 200 PL (LSE)	Control 200 C (LSE) 200 C (LSE) 200 C (LSE) 200 C (LSE) 200 C (LSE)
200 Electronics Rack (LSE) 200 E (LSE) 200 E (LSE) 200 E (LSE) 200 E (LSE) 200 E (LSE)	200 Electronics Rack (LSE) 200 E (LSE) 200 E (LSE) 200 E (LSE) 200 E (LSE) 200 E (LSE)	200 Electronics Rack (LSE) 200 E (LSE) 200 E (LSE) 200 E (LSE) 200 E (LSE) 200 E (LSE)
200 Electronics Rack (LSE) 200 E (LSE) 200 E (LSE) 200 E (LSE) 200 E (LSE) 200 E (LSE)	200 Electronics Rack (LSE) 200 E (LSE) 200 E (LSE) 200 E (LSE) 200 E (LSE) 200 E (LSE)	200 Electronics Rack (LSE) 200 E (LSE) 200 E (LSE) 200 E (LSE) 200 E (LSE) 200 E (LSE)

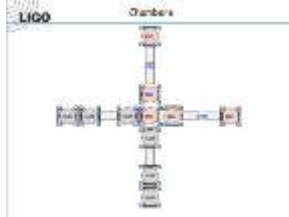

[<< Start](#)

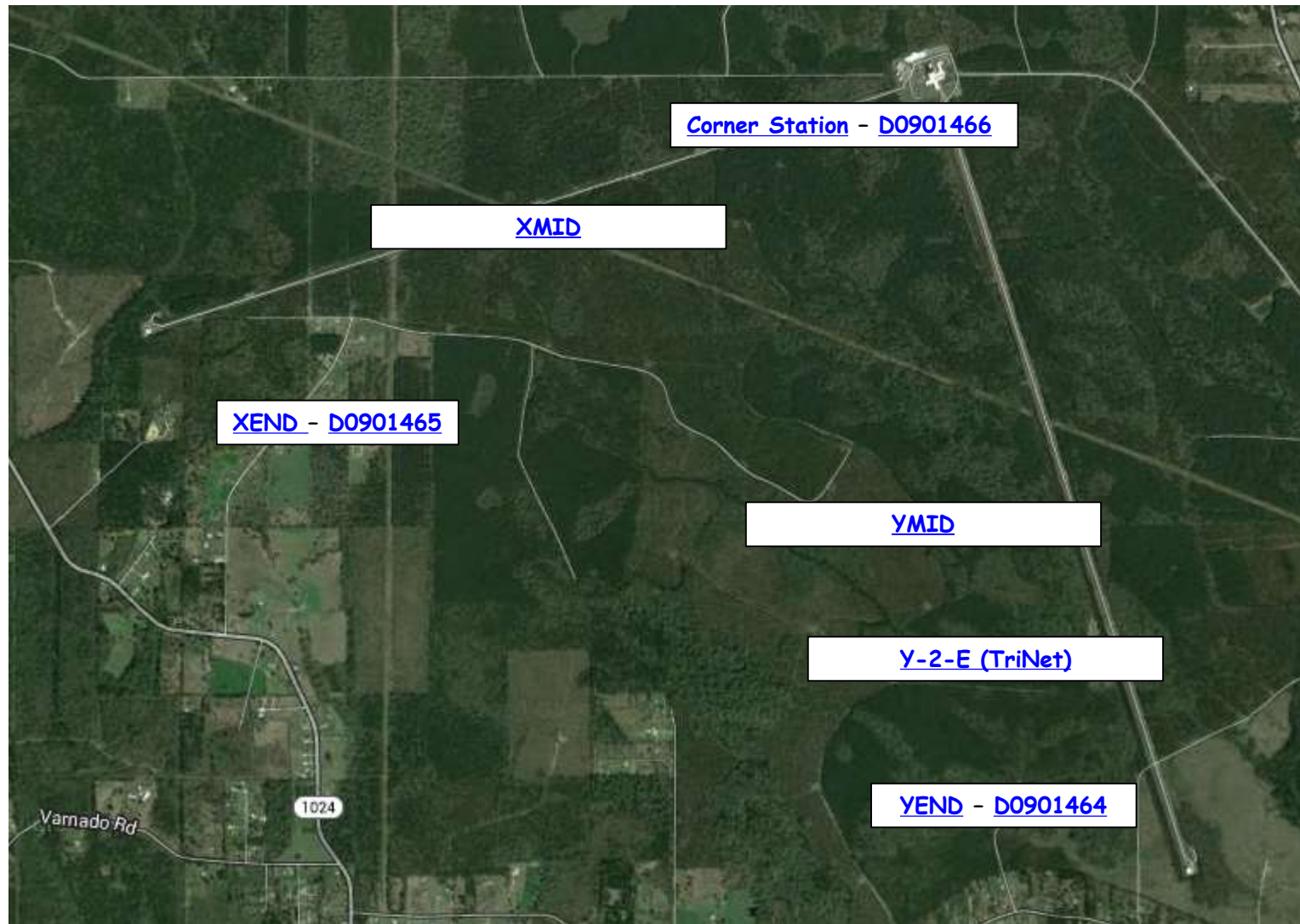

<< LLO Site

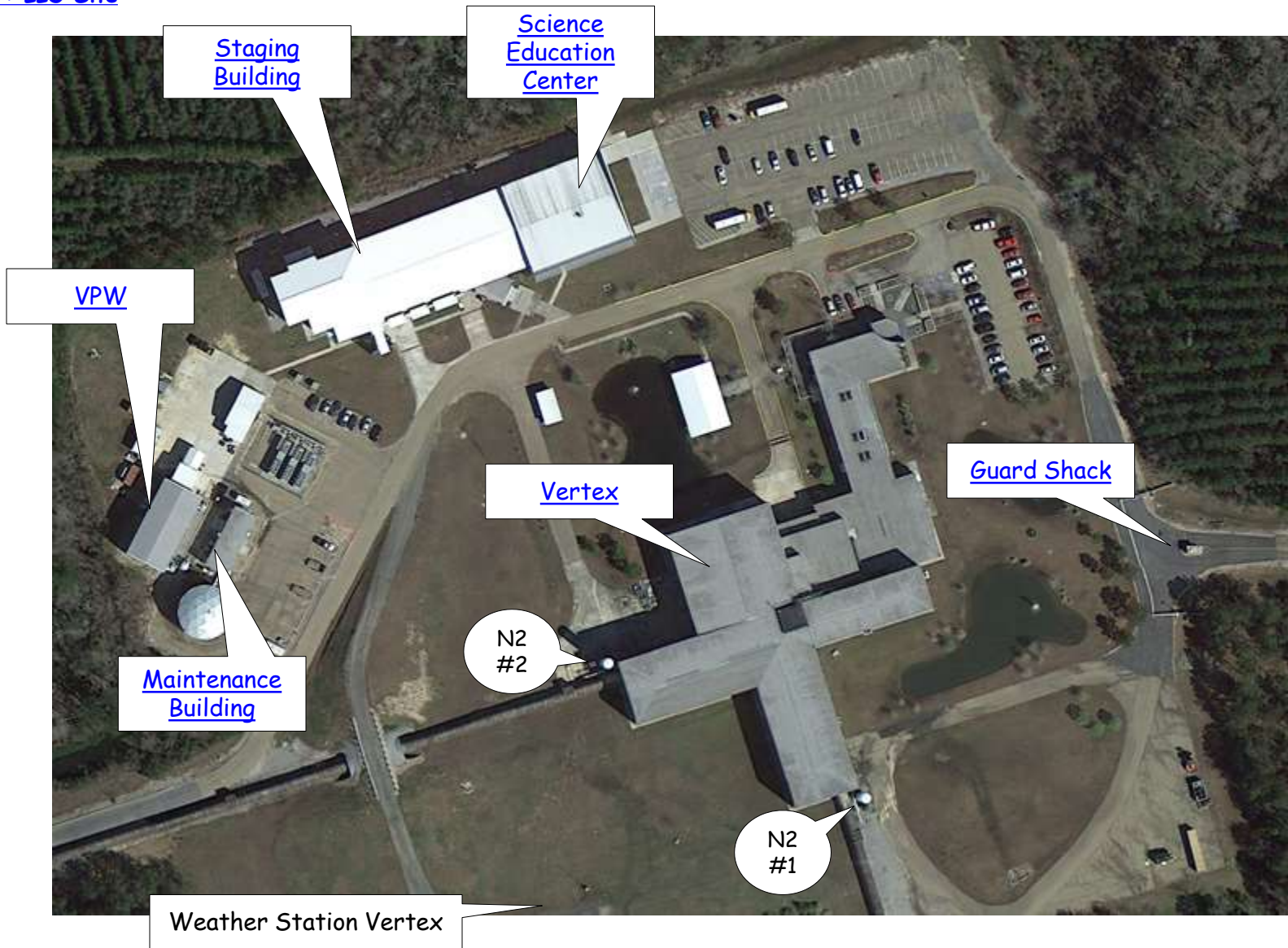



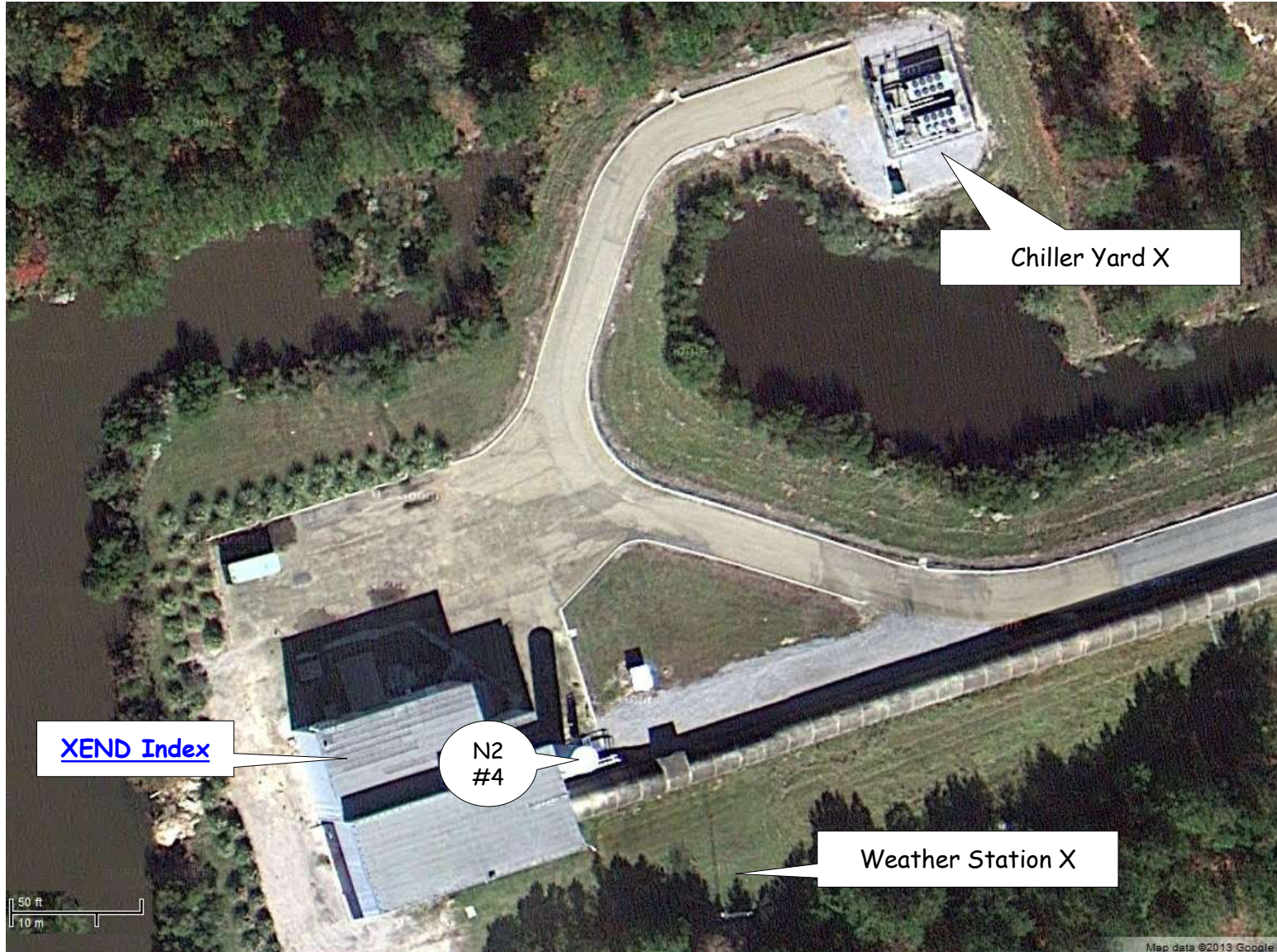

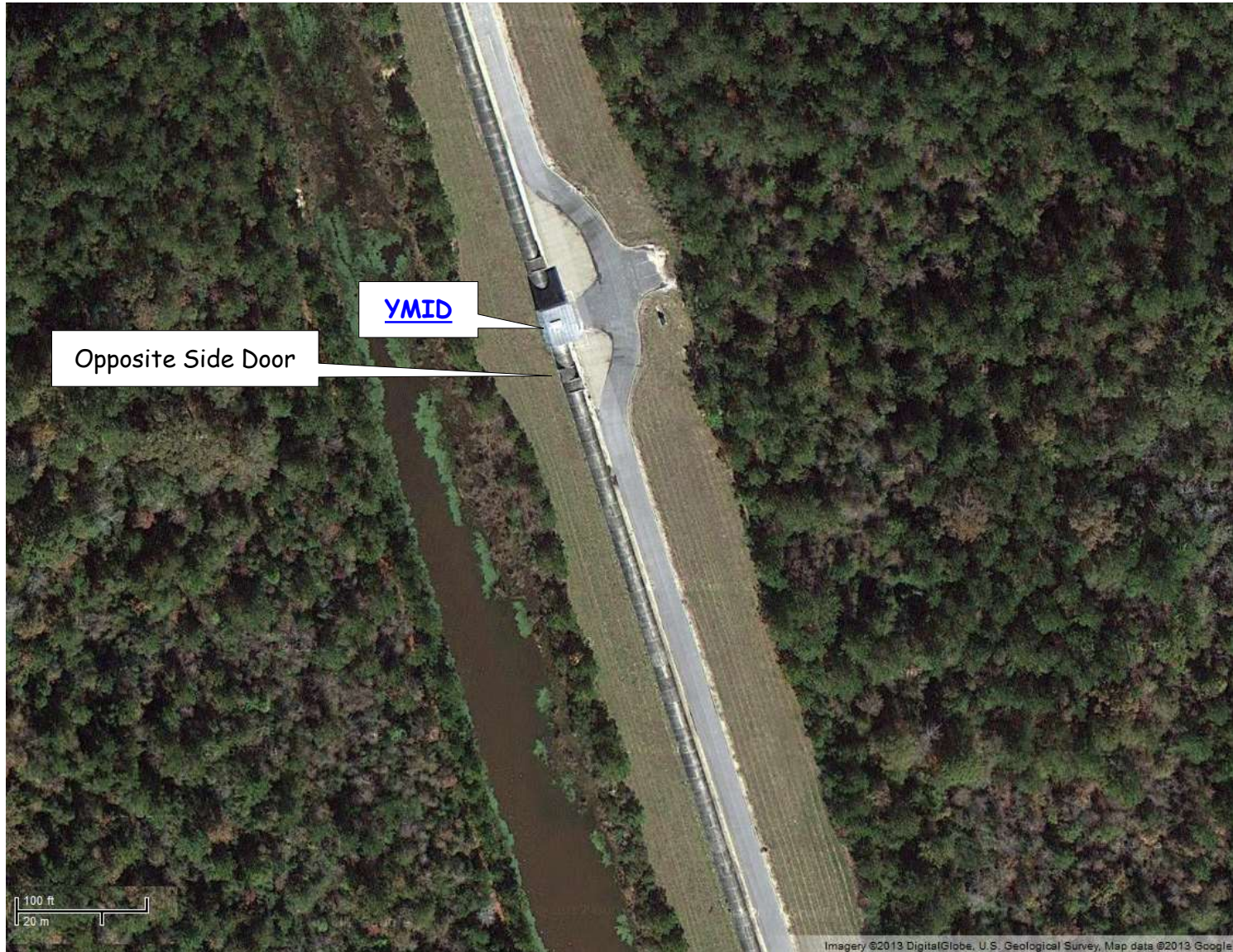



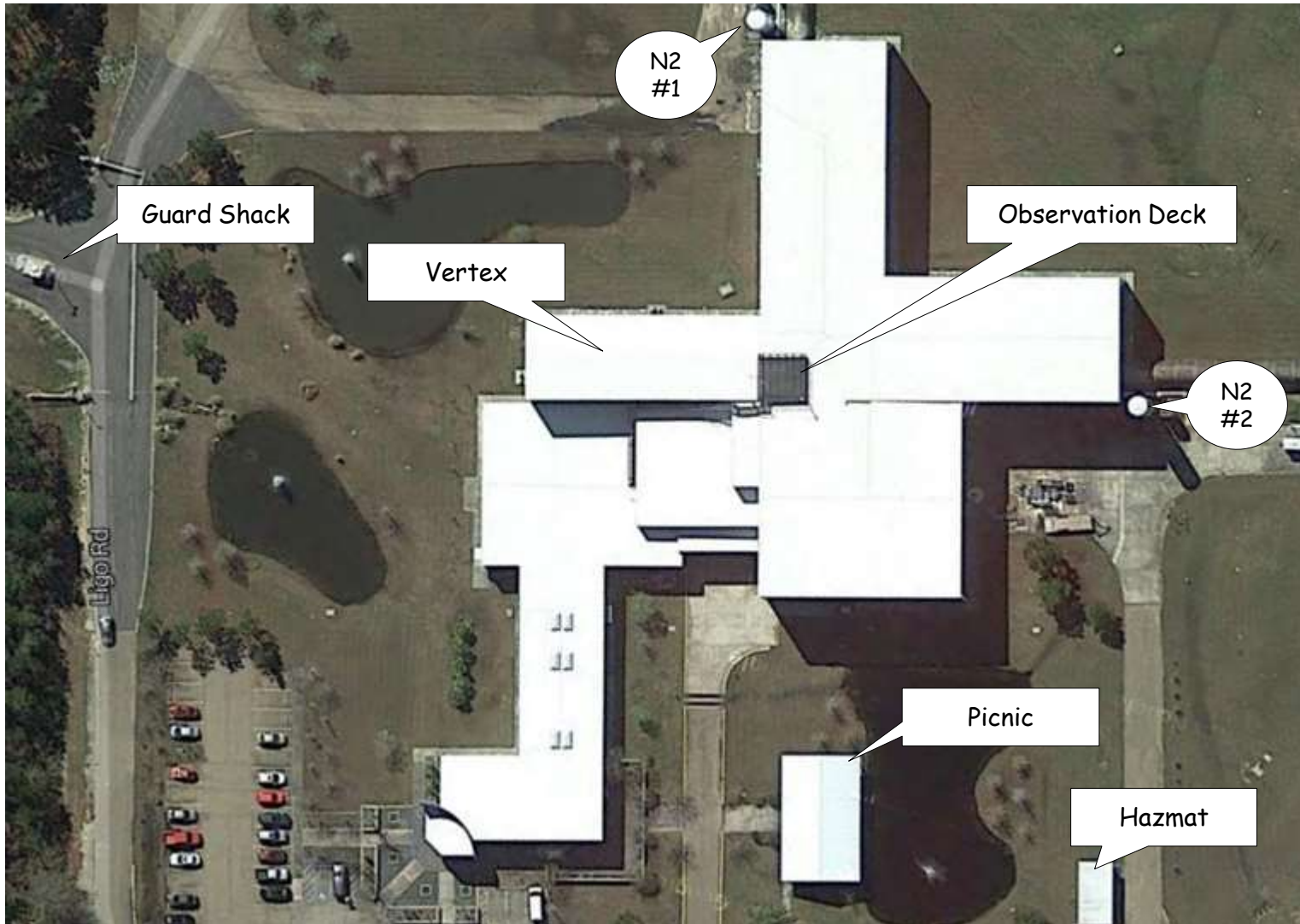

Staging Building and Science Education Center

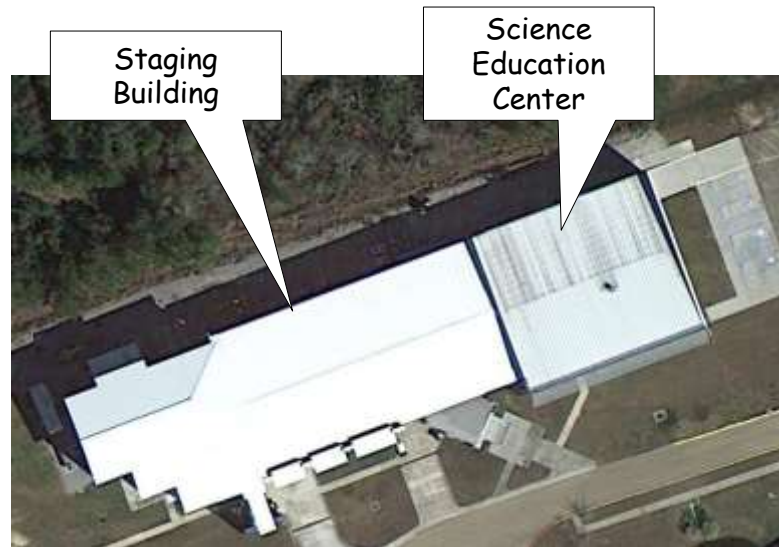



Guard Shack and Gates



[<< Start](#)

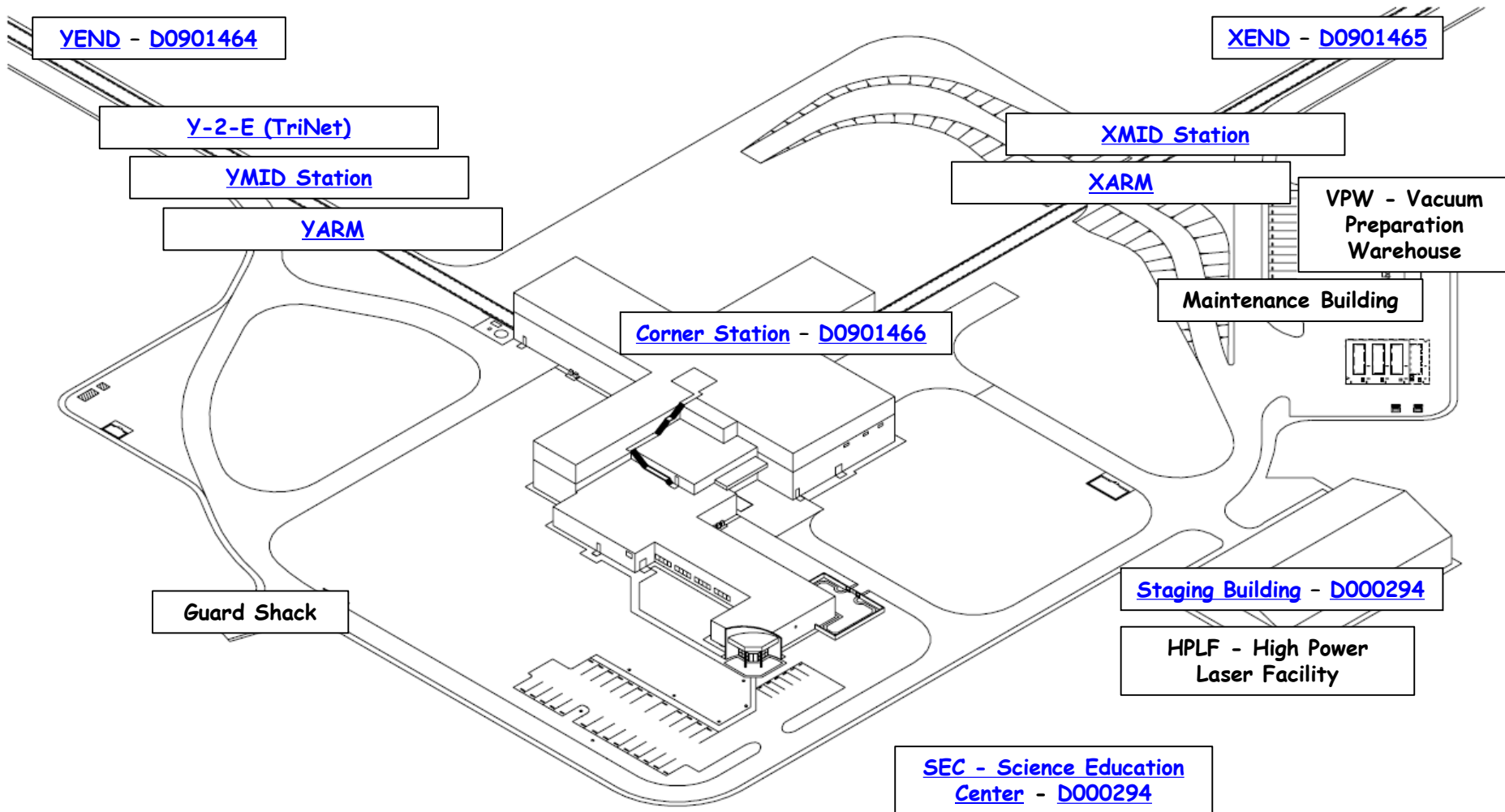

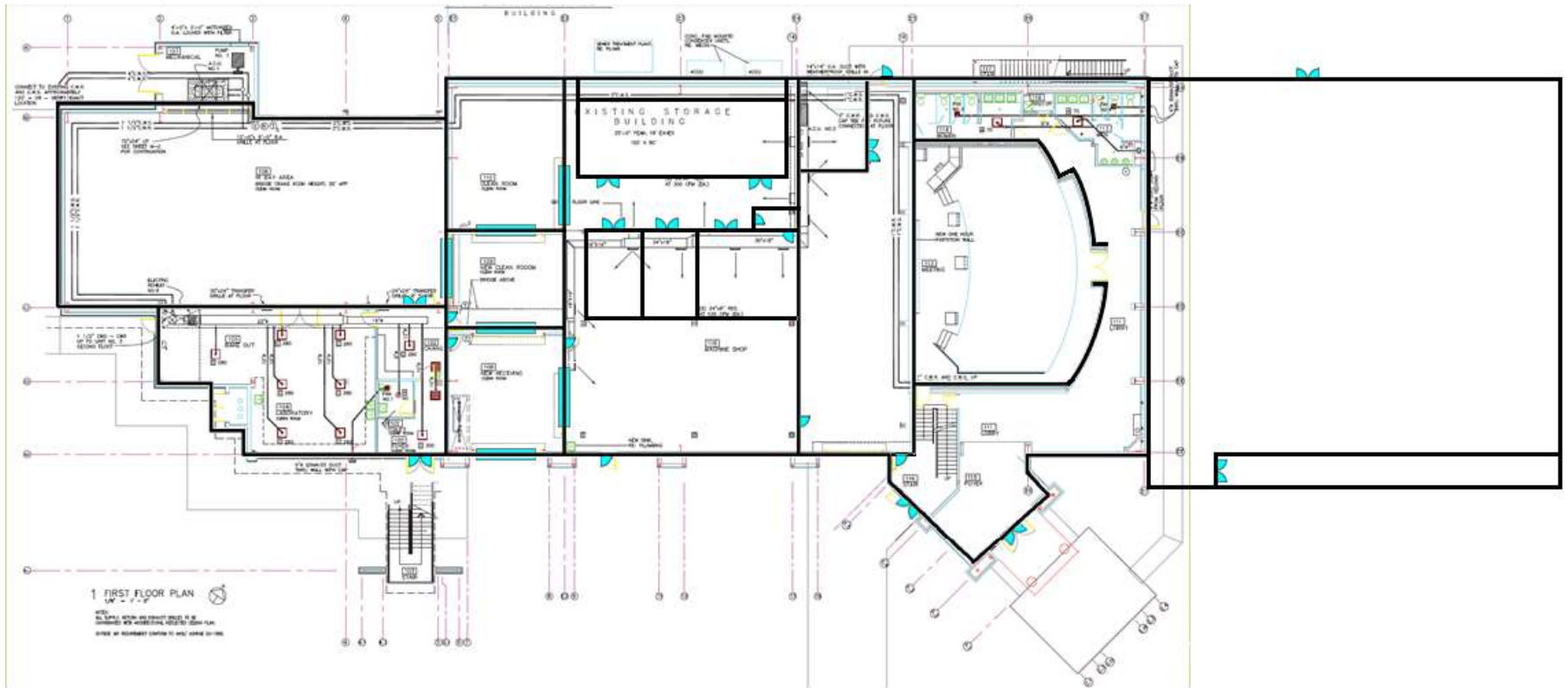

LLO electronics racks are installed in a variety of *LOCATIONS*. Generally speaking, each location houses a specific type of rack. Front-end computers are housed in the [MSR](#). Electronics racks with IO chassis are housed in the [CER](#). Other electronics racks that interface to chambers are located in the [LVEA](#), [XEND](#) and [YEND](#) areas. Power supplies are housed in the [CPR](#). And finally, test racks for electronics are spread throughout the facility, housed wherever they are required.

Operator Control Room (OCR)	CDS Electronics Room (CER)	LVEA Racks (LVEA Racks)	XEND Racks (XEND Racks)	Electronics Test Racks (ETR)
Mass Storage Room (MSR)	Laser Diode Room (LDR)	LVEA Tables (LVEA Tables)	XEND Tables (XEND Tables)	Other Areas (Other)
Computer User Room (CUR)	CDS Power Room (CPR)	Mechanical Room Racks (Mech Racks)	YEND Racks (YEND Racks)	
			YEND Tables (YEND Tables)	

I/O Subsystems are another way to view the racks that are installed in a variety of locations. Generally speaking, each subsystem has racks that are positioned in several physical locations. The subsystems are: AOS, DAQ, ISC, PSL, SEI, SUS, VAC, and VDC. TCS is a part of AOS. PEM and OAF are part of DAQ. HEPI is part of SEI.

<p>Auxiliary Optics CER:(AOS / TCS) LVEA:(AOS / TCS) CERX:(AOS / TCS) VEAX:(AOS / TCS) CERY:(AOS / TCS) VEAY:(AOS / TCS) MECH:(AOS / TCS)</p>	<p>Pre-stabilized Laser CER:(PSL) LVEA:(PSL) CERX:(PSL) VEAX:(PSL) CERY:(PSL) VEAY:(PSL)</p>	<p>Vacuum CER:(VAC) LVEA:(VAC) CERX:(VAC) VEAX:(VAC) CERY:(VAC) VEAY:(VAC) MECH:(VAC)</p>
<p>Interferometer Sensing and Control CER:(ISC) LVEA:(ISC) CERX:(ISC) VEAX:(ISC) CERY:(ISC) VEAY:(ISC)</p>	<p>Seismic Isolation CER:(SEI) LVEA:(SEI) CERX:(SEI) VEAX:(SEI) CERY:(SEI) VEAY:(SEI)</p>	<p>DC Power CER:(VDC) LVEA:(VDC) CERX:(VDC) VEAX:(VDC) CERY:(VDC) VEAY:(VDC)</p>
<p>Data Acquisition CER:(DAQ / PEM / OAF) LVEA:(DAQ / PEM / OAF) CERX:(DAQ / PEM / OAF) VEAX:(DAQ / PEM / OAF) CERY:(DAQ / PEM / OAF) VEAY:(DAQ / PEM / OAF) PEM Categories</p>	<p>Suspensions CER:(SUS) LVEA:(SUS) CERX:(SUS) VEAX:(SUS) CERY:(SUS) VEAY:(SUS)</p>	<p>Facilities CER:(FAC) LVEA:(FAC) CERX:(FAC) VEAX:(FAC) CERY:(FAC) VEAY:(FAC)</p>

<< Start

<< LLO Corner Station

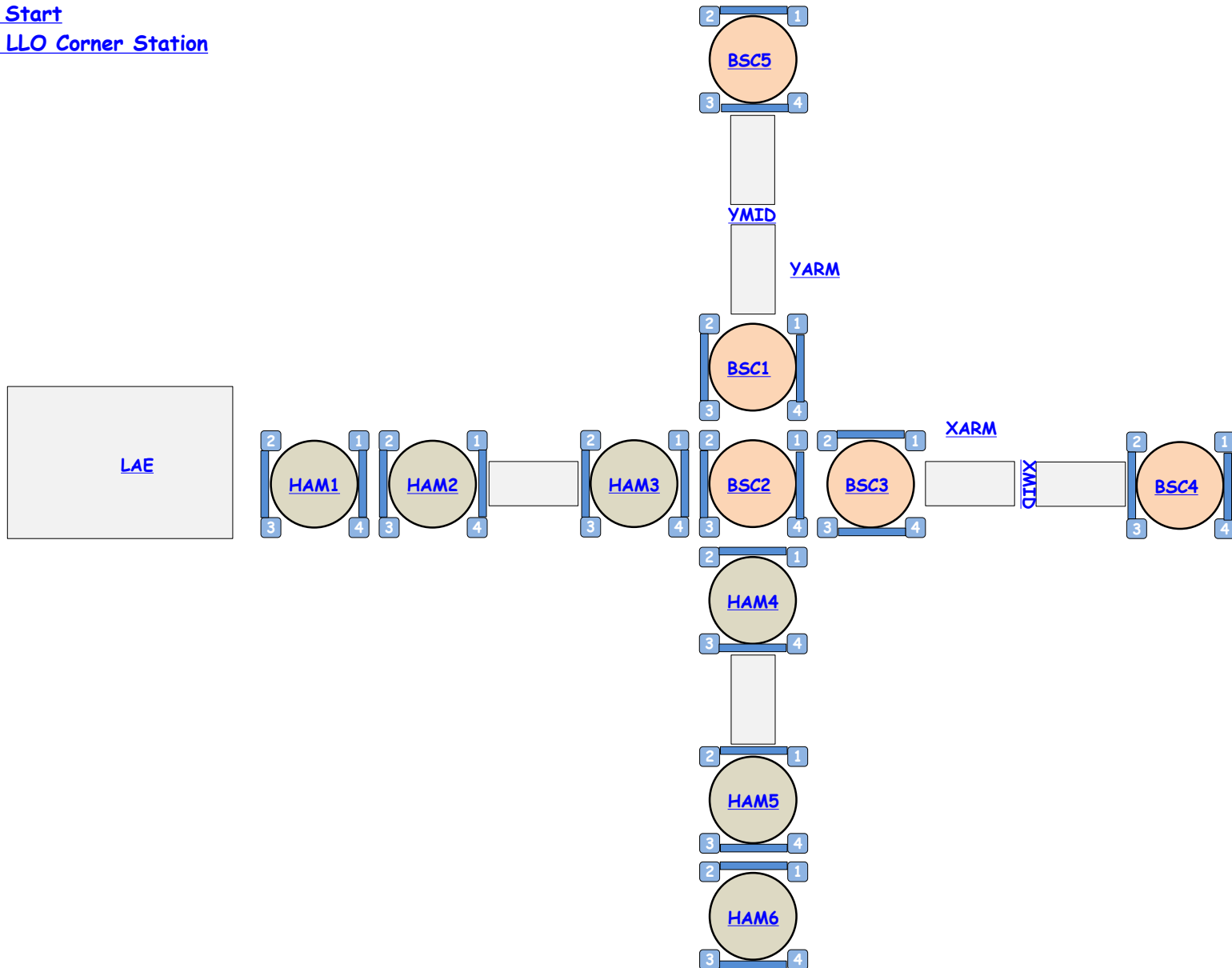

[<< Start](#)[<< LLO Corner Station](#)

- [HAM1 Flange Layout](#) - L1 Horizontal Access Module1 [D1002884](#)
- [HAM2 Flange Layout](#) - L1 Horizontal Access Module 2 [D1002885](#)
- [HAM3 Flange Layout](#) - L1 Horizontal Access Module 3 [D1002886](#)
- [HAM4 Flange Layout](#) - L1 Horizontal Access Module 4 [D1002887](#)
- [HAM5 Flange Layout](#) - L1 Horizontal Access Module 5 [D1002888](#)
- [HAM6 Flange Layout](#) - L1 Horizontal Access Module 6 [D1002890](#)
- [BSC1 Flange Layout](#) - L1 Beam Splitter Chamber 1 (ITMY) [D1003088](#)
- [BSC2 Flange Layout](#) - L1 Beam Splitter Chamber 2 (BS) [D1003089](#)
- [BSC3 Flange Layout](#) - L1 Beam Splitter Chamber 3 (ITMX) [D1003090](#)
- [BSC4 Flange Layout](#) - L1 Beam Splitter Chamber 4 (ETMX) [D1003091](#)
- [BSC5 Flange Layout](#) - L1 Beam Splitter Chamber 5 (ETMY) [D1003092](#)

Viewports are named in [T1000746](#)

Chamber Flanges are named in [D1002892](#)

Flanges are indexed in [E1200755](#)

Flanges are also documented in [D1002870](#)

Feedthroughs are documented in [D1101775](#)

Flange Types are also named in [D1101775](#)

LLO Rack Naming Scheme

CDS racks are named according to site, IFO designation, subsystem use, station (location) and sequence. (See [G1001030](#))

Site	Description	IFO	Subsystem	Description	Station	Description	Rack Number
L	Livingston	1	AOS	Auxiliary Optics	C	[Corner] Common	1
H	Hanford	2	DAQ	Data Acquisition	MS	Mass Storage	2
M	MIT		ETR	Electronics Test Rack	R	[Corner] Remote (Field)	3
C	CIT		FAC	Facilities and Infrastructure	XC	ENDX Common	4
			ISC	IFO Sensing and Control	XR	ENDX Remote [Field]	5
			LDR	Laser Diode Room	YC	ENDY Common	6
			OAF	Online Adaptive Filtering	YR	ENDY Remote [Field]	7
			PEM	Physical Environment Monitoring			8
			PSL	Pre-stabilized Laser			9
			SEI	Seismic Isolation			10
			SUS	Suspensions			11
			TCS	Thermal Compensation System			12
			VAC	Vacuum			etc.
			VDC	Voltage - DC			

LLO CDS Electronics Rack Names

<< Start

CDS racks are named according to site, IFO designation, subsystem use, station (location) and sequence. (See [G1001030](#))

Rack	Rack Designator	Subsystem	Location	Comment	Rack Type	Dxxxxxxx	Sxxxxxxx
1	L1-AOS-C1	AOS	CER		Standard	D1201119	S1202974
2	L1-TCS-R1	AOS	LVEA		Standard	D1201122	S1202975
3	L1-TCS-R2	AOS	LVEA		Standard	D1201123	S1202976
4	L1-TCS-XC1	AOS	CERX		Standard	D1201129	S1202980
5	L1-TCS-YC1	AOS	CERY		Standard	D1201130	S1202981
6	L1-OAF-C1	DAQ	CER	OAF/PEM	Standard	D1200941	S1202404
7	L1-DAQ-XC1	DAQ	CERX		Standard	D1201085	S1202949
8	L1-DAQ-YC1	DAQ	CERY		Standard	D1201092	S1202956
9	L1-ISC-C1	ISC	CER		Standard	D1200949	S1201186
10	L1-ISC-C2	ISC	CER		Standard	D1200975	S1201187
11	L1-ISC-C3	ISC	CER		Standard	D1200976	S1201188
12	L1-ISC-C4	ISC	CER		Standard	D1200977	S1201189
13	L1-ISC-R1	ISC	LVEA		Standard	D1001460	S1201192
14	L1-ISC-R2	ISC	LVEA		Standard	D1001425	S1201193
15	L1-ISC-R3	ISC	LVEA		Standard	D1001426	S1201194
16	L1-ISC-R4	ISC	LVEA		Standard	D1101904	S1201195
17	L1-ISC-R5	ISC	LVEA		Standard	D1200196	S1201196
18	L1-ISC-XC1	ISC	CERX		Standard	D1201084	S1202948
19	L1-ISC-YC1	ISC	CERY		Standard	D1201091	S1202955
20	L1-ISC-XR1	ISC	VEAX		Standard	D1201087	S1202951
21	L1-ISC-YR1	ISC	VEAY		Standard	D1201094	S1202958
22	L1-ETR-04	OPTICS	Test Rack	Optics Electronics Lab Rack	IIU		
23	L1-LDR-C1	PSL	LDR		Vendor		
24	L1-LDR-C2	PSL	LDR		Vendor		
25	L1-PSL-C1	PSL	CER		Standard	D1201118	S1202977
26	L1-PSL-R1	PSL	LVEA		Standard	D1201120	S1202978
27	L1-PSL-R2	PSL	LVEA		Standard	D1201121	S1202979
28	L1-SEI-C1	SEI	CER	SET HAM 1 and HAM 6	Standard	D1201112	S1200743
29	L1-SEI-C2	SEI	CER	SET HAM 2 and HAM 3	Standard	D1201113	S1200744
30	L1-SEI-C3	SEI	CER	SET HAM 4 and HAM 5	Standard	D1201114	S1200745
31	L1-SEI-C4	SEI	CER	SET BCS1	Standard	D1201115	S1200746
32	L1-SEI-C5	SEI	CER	SET BCS2	Standard	D1201116	S1200747
33	L1-SEI-C6	SEI	CER	SET BCS3	Standard	D1201117	S1200748
34	L1-SEI-XC1	SEI	CERX	SET BCS4	Standard	D1201081	S1202945
35	L1-SEI-YC1	SEI	CERY	SET BCS5	Standard	D1201088	S1202952
36	L1-ETR-05	SEI	Test Rack	HAM ISI Electronics Test Rack			
37	L1-ETR-07	SEI	Test Rack	Triple Electronics Test Rack			
38	L1-SUS-C1	SUS	CER	SUS ITM, FM, and BS (1 of 2)	Standard	D1200856	S1104062
39	L1-SUS-C2	SUS	CER	SUS ITM, FM, and BS (2 of 2)	Standard	D1200859	S1104356
40	L1-SUS-C3	SUS	CER	SUS HAM 2 (1 of 2)	Standard	D1200864	S1104357
41	L1-SUS-C4	SUS	CER	SUS HAM 2 (2 of 2)	Standard	D1200867	S1104358
42	L1-SUS-C5	SUS	CER	SUS ITMX, ITMY, and BS (1 of 2)	Standard	D1200874	S1105375
43	L1-SUS-C6	SUS	CER	SUS ITMX, ITMY, and BS (2 of 2)	Standard	D1200875	S1105376
44	L1-SUS-C7	SUS	CER	SUS HAM 5 and HAM 6 (1 of 2)	Standard	D1200876	S1105377
45	L1-SUS-C8	SUS	CER	SUS HAM 5 and HAM 6 (2 of 2)	Standard	D1200877	S1105378
46	L1-SUS-R1	SUS	LVEA		Standard	D1200879	S1200749
47	L1-SUS-R2	SUS	LVEA		Standard	D1200880	S1200750
48	L1-SUS-R3	SUS	LVEA		Standard	D1200883	S1202300

49	L1-SUS-R4	SUS	LVEA		Standard	D1201134	S1202995
50	L1-SUS-R5	SUS	LVEA		Standard	D1201135	S1202996
51	L1-SUS-R6	SUS	LVEA		Standard	D1201136	S1202997
52	L1-SUS-XC1	SUS	CERX		Standard	D1201082	S1202946
53	L1-SUS-XC2	SUS	CERX		Standard	D1201083	S1202947
54	L1-SUS-XR1	SUS	VEAX		Standard	D1201131	S1202993
55	L1-SUS-YC1	SUS	CERY		Standard	D1201089	S1202953
56	L1-SUS-YC2	SUS	CERY		Standard	D1201090	S1202954
57	L1-SUS-YR1	SUS	VEAY		Standard	D1201132	S1202994
58	L1-ETR-02	SUS	Test Rack	BSC Electronics Test Rack			
59	L1-ETR-03	SUS	Test Rack	RM Electronics Test Rack			
60	L1-ETR-06	SUS	Test Rack	STS Huddle Electronics Test Rack			
61	L1-VAC-R1	VAC	LVEA	Vacuum Rack - X Arm	Knurr		
62	L1-VAC-R2	VAC	LVEA	Vacuum Rack - Y Arm	Knurr		
63	L1-VAC-R3	VAC	Mechanical Room	Vacuum Rack - Mechanical Room	Knurr		
64	L1-VAC-XR1	VAC	VEAX	Vacuum Rack - X End	Knurr		
65	L1-VAC-YR1	VAC	VEAY	Vacuum Rack - Y End	Knurr		
66	L1-VDC-C1	VDC	CPR		DC	D1200890	S1105247
67	L1-VDC-C2	VDC	CPR		DC	D1200891	S1105248
68	L1-VDC-C3	VDC	CPR		DC	D1200892	S1105249
69	L1-VDC-C4	VDC	CPR		DC	D1200893	S1105250
70	L1-VDC-C5	VDC	CPR		DC	D1200894	S1105251
71	L1-VDC-C6	VDC	CPR		DC	D1200895	S1105252
72	L1-VDC-C7	VDC	CPR		DC	D1200896	S1105253
73	L1-VDC-C8	VDC	CPR	Planned	DC	D1201137	S1202998
74	L1-VDC-XC1	VDC	CERX		DC	D1200897	S1202311
75	L1-VDC-XC2	VDC	CERX		DC	D1200898	S1202312
76	L1-VDC-YC1	VDC	CERY		DC	D1200899	S1202313
77	L1-VDC-YC2	VDC	CERY		DC	D1200900	S1202314
78	L1-MSR-01	CDS	MSR	Atomic Clock	Knurr	D1201372	S1203487
79	L1-MSR-02	CDS	MSR	Fiber Patch	Knurr	D1201373	S1203488
80	L1-MSR-03	CDS	MSR	EPICS	Knurr	D1201374	S1203489
81	L1-MSR-04	CDS	MSR	EPICS	Knurr	D1201375	S1203490
82	L1-MSR-05	CDS	MSR	Backup Tape	Knurr	D1201376	S1203491
83	L1-MSR-06	CDS	MSR	Video	Knurr	D1201377	S1203492
84	L1-MSR-07	CDS	MSR	IFO Front End Computers	Standard	D1201378	S1203493
85	L1-MSR-08	CDS	MSR	IFO Front End Computers	Standard	D1201379	S1203494
86	L1-MSR-09	CDS	MSR	CDS Computers	Standard	D1201380	S1203495
87	L1-MSR-10	CDS	MSR	CDS Computers	Standard	D1201381	S1203496
88	L1-MSR-11	CDS	MSR	General Computing	Standard	D1201382	S1203497
89	L1-MSR-12	CDS	MSR	DAQ Electronics Test Rack	Standard	D1201383	S1203498
90	L1-MSR-13	CDS	MSR	UPS for IFO and CDS Computers	Linier	D1201384	S1203499
91	L1-FAC-C1	FAC	CER		Standard	D1200940	S1202403
92	L1-FAC-XC1	FAC	CERX		Standard	D1201086	S1202950
93	L1-FAC-YC1	FAC	CERY		Standard	D1201093	S1202957
94	L1-UNK-C1	CER			Standard	D1201356	S1203450
95	L1-UNK-C2	CER			Standard	D1201357	S1203451
96	L1-UNK-C3	CER			Standard	D1201358	S1203452

LLO CDS Components

<< Start

Racks and Rooms (RAR)

YEND Racks (YEND)

Field Satellite Racks

LVEA Racks (LVEA)

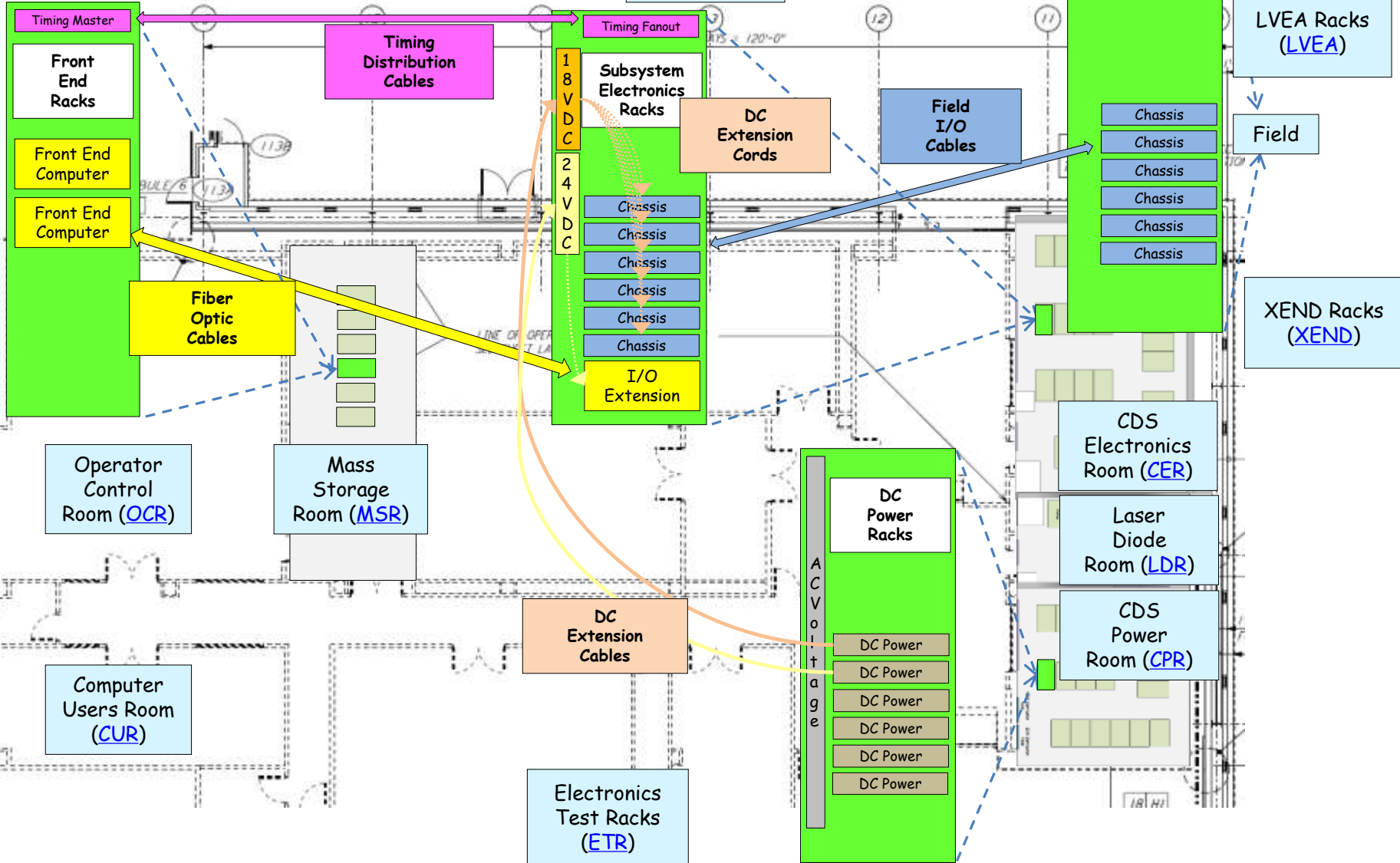

Field

XEND Racks (XEND)

CDS Electronics Room (CER)

Laser Diode Room (LDR)

CDS Power Room (CPR)

DC Power Racks

DC Power
DC Power
DC Power
DC Power
DC Power

DC Extension Cables

Electronics Test Racks (ETR)

Operator Control Room (OCR)

Mass Storage Room (MSR)

Computer Users Room (CUR)

Timing Master

Front End Racks

Front End Computer

Front End Computer

Fiber Optic Cables

Timing Distribution Cables

Subsystem Electronics Racks

1 8 V D C

2 4 V D C

Chassis

Chassis

Chassis

Chassis

Chassis

Chassis

I/O Extension

DC Extension Cords

Field I/O Cables

Chassis

Chassis

Chassis

Chassis

Chassis

Chassis

Chassis

Chassis

Chassis

A C V o l t a g e

DC Power

DC Power

DC Power

DC Power

DC Power

DC Power

DC Power

DC Power

[<< Locations](#)

[YEND - D0901464](#)

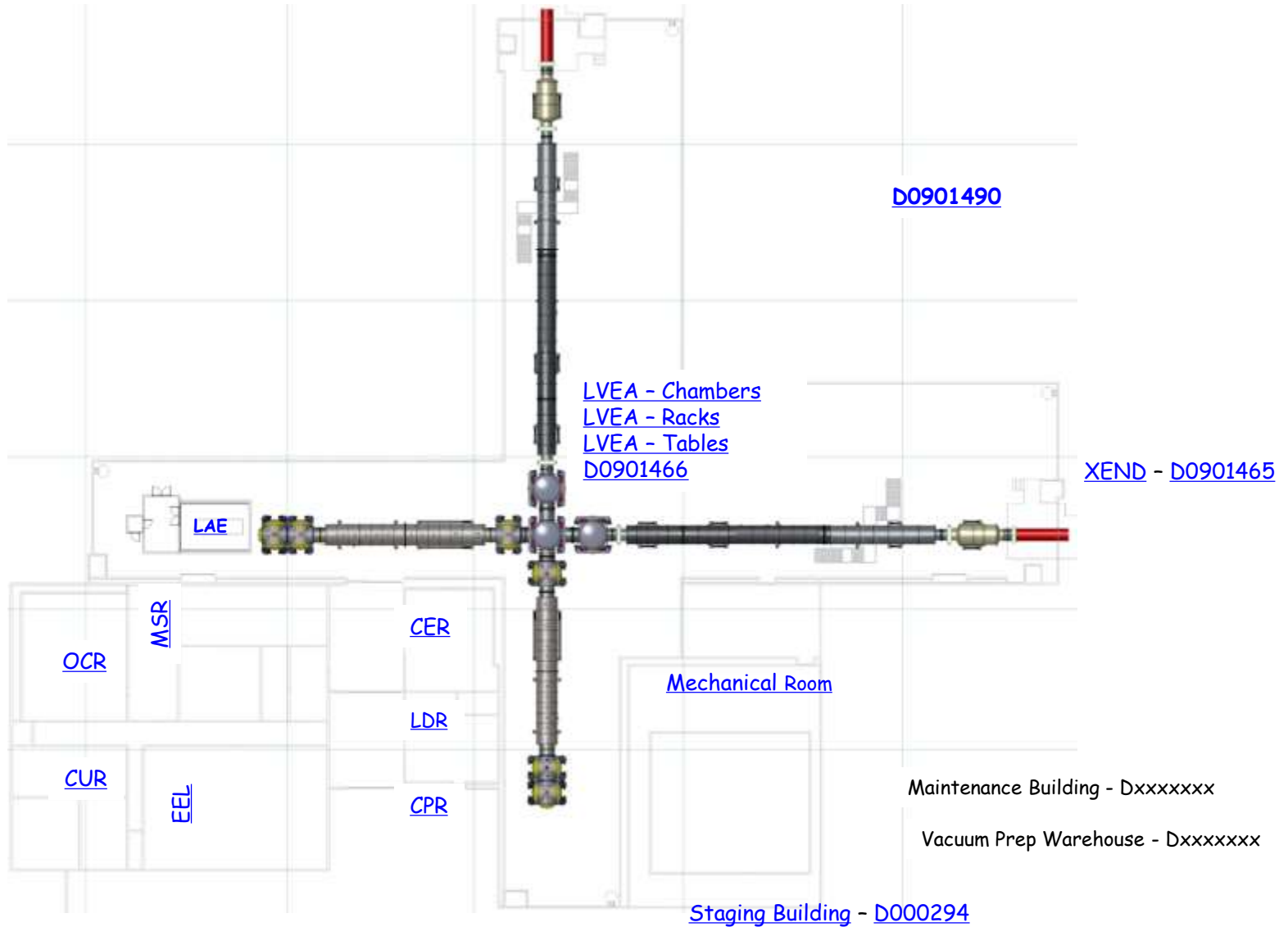

LAE

LAE Documentation

[<< LLO Corner Station](#)

[<< LLO Racks by AREA](#)

[<< LLO CDS Components](#)

OCR

[OCR Documentation](#)

<< OCR

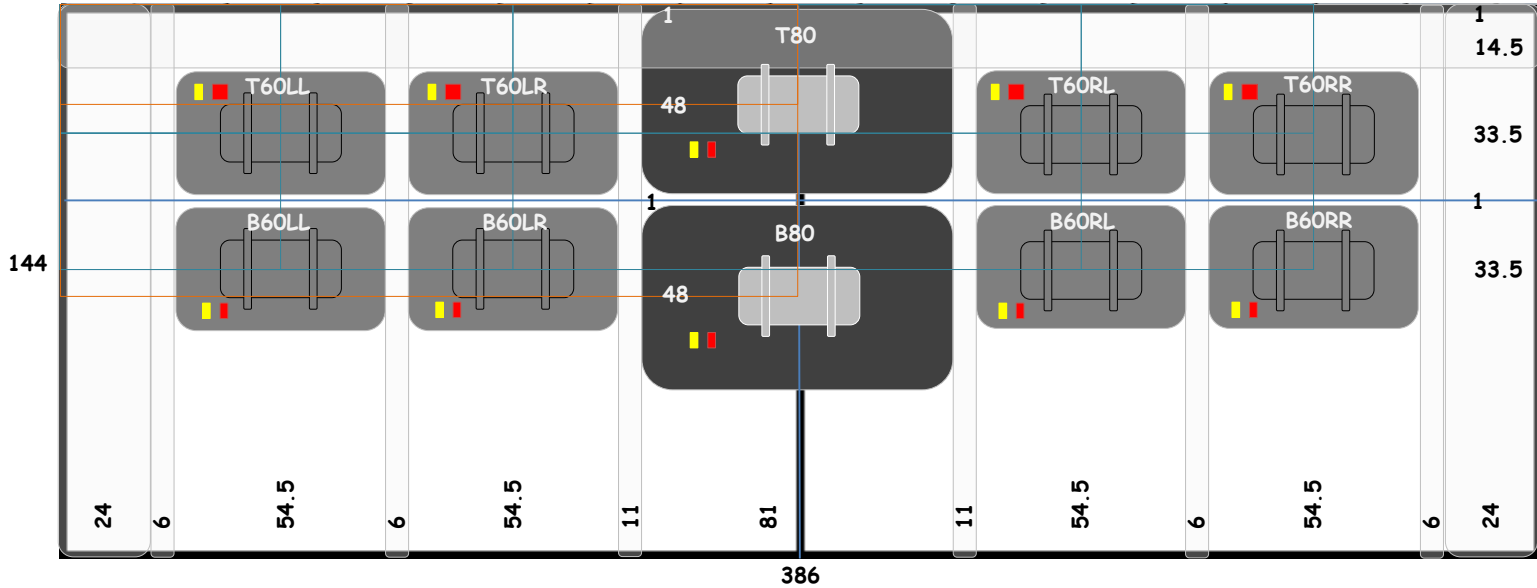

Item	Center X (From Left Wall)	Center Y (From Ceiling)	Circuit
T60LL	57.375	32.250	Q:CS175-RP-01:13
T60LR	118.125	32.250	Q:CS175-RP-01:15
T80	192.000	25.000	D:CS175-RP-01:25
T60RL	265.875	32.250	Q:CS175-RP-01:8
T60RR	326.625	32.250	Q:CS175-RP-01:10
B60LL	57.375	66.750	D:CS175-RP-01:13
B60LR	118.125	66.750	D:CS175-RP-01:15
B80	192.000	74.000	D:CS175-RP-01:25
B60RL	265.875	66.750	D:CS175-RP-01:8
B60RR	326.625	66.750	D:CS175-RP-01:10

<< OCR

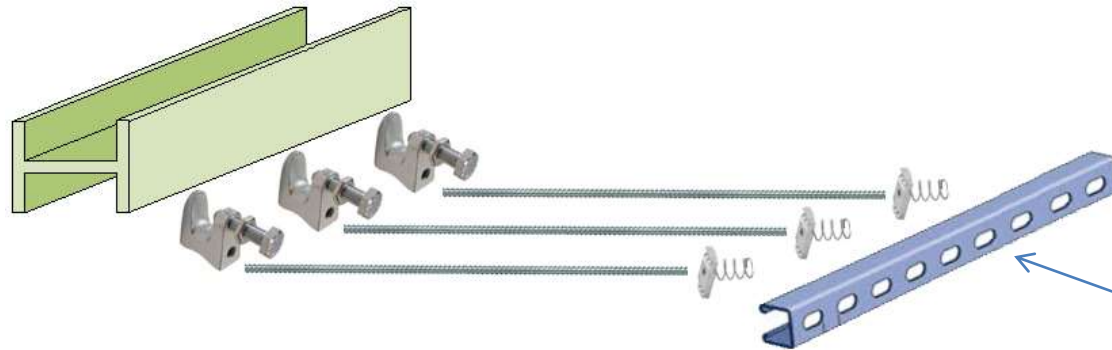

Unistrut is used to reinforce the front wall.

Two lengths of unistrut are used to support each monitor. They are bolted to the wall from the crawl space between the front wall and the LVEA wall.

Beam Clamps and Allthread are used as a brace.

On one of the unistruts (see diagram) allthread and beam clamps are evenly positioned and clamped to the I-beam structure of the building. This is to provide stability for the front wall.

Clamps are attached to this unistrut

Unistrut

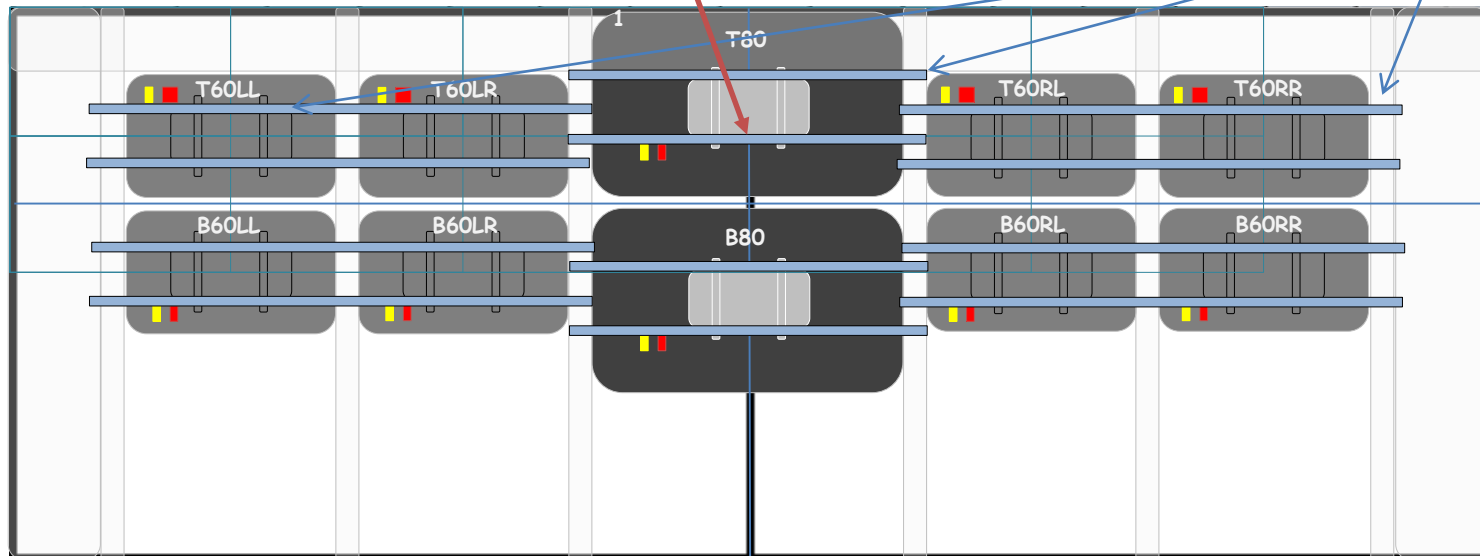

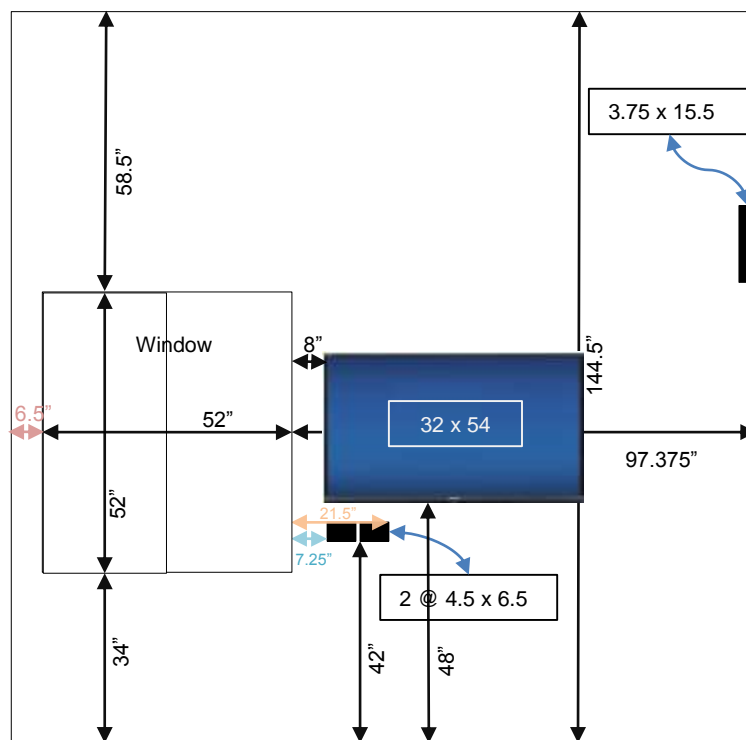

OCR West Side Wall Layout

<< OCR

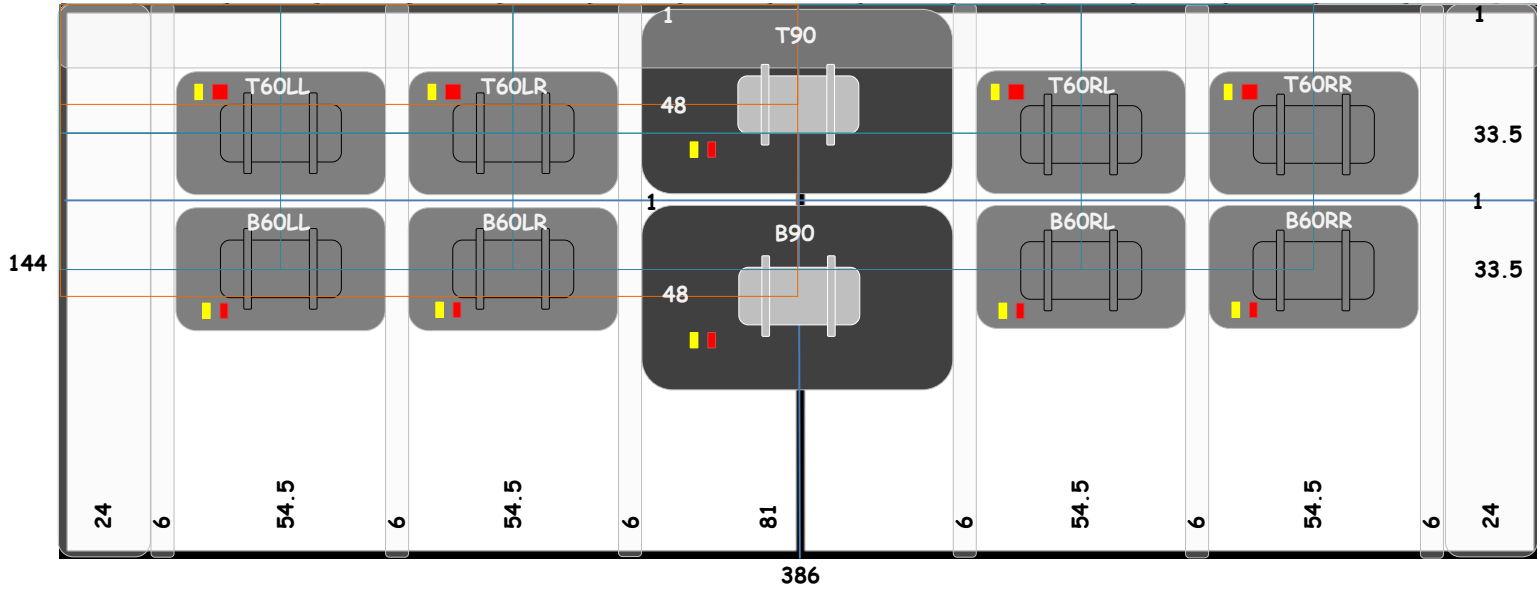

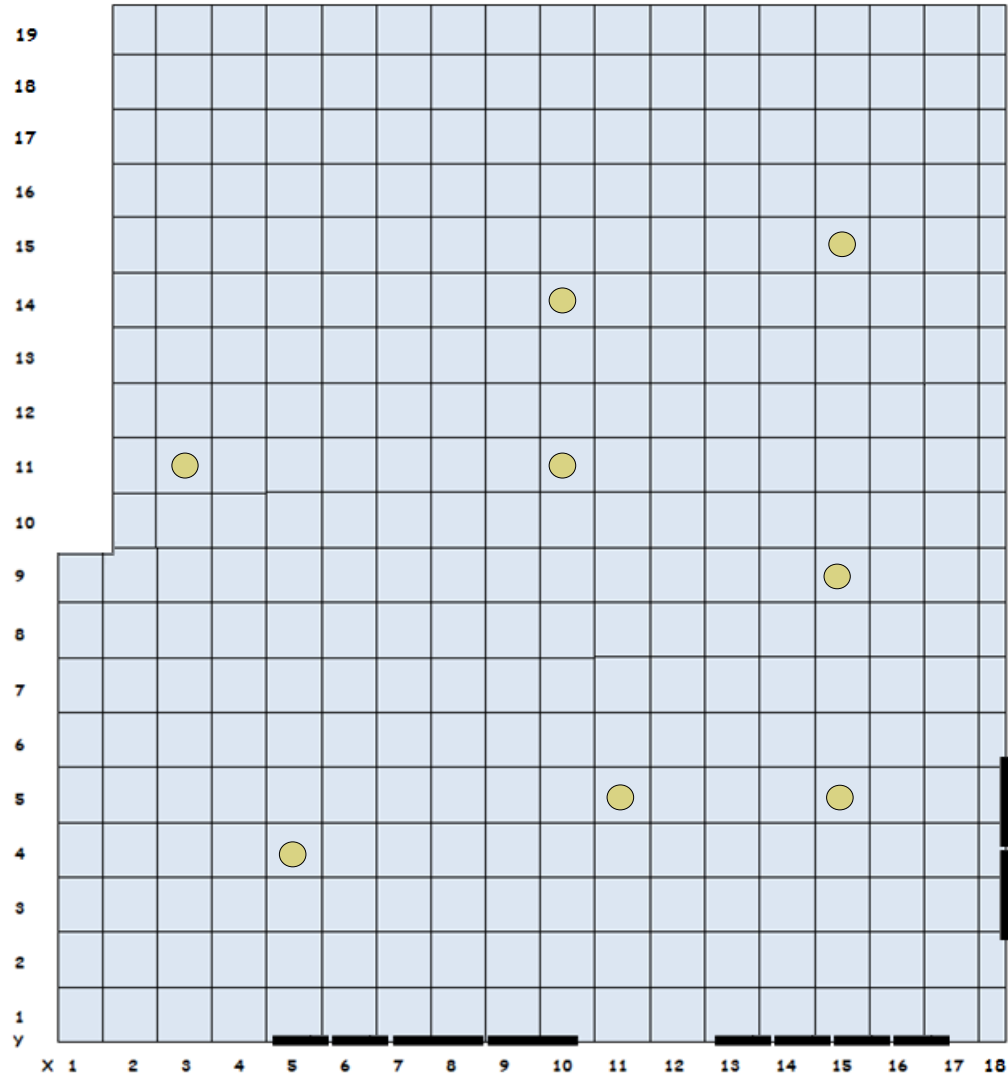

[<< LLO Corner Station](#)

[<< LLO Racks by AREA](#)

[<< LLO CDS Components](#)

CUR

[CUR Documentation](#)

- [<< LLO Corner Station](#)
- [<< LLO Racks by AREA](#)
- [<< LLO CDS Components](#)

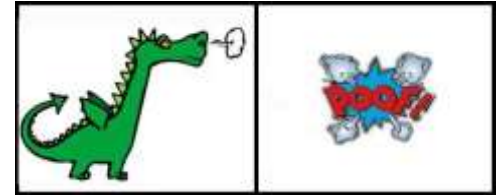

EEL

EEL Documentation

EEL (EE Lab) Layout

AC Power to the benches:

Twelve 12) new circuits from RP2 power the Orange, White, Green, and Red benches.

Under the floor:

Provide two locations of four (4) circuits in one Quad 'D':

- 1) Each Socket is a 15A 110VAC circuit.
- 2) Each circuit serves a power strip on a bench.

Provide two locations of two (2) circuits each in a Single 'D':

- 1) Each Single outlet is a 20A 110VAC circuit.
- 2) Each circuit serves a Double-Double 'D' mounted to a bench.

Attached to the benches:

- 1) Attached to each bench is a Double-Double 'D' mounted on the far right underside of the work surface (facing the bench from the front). This box is on a flexible cord that plugs in beneath the floor and is long enough to allow some freedom of movement of the bench.

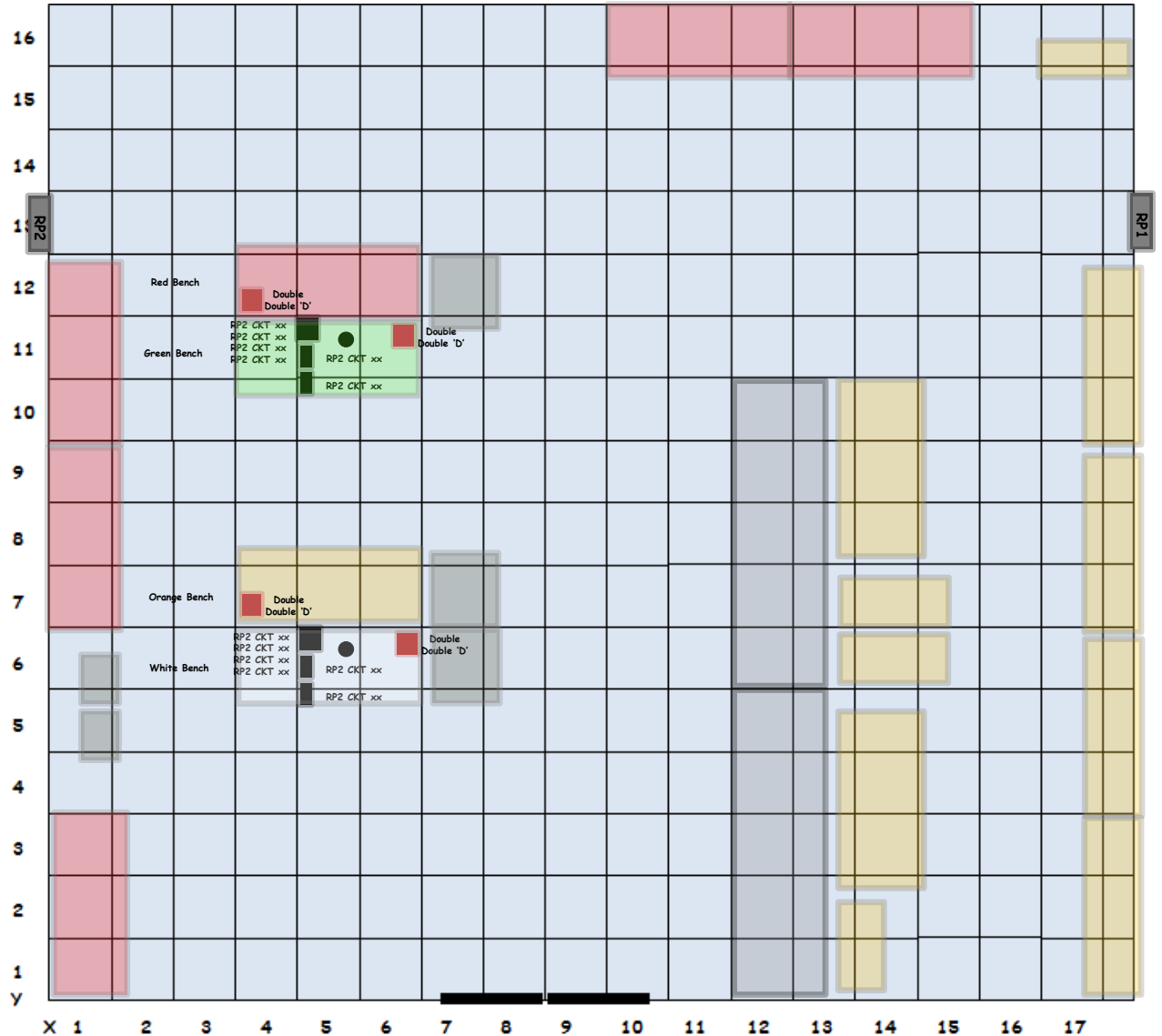

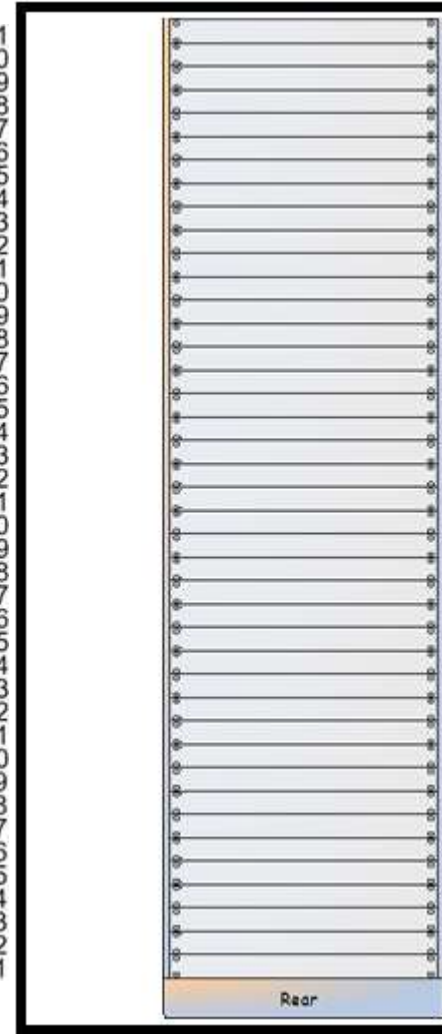

[<< LLO Corner Station](#)

[<< LLO Racks by AREA](#)

[<< LLO CDS Components](#)

MSR

[MSR Documentation](#)

[MSR Layout](#)

[IO Extenders Index](#)

MSR (Mass Storage Room) Layout

- << LLO Corner Station
- << LLO Racks by AREA
- << LLO CDS Components

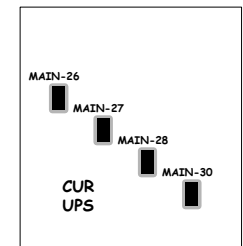
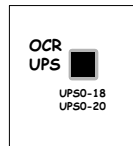
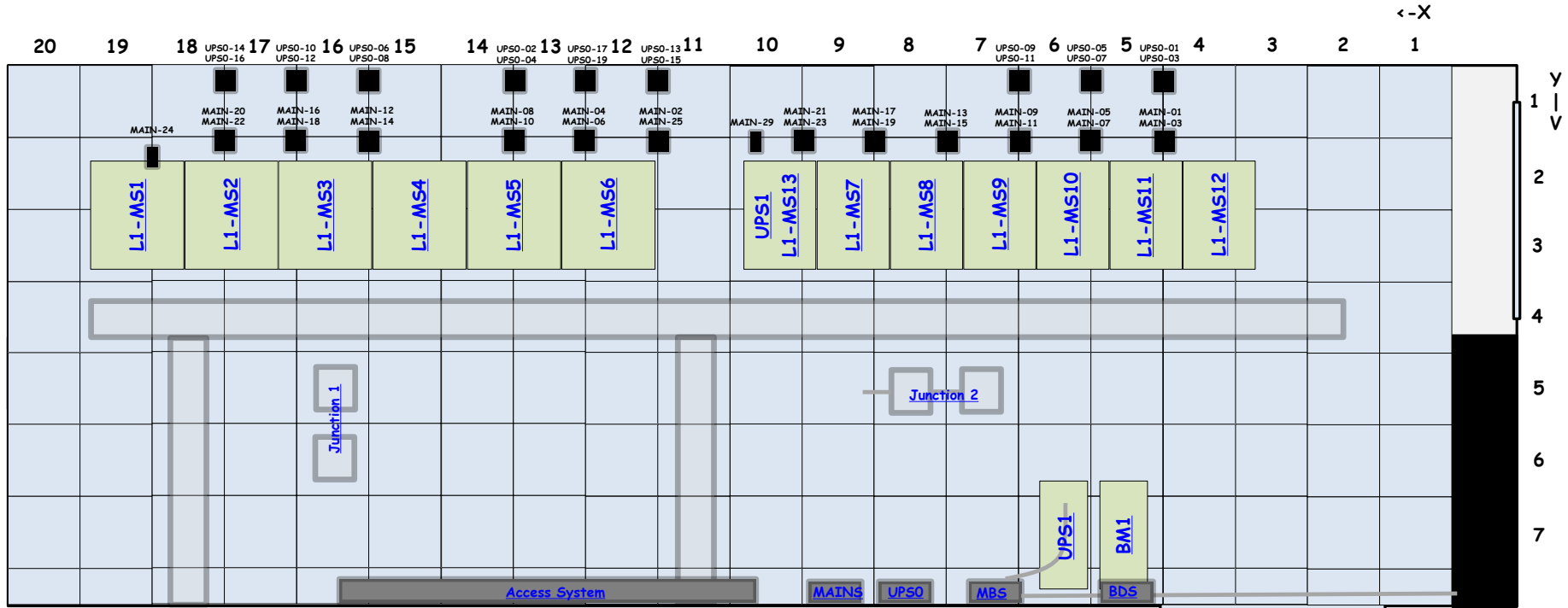

<< MSR Layout

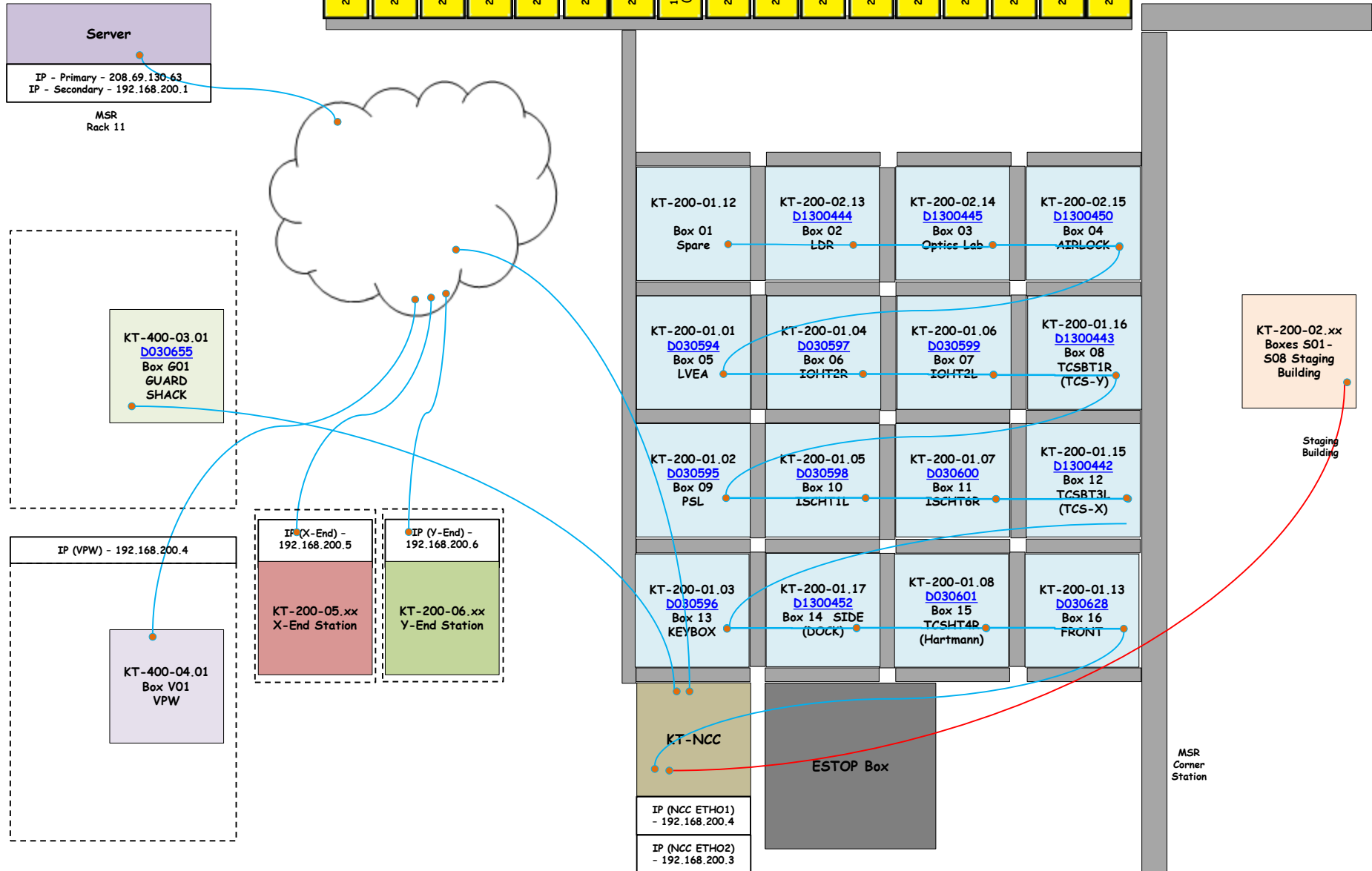

MSR Power Panels

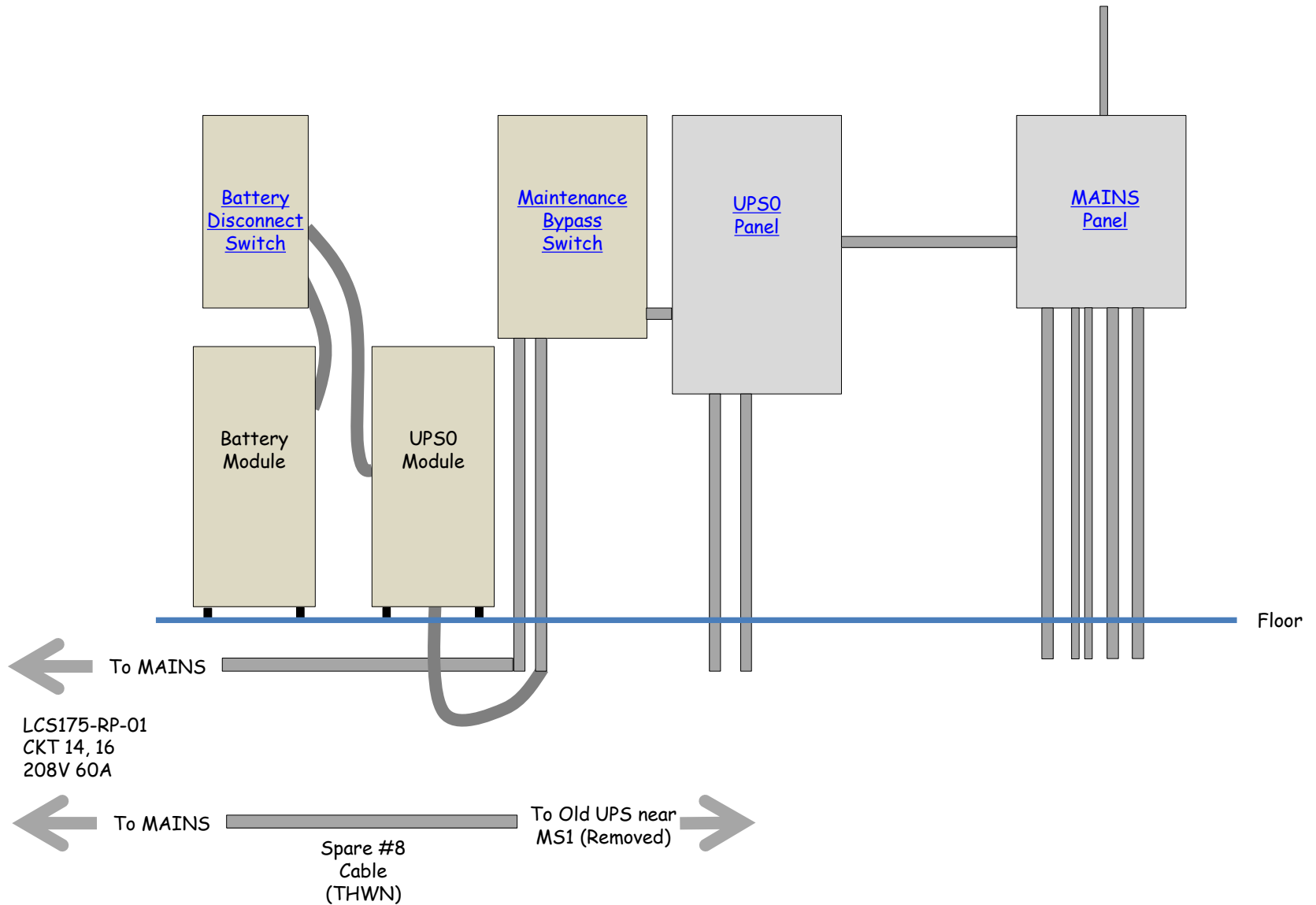



Panel	Circuit	Circuit Voltage	Breaker Amperage	Outlet Box Label	Type	Outlet Amperage	Outlet Color	Outlet Strip	Rack
UPS Panel	1	110	20	UPS CKT 1	DD 5-20R	110VAC 20A	Orange	Open	Open
UPS Panel	2	110	20	UPS CKT 2	DD 5-20R	110VAC 20A	Orange	20A-009	MS4-2
UPS Panel	3	110	20	UPS CKT 3	DD 5-20R	110VAC 20A	Orange	Open	Open
UPS Panel	4	110	20	UPS CKT 4	DD 5-20R	110VAC 20A	Orange	20A-011	MS4-1
UPS Panel	5	110	20	UPS CKT 5	DD 5-20R	110VAC 20A	Orange	20A-028	MS11-1
UPS Panel	6	110	20	UPS CKT 6	DD 5-20R	110VAC 20A	Orange	20A-004	MS3-1
UPS Panel	7	110	20	UPS CKT 7	DD 5-20R	110VAC 20A	Orange	20A-045	MS11-2
UPS Panel	8	110	20	UPS CKT 8	DD 5-20R	110VAC 20A	Orange	20A-003	MS3-2
UPS Panel	9	110	20	UPS CKT 9	DD 5-20R	110VAC 20A	Orange	20A-047	MS10-2
UPS Panel	10	110	20	UPS CKT 10	DD 5-20R	110VAC 20A	Orange	20A-002	MS2-1
UPS Panel	11	110	20	UPS CKT 11	DD 5-20R	110VAC 20A	Orange	20A-048	MS10-1
UPS Panel	12	110	20	UPS CKT 12	DD 5-20R	110VAC 20A	Orange	20A-001	MS2-2
UPS Panel	13	110	20	UPS CKT 13	DD 5-20R	110VAC 20A	Orange	15A-001	MS6-1
UPS Panel	14	110	20	UPS CKT 14	DD 5-20R	110VAC 20A	Orange	Open	Open
UPS Panel	15	110	20	UPS CKT 15	DD 5-20R	110VAC 20A	Orange	Open	Open
UPS Panel	16	110	20	UPS CKT 16	DD 5-20R	110VAC 20A	Orange	20A-007	MS1-1
UPS Panel	17	110	20	UPS CKT 17	DD 5-20R	110VAC 20A	Orange	20A-005	MS5-1
UPS Panel	18	110	20	UPS CKT 18	DD 5-20R	110VAC 20A	Orange	Operator Desk	OCR X11Y2
UPS Panel	19	110	20	UPS CKT 19	DD 5-20R	110VAC 20A	Orange	20A-008	MS5-2
UPS Panel	20	110	20	UPS CKT 20	DD 5-20R	110VAC 20A	Orange	Operator Desk	OCR X11Y2
									<small>As of 4/9/2013</small>

MAINS Power Panel

<< MSR Power Panels



Panel	Circuit	Circuit Voltage	Breaker Amperage	Outlet Box Label	Type	Outlet Amperage	Outlet Color	Outlet Strip	Destination
MAINS	01	110	20	MAIN CKT 1	DD 5-20R	110VAC 20A	White	15A-005	MS12-2
MAINS	02	110	20	MAIN CKT 2	DD 5-20R	110VAC 20A	White	20A-050	MS7-3
MAINS	03	110	20	MAIN CKT 3	DD 5-20R	110VAC 20A	White	15A-006	MS12-1
MAINS	04	110	20	MAIN CKT 4	DD 5-20R	110VAC 20A	White	20A-014	MS5-1
MAINS	05	110	20	MAIN CKT 5	DD 5-20R	110VAC 20A	White	20A-027	MS11-1
MAINS	06	110	20	MAIN CKT 6	DD 5-20R	110VAC 20A	White	20A-015	MS5-2
MAINS	07	110	20	MAIN CKT 7	DD 5-20R	110VAC 20A	White	20A-046	MS11-2
MAINS	08	110	20	MAIN CKT 8	DD 5-20R	110VAC 20A	White	20A-029	MS4-2
MAINS	09	110	20	MAIN CKT 9	DD 5-20R	110VAC 20A	White	20A-044	MS10-2
MAINS	10	110	20	MAIN CKT 10	DD 5-20R	110VAC 20A	White	20A-010	MS4-1
MAINS	11	110	20	MAIN CKT 11	DD 5-20R	110VAC 20A	White	20A-043	MS10-1
MAINS	12	110	20	MAIN CKT 12	DD 5-20R	110VAC 20A	White	20A-016	MS3-2
MAINS	13	110	20	MAIN CKT 13	DD 5-20R	110VAC 20A	White	20A-025	MS9-2
MAINS	14	110	20	MAIN CKT 14	DD 5-20R	110VAC 20A	White	20A-012	MS3-1
MAINS	15	110	20	MAIN CKT 15	DD 5-20R	110VAC 20A	White	20A-026	MS9-1
MAINS	16	110	20	MAIN CKT 16	DD 5-20R	110VAC 20A	White	20A-013	MS2-1
MAINS	17	110	20	MAIN CKT 17	DD 5-20R	110VAC 20A	White	20A-024	MS8-1
MAINS	18	110	20	MAIN CKT 18	DD 5-20R	110VAC 20A	White	20A-017	MS2-2
MAINS	19	110	20	MAIN CKT 19	DD 5-20R	110VAC 20A	White	20A-018	MS8-2
MAINS	20	110	20	MAIN CKT 20	DD 5-20R	110VAC 20A	White	Open	Open
MAINS	21	110	20	MAIN CKT 21	DD 5-20R	110VAC 20A	White	20A-019	MS7-2
MAINS	22	110	20	MAIN CKT 22	DD 5-20R	110VAC 20A	White	20A-038	MS1-1
MAINS	23	110	20	MAIN CKT 23	DD 5-20R	110VAC 20A	White	20A-020	MS7-1
MAINS	24	110	30	MAIN CKT 24	L6-30R	110VAC 30A	Brown	Single Outlet	Open
MAINS	25	110	20	MAIN CKT 25	DD 5-20R	110VAC 20A	White	15A-002	MS6-1
MAINS	26	110	30	MAIN CKT 26	L6-30R	110VAC 30A	Brown	Single Outlet	CUR-UPS 1
MAINS	27	110	30	MAIN CKT 27	L6-30R	110VAC 30A	Brown	Single Outlet	CUR-UPS 2
MAINS	28	110	30	MAIN CKT 28	L6-30R	110VAC 30A	Brown	Single Outlet	CUR-UPS 4
MAINS	29	110	20	MAIN CKT 29	DD 5-20R	110VAC 20A	White	20A-055	MS9-3
MAINS	30	110	30	MAIN CKT 30	L6-30R	110VAC 30A	Brown	Single Outlet	CUR-UPS 3
MAINS	31/32/33		100						As of 4/9/2013

Battery Module

30 each NPX-150R

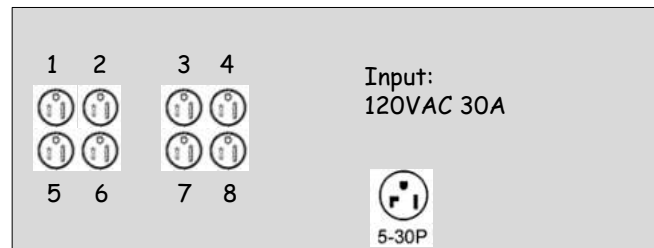

UPS ACP 2200

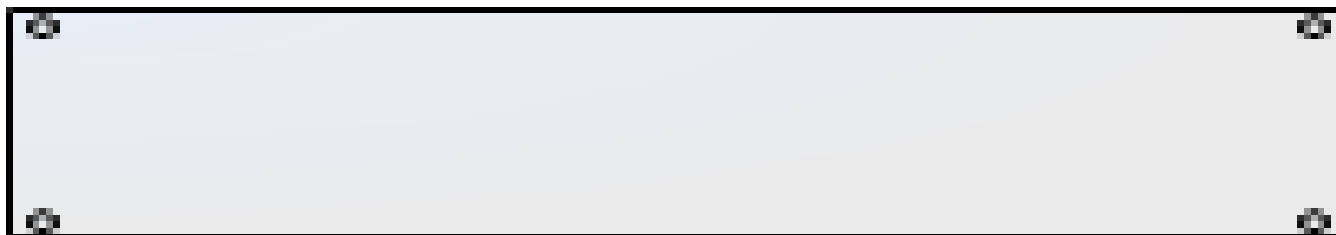
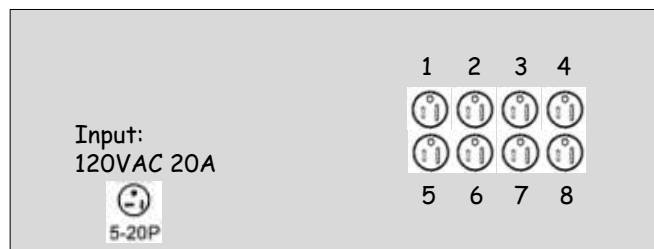

UPS APC 2200XL

UPS

UPS APC 2200XL

SN:

110VAC

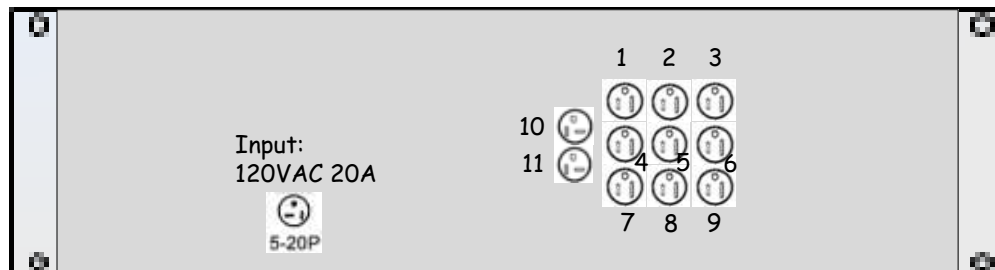
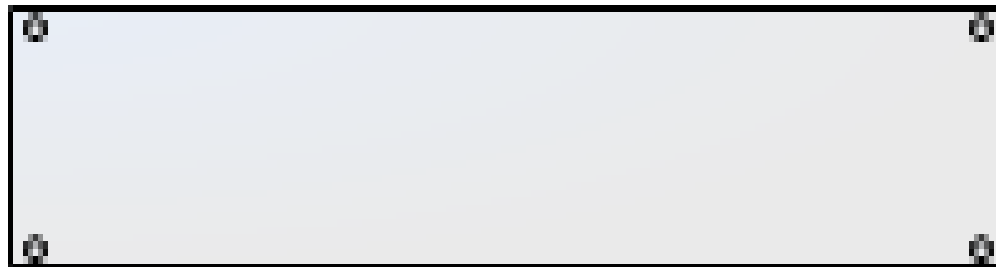

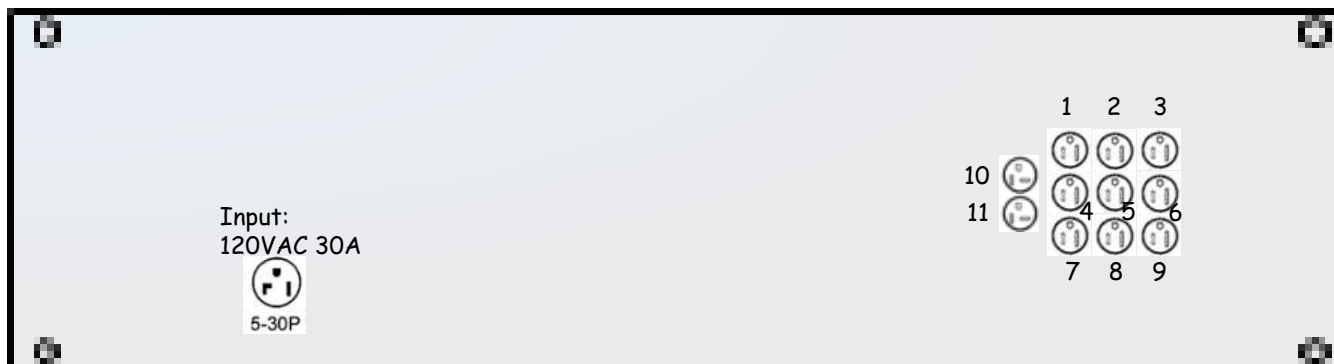

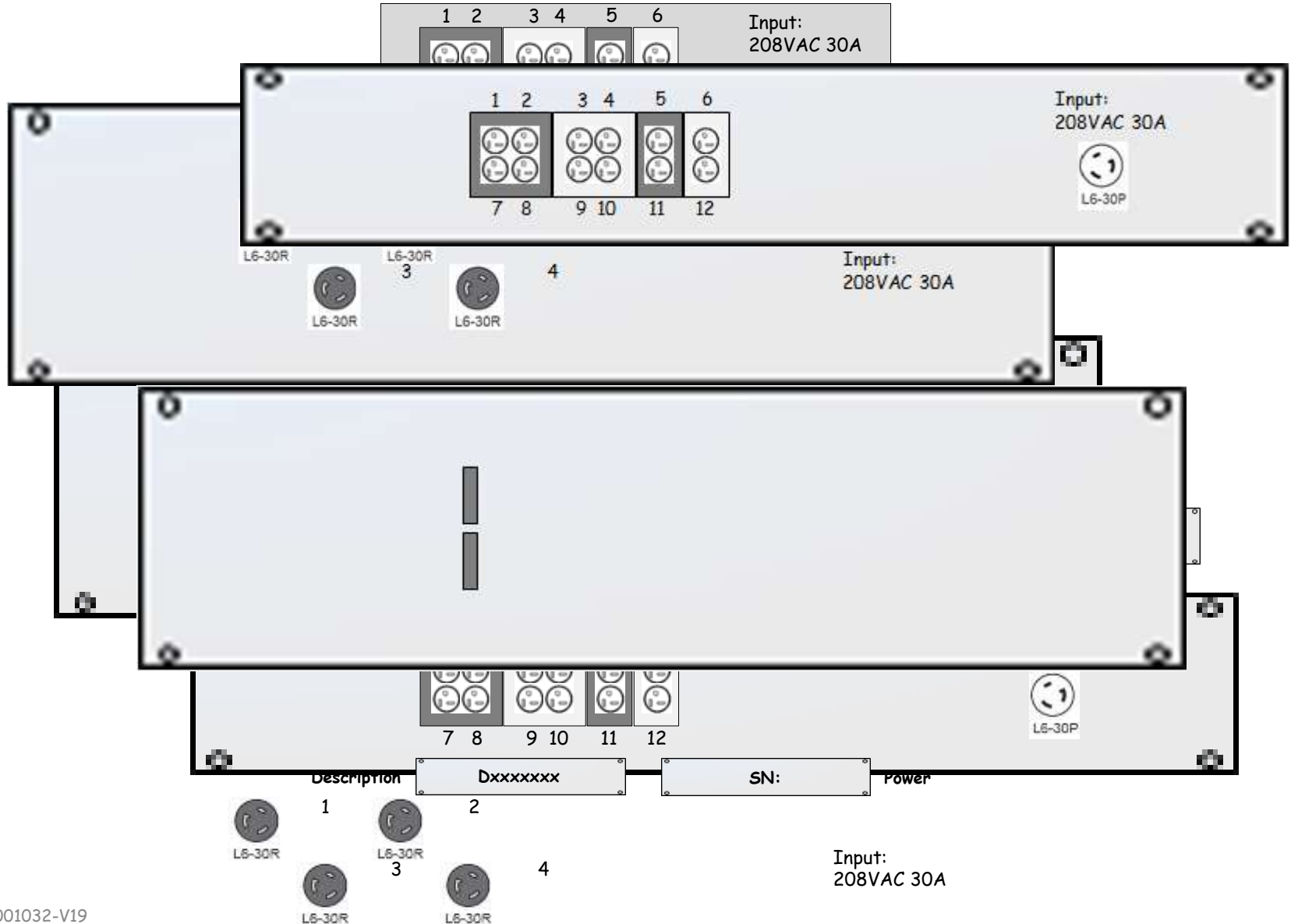

UPS0 Battery Module Switch Box



UPS0 Maintenance Bypass Switch Box



Mains and UPS Subfloor Distribution Boxes

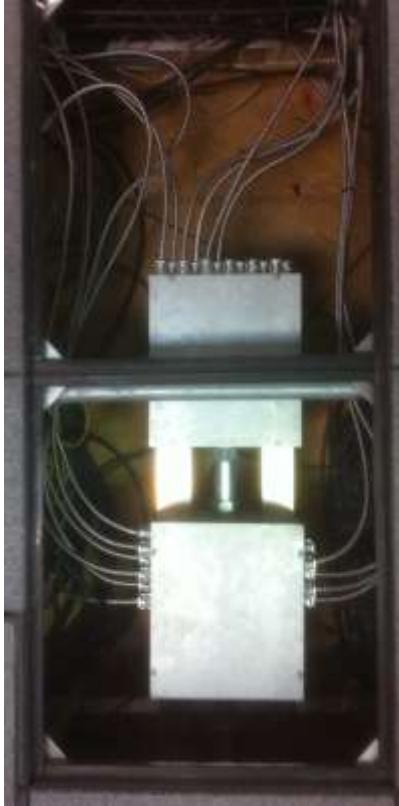

**MAINS and UPSO Subfloor
Distribution Junction 1**



**MAINS and UPSO Subfloor
Distribution Junction 2**



MAINS Floor Penetration

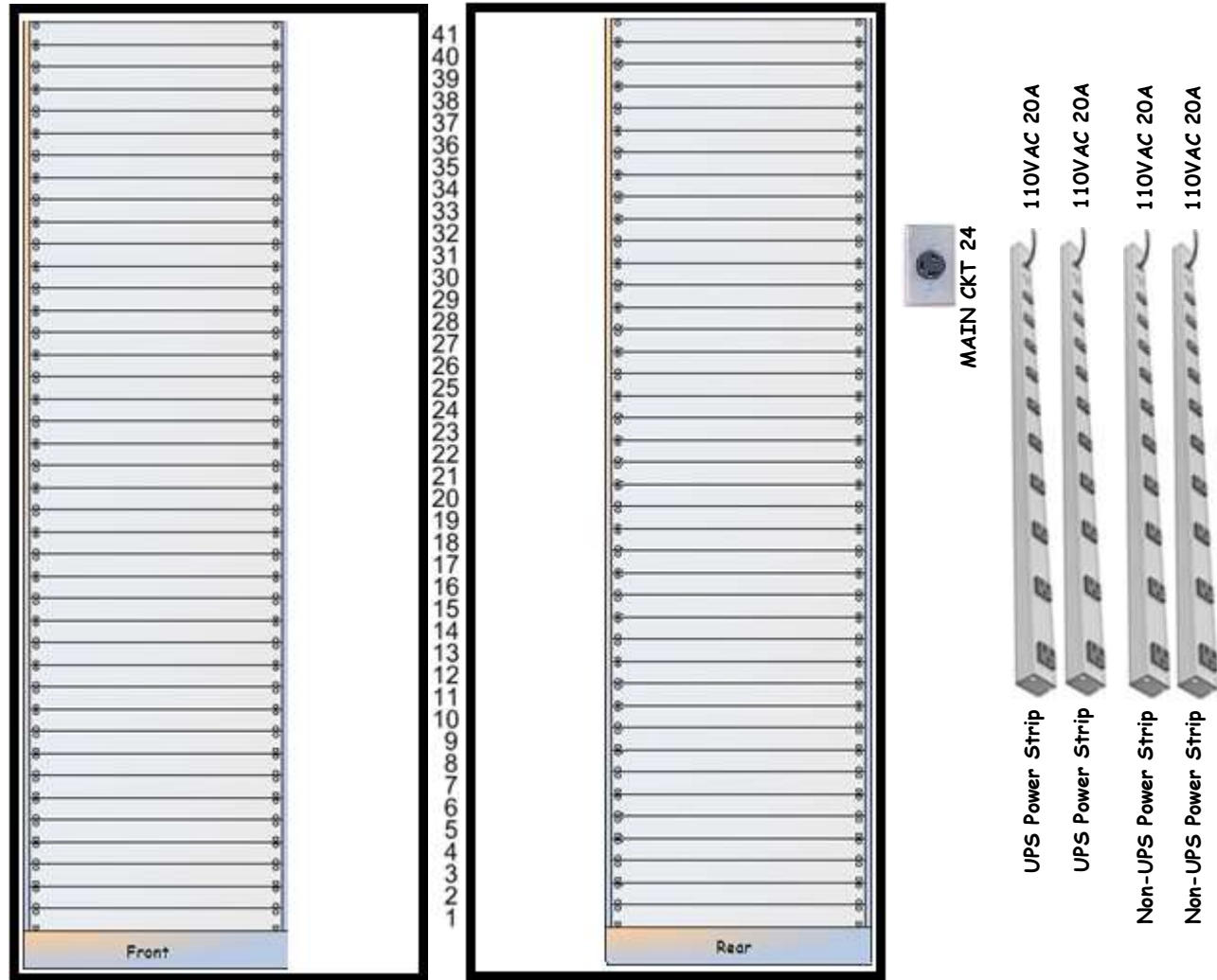

<< L1-MS1

Timing Master Module +12VDC

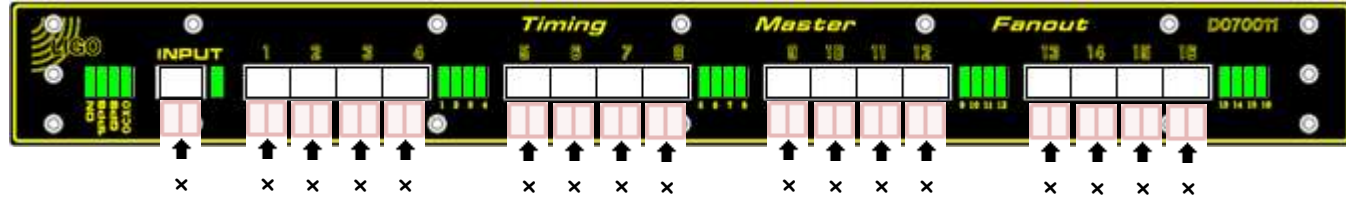

D070011
Front



S1000876
Rear
Master

- [Staging Building MM Fiber Patch](#)
- [Staging Building SM Fiber Patch](#)
- [Network Switch](#)
- [Network Switch](#)
- [Network Switch](#)
-
- [DIN Rail for ESTOP Communication](#)
-
- [Mid Stations Fiber Patch](#)
-
- [Polarization Control](#)
-
- [End Stations SM Fiber Patch](#)
-
- [End Station Telephone WDMs](#)
- [Unknown Fiber Patch](#)

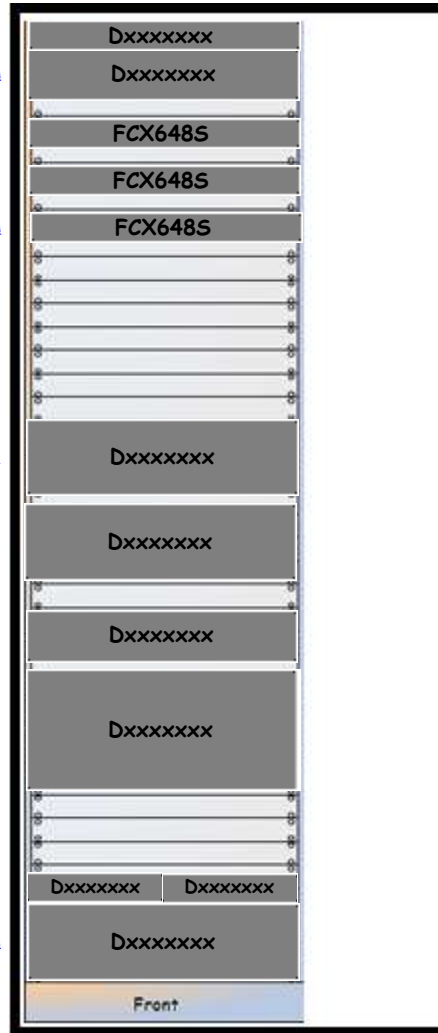

41
40
39
38
37
36
35
34
33
32
31
30
29
28
27
26
25
24
23
22
21
20
19
18
17
16
15
14
13
12
11
10
9
8
7
6
5
4
3
2
1

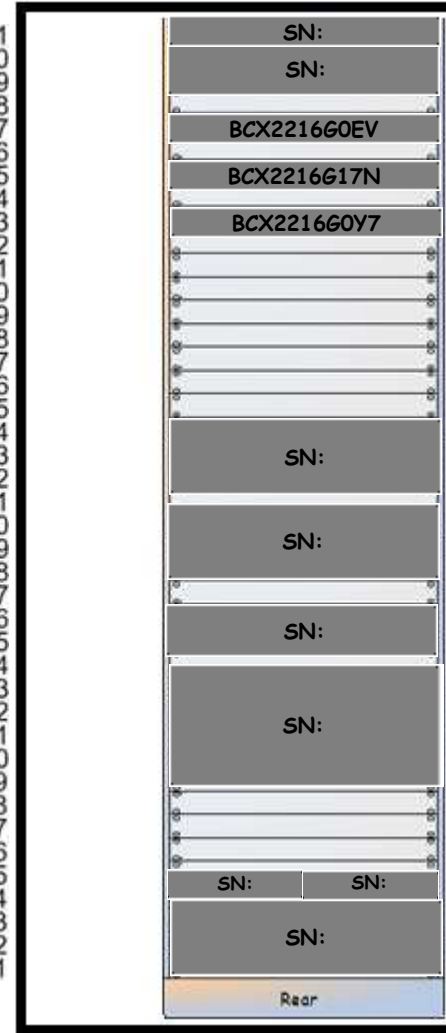

No Power
No Power
UPS and 110VAC
UPS and 110VAC
UPS and 110VAC
110VAC 20A
110VAC 20A
110VAC 20A
110VAC 20A
UPS
No Power
110VAC
No Power
No Power
No Power
No Power
UPS Power Strip
UPS Power Strip
Non-UPS Power Strip
Non-UPS Power Strip

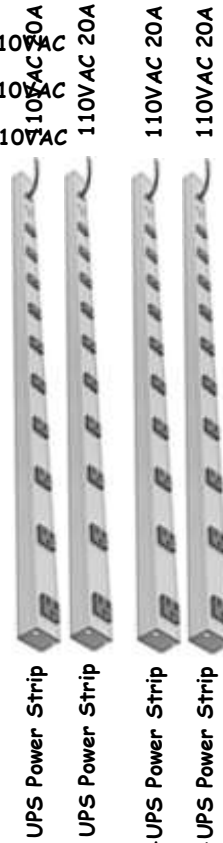

MSR to Staging Building MM Fiber Patch

[<< L1-MSR-02](#)

Staging Building MM Fiber Patch

Dxxxxxxx

SN:

No Power

MSR to Staging Building SM Fiber Patch

[<< L1-MSR-02](#)

Staging Building SM Fiber Patch

Dxxxxxxx

SN:

No Power

2MMF
Landscape Corning

[<< L1-MSR-02](#)

Network Switch

FCX648S

BCX221660EV

110VAC MAINS and UPS

FID: de2HHGLiFgx

[<< L1-MSR-02](#)

Network Switch

FCX648S

BCX2216617N

110VAC MAINS and UPS

FID: de2HHGLiGMp

Network Switch

Network Switch

FCX648S

BCX221660Y7

110VAC MAINS and UPS

FID: de2HHGKiFaM

DIN Rail for ESTOP Communication

<< [L1-MSR-02](#)

DIN Rail for ESTOP Communication

Dxxxxxxx

SN:

UPS

See LIGO-G1200383

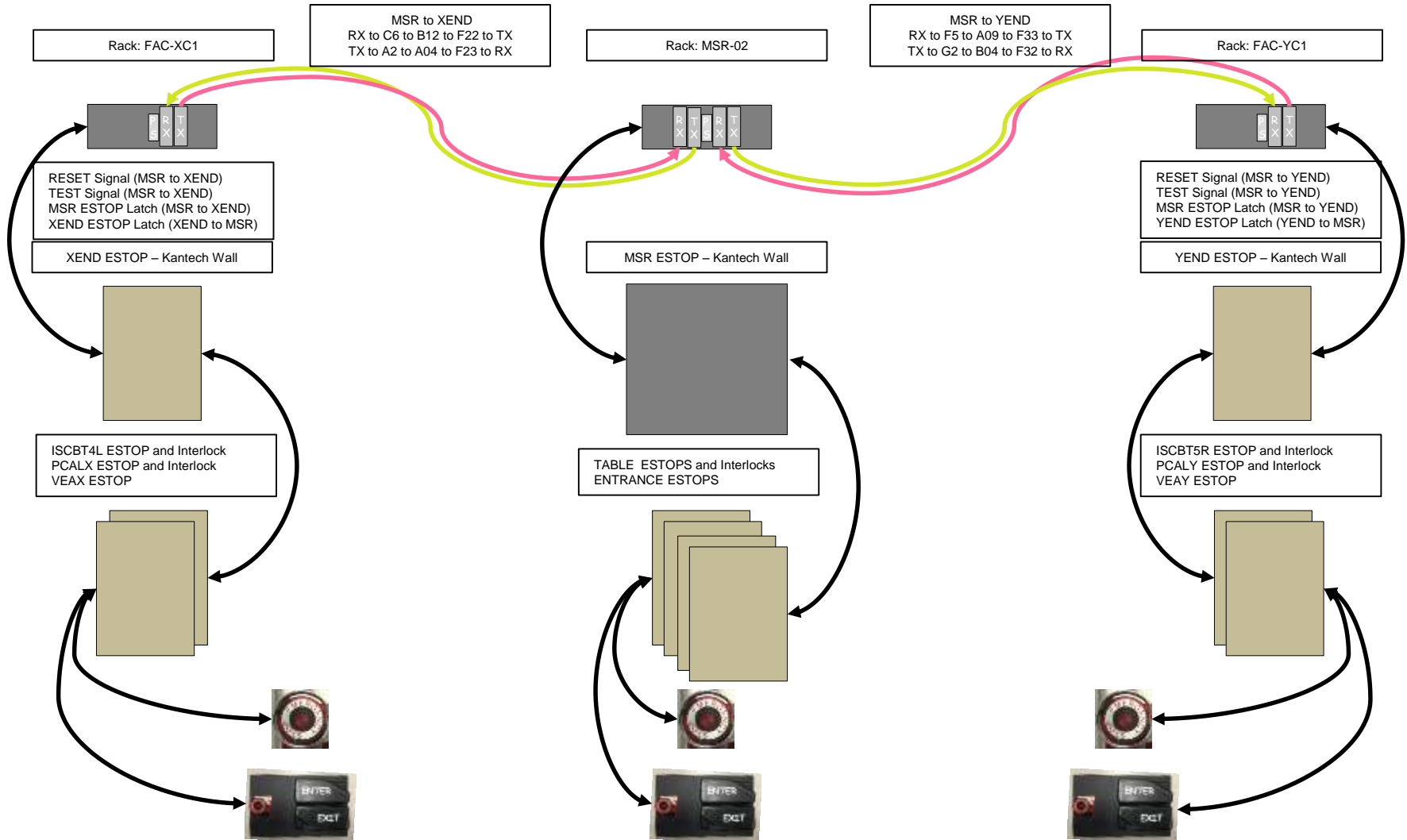

MSR to Mid Stations ?M Fiber Patch

<< [L1-MSR-02](#)

Mid Stations Fiber Patch

Dxxxxxxx

SN:

No Power

1-12 SM to X MIDX
13-24 SM to Y MID

Fiber Control MPC1-2 Polarization Control

Polarization Control

Dxxxxxxx

SN:

No Power

MSR to End Stations SM Fiber Patch

<< [L1-MSR-02](#)

End Stations SM Fiber Patch

Dxxxxxxx

SN:

No Power

Cable/Jacket
Colors

X-Black
Blue

X-Black
Orange

Y-Black
Blue

Y-Black
Orange

Orange
Blue

Orange
Orange

Fiber-Insulation-Colors

- 1 Blue
- 2 Orange
- 3 Green
- 4 Brown
- 5 Slate
- 6 White



- 1 Red
- 2 Black
- 3 Yellow
- 4 Purple
- 5 Tan
- 6 Teal

[X END Fiber Patch Panel >>](#)

[See LIGO-E1500002](#)

[Y END Fiber Patch Panel >>](#)

<< [L1-MSR-02](#)

End Station Telephone WDMs

Dxxxxxxx Dxxxxxxx

SN:

SN:

No Power

X End Phone

TR3030WDM

GE Security

Optical In/Out:

To 1Y23 PP B2

Phone: Copper to

X Foyer

Power: 12VDC

System Design

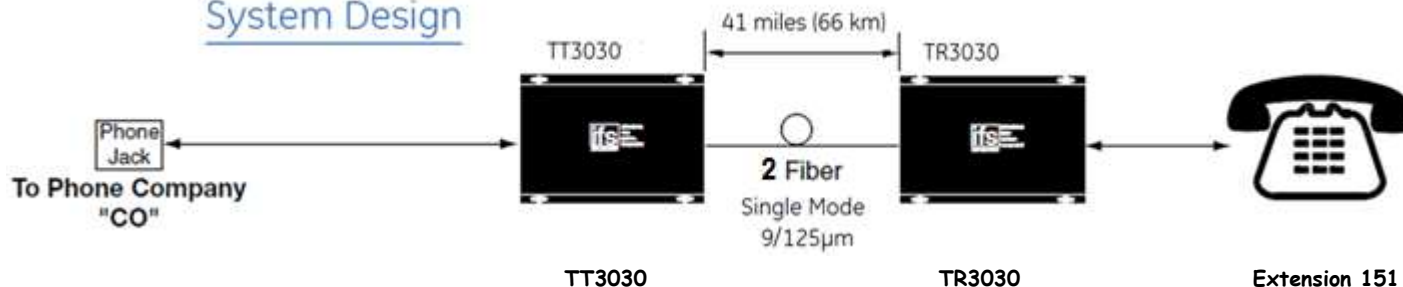

Y End Phone

TR3030WDM

GE Security

Optical In/Out:

To 1Y23 PP B2

Phone: Copper to

Y Foyer

Power: 12VDC

System Design

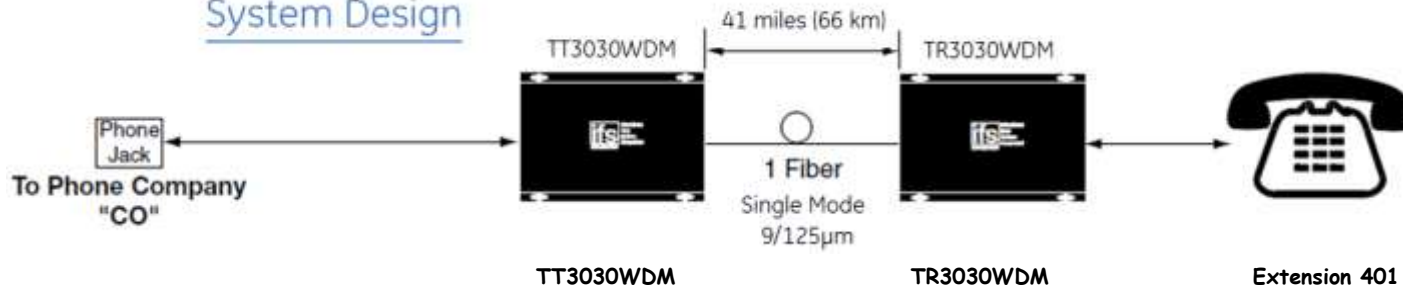

<< End Station Phones

End Station Telephone WDMs

Dxxxxxxx

Dxxxxxxx

SN:

SN:

No Power

X End Phone

TR3030WDM

GE Security

Optical In/Out:

To 1Y23 PP B2

Phone: Copper to

X Foyer

Power: 12VDC

Powered from Wall Wart from
Tripp-Lite UPS
Model BC320
9834DY0BC614000661 To 6-
Outlet Power Strip in Non-
isolated wall socket



System Design

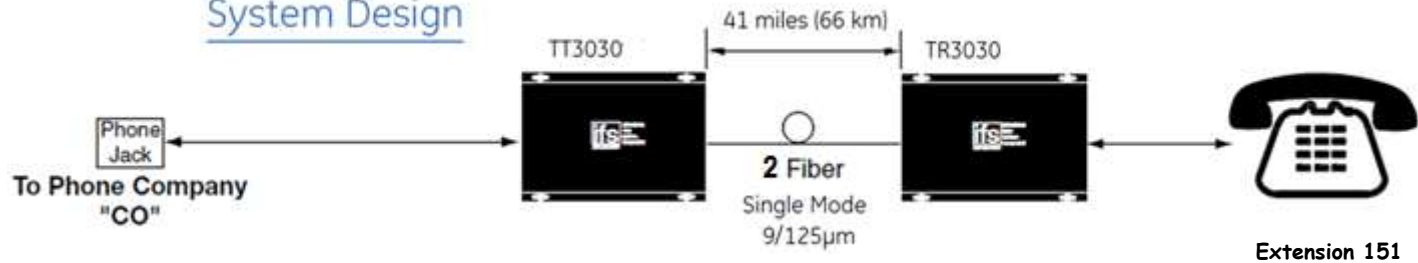

<< End Station Phones

End Station Telephone WDMs

Dxxxxxxx

Dxxxxxxx

SN:

SN:

No Power

Phone

TR3030WDM

GE Security
Optical In/Out:
To 1Y23 PP B2
Phone: Copper to
Y Foyer
Power: 12VDC

Powered from Wall Wart from
Tripp-Lite UPS
Model BC320
9834DY0BC614000661 To 6-
Outlet Power Strip in Non-
isolated wall socket



System Design

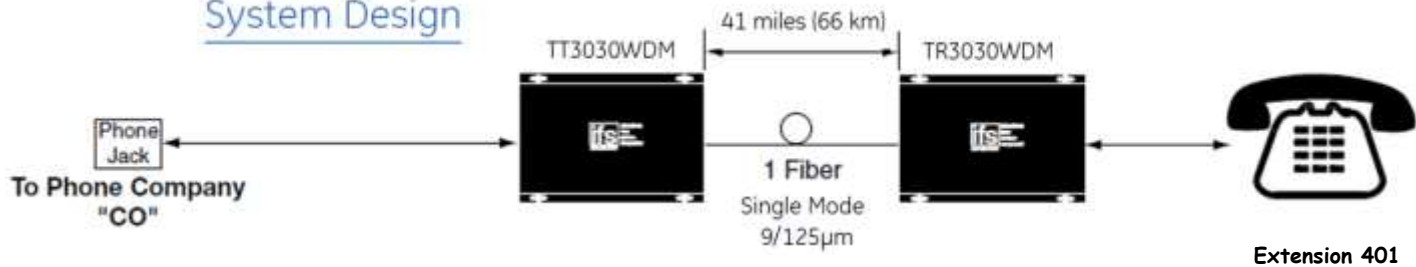

Extension 401

[<< L1-MSR-02](#)

Unknown Fiber Patch

Dxxxxxxx

SN:

No Power

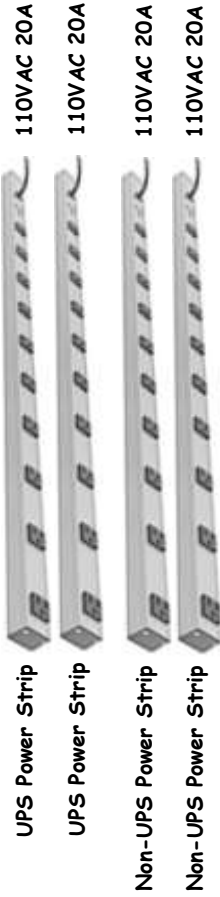
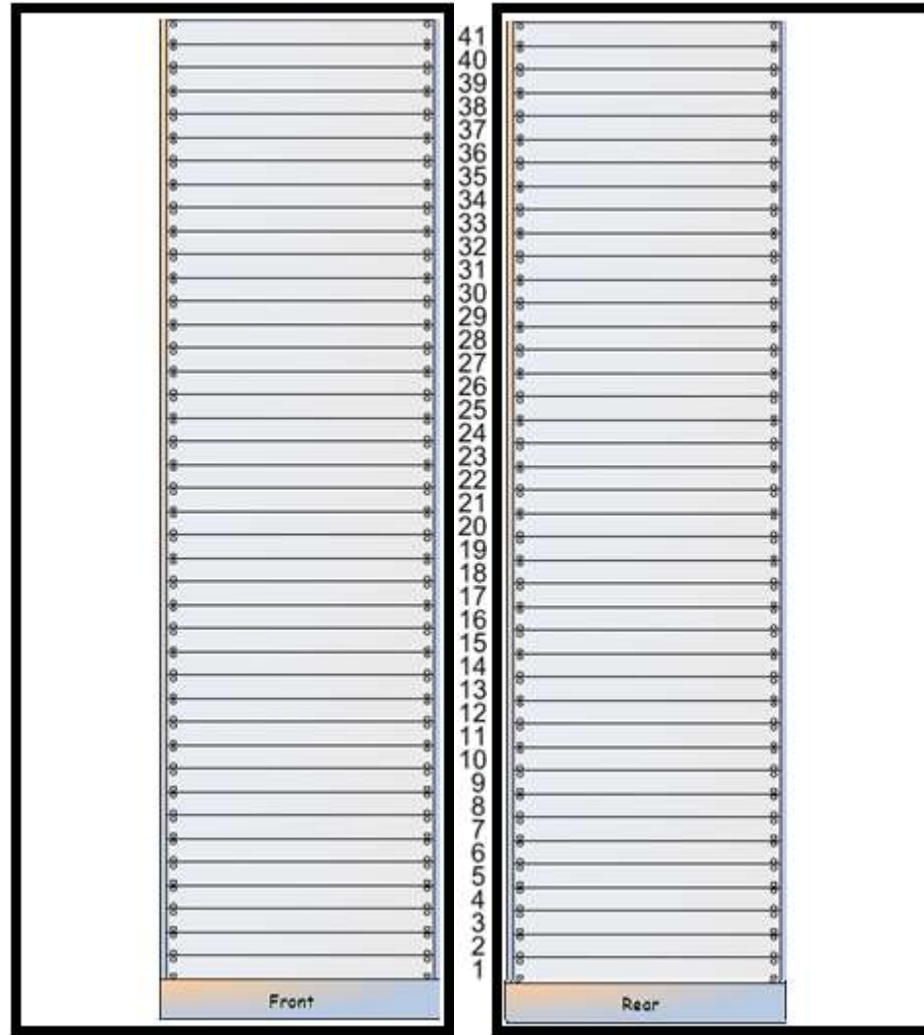

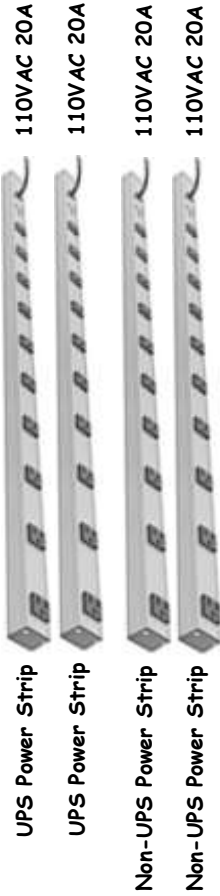
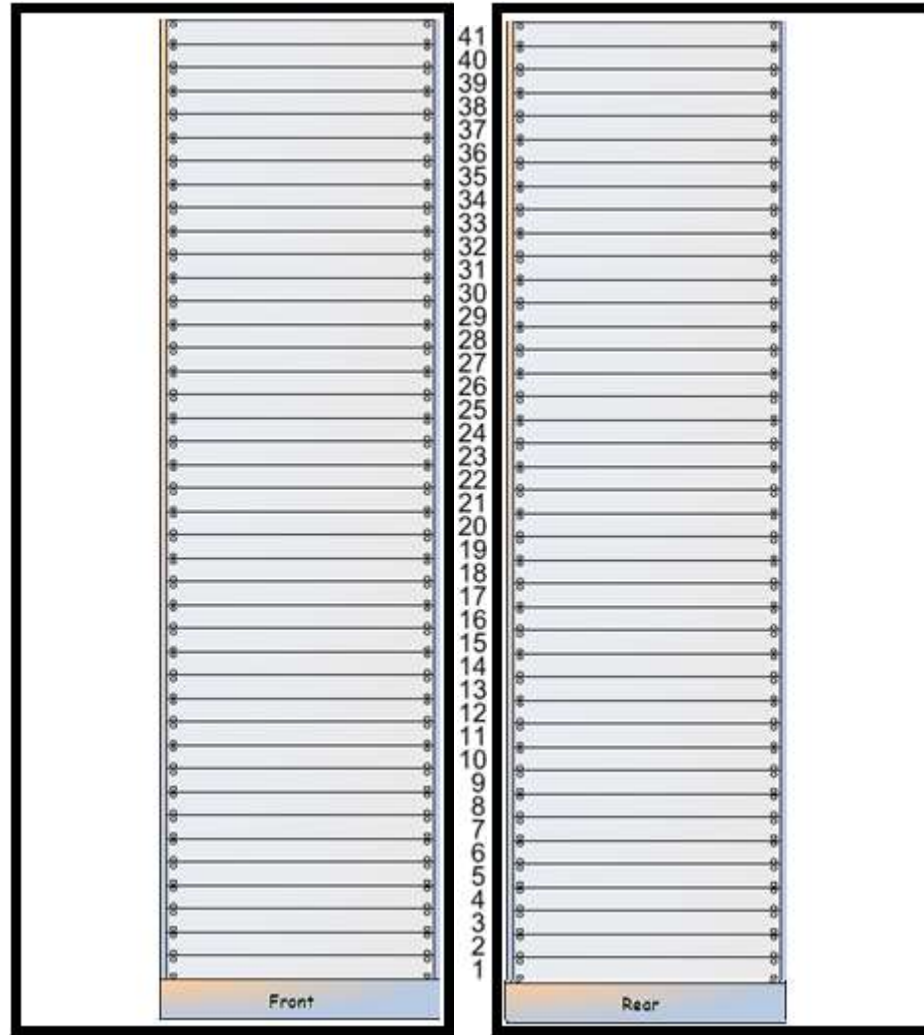

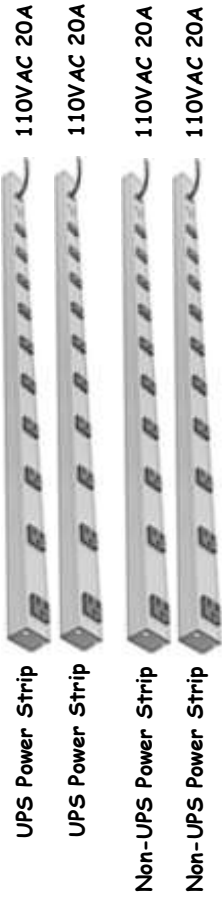
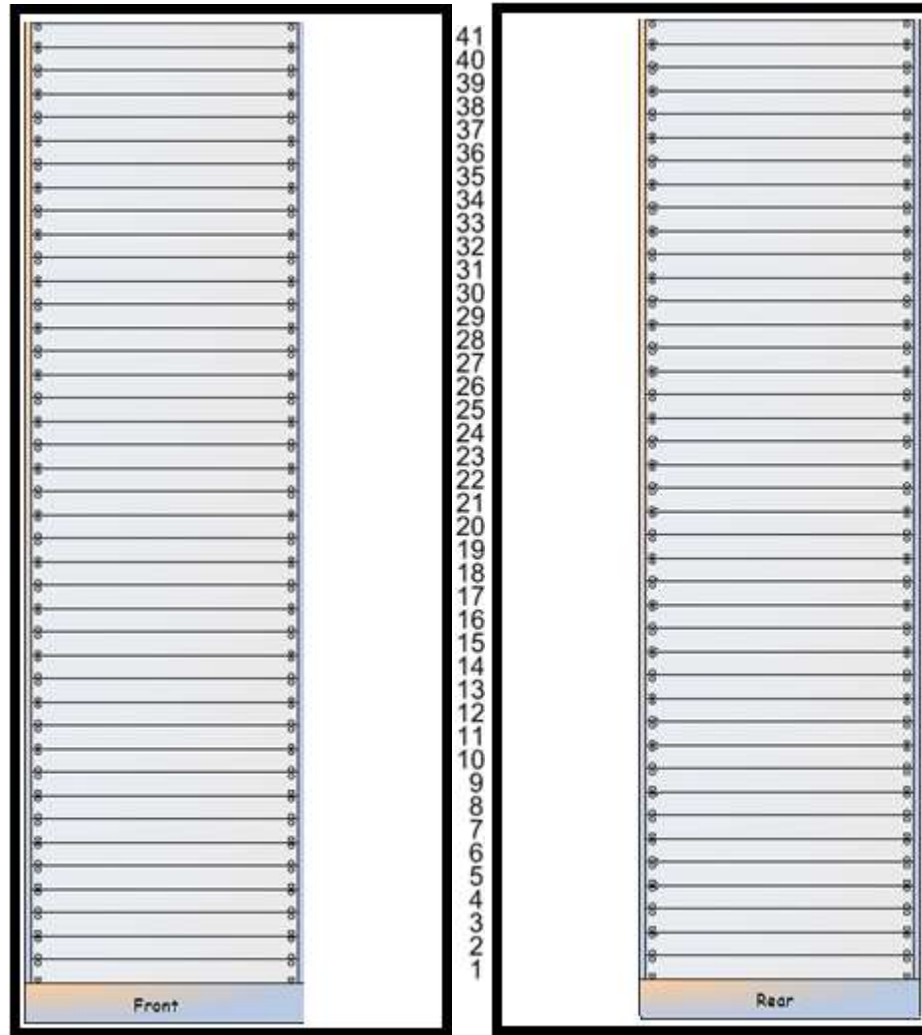

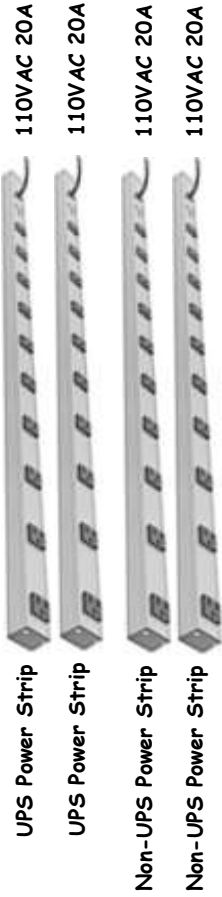
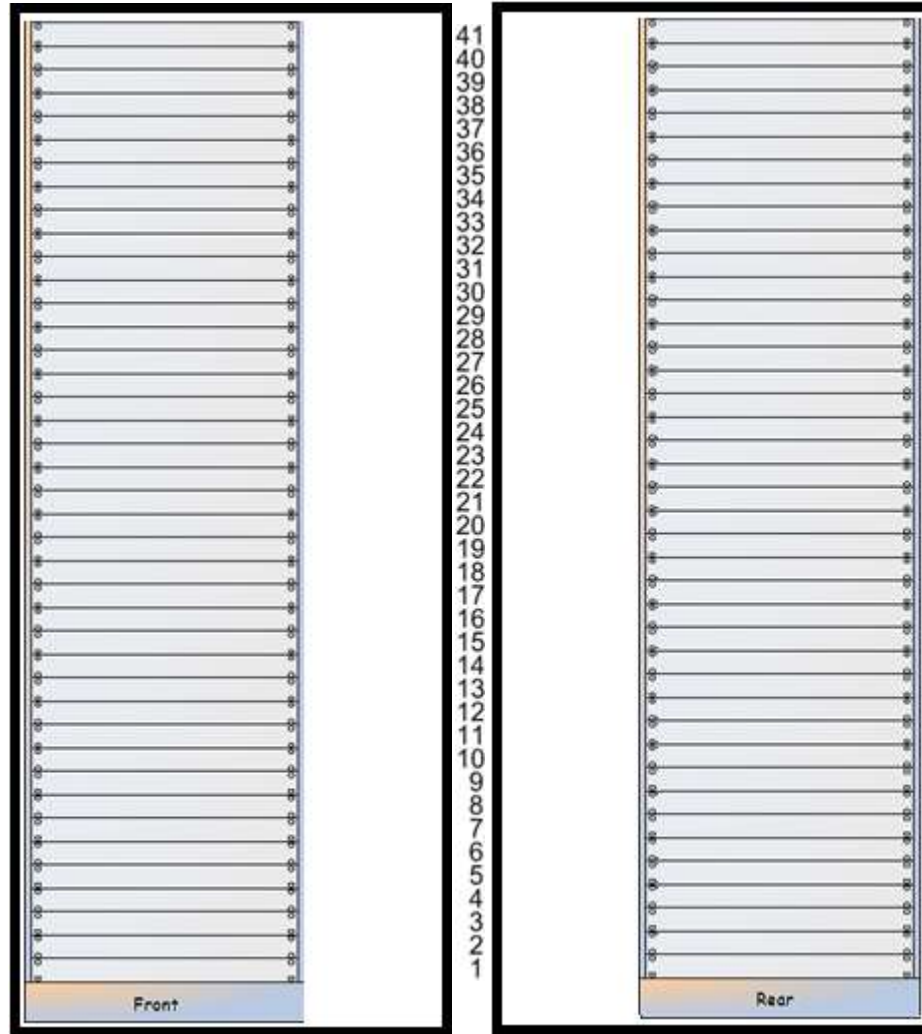

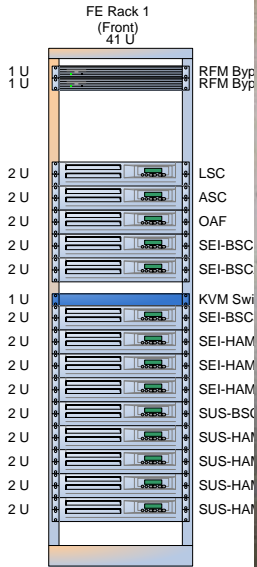

Network Switch
Network Switch

Switch 1
Switch 2

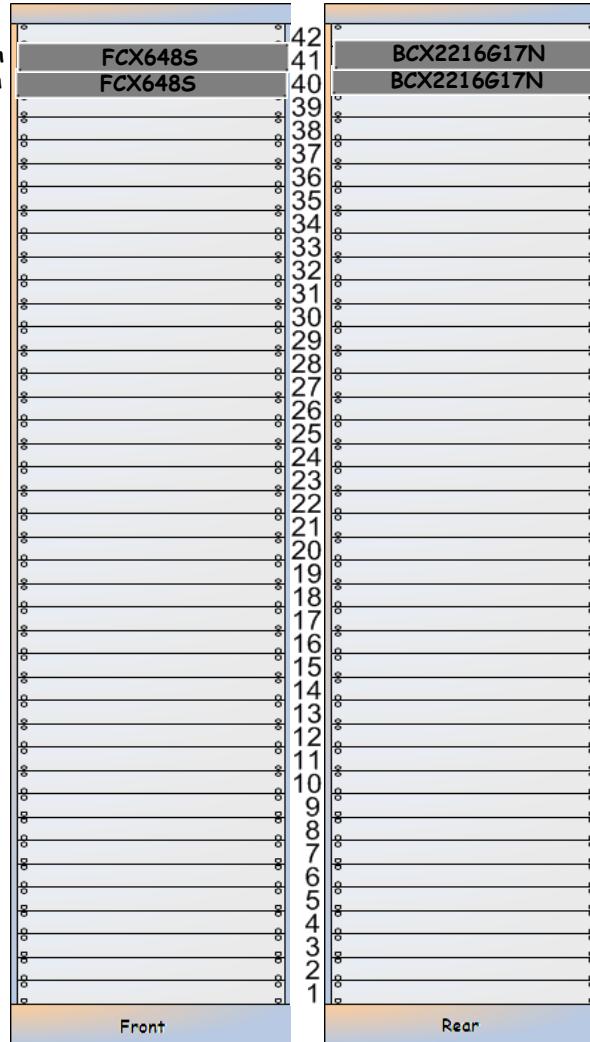

UPS and 110VAC
UPS and 110VAC

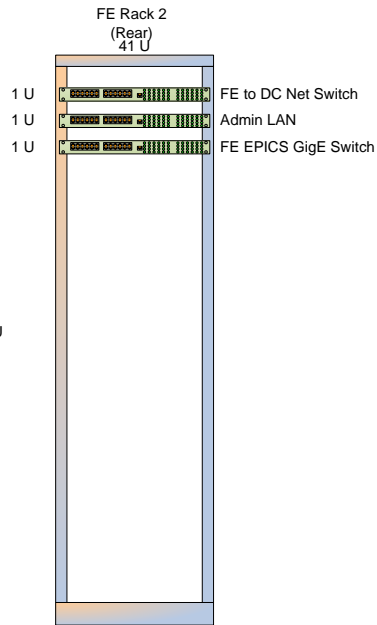
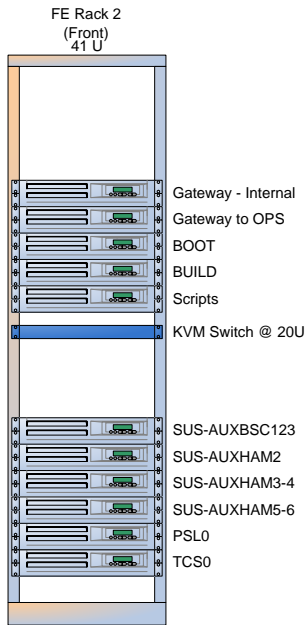

Network Switch

Network Switch

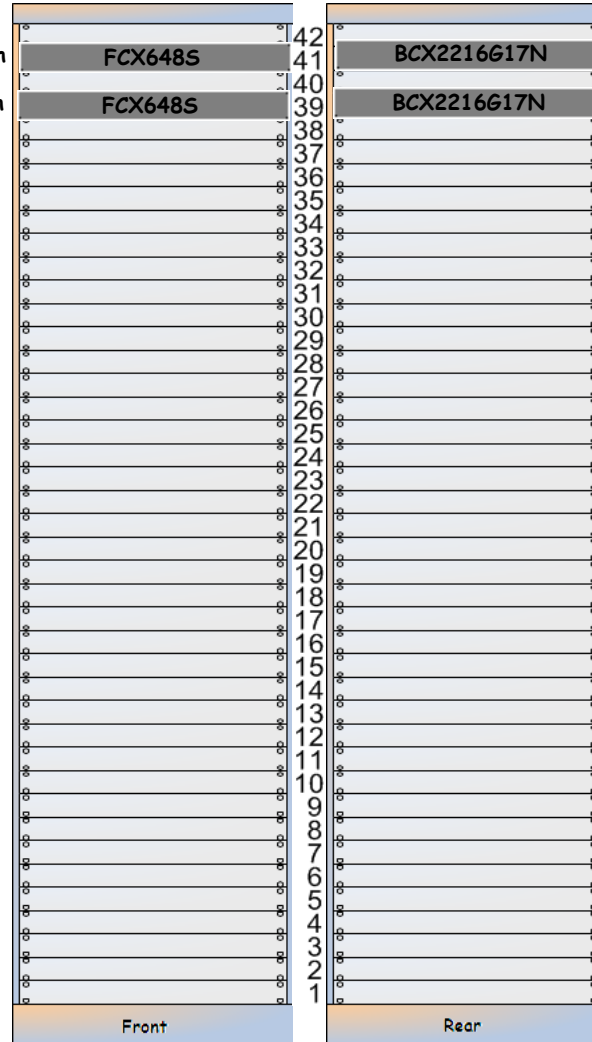

UPS and 110VAC

UPS and 110VAC

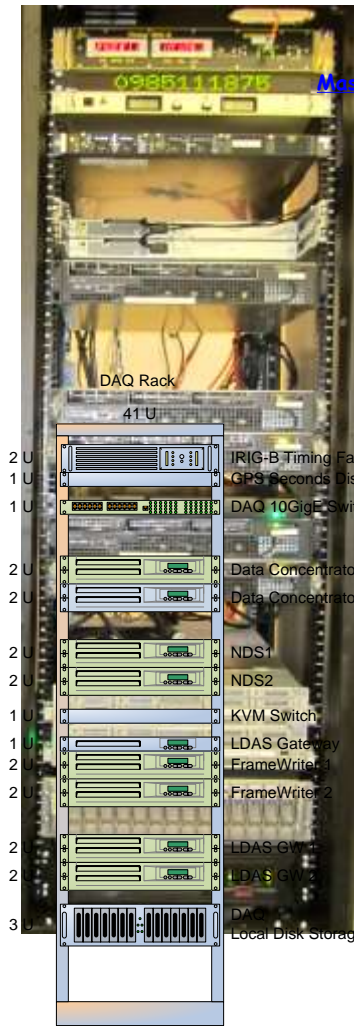

Timing IRIG-B Chassis
MasterClock GPS Seconds Display
Power 10 DC Power Supply

DAQ Rack
Rear
41 U

1 U
1 U

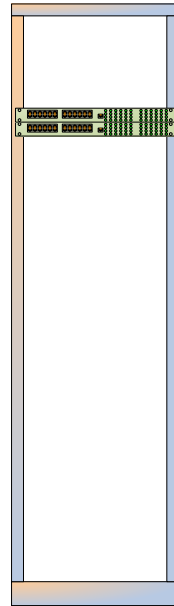

Qlogic Switch
Qlogic Switch

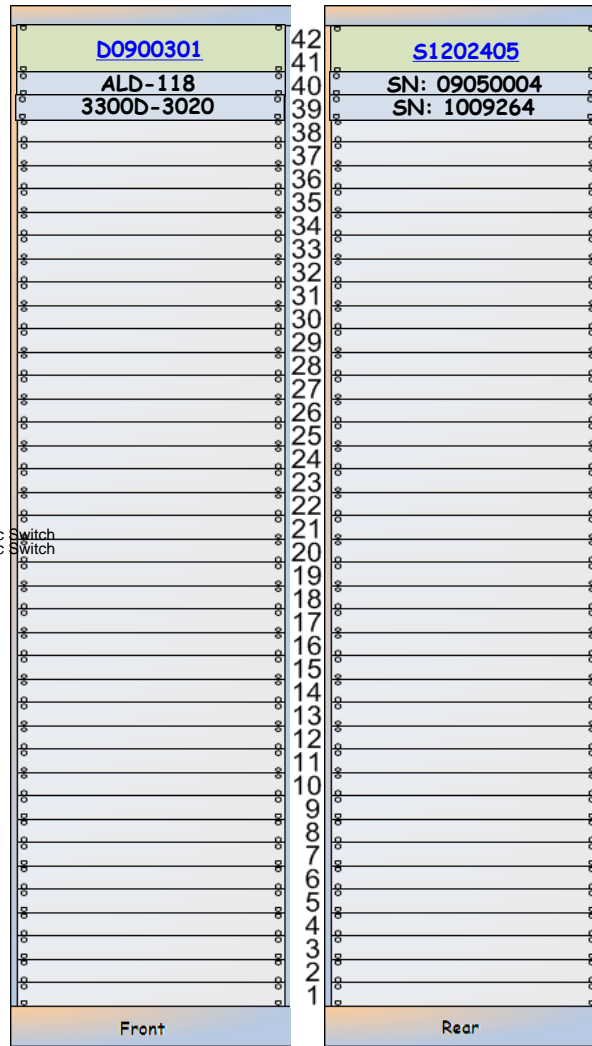

$\pm 12@1A$
UPS
UPS

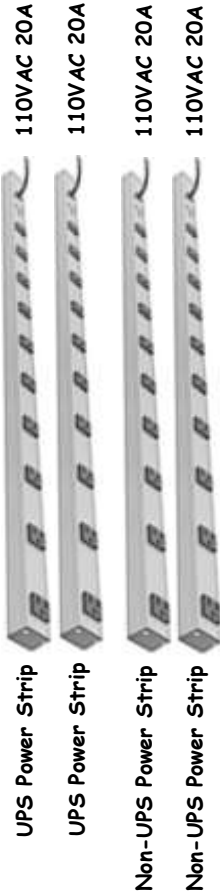

L1-MSR-9 is a part of [T1000588](#)

<< [L1-MS9](#)

Timing IRIG-B Interface Chassis

[D0900301](#)

[S1202405](#)

+12VDC

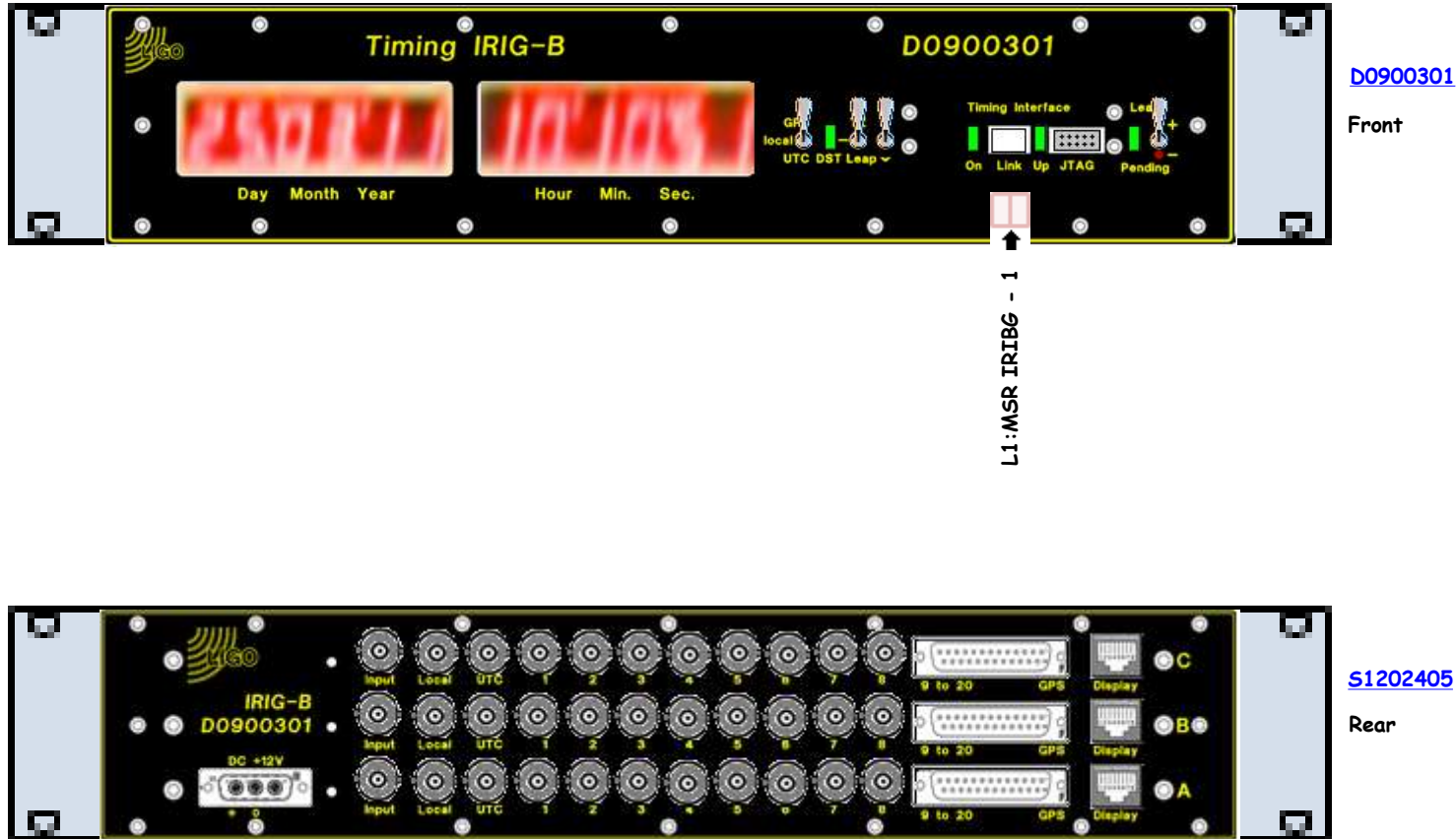

[D0900301](#)

Front

[S1202405](#)

Rear

[<< L1-MS9](#)

MasterClock GPS Seconds Display UPS

[D0900301](#)

Front

[S1202405](#)

Rear

Power 10 DC Power Supply

The LIGO logo consists of the word "LIGO" in a bold, black, sans-serif font. To the left of the text are several concentric, curved lines that resemble a ripple effect or a stylized representation of gravitational waves.

[<< L1-MS9](#)

Power 10 DC Power Supply UPS

[D0900301](#)

Front

[S1202405](#)

Rear

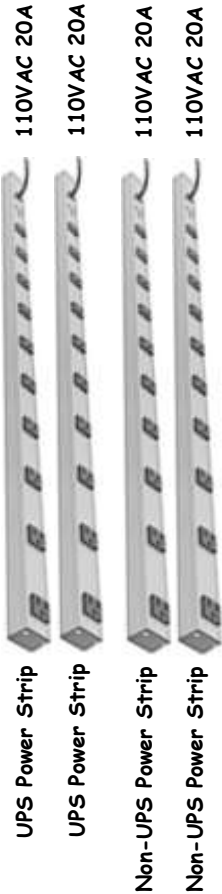
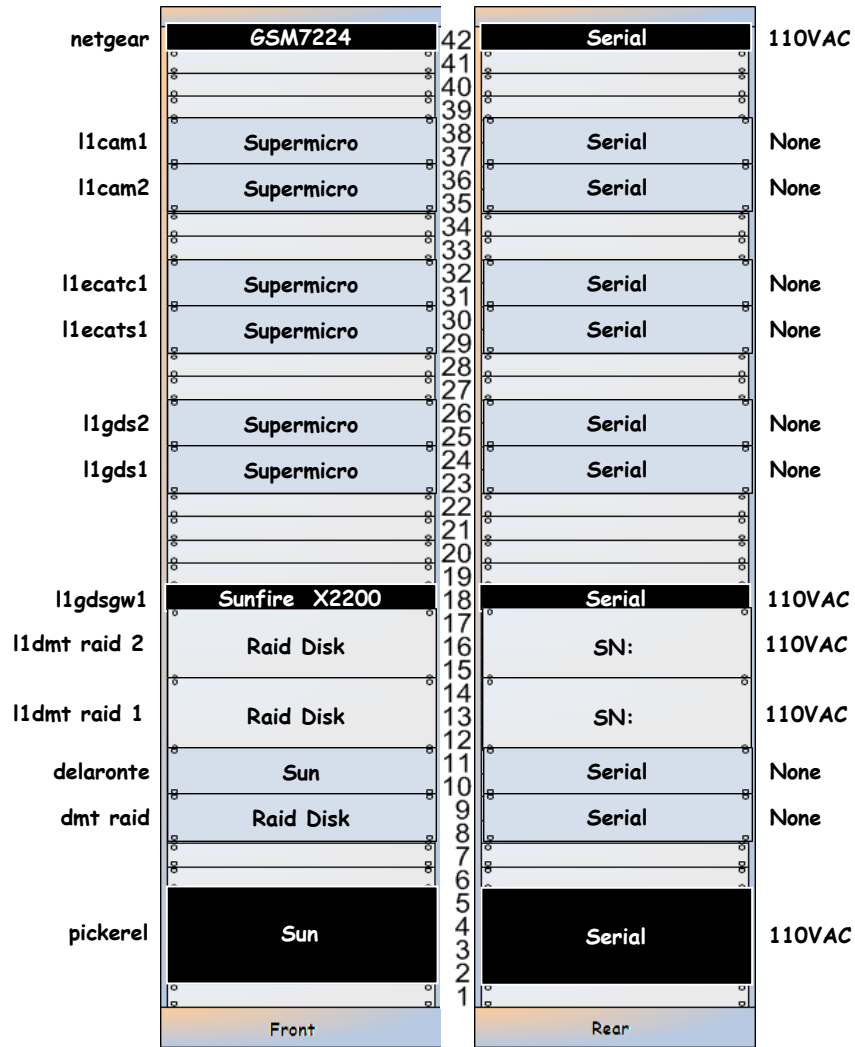

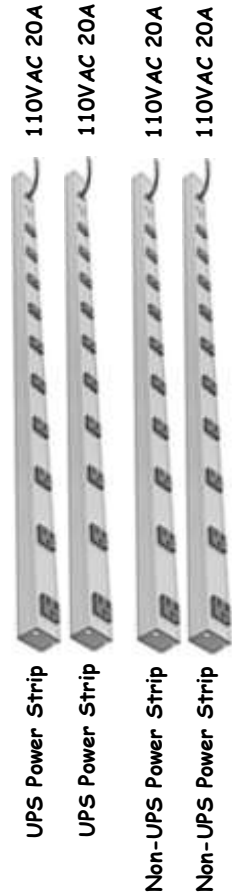
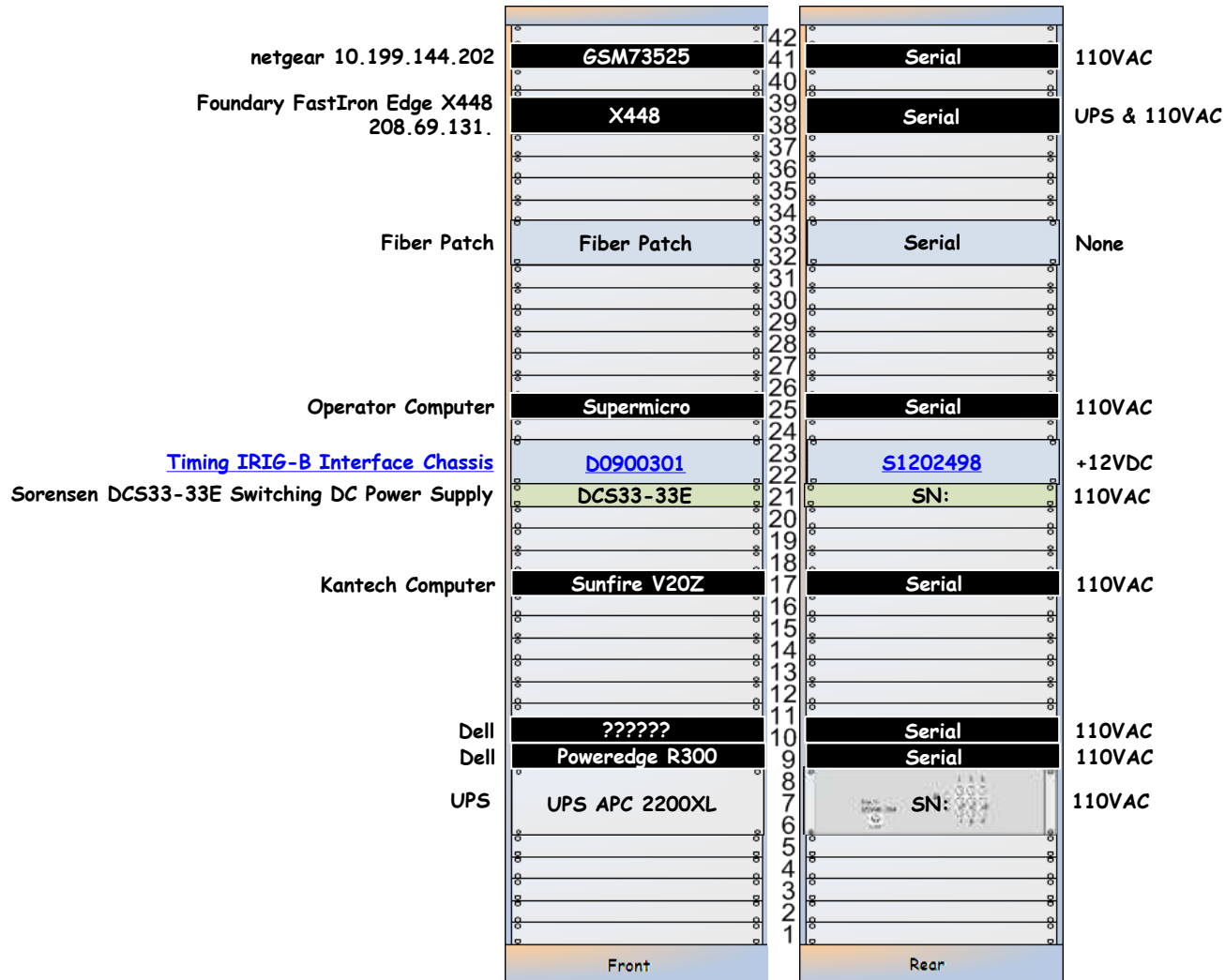

Timing IRIG-B Interface Chassis

D0900301

S1202498

+12VDC

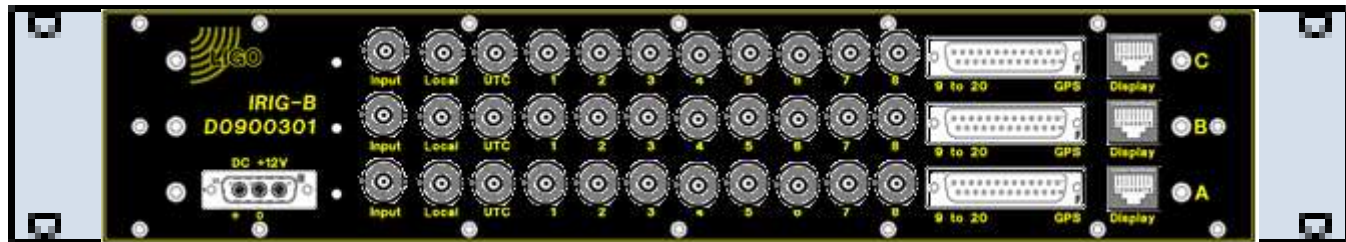
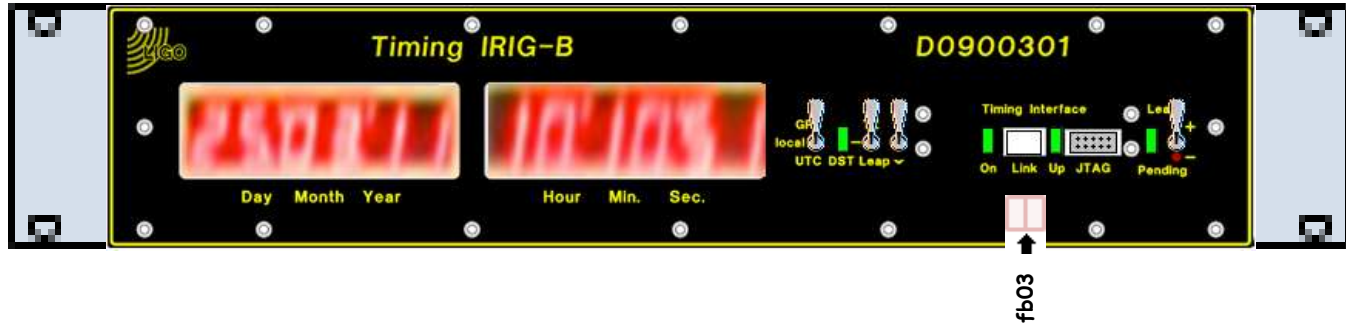

x2fedaq net 10.146.0.x	GSM7224	42	Serial	110VAC
x2fe lan 10.144.0.x	GSM7224	41	Serial	110VAC
x2 daq-out 10.145.0.x	JGS516	40	Serial	110VAC
netgear	GSM7224	39	Serial	110VAC
x2daqdc 10.144.0.100	???????	38	Serial	110VAC
x2daqfw 10.144.0.102	???????	37	Serial	110VAC
x2daqnds 10.144.0.104	???????	36	Serial	110VAC
x2work 10.144.0.90	???????	35	Serial	110VAC
x2file 10.144.0.10	???????	34	Serial	110VAC
x2boot 10.144.0.20	???????	33	Serial	110VAC
x2netrfm 10.144.0.82	VMI ACC 5595	32	Serial	110VAC
		31		
x2dtsfe1 10.144.0.30	???????	30	Serial	110VAC
		29		
x2dtsfe2 10.144.0.31	???????	28	Serial	110VAC
		27		
x2dtsfe3 10.144.0.32	???????	26	Serial	110VAC
		25		
		24		
		23		
		22		
		21		
ATEN KVM Switch	CL1016M	20	SN:	110VAC
		19		
x2dtsfe2 - I/O Extension Chassis	D1001715	18	S1000532	110VAC
		17		
		16		
x2dtsfe3 - I/O Extension Chassis	D1001715	15	S1001145	110VAC
		14		
		13		
		12		
		11		
		10		
		9		
		8		
		7		
Sorensen DCS33-33E Switching DC Power Supply	DCS33-33E	6	SN:	110VAC
Sorensen DCS33-33E Switching DC Power Supply	DCS33-33E	5	SN:	110VAC
		4		
UPS	UPS APC 2200XL	3		
		2	SN:	110VAC
		1		





GSM7224

Front

CO:3F:0E:86:88:AC

3 - To FE LAN Port

5 - To 5595 LAN 10BaseT

21F - To 1X23 PP E3,E4



2B62045700143

Rear

To UPS Power Strip

L1-MSR-13 UPS for IFO and CDS Computers Rack Layout (Txxxxxxx)

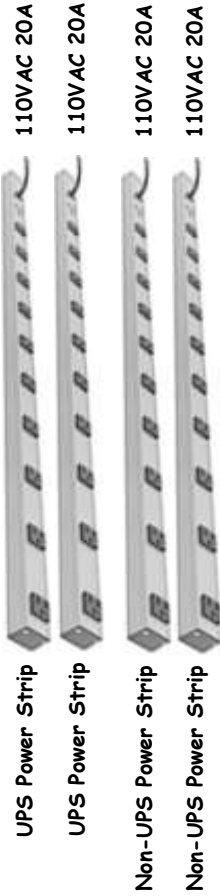

l1psl0	S1001134	L1-PSL-C1	L1:FE-IO-19	L1:TIM-PSL-C1-A
l1oaf0	S1103894	L1-OAF-C1	L1:FE-IO-03	
l1tcs0	S1103894	L1-AOS-C1	L1:FE-IO-22	
l1seiham16	S1001144	L1-SEI-C1	L1:FE-IO-07	
l1seiham23	S1001145	L1-SEI-C2	L1:FE-IO-08	
l1seiham45	S1001146	L1-SEI-C3	L1:FE-IO-09	
l1seibsc1	S1001147	L1-SEI-C4	L1:FE-IO-04	
l1seibsc2	S1001148	L1-SEI-C5	L1:FE-IO-20	
l1seibsc3	S1100946	L1-SEI-C6	L1:FE-IO-23	
l1asc0	S1106300	L1-ISC-C1	L1:FE-IO-02	
l1lsc0	S1106342	L1-ISC-C1	L1:FE-IO-01	
l1susauxham34	S1001141	L1-SUS-C2	L1:FE-IO-17	
l1susham34	S1001140	L1-SUS-C2	L1:FE-IO-13	
l1susauxham2	S1103891	L1-SUS-C3	L1:FE-IO-16	
l1susham2a	S1001133	L1-SUS-C3	L1:FE-IO-11	
l1susham2b	S1001139	L1-SUS-C3	L1:FE-IO-12	
l1susbsc123	S1001143	L1-SUS-C5	L1:FE-IO-10	
l1susauxbsc123	S1103888	L1-SUS-C5	L1:FE-IO-21	
l1susauxham56	S1103889	L1-SUS-C8	L1:FE-IO-18	
l1susham56	S1001142	L1-SUS-C8	L1:FE-IO-14	
l1iscex	S1000536	L1-ISC-XC1	L1:FE-IO-33	L1:ISCEX
l1seiex	S1201774	L1-SEI-XC1	L1:FE-IO-30	L1:SEIEX
l1susauxex	S1201779	L1-SUS-XC2	L1:FE-IO-32	L1:SUSAUXEX
l1susex	S1103367	L1-SUS-XC2	L1:FE-IO-31	L1:SUSEX
l1pemey	S1000528	L1-ISC-YC1		
l1seiye	S1200166	L1-SEI-YC1		
l1susauxey	S1201775	L1-SUS-YC2		
l1susey	S1201776	L1-SUS-YC2		

Binary IO Card - DIO6464L-PE

DIO6464L-PE

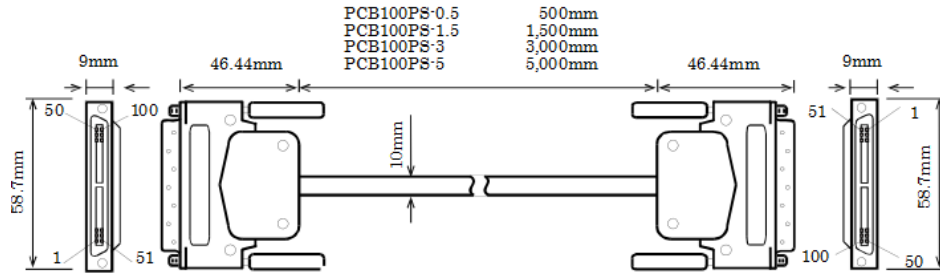

37-pin D-SUB × for 100-pin
0.8mm pitch connector shielded
cable distribution 2 (3m)

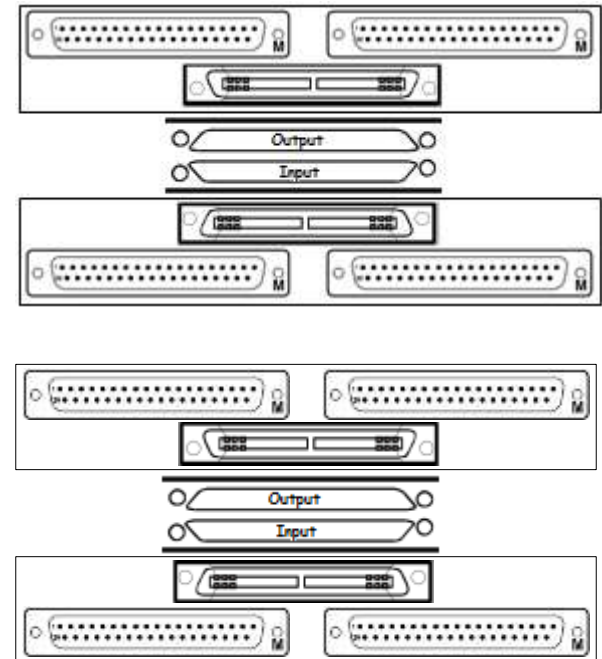
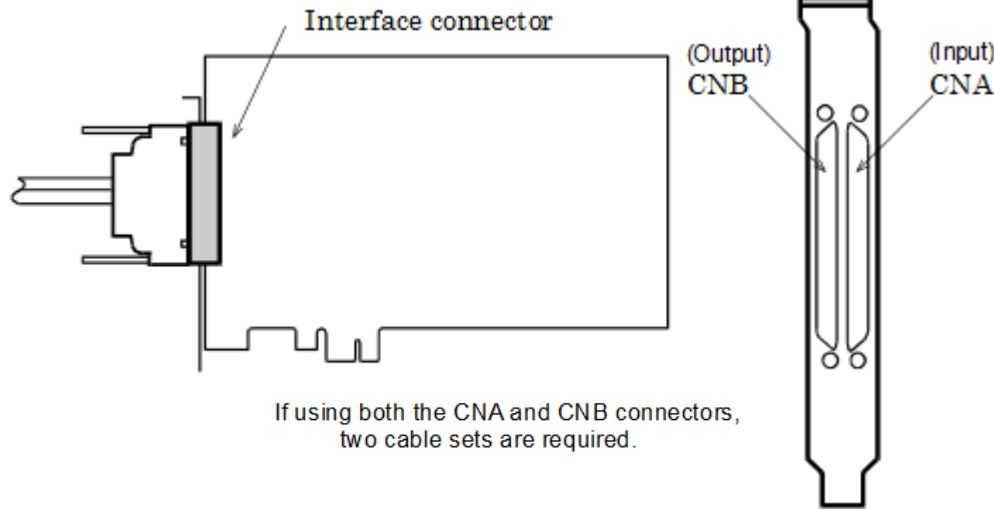

[<< LLO Corner Station](#)

[<< LLO Racks by AREA](#)

[<< LLO CDS Components](#)

CER

[Rack Layout >>](#)

LLO CER - Rack Layout

- << LLO Corner Station
- << LLO Racks by Area
- << LLO CDS Components

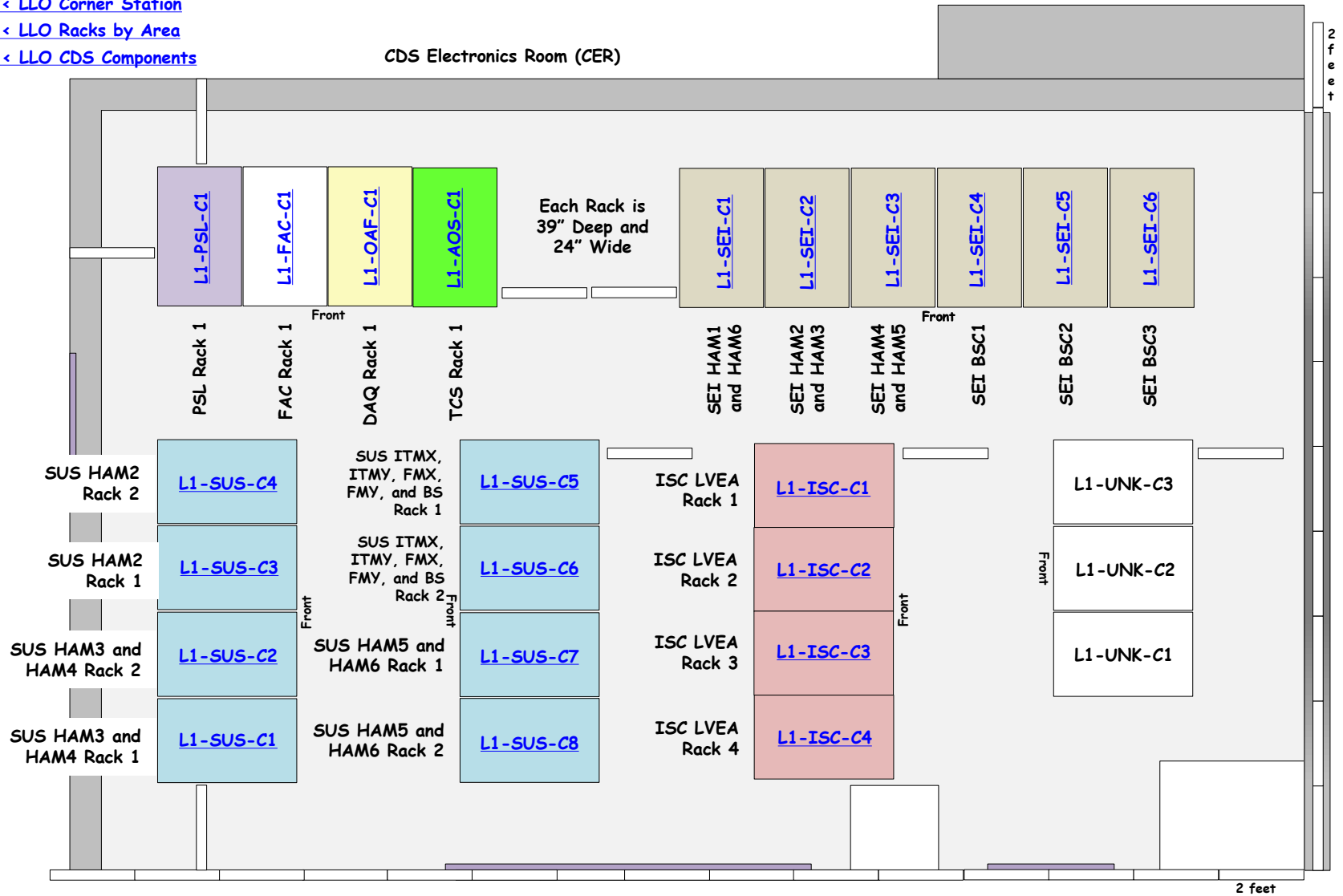

LLO CER, LDR, and CPR Cable Tray Layout

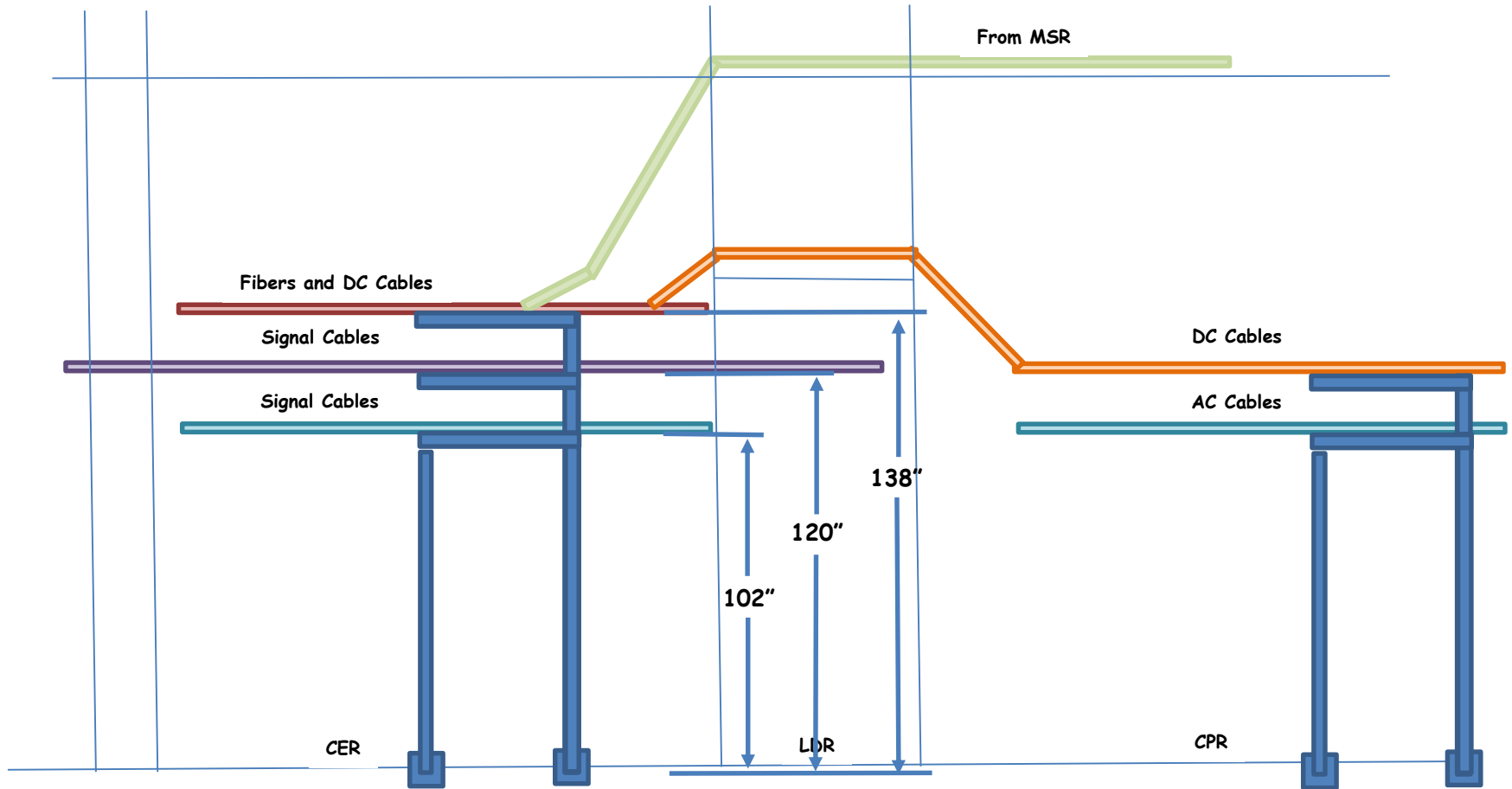

LLO CER - 8.5ft Cable Tray Layout

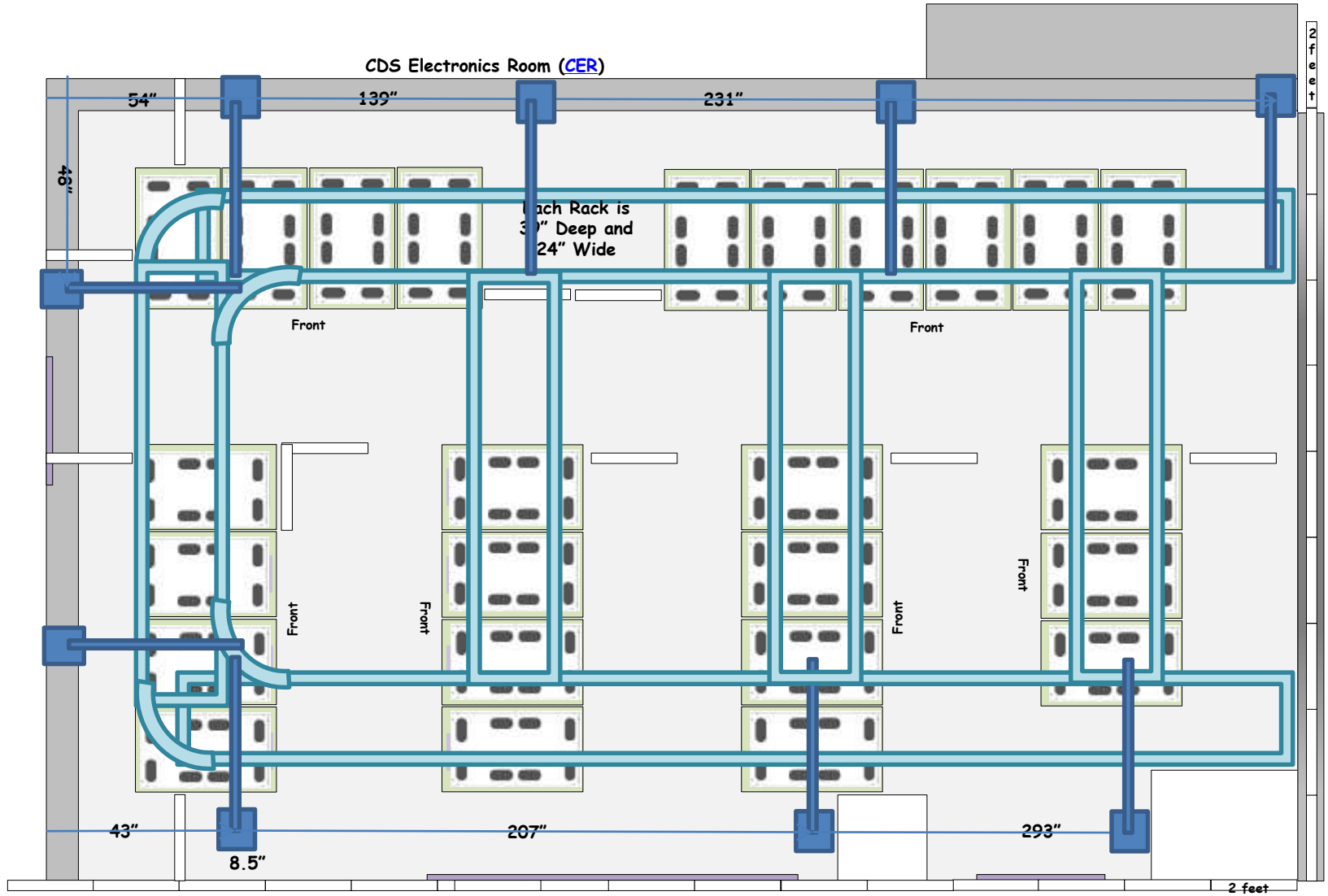

All posts are E-Posts

LIGO CER - 10ft Cable Tray Layout

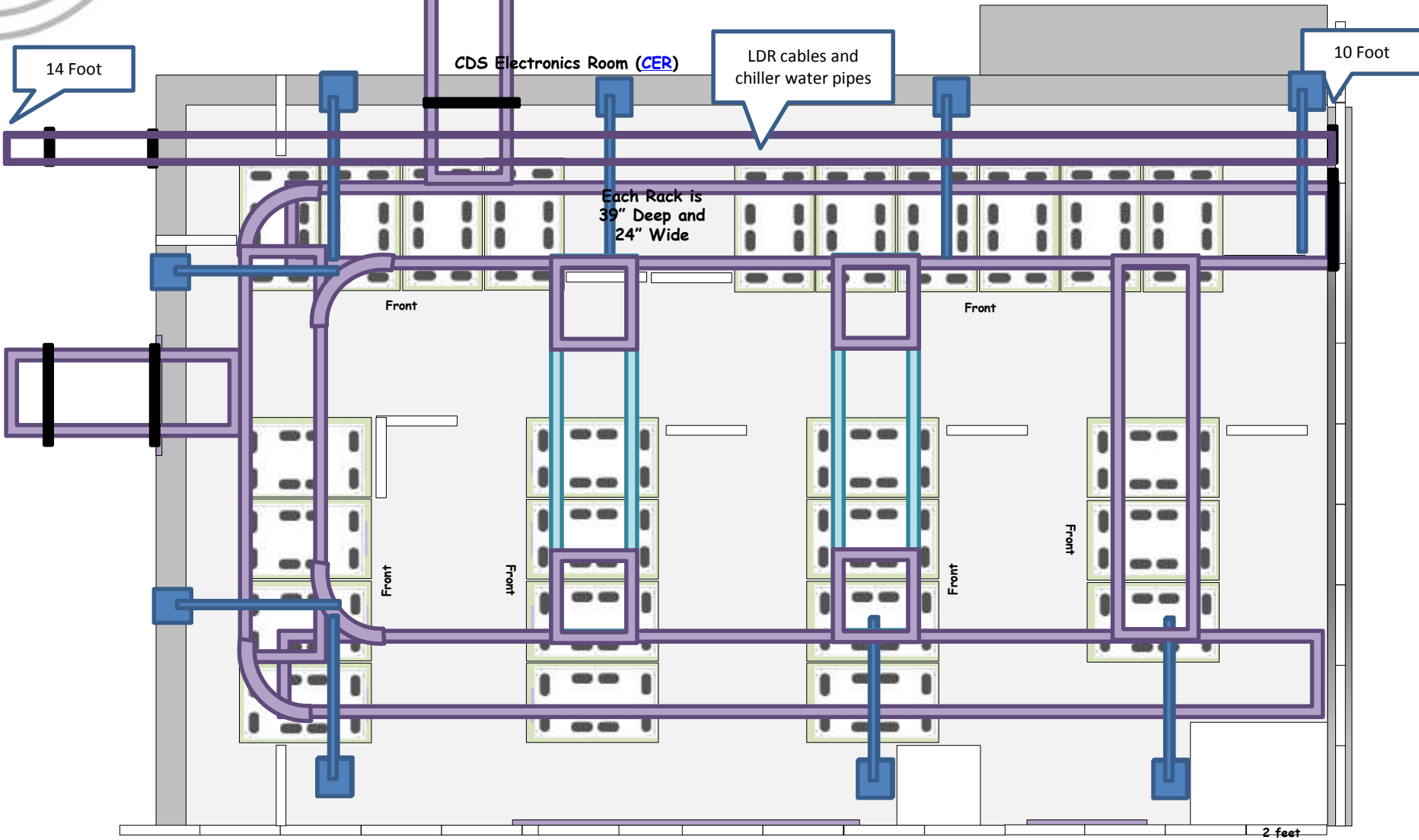

All posts are E-Posts

LLO CER - 11.5ft Cable Tray Layout

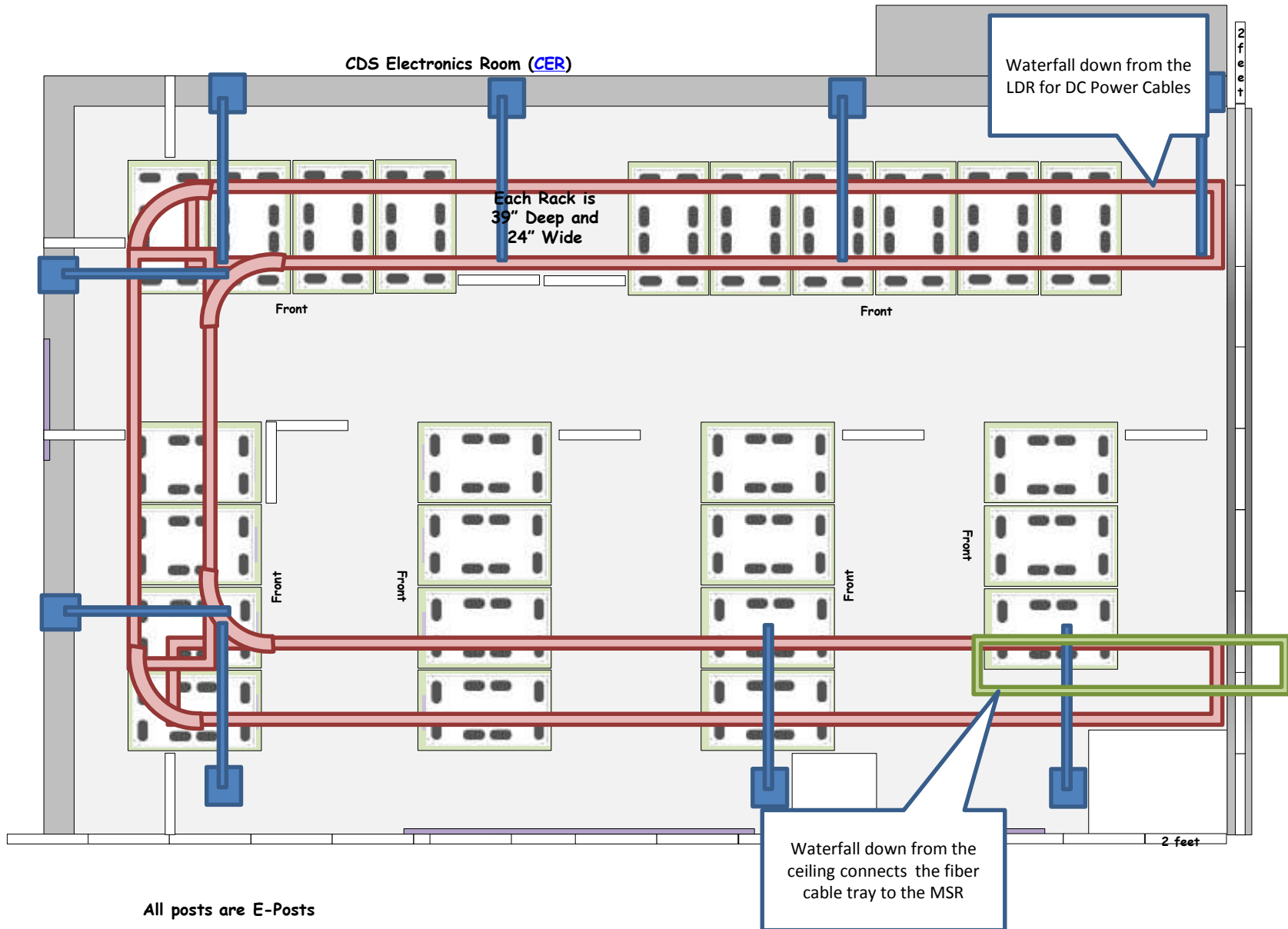

LLO CER - Rack Layout

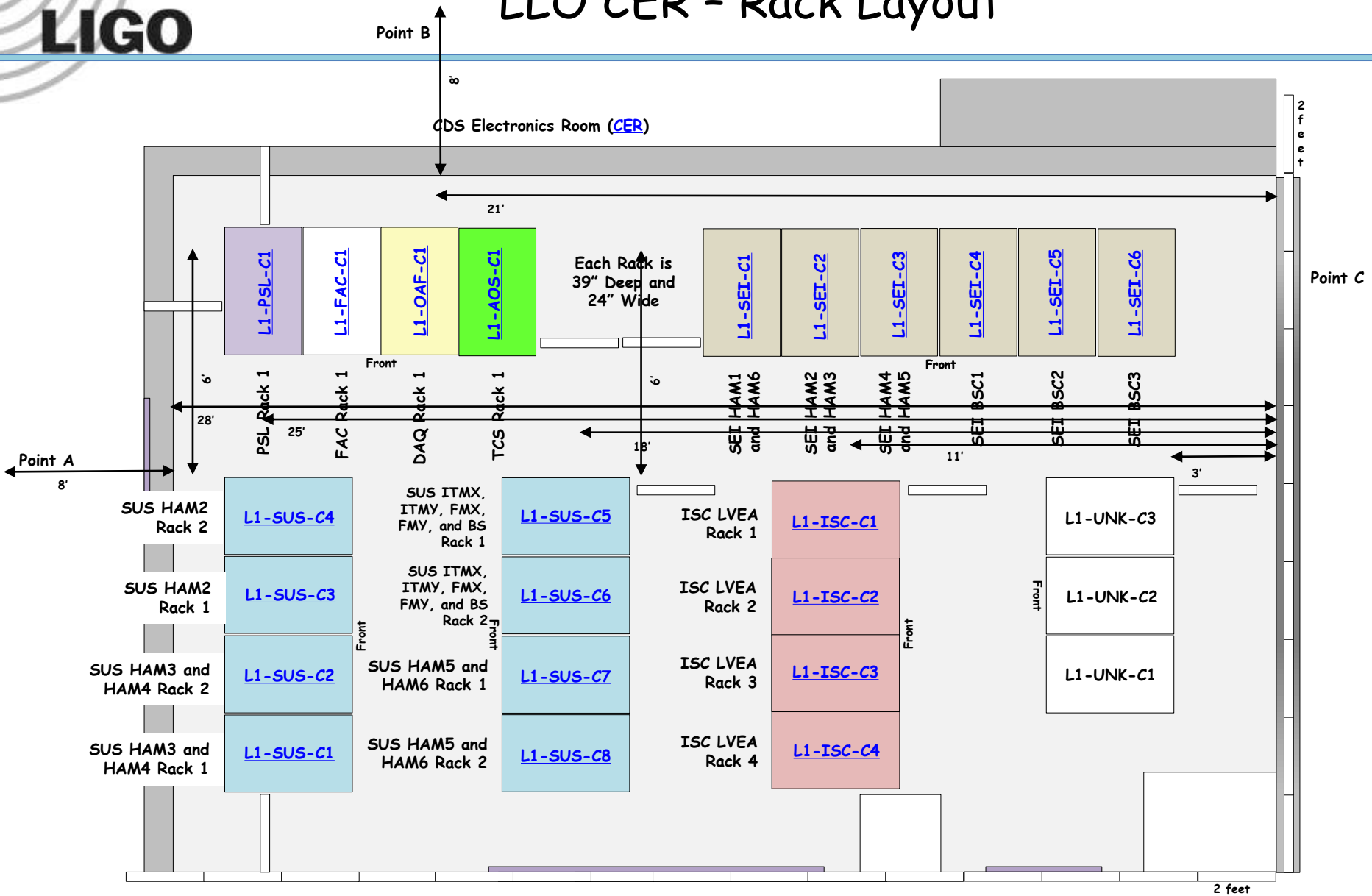

[<< LLO Corner Station](#)

[<< LLO Racks by AREA](#)

[<< LLO CDS Components](#)

LDR

LLO LDR - Rack Layout

- << [LLO Corner Station](#)
- << [LLO Racks by AREA](#)
- << [LLO CDS Components](#)

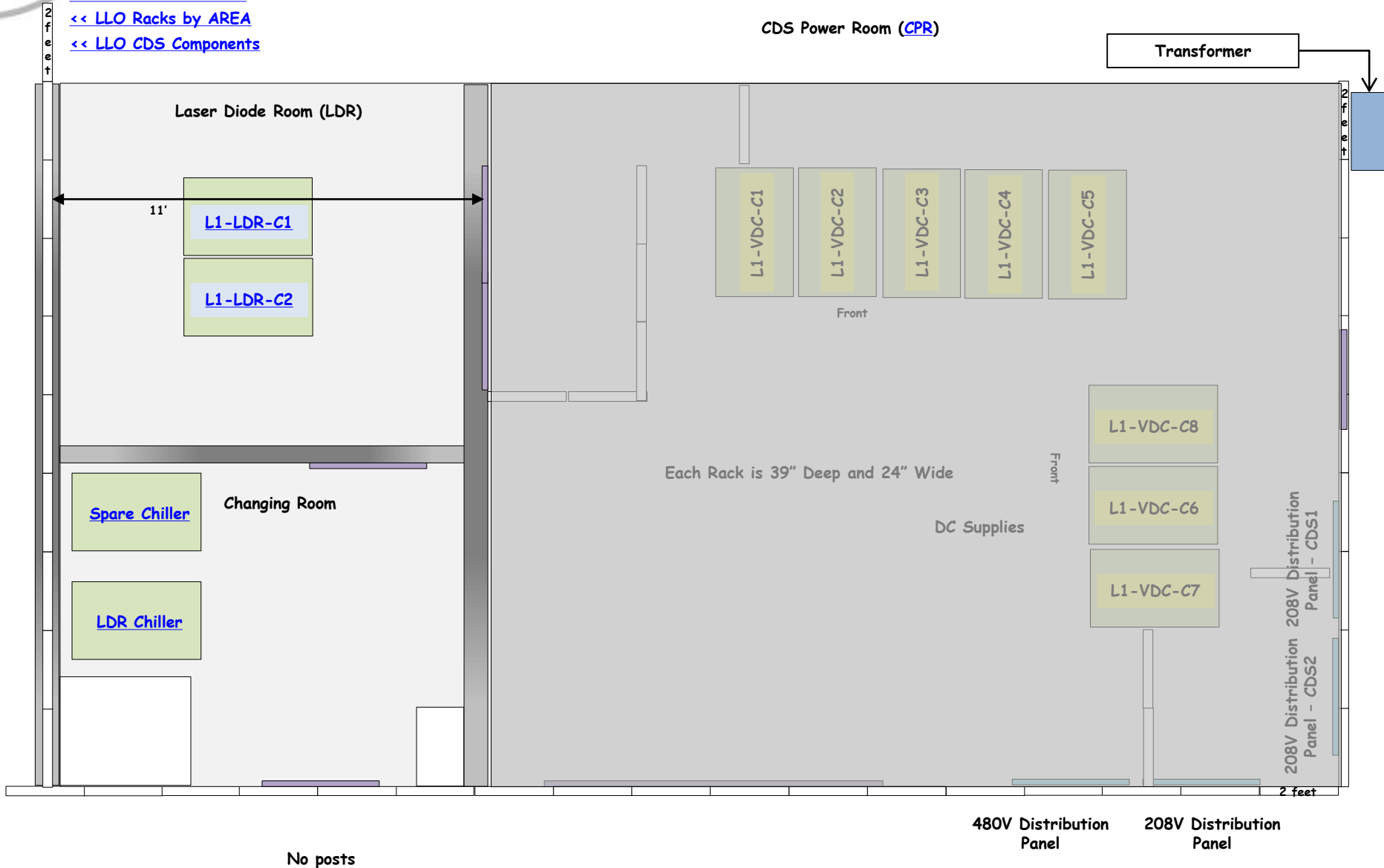

LLO LDR - 10ft Cable Tray Layout

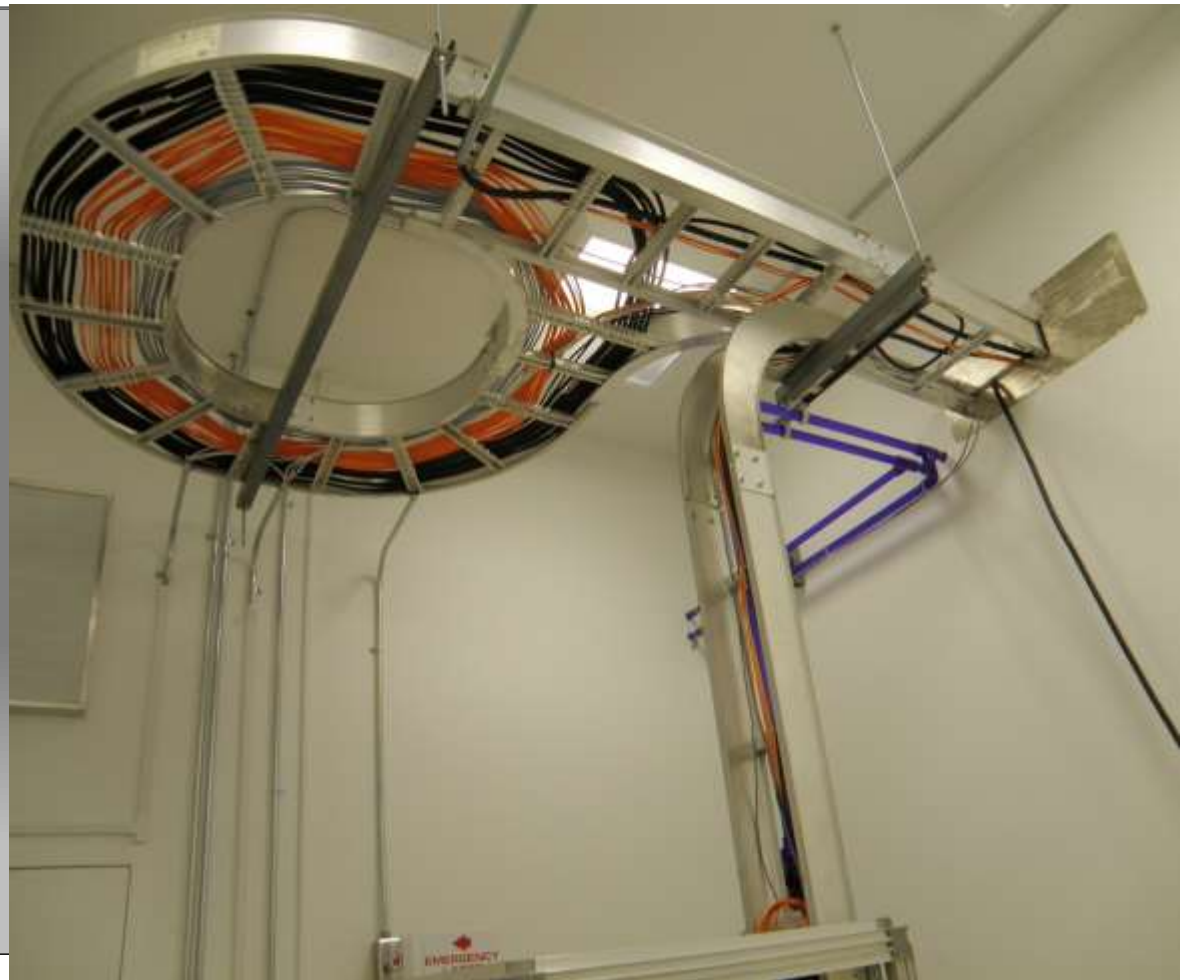
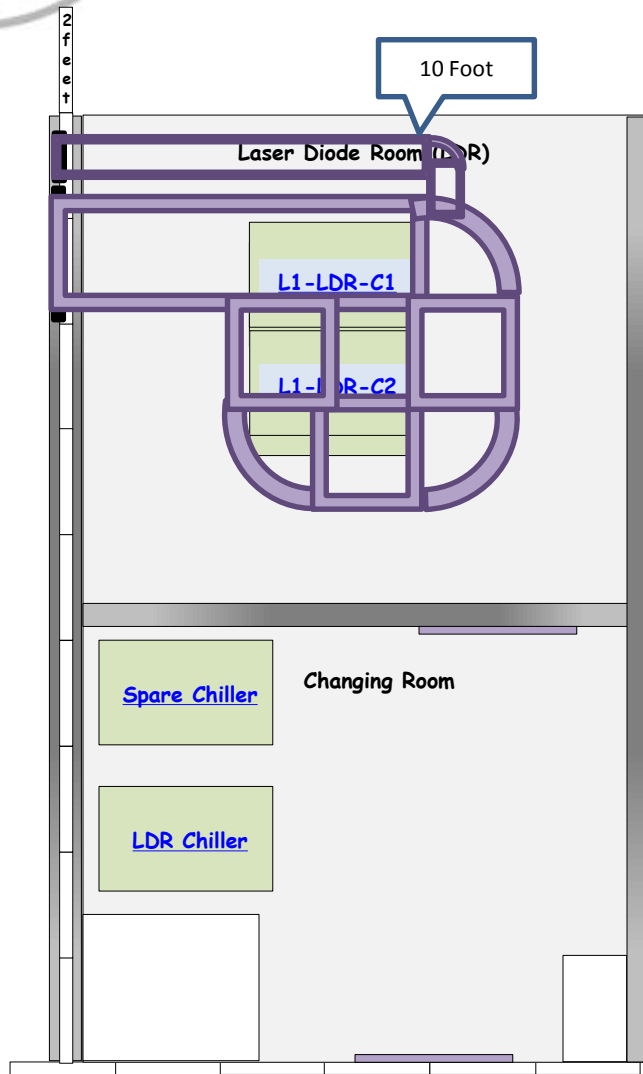

No posts

[<< LLO Corner Station](#)

[<< LLO Racks by AREA](#)

[<< LLO CDS Components](#)

CPR

LLO CPR - Rack Layout

- << [LLO Corner Station](#)
- << [LLO Racks by AREA](#)
- << [LLO CDS Components](#)

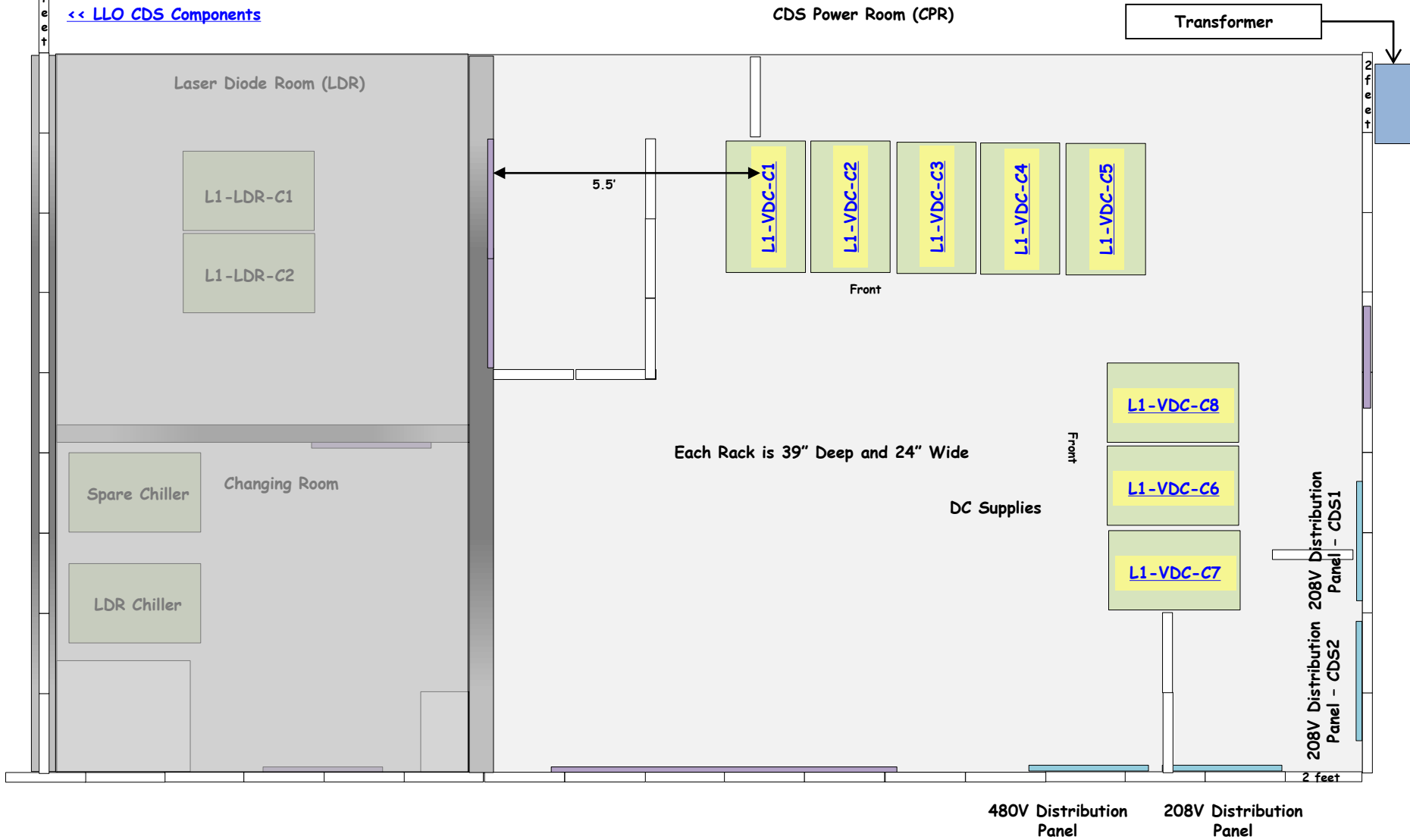

LLO CPR - 8.5ft (AC) Cable Tray Layout

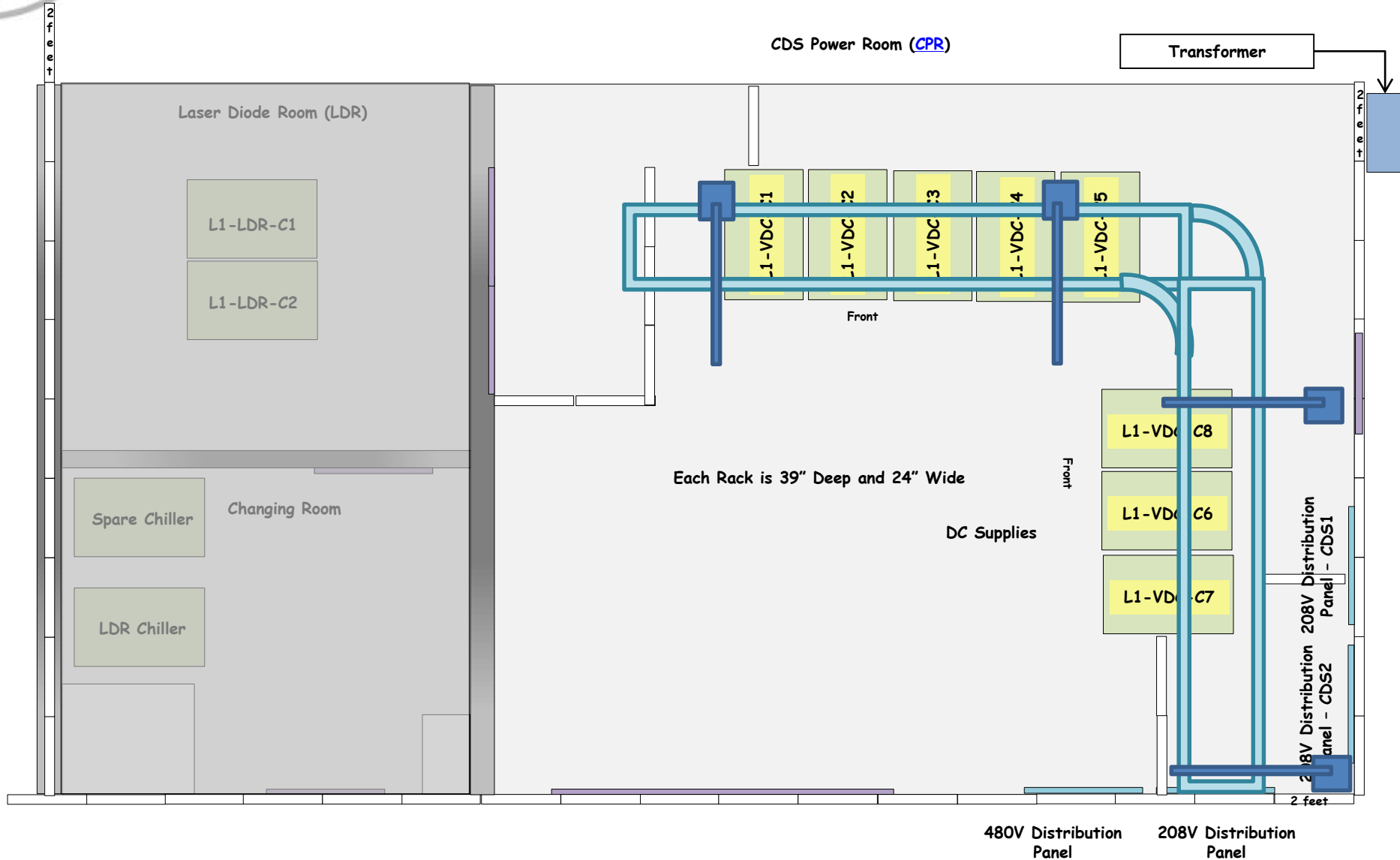

All posts are F-Posts

480V Distribution Panel

208V Distribution Panel

LLO CPR - 10ft (DC) Cable Tray

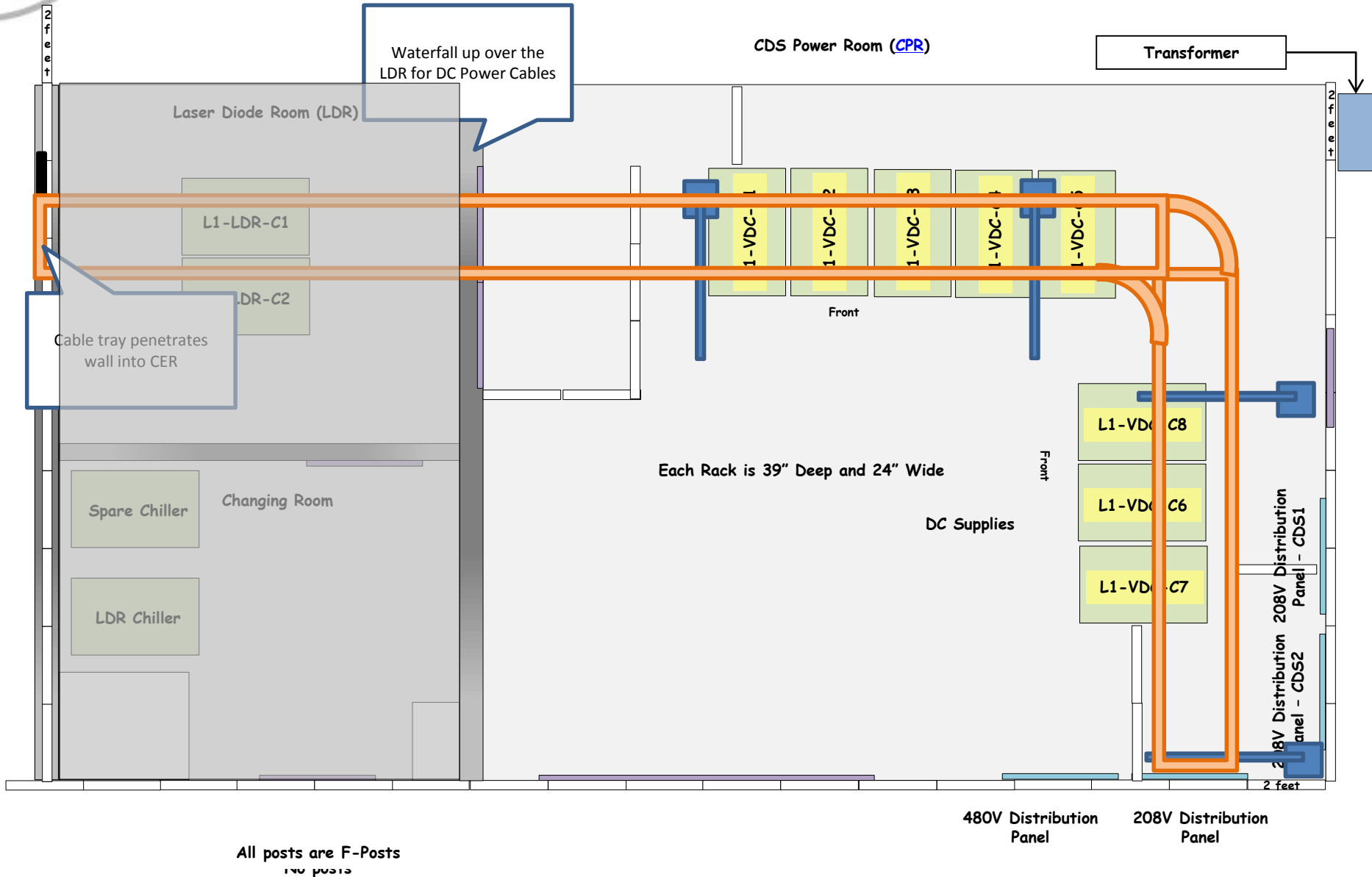

- [<< LLO Corner Station](#)
- [<< LLO Racks by AREA](#)
- [<< LLO CDS Components](#)
- [<< LLO Racks by Subsystem](#)

VDC

[DC Power Supplies >>](#)

[CPR Rack Layout >>](#)

[CERX DC Rack Layout >>](#)

[CERY DC Rack Layout >>](#)

[KEPCO BHK500-80MG](#)

[KEPCO JQE25-20MVPY27274](#)

[KEPCO JQE36-30M](#)

Picture: Front Panel

Picture: Rear Panel

Specifications

Inventory of Serial Numbers / Dates received / scheduled maintenance / assigned use / etc.

Acceptance Testing: LIGO-Txxxxxxx

[<< DC Power Supplies](#)

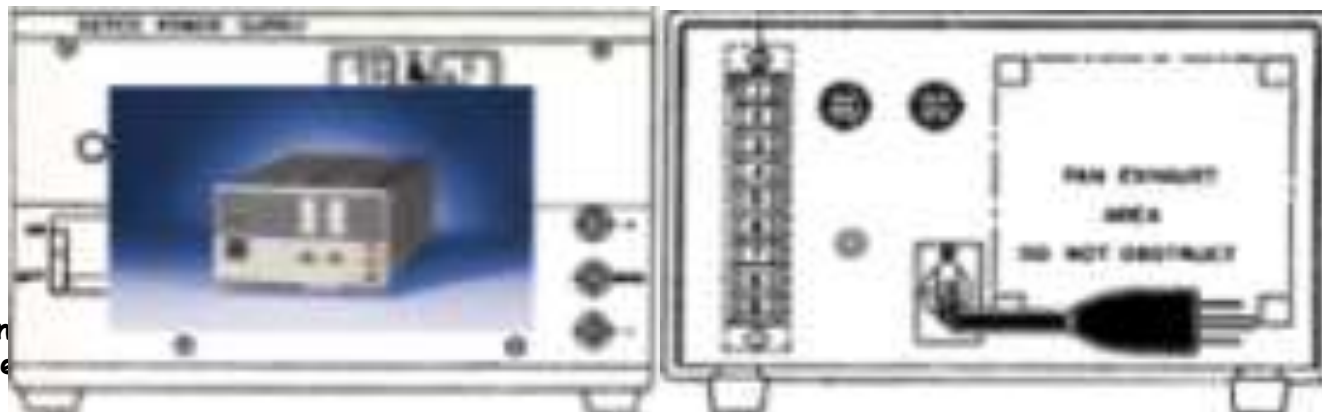

Picture: Front Panel

Picture: Rear Panel

Specifications

Inventory of Serial Numbers / Dates received / scheduled maintenance / assigned use / etc.

Acceptance Testing: [LIGO-T1100478](#)

Picture: Front Panel

Picture: Rear Panel

Specifications

**Inventory of Serial Numbers / Dates received / scheduled
maintenance / assigned use / etc.**

Acceptance Testing: LIGO-Txxxxxxx

DC Power Rack - Required VDC

5 Standard Banks
per Rack

10 x 4U => 40U

DC Power Rack



A Standard Bank (SB) of power supplies consists of 4 supplies, and services 1 Electronics Rack.

The 4 supplies are:
+18V@20A, -18V@20A,
+24V@20A, and -24V@20A.

Each Standard Bank of DC Power Supplies provides

$18V * 20A \Rightarrow 360W$
 $360W * 2 PS \Rightarrow 720W$
 $24V * 20A \Rightarrow 480W$
 $480W * 2 PS \Rightarrow 960W$
 $720W + 960W \Rightarrow 1680W$

There are 5 SB (20 PS) / Power Rack. Each Power Rack therefore provides 8400W

Each Power Rack services 5 Electronics Racks.

There are roughly 22 racks per interferometer.

Therefore 5 DC Power Racks are required and will **provide** for a total of 42,000 W.

DC Power Rack - Required VAC

5 Standard Banks
per Rack

10 x 4U => 40U

DC Power Rack

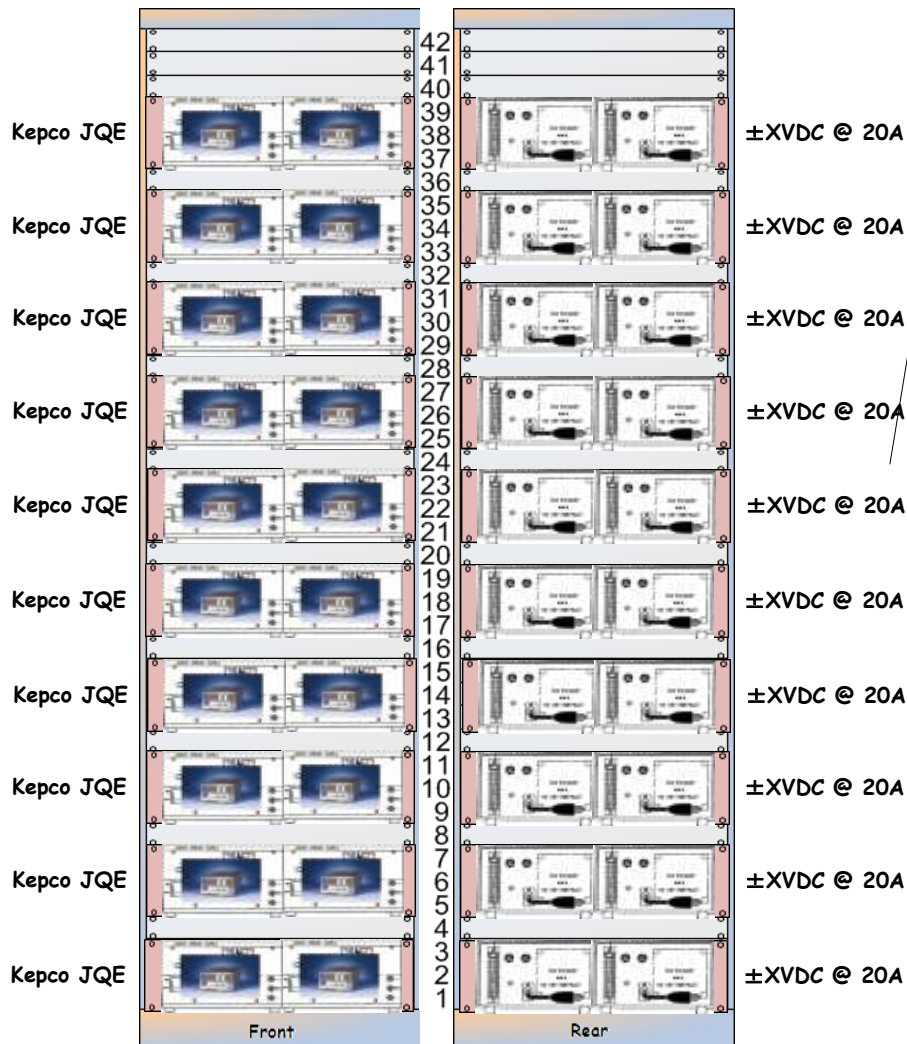

A Standard Bank (SB) of power supplies consists of 4 supplies, and services 1 Electronics Rack.

The 4 supplies are:
+18V@20A, -18V@20A,
+24V@20A, and -24V@20A.

Each (~JQE25-20M) DC Power Supply requires 10.5A @ 125VAC

Each Standard Bank of DC Power Supplies requires 42A @ 125VAC

There are 5 SB (20 PS) / Power Rack. Each Power Rack therefore requires 210A @ 125VAC.

10 - 125V@20A circuits per Power Rack should suffice.

Each Power Rack services 5 Electronics Racks.

There are roughly 22 racks per interferometer.

70 - 125V @20A circuits are required for a total of 183,750W.

Therefore 2 - 480VAC * 200A circuits would provide 192,000W

DC Power Rack - VAC Wiring

DC Power Rack

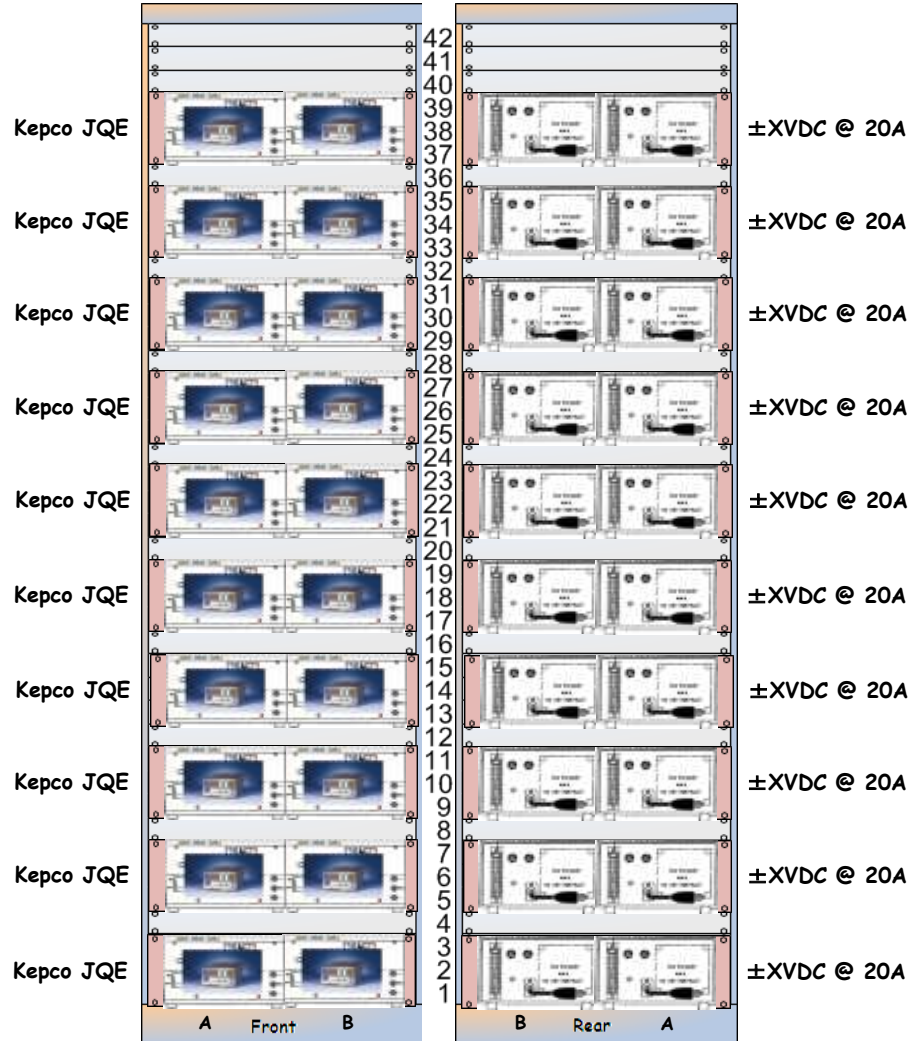

12 @ 125V, 20A Circuits per Rack

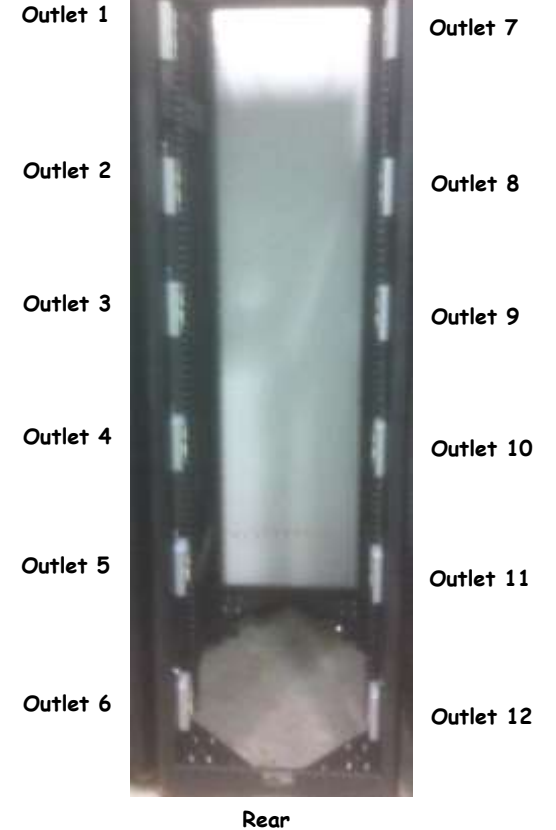

L1-VDC-C1 Power Racks - Required Supplies

<< CPR

L1-VDC-C1 Corner Station DC Power Rack Layout ([D1200890](#)) ([S1105247](#))

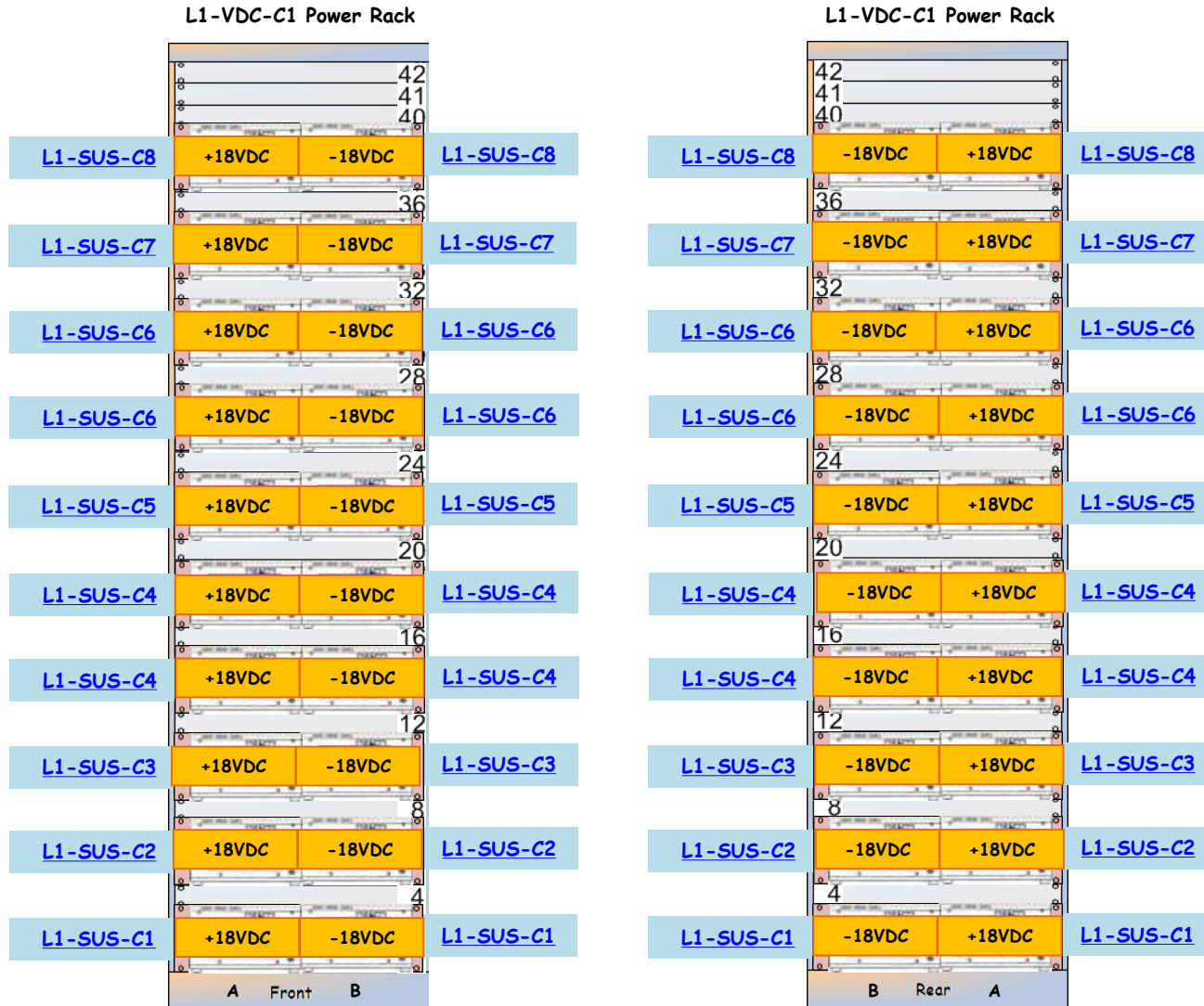

[Cable Runs >>](#)

L1-VDC-C1 Cable Runs

<< [L1-VDC-C1](#)

L1-VDC-C1 Corner Station DC Cable Runs ([D1200890](#)) ([S1105247](#))

L1-VDC-C1 S1105247	Power Panel	Circuit	DC Power Rack	Outlet	Plug Position	Rack U	Power Supply Model	Power Supply Serial	Polarity	DC Extension Cable	Electronics Rack	DC Power Strip
1	CDS-1	06	L1-VDC-C1	08	Top	U37-A (Left)	JQE 25V 20A	H236464	Plus	PTO-001	L1-SUS-C8	PSO-001
2	CDS-1	06	L1-VDC-C1	08	Bottom	U37-B (Right)	JQE 25V 20A	H236467	Minus	PTO-001	L1-SUS-C8	PSO-001
3	CDS-1	27	L1-VDC-C1	02	Top	U33-A (Left)	JQE 25V 20A	H236434	Plus	PTO-002	L1-SUS-C7	PSO-002
4	CDS-1	27	L1-VDC-C1	02	Bottom	U33-B (Right)	JQE 25V 20A	H236427	Minus	PTO-002	L1-SUS-C7	PSO-002
5	CDS-1	08	L1-VDC-C1	09	Top	U29-A (Left)	JQE 25V 20A	H236468	Plus	PTO-021	L1-SUS-C6A	PSO-003
6	CDS-1	08	L1-VDC-C1	09	Bottom	U29-B (Right)	JQE 25V 20A	H236372-R1	Minus	PTO-021	L1-SUS-C6A	PSO-003
7	CDS-1	29	L1-VDC-C1	03	Top	U25-A (Left)	JQE 25V 20A	H236447	Plus	PTO-003	L1-SUS-C6B	PSO-021
8	CDS-1	29	L1-VDC-C1	03	Bottom	U25-B (Right)	JQE 25V 20A	H236463	Minus	PTO-003	L1-SUS-C6B	PSO-021
9	CDS-1	10	L1-VDC-C1	10	Top	U21-A (Left)	JQE 25V 20A	H236388	Plus	PTO-004	L1-SUS-C5	PSO-004
10	CDS-1	10	L1-VDC-C1	10	Bottom	U21-B (Right)	JQE 25V 20A	H236406	Minus	PTO-004	L1-SUS-C5	PSO-004
11	CDS-1	31	L1-VDC-C1	04	Top	U17-A (Left)	JQE 25V 20A	H236396	Plus	PTO-005	L1-SUS-C4A	PSO-005
12	CDS-1	31	L1-VDC-C1	04	Bottom	U17-B (Right)	JQE 25V 20A	H236404	Minus	PTO-005	L1-SUS-C4A	PSO-005
13	CDS-1	12	L1-VDC-C1	11	Top	U13-A (Left)	JQE 25V 20A	H236418	Plus	PTO-022	L1-SUS-C4B	PSO-022
14	CDS-1	12	L1-VDC-C1	11	Bottom	U13-B (Right)	JQE 25V 20A	H236424	Minus	PTO-022	L1-SUS-C4B	PSO-022
15	CDS-1	33	L1-VDC-C1	05	Top	U09-A (Left)	JQE 25V 20A	H236469	Plus	PTO-006	L1-SUS-C3	PSO-006
16	CDS-1	33	L1-VDC-C1	05	Bottom	U09-B (Right)	JQE 25V 20A	H236443	Minus	PTO-006	L1-SUS-C3	PSO-006
17	CDS-1	14	L1-VDC-C1	12	Top	U05-A (Left)	JQE 25V 20A	H210616	Plus	PTO-007	L1-SUS-C2	PSO-007
18	CDS-1	14	L1-VDC-C1	12	Bottom	U05-B (Right)	JQE 25V 20A	H210622	Minus	PTO-007	L1-SUS-C2	PSO-007
19	CDS-1	02	L1-VDC-C1	06	Top	U01-A (Left)	JQE 25V 20A	H210617	Plus	PTO-008	L1-SUS-C1	PSO-008
20	CDS-1	02	L1-VDC-C1	06	Bottom	U01-B (Right)	JQE 25V 20A	H210619	Minus	PTO-008	L1-SUS-C1	PSO-008
D1200890												

L1-VDC-C2 Power Racks - Required Supplies

<< CPR

L1-VDC-C2 Corner Station DC Power Rack Layout ([D1200891](#)) ([S1105248](#))

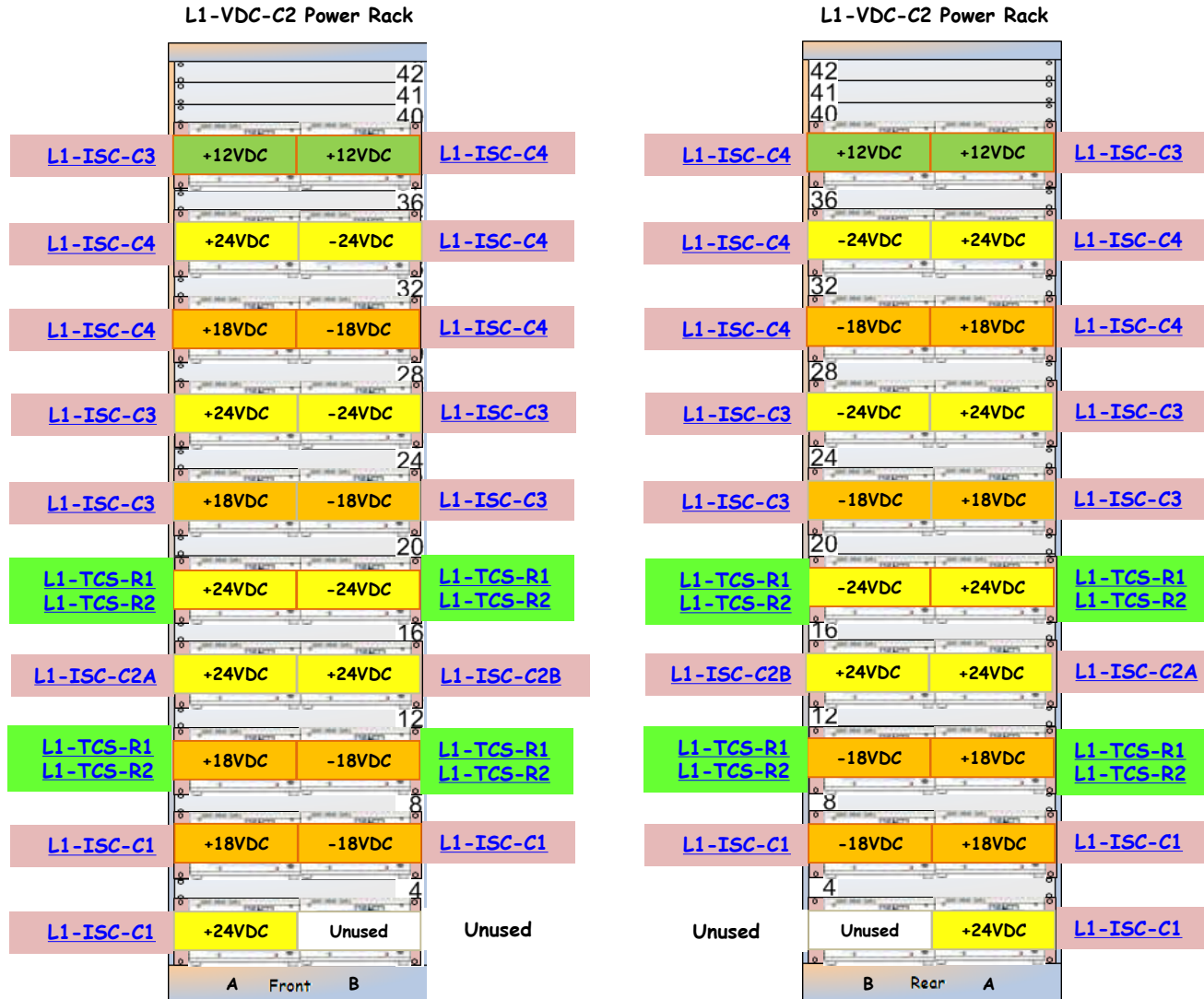

[Cable Runs >>](#)

L1-VDC-C2 Cable Runs

<< [L1-VDC-C2](#)

L1-VDC-C2 Corner Station DC Cable Runs ([D1200891](#)) ([S1105248](#))

L1-VDC-C2 S1105248	Power Panel	Circuit	DC Power Rack	Outlet	Plug Position	Rack U	Power Supply Model	Power Supply Serial	Polarity	DC Extension Cable	Electronics Rack	Cable Length	DC Power Strip
1	CDS-1	15	L1-VDC-C2	08	Top	U37-A (Left)	JQE 15V 6A		Plus	PTG-002	L1-ISC-C3		PSG-003
2	CDS-1	15	L1-VDC-C2	08	Bottom	U37-B (Right)	JQE 15V 6A		Plus	PTG-003	L1-ISC-C4		PSG-004
3	CDS-1	03	L1-VDC-C2	02	Top	U33-A (Left)	JQE 25V 20A	H236408	Plus	PTY-012	L1-ISC-C4		
4	CDS-1	03	L1-VDC-C2	02	Bottom	U33-B (Right)	JQE 25V 20A	H236466	Minus	PTY-012	L1-ISC-C4		
5	CDS-1	17	L1-VDC-C2	09	Top	U29-A (Left)	JQE 25V 20A	H236426	Plus	PTO-057	L1-ISC-C4		
6	CDS-1	17	L1-VDC-C2	09	Bottom	U29-B (Right)	JQE 25V 20A	H236439	Minus	PTO-057	L1-ISC-C4		
7	CDS-1	05	L1-VDC-C2	03	Top	U25-A (Left)	JQE 25V 20A	H236437	Plus	PTY-011	L1-ISC-C3		
8	CDS-1	05	L1-VDC-C2	03	Bottom	U25-B (Right)	JQE 25V 20A	H236425	Minus	PTY-011	L1-ISC-C3		
9	CDS-1	19	L1-VDC-C2	10	Top	U21-A (Left)	JQE 25V 20A	H236444	Plus	PTO-056	L1-ISC-C3		
10	CDS-1	19	L1-VDC-C2	10	Bottom	U21-B (Right)	JQE 25V 20A	H236471	Minus	PTO-056	L1-ISC-C3		
11	CDS-1	07	L1-VDC-C2	04	Top	U17-A (Left)	JQE 25V 20A	H236449	Plus	PTY-037 PTY-038	L1-TCS-R1 L1-TCS-R2		
12	CDS-1	07	L1-VDC-C2	04	Bottom	U17-B (Right)	JQE 25V 10A	H192374	Minus	PTY-037 PTY-038	L1-TCS-R1 L1-TCS-R2		
13	CDS-1	21	L1-VDC-C2	11	Top	U13-A (Left)	JQE 25V 20A	H236430	Plus	L1-TB07	L1-ISC-C2A		
14	CDS-1	21	L1-VDC-C2	11	Bottom	U13-B (Right)	JQE 25V 20A	H236445	Minus	PTY-047	L1-ISC-C2B		
15	CDS-1	09	L1-VDC-C2	05	Top	U09-A (Left)	JQE 25V 20A	H236395	Plus	PTO-037 PTO-038	L1-TCS-R1 L1-TCS-R2		
16	CDS-1	09	L1-VDC-C2	05	Bottom	U09-B (Right)	JQE 25V 20A	H236438	Minus	PTO-037 PTO-038	L1-TCS-R1 L1-TCS-R2		
17	CDS-1	23	L1-VDC-C2	12	Top	U05-A (Left)	JQE 25V 20A	H236475	Plus	PTO-054	L1-ISC-C1		
18	CDS-1	23	L1-VDC-C2	12	Bottom	U05-B (Right)	JQE 25V 20A	H236455	Minus	PTO-054	L1-ISC-C1		
19	CDS-1	06	L1-VDC-C2	06	Top	U01-A (Left)	JQE 25V 20A	H236399	Plus	L1-TB02	L1-ISC-C1		
20	CDS-1	06	L1-VDC-C2	06	Bottom	U01-B (Right)	JQE 25V 20A	H236407	Plus		L1-ISC-C2		
D1200891													

L1-VDC-C3 Power Racks - Required Supplies

<< CPR

L1-VDC-C3 Corner Station DC Power Rack Layout ([D1200892](#)) ([S1105249](#))

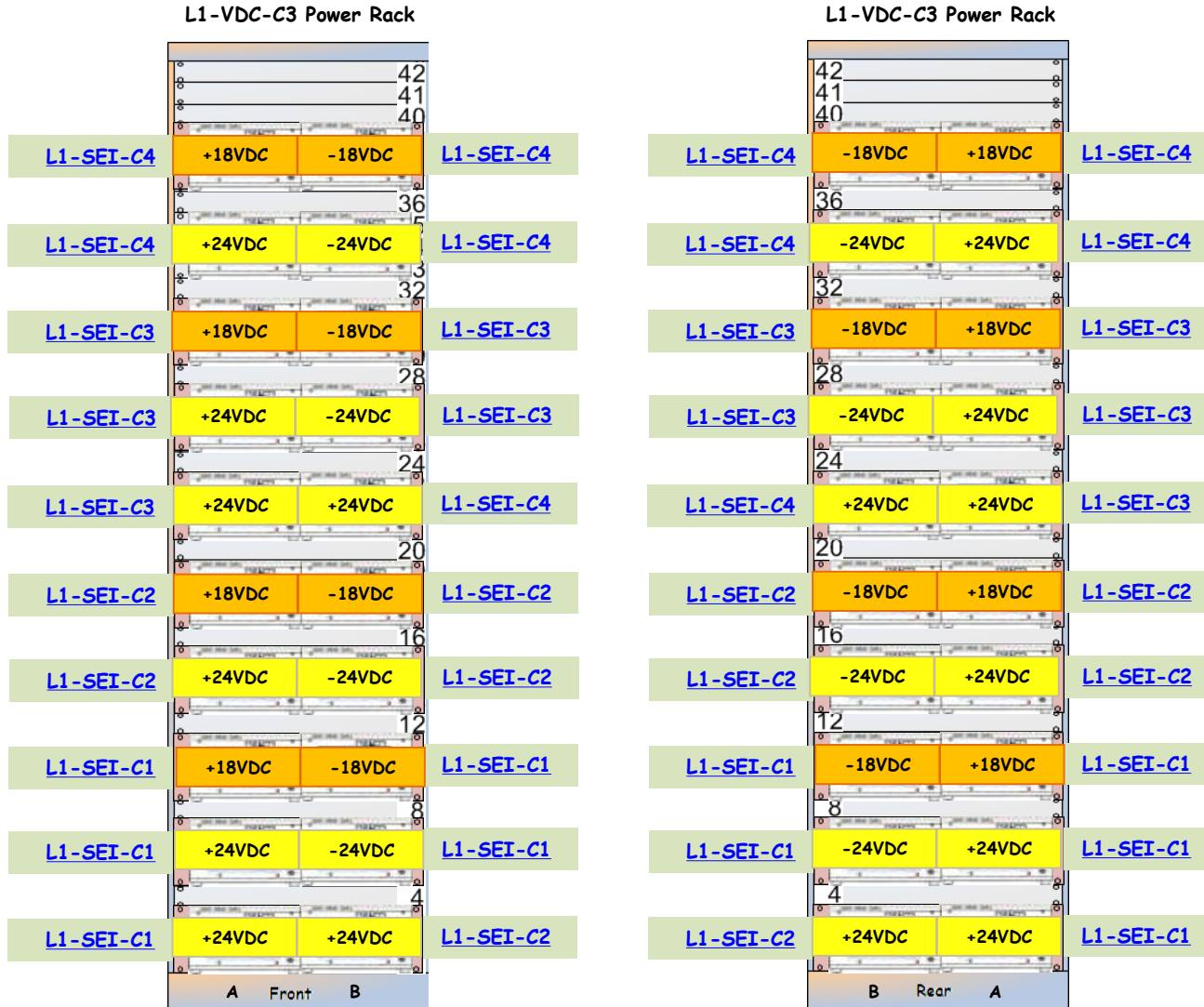

[Cable Runs >>](#)

L1-VDC-C3 Cable Runs

<< [L1-VDC-C3](#)

L1-VDC-C3 Corner Station DC Cable Runs ([D1200892](#)) ([S1105249](#))

L1-VDC-C3 S1105249	Power Panel	Circuit	DC Power Rack	Outlet	Plug Position	Rack U	Power Supply Model	Power Supply Serial	Polarity	DC Extension Cable	Electronics Rack	Cable Length	DC Power Strip
1	CDS-2	15	L1-VDC-C3	08	Top	U37-A (Left)	JQE 25V 20A	H236457	Plus	PTO-014	L1-SEI-C4		PSO-014
2	CDS-2	15	L1-VDC-C3	08	Bottom	U37-B (Right)	JQE 25V 20A	H236456	Minus	PTO-014	L1-SEI-C4		PSO-014
3	CDS-2	03	L1-VDC-C3	02	Top	U33-A (Left)	JQE 25V 20A	H236450	Plus	PTY-013	L1-SEI-C4		PSY-013
4	CDS-2	03	L1-VDC-C3	02	Bottom	U33-B (Right)	JQE 25V 20A	H236454	Minus	PTY-013	L1-SEI-C4		PSY-013
5	CDS-2	17	L1-VDC-C3	09	Top	U29-A (Left)	JQE 25V 20A	H236452	Plus	PTO-015	L1-SEI-C3		PSO-015
6	CDS-2	17	L1-VDC-C3	09	Bottom	U29-B (Right)	JQE 25V 20A	H236451	Minus	PTO-015	L1-SEI-C3		PSO-015
7	CDS-2	05	L1-VDC-C3	03	Top	U25-A (Left)	JQE 25V 20A	H236458	Plus	PTY-014	L1-SEI-C3		PSY-014
8	CDS-2	05	L1-VDC-C3	03	Bottom	U25-B (Right)	JQE 25V 20A	H236432	Minus	PTY-014	L1-SEI-C3		PSY-014
9	CDS-2	19	L1-VDC-C3	10	Top	U21-A (Left)	JQE 25V 20A	H236435	Plus	PTY-015	L1-SEI-C3		PSY-015
10	CDS-2	19	L1-VDC-C3	10	Bottom	U21-B (Right)	JQE 25V 20A	H236436	Plus	PTY-016	L1-SEI-C4		PSY-016
11	CDS-2	07	L1-VDC-C3	04	Top	U17-A (Left)	JQE 25V 20A	H236402	Plus	PTO-016	L1-SEI-C2		PSO-016
12	CDS-2	07	L1-VDC-C3	04	Bottom	U17-B (Right)	JQE 25V 20A	H236477	Minus	PTO-016	L1-SEI-C2		PSO-016
13	CDS-2	21	L1-VDC-C3	11	Top	U13-A (Left)	JQE 25V 20A	H236384	Plus	PTY-017	L1-SEI-C2		PSY-017
14	CDS-2	21	L1-VDC-C3	11	Bottom	U13-B (Right)	JQE 25V 20A	H236390	Minus	PTY-017	L1-SEI-C2		PSY-017
15	CDS-2	09	L1-VDC-C3	05	Top	U09-A (Left)	JQE 25V 20A	H236383	Plus	PTO-017	L1-SEI-C1		PSO-017
16	CDS-2	09	L1-VDC-C3	05	Bottom	U09-B (Right)	JQE 25V 20A	H236391	Minus	PTO-017	L1-SEI-C1		PSO-017
17	CDS-2	23	L1-VDC-C3	12	Top	U05-A (Left)	JQE 25V 20A	H236372-R2	Plus	PTY-018	L1-SEI-C1		PSY-018
18	CDS-2	23	L1-VDC-C3	12	Bottom	U05-B (Right)	JQE 25V 20A	H236377	Minus	PTY-018	L1-SEI-C1		PSY-018
19	CDS-2	11	L1-VDC-C3	06	Top	U01-A (Left)	JQE 25V 20A	H236401	Plus	PTY-019	L1-SEI-C1		PSY-019
20	CDS-2	11	L1-VDC-C3	06	Bottom	U01-B (Right)	JQE 25V 20A	H236392	Plus	PTY-020	L1-SEI-C2		PSY-020
D1200892													

L1-VDC-C4 Power Racks - Required Supplies

<< CPR

L1-VDC-C4 Corner Station DC Power Rack Layout ([D1200893](#)) ([S1105250](#))

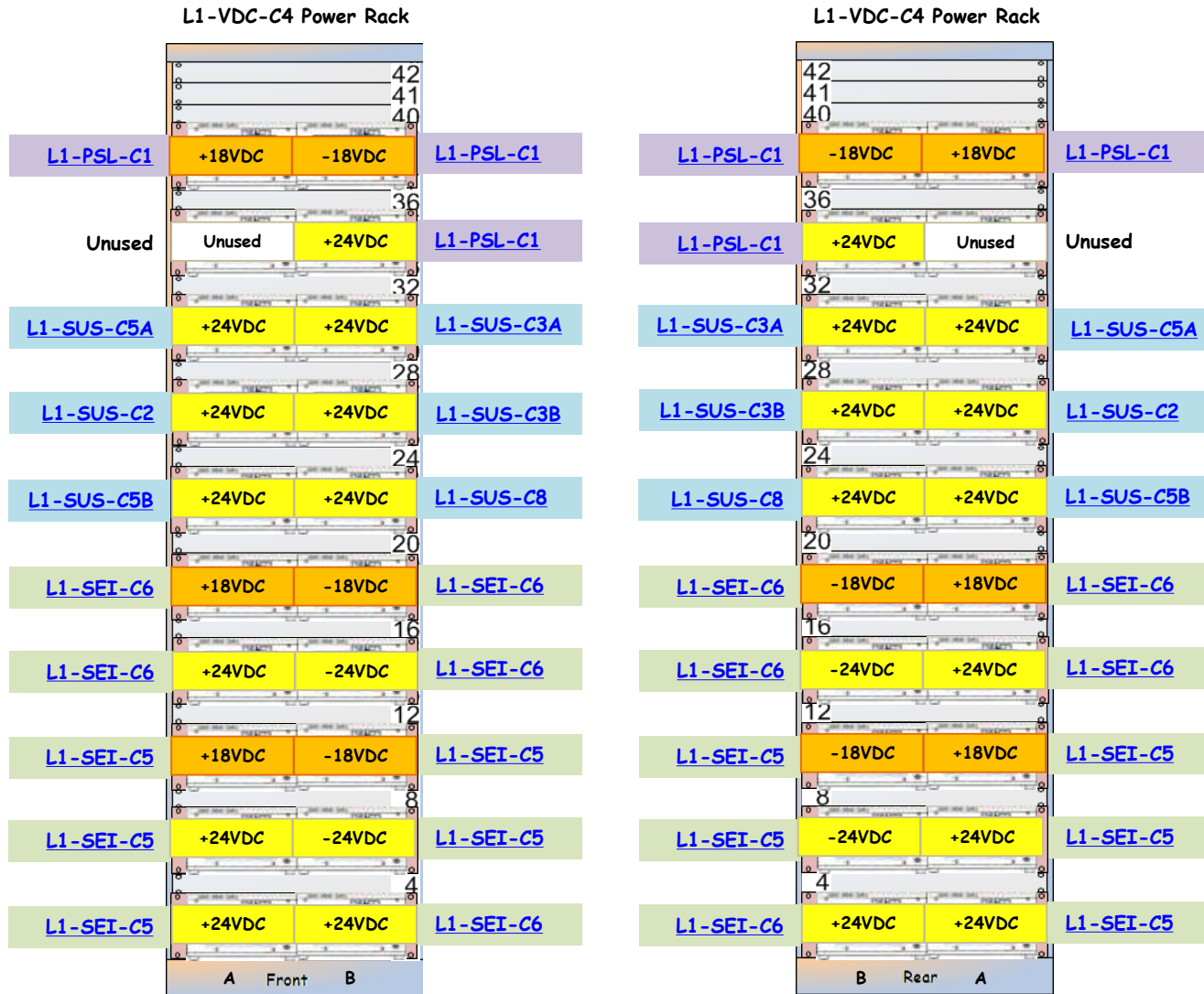

[Cable Runs >>](#)

L1-VDC-C4 Cable Runs

<< [L1-VDC-C4](#)

L1-VDC-C4 Corner Station DC Cable Runs ([D1200893](#)) ([S1105250](#))

L1-VDC-C4 S1105250	Power Panel	Circuit	DC Power Rack	Outlet	Plug Position	Rack U	Power Supply Model	Power Supply Serial	Polarity	DC Extension Cable	Electronics Rack	Cable Length	DC Power Strip
1	CDS-2	26	L1-VDC-C4	08	Top	U37-A (Left)	JQE 25V 20A	H236442	Plus	PTO-018	L1-PSL-C1		PSO-018
2	CDS-2	26	L1-VDC-C4	08	Bottom	U37-B (Right)	JQE 25V 20A	H236416	Minus	PTO-018	L1-PSL-C1		PSO-018
3	CDS-2	14	L1-VDC-C4	02	Top	U33-A (Left)	JQE 25V 20A						
4	CDS-2	14	L1-VDC-C4	02	Bottom	U33-B (Right)	JQE 25V 20A	H236453	Plus	PTY-009	L1-PSL-C1		PSY-009
5	CDS-2	28	L1-VDC-C4	09	Top	U29-A (Left)	JQE 25V 20A	H236495	Plus	PTY-002	L1-SUS-C5A		None
6	CDS-2	28	L1-VDC-C4	09	Bottom	U29-B (Right)	JQE 25V 20A	H236375	Plus	PTY-005	L1-SUS-C3A		PSY-027
7	CDS-2	16	L1-VDC-C4	03	Top	U25-A (Left)	JQE 25V 20A	H210621	Plus	L1-TB03	L1-SUS-C2		PSY-004
8	CDS-2	16	L1-VDC-C4	03	Bottom	U25-B (Right)	JQE 25V 20A	H210620	Plus	L1-TB04	L1-SUS-C3B		PSY-005
9	CDS-2	30	L1-VDC-C4	10	Top	U21-A (Left)	JQE 25V 20A	H210618	Plus	L1-TB01	L1-SUS-C5B		PSY-002
10	CDS-2	30	L1-VDC-C4	10	Bottom	U21-B (Right)	JQE 25V 20A	H236386	Plus	PTY-001	L1-SUS-C8		PSY-001
11	CDS-2	18	L1-VDC-C4	04	Top	U17-A (Left)	JQE 25V 20A	H236374	Plus	PTO-019	L1-SEI-C6		PSO-019
12	CDS-2	18	L1-VDC-C4	04	Bottom	U17-B (Right)	JQE 25V 20A	H236382	Minus	PTO-019	L1-SEI-C6		PSO-019
13	CDS-2	32	L1-VDC-C4	11	Top	U13-A (Left)	JQE 25V 20A	H236373	Plus	PTY-021	L1-SEI-C6		PSY-021
14	CDS-2	32	L1-VDC-C4	11	Bottom	U13-B (Right)	JQE 25V 20A	H236387	Minus	PTY-021	L1-SEI-C6		PSY-021
15	CDS-2	20	L1-VDC-C4	05	Top	U09-A (Left)	JQE 25V 20A	H236376	Plus	PTO-020	L1-SEI-C5		PSO-020
16	CDS-2	20	L1-VDC-C4	05	Bottom	U09-B (Right)	JQE 25V 20A	H236379	Minus	PTO-020	L1-SEI-C5		PSO-020
17	CDS-2	34	L1-VDC-C4	12	Top	U05-A (Left)	JQE 25V 20A	H236381	Plus	PTY-022	L1-SEI-C5		PSY-022
18	CDS-2	34	L1-VDC-C4	12	Bottom	U05-B (Right)	JQE 25V 20A	H236385	Minus	PTY-022	L1-SEI-C5		PSY-022
19	CDS-2	22	L1-VDC-C4	06	Top	U01-A (Left)	JQE 25V 20A	H236415	Plus	PTY-023	L1-SEI-C5		PSY-023
20	CDS-2	22	L1-VDC-C4	06	Bottom	U01-B (Right)	JQE 25V 20A	H236403	Plus	PTY-024	L1-SEI-C6		PSY-024
D1200893													

L1-VDC-C5 Power Racks - Required Supplies

<< CPR

L1-VDC-C5 Corner Station DC Power Rack Layout ([D1200894](#)) ([S1105251](#))

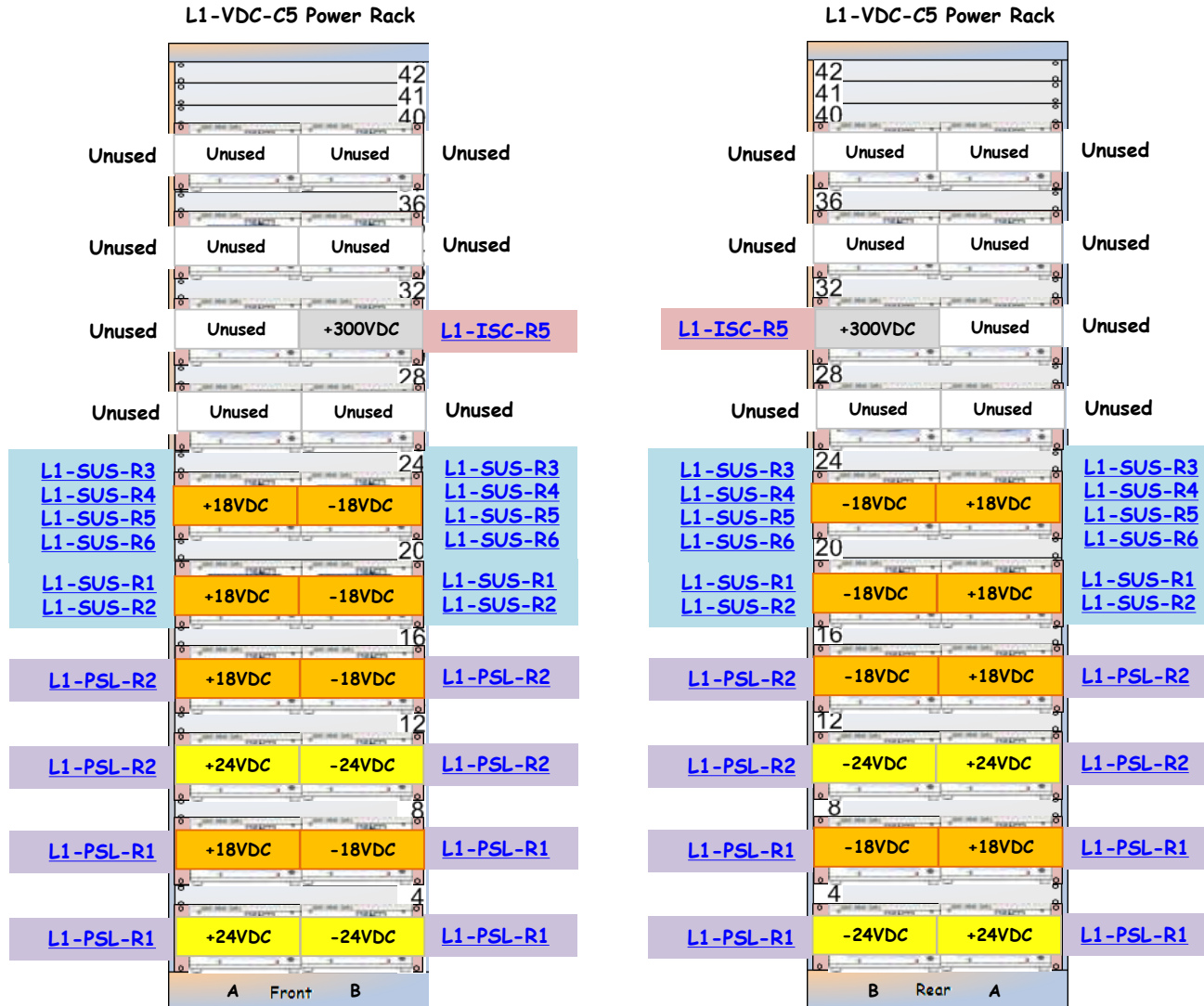

[Cable Runs >>](#)

L1-VDC-C5 Cable Runs

<< [L1-VDC-C5](#)

L1-VDC-C5 Corner Station DC Cable Runs ([D1200894](#)) ([S1105251](#))

L1-VDC-C5 S1105251	Power Panel	Circuit	DC Power Rack	Outlet	Plug Position	Rack U	Power Supply Model	Power Supply Serial	Polarity	DC Extension Cable	Electronics Rack	Cable Length	DC Power Strip
1	CDS-1	25	L1-VDC-C5	08	Top	U37-A (Left)							
2	CDS-1	25	L1-VDC-C5	08	Bottom	U37-B (Right)	PCX 100-0.2MAT PCS 40-0.5MAT						
3	CDS-2	13	L1-VDC-C5	02	Top	U33-A (Left)	JQE 25V 4A JQE 25V 4A						
4	CDS-2	13	L1-VDC-C5	02	Bottom	U33-B (Right)	PCX 100-0.2MAT PCS 40-0.5MAT						
5	CDS-1	13	L1-VDC-C5	09	Top	U29-A (Left)	BHK 300V 130mA	A107948	Plus		L1-ISC-R5		
6	CDS-1	13	L1-VDC-C5	09	Bottom	U29-B (Right)	BHK 300V 130mA	A100472	Plus	PBX-005	L1-ISC-R5		
7	CDS-2	38	L1-VDC-C5	03	Top	U25-A (Left)	JQE 150V 3.5A	H179839					
8	CDS-2	38	L1-VDC-C5	03	Bottom	U25-B (Right)	JQE 150V 3.5A	H179837					
9	CDS-1	01	L1-VDC-C5	10	Top	U21-A (Left)	JQE 25V 20A	H236420	Plus	PTO-027 PTO-028 PTO-029 PTO-030	L1-SUS-R3 L1-SUS-R4 L1-SUS-R5 L1-SUS-R6		PSO-027 PSO-028 PSO-029 PSO-030
10	CDS-1	01	L1-VDC-C5	10	Bottom	U21-B (Right)	JQE 25V 20A	H236378	Minus	PTO-027 PTO-028 PTO-029 PTO-030	L1-SUS-R3 L1-SUS-R4 L1-SUS-R5 L1-SUS-R6		PSO-027 PSO-028 PSO-029 PSO-030
11	CDS-2	12	L1-VDC-C5	04	Top	U17-A (Left)	JQE 25V 20A	H236409	Plus	PTO-023 PTO-024	L1-SUS-R1 L1-SUS-R2		PSO-023 PSO-024
12	CDS-2	12	L1-VDC-C5	04	Bottom	U17-B (Right)	JQE 25V 20A	H236410	Minus	PTO-023 PTO-024	L1-SUS-R1 L1-SUS-R2		PSO-023 PSO-024
13	CDS-1	04	L1-VDC-C5	11	Top	U13-A (Left)	JQE 25V 20A	H236380	Plus	PTO-025	L1-PSL-R2		PSO-025
14	CDS-1	04	L1-VDC-C5	11	Bottom	U13-B (Right)	JQE 25V 20A	H236465	Minus	PTO-025	L1-PSL-R2		PSO-025
15	CDS-2	24	L1-VDC-C5	05	Top	U09-A (Left)	JQE 25V 20A	H236459	Plus	PTY-025	L1-PSL-R2		PSY-025
16	CDS-2	24	L1-VDC-C5	05	Bottom	U09-B (Right)	JQE 25V 20A	H236394	Minus	PTY-025	L1-PSL-R2		PSY-025
17	CDS-2	01	L1-VDC-C5	12	Top	U05-A (Left)	JQE 25V 20A	H236397	Plus	PTO-026	L1-PSL-R1		PSO-026
18	CDS-2	01	L1-VDC-C5	12	Bottom	U05-B (Right)	JQE 25V 20A	H236400	Minus	PTO-026	L1-PSL-R1		PSO-026
19	CDS-2	36	L1-VDC-C5	06	Top	U01-A (Left)	JQE 25V 20A	H236393	Plus	L1-TB05	L1-PSL-R1		PSY-026
20	CDS-2	36	L1-VDC-C5	06	Bottom	U01-B (Right)	JQE 25V 20A	H236398	Minus	L1-TB05	L1-PSL-R1		PSY-026
D1200894													

L1-VDC-C6 Power Racks - Required Supplies

<< CPR

L1-VDC-C6 Corner Station DC Power Rack Layout ([D1200895](#)) ([S1105252](#))

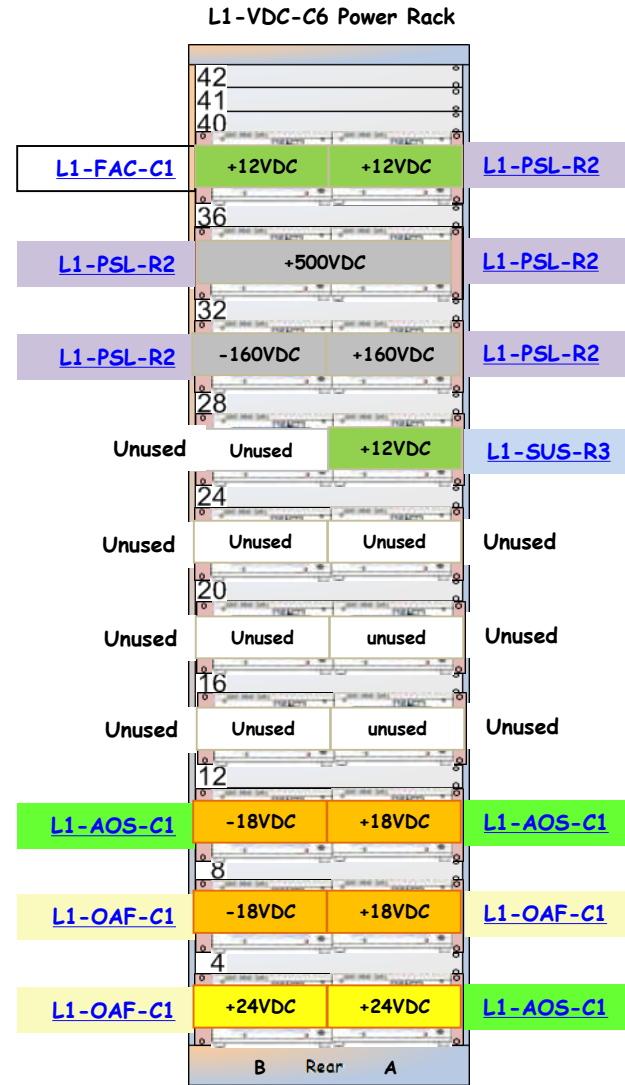
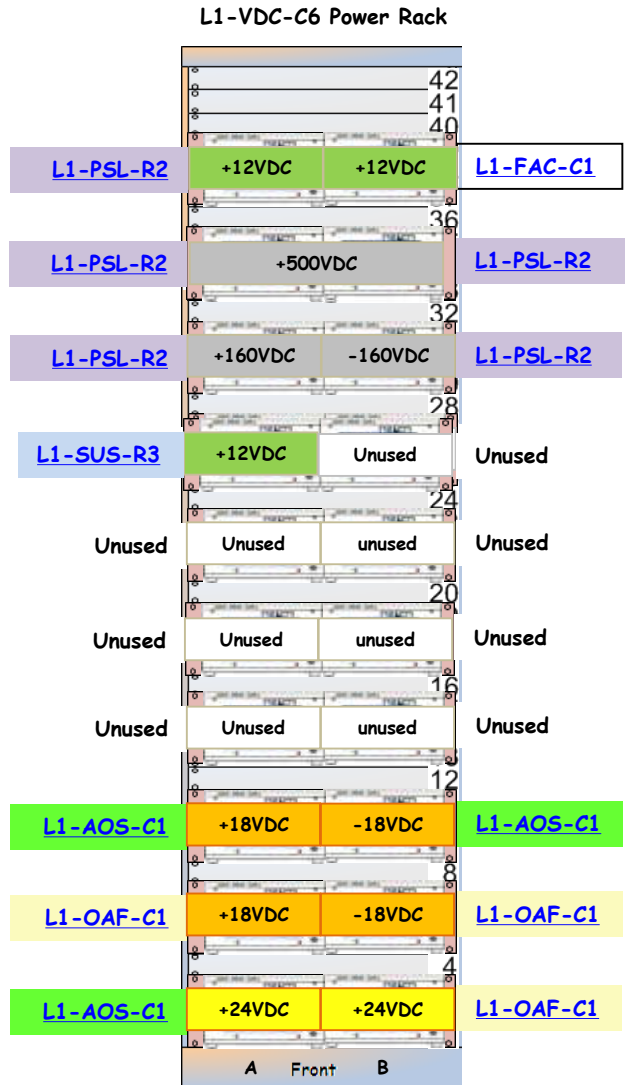

[Cable Runs >>](#)

L1-VDC-C6 Cable Runs

<< [L1-VDC-C6](#)

L1-VDC-C6 Corner Station DC Cable Runs ([D1200895](#)) ([S1105252](#))

L1-VDC-C6 S1105252	Power Panel	Circuit	DC Power Rack	Outlet	Plug Position	Rack U	Power Supply Model	Power Supply Serial	Polarity	DC Extension Cable	Electronics Rack	Cable Length	DC Power Strip
1	CDS-2	37	L1-VDC-C6	08	Top	U37-A (Left)	JQE 15V 6A		Plus	PTB-001	L1-PSL-R2		PSG-002
2	CDS-2	37	L1-VDC-C6	08	Bottom	U37-B (Right)	JQE 15V 6A		Plus	PTG-001	L1-FAC-C1	-	PSG-001
3	CDS-2	31	L1-VDC-C6	02	Top	U33-A (Left)	BHK 500V 0.4A	C72508	Plus	PBX-001	L1-PSL-R2		
4	CDS-2	31	L1-VDC-C6	02	Bottom	U33-B (Right)	BHK 500V 0.4A	C72508	Plus	PBX-001	L1-PSL-R2		
5	CDS-2	27	L1-VDC-C6	09	Top	U29-A (Left)	PCX 200V 0.1A		Plus	PBX-002	L1-PSL-R2		
6	CDS-2	27	L1-VDC-C6	09	Bottom	U29-B (Right)	PCX 200V 0.1A		Minus	PBX-002	L1-PSL-R2		
7	CDS-2	08	L1-VDC-C6	03	Top	U25-A (Left)	BHK 500V 80mA	A107262	Plus	Spare	L1-TSC-XR1		
8	CDS-2	08	L1-VDC-C6	03	Bottom	U25-B (Right)	BHK 500V 80mA	A107265	Minus	Spare	L1-TSC-YR1		
9	CDS-2	39	L1-VDC-C6	10	Top	U21-A (Left)	JQE 15V 12A	H114633	Plus	PTG-006	L1-SUS-R3		
10	CDS-2	39	L1-VDC-C6	10	Bottom	U21-B (Right)	JQE 15V 12A	H114642					
11	CDS-2	33	L1-VDC-C6	04	Top	U17-A (Left)	JQE 15V 12A	H114630					
12	CDS-2	33	L1-VDC-C6	04	Bottom	U17-B (Right)	JQE 15V 12A	H114625					
13	CDS-2	29	L1-VDC-C6	11	Top	U13-A (Left)	JQE 25V 20A	H210611					
14	CDS-2	29	L1-VDC-C6	11	Bottom	U13-B (Right)	JQE 150V 1.5A	H193672					
15	CDS-2	10	L1-VDC-C6	05	Top	U09-A (Left)	JQE 25V 20A	H236431	Plus	PTO-013	L1-AOS-C1		
16	CDS-2	10	L1-VDC-C6	05	Bottom	U09-B (Right)	JQE 25V 20A	H236470	Minus	PTO-013	L1-AOS-C1		
17	CDS-2	41	L1-VDC-C6	12	Top	U05-A (Left)	JQE 25V 20A	H236423	Plus	PTO-013	L1-OAF-C1	-	
18	CDS-2	41	L1-VDC-C6	12	Bottom	U05-B (Right)	JQE 25V 20A	H236413	Minus	PTO-013	L1-OAF-C1	-	
19	CDS-2	35	L1-VDC-C6	06	Top	U01-A (Left)	JQE 25V 20A	H236491	Plus	PTY-055	L1-AOS-C1		
20	CDS-2	35	L1-VDC-C6	06	Bottom	U01-B (Right)	JQE 25V 20A	H236472	Plus	PTY-053	L1-OAF-C1	-	
D1200895													

L1-VDC-C7 Power Racks - Required Supplies

<< CPR

L1-VDC-C7 Corner Station DC Power Rack Layout ([D1200896](#)) ([S1105253](#))

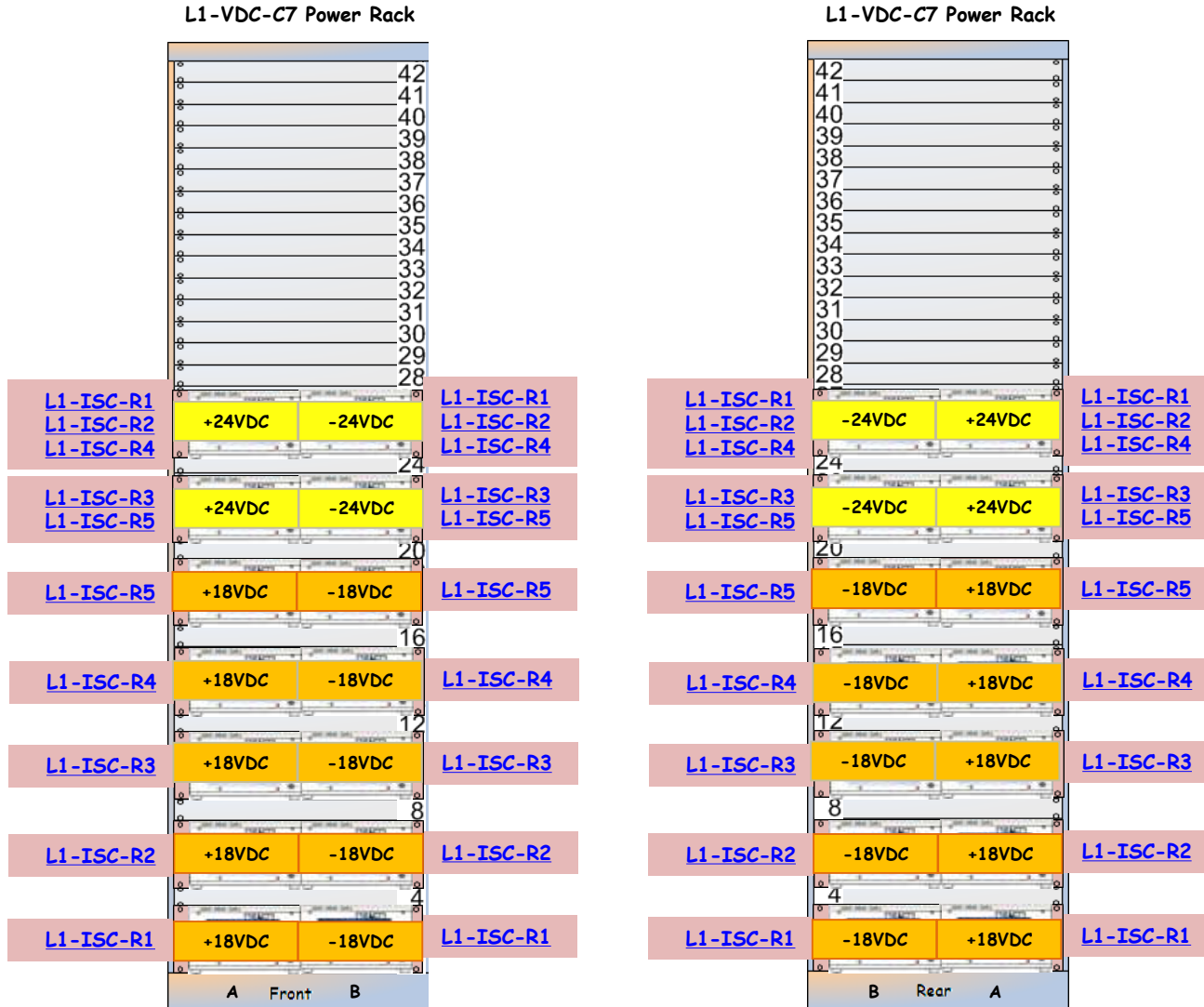

[Cable Runs >>](#)

L1-VDC-C7 Cable Runs

<< [L1-VDC-C7](#)

L1-VDC-C7 Corner Station DC Cable Runs ([D1200896](#)) ([S1105253](#))

L1-VDC-C7 S1105253	Power Panel	Circuit	DC Power Rack	Outlet	Plug Position	Rack U	Power Supply Model	Power Supply Serial	Polarity	DC Extension Cable	Electronics Rack	Cable Length	DC Power Strip
1	CDS-1	22	L1-VDC-C7	07	Top	U37-A (Left)	JQE 15V 12A	H114649					
2	CDS-1	22	L1-VDC-C7	07	Bottom	U37-B (Right)	JQE 15V 12A	H114648					
3	CDS-1	16	L1-VDC-C7	01	Top	U33-A (Left)							
4	CDS-1	16	L1-VDC-C7	01	Bottom	U33-B (Right)							
5	CDS-1	34	L1-VDC-C7	08	Top	U29-A (Left)							
6	CDS-1	34	L1-VDC-C7	08	Bottom	U29-B (Right)							
7	CDS-1	28	L1-VDC-C7	02	Top	U25-A (Left)	JQE 25V 20A	H236405	Plus	L1-TB06 PTY-048 PTY-049	L1-ISC-R1 L1-ISC-R2 L1-ISC-R4		
8	CDS-1	28	L1-VDC-C7	02	Bottom	U25-B (Right)	JQE 25V 20A	H236411	Minus	L1-TB06 PTY-048 PTY-049	L1-ISC-R1 L1-ISC-R2 L1-ISC-R4		
9	CDS-1	24	L1-VDC-C7	09	Top	U21-A (Left)	JQE 25V 20A	H236460	Plus	PTY-050 PTY-051	L1-ISC-R3 L1-ISC-R5		
10	CDS-1	24	L1-VDC-C7	09	Bottom	U21-B (Right)	JQE 25V 20A	H236433	Minus	PTY-050 PTY-051	L1-ISC-R3 L1-ISC-R5		
11	CDS-1	18	L1-VDC-C7	03	Top	U17-A (Left)	JQE 25V 20A	H236448	Plus	PTO-061	L1-ISC-R5		
12	CDS-1	18	L1-VDC-C7	03	Bottom	U17-B (Right)	JQE 25V 20A	H236446	Minus	PTO-061	L1-ISC-R5		
13	CDS-2	02	L1-VDC-C7	10	Top	U13-A (Left)	JQE 25V 20A	H236440	Plus	PTO-060	L1-ISC-R4		
14	CDS-2	02	L1-VDC-C7	10	Bottom	U13-B (Right)	JQE 25V 20A	H236485	Minus	PTO-060	L1-ISC-R4		
15	CDS-1	30	L1-VDC-C7	04	Top	U09-A (Left)	JQE 25V 20A	H236419	Plus	PTO-062	L1-ISC-R3		
16	CDS-1	30	L1-VDC-C7	04	Bottom	U09-B (Right)	JQE 25V 20A	H236412	Minus	PTO-062	L1-ISC-R3		
17	CDS-1	26	L1-VDC-C7	11	Top	U05-A (Left)	JQE 25V 20A	H236429	Plus	PTO-059	L1-ISC-R2		
18	CDS-1	26	L1-VDC-C7	11	Bottom	U05-B (Right)	JQE 25V 20A	H236462	Minus	PTO-059	L1-ISC-R2		
19	CDS-1	20	L1-VDC-C7	05	Top	U01-A (Left)	JQE 25V 20A	H236417	Plus	PTO-058	L1-ISC-R1		
20	CDS-1	20	L1-VDC-C7	05	Bottom	U01-B (Right)	JQE 25V 20A	H236421	Minus	PTO-058	L1-ISC-R1		
D1200896													

L1-VDC-C8 Power Racks - Required Supplies

[<< CPR](#)

L1-VDC-C8 Corner Station DC Power Rack Layout ([D1201137](#)) ([S1202998](#))

L1-VDC-C8 Power Rack

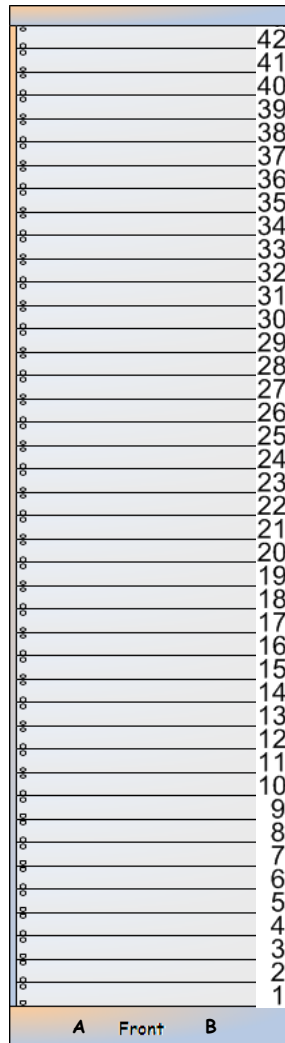

L1-VDC-C8 Power Rack

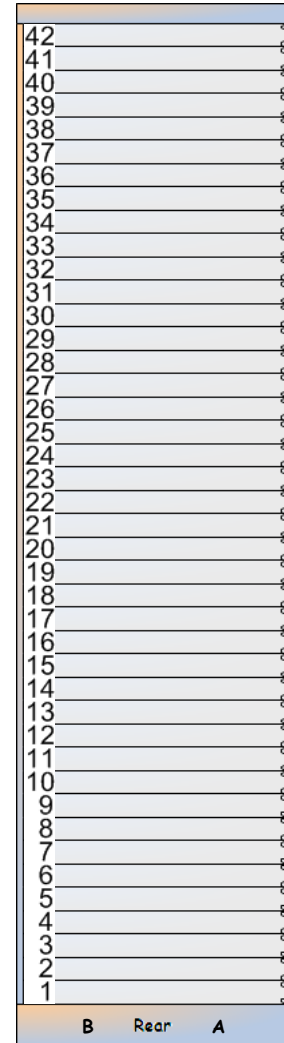

[Cable Runs >>](#)

L1-VDC-C8 Cable Runs

<< [L1-VDC-C8](#)

L1-VDC-C8 Corner Station DC Cable Runs ([D1201137](#)) ([S1202998](#))

L1-VDC-C8 S1202998	Power Panel	Circuit	DC Power Rack	Outlet	Plug Position	Rack U	Power Supply Model	Power Supply Serial	Polarity	DC Extension Cable	Electronics Rack	Cable Length	DC Power Strip
1	CDS-1	36	L1-VDC-C8	08	Top	U37-A (Left)							
2	CDS-1	36	L1-VDC-C8	08	Bottom	U37-B (Right)							
3	CDS-1	35	L1-VDC-C8	02	Top	U33-A (Left)							
4	CDS-1	35	L1-VDC-C8	02	Bottom	U33-B (Right)							
5	CDS-1	38	L1-VDC-C8	09	Top	U29-A (Left)							
6	CDS-1	38	L1-VDC-C8	09	Bottom	U29-B (Right)							
7	CDS-1	37	L1-VDC-C8	03	Top	U25-A (Left)							
8	CDS-1	37	L1-VDC-C8	03	Bottom	U25-B (Right)							
9	CDS-1	40	L1-VDC-C8	10	Top	U21-A (Left)							
10	CDS-1	40	L1-VDC-C8	10	Bottom	U21-B (Right)							
11	CDS-1	39	L1-VDC-C8	04	Top	U17-A (Left)							
12	CDS-1	39	L1-VDC-C8	04	Bottom	U17-B (Right)							
13	CDS-2	42	L1-VDC-C8	11	Top	U13-A (Left)							
14	CDS-2	42	L1-VDC-C8	11	Bottom	U13-B (Right)							
15	CDS-1	41	L1-VDC-C8	05	Top	U09-A (Left)							
16	CDS-1	41	L1-VDC-C8	05	Bottom	U09-B (Right)							
17	CDS-2	40	L1-VDC-C8	12	Top	U05-A (Left)							
18	CDS-2	40	L1-VDC-C8	12	Bottom	U05-B (Right)							
19	CDS-2	42	L1-VDC-C8	06	Top	U01-A (Left)							
20	CDS-2	42	L1-VDC-C8	06	Bottom	U01-B (Right)							
D1201137													

Other KEPCOs

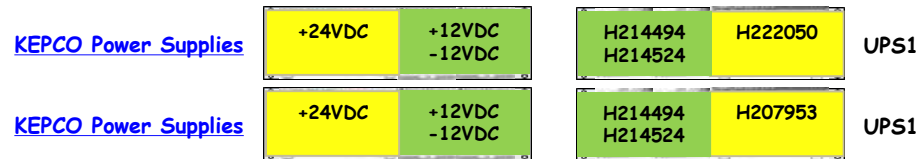

<< LLO Racks by Subsystem

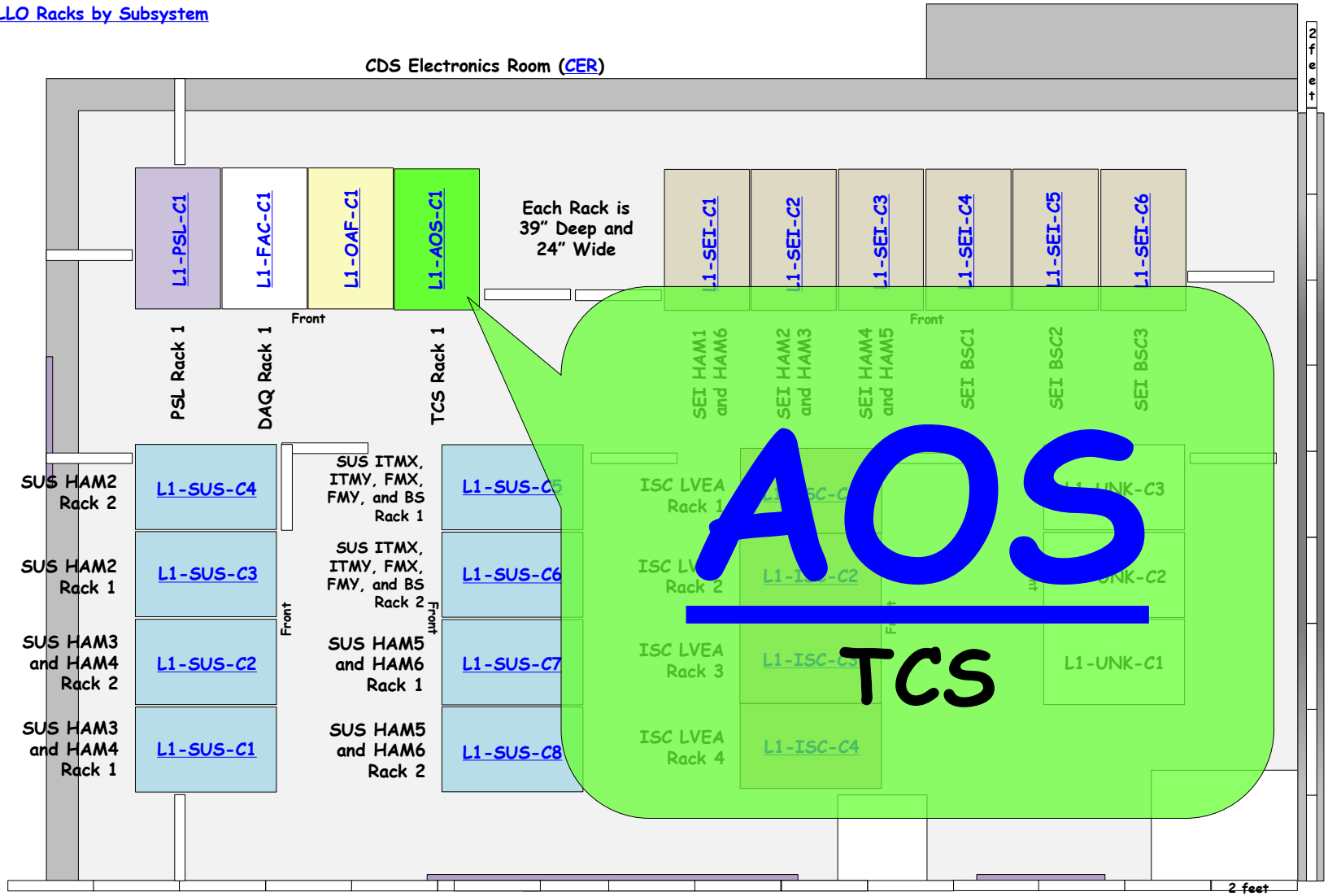

IO Diagram: [D1100909](#)

Op Lev Docs : [E1200031](#) and [T1000097](#)

[D1200258](#)

AOS Rack Layout ([D1201119](#)) ([S1202974](#))

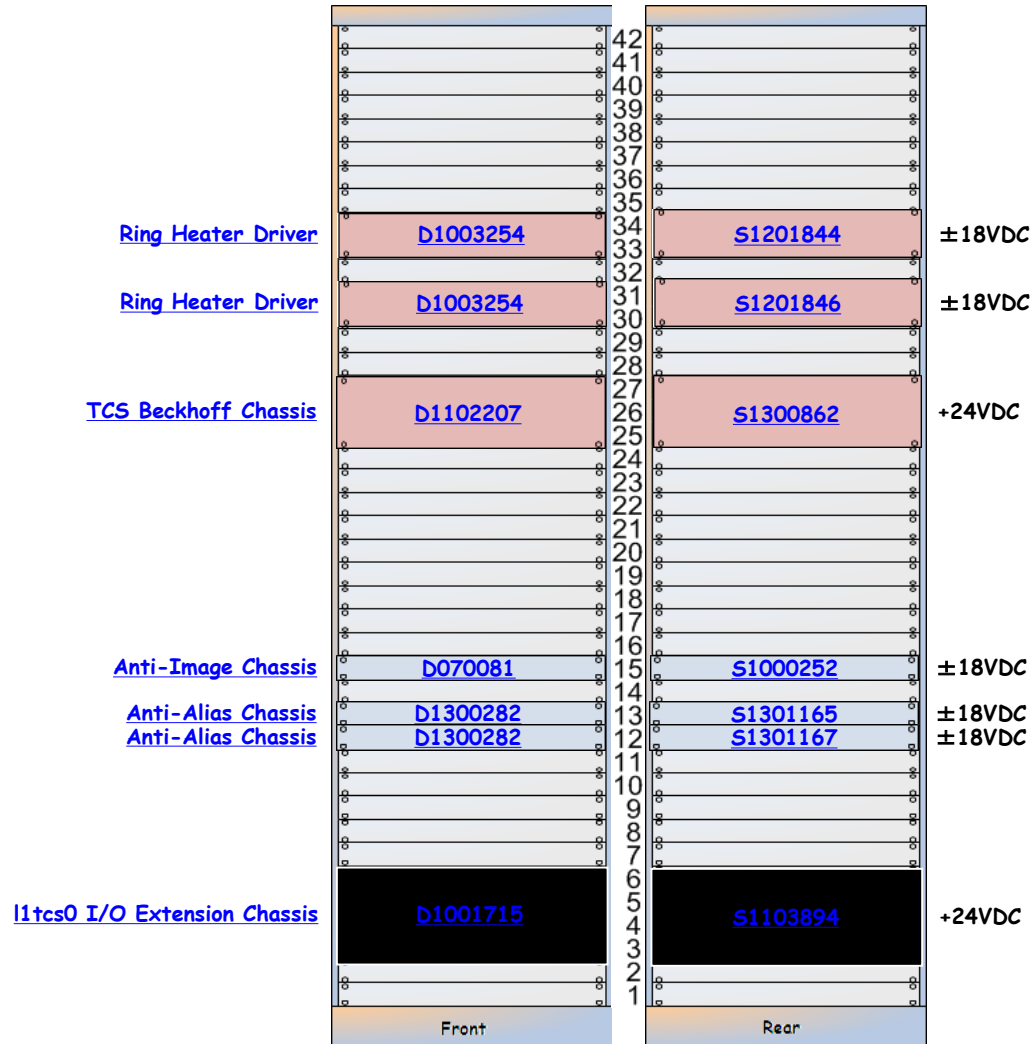

L1-AOS-C1 is part of [E1100895](#)

L1-AOS-C1 is part of [D1200258](#)



L1-AOS-C1 Details

Ring Heater Driver

D1003254

S1201844

±18VDC

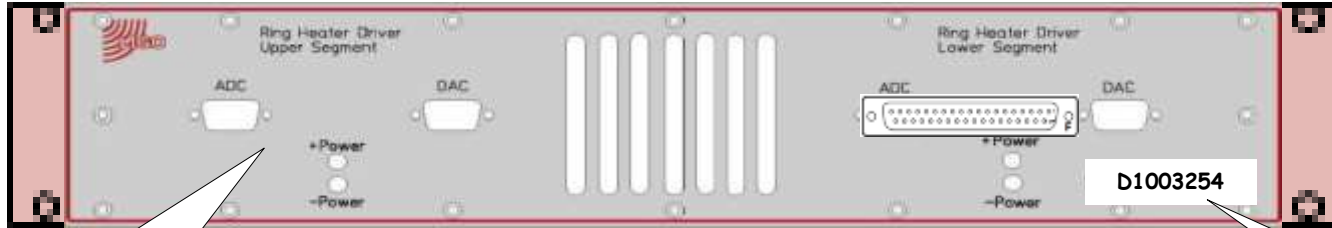

D1003254

Front

This is an early revision of the front panel. It now has one DB37M connector. 20121205 dlk

Label	Description

White label 20121205 dlk

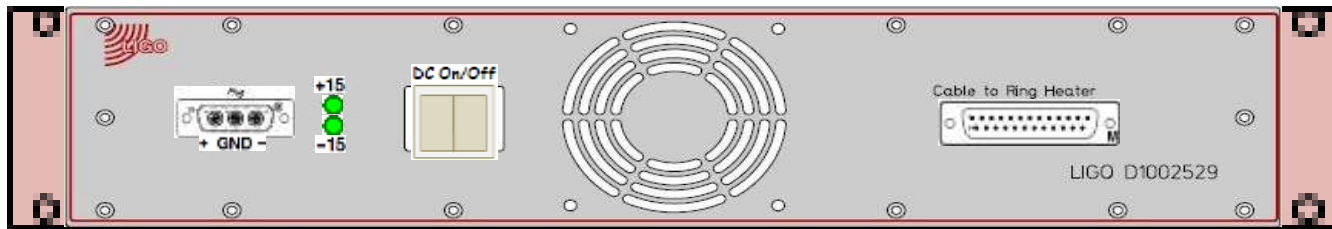

S1201844

Rear

Label	Description
	Cable to Ring Heater

Ring Heater Driver

D1003254

S1201846

±18VDC

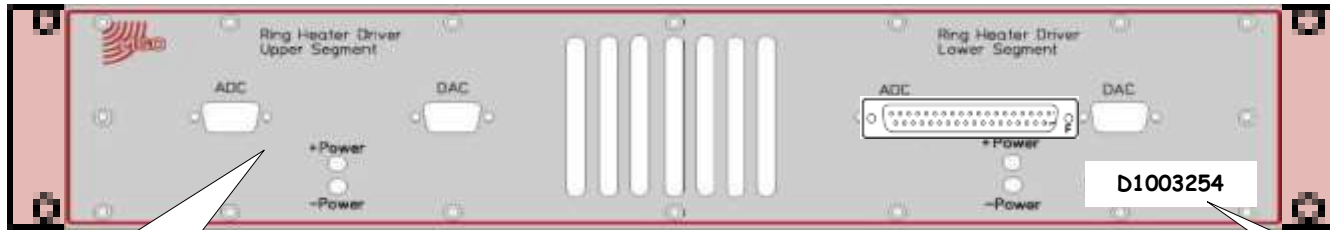

D1003254

Front

This is an early revision of the front panel. It now has one DB37M connector. 20121205 dlk

Label	Description

White label 20121205 dlk

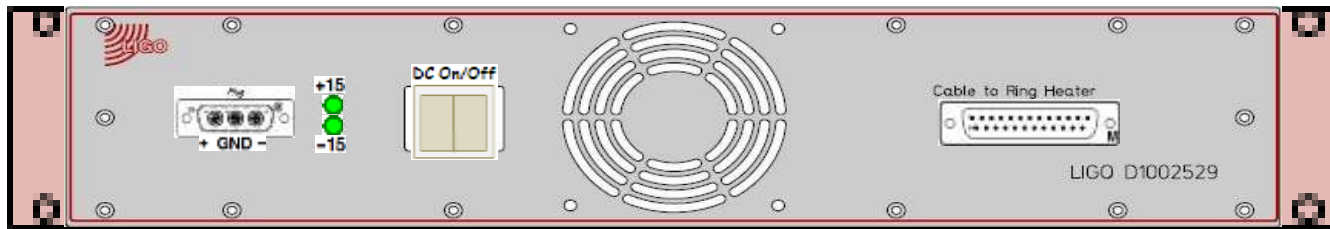

S1201846

Rear

Label	Description
	Cable to Ring Heater

Anti-Image Chassis ±18VDC

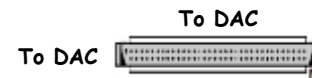
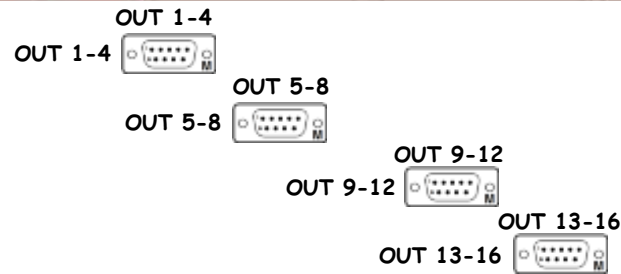
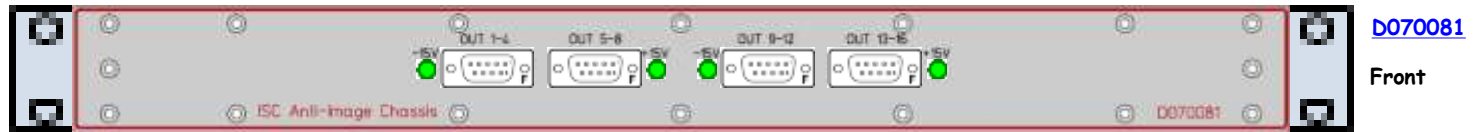

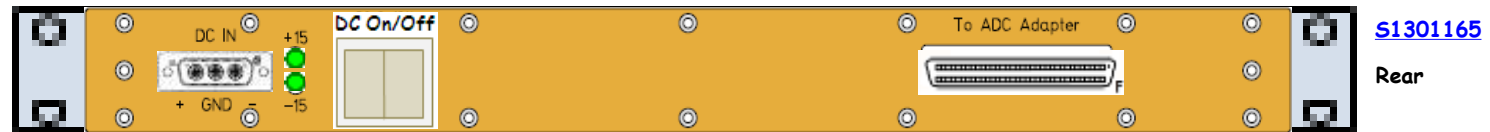
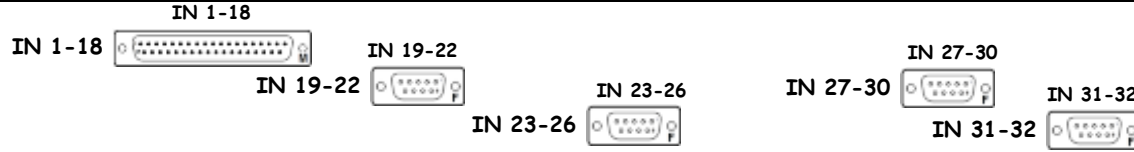
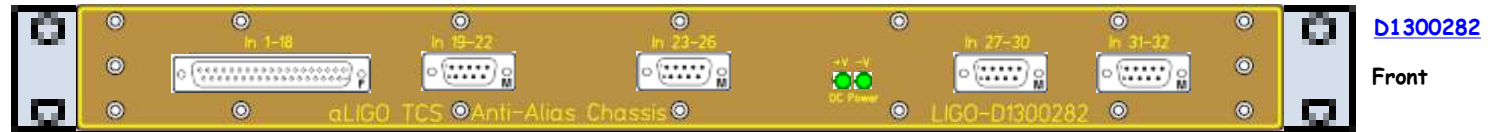

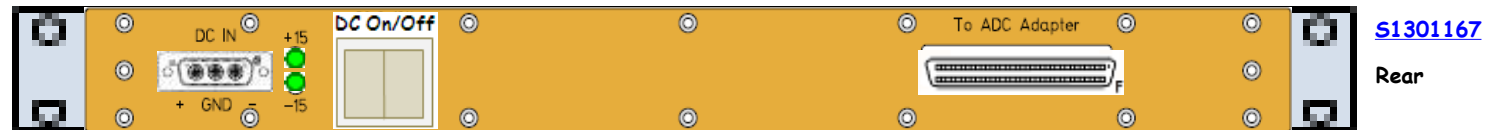
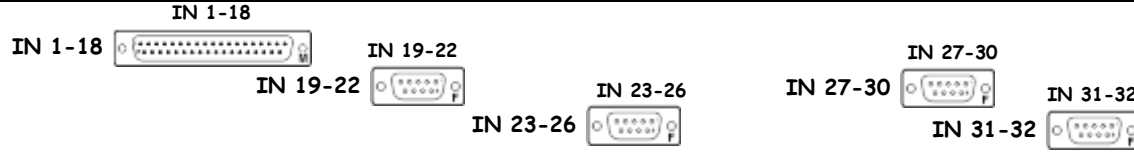
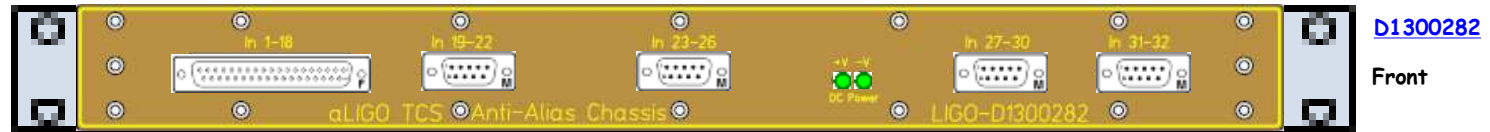

I1tcs0 I/O Extension Chassis

[D1001715](#)

[S1103894](#)

+24VDC

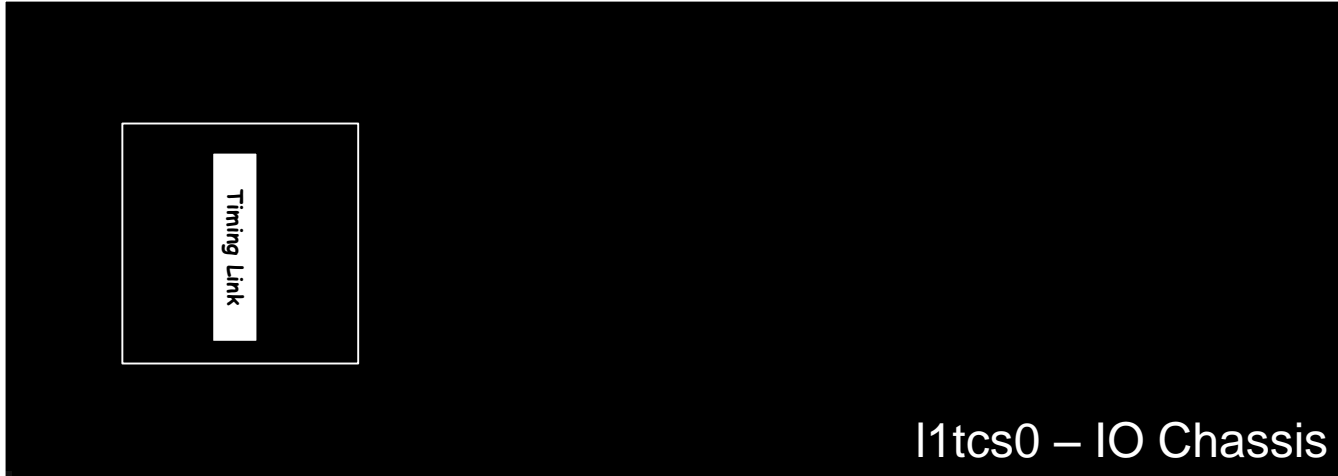

[D1001715](#)

Front

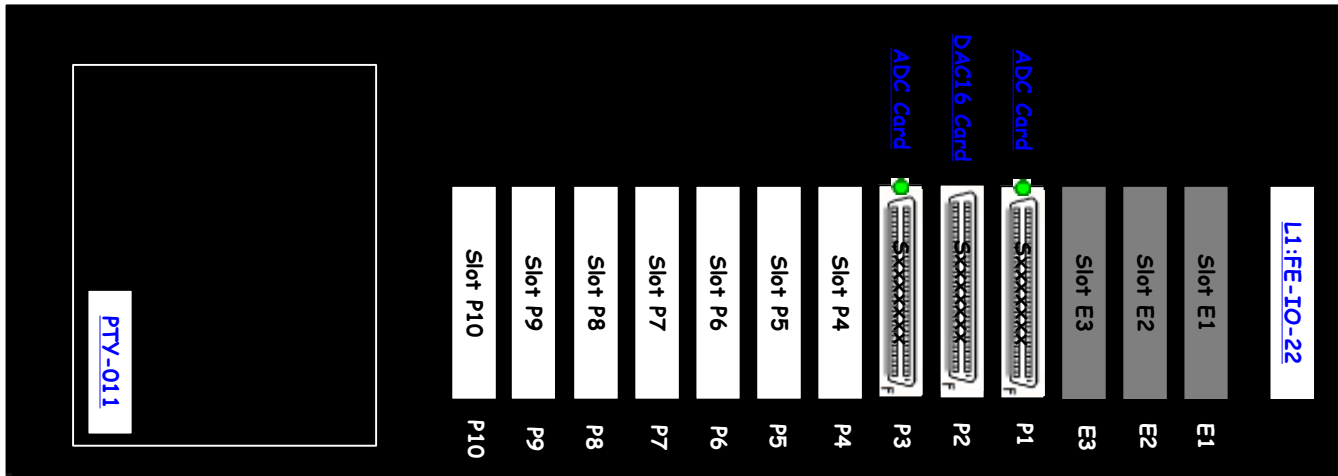

[S1103894](#)

Rear

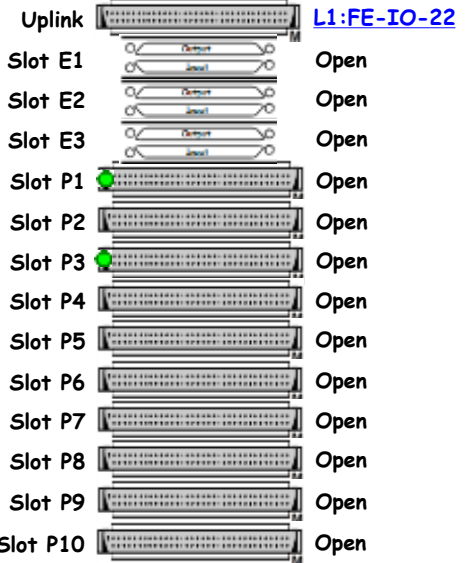

TCS Beckhoff Chassis

[D1102207](#)

[S1300862](#)

+24VDC

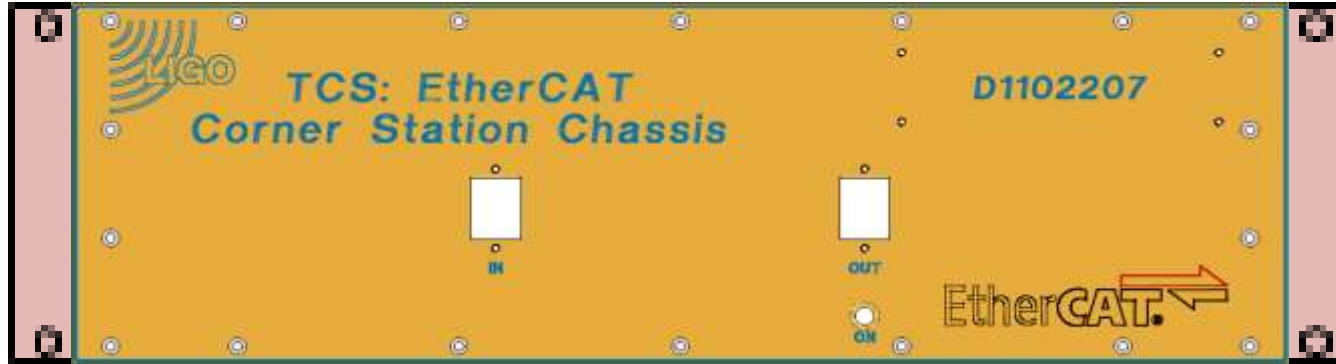

[D1102207](#)

Front

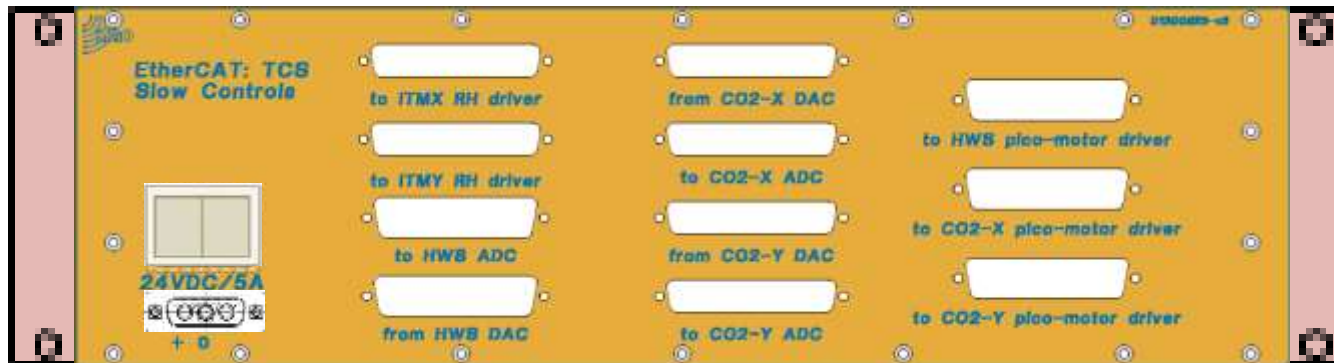

[S1300862](#)

Rear

- << [LLO Racks by AREA](#)
- << [LLO Racks by Subsystems](#)

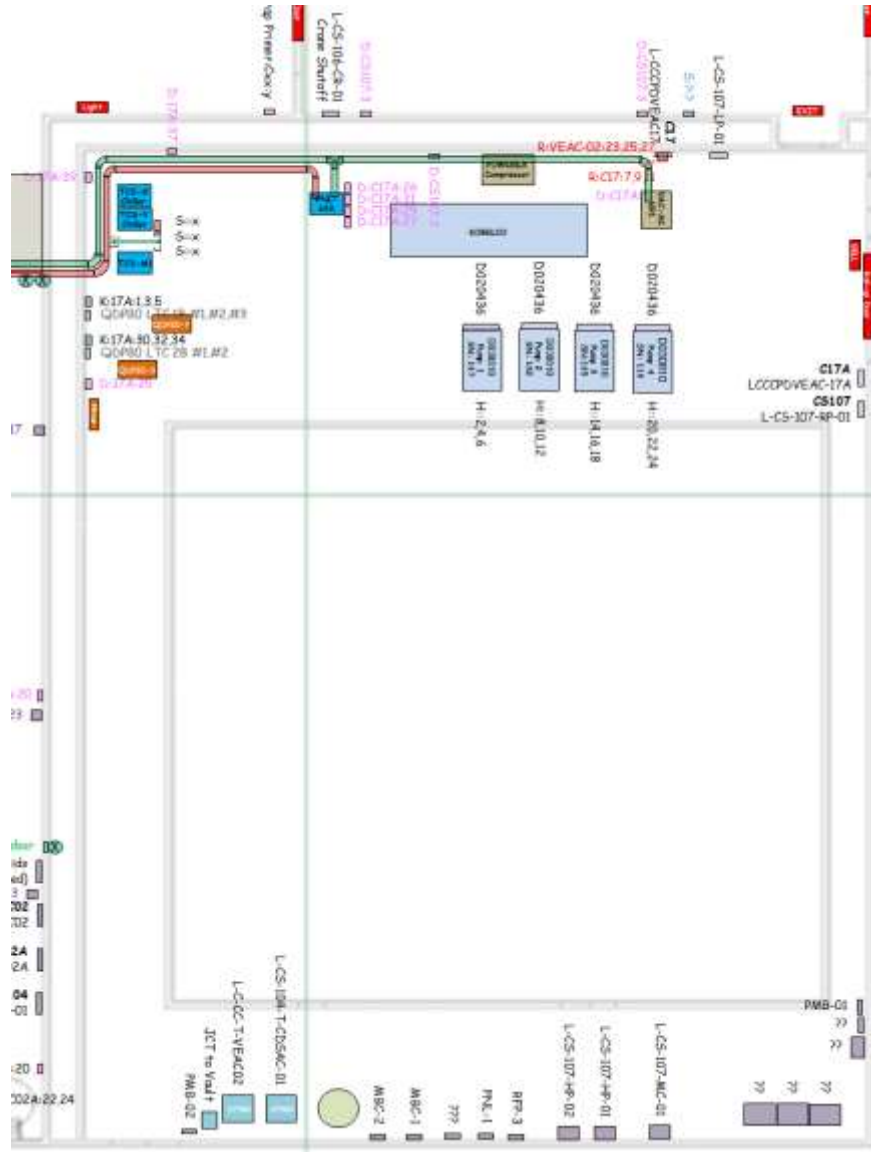

- | | |
|---|--|
| TCS Rack 1 (HV)
(L1-TCS-M1) | LVEA Mech VAC
(L1-VAC-R3) |
| | Vacuum ION PUMP Controllers
(L1-PNL-600) |
| QDP80
(link) | HEPI Pumps
(link) |
| Kobelco
(link) | PMB
(link) |
| Chillers
(link) | |



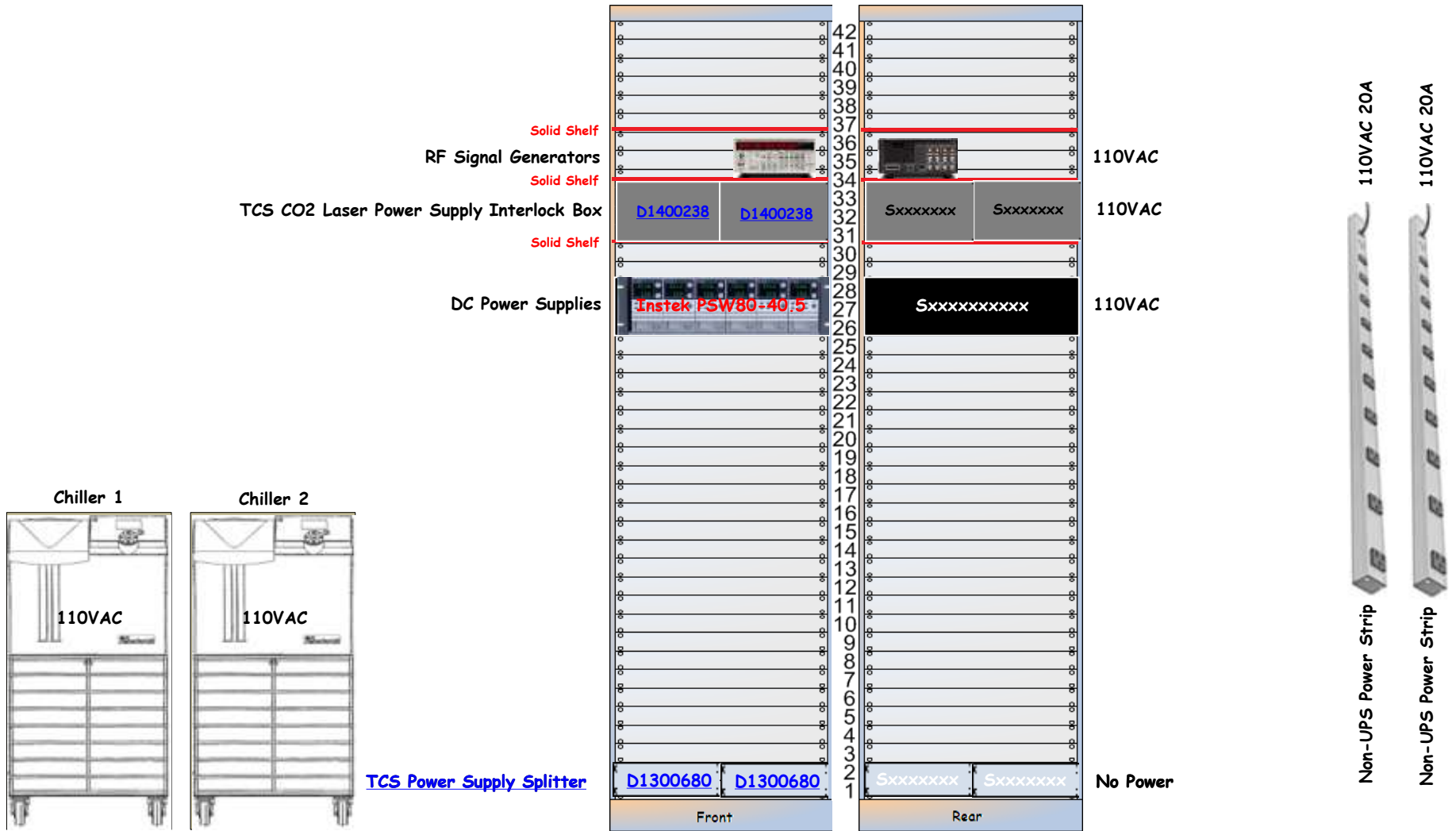

TCS CO2 Laser Power Supply Interlock Box

D1400238

Sxxxxxxx

±24VDC



D1400238

Front

Sxxxxxxx

Rear



D1400238 - TCS CO2 Laser Input Power Interlock Box

- Digi-Key HM1193-ND 8.74 x 5.75 x 4.14 Black Box
- Mouser 651—2963802 Phoenix Contact Safety Relay
- Digi-Key 277-9822-ND AC/DC CONVERTER 24V 2.5A 60W
- DB9 F bulkhead mount + 2 pins
- 3.75" DIN rail
- 2 – 8-32*3/8 Screws
- 2 – 8-32 Nylon filled nuts
- 2 - #10 Flat washers
- 2 - Grommets
- 1 – 16/3 3-prong extension cord – 6'

This device is NOT removable because signals cross pins. And Pin 7 is called out as Ground, but is not connected.

In addition, the drawings for the cable pin-outs are wrong.



D1300680

Front

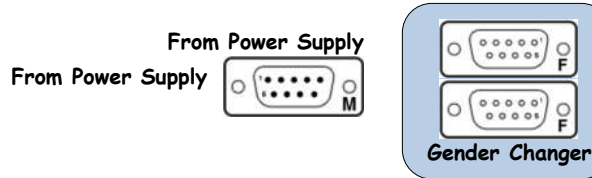

D1300680

Rear

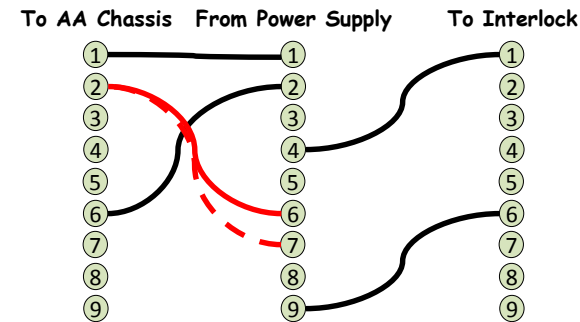

"To Interlock" cable is NOT present. The actual Interlock Cable comes from the D1400238 Box.

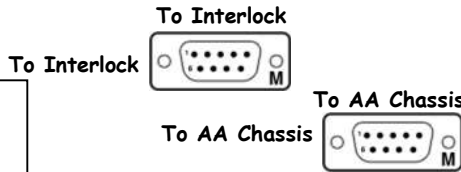

This device is NOT removable because signals cross pins. And Pin 7 is called out as Ground, but is not connected.

In addition, the drawings for the cable pin-outs are wrong.



D1300680

Front

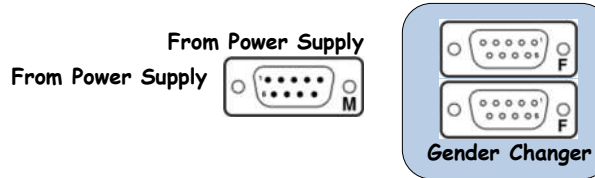

D1300680

Rear

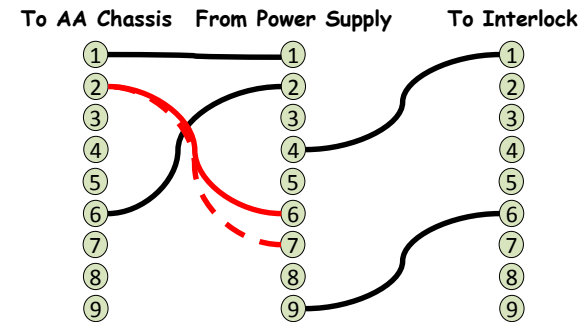

"To Interlock" cable is NOT present. The actual Interlock Cable comes from the D1400238 Box.

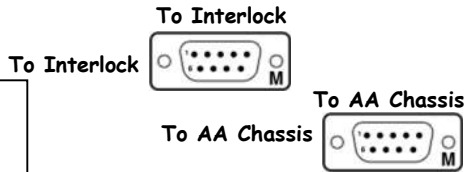

TCS Chiller UPS Calculations

Per chiller (2 per site)

ThermoFisher SCIENTIFIC

Bldg. 2B - Suite 400
28 Schenck Parkway
Asheville, NC 28803
Phone: (866) 984-3766 Fax: (888) 618-2676

Description
1111C20160200100
TF14 D A 115/60 T1 FCR DCOM ACOM

Setpoint range: 5-40C
Cooling capacity: 60Hz - 1400 Watts @20C
Dimensions: H x W x D: (27.3 in x 14.2 in x 24.6 in); (69.2 cm x 36.0 cm x 62.4 cm)
Volume: 1.9 gallons (7.2 liters)
Power Requirements: 115VAC 60HZ; 100VAC 50HZ 14.6A
Pump: 60Hz - Pump Flow: 3.5 gpm @ 60 psid; (13.2 lpm @ 4.1 bar)
Compliance:
CSA File #: 1056974_C_000
CLASS: 8721-05 CAN/CSA 22.2 No. 61010-1-04
CLASS: 8721-85 ANSI/UL Standard 61010-1
2004/108/EC - EMC Directive - EN 61326-1:2006
2006/95/EC - Low Voltage Directive - EN 61010-1:2001

Options:
Flow Control Readout
RS232/RS485
Analog-IO

$$115\text{VAC} \times 14.6\text{A} = 1679\text{VA}$$



Configured Runtime Chart

Model plus battery quantity

Typical backup time at
1800W

SMX3000RMLV2U	12 mins
SMX3000RMLV2U + (1)SMX120RMBP2U	51 mins
SMX3000RMLV2U + (2)SMX120RMBP2U	1 hrs 31 mins
SMX3000RMLV2U + (3)SMX120RMBP2U	2 hrs 14 mins
SMX3000RMLV2U + (4)SMX120RMBP2U	2 hrs 57 mins
SMX3000RMLV2U + (6)SMX120RMBP2U	4 hrs 27 mins
SMX3000RMLV2U + (8)SMX120RMBP2U	5 hrs 59 mins
SMX3000RMLV2U + (10)SMX120RMBP2U	7 hrs 34 mins

Thermoflex 1400 Chiller

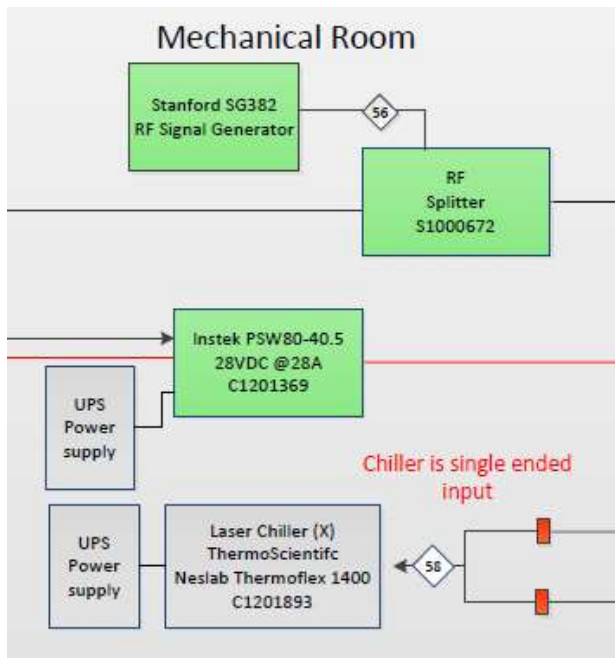

ThermoFlex1400

Voltage $\pm 10\%$	Frequency	Phase	Branch Circuit Requirements	Line Cord Plug
100 VAC	50 Hz	1Ø	20A	5-20P
115 VAC	60 Hz	1Ø	20A	5-20P
200 VAC	50 Hz	1Ø	15A	6-15P
208-230 VAC	60 Hz	1Ø	15A	6-15P
230 VAC	50 Hz	1Ø	*16A ¹ , 15A ² , 13A ³	-

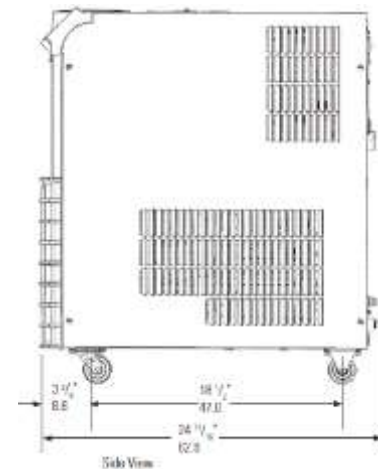
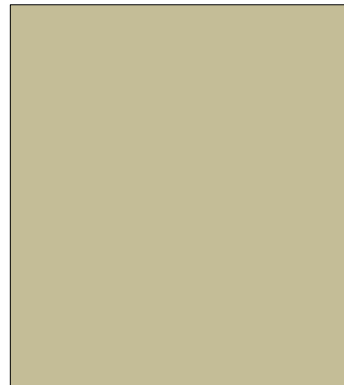
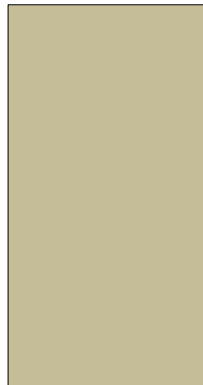

<< LLO Racks by Subsystem

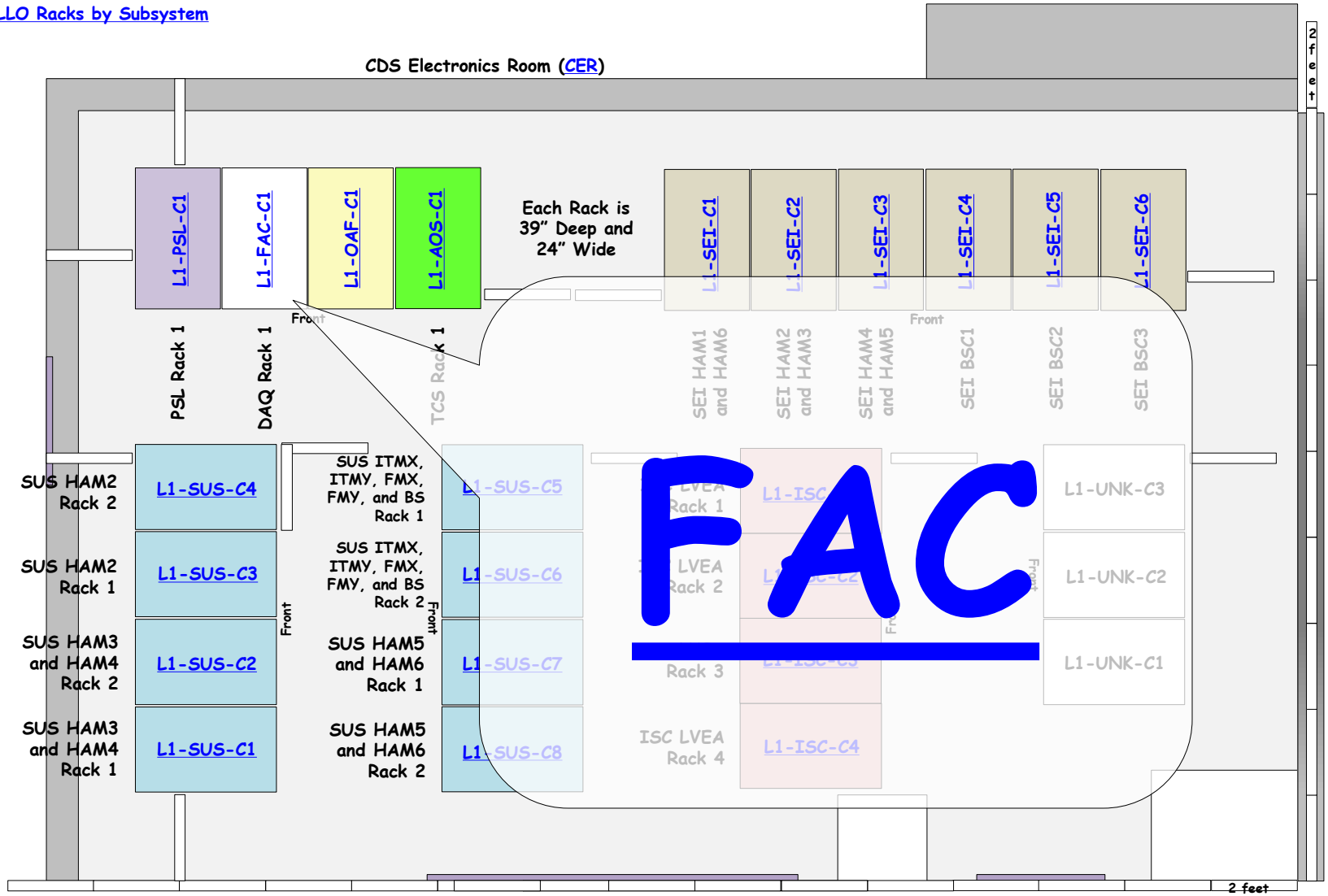

L1-FAC-C1 Rack Layout (D1200940) (S1202403)

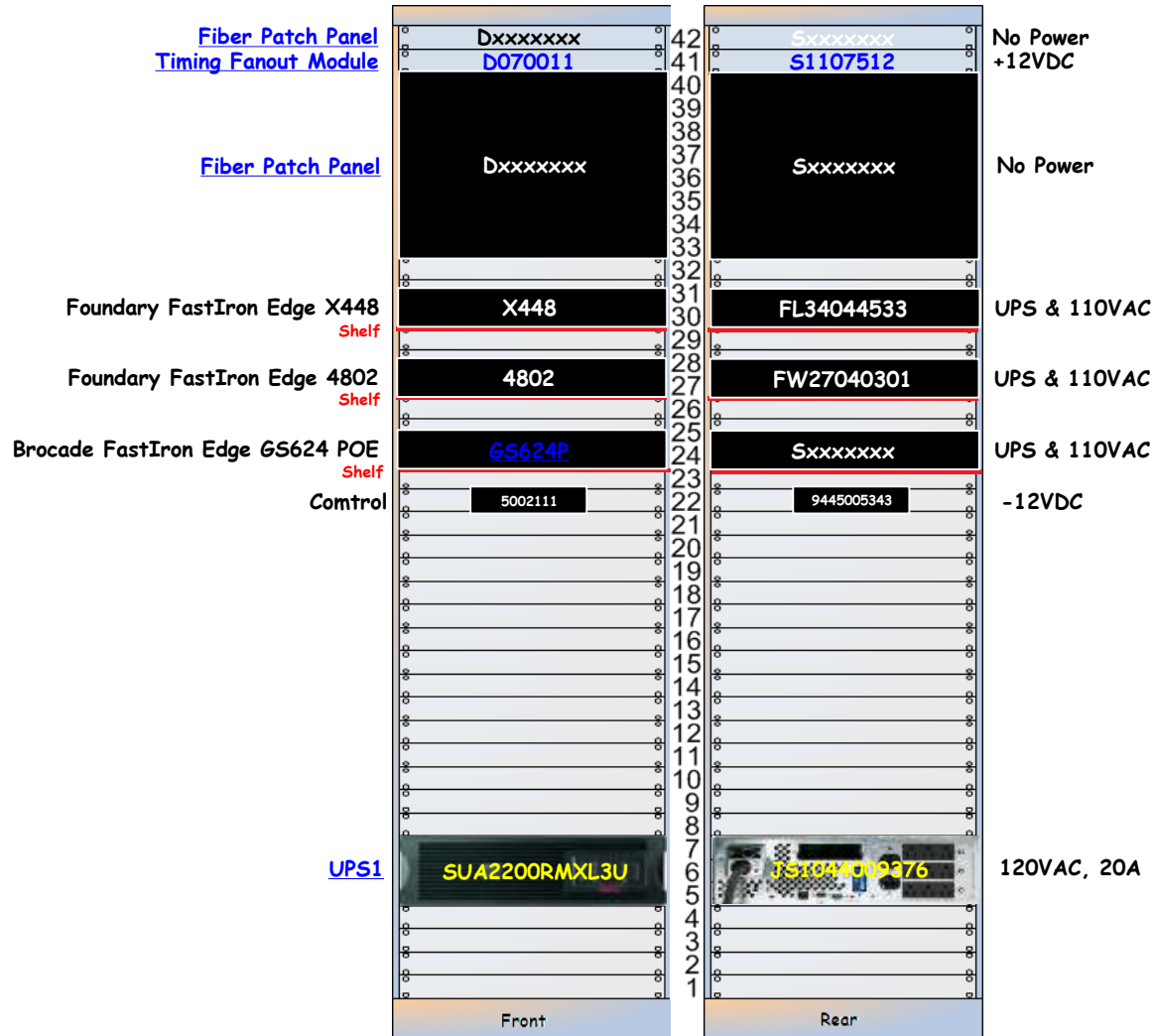

110VAC 20A

UPS Power Strip



PTG-001

L1-FAC-C1 Details

Dxxxxxxx - Sxxxxxxx

<< L1-FAC-C1

Fiber Patch Panel

Dxxxxxxx

Sxxxxxxx

No Power

Fibercables.com



Dxxxxxxx

Front

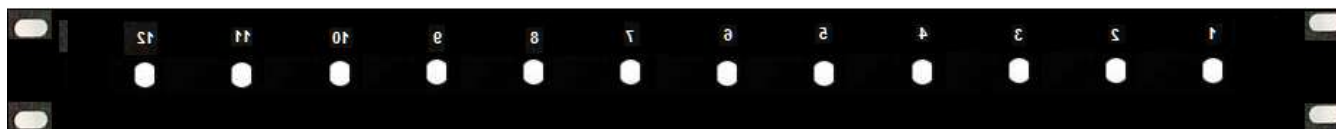

Sxxxxxxx

Rear

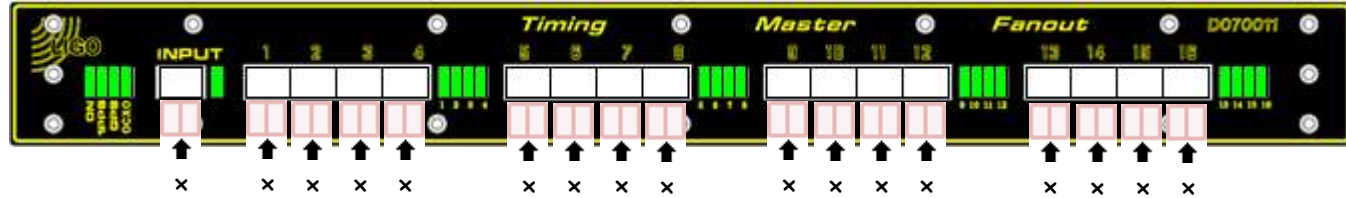

[D070011](#)
Front



[S1107512](#)
Rear
Fanout

Fiber Patch Panel

Fiber Patch Panel

Dxxxxxxx

Sxxxxxxx

No Power

SUA2200RMXL3U - JS1044009376 UPS

<< L1-FAC-C1

UPS1

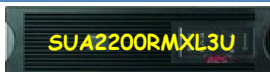

120VAC, 20A



<< LLO Racks by Subsystem

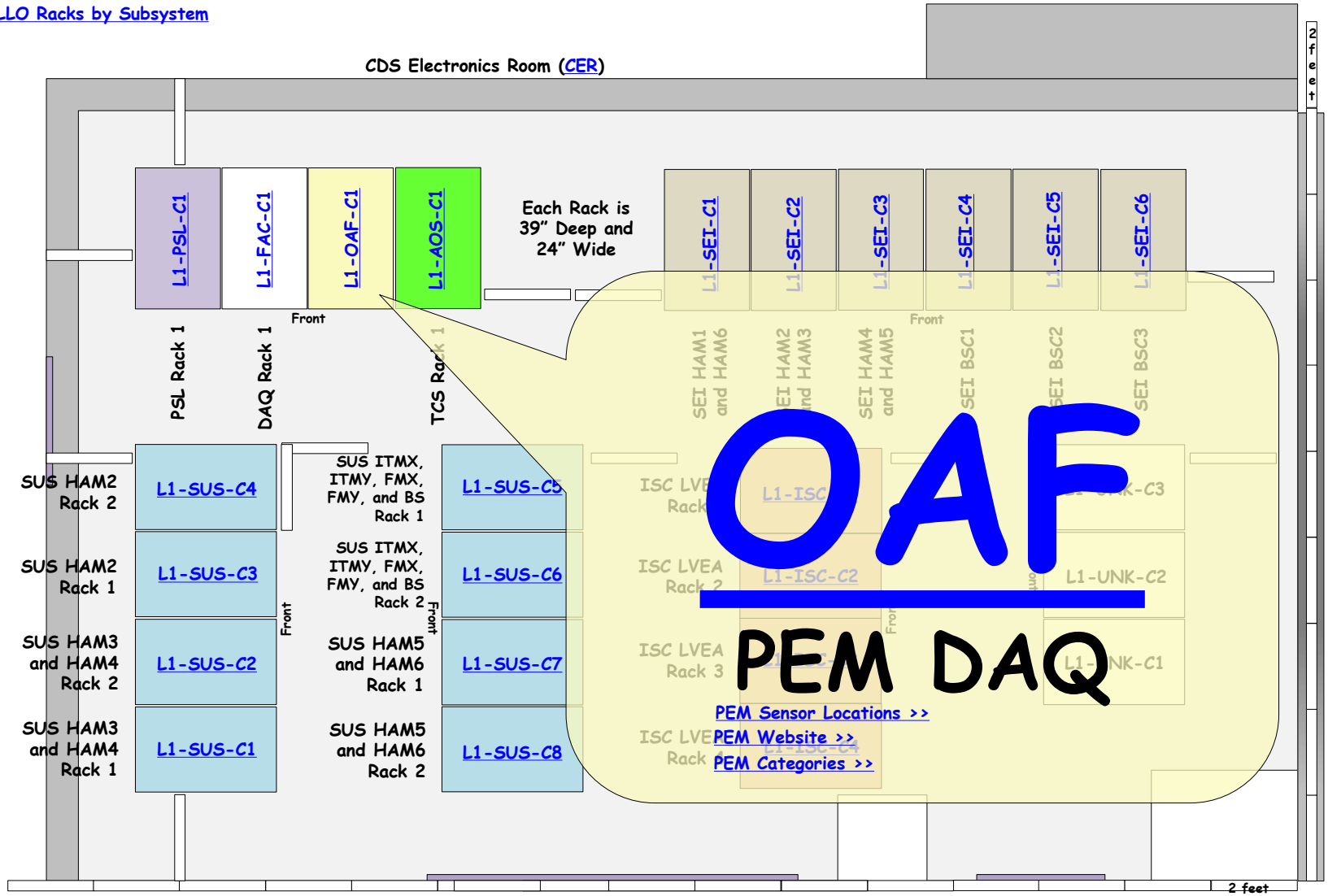

L1-OAF-C1 Rack Layout (D1200941) (S1202404)

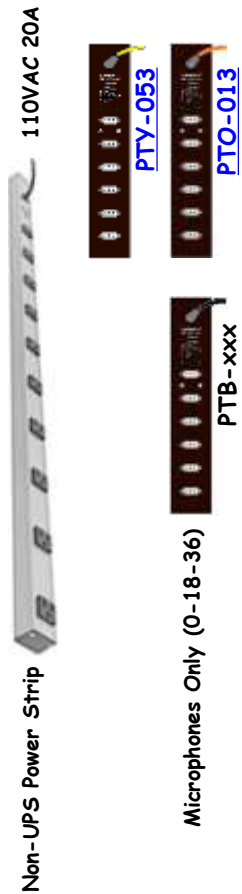
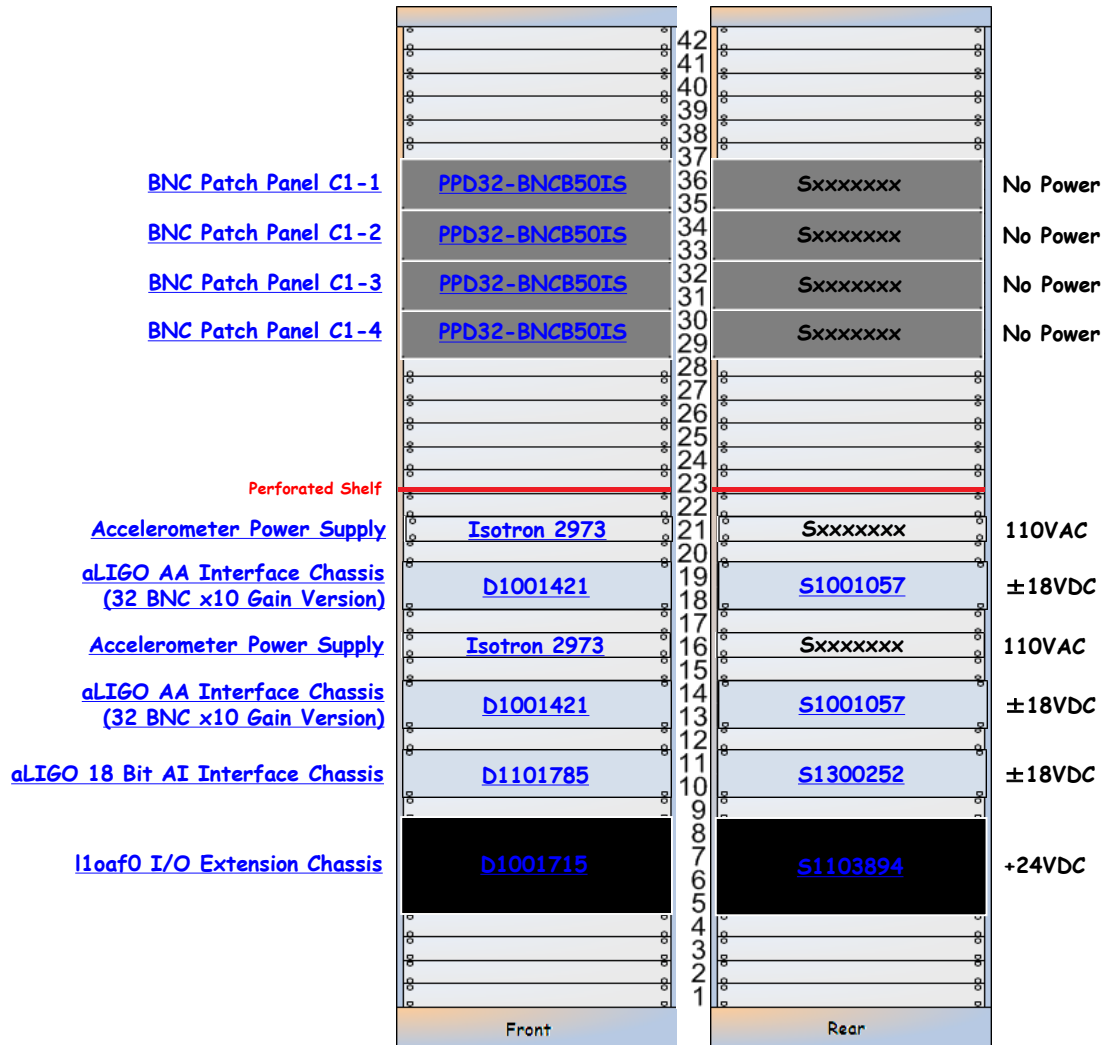

[PEM Sensor Locations >>](#)

L1-OAF-C1 Details

BNC Patch Panel C1-1

<< [L1-OAF-C1](#)

BNC Patch Panel C1-1

[PPD32-BNCB50IS](#)

Sxxxxxxx

No Power



[PPD32-BNCB50IS](#)

Front

BNC Patch Panel C1-2

<< L1-OAF-C1

BNC Patch Panel C1-2

PPD32-BNCB50IS

Sxxxxxxx

No Power



PPD32-BNCB50IS

Front

BNC Patch Panel C1-3

<< L1-OAF-C1

BNC Patch Panel C1-3

PPD32-BNCB50IS

Sxxxxxxx

No Power



PPD32-BNCB50IS

Front

BNC Patch Panel C1-4

<< [L1-OAF-C1](#)

BNC Patch Panel C1-4

[PPD32-BNCB50IS](#)

Sxxxxxxx

No Power



[PPD32-BNCB50IS](#)

Front

Endevco Isotron 2793

<< L1-OAF-C1

Accelerometer Power Supply 110VAC



[Isotron 2973](#)

Front

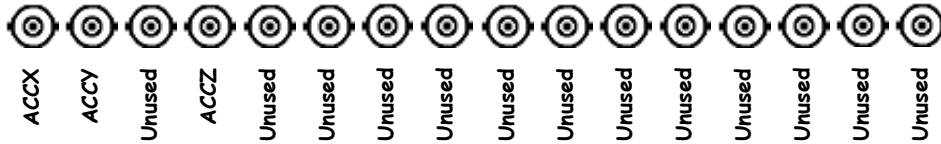

Sxxxxxxx

Rear

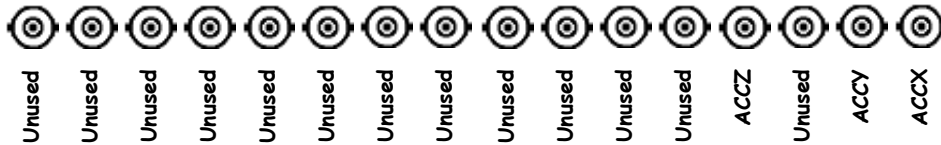

<< L1-OAF-C1

aLIGO AA Interface Chassis
(32 BNC, x10 Gain Version)

[D1001421](#)

[S1001057](#) :

±18VDC

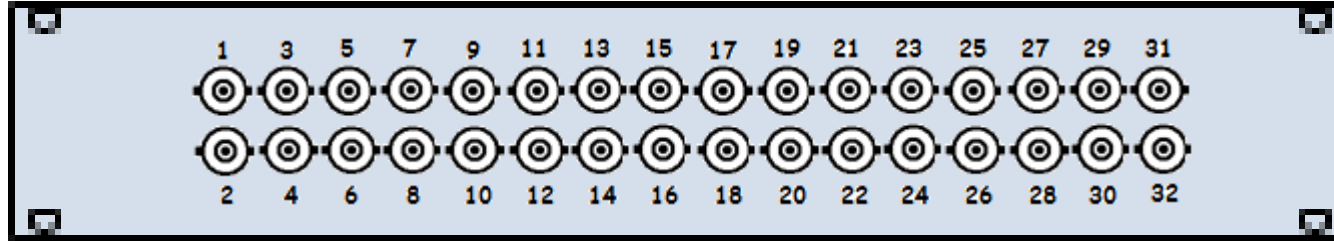

[D1001421](#)

Front

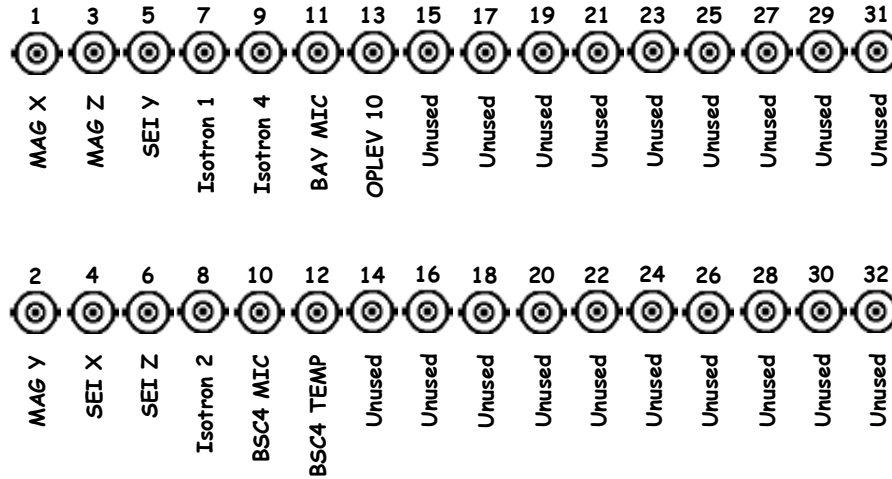

[D1300774](#)

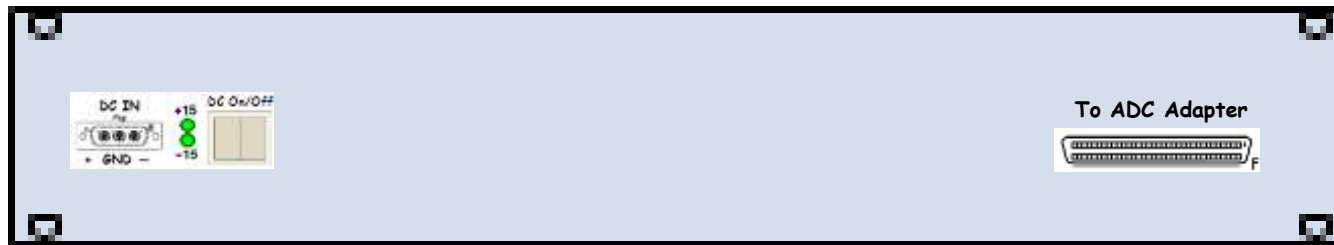

[S1001057](#)

Rear

[To I1oaf0 Slot P1](#)



To ADC Adapter

Endevco Isotron 2793

<< L1-OAF-C1

Accelerometer Power Supply 110VAC



[Isotron 2973](#)

Front

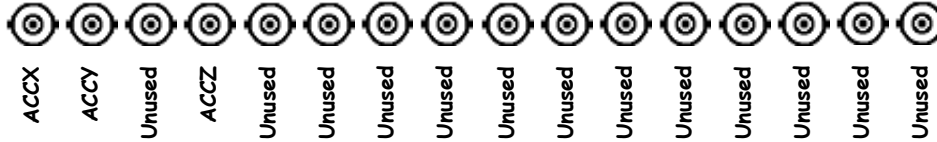

Sxxxxxxx

Rear

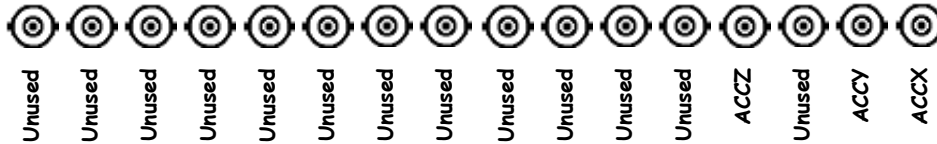

<< L1-OAF-C1

aLIGO AA Interface Chassis
(32 BNC, x10 Gain Version)

[D1001421](#)

[S1001057](#) :

±18VDC

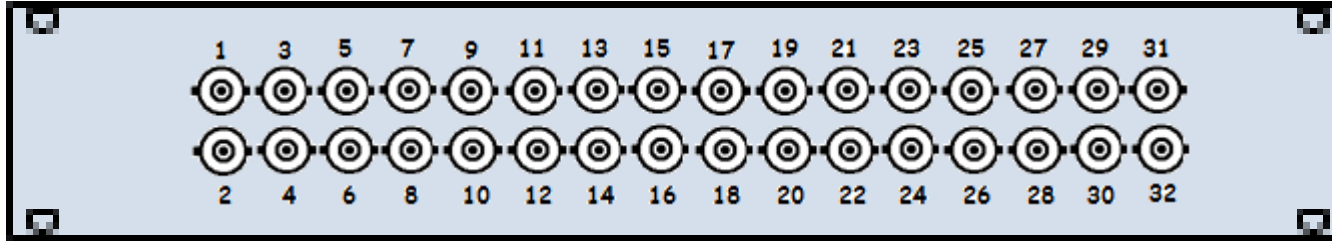

[D1001421](#)

Front

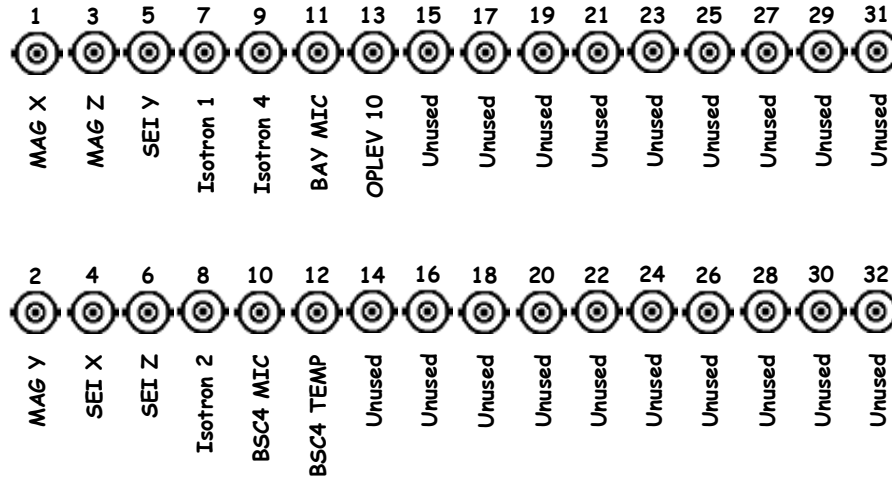

[D1300774](#)

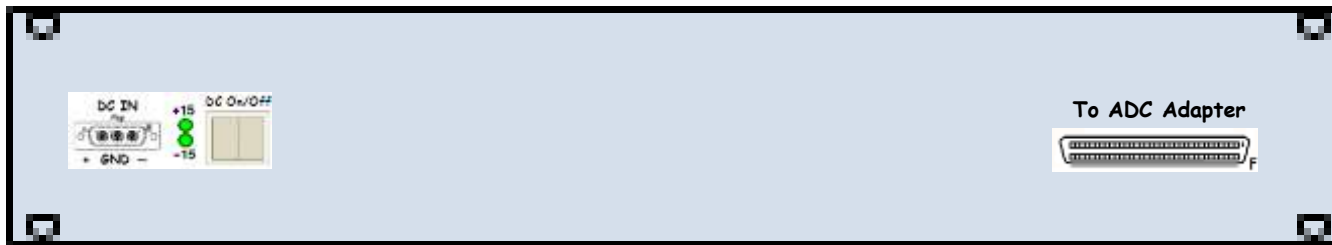

[S1001057](#)

Rear

[To I1oaf0 Slot P1](#)



To ADC Adapter

aLIGO 18 Bit AI Interface Chassis

D1101785

S1300252

±18VDC

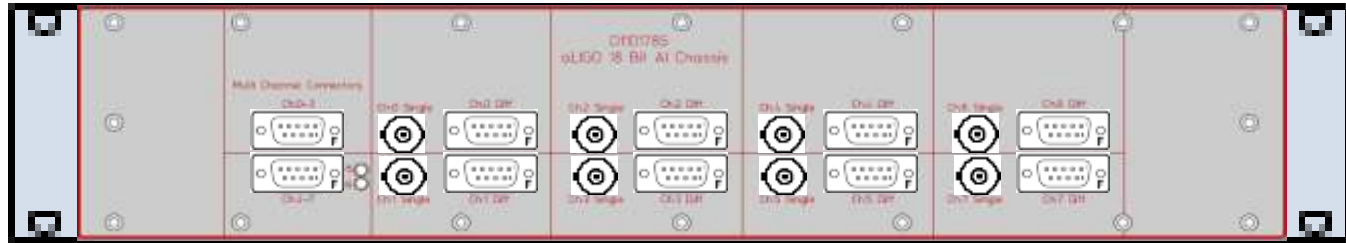

D1101785

Front

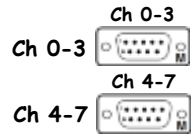

S1300252

Rear

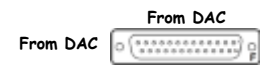

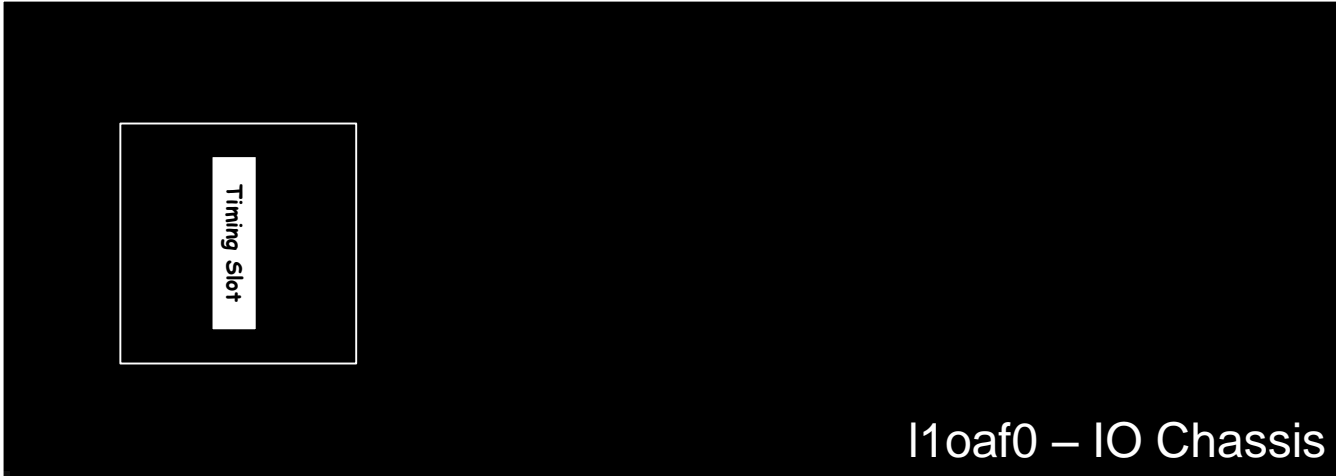

D1001715

Front

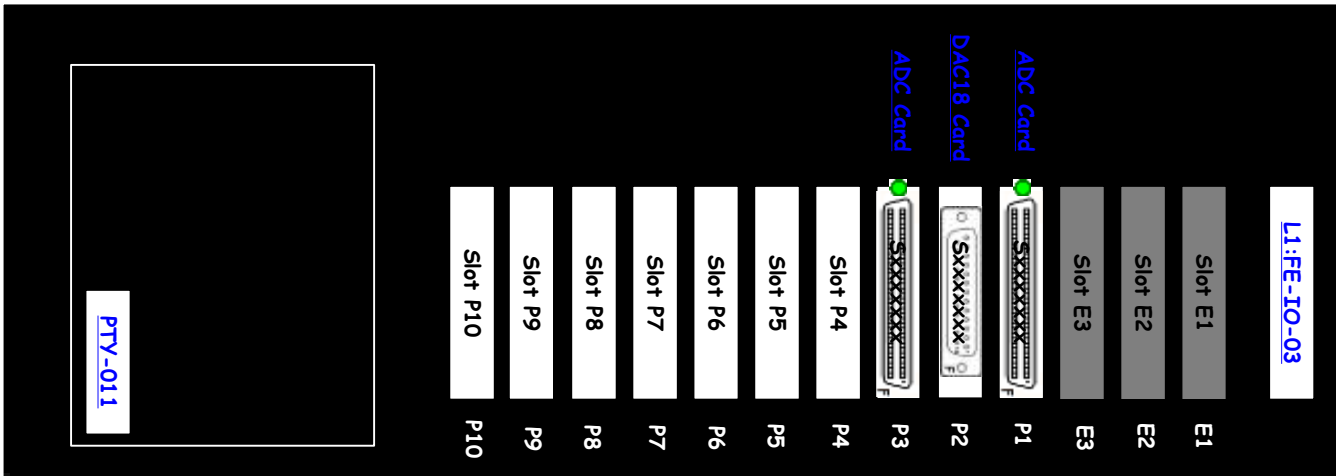

S1103894

Rear

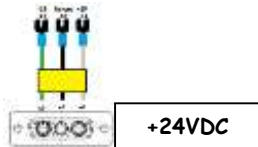
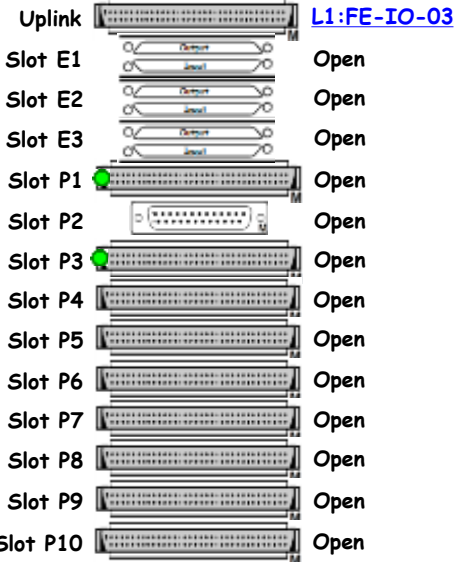

LLO PEM Sensor Locations

aLIGO PEM SENSOR LOCATIONS LLO

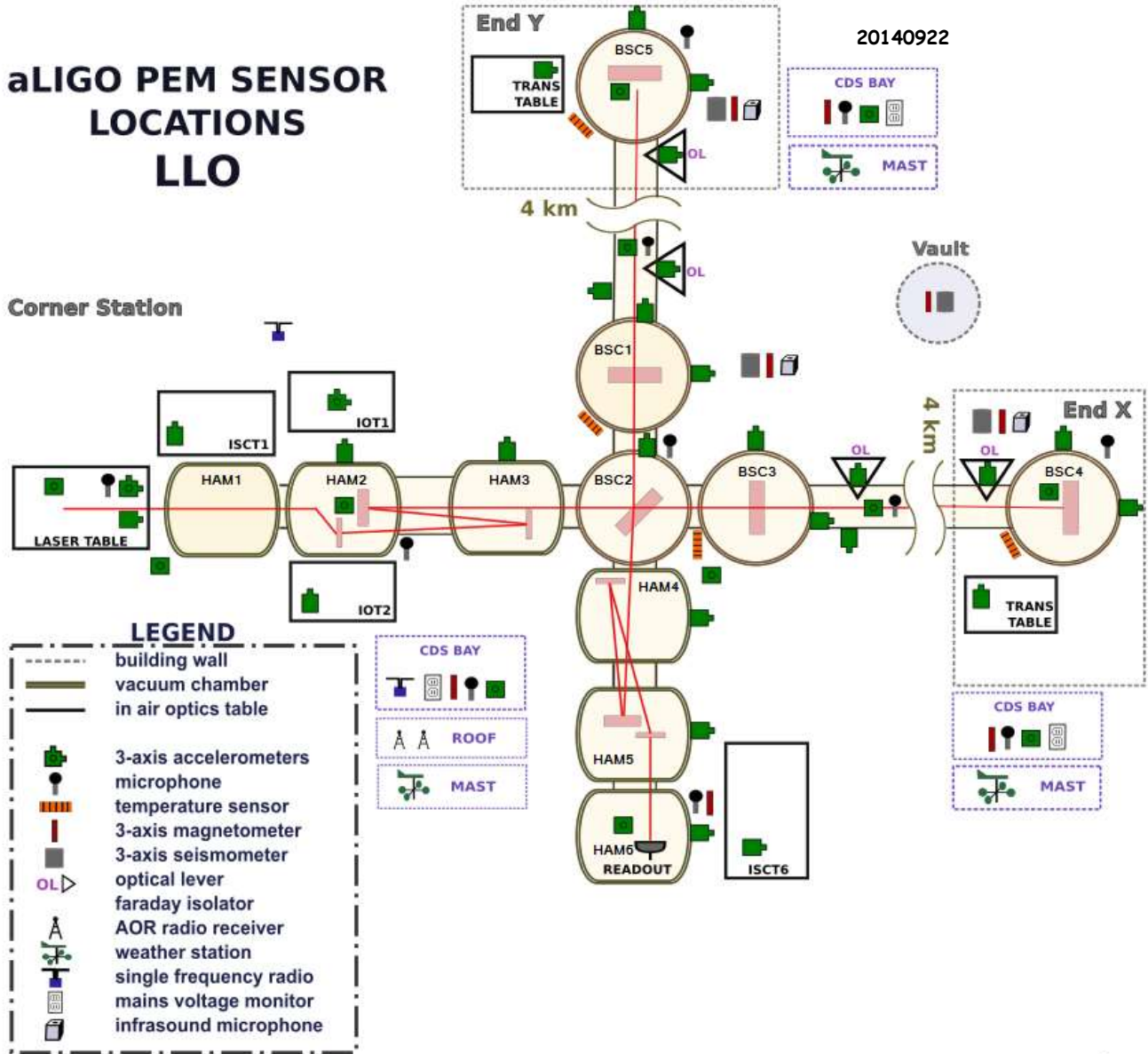

[PEM Website](#)
[PEM Categories](#)

D1200615

- [Accelerometers](#)
- [Antennae \(Radio Receivers\)](#)
- Coil Magnetometer
- Cosmic Ray Detector
- [Magnetometer](#)
- [Microphones](#)
- Muon (Charged Particle) Detector
- [Particle Counters \(Dust Monitors\)](#)
- [Power Line \(Voltage\) Monitor](#)
- Residual Gas in Vacuum System
- Scintillator Detector
- [Seismometers](#)
- [Temperature Sensors](#)
- [Tiltmeters](#)
- Vacuum Contamination Monitor
- Weather Stations

- **Accelerometers**
 - $10^{-8} f^{-2} \text{ m Hz}^{-1/2}$
 - 10-200Hz (256Hz, 16bit)
- **Seismometers**
 - $3 \times 10^{-10} f^{-2} \text{ m Hz}^{-1/2}$
 - 0-10 Hz (256Hz, 16bit, 3 axis)
- **Microphones**
 - $10 \text{ Pa Hz}^{-1/2}$
 - 10-1000Hz (2048Hz, 16bit)
- **RF receivers**
 - $10 \mu\text{V/m}$
 - 1.3GHz (2048Hz, 6x16bit)
- Residual Gas in Vacuum System
- Vacuum contamination Monitor
- Weather Station
 - T (1K), RH (10%), precipitation (10%), Wind (1mph)

- **Tiltmeters**
 - $2 \times 10^{-9} f^{-2} \text{ rad Hz}^{-1/2}$
 - 0-10Hz (256Hz, 16bit, 2 axis)
- **Dust Monitors**
- **Muon (Charged Particle) Detector**
 - $10^{-4} \mu/s/m^2$
 - 1 msec (2048Hz, 16bit)
- **Cosmic Rays**
- **Magnetometer**
 - $2 \times 10^{-11} \text{ T.Hz}^{-1/2}$
 - 1 kHz (2048Hz, 3x16bit)
- **Coil magnetometer**
 - $2 \times 10^{-12} \text{ T.Hz}^{-1/2}$
 - 1 kHz (2048Hz, 16bit)
- **Scintillator detector**
- **Power Line Monitor**

PCIe to Fiber Cable Adapter



Accelerometers (1)

1X5
1X20
1Y20

Isotron Power Supply Model 2793 has 16 channels
This model does NOT come with a DC option.
There is a 3-channel Power Supply that has a DC option,
but it has many other features not desired.

It appears that a short (6") 10-32 to BNC cable can be ordered, but
care should be given to strain relief considerations.

Only Wilcoxon Accelerometers are used for PEM

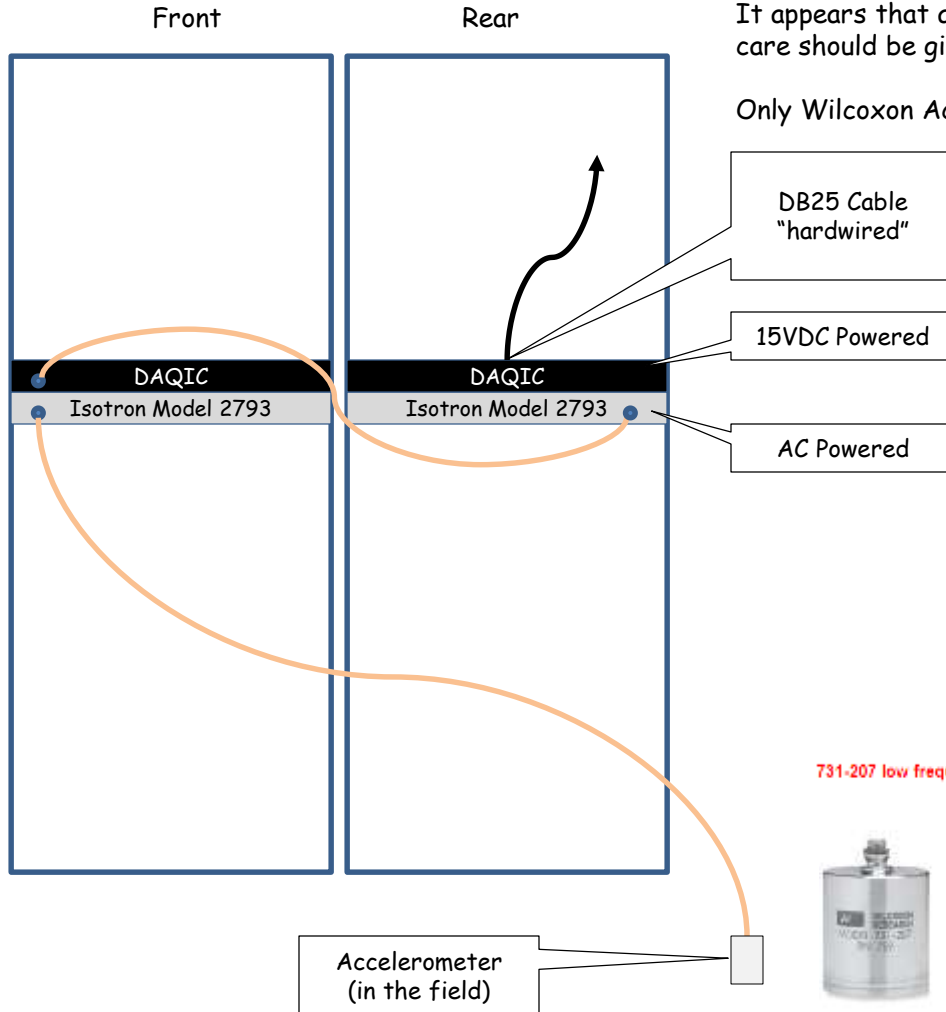

Accelerometer locations:

- | | |
|-----------------------|-------------------|
| 1) PSL X | 16) BSC1 X |
| 2) PSL Y | 17) BSC1 Y |
| 3) PSL Z | 18) BSC1 Z |
| 4) ISCT1 X | 19) BSC2 X |
| 5) ISCT1 Y | 20) BSC2 Y |
| 6) ISCT1 Z | 21) BSC2 Z |
| 7) HAM1 X | 22) BSC3 X |
| 8) HAM1 Y aka HAM6 X | 23) BSC3 Y |
| 9) HAM1 Z | 24) BSC3 Z |
| 10) HAM2 X | 25) HAM6 X |
| 11) HAM2 Y aka HAM6 Y | 26) HAM6 Y |
| 12) HAM2 Z | 27) HAM6 Z |
| 13) HAM3 X | 28) BSC4 X (VEAX) |
| 14) HAM3 Y aka HAM6 Z | 29) BSC4 Y (VEAX) |
| 15) HAM3 Z | 30) BSC4 Z (VEAX) |
| | 31) BSC5 X (VEAY) |
| | 32) BSC5 Y (VEAY) |
| | 33) BSC5 Z (VEAY) |

731-207 low frequency seismic accelerometer

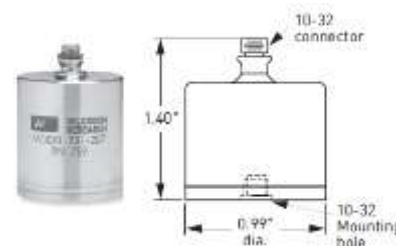

731-207 low frequency seismic accelerometer

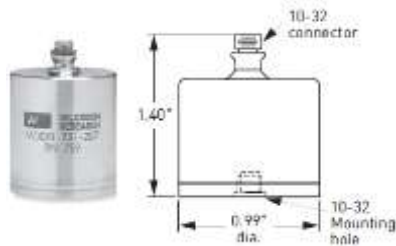

3061

The Endevo model 3061 cable is a non-low noise treated version of the 3090CM12 cable assembly. This cable has a male 10-32 miniature coax connector at one end and a male BNC at the other. The model 3061 is temperature rated from -85°F to +350°F.

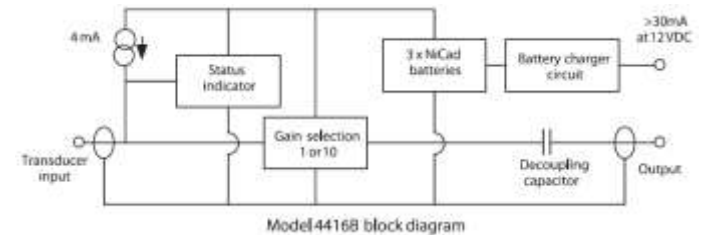
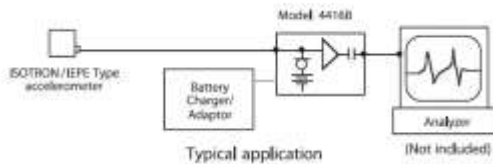
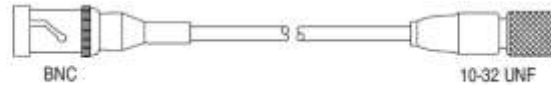

Notes:

1. For ultra-low noise application, model 4416BM1 offers the same basic design without the gain stage.

Avoiding ground loops

In order to provide proper shielding and prevent ground loops, shield and common grounding should be carefully considered. Ground loops are developed when a common line (i.e. signal return/shield) is grounded at two points of differing electrical potential.

For sensors with coaxial cable, the center conductor carries the signal and power, while the outer braiding provides the shielding and signal return. Normally the cable shield is electrically isolated from the sensor housing. This isolates the shield from the mounting point of the machine and prevents ground loops. If a non-isolated sensor is used, it is recommended that an isolated mounting pad be used to break up possible ground loops.

For sensors using two conductor/shielded cable, the signal and power are carried on one lead and the signal common on the other. The cable shield serves to protect the signal from Electrostatic Discharge (ESD) and Electromagnetic Interference (EMI). The shield should be grounded at only one point, normally to the readout equipment.

In all cases, it is very important that the cable shield terminations be properly grounded. Failure to do so in high ESD/EMI environments can result in damage to the sensor electronics.

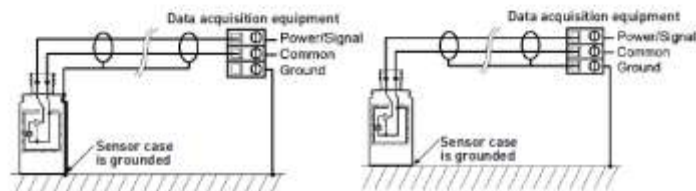

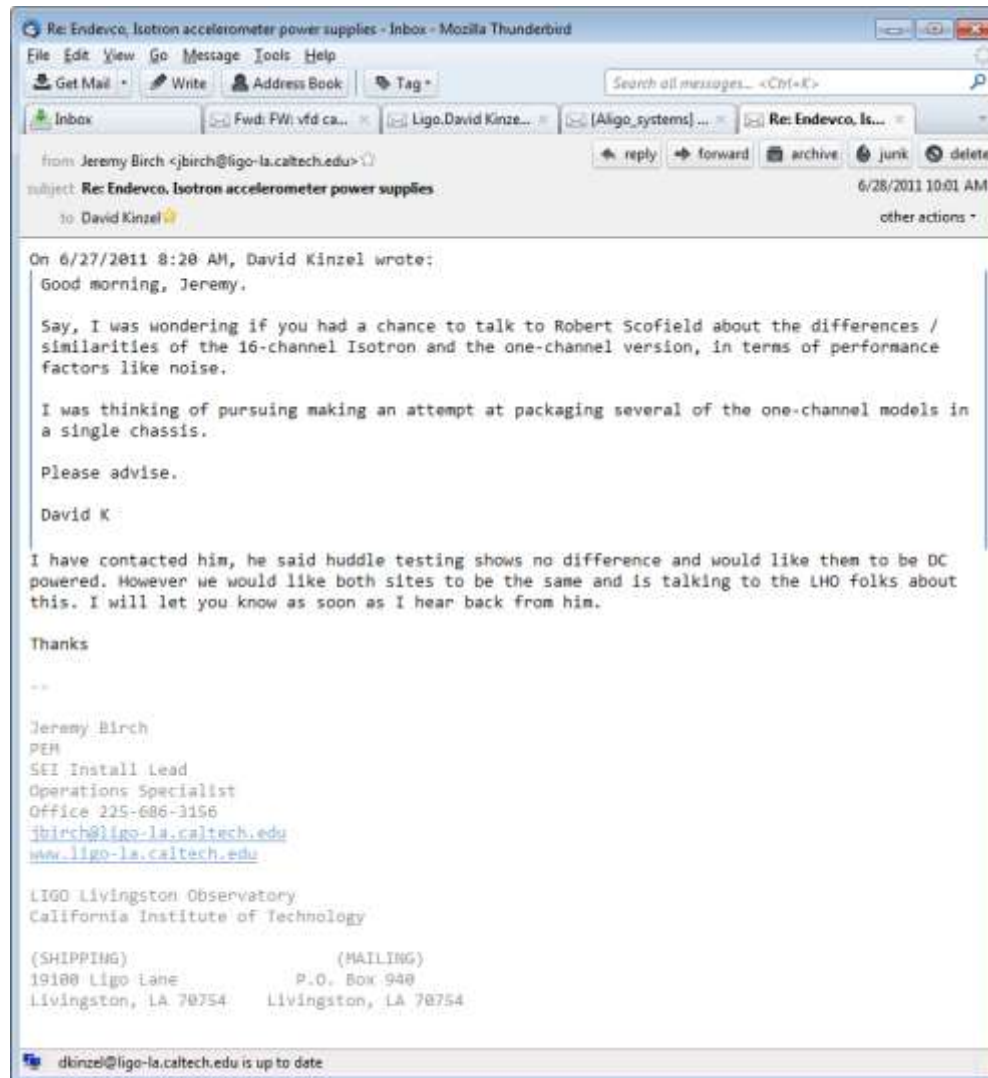

Re: Endevo, Isotron accelerometer power supplies - Inbox - Mozilla Thunderbird

File Edit View Go Message Tools Help

Get Mail Write Address Book Tag

Search all messages... <Ctrl+K>

Inbox Fwd: FW: vfd ca... Ligo.David Kinze... [Aligo_systems] ... Re: Endevo, Is...

from: Jeremy Birch <jbirch@ligo-la.caltech.edu>

subject: **Re: Endevo, Isotron accelerometer power supplies**

to: David Kinzel

6/28/2011 10:01 AM

reply forward archive junk delete other actions

On 6/27/2011 8:28 AM, David Kinzel wrote:

Good morning, Jeremy.

Say, I was wondering if you had a chance to talk to Robert Scofield about the differences / similarities of the 16-channel Isotron and the one-channel version, in terms of performance factors like noise.

I was thinking of pursuing making an attempt at packaging several of the one-channel models in a single chassis.

Please advise.

David K

I have contacted him, he said huddle testing shows no difference and would like them to be DC powered. However we would like both sites to be the same and is talking to the LHO folks about this. I will let you know as soon as I hear back from him.

Thanks

--

Jeremy Birch
PEH
SEI Install Lead
Operations Specialist
Office 225-686-3156
jbirch@ligo-la.caltech.edu
www.ligo-la.caltech.edu

LIGO Livingston Observatory
California Institute of Technology

(SHIPPING) (MAILING)
19188 Ligo Lane P.O. Box 948
Livingston, LA 70754 Livingston, LA 70754

dkinzel@ligo-la.caltech.edu is up to date

There are two antennae of interest.

- 1) Roof Antenna
- 2) CDS High-bay Antenna

The Roof Antenna

- 1) Receiver is located in the MSR
- 2) 219.84 MHz FM

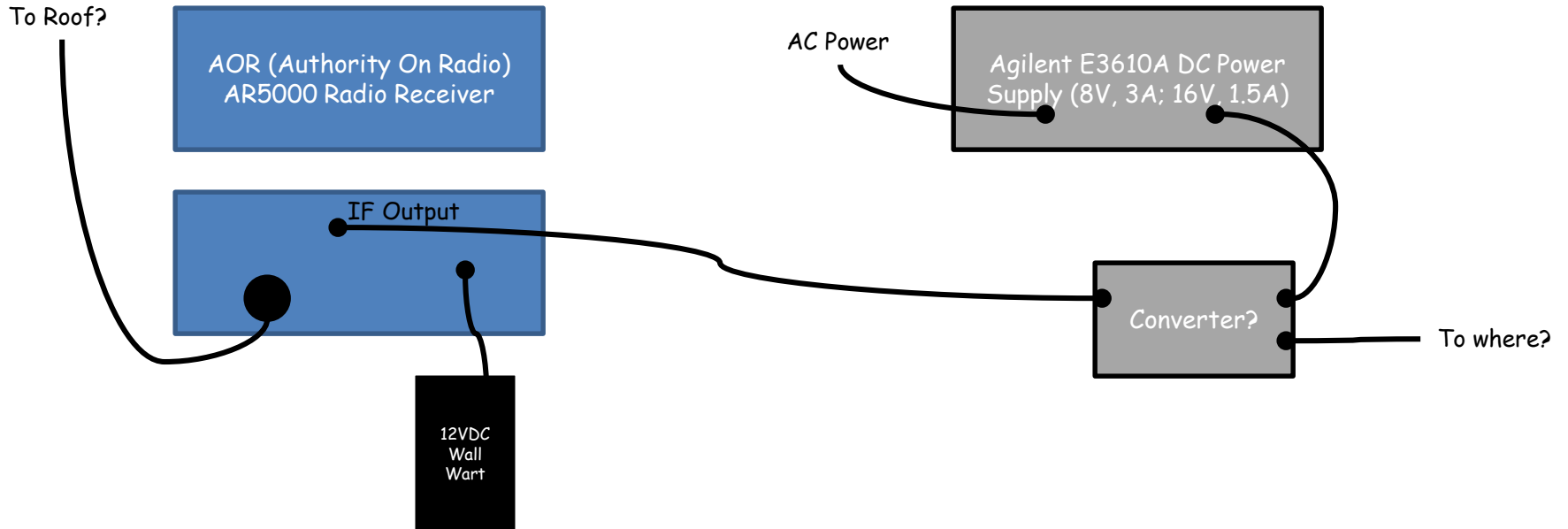

[<< PEM Categories](#)

Humidity sensor locations
1) Room 172 - LDR Changing Room

Relative Humidity/Temperature Transmitter with dual Voltage or Current Output, Compact Size
Discontinued Product! See Note Below

HX93 Series



- 4-20mA or 0-1V Output
- RH and Temperature Output
- Compact Size for Mounting Versatility
- Watertight Enclosure
- Accurate to 2.5% RH and 0.5°C

Click for larger image

Send Action To Email Print Specs

The HX93 Series is no longer available. Please see the [HX93A Series](#) as a substitute or contact Sales/Temperature Engineering.

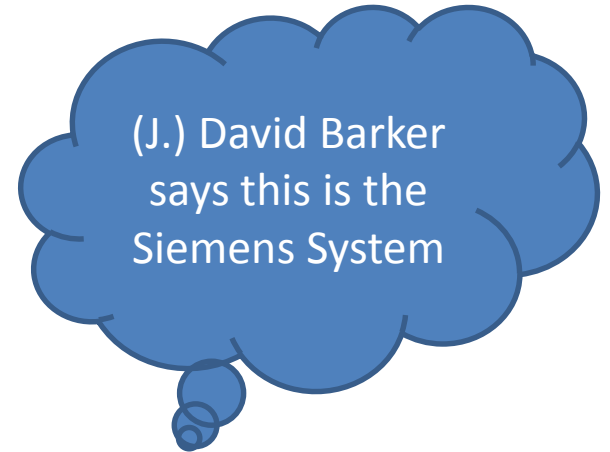

<< PEM Categories

Magnetometer: Bartington Instruments
MAG-03MC

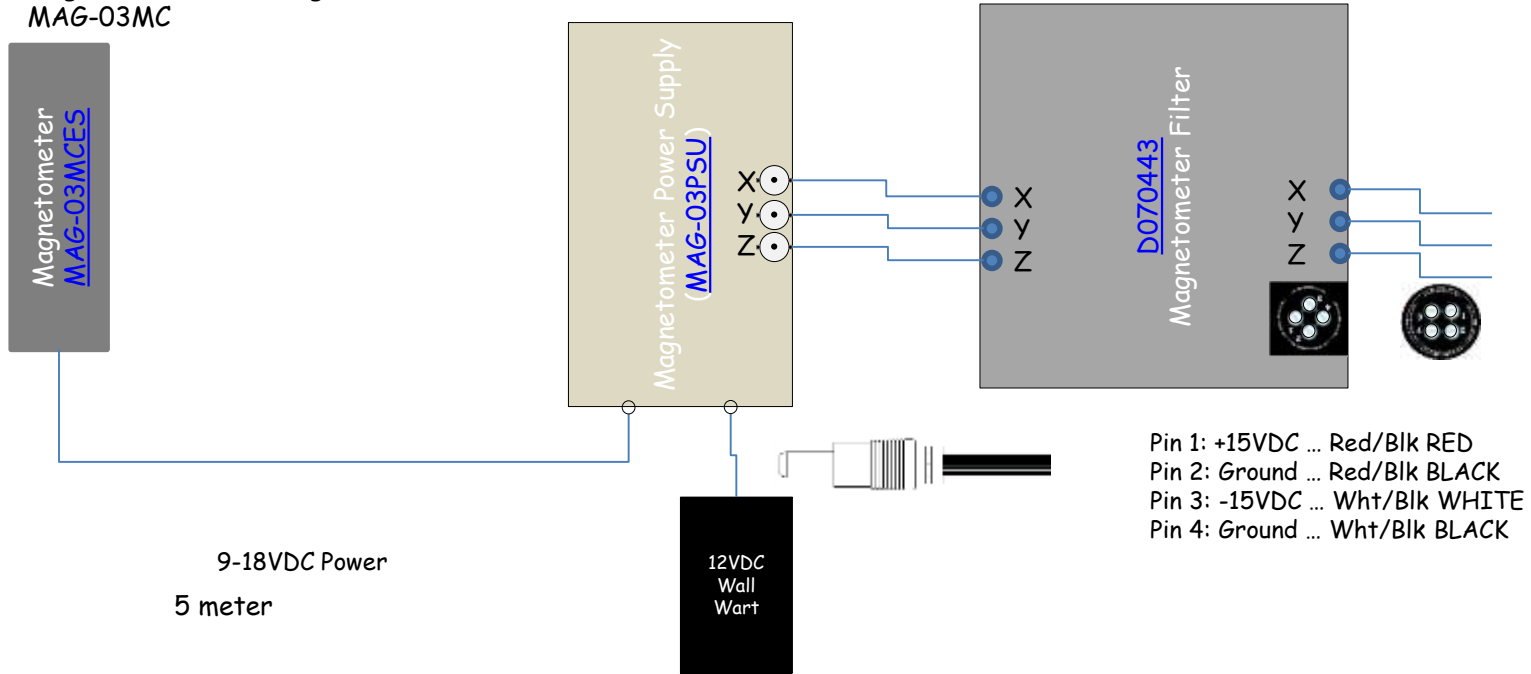

- Pin 1: +15VDC ... Red/Blk RED
- Pin 2: Ground ... Red/Blk BLACK
- Pin 3: -15VDC ... Wht/Blk WHITE
- Pin 4: Ground ... Wht/Blk BLACK



D030574
T1100382

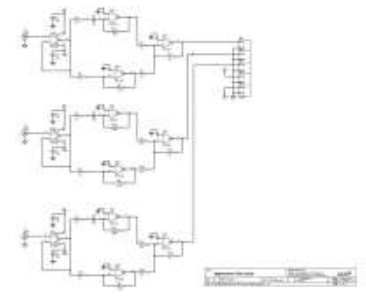

Magnetometers (2) Filter Schematic

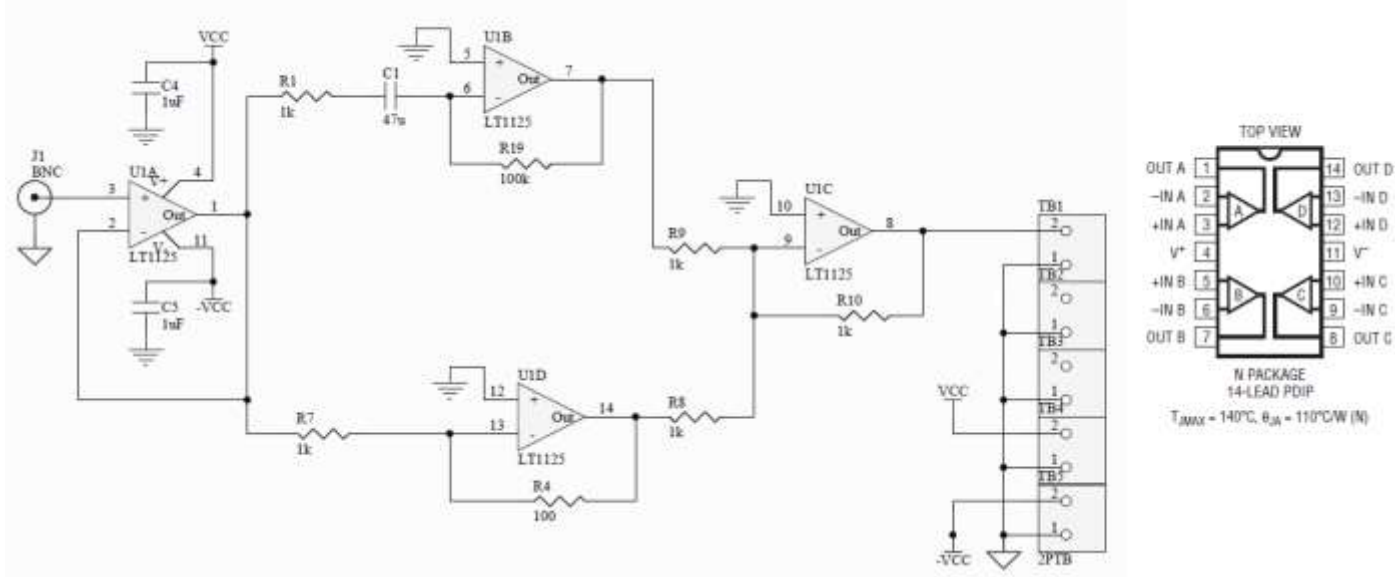

[D030574](#)

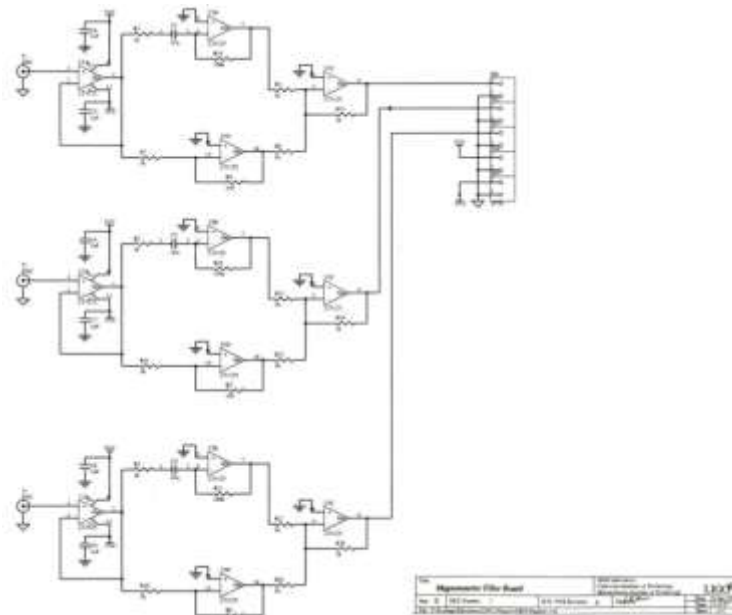

Magnetometers (3) Amplifier Sketch

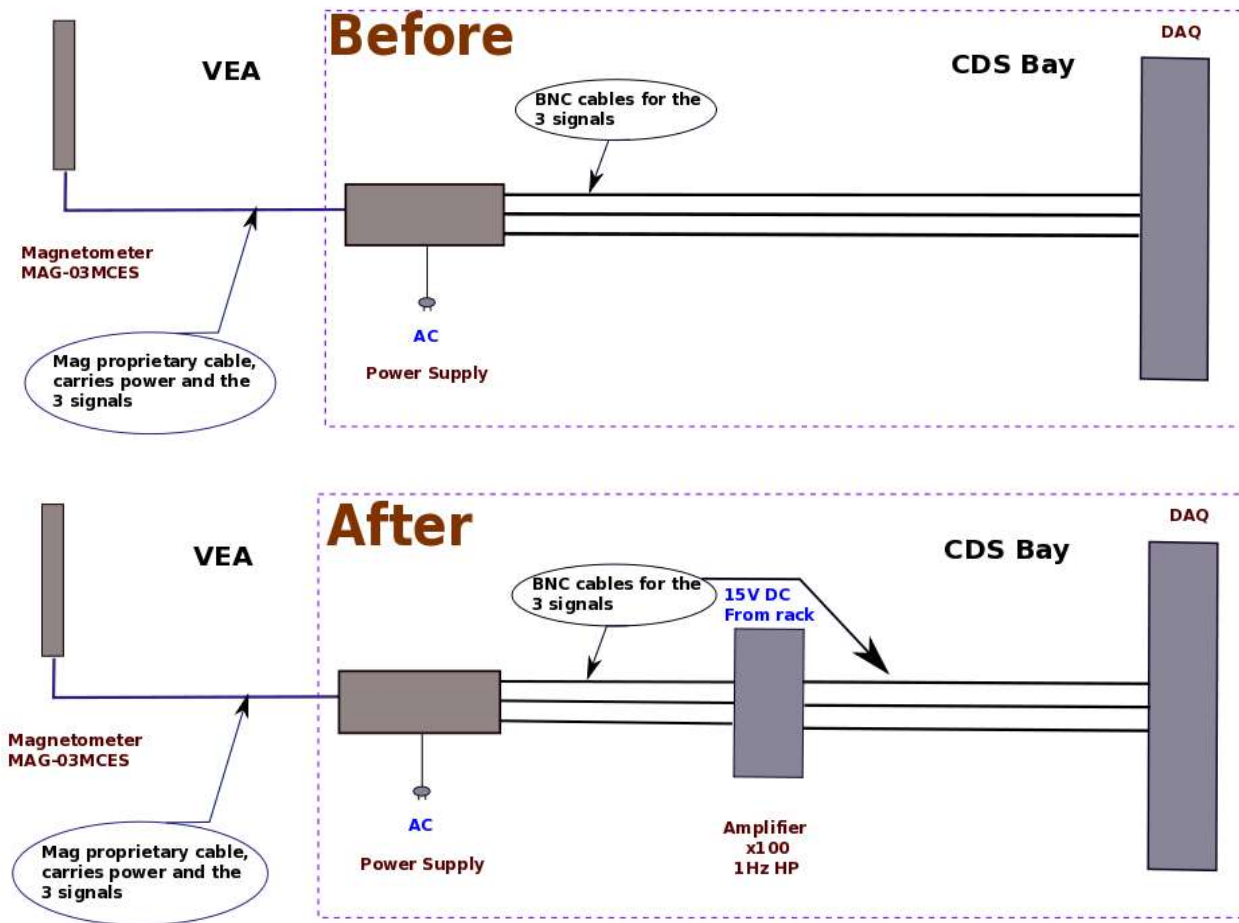

LVEA PEM Sensors (No-Fly Zone)

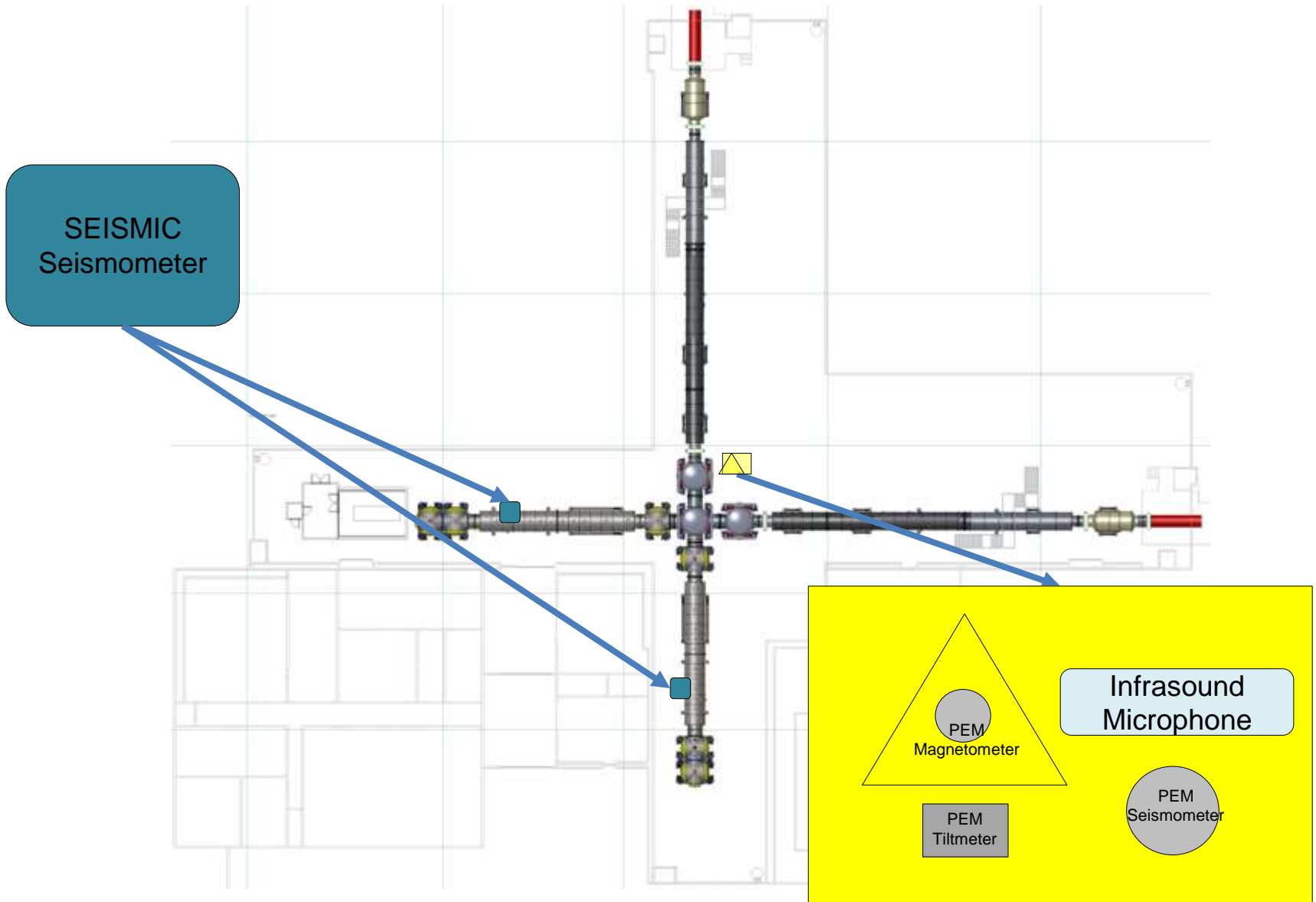

VEAX PEM Sensors (No-Fly Zone)

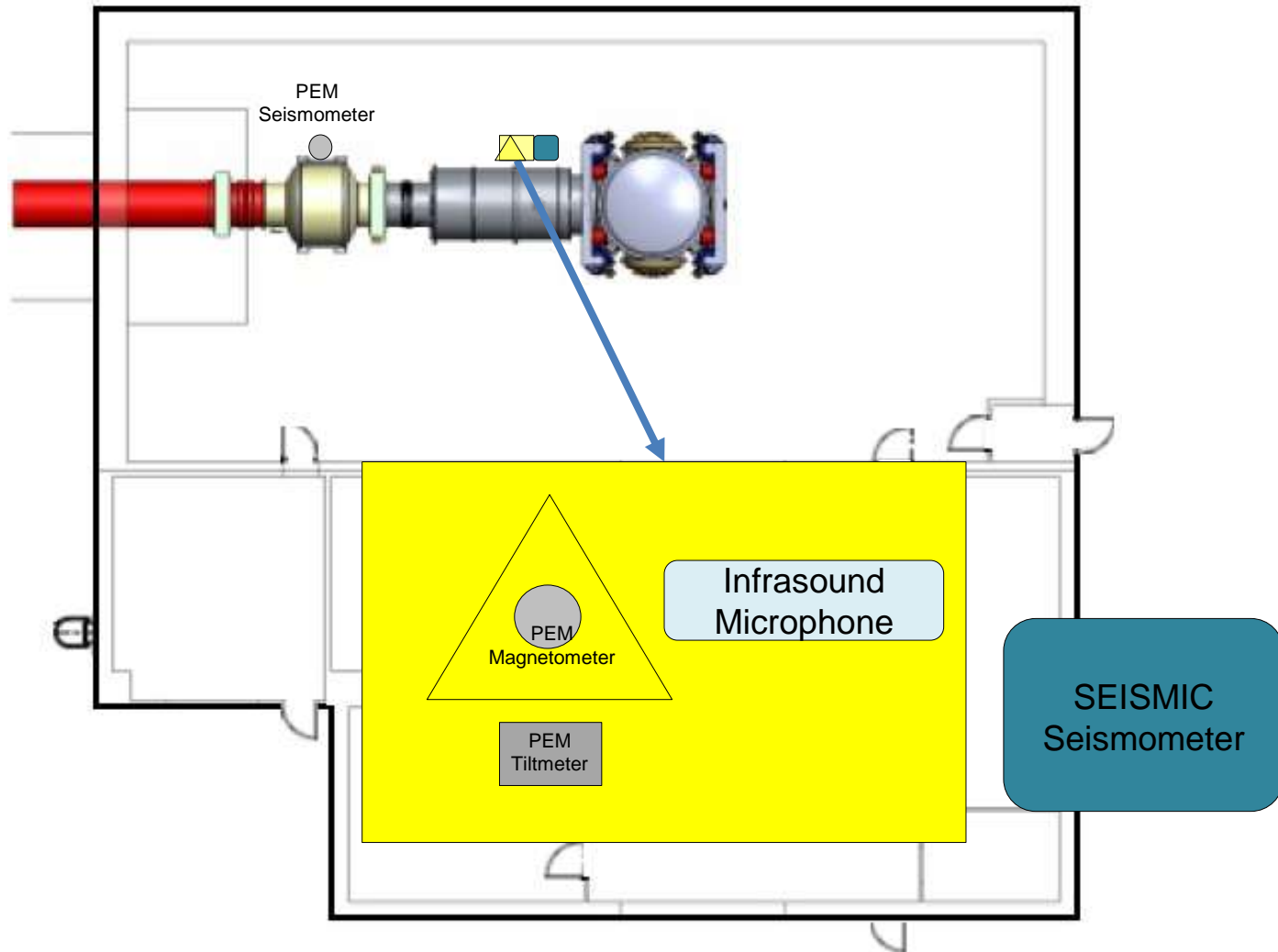

VEAY PEM Sensors (No-Fly Zone)

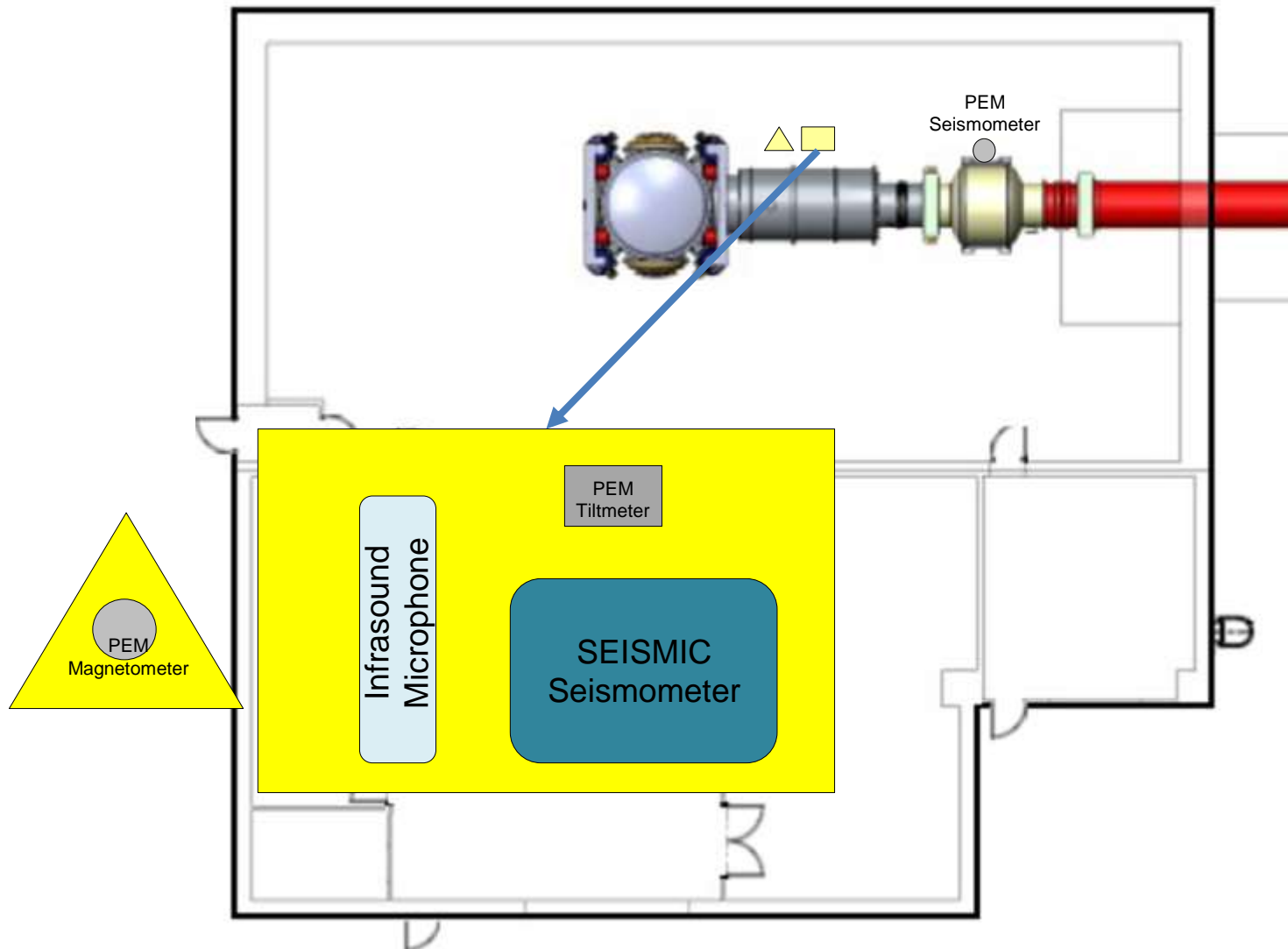

<< PEM Categories

Microphone locations

- 1) LVEA (PSL)
- 2) LVEA (Input Optics (HAM2))
- 3) LVEA (BCS3)
- 4) LVEA (CRYO-X)
- 5) LVEA (CRYO-Y)
- 6) LVEA (Output Optics (HAM6))
- 7) CER (EBAY)
- 8) VEAX (BSC4)
- 9) VEAY (BSC5)
- 10) CERX (XBAY)
- 11) CERY (YBAY)

The Manufacturer is Bruel & Kjaer

Since the power supply handles two microphones, the microphones are 'paired' in certain places.



Extension cables are available -
3m, 10m, and 30m

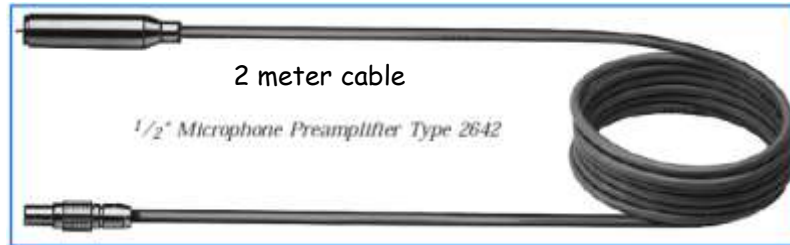

BRÜEL & KJÆR
Naarum - Denmark

Service Instruction Microphone Power Supply

2810

Valid from serial no. 721385

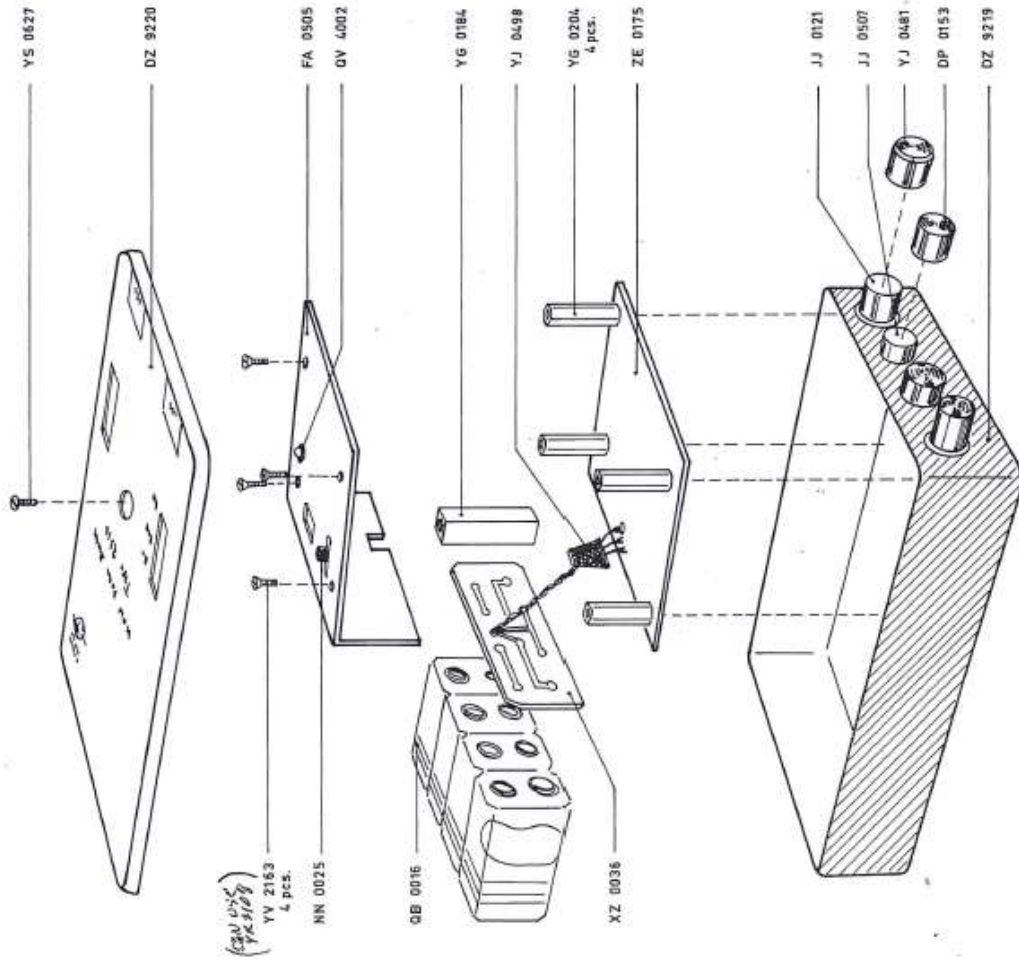

Modifications

Due to the constant technical progress the instrument will be modified from time to time in order to provide continuously improved performance.

For this reason there may be small differences between the instrument and the Service Instruction.

However, the local Representative Service is in possession of all information regarding the modifications that have been made.

Spare Parts

Please state type and serial number of the instrument when ordering spare parts.

3.80



Microphone Power Supply Type 2810

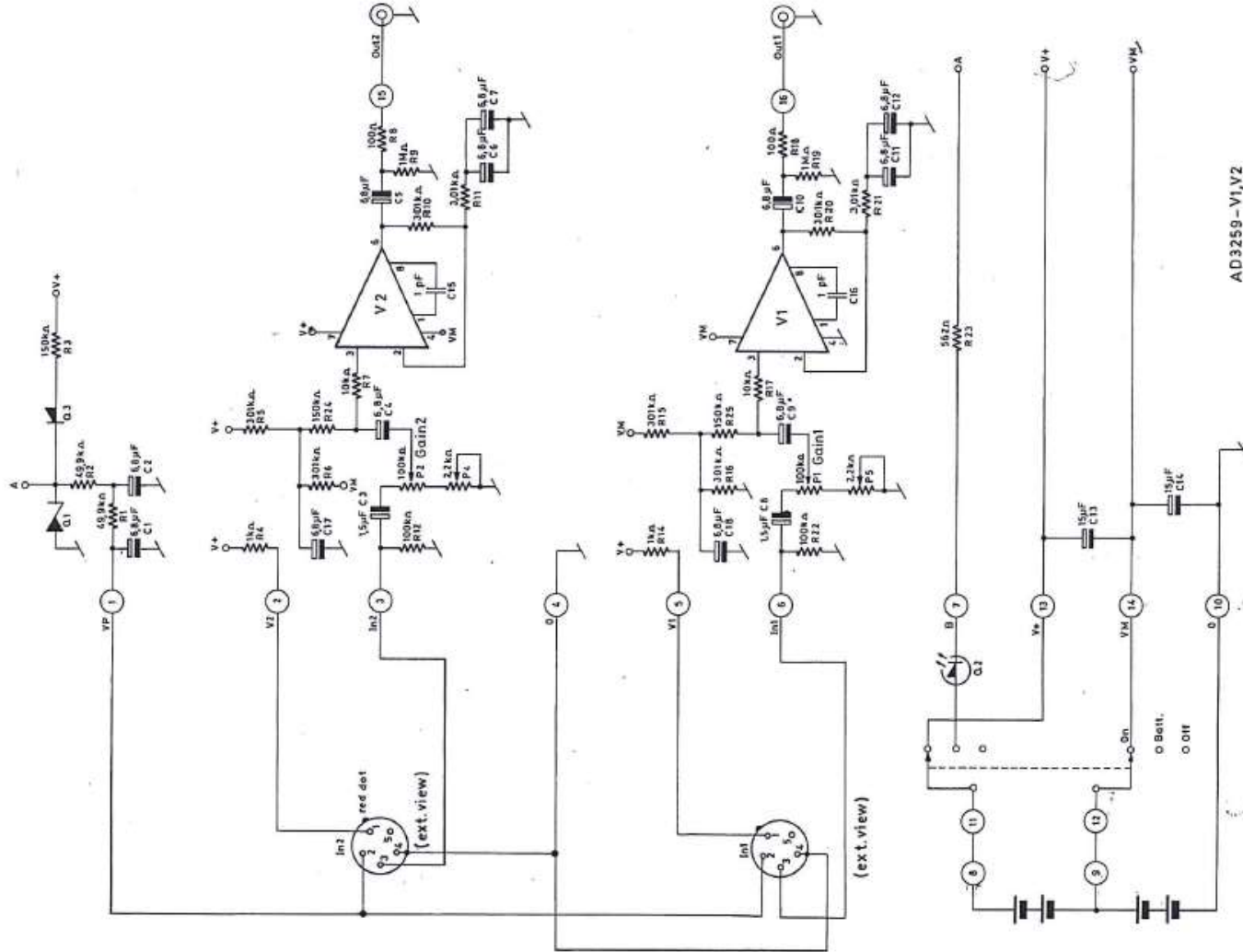

AD3250-V1,V2

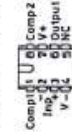

top view



Parts List

C 1,2	Tantalum	6.8 μ F / 35 V	CF 0009
C 3	-	1.5 μ F / 35 V	CF 0008
C 4-7	-	6.8 μ F / 35 V	CF 0009
C 8	-	1.5 μ F / 35 V	CF 0008
C 9-12	-	6.8 μ F / 35 V	CF 0009
C 13,14	-	15 μ F / 20 V	CF 0010
C 15,16	Ceramic	1 μ F / 400 V	CK 0100
C 17,18	Tantalum	6.8 μ F / 35 V	CF 0009
P 1,2	Trimmer	100 k Ω	#D-4104
P 4,5	-	2.2 k Ω	PG 2220
Q 1	Zener	27-28V/0.4 W	QV 1120
Q 2	Light Emitting Diode		QV 4002
Q 3	Silicon	150 V/300 mA	QV 0217
R 1,2	Metal	1/4 W	
R 3	-	49.9 k Ω	RF 4499
R 4	-	150 k Ω	RF 5150
R 5,6	-	1.00 k Ω	RF 3100
R 7	-	301 k Ω	RF 5301
R 8	-	10.0 k Ω	RF 4100
R 9	Carbon	100 Ω	RF 2100
R 10	Metal	1 M Ω	RB 6100
R 11	-	301 k Ω	RF 5301
R 12	-	3.01 k Ω	RF 3301
R 14	-	100 k Ω	RF 5100
R 15,16	-	1.00 k Ω	RF 3100
R 17	-	301 k Ω	RF 5301
R 18	-	10.0 k Ω	RF 4100
R 19	Carbon	100 Ω	RF 2100
R 20	Metal	1 M Ω	RB 6100
R 21	-	301 k Ω	RF 5301
R 22	-	3.01 k Ω	RF 3301
R 23	-	100 k Ω	RF 5100
R 24,25	-	562 Ω	RF 2562
	-	150 k Ω	RF 5150
V 1,2	Op. Ampl.	AD 3259	VE 0057
	Printed Circuit Board		XC 1254
	8-pin DIL Socket		JJ 0804

PS 4117

= QV1103 (solution)



Microphone Power Supply Type 2810

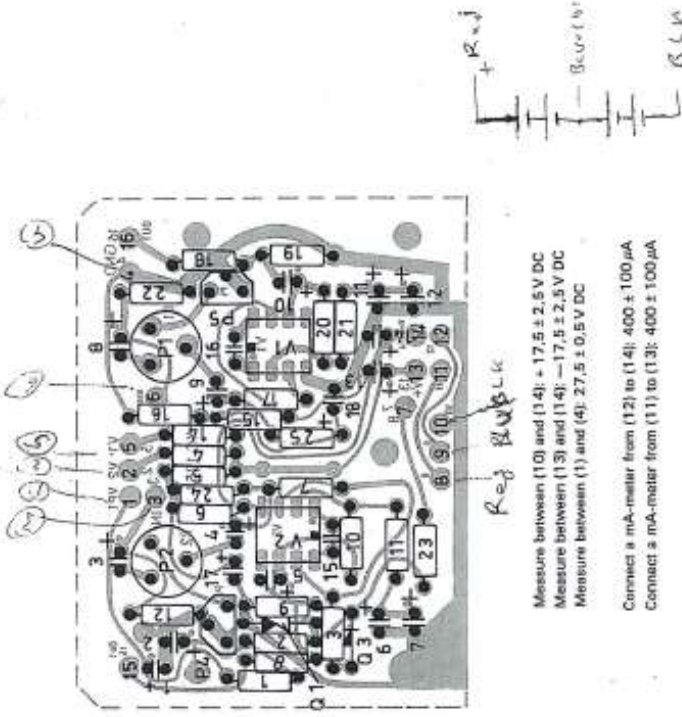

1. Power Supply

- a. Voltage
ON/OFF: "On"
- b. Current Consumption
ON/OFF: "Off"

2. Amplifier

- a. Amplification
ON/OFF: "On"
- b. Frequency Response
- c. Distortion
- d. Output Impedance
- e. Input Impedance
- f. Noise

Measure between (10) and (14): $+17.5 \pm 2.5$ V DC
 Measure between (13) and (14): -17.5 ± 2.5 V DC
 Measure between (1) and (4): 27.5 ± 0.5 V DC

Connect a mA-meter from (12) to (14); $400 \pm 100 \mu\text{A}$
 Connect a mA-meter from (11) to (13); $400 \pm 100 \mu\text{A}$

The instrument consists of two electrically equal amplifiers.
 The following adjustments refers to amplifier 1.

Connect the input signal to (8) and adjust it to 1 kHz, 30 mV RMS.
 Set P1 fully counter clockwise
 Adjust P5 to 0 dB amplification, measured on the output socket.
 Set P1 fully clockwise and check the amplification: 40 ± 0.3 dB.

Connect an oscilloscope to the output.
 Increase the input voltage until the output voltage is 9 Vpp.
 Check that the output voltage is not peak limited.

Set the input voltage (at 1 kHz) for 3 V RMS on output.
 Check the frequency response at:
 10 Hz: ± 1 dB
 10 kHz: ± 0.7 dB
 15 kHz: ± 0.7 dB

Set the input voltage (at 10 kHz) for 3 V RMS on output
 Check the distortion of the output voltage: max 4%

Set the input voltage (at 1 kHz) for 3 V RMS on output
 Load the output with a 2.0 kΩ resistor ($\pm 1\%$)
 Check the output voltage: 3 V RMS -0.5 ± 0.1 dB.

Set the input voltage (at 1 kHz) for 3 V RMS on output
 Connect a 2.21 kΩ resistor ($\pm 1\%$) in series with the input signal
 Check the output voltage: 3 V RMS -0.5 ± 0.1 dB.

Short circuit input to ground.
 Measure the noise signal on output: $400 \pm 200 \mu\text{V}$ (22.5 Hz - 22.5 kHz)
 $300 \pm 100 \mu\text{V}$ (A-weighted)



Microphone Power Supply Type 2810

Microphone Locations (Vertex)

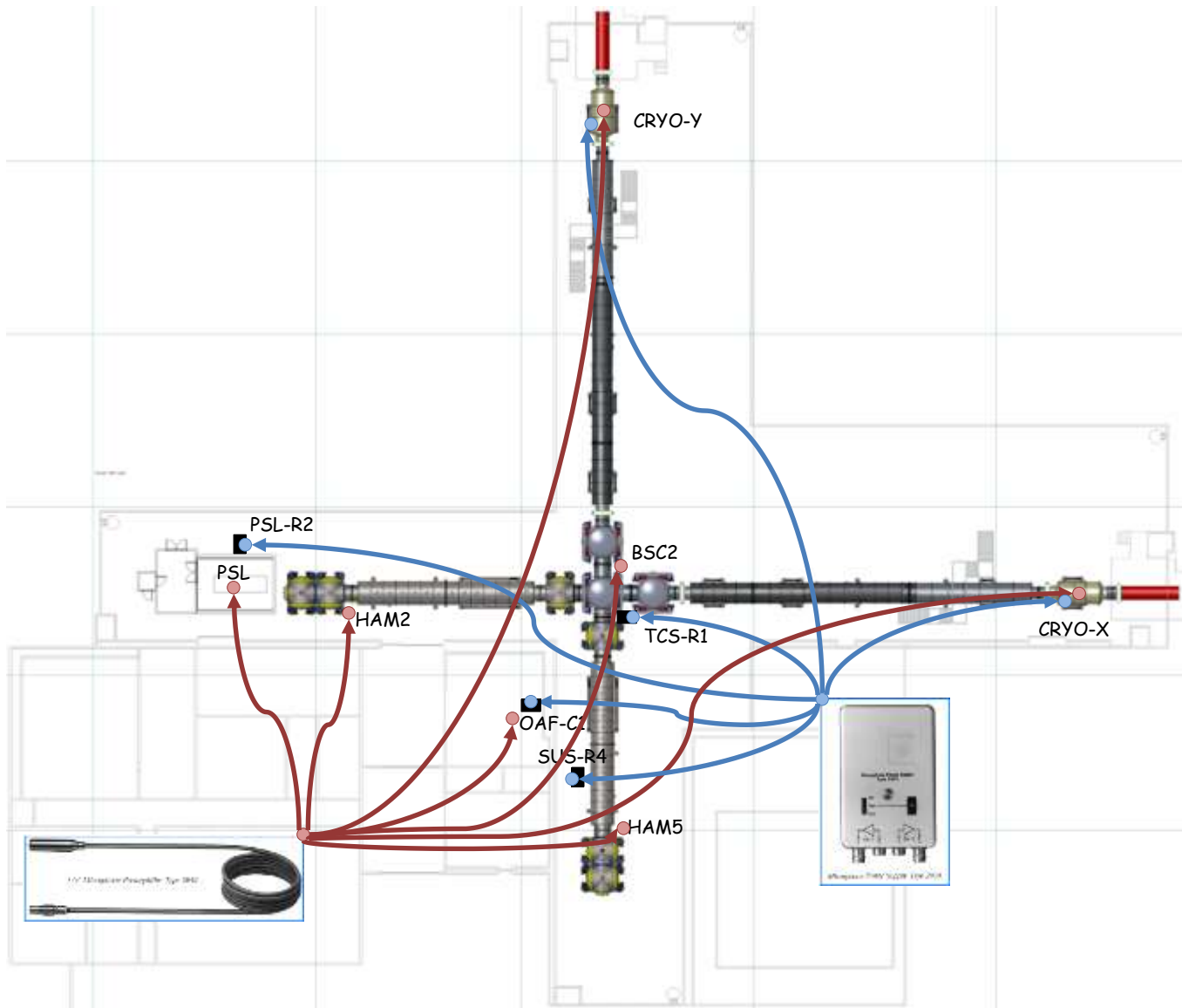

Microphone Locations (X-End)

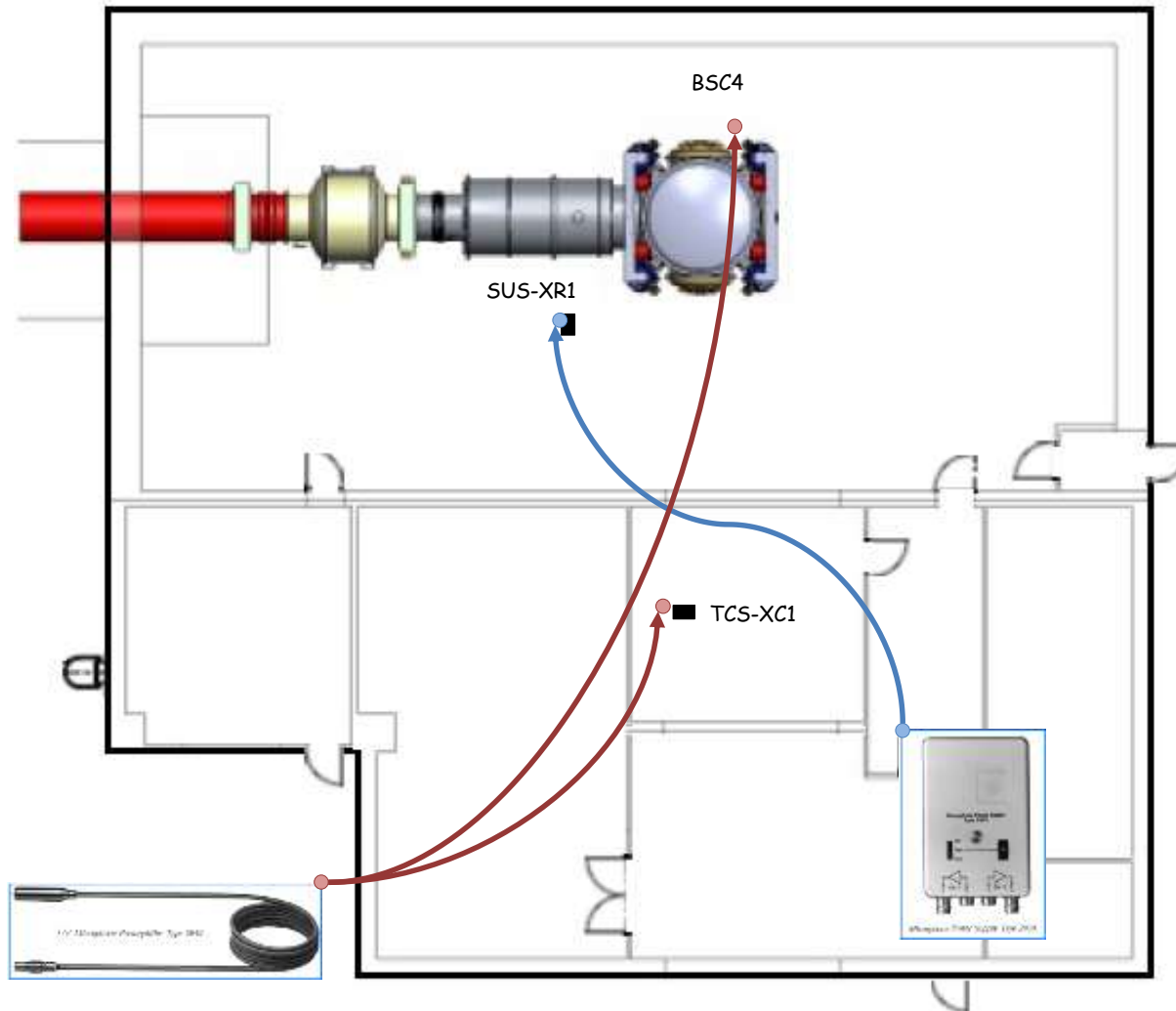

Microphone Locations (Y-End)

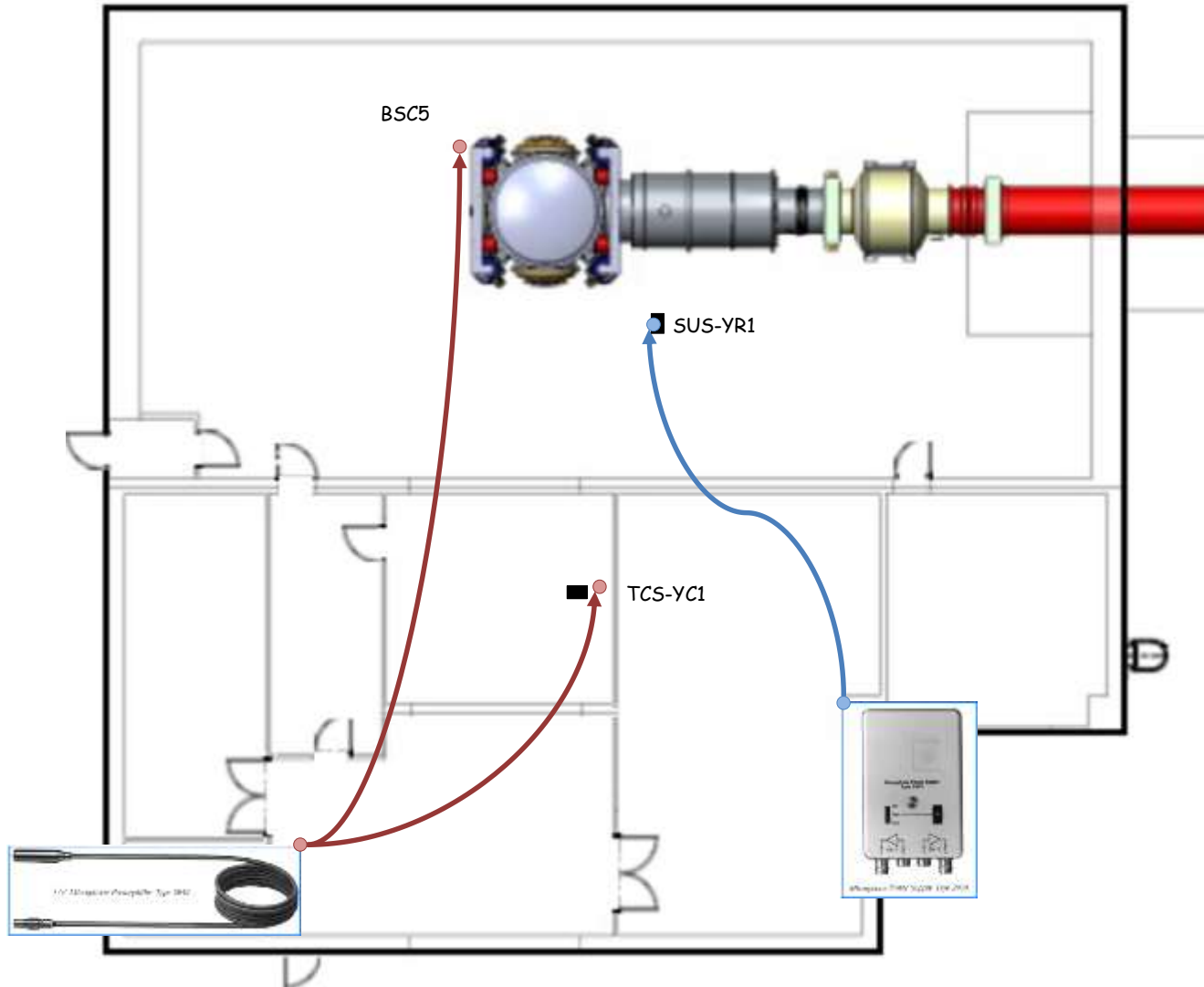

The 2810 was originally powered by 4 (four) 9V batteries. They were self-contained and would not interfere with any other device. But somebody modified them to take DC power from power supplies because perpetually replacing batteries is onerous.

So - due to internal 2810 circuitry that puts the return voltage on the shield of the BNC signal cables, the power supplies that replace the batteries must be configured with a common NEGATIVE pole, and all permanently modified 2810s must be exclusively powered from these supplies.

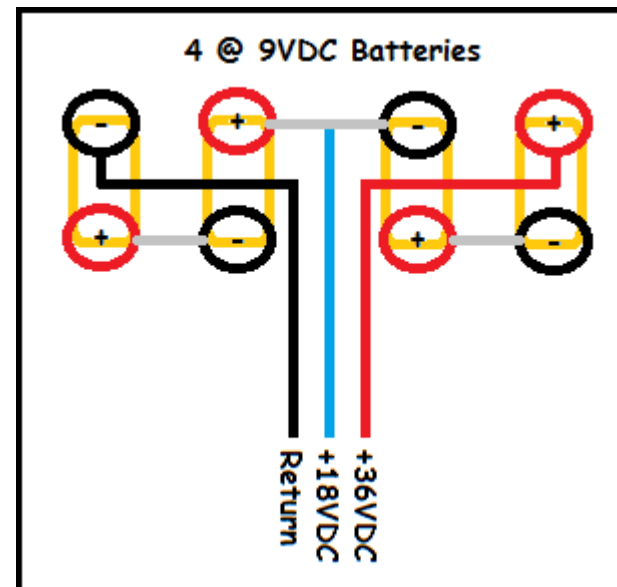
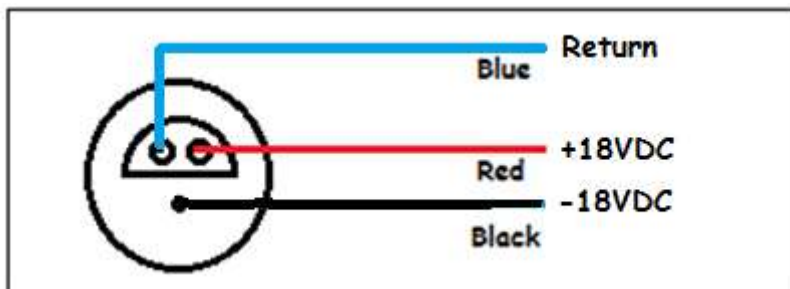
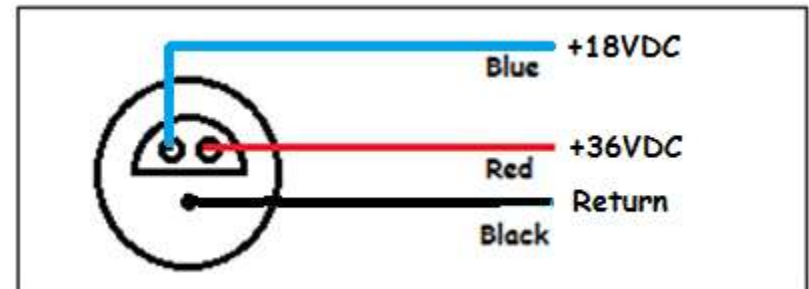
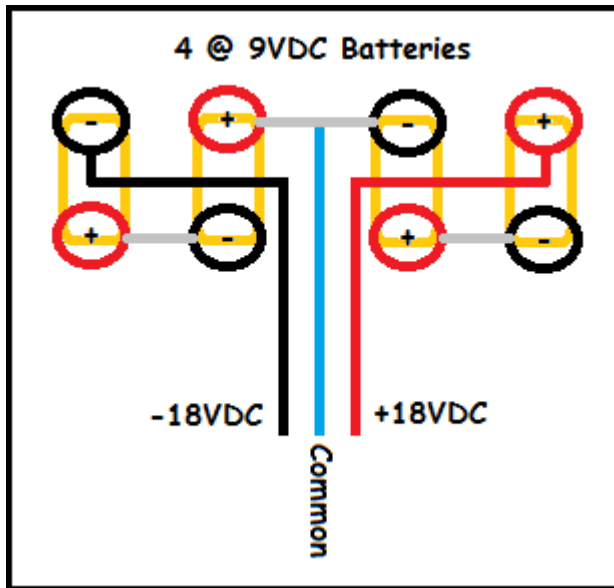

[Anamaria Effler \(Experimental Relativity Group of the Louisiana State University\)](#) 2014-03-05 17:11:21 PST

The PEM microphones require a 0-18-36V power supply. The 0V goes on the shield, so it cannot be floated. They pull very little current (few mA), so one would be sufficient to run several microphones.

The power supply must go into the DC power room, and cables have to be run to each sensor:

- in the end stations, the power cable should be run until under each BSC;
- in the LVEA the power cables should be run under each location, as shown in the LLO sensor map: <http://pem.ligo.org/channelinfo/>

The cable length doesn't need to be exact, just approximately in the area (e.g. between HAM1 and HAM2, for the input optics microphone).

The cable should be left unterminated at the sensor end (and disconnected at the power supply), to be terminated when each sensor is installed.

Currently there are two power supplies on the floor in the LVEA, one in the PSL racks and one between BSC2 and HAM2 serving the PSL microphone and the LVEA microphone. These will be removed when the final solution (above) is in place.

Microphones - Power Adaptor Cable

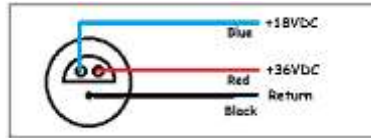

Particle Counters (Dust Monitors)

Dust Monitors are not on during Science Mode due to the acoustic noise. This noise is the air pump. It is always on.

The manufacturer is Pacific Scientific
 Old ones (being replaced) are MET One 227B. (9VDC)
 New ones (replacements) are MET One GT-321. (9VDC, 2A)

These are scattered throughout the LVEA and usually two of them share a power supply via a cable to a junction box. They are powered from the serial interface port. Not sure if this is a homemade adaptation.

The Junction Box needs documentation.

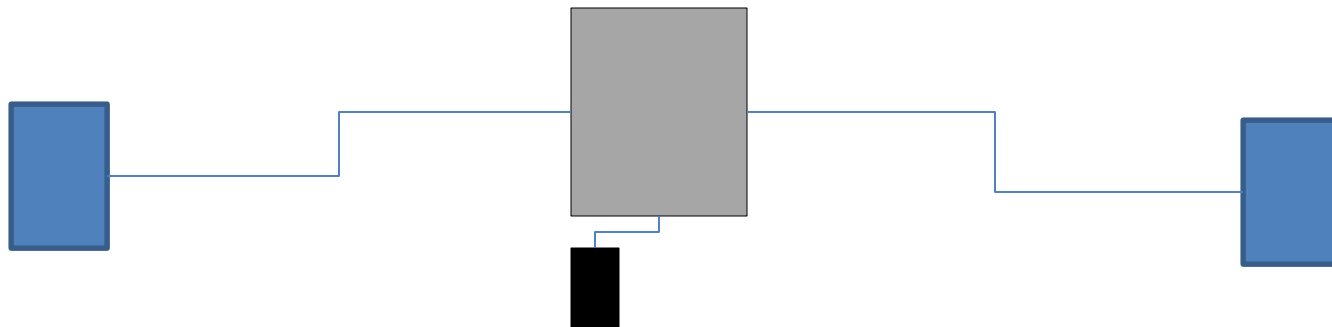
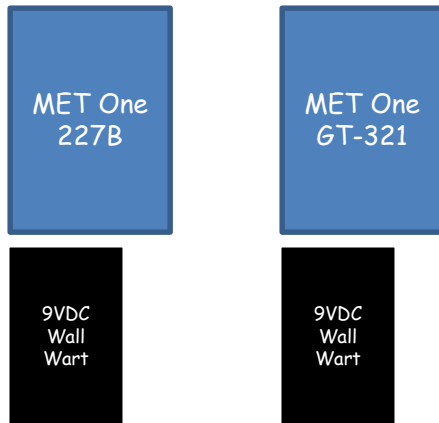

Control DeviceMaster with DB9 Ports

Control DeviceMaster 4 with DB9 Ports

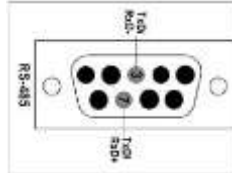

4-Port Power Supply

This table provides the specifications for the power supply shipped with the DeviceMaster 4-port.

Control Power Supply: 4-Port	
Input line frequency	47 - 63 Hz
Input line voltage	90 - 260 VAC
Output voltage	24VDC
Output current	500 mA @ 24VDC



Housing Molex P/N:
39-01-4030
Pins Molex P/N:
44485-1211



3M Shell 3357-9209



2.1mm Socket
(Note polarity)

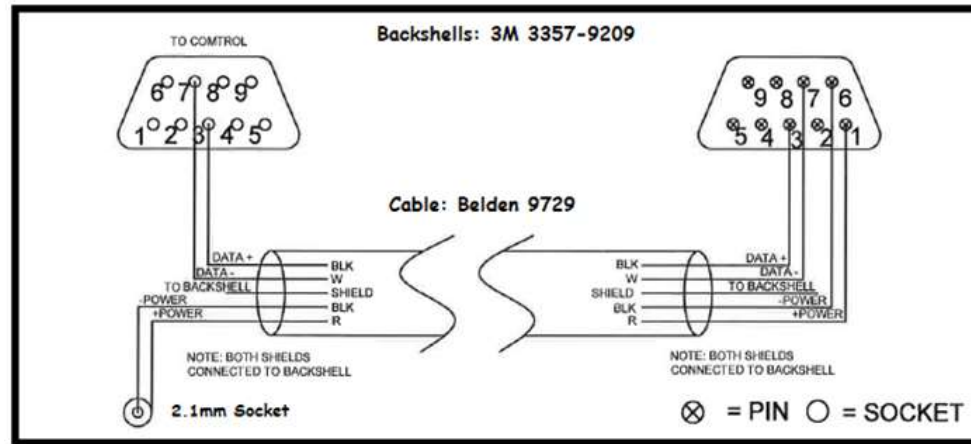

3M Shell 3357-9209

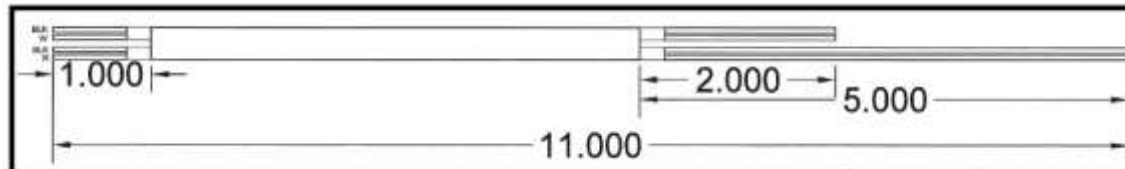



3M Shell 3357-9209



2.1mm Socket
(Note polarity)

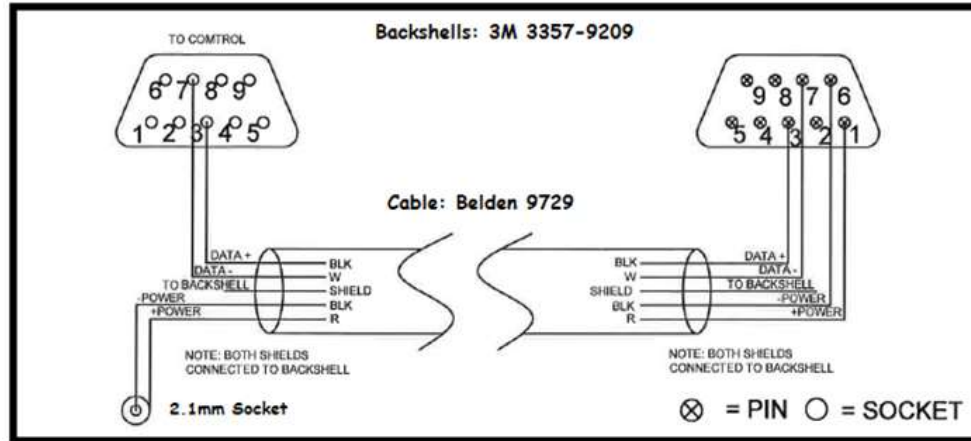

3M Shell 3357-9209

This cable is configured to carry both DC Power and RS485 Signals. The 2.1mm Socket can come from a commercially available 2.1mm Cable Assembly. Note the center pin of the 2.1mm is NEGATIVE. And both shields are tied together and tied to both backshells.

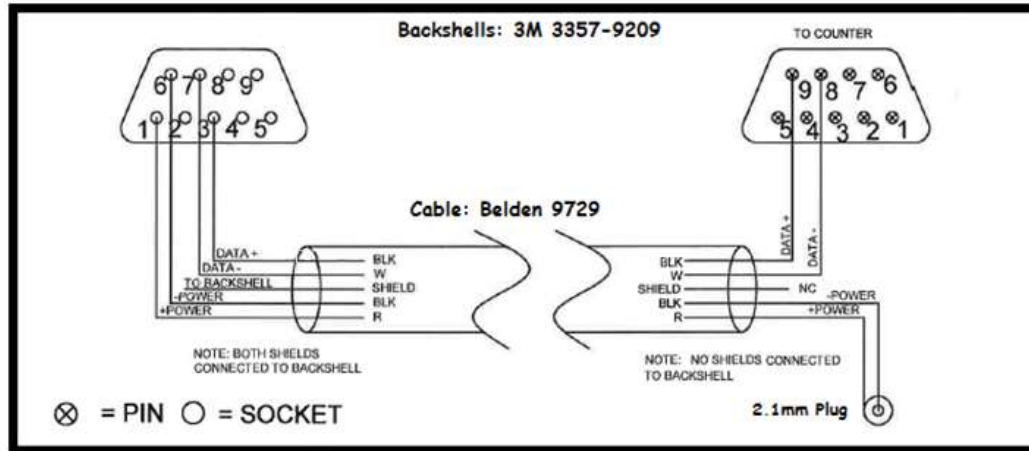

This cable is configured to carry both DC Power and RS485 Signals. The 2.1mm Plug can come from a commercially available 2.1mm Cable Assembly. Note the center conductor of the 2.1mm is NEGATIVE. And both shields are tied together and are tied only to the backshell that connects to the cable. The backshell connected to the Particle Counter is NOT tied to the shields.

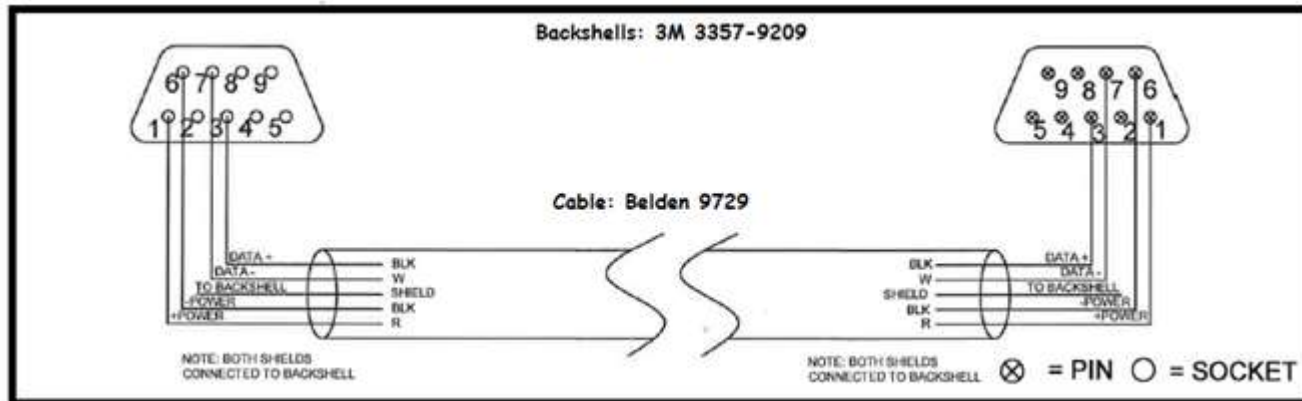

This cable is configured to carry both DC Power and RS485 Signals. Note that both shields are tied together and tied to both backshells.

It is 70' from the L1-FAC-XC1 Rack to the knee of the waterfall in the VEAX.

It is 65' from the L1-FAC-YC1 Rack to the knee of the waterfall in the VEAY.

3M Backshell Assembly

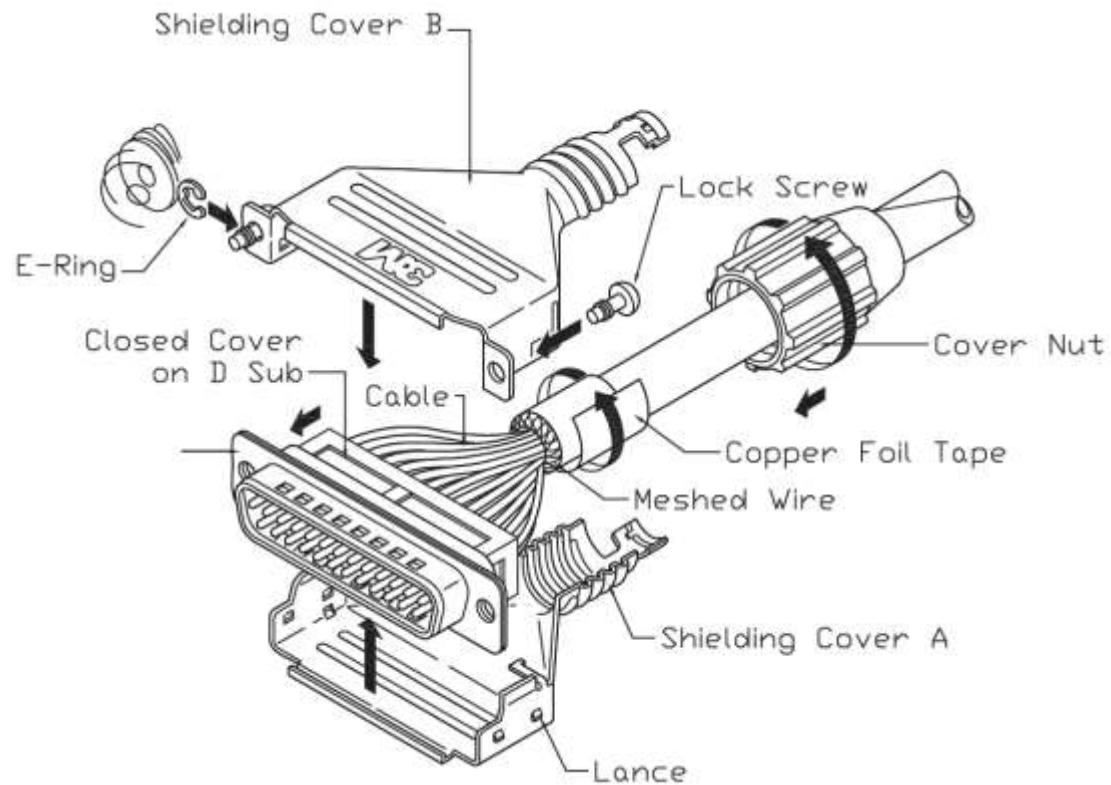

This is a sample drawing of the 3M backshell showing how the E-Ring is attached to the Lock Screw, and showing how the Cover Nut holds the backshell in place.

Particle Counters (Met One 227B)



Model 227 Series Hand-Held Particle Counter
With Temperature/Relative Humidity Probe

Connector for Counter
or RS-232/RS-485
Converter

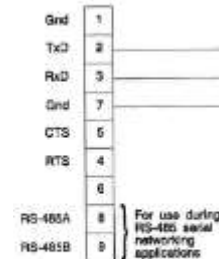

Connector for
Computer
(IBM PC/PS)

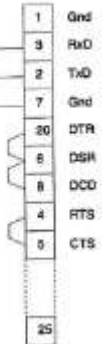

Serial Cable Schematic Diagram



3M Shell 3357-9209

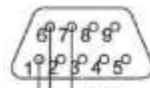

Belden 9729

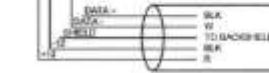

2.1mm Plug

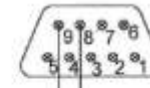

3M Shell 3357-9209

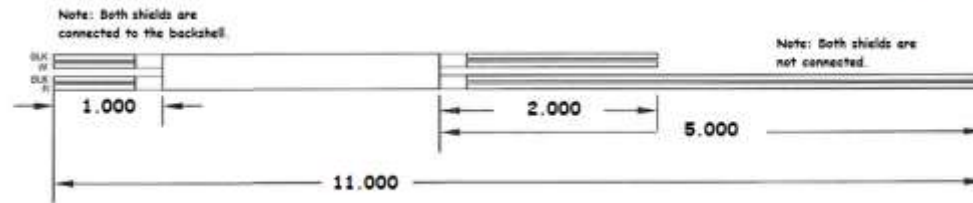

⊗ = PIN ○ = SOCKET



2.1mm Plug
(Note polarity)

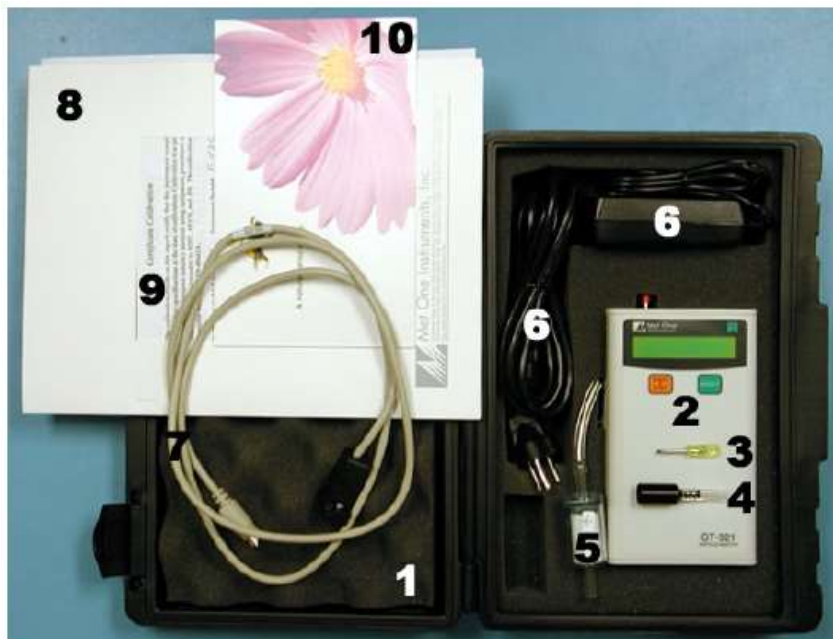

1. Carrying case
2. GT-321 Hand Held Particle Counter
3. Miniature screwdriver
4. Iso-kinetic Sample Probe with a short piece of tubing
5. Zero Particulate Filter (Met One Part Number G3111)
6. Universal AC to DC converter module with IEC AC power cord
7. RS-232 Serial Cable
8. Operation Manual
9. GT-321 Calibration Certificate
10. Color Brochure (optional)



Seismometer locations

- 1) BSC1 (LVEA) -
- 2) BSC4 (VEAX) - [Guralp CMG-40T](#)
- 3) BSC5 (VEAY) - [Guralp CMG-40T](#)
- 4) EELAB (SPARE) - [Guralp CMG-40T](#)



PT06E-16-26S(SR)-ND
CONN PLUG 26 POS
STRAIGHT W/SCKT



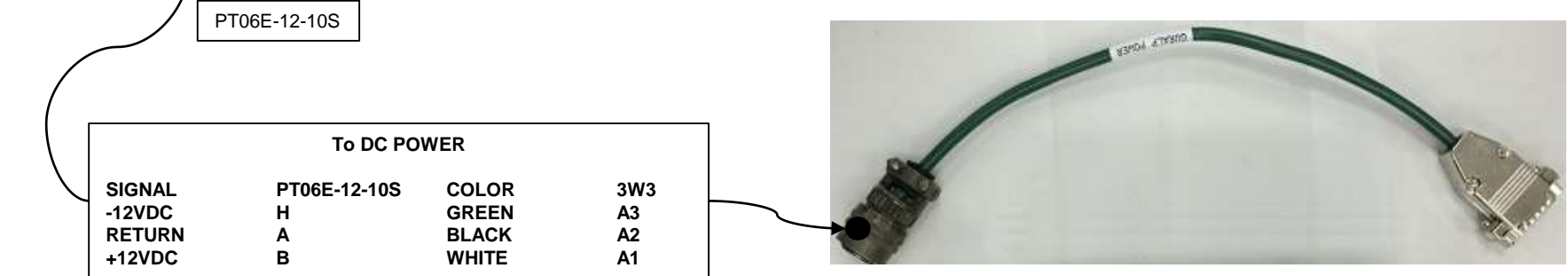
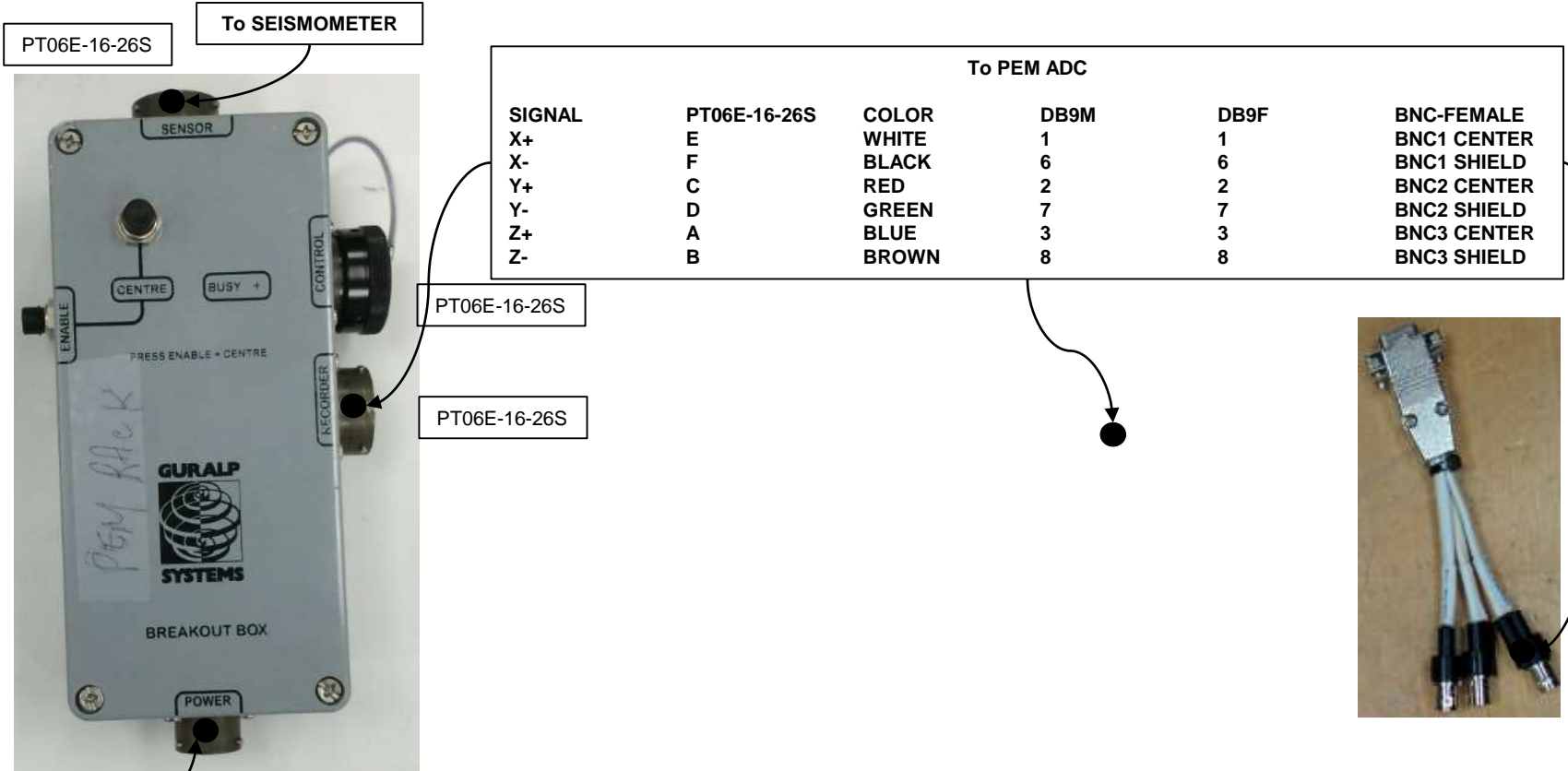



PT06E-16-26S(SR)-ND
CONN PLUG 26 POS
STRAIGHT W/SCKT



501-1030-ND
BREAKOUT BNC
FEMALE-20AWG LEADS



PT06A-14-15P(SR)-ND
CONN PLUG 15 POS
STRAIGHT W/PINS



PT06E-12-10S(470)-ND
CONN PLUG 10 POS
STRAIGHT W/SCKT



PT06A-14-15S(SR)-ND
CONN PLUG 15 POS
STRAIGHT W/SCKT



Temperature Sensors

Temperature Sensor locations

- 1) BSC1 (LVEA) - one old, one new
- 2) BSC3 (LVEA)
- 3) BSC4 (VEAX)
- 4) BSC5 (VEAY)

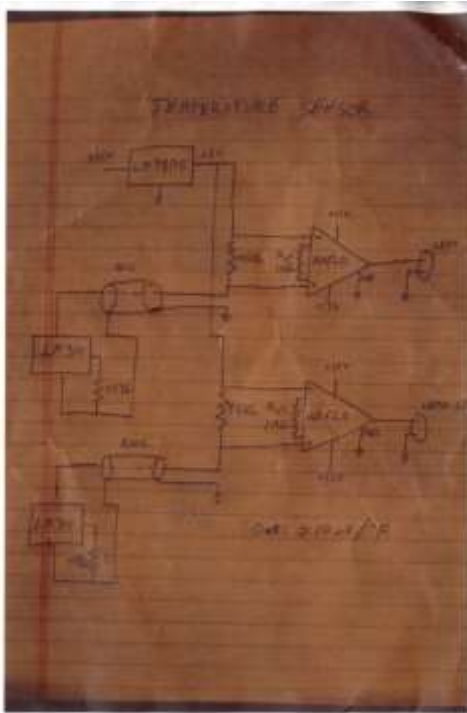

Temperature Sensors include thermocouples:

- 1) Are there any read in the chiller lines? TCS, PSL?
- 2) There are thermocouples in the vacuum system for the N2 tanks.
- 3) <https://dcc.ligo.org/G1401168-v1>

1005-11
Tue Jan 9
2007
(Local)

Topic: Committing Author: Valera Frolov Tue Jan 9 16:05:43 2007 UTC

Thermocouple readout

According to Russ the thermocouple goes straight to ADC.
The 12 bit ADC is not sensitive enough for the K type Omega
thermocouple that has EMF range -40 mV/C.

- Valera Frolov <http://ligo.ligo.caltech.edu/>

NO_KEYWORD Add or Remove Keyword: NO_KEYWORD

Temperature Sensors

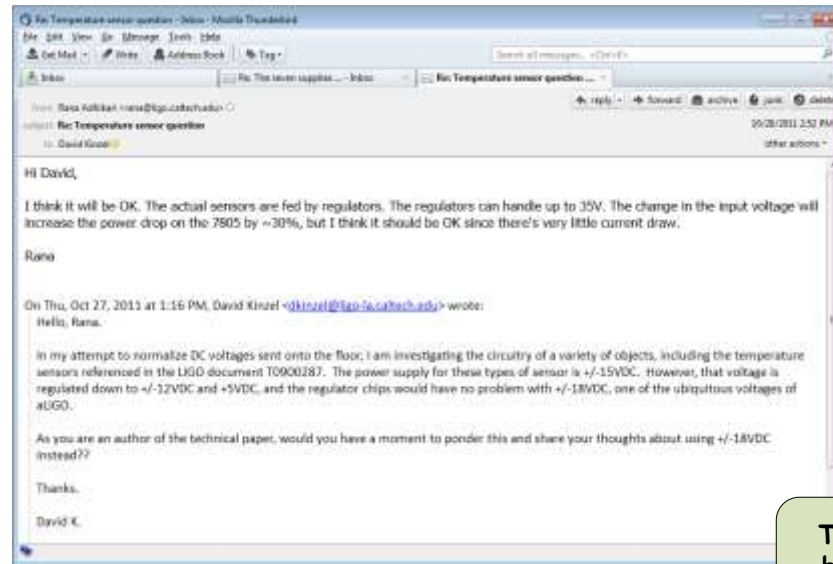

These cables can be replaced with standard +/-18VDC

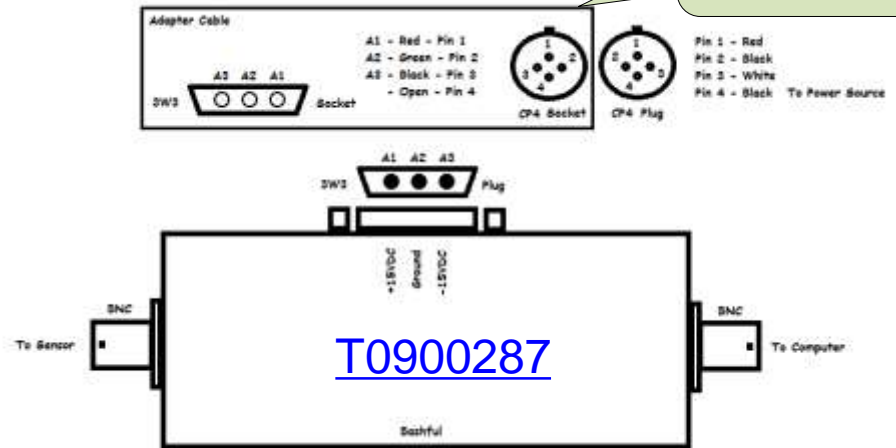

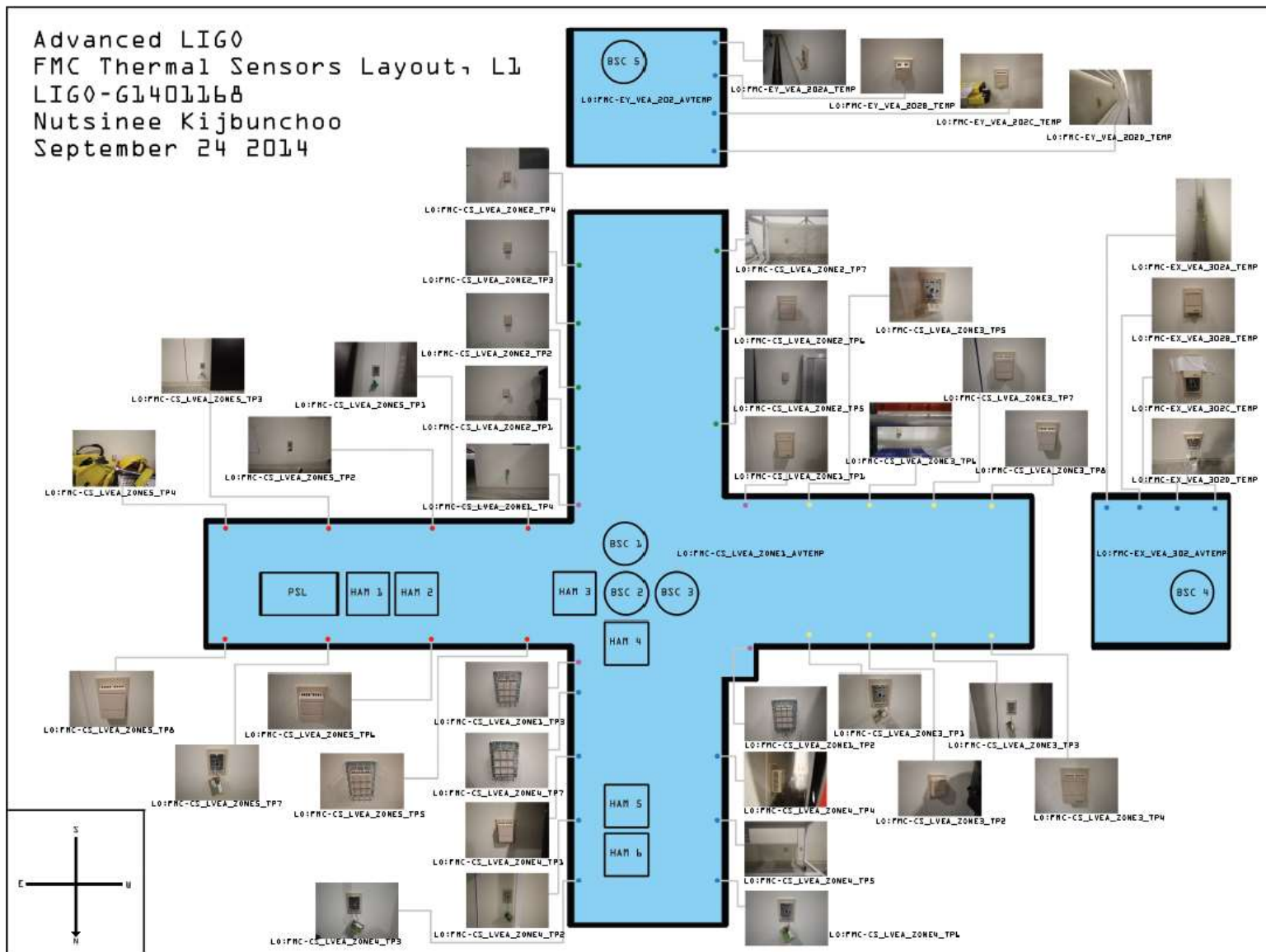

Tiltmeters



PT06E-16-26S(SR)-ND
CONN PLUG 26 POS
STRAIGHT W/SCKT



Comments as of 20100525

PEM Voltage Monitor locations:

- 1) LVEA - Rack 1X5 - DAQIC2, BNC Port 13
- 2) VEAX - Rack 1X20 - DAQIC2, BNC Port ?
- 3) VEAY - Rack 1Y20 - DAQIC2, BNC Port 10

This monitor is labeled, "PEM Voltage Monitor No. CAS-Vxx." The circuit board inside says, "LHO EE Power Monitor Board D0000TBD." Documentation is scarce. This device is probably OK for monitoring the single balanced power into which it is plugged in Rack 1X5. It is intended to record the differential between the two phases of the balanced power. But if it is used on any 'real' AC circuit, it creates the potential for a $\frac{1}{2}$ line voltage ground loop between neutral and ground, and another between hot and ground.

Additionally, even in the balanced power situation, NEUTRAL is the wrong designation, for none of the conductors is neutral in a balanced power circuit: it is the negative AC power.

The circuit ties all shields together, so current loops exist between 2 potentially different AC circuits.

And also the cable ties all shields together, creating the same problem.

And most ironic, the monitor in Rack 1X5 is NOT being read at all: there is no signal name, but it is plugged in. (This was NOT true in September 2009 when inventory of the DAQIC signals was last taken.)

At the YEND, the AC cable has only three BNC connectors. Two are connected to the Voltage Monitor box.

At the XEND, the AC cable has all four BNC connectors, but they are cross-connected to the Voltage Monitor Box: Cable HOT1, NEU1, HOT2, NEU2 are connected to Box HOT2, NEU2, HOT1, NEU1 and I did not check the cable for accuracy. I did note it only has 2 wires coming into the CP4 port, however, but which two is not clear.



LHO EE
Power
Monitor
Board
D000TBD?

Voltage Monitor (2)

Photos as of 20100525



Internal Design and Interfaces as of 20100525

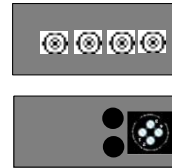
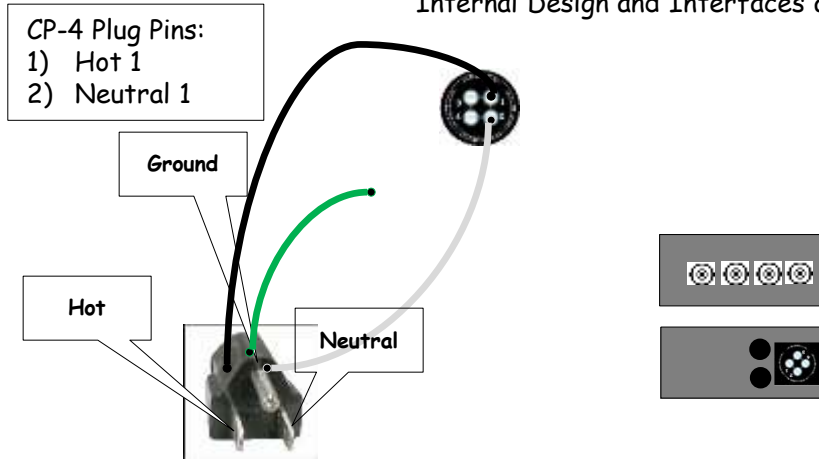

AC Power (input to monitor)
 2 - Fuses - 250V 1/4A

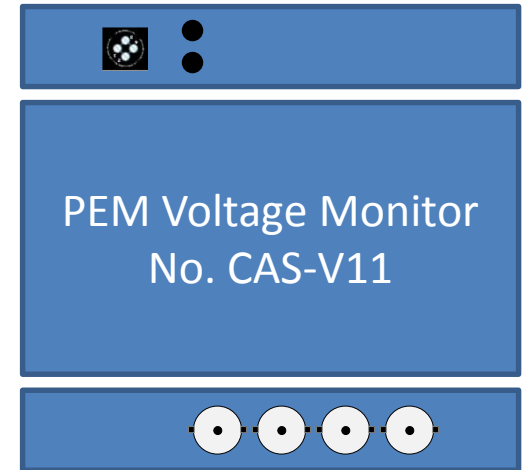

J4 - Neutral 2
 J3 - Hot 2
 J2 - Neutral 1
 J1 - Hot 1

Outputs

CP-4 Socket Pins:
 1) Hot 1 - fused
 2) Neutral 1
 3) Hot 2 - fused
 4) Neutral 2

R1,R3,R5,R7 = 1M Ω
 R2,R4,R6,R8 = 1k Ω
 Fuse1,2 = 250V, 1/4A

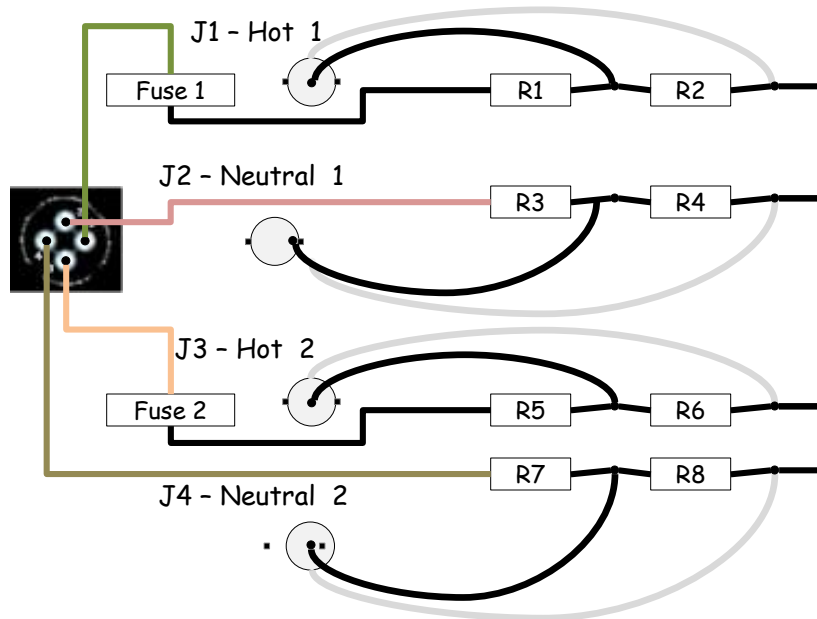

Cable design as of 20100525

Cable: From 4 BNC connectors to 4-Pin Lemo on DAQIC-2

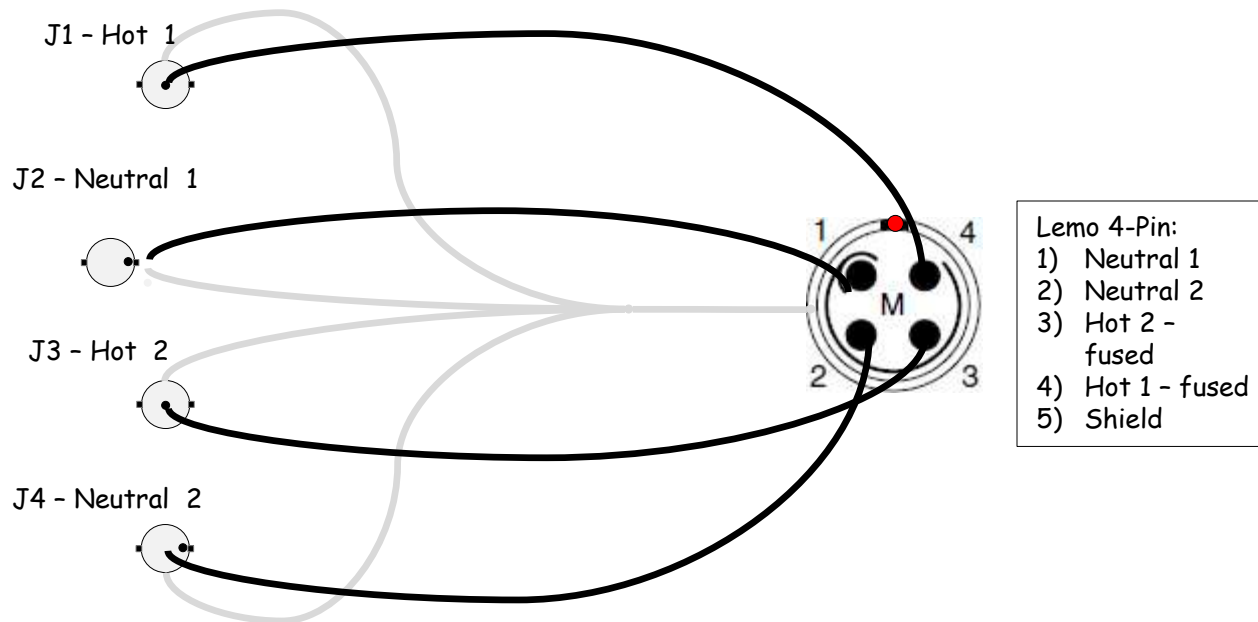

[<< PEM Categories](#)

Weather Sensor locations

LLO network



LSU network

- Cameras
- Computer Monitors
- Lights

Vacuum Equipment

Rechargeable Flashlights

Optical Isolators

Trouble Lights

Warning Signs

Laser Hazard Status Signs

Laser Danger Signs

Loudspeaker

Telephones



3-Pin Power Connector

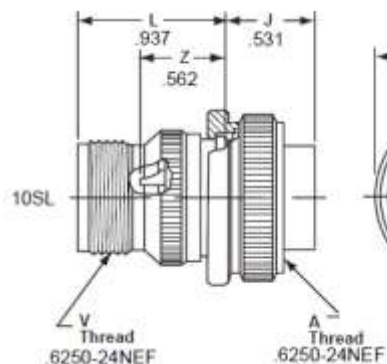

Amphenol[®]
Industrial

Mouser Part #: 654-MS3106A10SL-3S
 Manufacturer Part #: MS3106A10SL-3S
 Manufacturer: Amphenol Industrial
 Description: Circular MIL Spec Connector 3P #16 SKT CONTACTS

Amphenol[®]
Industrial



Mouser Part #: 654-97-3057-1004-1
 Manufacturer Part #: 97-3057-1004-1
 Manufacturer: Amphenol Industrial
 Description: Circular MIL Spec Strain Reliefs & Adapters Clamp with Bushing Size 10SL, 12S

Pin A -
 Pin B -
 Pin C -

<< LLO Racks by Subsystem

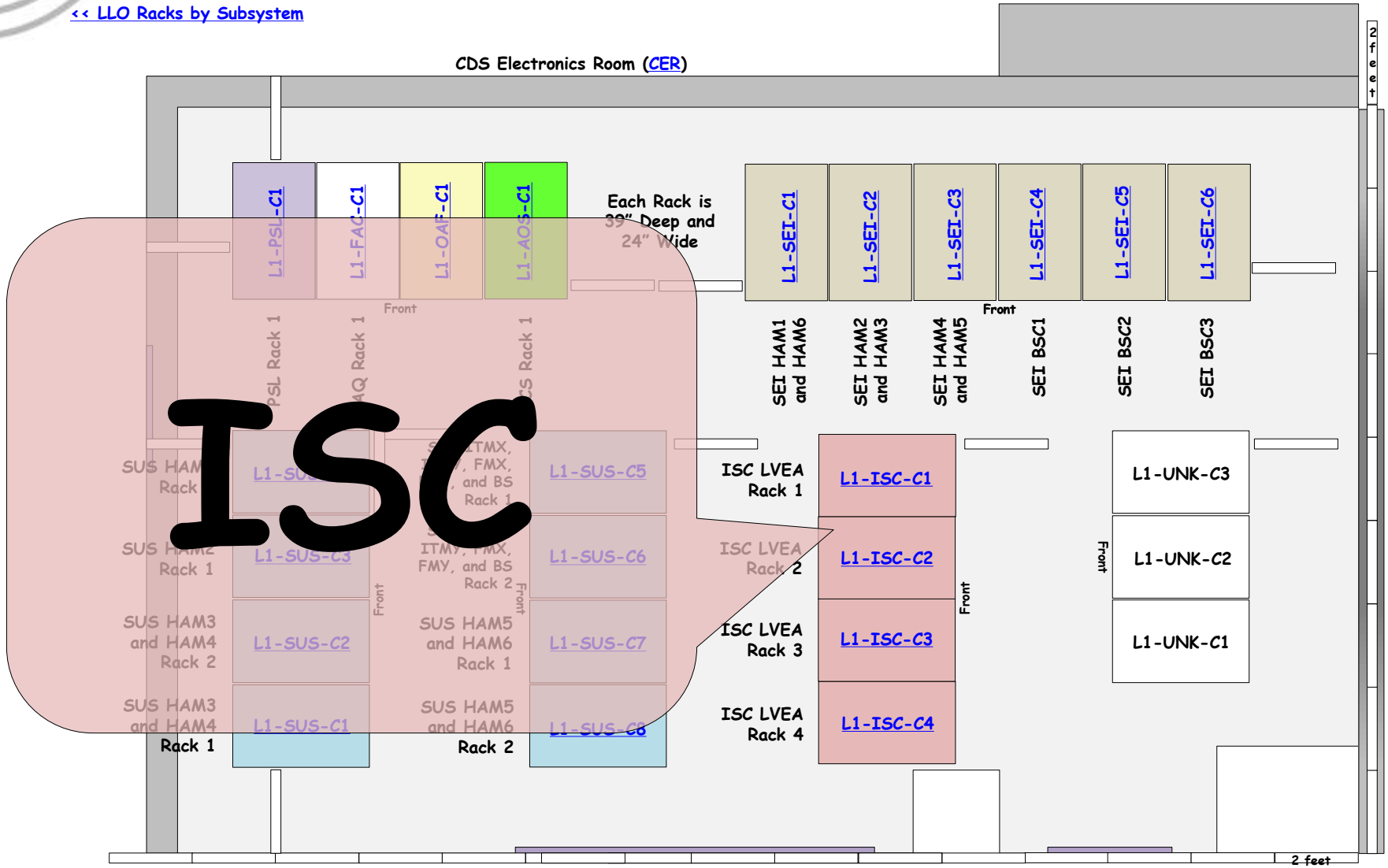

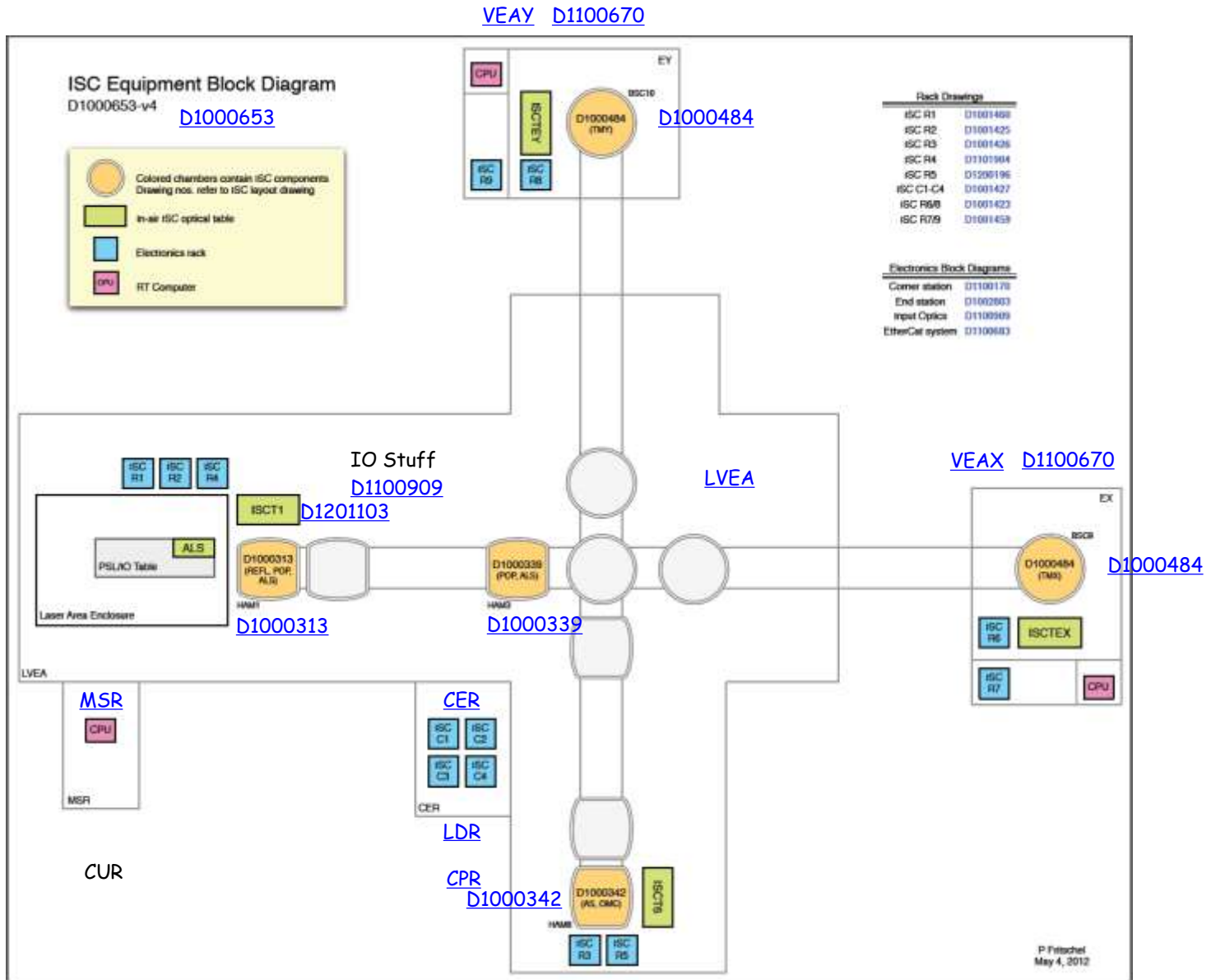

		42			
		41			
		40			
		39			
		38			
Anti-Alias Chassis (ASC)	D0902783	37	S1102778	±18VDC	
Anti-Alias Chassis (ASC)	D0902783	36	S1102772	±18VDC	
		35			
Anti-Alias Chassis (ASC)	D0902783	34	S1102767	±18VDC	
Anti-Alias Chassis (ASC)	D0902783	33	S1102769	±18VDC	
		32			
Anti-Alias Chassis (ASC)	D0902783	31	S1102775	±18VDC	
Anti-Alias Chassis (ASC)	D0902783	30	S1102771	±18VDC	
		29			
Anti-Alias Chassis (ASC)	D0902783	28	S1102708	±18VDC	
Anti-Alias Chassis (ASC)	D0902783	27	S1102780	±18VDC	
		26			
4 Channel Coil Driver (Tip/Tilt REFL)	D1100687	25	S1200615	±18VDC	
4 Channel Coil Driver (Tip/Tilt REFL)	D1100687	24	S1200616	±18VDC	
		23			
4 Channel Coil Driver (Tip/Tilt OMC)	D1100687	22	S1200604	±18VDC	
4 Channel Coil Driver (Tip/Tilt OMC)	D1100687	21	S1106047	±18VDC	
		20			
4 Channel Coil Driver (Tip/Tilt OMC)	D1100687	19	S1200603	±18VDC	
Anti-Image Chassis (ASC)	D070081	18	S1102757	±18VDC	
		17			
Anti-Image Chassis (ASC)	D070081	16	S1102756	±18VDC	
		15			
		14			
l1asc0 I/O Extension Chassis	D1001715	12	S1106300	+24VDC	
		11			
		10			
Anti-Alias Chassis (LSC)	D0902783	9	S1102768	±18VDC	
Anti-Alias Chassis (LSC)	D0902783	8	S1102779	±18VDC	
		7			
Anti-Alias Chassis (LSC)	D0902783	6	S1102773	±18VDC	
Anti-Image Chassis (LSC)	D070081	5	S1102758	±18VDC	
		4			
l1lsc0 I/O Extension Chassis	D1001715	3	S1106342	+24VDC	
		2			
		1			
	Front		Rear		

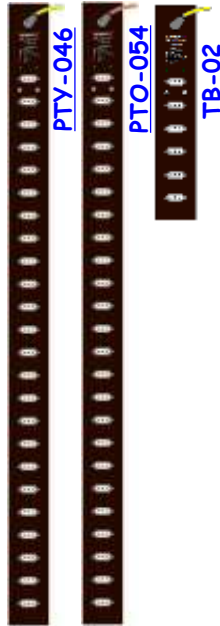

ISC-C1 is part of [D1001427](#).

IO Diagram: [D1100909](#)

Vertex ISC: [D1100170](#)



L1-ISC-C1 Details

ISC-C1 is part of [D1001427](#).

D0902783 - S1102778 (ADC0)

<< L1-ISC-C1

Anti-Alias Chassis (ASC) D0902783 S1102778 ±18VDC



[D0902783](#)
Front

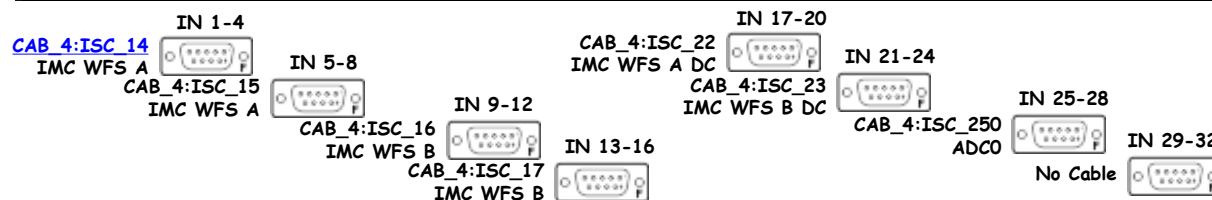

[S1102778](#)
Rear



[<< D0902783 - S1102778](#)

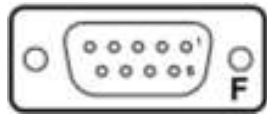

Pins

- 1
- 2
- 3
- 4
- 5
- 6
- 7
- 8
- 9

D0902783-S1102778

Other End

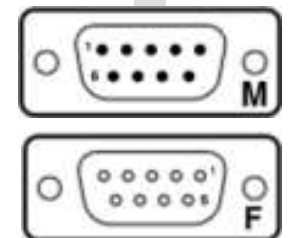

>> Thing

[<< D0902783 - S1102778](#)

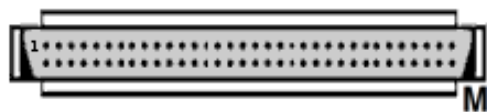

Pins

D0902783-S1102778

D1001715-S1106300

- 1
- 2
- 3
- 4
- 5
- 6
- 7
- 8
- 9
- 10
- 11
- 12
- 13
- 14

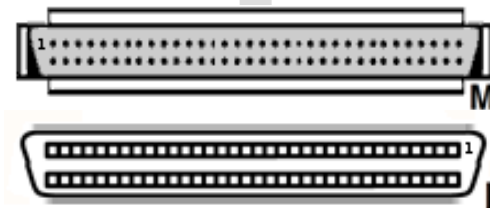

[>> D1001715 - S1106300](#)

D0902783 - S1102772 (ADC1)

<< L1-ISC-C1

Anti-Alias Chassis (ASC) D0902783 S1102772 ±18VDC

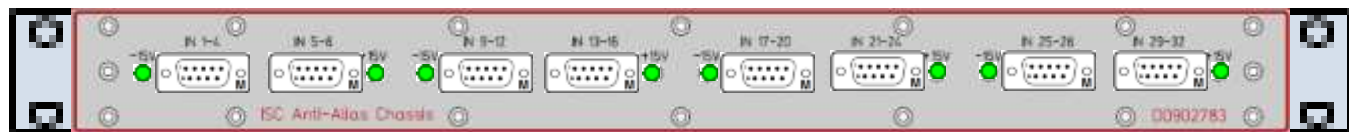

D0902783

Front

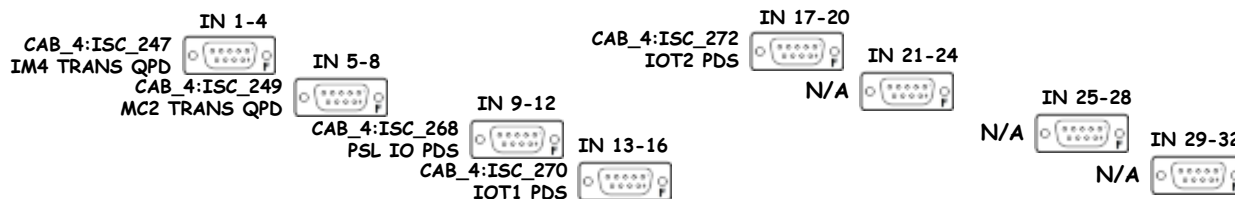

S1102772

Rear



[<< D0902783 - S1102772](#)

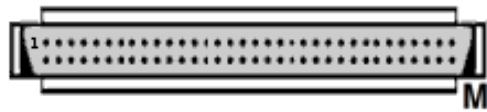

Pins

D0902783-S1102772

D1001715-S1106300

- 1
- 2
- 3
- 4
- 5
- 6
- 7
- 8
- 9
- 10
- 11
- 12
- 13
- 14

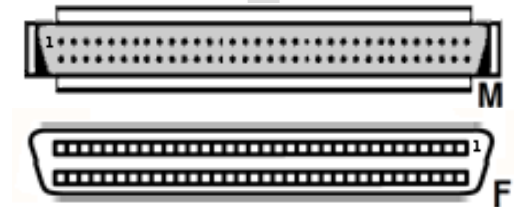

[>> D1001715 - S1106300](#)

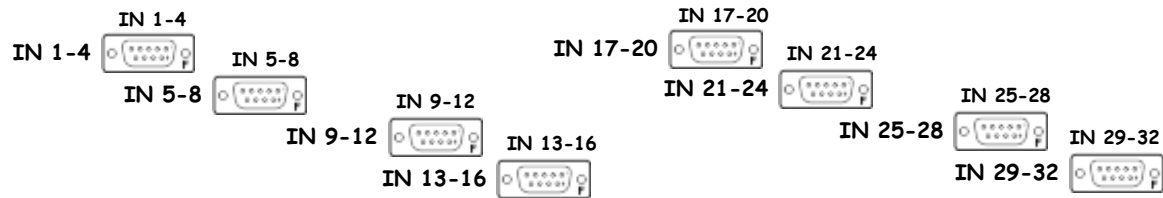
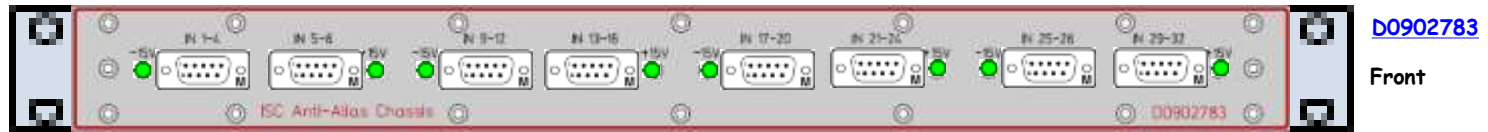

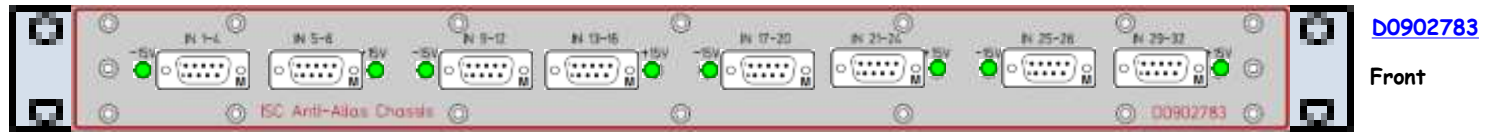

D0902783

Front

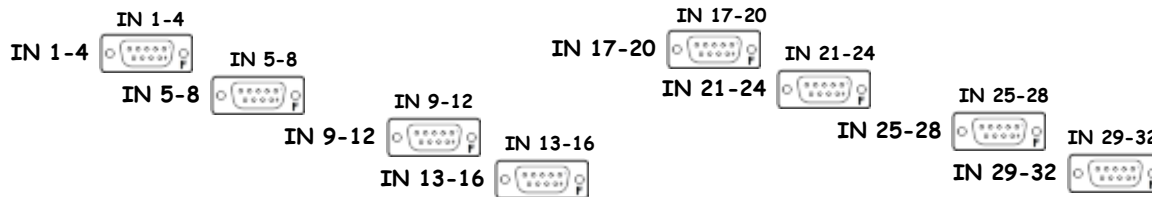

S1102769

Rear





D0902783

Front

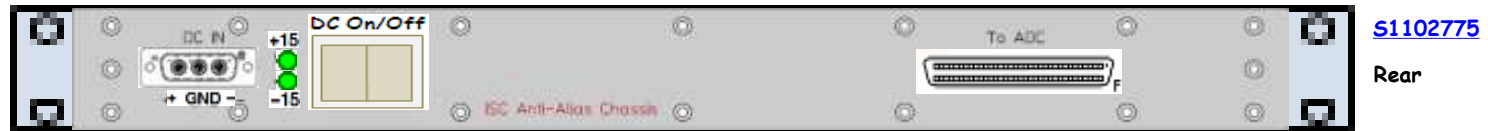
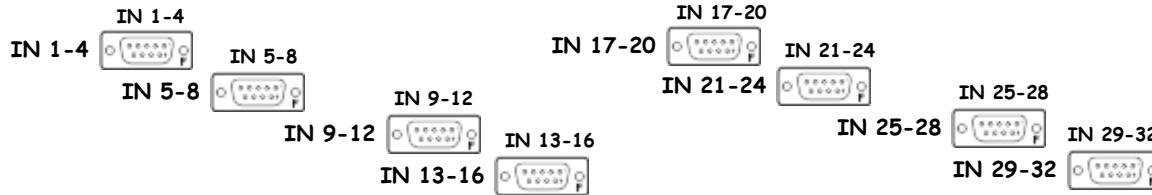

S1102775

Rear



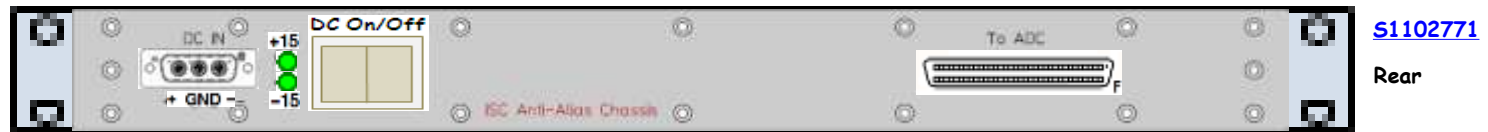
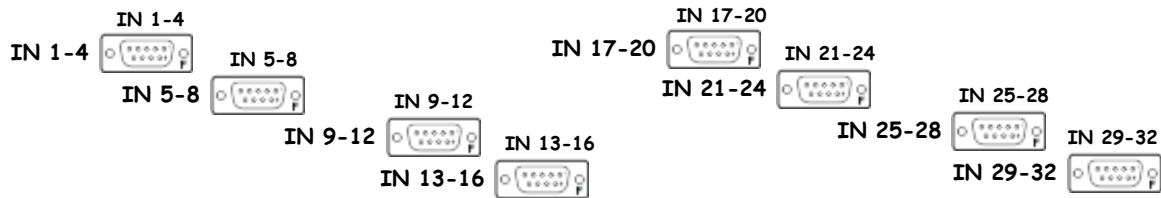
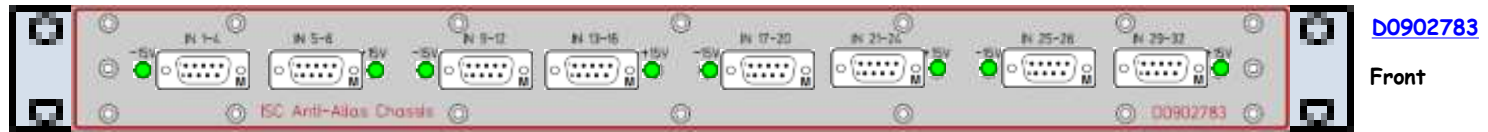

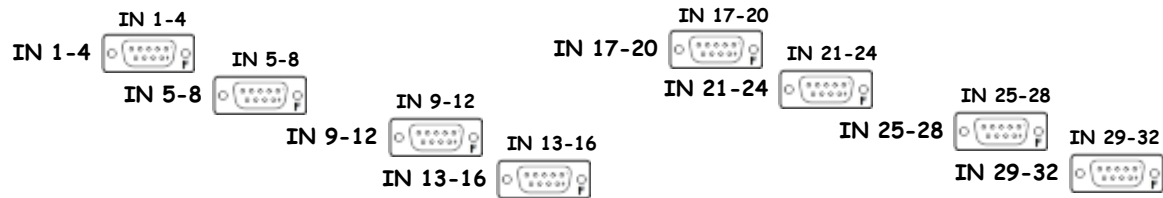
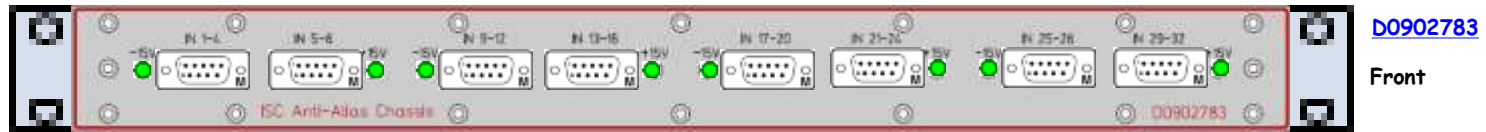



D0902783

Front

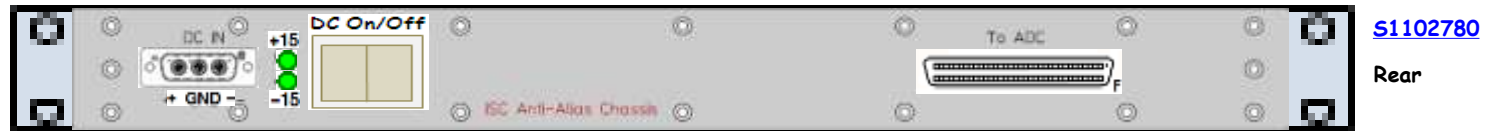
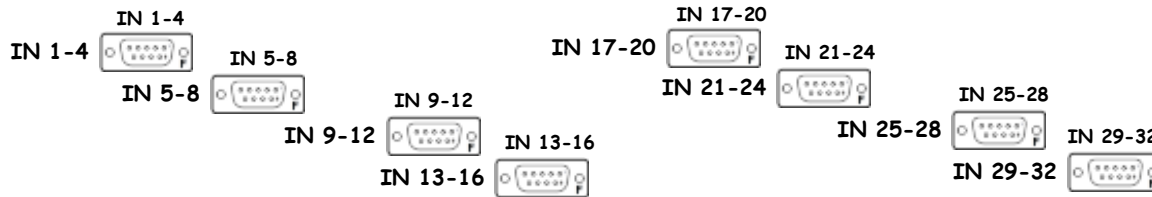

S1102780

Rear



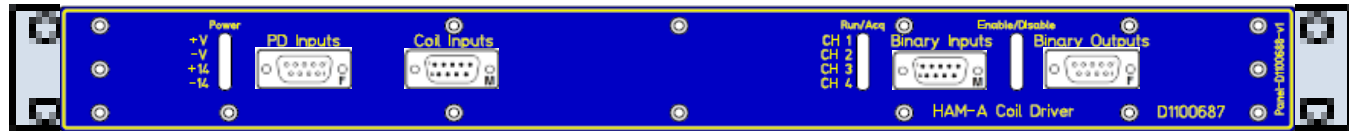

D1100687

Front



S1200615

Rear

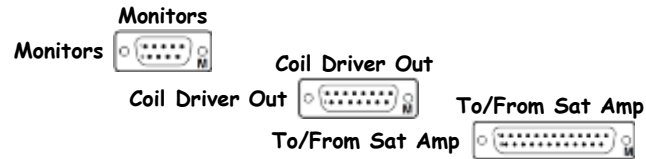

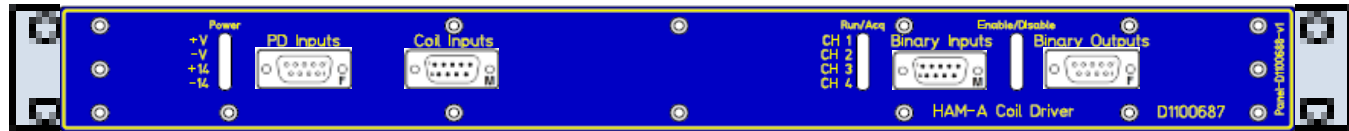

D1100687

Front



S1200616

Rear

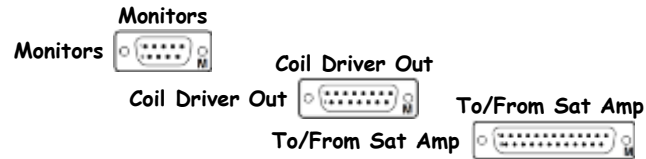

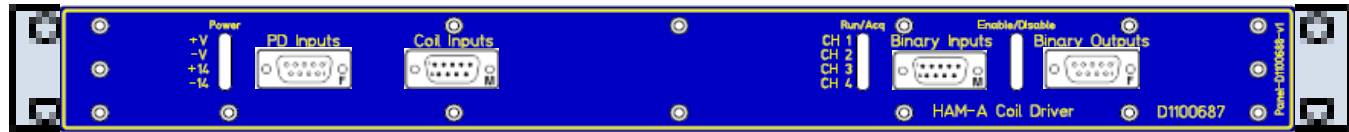

D1100687

Front



S1106047

Rear

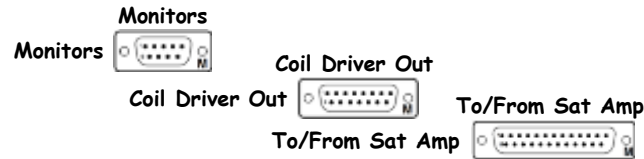

4 Channel Coil Driver (Tip/Tilt OMC) D1100687 S1200604 : ±18VDC

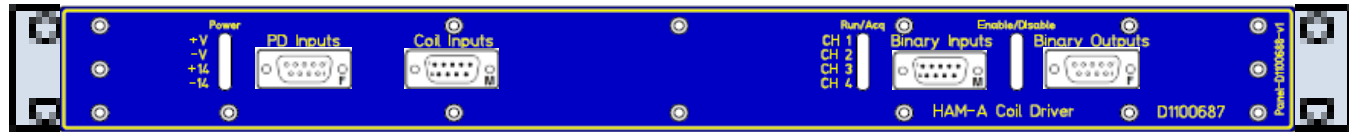

D1100687

Front



S1200604

Rear

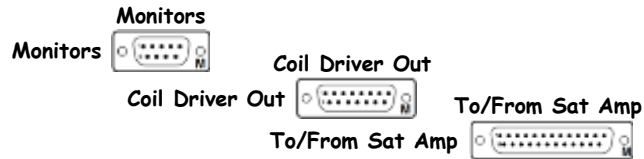

4 Channel Coil Driver (Tip/Tilt OMC) D1100687 S1200603 ±18VDC

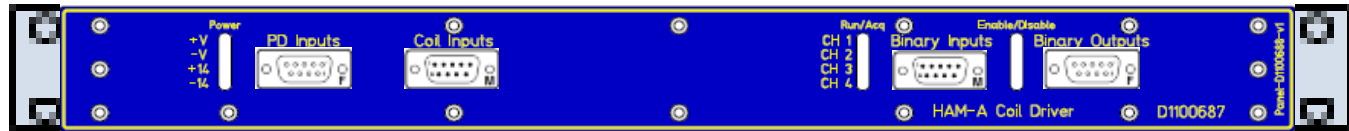

D1100687

Front



S1200603

Rear

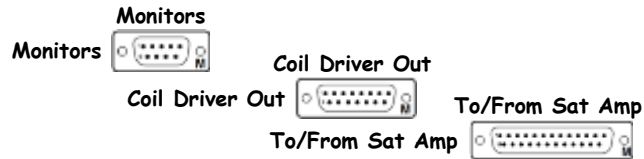

Anti-Image Chassis (ASC) D070081 S1102757 ±18VDC

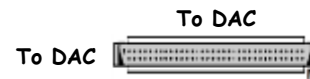
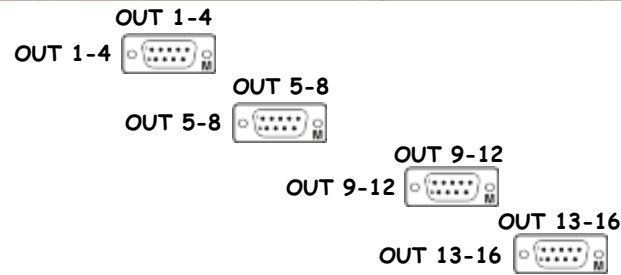
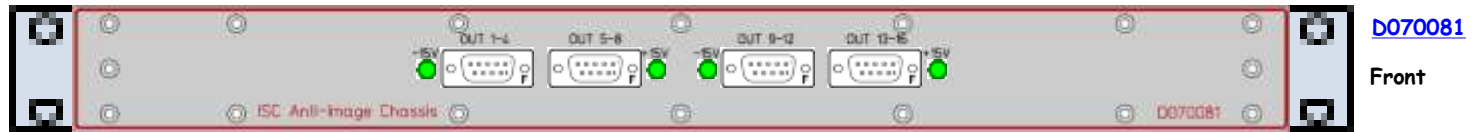

Anti-Image Chassis (ASC) D070081 S1102756 ±18VDC

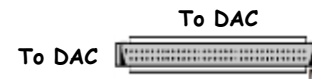
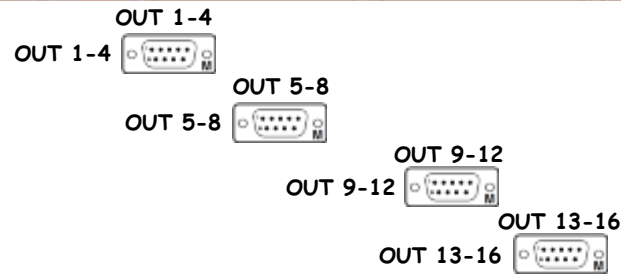
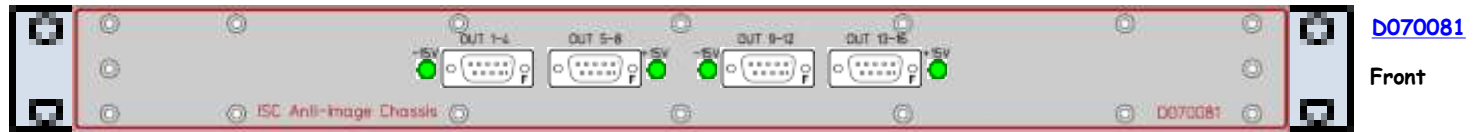

l1asc0 I/O Extension Chassis

D1001715

S1106300

+24VDC

D1001715

Front

Timing Link

l1asc0 – I/O Extender

S1106300

Rear

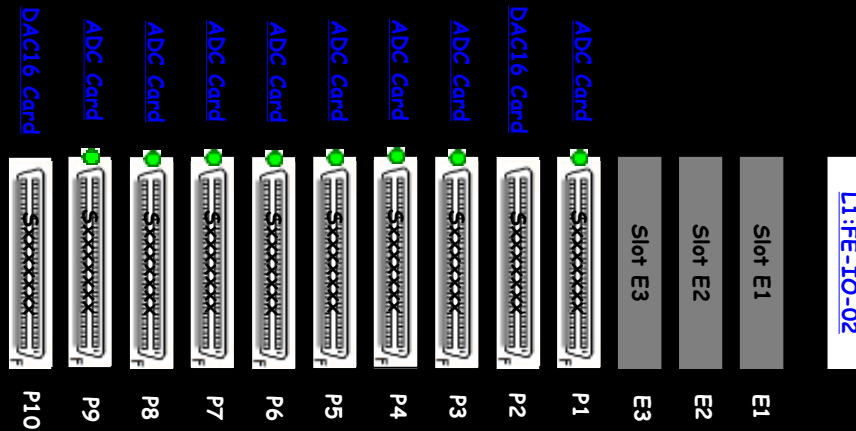
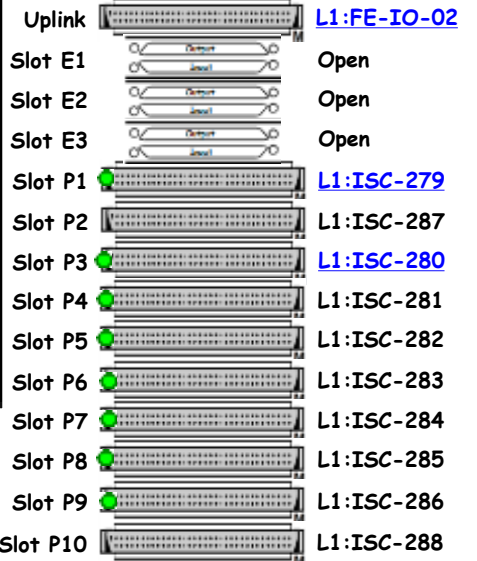

TB-02

L1:FE-IO-02



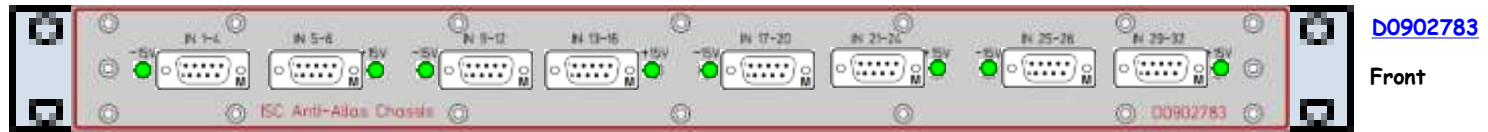

D0902783

Front

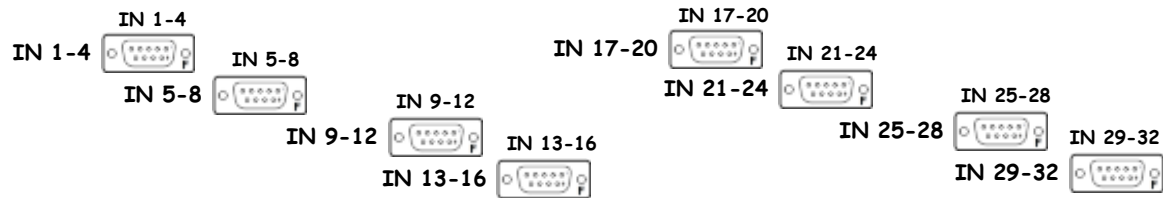

S1102768

Rear



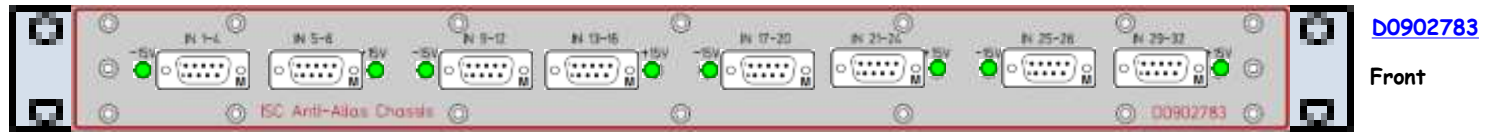

[D0902783](#)

Front

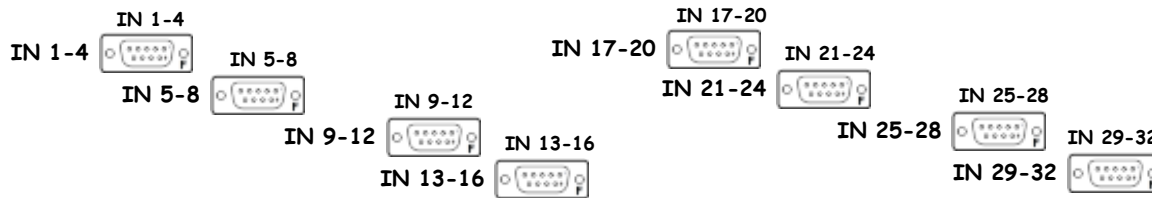

[S1102779](#)

Rear





D0902783

Front

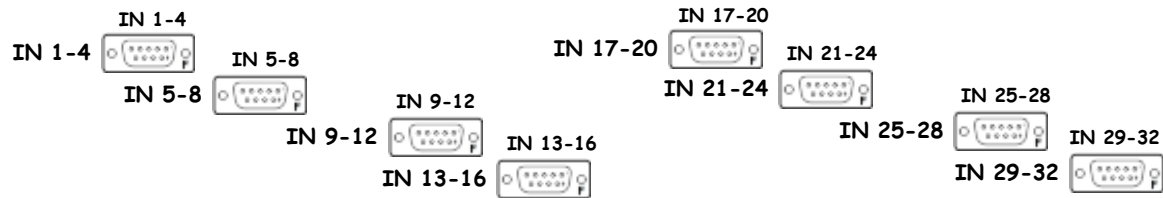

S1102773

Rear



Anti-Image Chassis (LSC) D070081 S1102758 ±18VDC

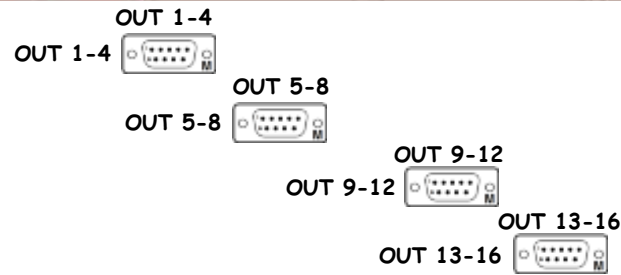
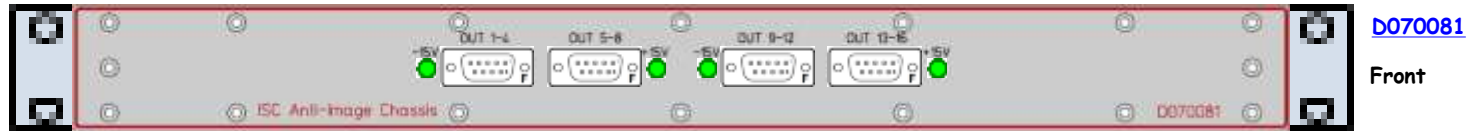

<< L1-ISC-C1

I1isc0 I/O Extension Chassis

D1001715

S1106342

+24VDC

D1001715

Front

Timing Link

I1isc0 – I/O Extender

S1106342

Rear

Uplink  L1:FE-IO-01

Slot E1  Open

Slot E2  Open

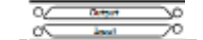
Slot E3  Open

Slot P1  L1:ISC-276

Slot P2  L1:ISC-278

Slot P3  L1:ISC-277

Slot P4  Unlabeled

Slot P5  Open

Slot P6  Open

Slot P7  Open

Slot P8  Open

Slot P9  Open

Slot P10  Open

TB-02

L1:FE-IO-01

Slot P10 P10

Slot P9 P9

Slot P8 P8

Slot P7 P7

Slot P6 P6

Slot P5 P5

Slot P4 P4

Slot P3 P3

Slot P2 P2

Slot P1 P1

Slot E3 E3

Slot E2 E2

Slot E1 E1

ADC Card

ADC Card

DAC16 Card

ADC Card

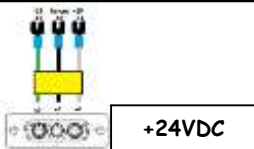

+24VDC

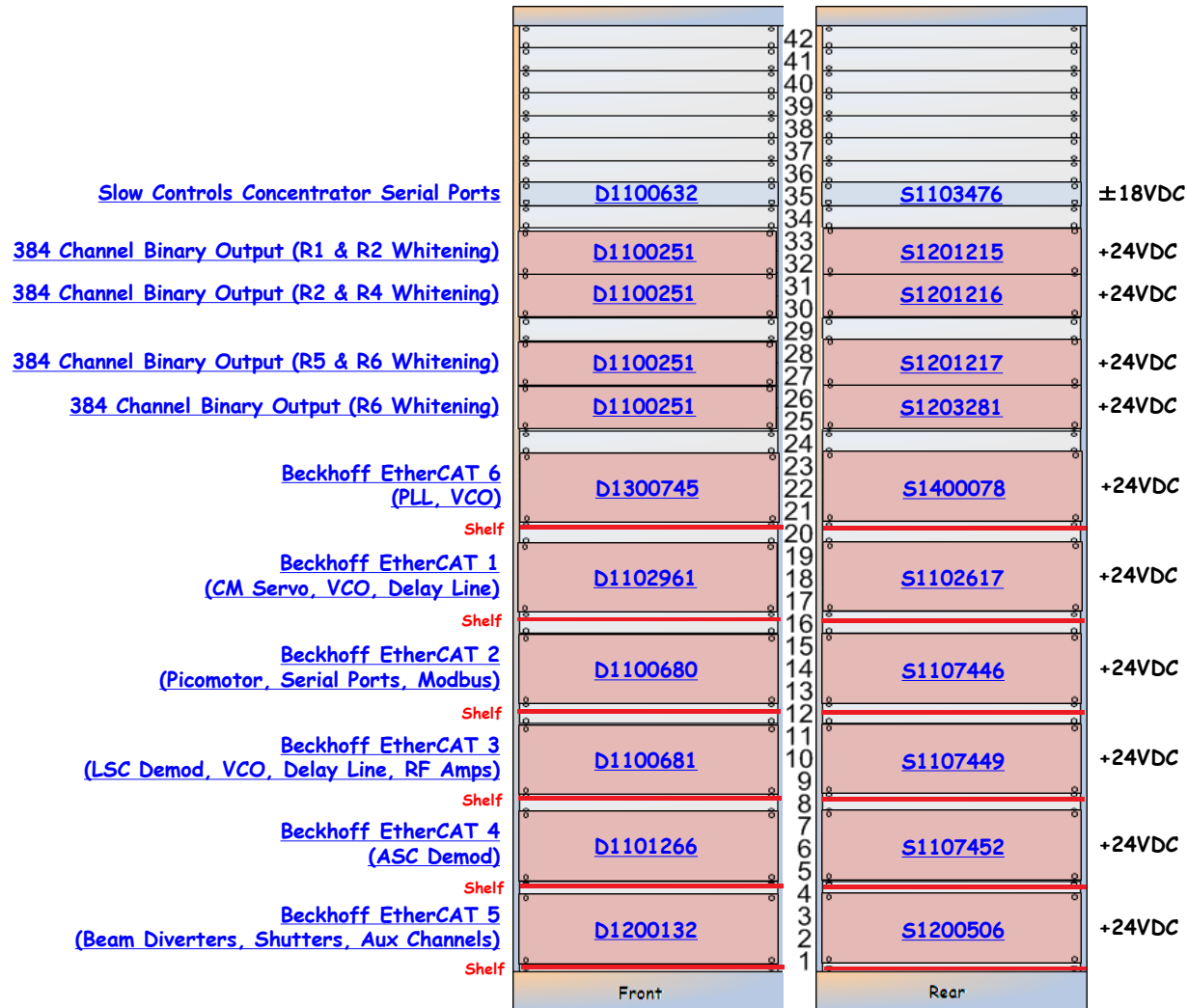

ISC-C2 is part of [D1001427](#).
 ISC-C2 is part of [D1100170](#).

ISC C2 LIGO-D1001427-v17

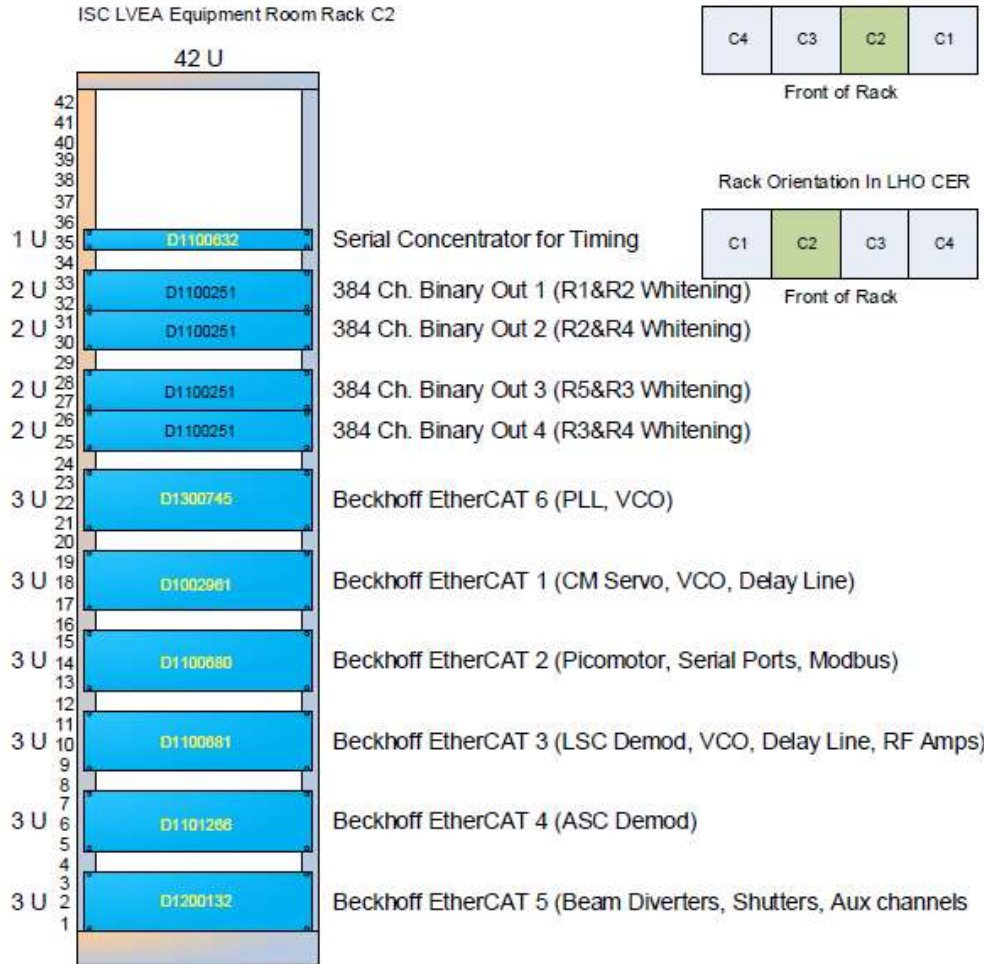

(D1001427)

Rack Orientation In LLO CER

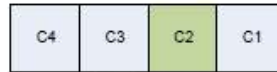

Rack Orientation In LHO CER

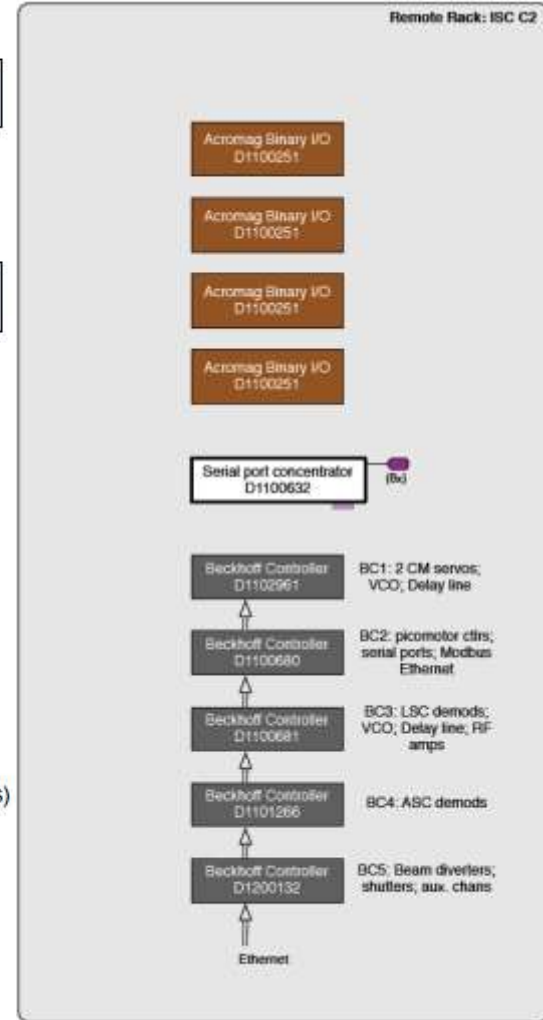
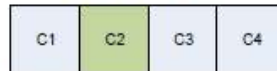

(D1100170)

L1-ISC-C2 Details

ISC-C2 is part of [D1001427](#).

ISC-C2 is part of [D1100170](#).



D1100632

Front

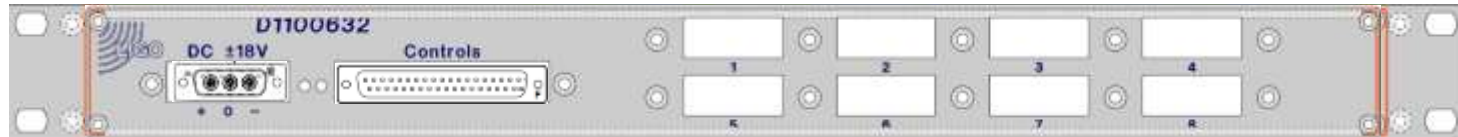

S1103476

Rear



384 Channel Binary Output (R1 & R2 Whitening)

D1100251

S1201215

+24VDC

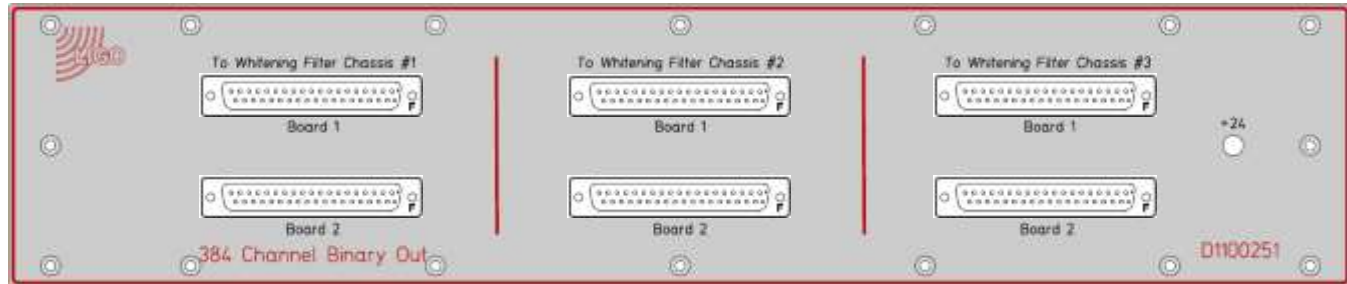

D1100251

Front

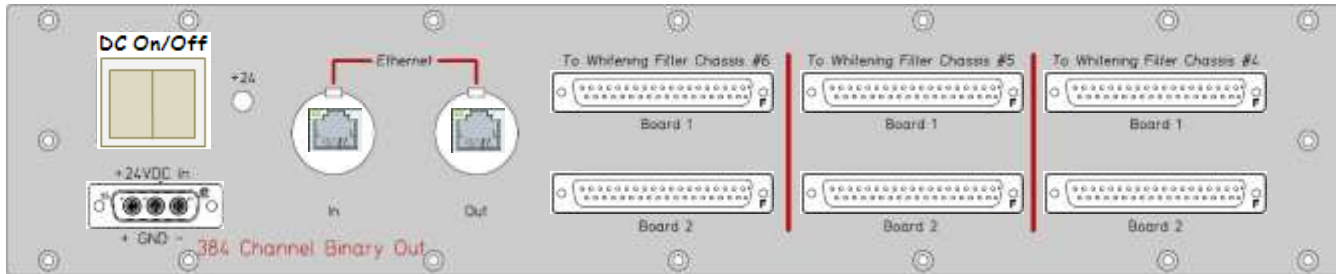
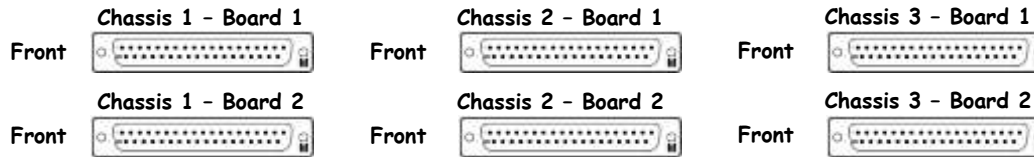

S1201215

Rear

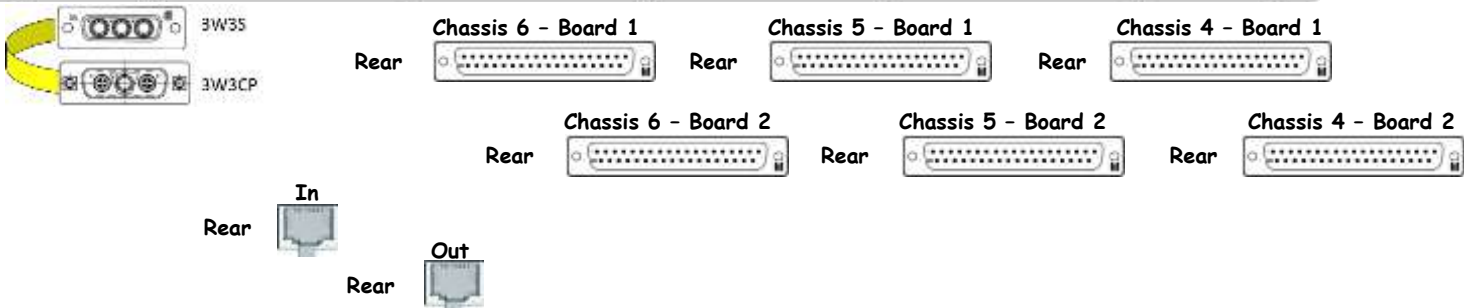

384 Channel Binary Output (R2 & R4 Whitening)

D1100251

S1201216

+24VDC

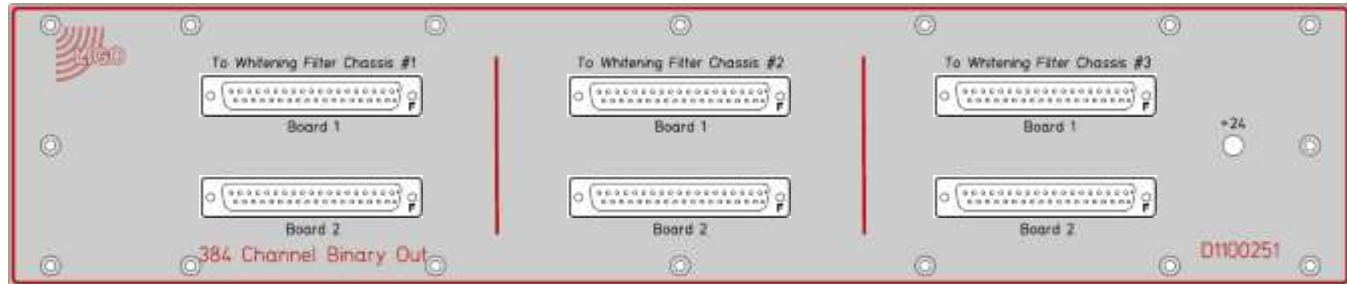

D1100251

Front

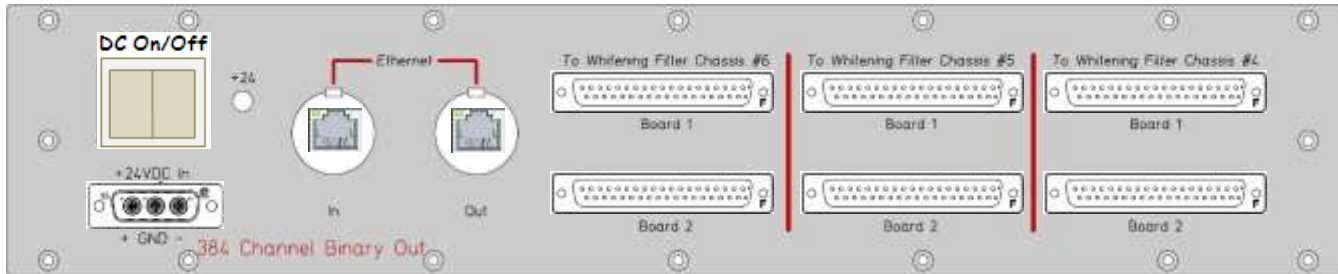
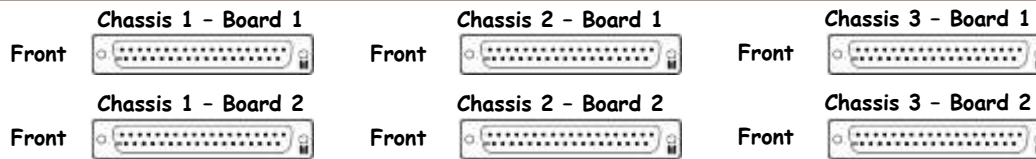

S1201216

Rear

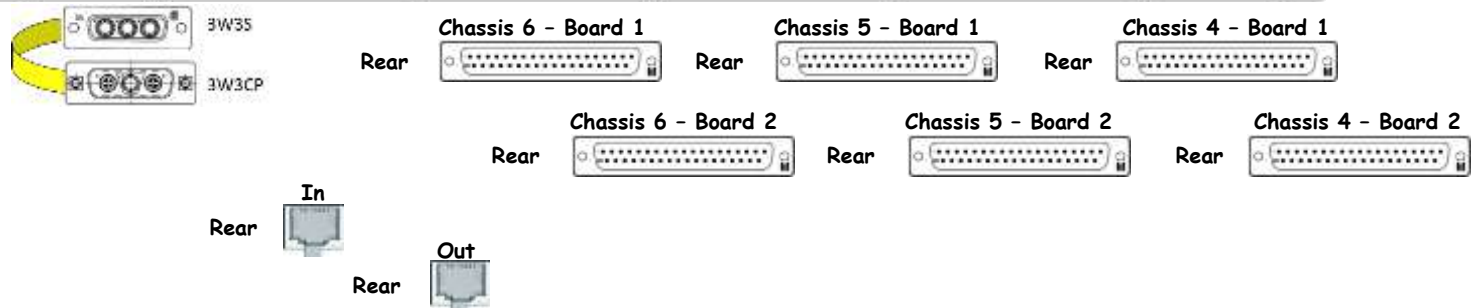

384 Channel Binary Output (R5 & R6 Whitening)

D1100251

S1201217

+24VDC

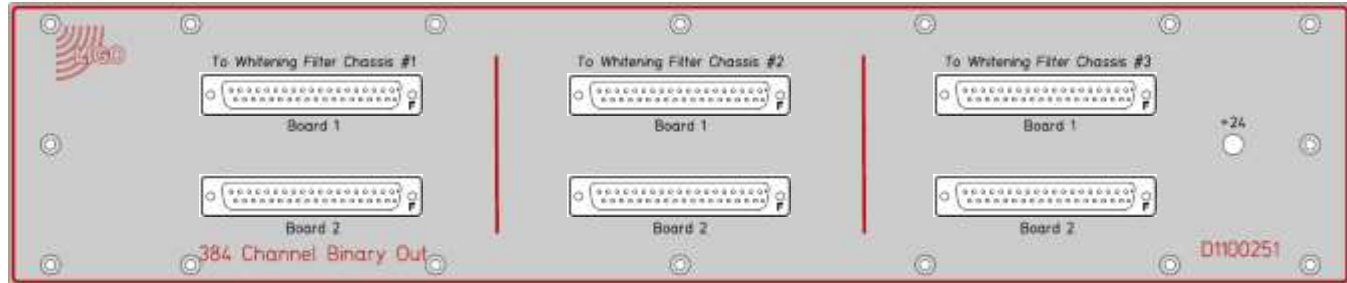

D1100251

Front

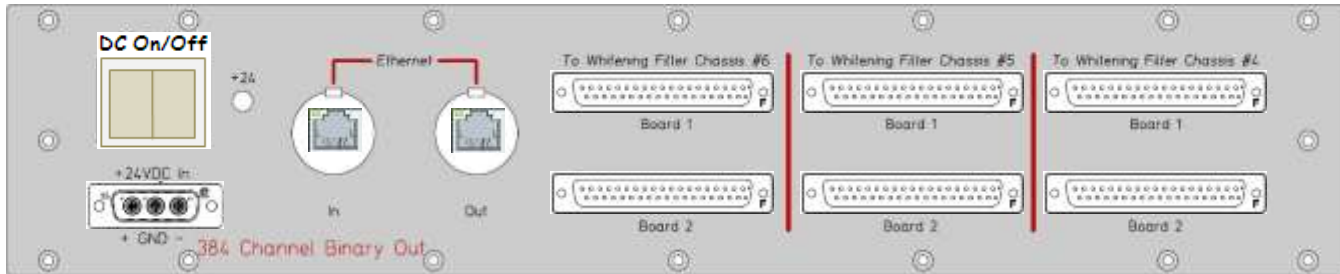
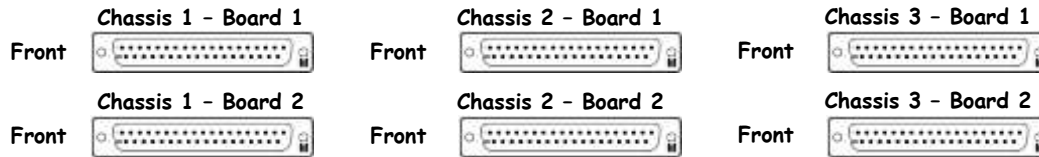

S1201217

Rear

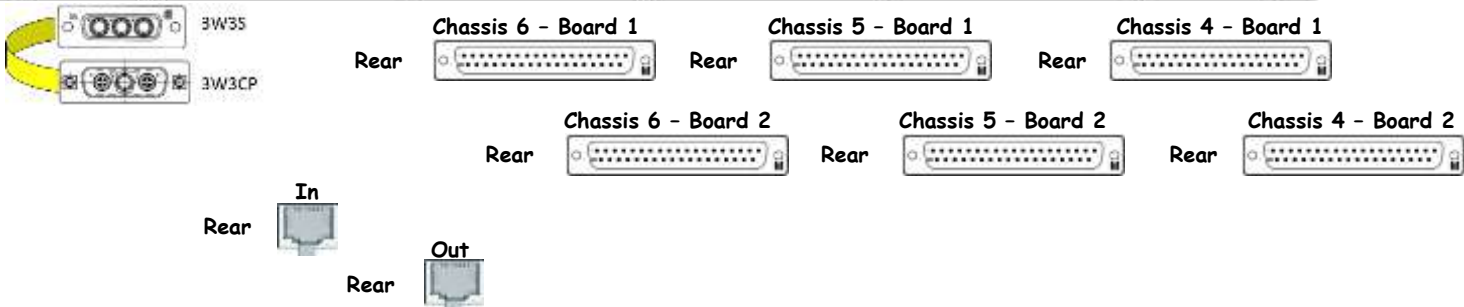

384 Channel Binary Output (R6 Whitening)

D1100251

S1203281

+24VDC

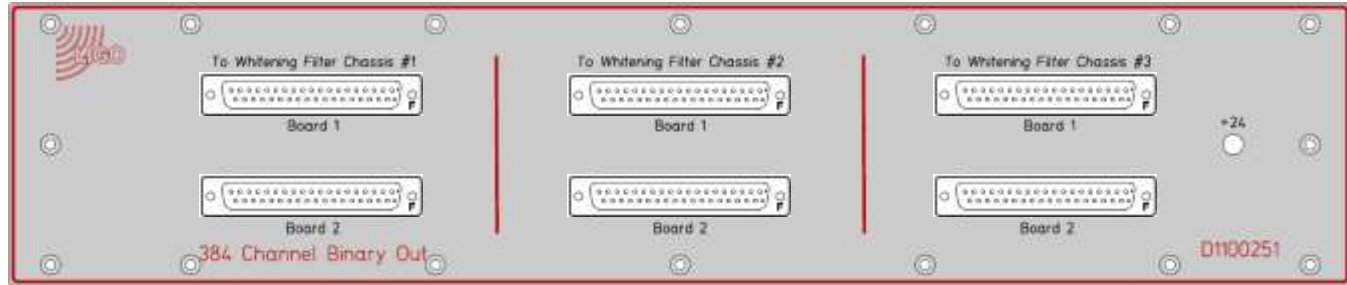

D1100251

Front

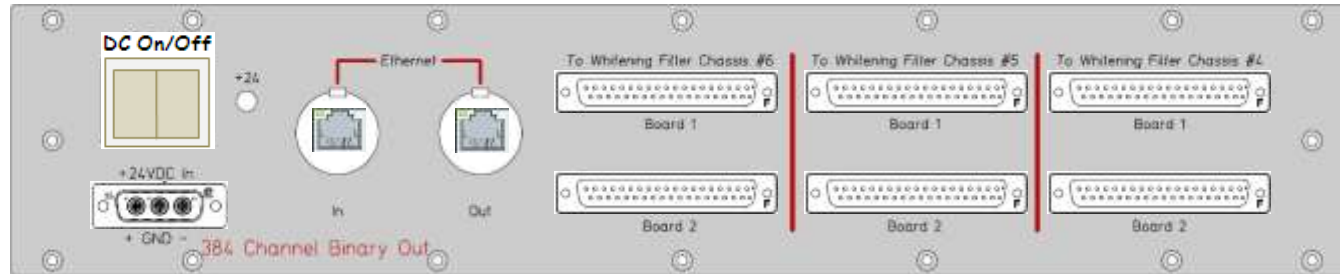
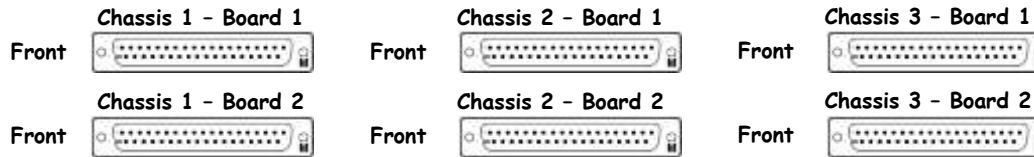

S1203281

Rear

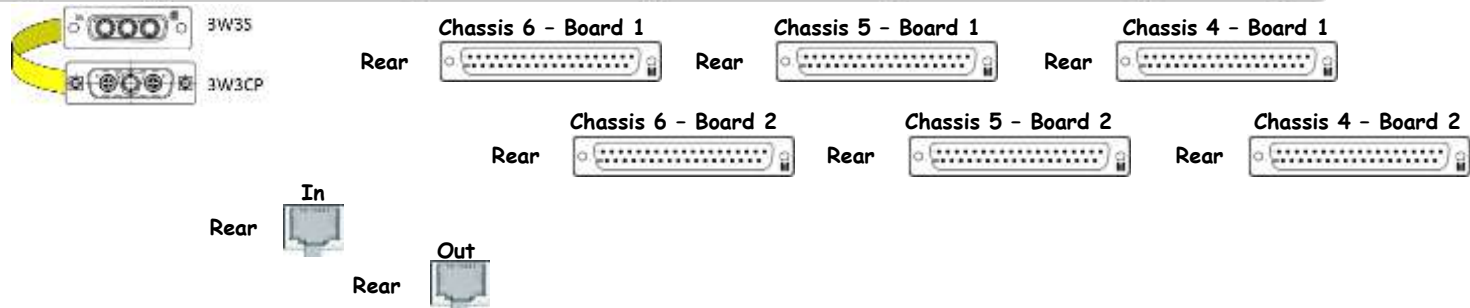

<< [L1-ISC-C2](#)

Beckhoff EtherCAT 1
(CM Servo, VCO, Delay Line)

[D1102961](#)

[S1102617](#)

Power

[D1102961](#)

Front

[S1102617](#)

Rear

DC On/Off

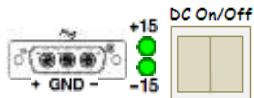

From DAC Adapter

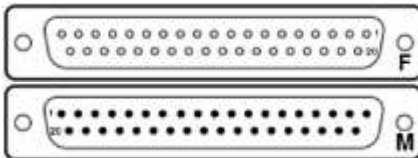

<< [L1-ISC-C2](#)

Beckhoff EtherCAT 2
(Picomotor, Serial Ports, Modbus)

[D1100680](#)

[S1107446](#)

Power

[D1100680](#)

Front

[S1107446](#)

Rear

DC On/Off

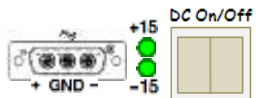

From DAC Adapter

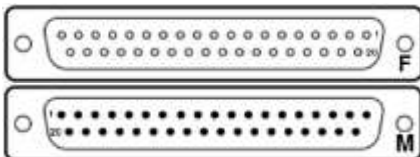

<< [L1-ISC-C2](#)

Beckhoff EtherCAT 3
(LSC Demod, VCO, Delay Line, RF Amps)

[D1100681](#)

[S1107449](#)

Power

[D1100681](#)

Front

[S1107449](#)

Rear

DC On/Off

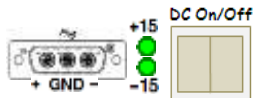

From DAC Adapter

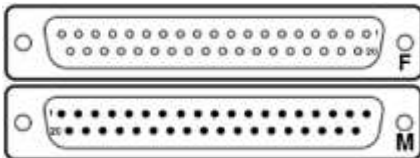

<< [L1-ISC-C2](#)

Beckhoff EtherCAT 4
(ASC Demod)

[D1101266](#)

[S1107452](#)

Power

[D1101266](#)

Front

[S1107452](#)

Rear

DC On/Off

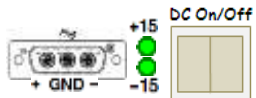

From DAC Adapter

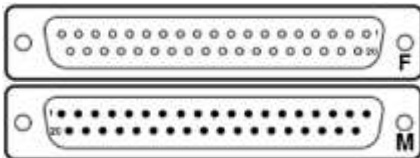

[<< L1-ISC-C2](#)

Beckhoff EtherCAT 5
(Beam Diverters, Shutters, Aux Channels)

[D1200132](#)

[S1200506](#)

Power

[D1200132](#)

Front

[S1200506](#)

Rear

DC On/Off

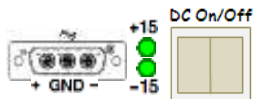

From DAC Adapter

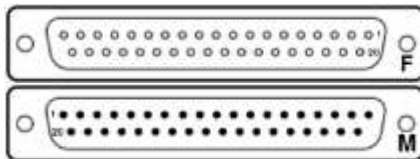

<< [L1-ISC-C2](#)

Beckhoff EtherCAT 6
(PLL, VCO)

[D1300745](#)

[S1400078](#)

Power

[D1300745](#)

Front

[S1400078](#)

Rear

DC On/Off

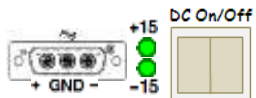

From DAC Adapter

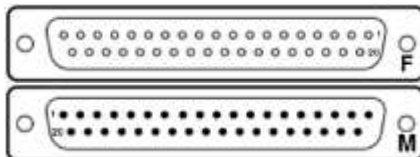

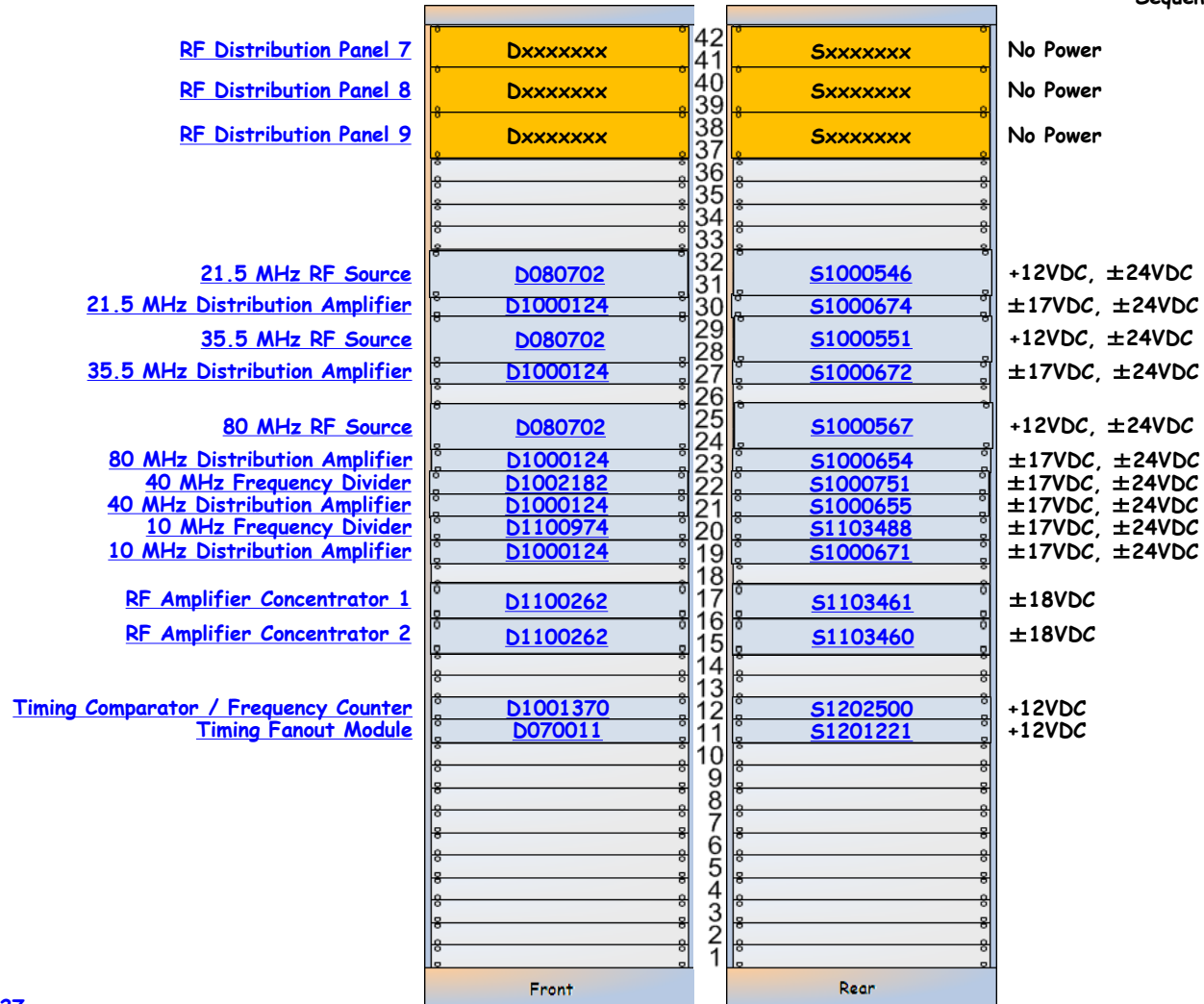

ISC-C3 is part of [D1001427](#).

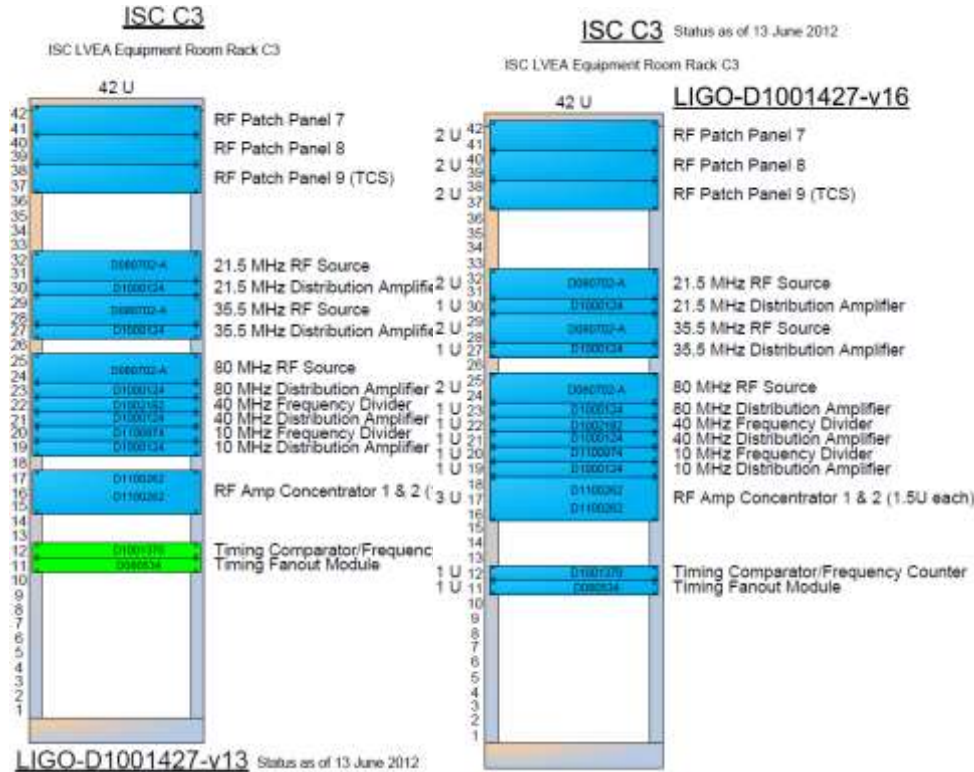

([D1001427](#))

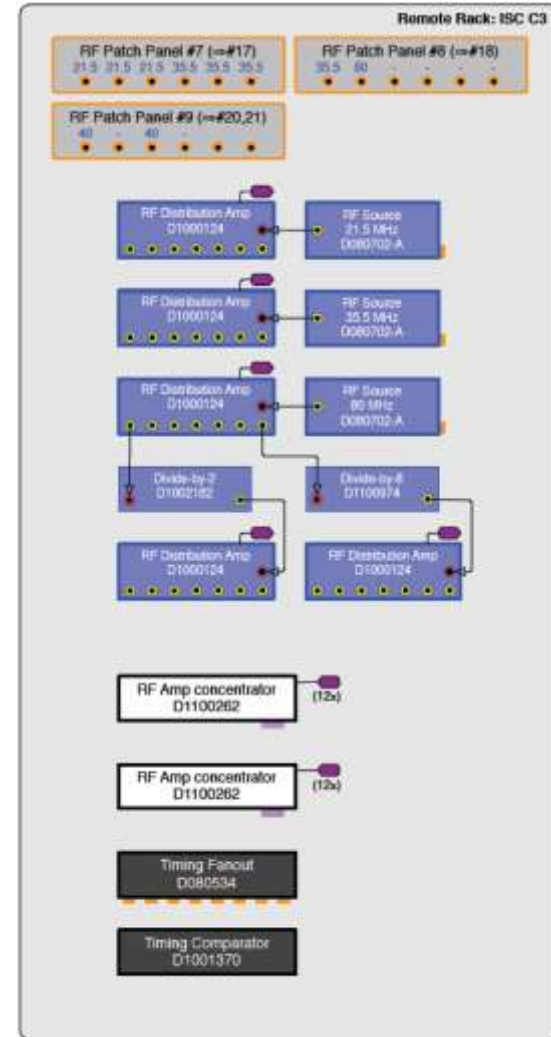

([D1100170](#))

L1-ISC-C3 Details

ISC-C3 is part of [D1001427](#).

RF Distribution Panel 7

<< [L1-ISC-C3](#)

RF Distribution Panel 7

Dxxxxxxx

Sxxxxxxx

No Power

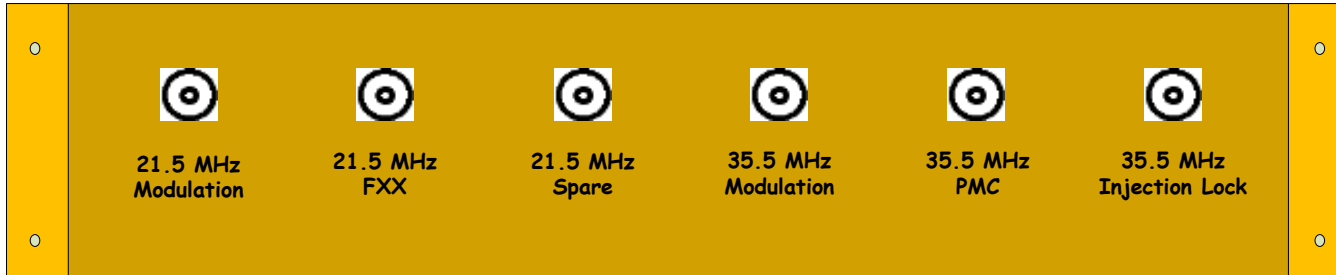

Dxxxxxxx

Front

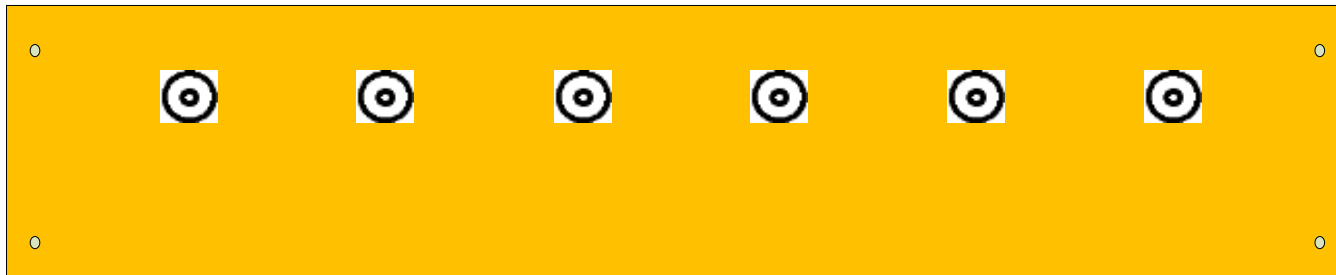

Sxxxxxxx

Rear

RF Distribution Panel 8

<< [L1-ISC-C3](#)

RF Distribution Panel 8

Dxxxxxxx

Sxxxxxxx

No Power

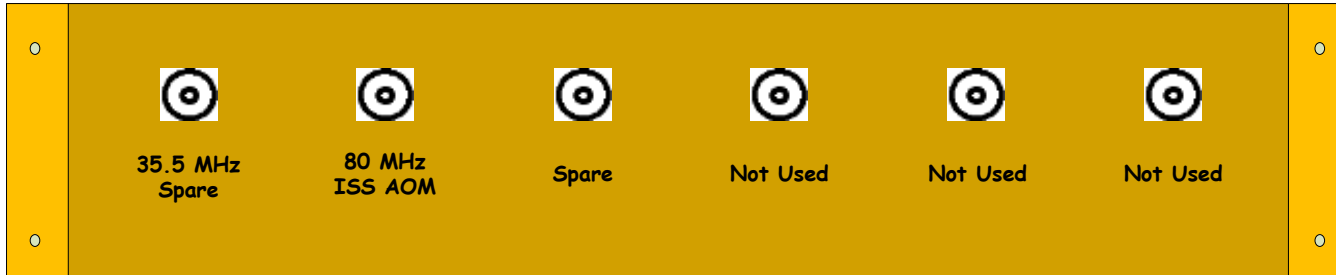

Dxxxxxxx

Front

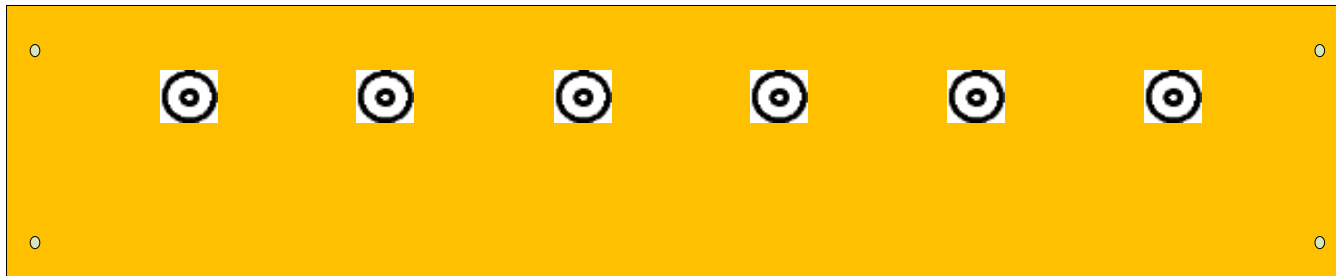

Sxxxxxxx

Rear

RF Distribution Panel 9

<< [L1-ISC-C3](#)

RF Distribution Panel 9

Dxxxxxxx

Sxxxxxxx

No Power

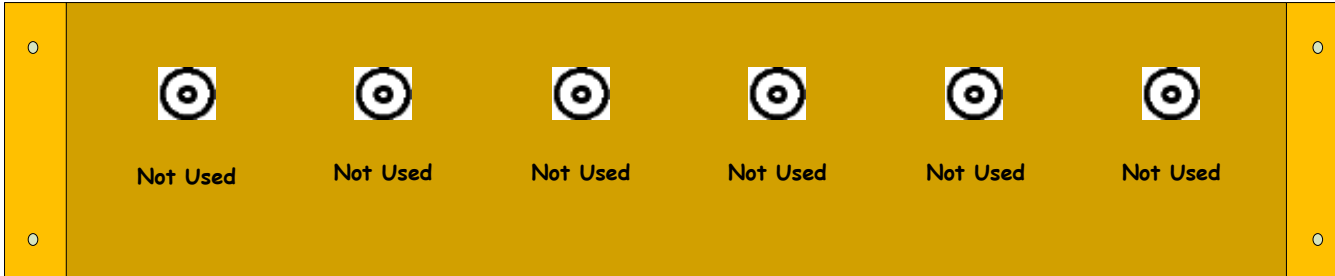

Dxxxxxxx

Front

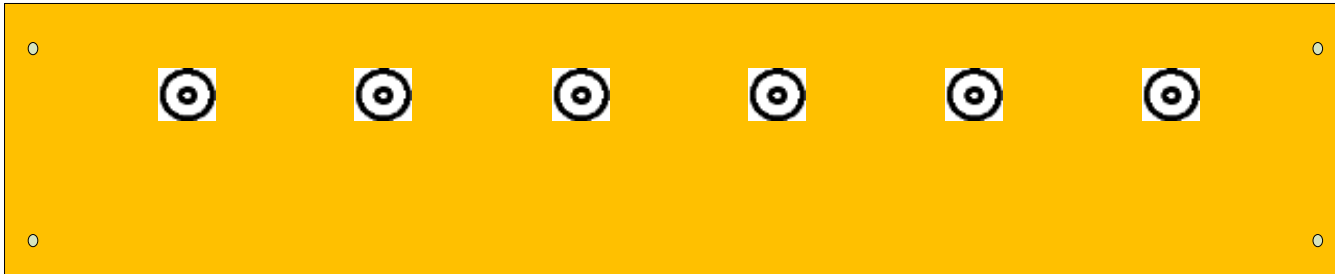

Sxxxxxxx

Rear

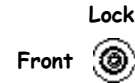
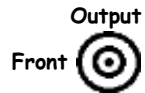
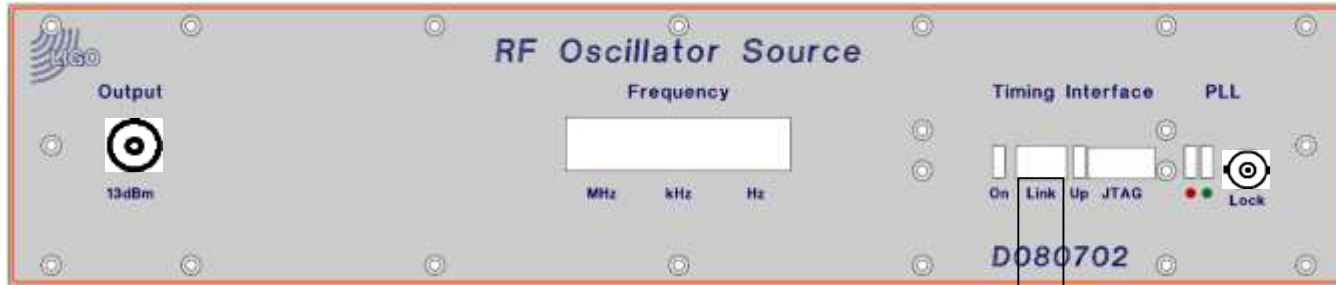

To ...

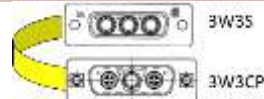

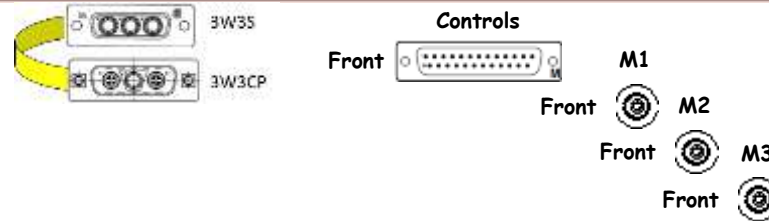
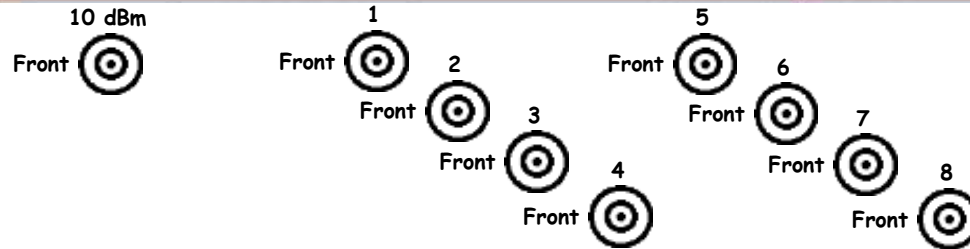
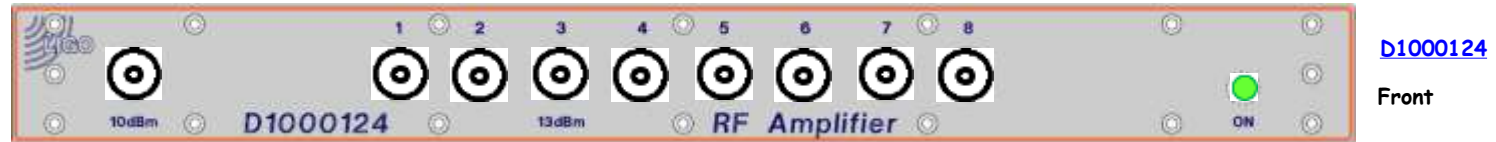

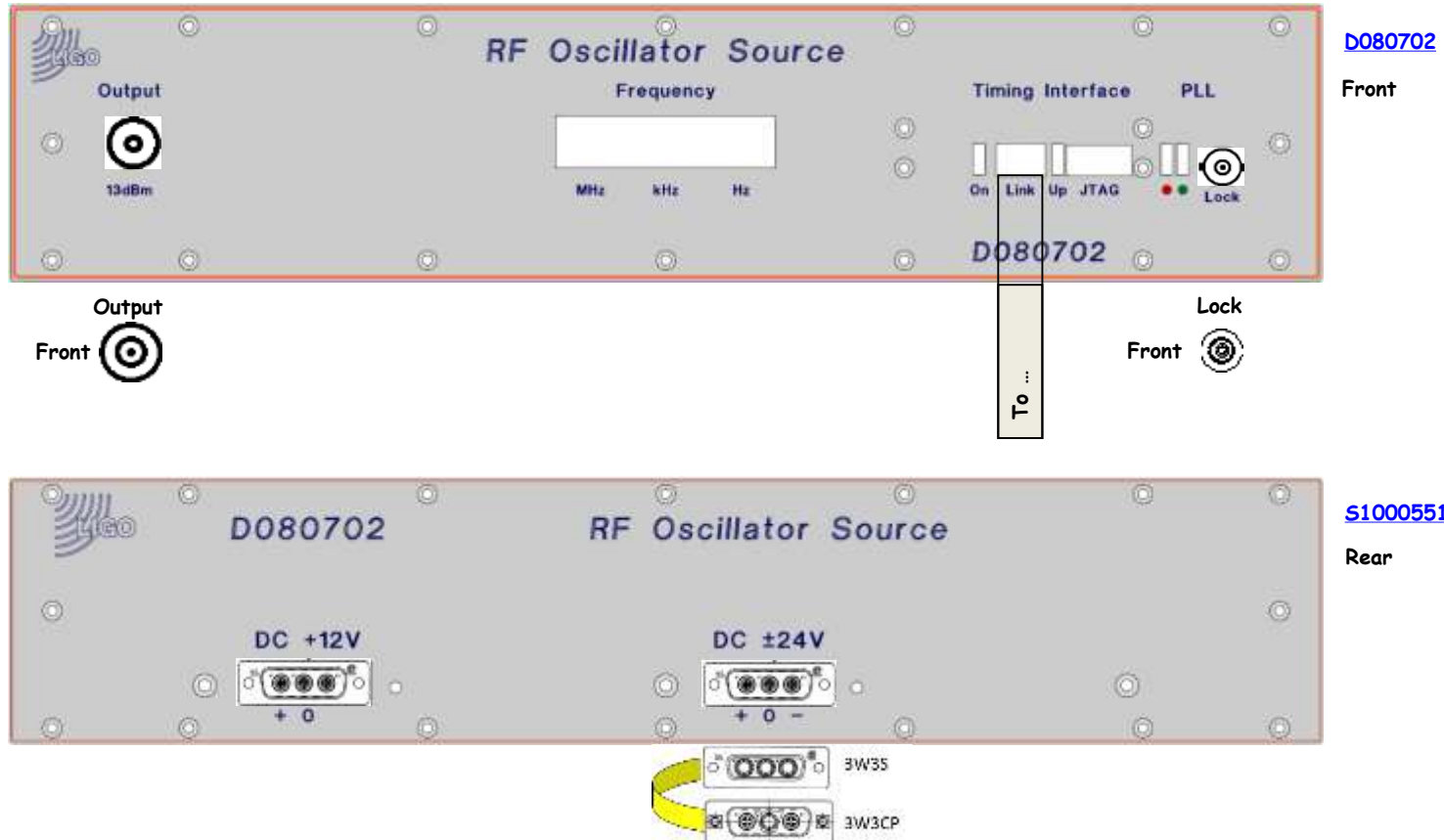

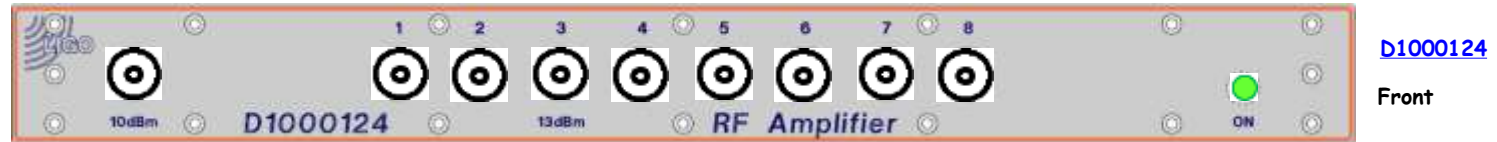

D1000124

Front

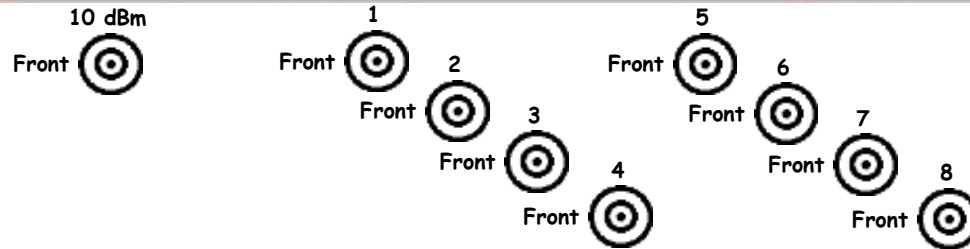

S1000672

Rear

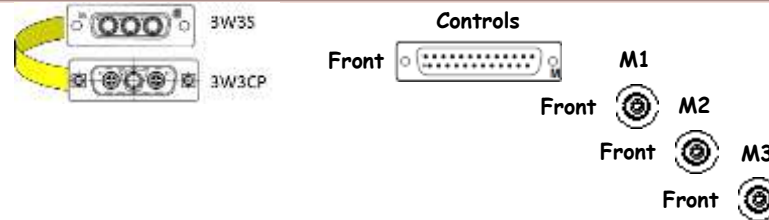

D080702 - Sxxxxxxxx

<< [L1-ISC-3](#)

80 MHz RF Source

[D080702](#)

[Sxxxxxxxx](#)

+12VDC, ±24VDC

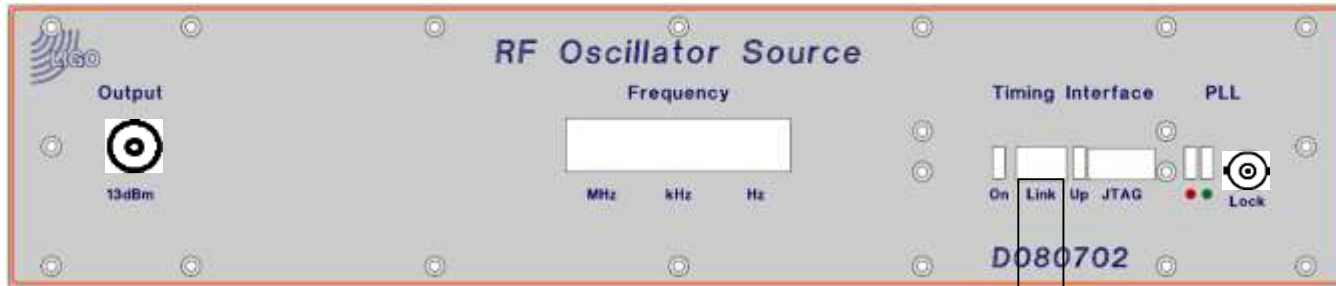

[D080702](#)

Front

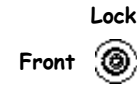
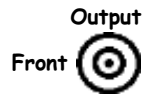

To ...



[S1000551](#)

Rear

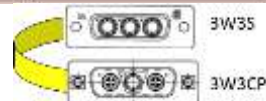

D1000124 - Sxxxxxxx

<< L1-ISC-C3

80 MHz Distribution Amplifier

D1000124

Sxxxxxxx

±17VDC, ±24VDC



D1000124

Front

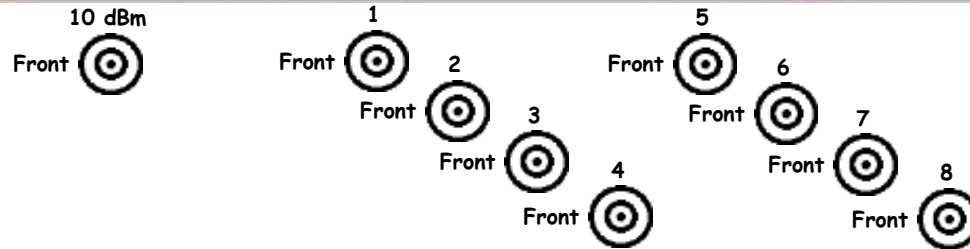

Sxxxxxxx

Rear

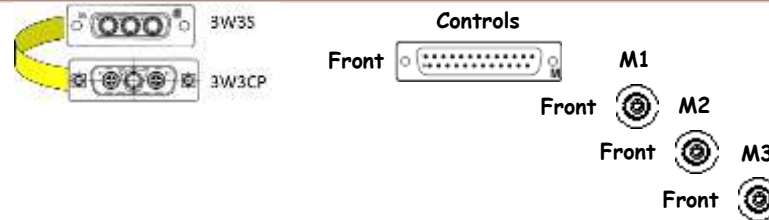

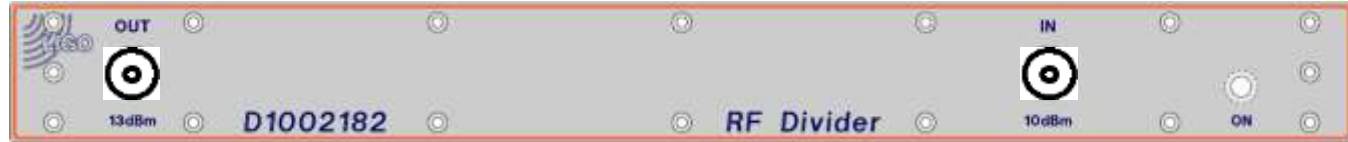

D1002182

Front



S1000650

Rear

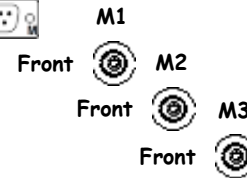
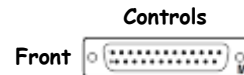
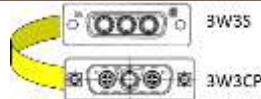

D1000124 - Sxxxxxxx

<< L1-ISC-C3

40 MHz Distribution Amplifier D1000124 Sxxxxxxx ±17VDC, ±24VDC

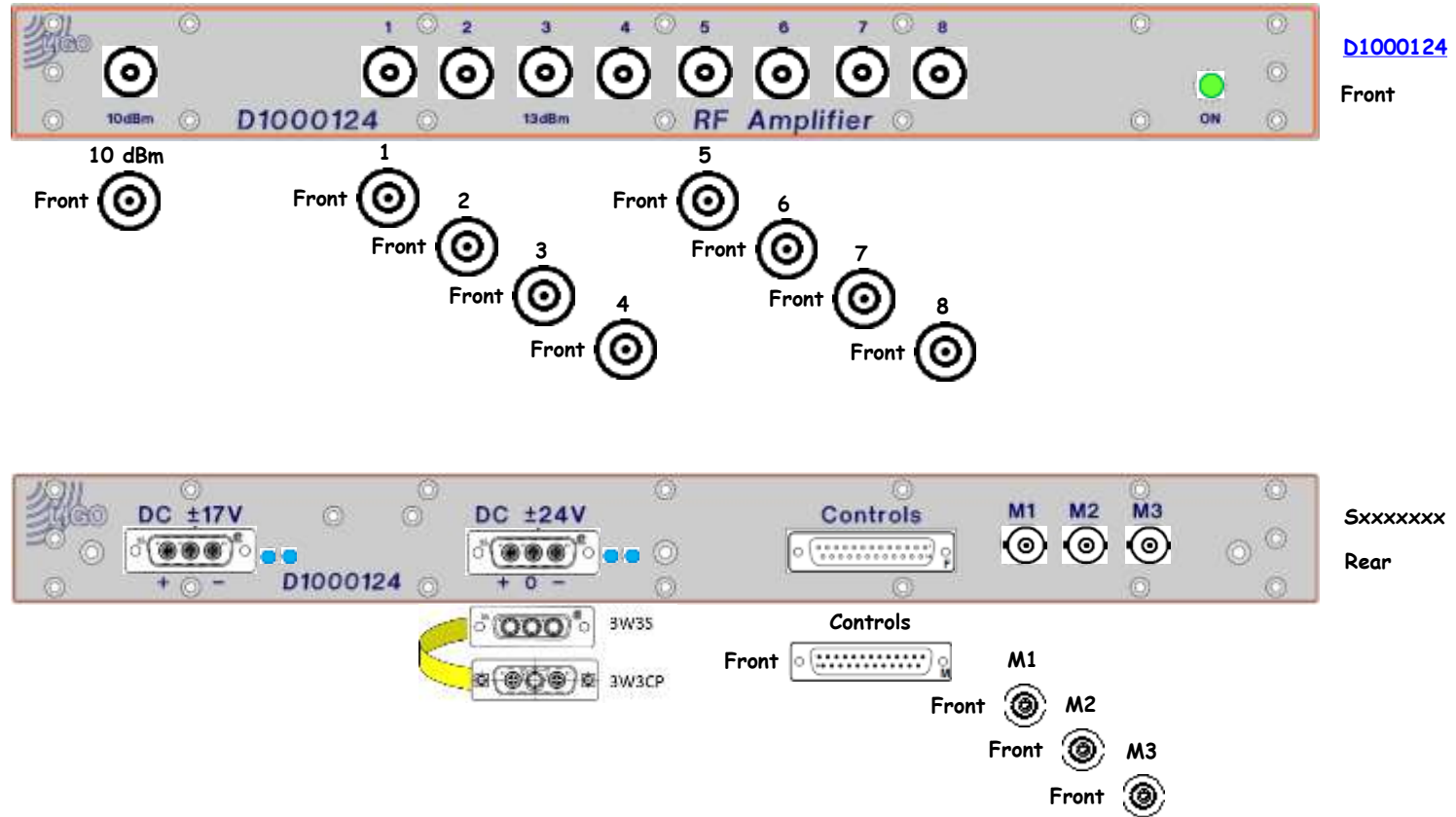

D1100974 - Sxxxxxxx

<< L1-ISC-C3

10 MHz Frequency Divider ±17VDC, ±24VDC



D1100974

Front

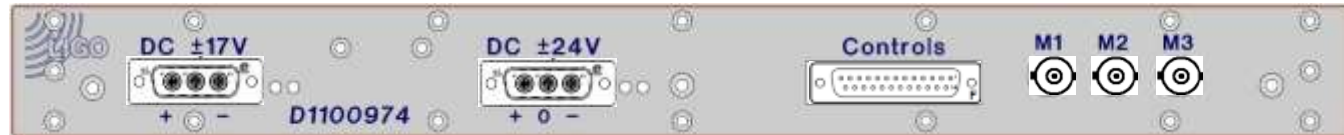

S1000650

Rear

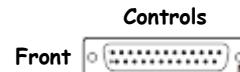
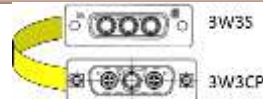

D1000124 - Sxxxxxxx

<< L1-ISC-C3

10 MHz Distribution Amplifier

D1000124

Sxxxxxxx

±17VDC, ±24VDC



D1000124

Front

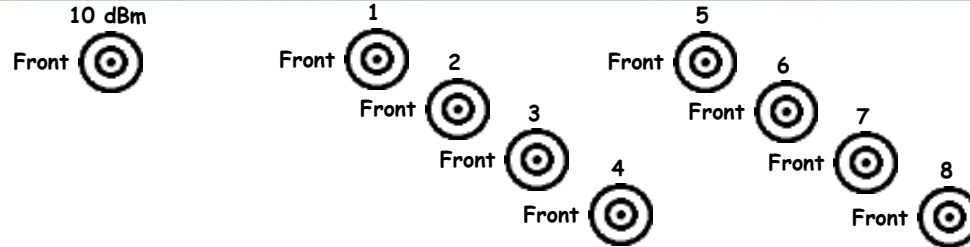

Sxxxxxxx

Rear

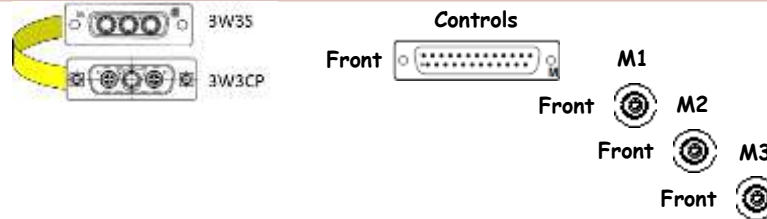

D1100262 - Sxxxxxxx

<< L1-ISC-C3

RF Amplifier Concentrator 1 D1100262 SN: ±18VDC



[D1100262](#)

Front

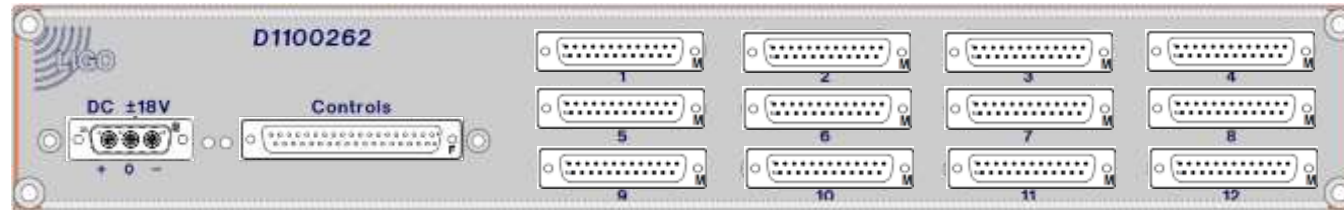

[S1001232](#)

Rear

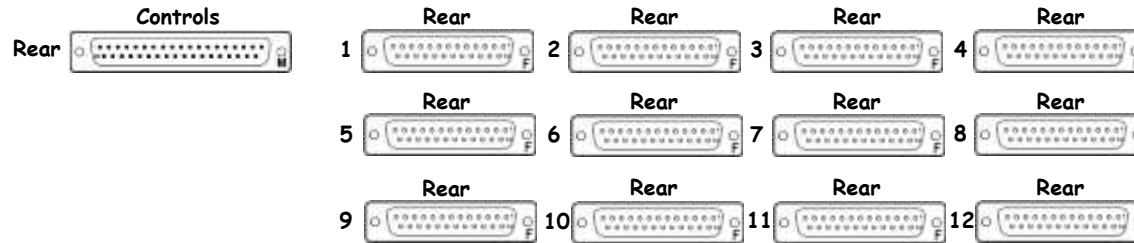

D1100262 - Sxxxxxxx

<< L1-ISC-C3

RF Amplifier Concentrator 2 D1100262 SN: ±18VDC



[D1100262](#)

Front

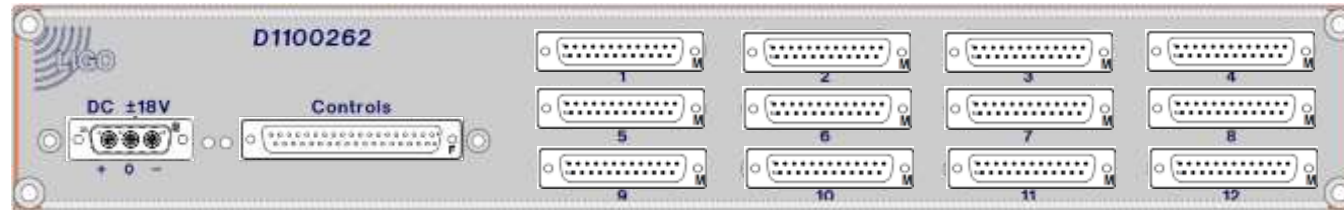

[S1001232](#)

Rear

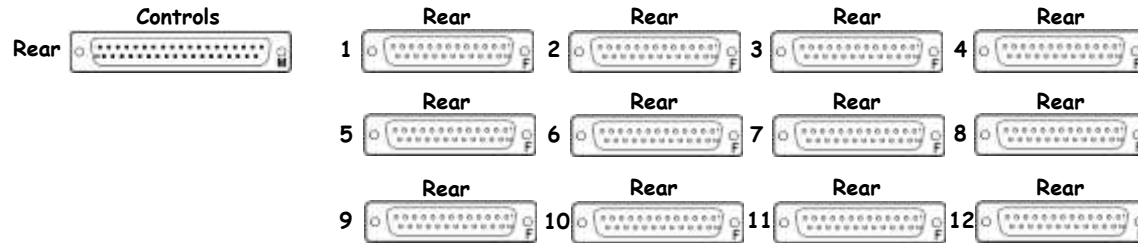

D1001370 - S1202500



D1001370

Front



S1202500

Rear

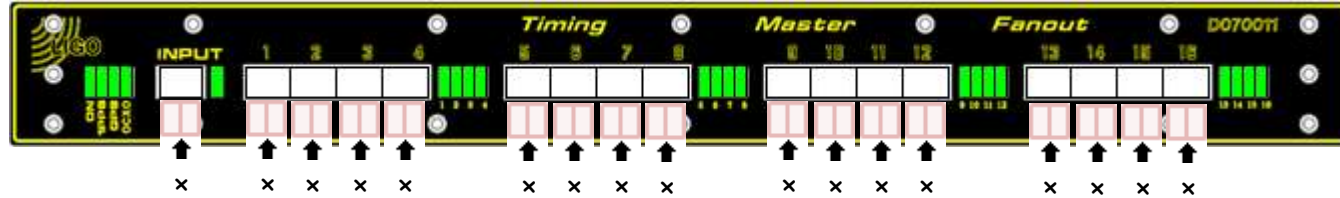

[D070011](#) (D080534)
Front



[S1201221](#)
Rear
Fanout

- [RF Distribution Panel 1](#)
- [RF Distribution Panel 2](#)
- [RF Distribution Panel 3](#)
- [RF Distribution Panel 4](#)
- [RF Distribution Panel 5](#)
- [RF Distribution Panel 6](#)

- [IFR Signal Generator](#)
- [9.099 / 8.684 MHz Distribution Amplifier](#)
- [Spectrum Microwave Harmonic Generator](#)
- [9.099 / 8.684 MHz Harmonic Power Supply](#)
- [18 MHz Distribution Amplifier](#)
- [27 MHz Distribution Amplifier](#)
- [36 MHz Distribution Amplifier](#)
- [45 MHz Distribution Amplifier](#)
- [90 MHz Distribution Amplifier](#)
- [135 MHz Distribution Amplifier](#)

- [24.078 / 22.993 MHz RF Source](#)
- [24.078 / 22.993 MHz Distribution Amplifier](#)
- [71 MHz RF Source](#)
- [71 MHz Distribution Amplifier](#)

	42	
	41	
	40	
	39	
	38	
	37	
	36	
	35	
	34	
	33	
	32	
	31	
	30	
	29	
	28	
	27	
	26	
	25	
	24	
	23	
	22	
	21	
	20	
	19	
	18	
	17	
	16	
	15	
	14	
	13	
	12	
	11	
	10	
	9	
	8	
	7	
	6	
	5	
	4	
	3	
	2	
	1	
Front		Rear

- No Power
- No Power
- No Power
- No Power
- No Power
- No Power
- Power
- ±17VDC, ±24VDC
- From D1002735
- ±17VDC, ±24VDC
- ±17VDC, ±24VDC
- ±17VDC, ±24VDC
- ±17VDC, ±24VDC
- ±17VDC, ±24VDC
- ±17VDC, ±24VDC
- ±17VDC, ±24VDC
- +12VDC, ±24VDC
- ±17VDC, ±24VDC
- +12VDC, ±24VDC
- ±17VDC, ±24VDC



ISC-C4 is part of [D1001427](#).

L1-ISC-C4

ISC LVEA Rack 4 Layout ([D1001427](#)) ([S1201189](#))

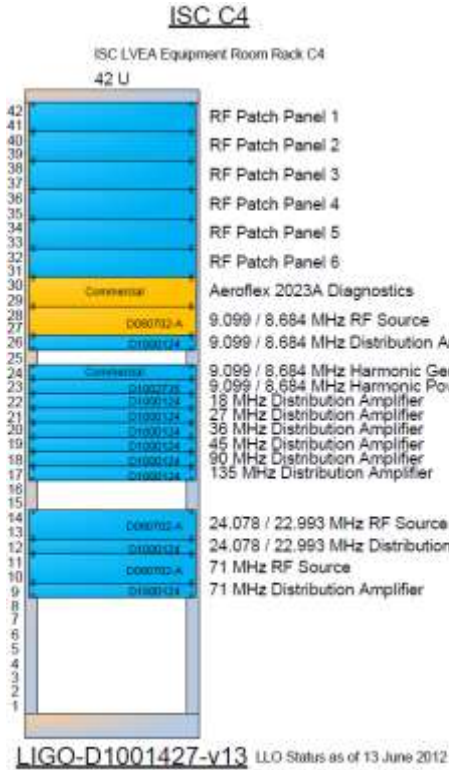

([D1001427](#))

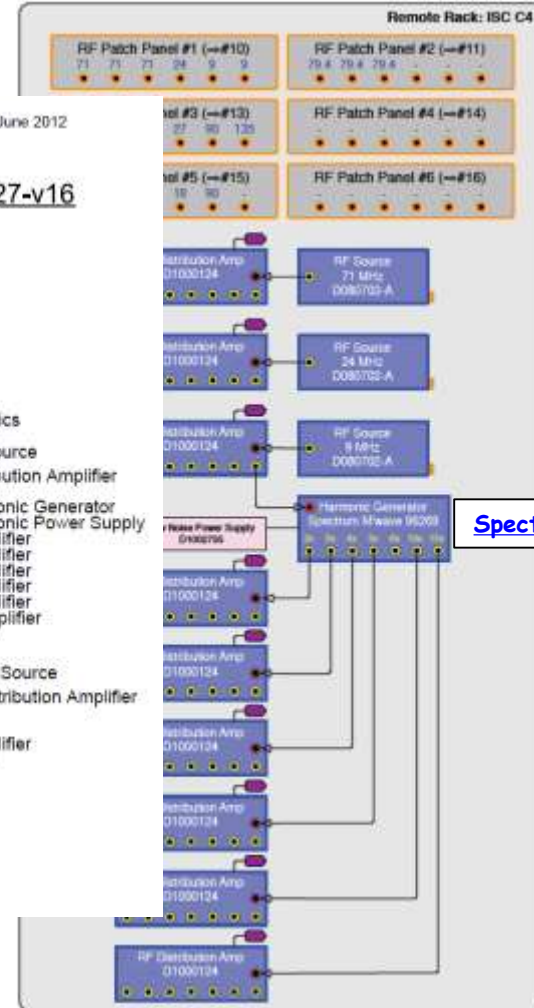
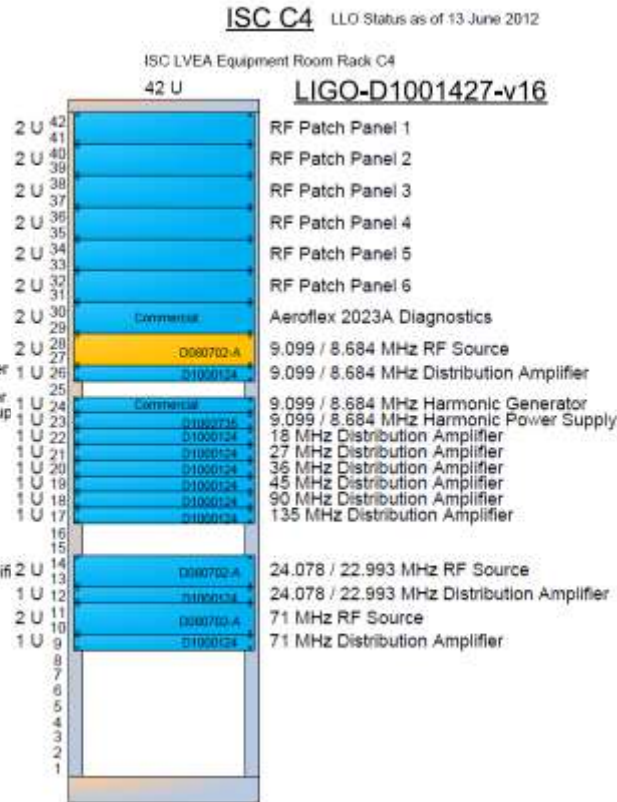

([D1100170](#))

Spectrum Microwave

L1-ISC-C4 Details

ISC-C4 is part of [D1001427](#).

RF Distribution Panel 1

<< [L1-ISC-C4](#)

RF Distribution Panel 1

Dxxxxxxx

Sxxxxxxx

No Power

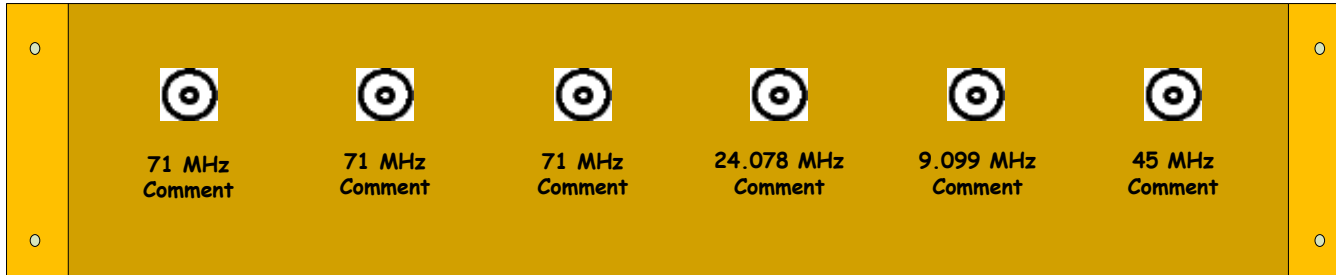

Dxxxxxxx

Front

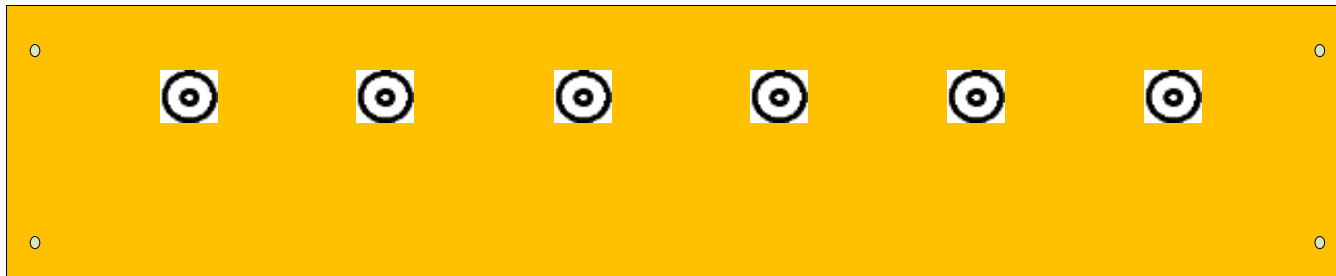

Sxxxxxxx

Rear

RF Distribution Panel 2

<< [L1-ISC-C4](#)

RF Distribution Panel 2

Dxxxxxxx

Sxxxxxxx

No Power

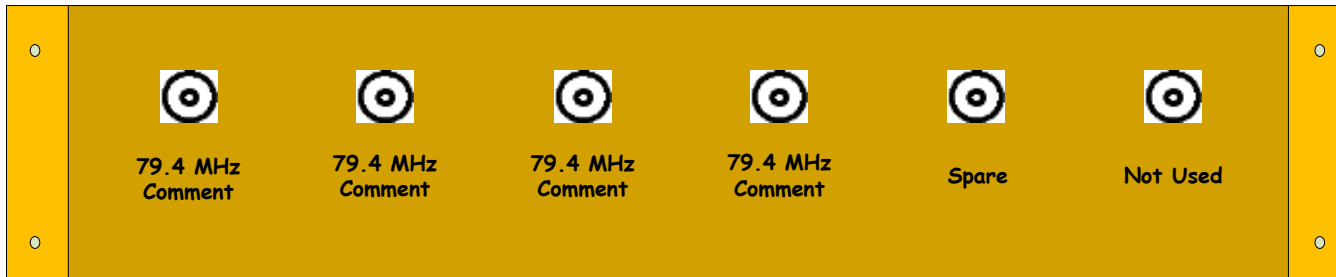

Dxxxxxxx

Front

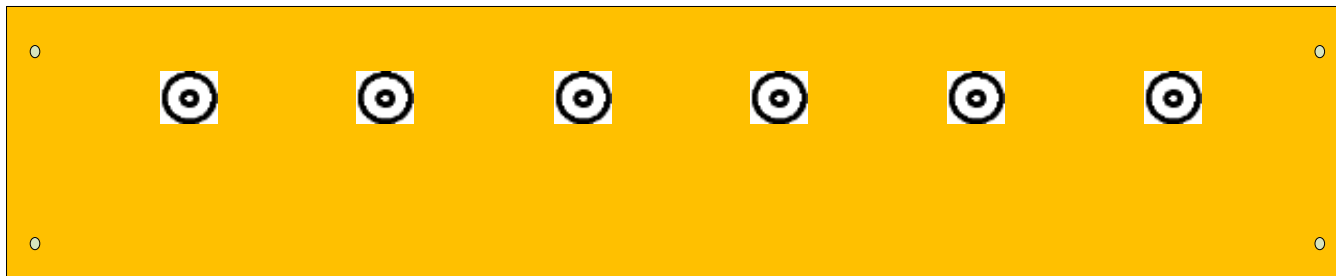

Sxxxxxxx

Rear

RF Distribution Panel 3

<< [L1-ISC-C4](#)

RF Distribution Panel 3

Dxxxxxxx

Sxxxxxxx

No Power

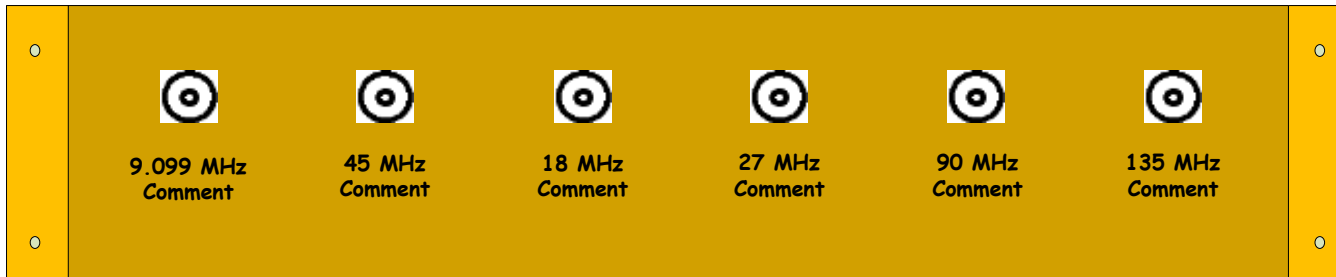

Dxxxxxxx

Front

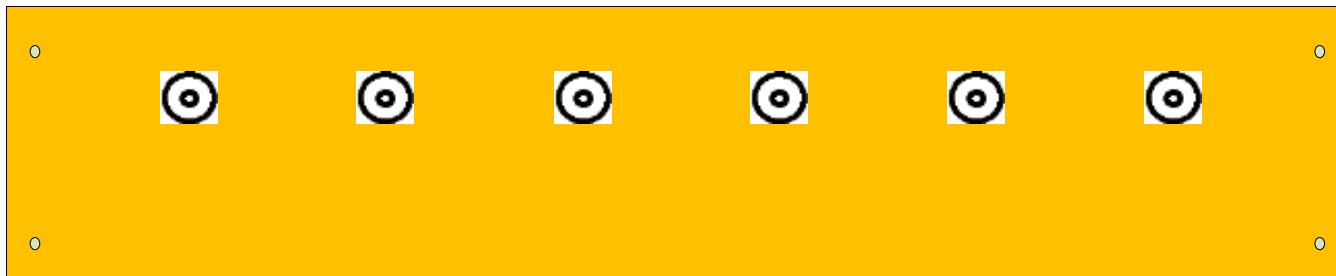

Sxxxxxxx

Rear

RF Distribution Panel 4

<< [L1-ISC-C4](#)

RF Distribution Panel 4

Dxxxxxxx

Sxxxxxxx

No Power

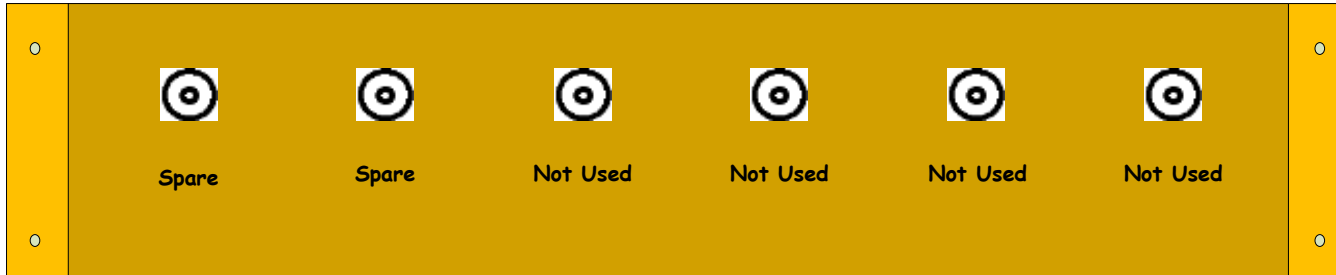

Dxxxxxxx

Front

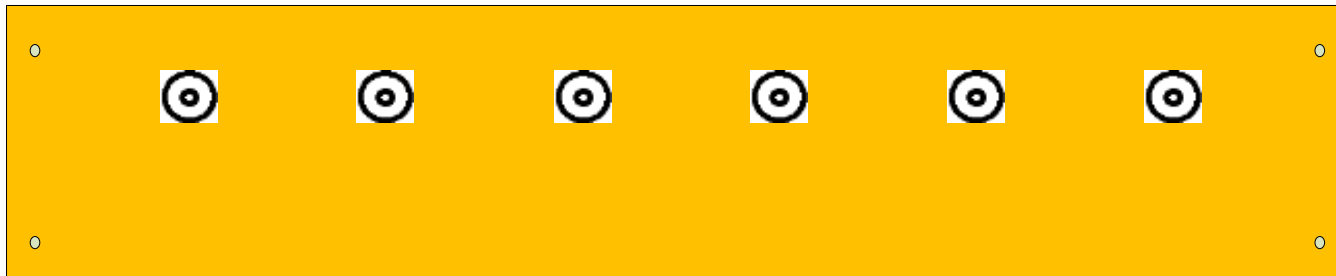

Sxxxxxxx

Rear

RF Distribution Panel 5

<< [L1-ISC-C4](#)

RF Distribution Panel 5

Dxxxxxxx

Sxxxxxxx

No Power

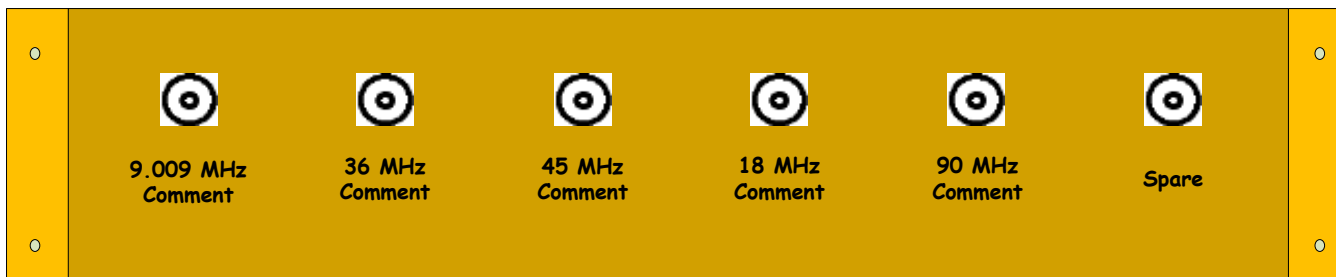

Dxxxxxxx

Front

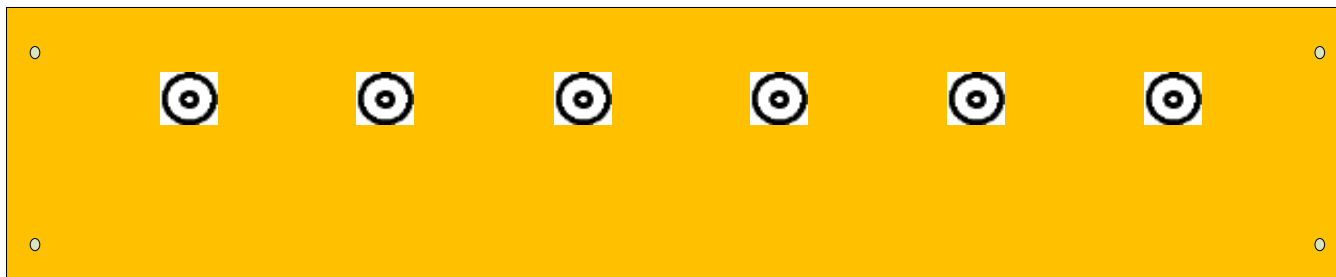

Sxxxxxxx

Rear

RF Distribution Panel 6

<< [L1-ISC-C4](#)

RF Distribution Panel 6

Dxxxxxxx

Sxxxxxxx

No Power

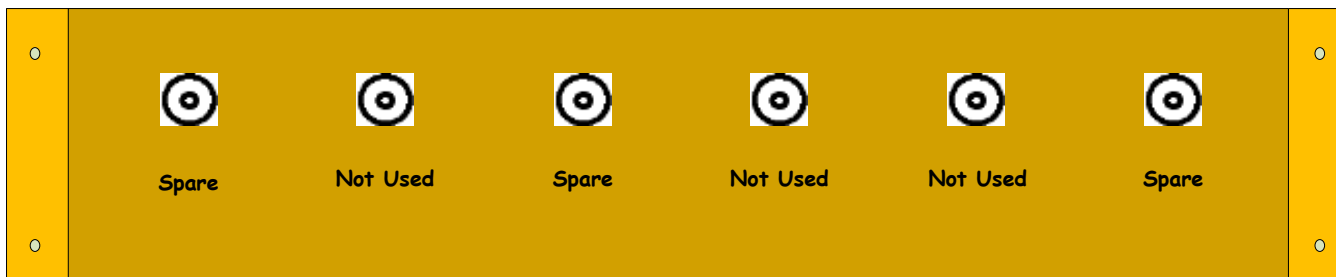

Dxxxxxxx

Front

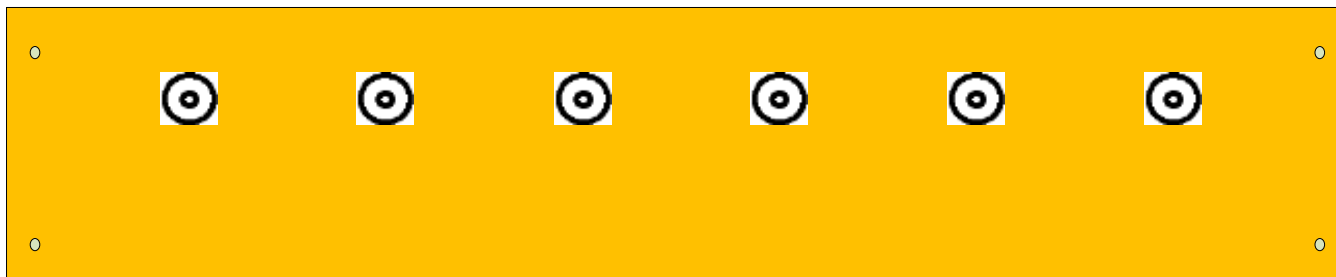

Sxxxxxxx

Rear



[D080702](#)

Front



[S1001232](#)

Rear

D1000124 - S1000657



<< L1-ISC-C4

9.099 / 8.684 MHz Distribution Amplifier

D1000124

S1000657

±17VDC, ±24VDC

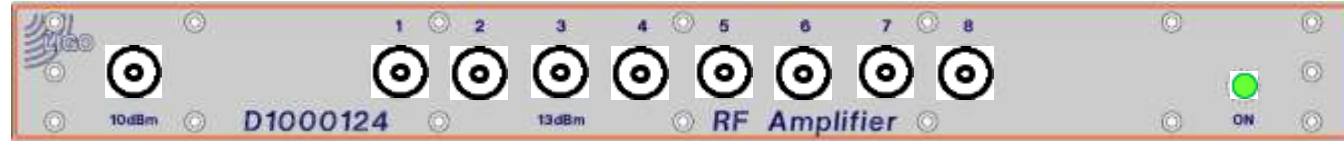

D1000124

Front

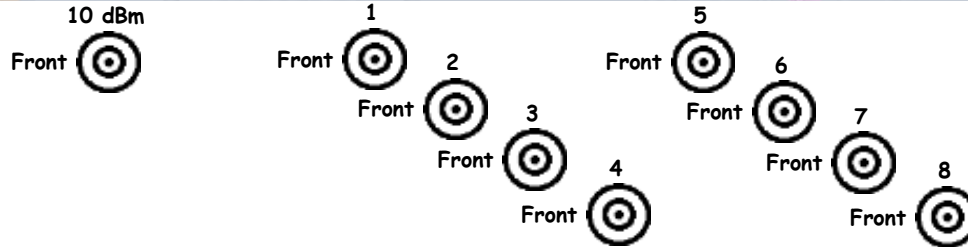

S1000657

Rear

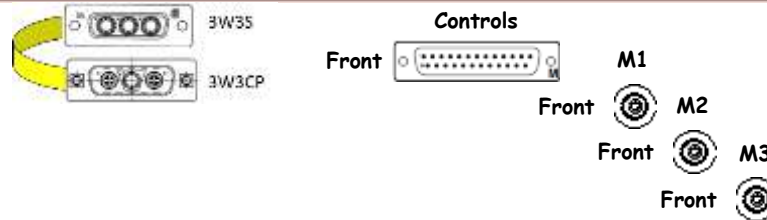

<< [L1-ISC-C4](#) 9.099 / 8.684 MHz Harmonic Generator Power Supply D1002735 S1000795 ±17VDC, ±24VDC

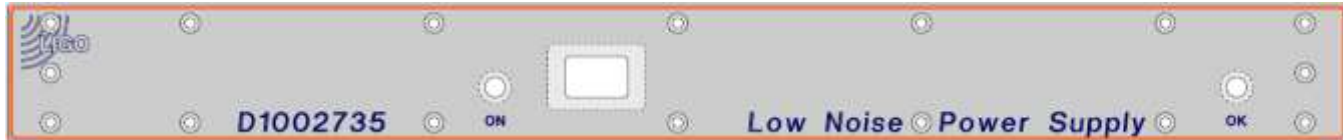

[D1002735](#)

Front

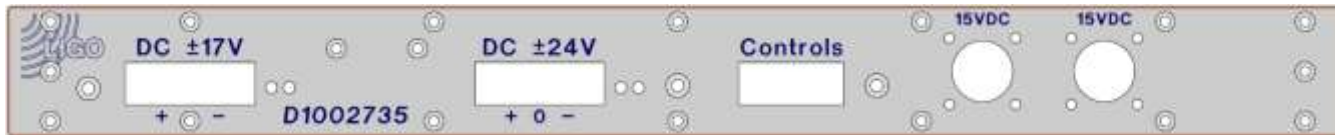

[S1000795](#)

Rear

From DAC Adapter

D1000124 - S1000660

<< L1-ISC-C4

18 MHz Distribution Amplifier

D1000124

S1000660

±17VDC, ±24VDC



D1000124

Front

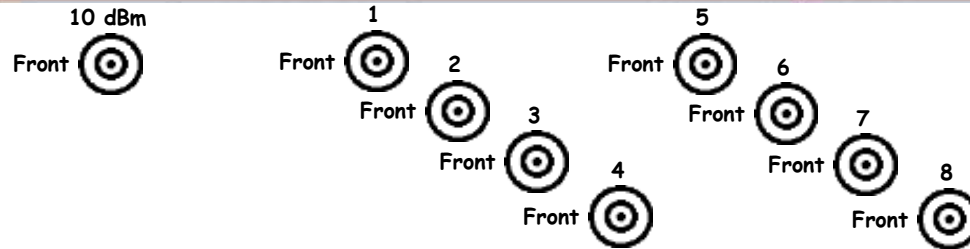

S1000660

Rear

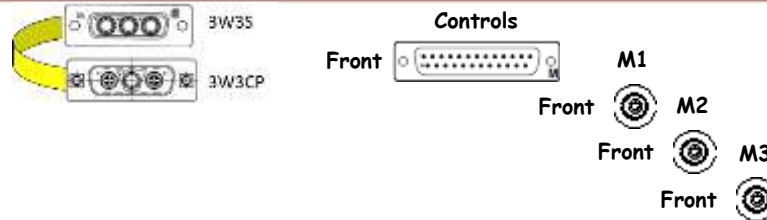

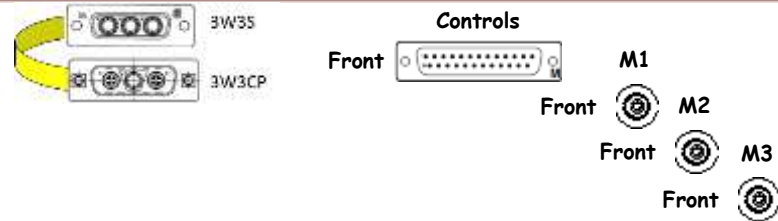
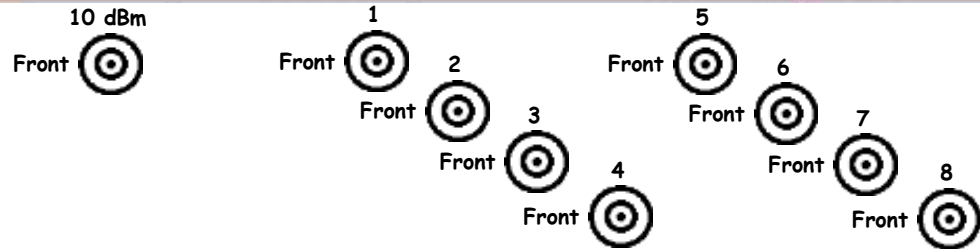
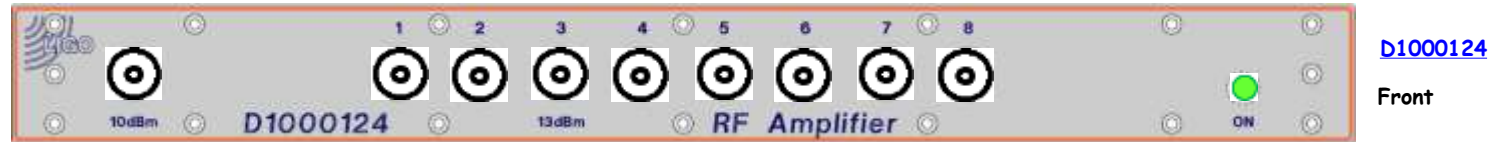

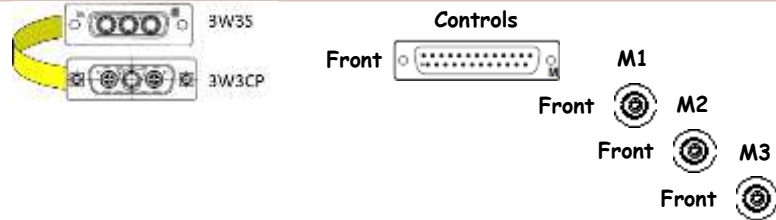
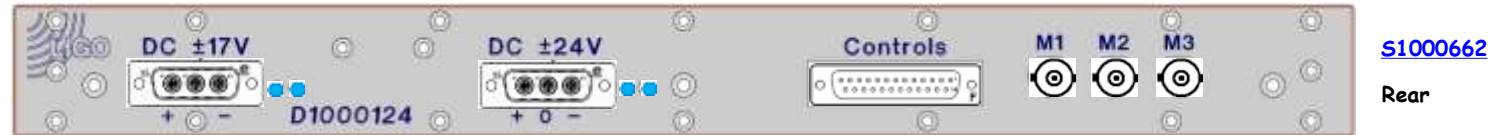
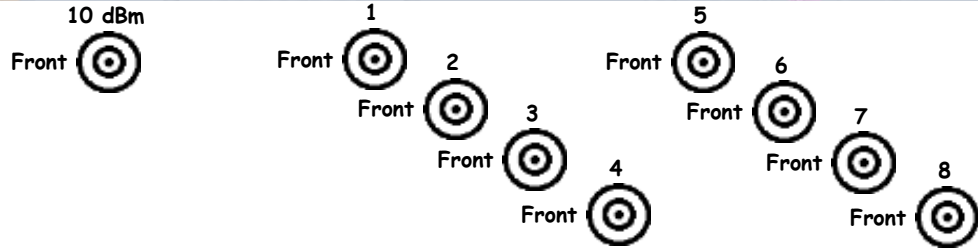
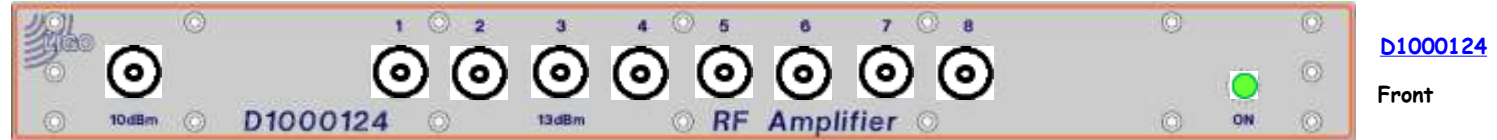

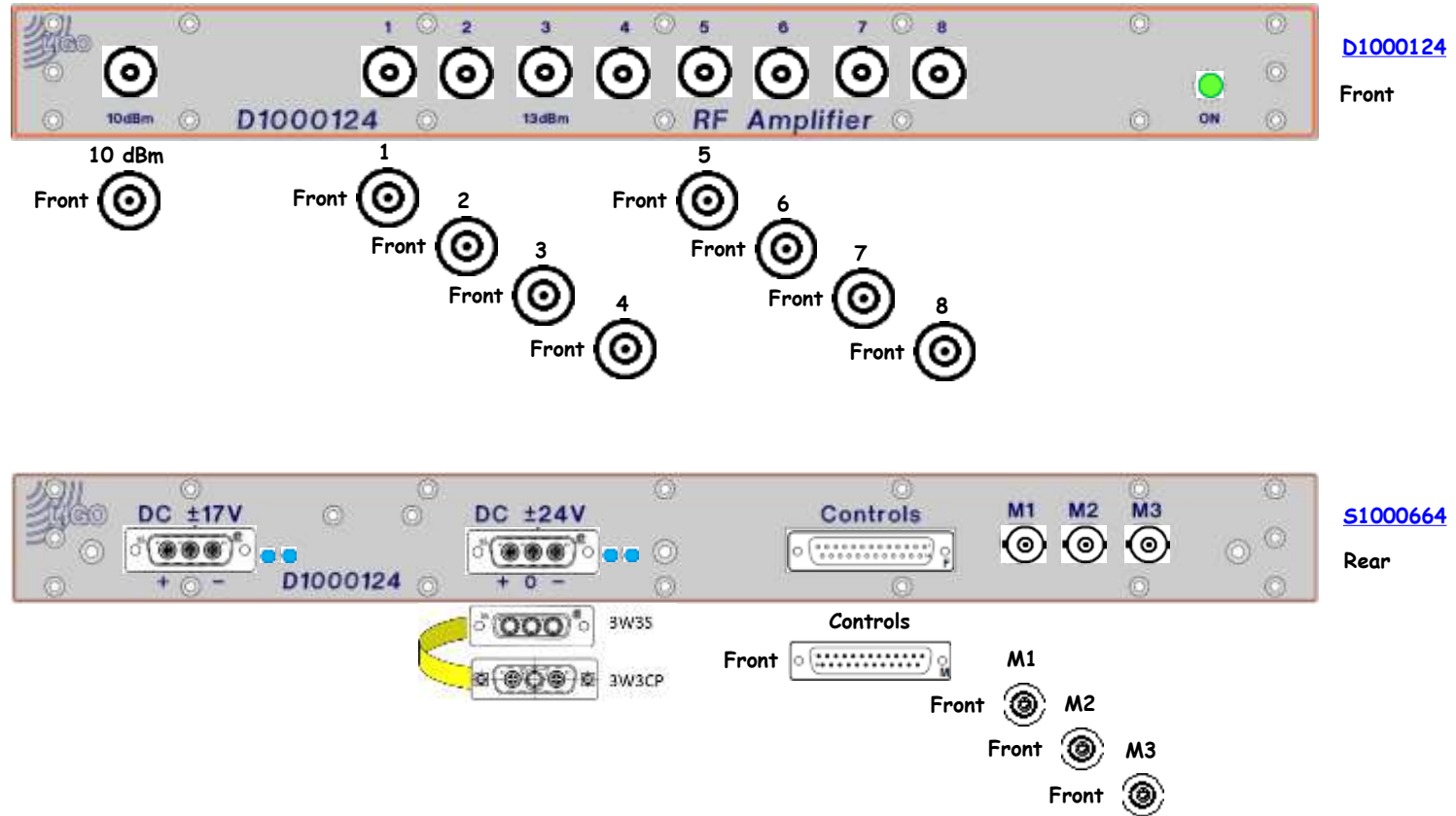

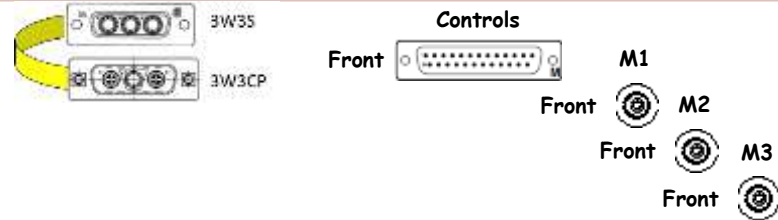
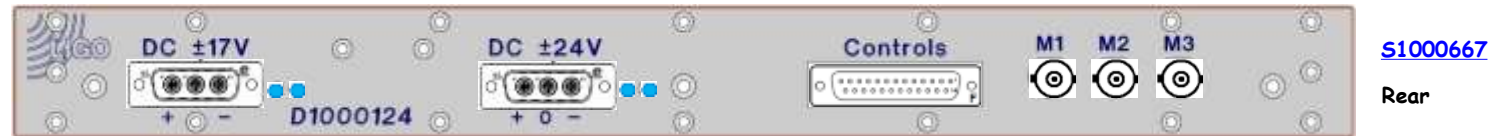
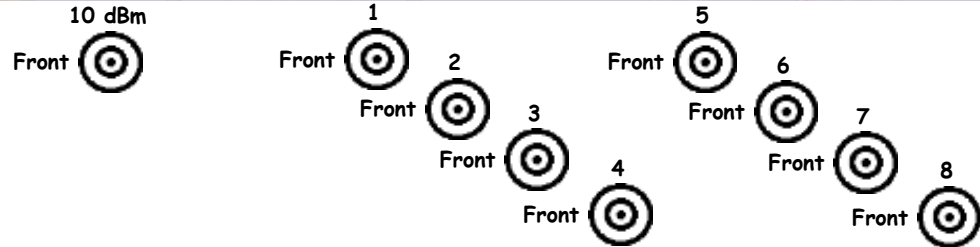
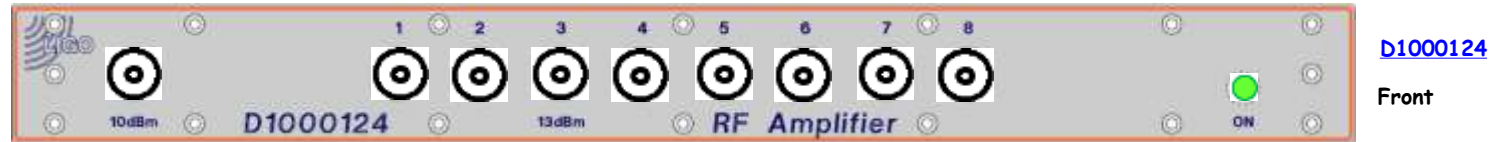

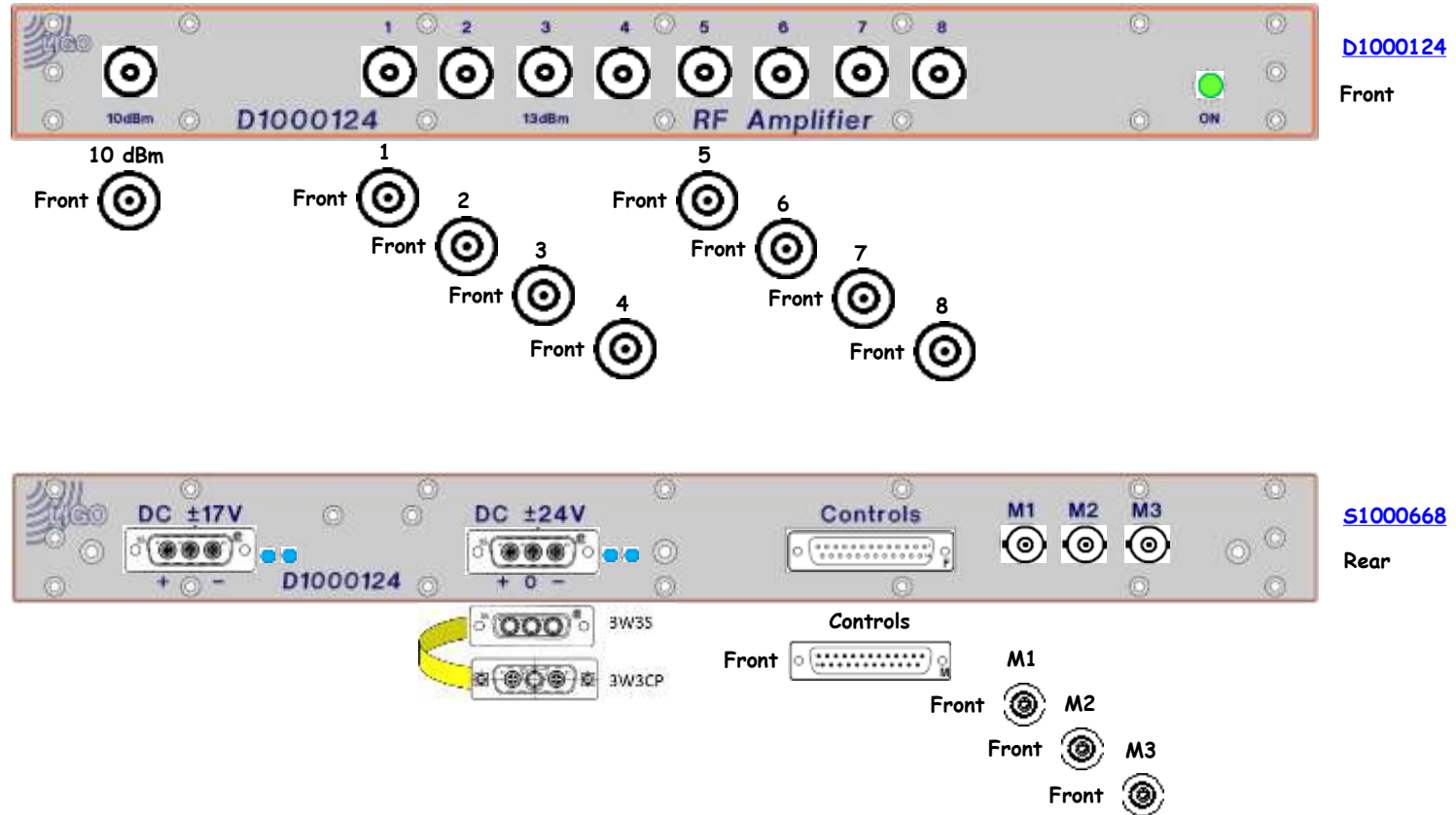

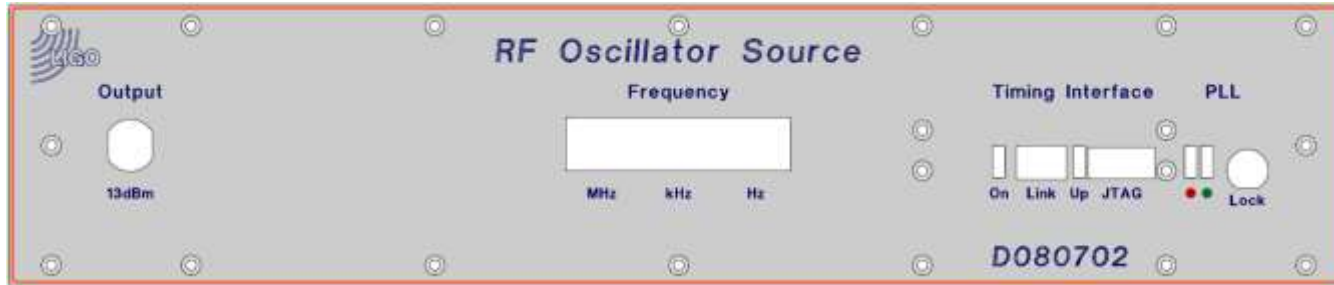

D080702

Front



S1000572

Rear

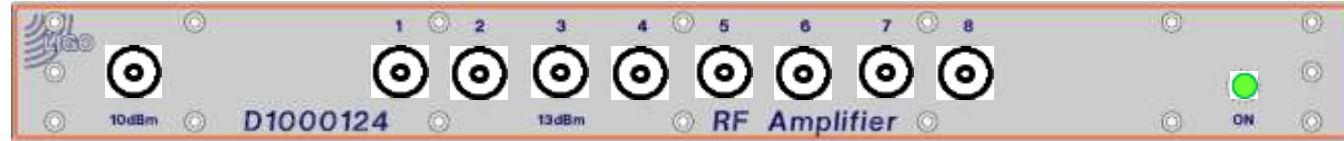

D1000124

Front

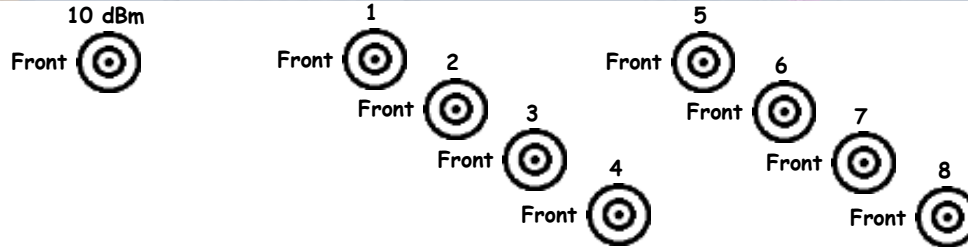

S1000656

Rear

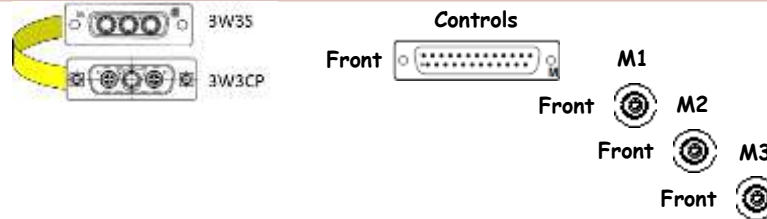

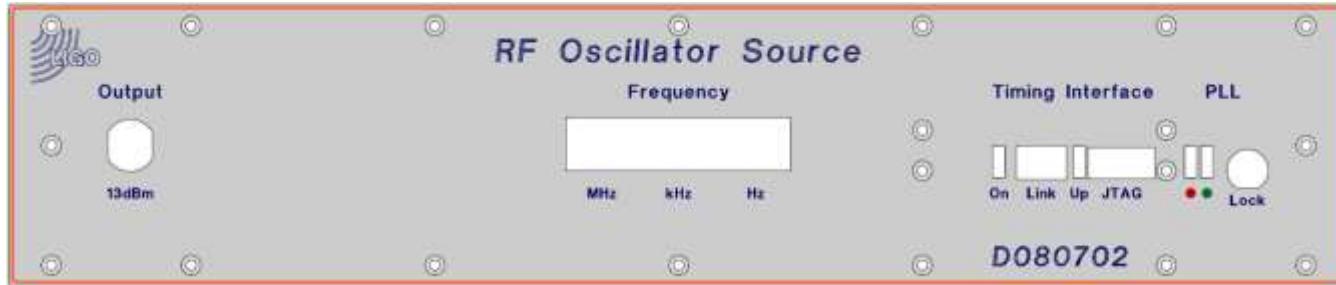

D080702

Front



S1000560

Rear

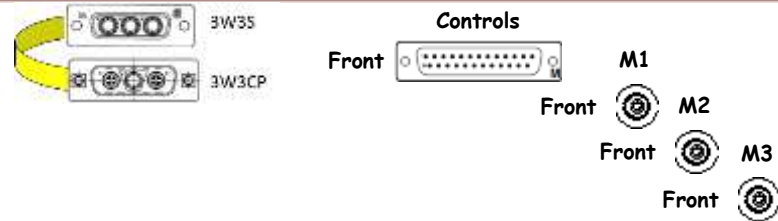
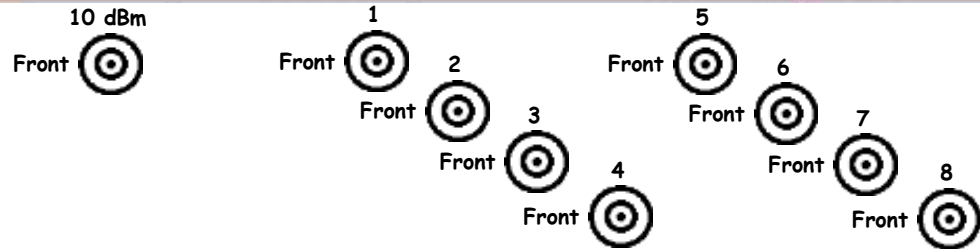
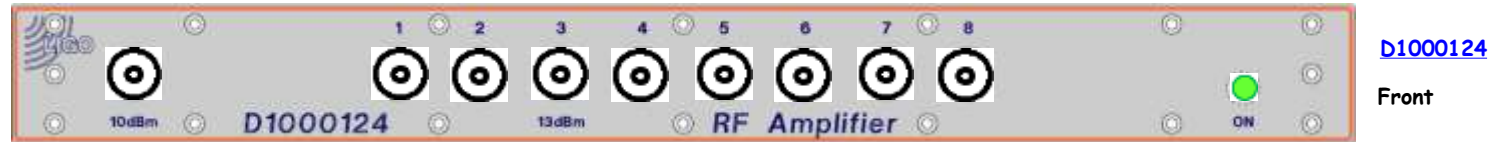

<< LLO Racks by Subsystem

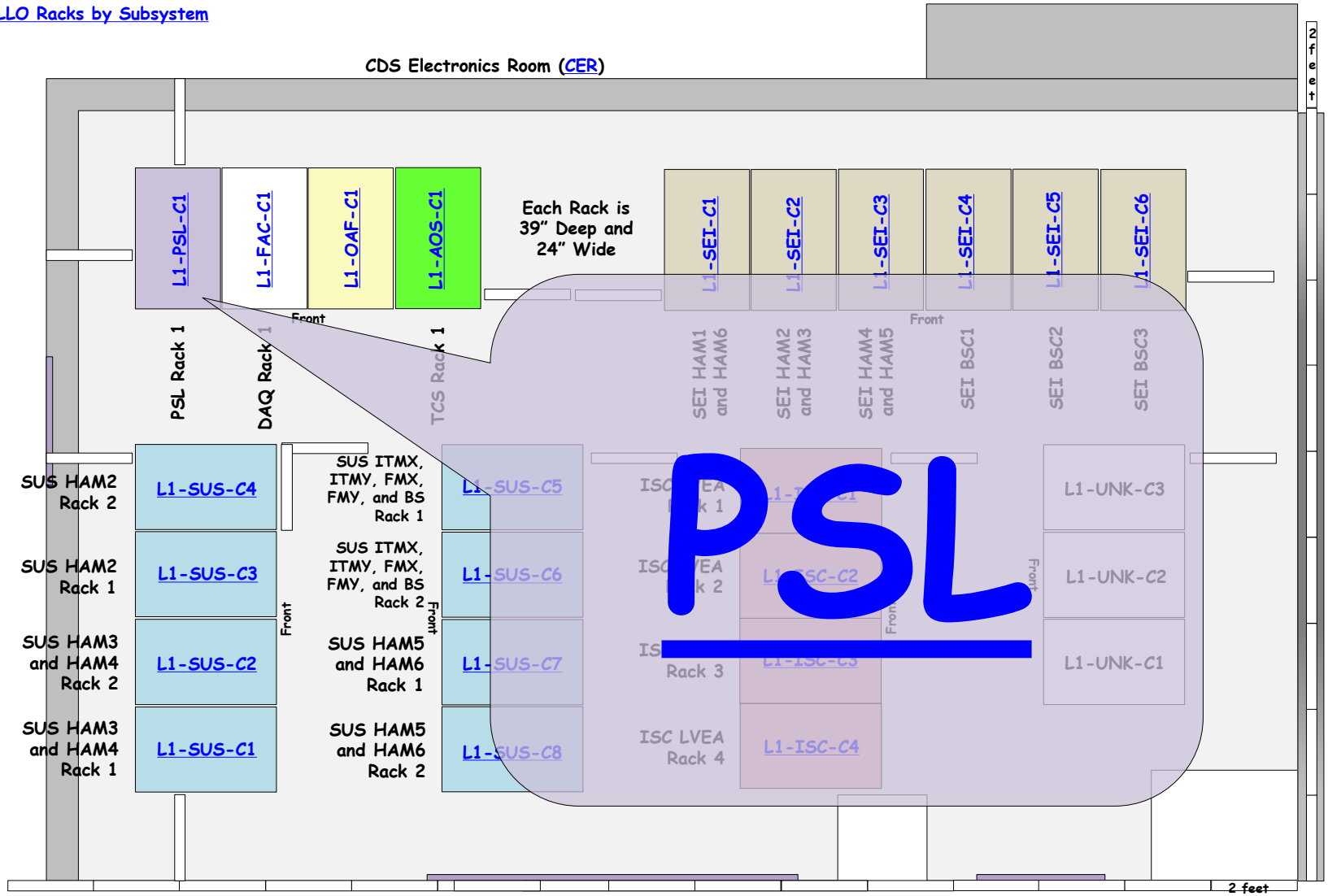

PSL Component List: [LIGO-T0900633](#)

PSL Table Layout: [LIGO-T0900610](#)

PSL Rack 1 Layout (D1201118) (S1202977)

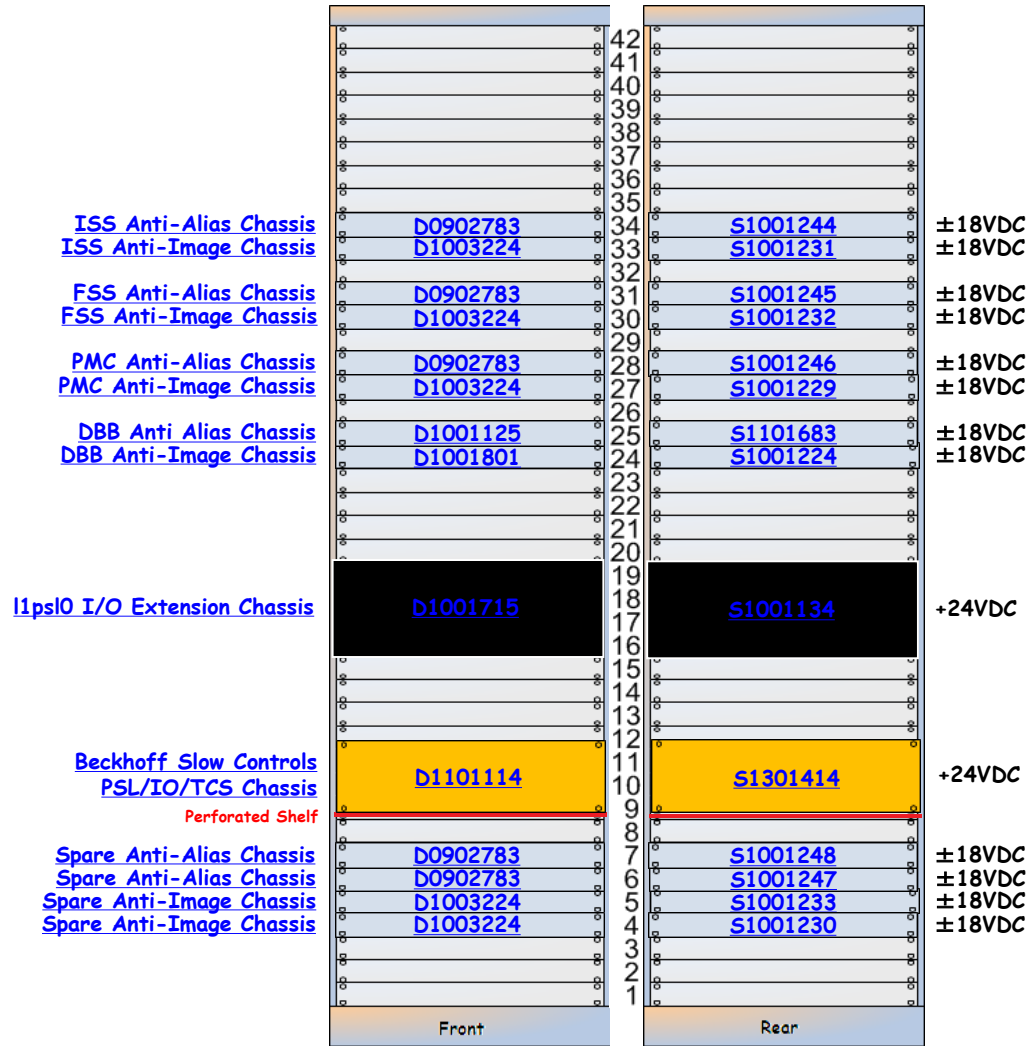

L1-PSL-C1 Details

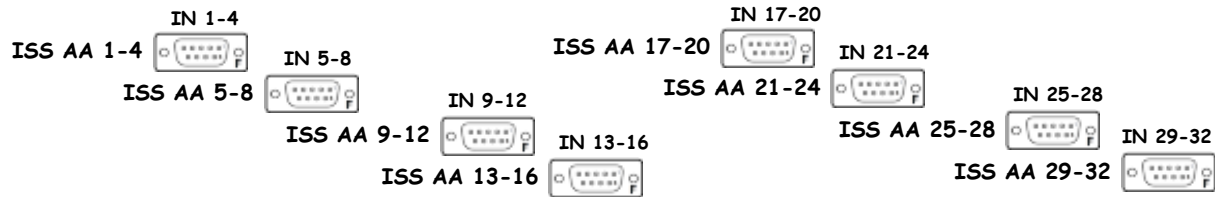

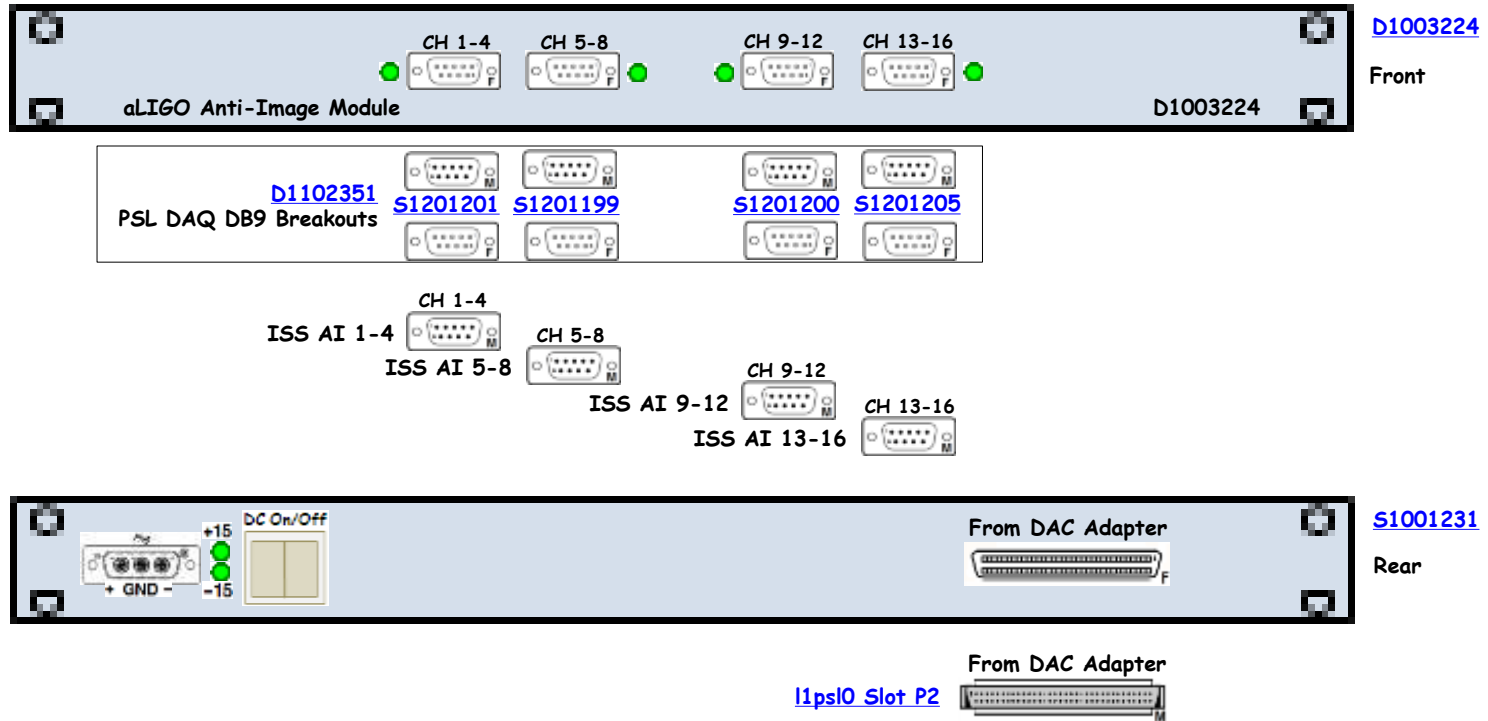

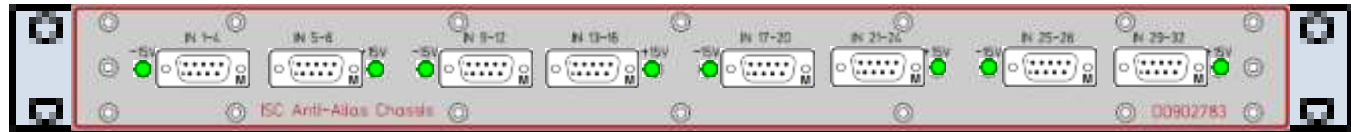

D0902783

Front

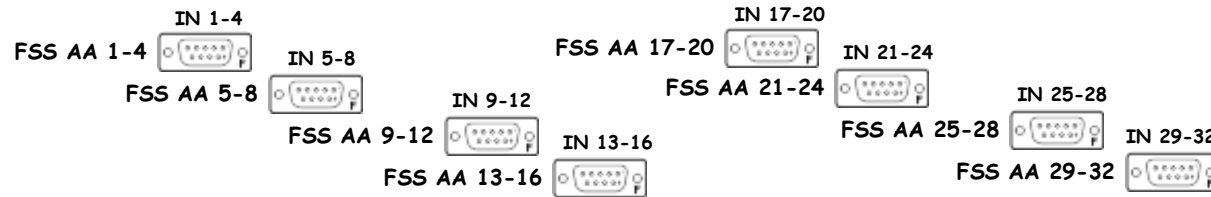

S1001245

Rear



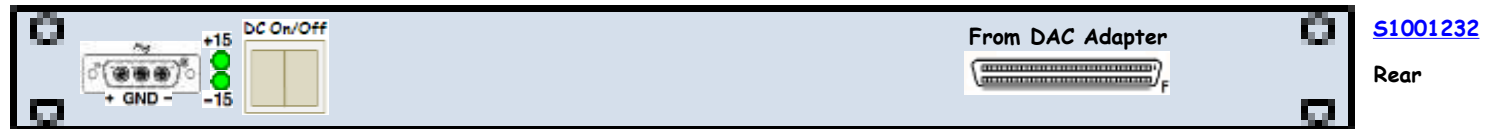
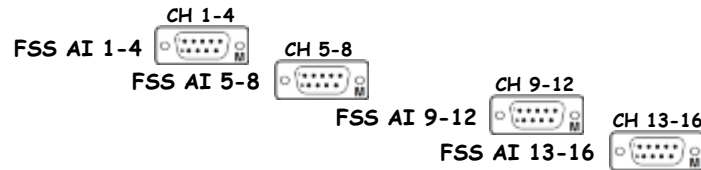
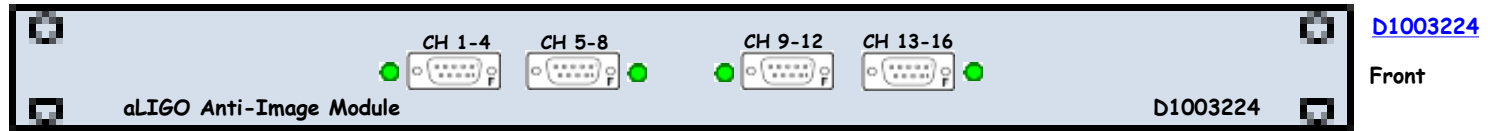

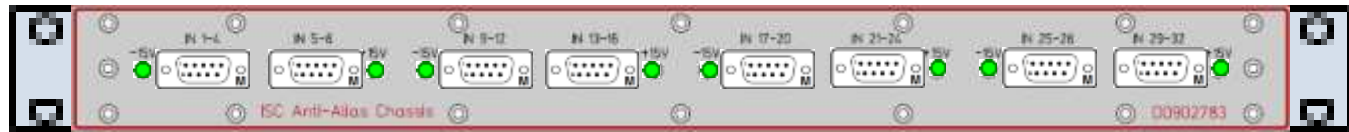

[D0902783](#)

Front

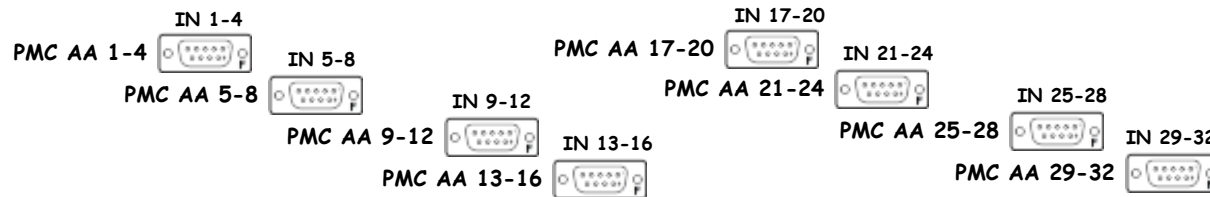

[S1001246](#)

Rear



[I1psI0 Slot P4](#)

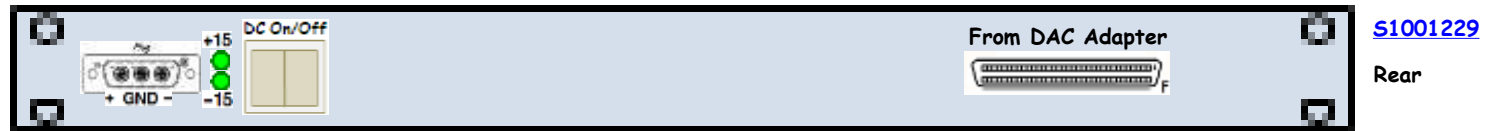
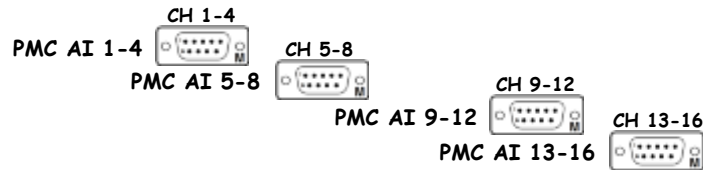
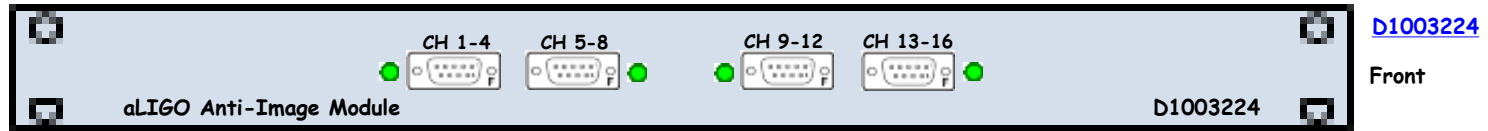

<< L1-PSL-C1

DBB Anti-Alias Chassis ±18VDC

AI Module aLIGO PSL DBB Assembly Drawing [D1100292](#)

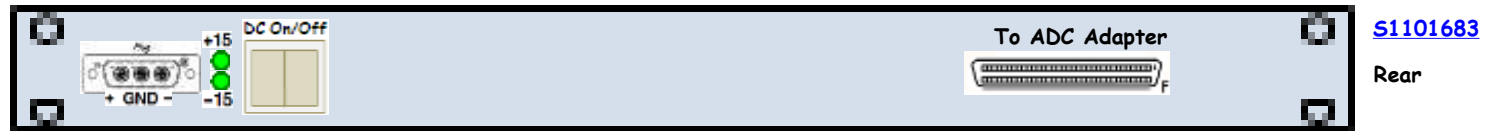
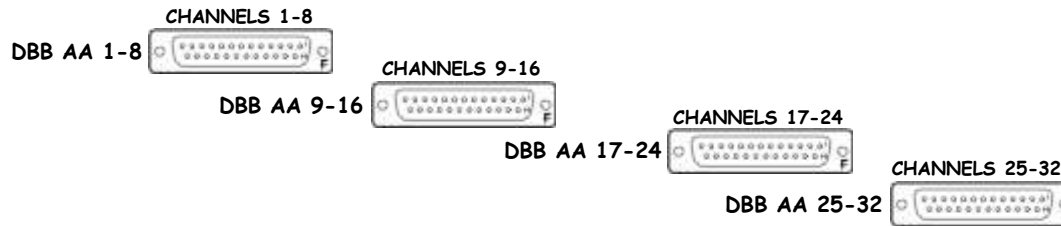

D1001801 - S1001224

<< L1-PSL-C1

DBB Anti-Image Chassis ±18VDC

AI Module aLIGO PSL DBB Assembly Drawing [D1002103](#)

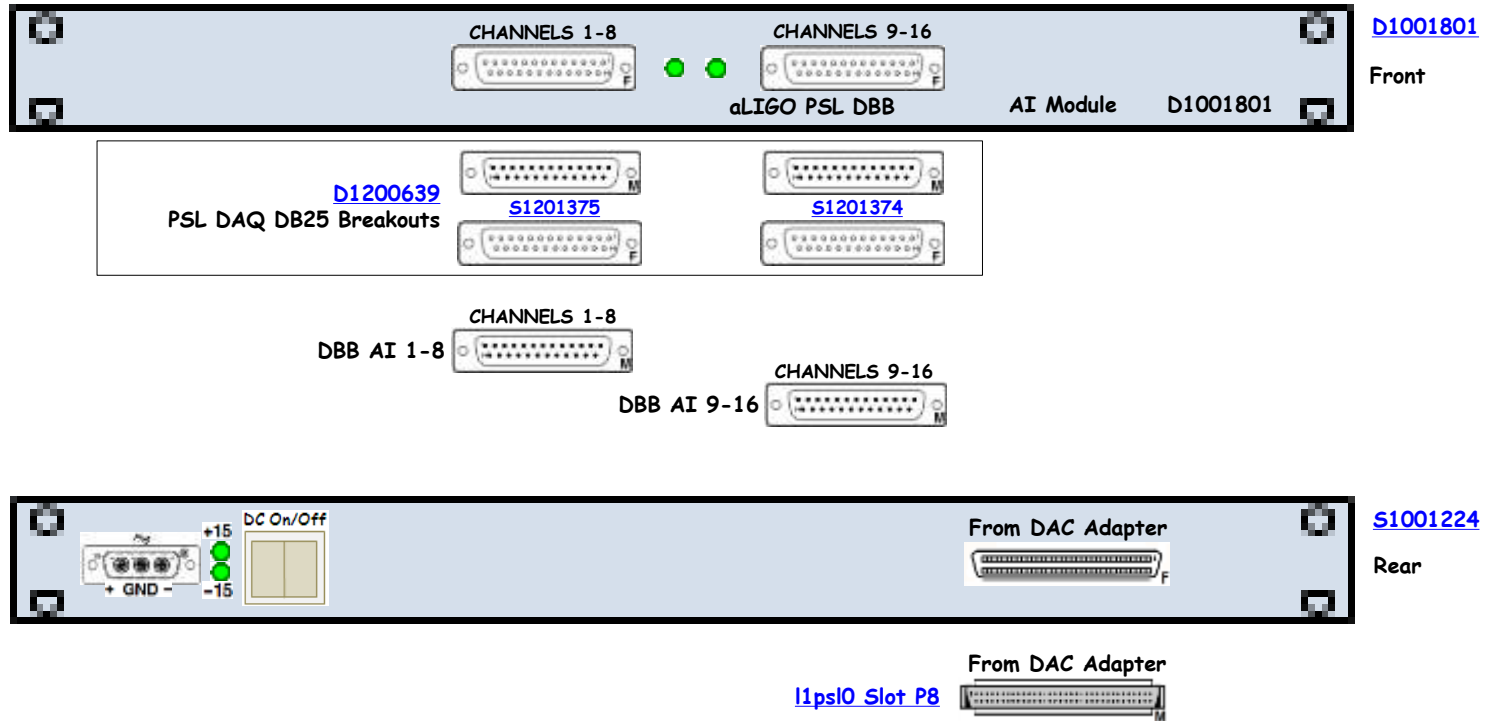

I1psI0 I/O Extension Chassis

D1001715

S1001134

+24VDC

D1001715

Front

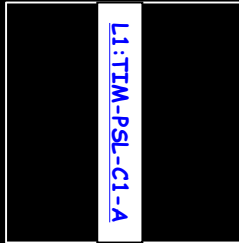

I1psI0 – I/O Extender

S1001134

Rear

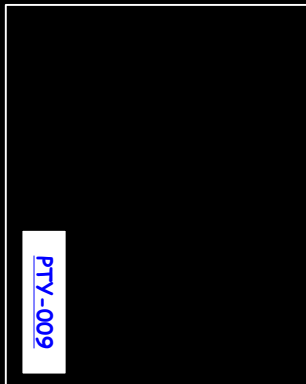

Uplink L1:FE-IO-19

Slot E1 Open

Slot E2 Open

Slot E3 Open

Slot P1 S1001244

Slot P2 S1001231

Slot P3 S1001245

Slot P4 S1001246

Slot P5 S1101683

Slot P6 S1001232

Slot P7 S1001233

Slot P8 S1001224

Slot P9 Open

Slot P10 Open

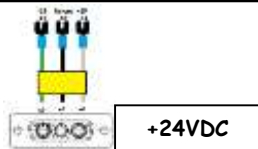

D1101114 - S1301414

<< L1-PSL-C1

Beckhoff Slow Controls
PSL/IO/TCS Chassis

D1101114

S1301414

+24VDC

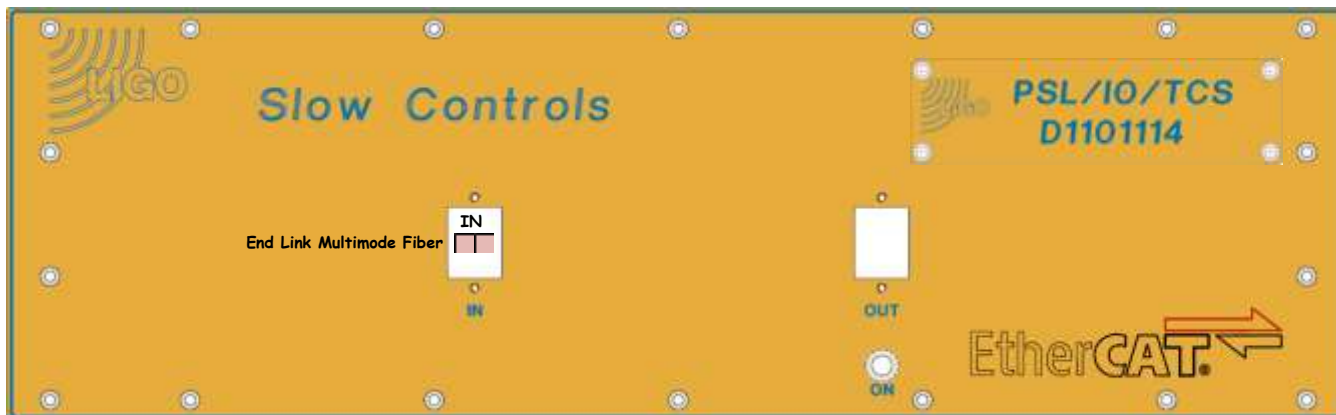

D1101114

Front: D0902553

Name: D1101121

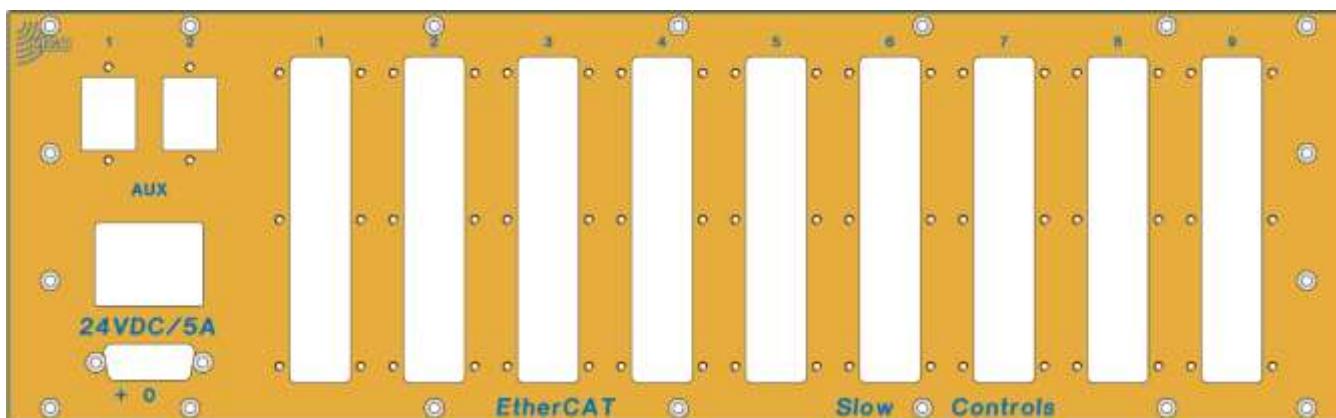

S1301414

Rear: D0902554

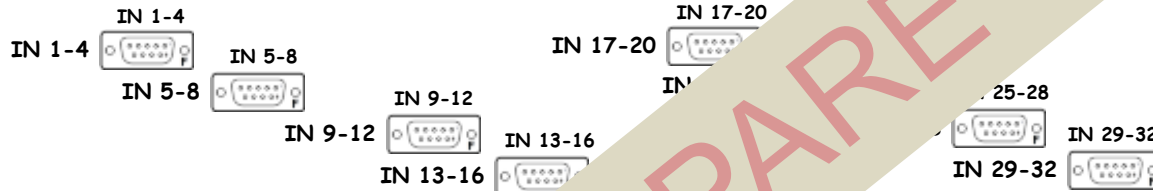
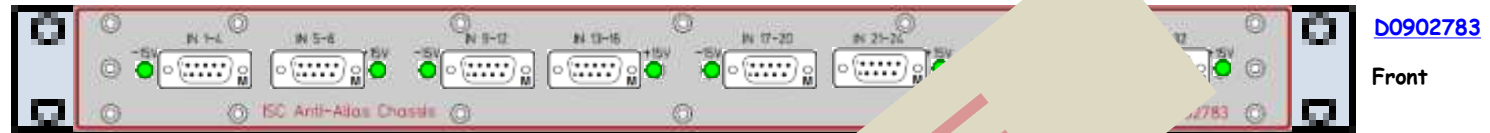

PSL SPARE

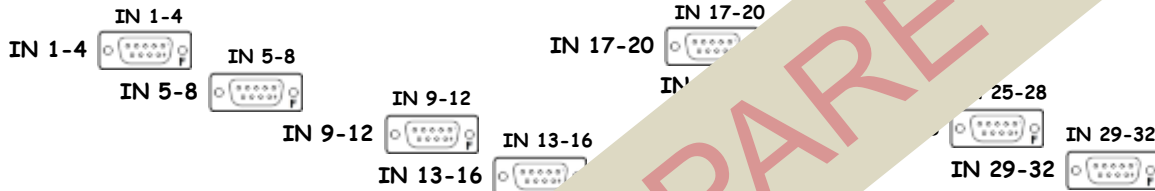
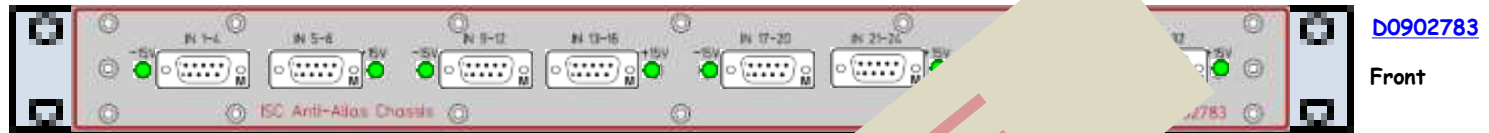

PSL SPARE

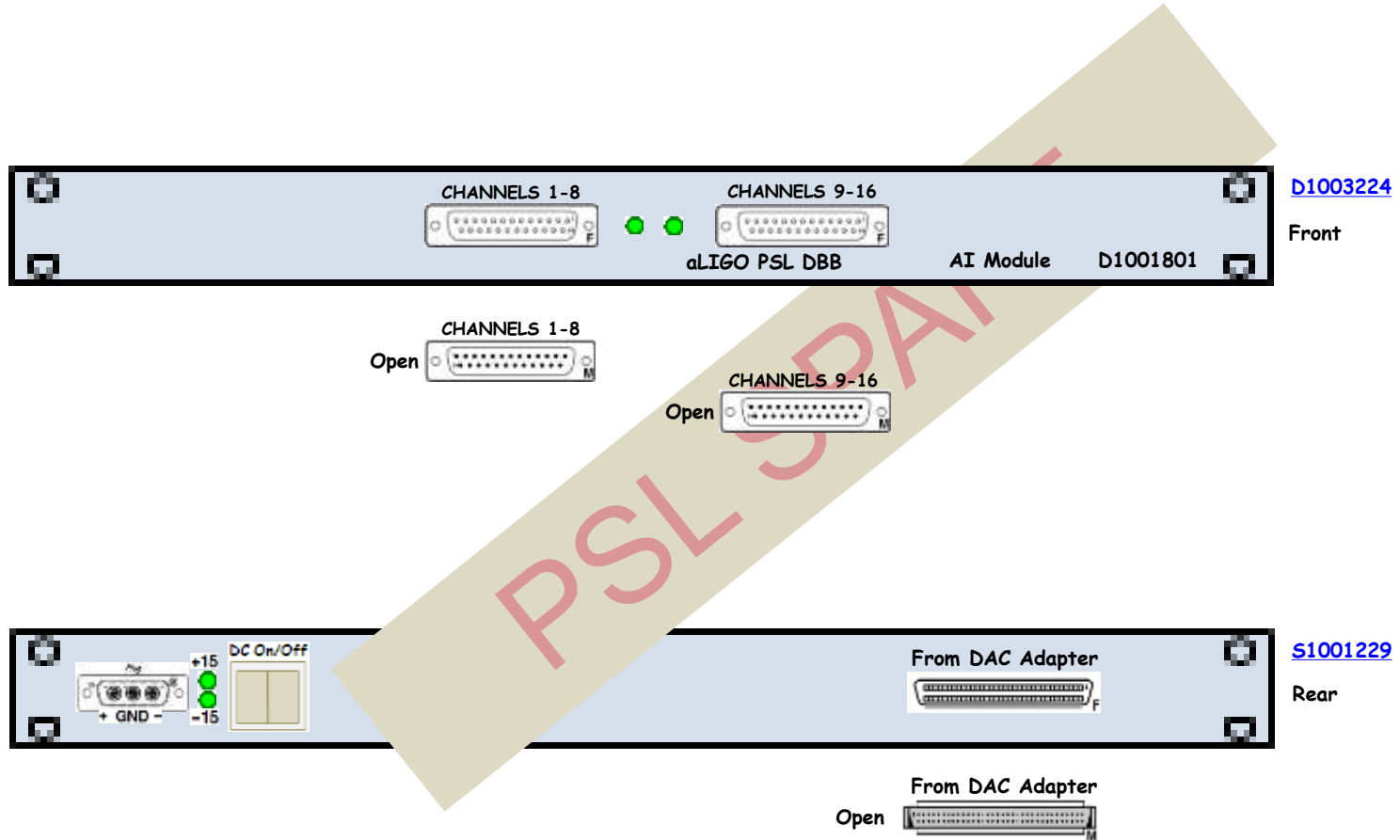

Anti-Image Chassis ±18VDC

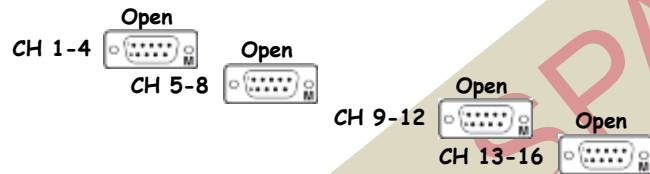
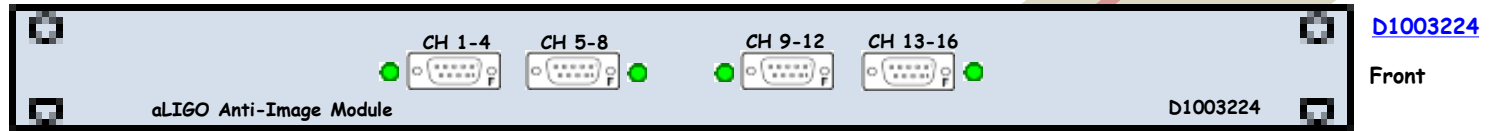

PSL 3 PAI

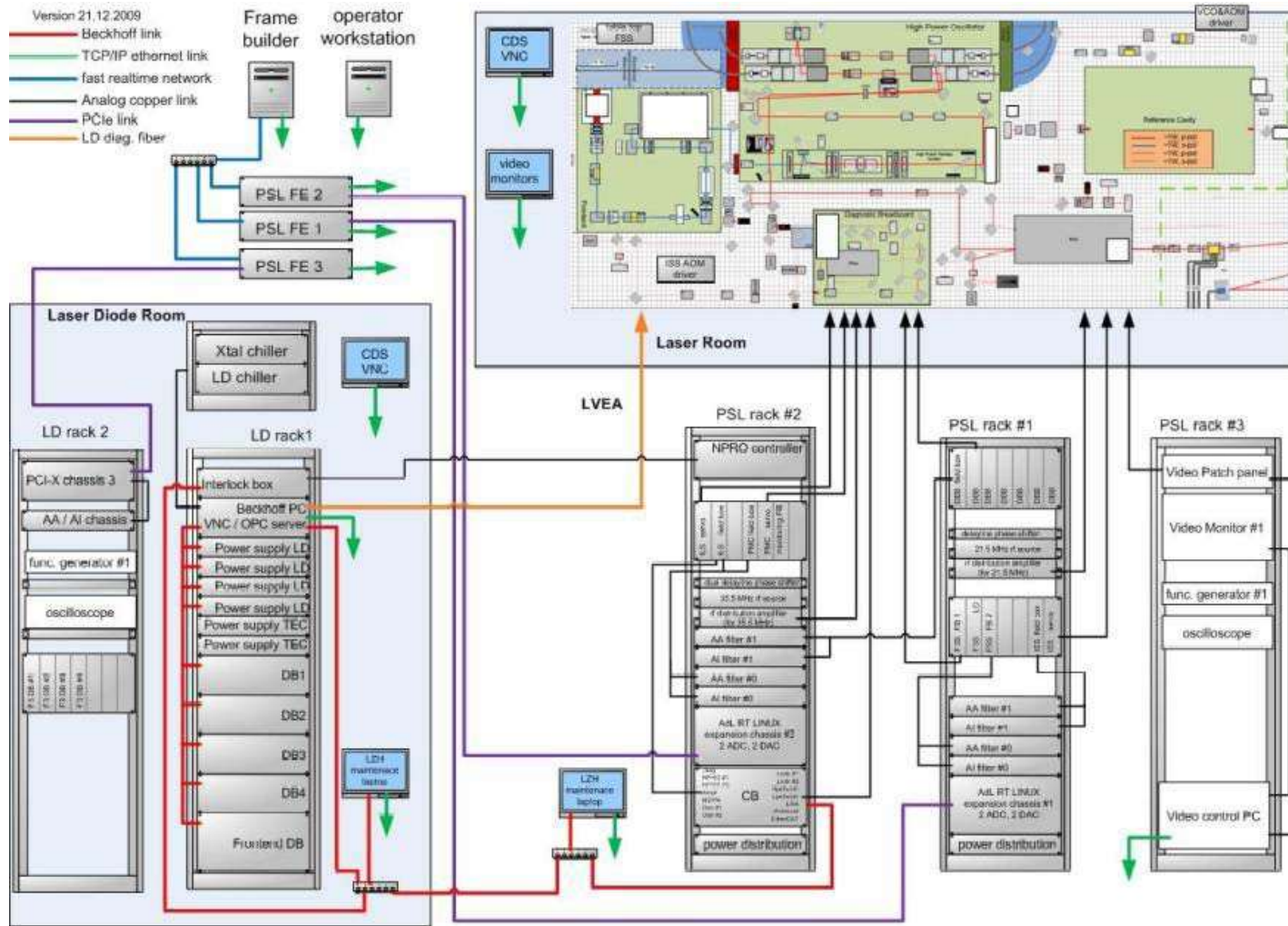

PSL Racks(Layout 20101006)

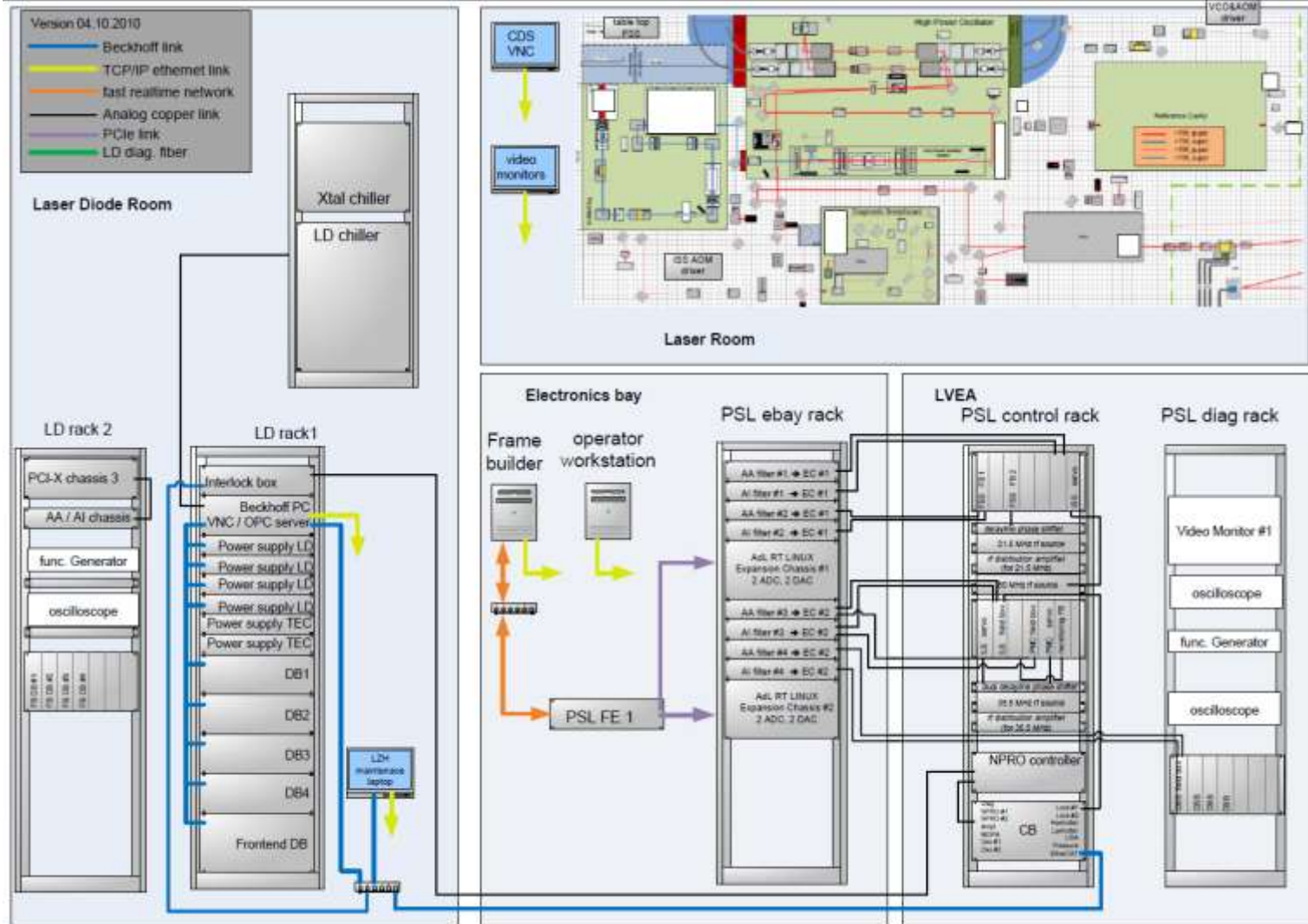

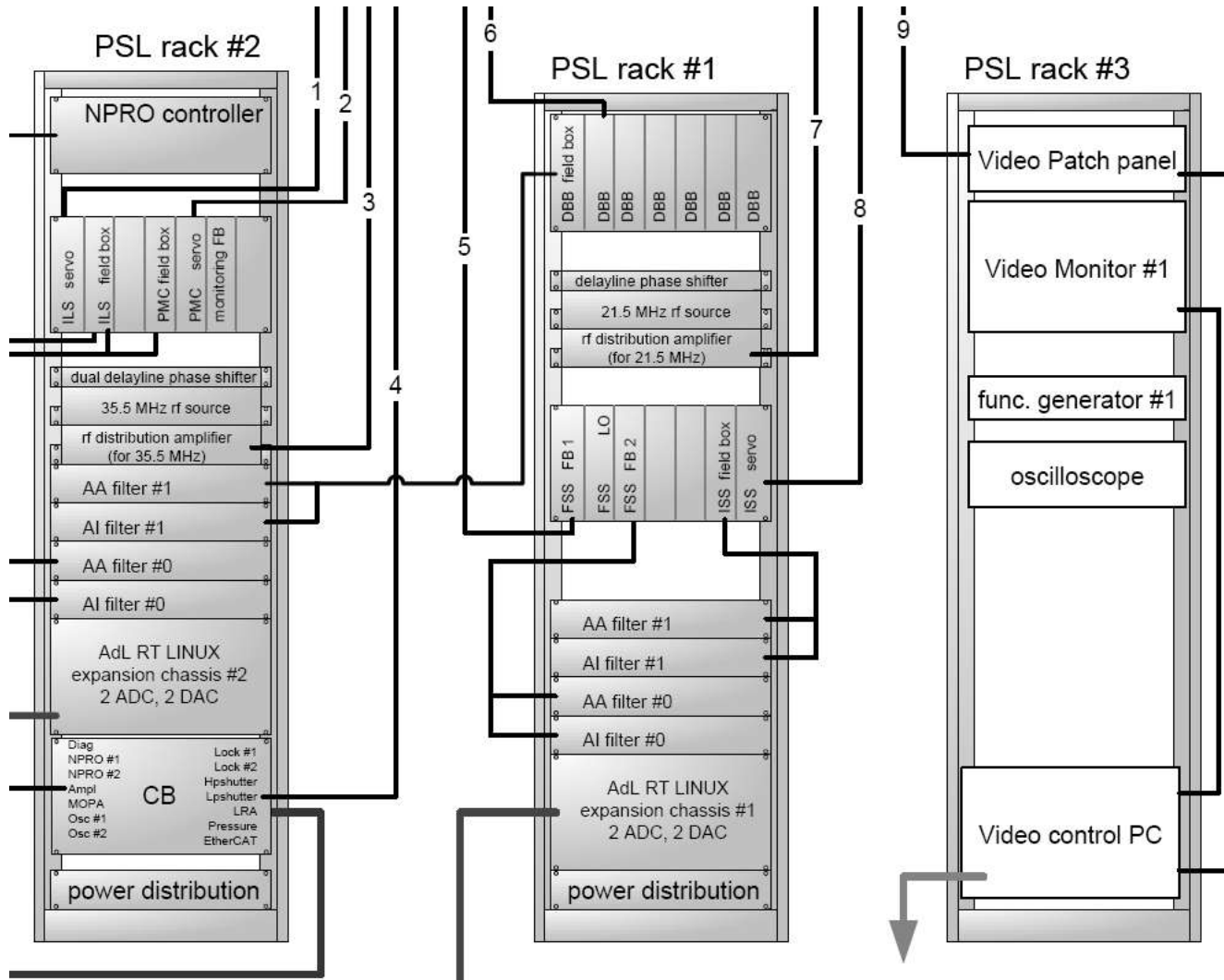

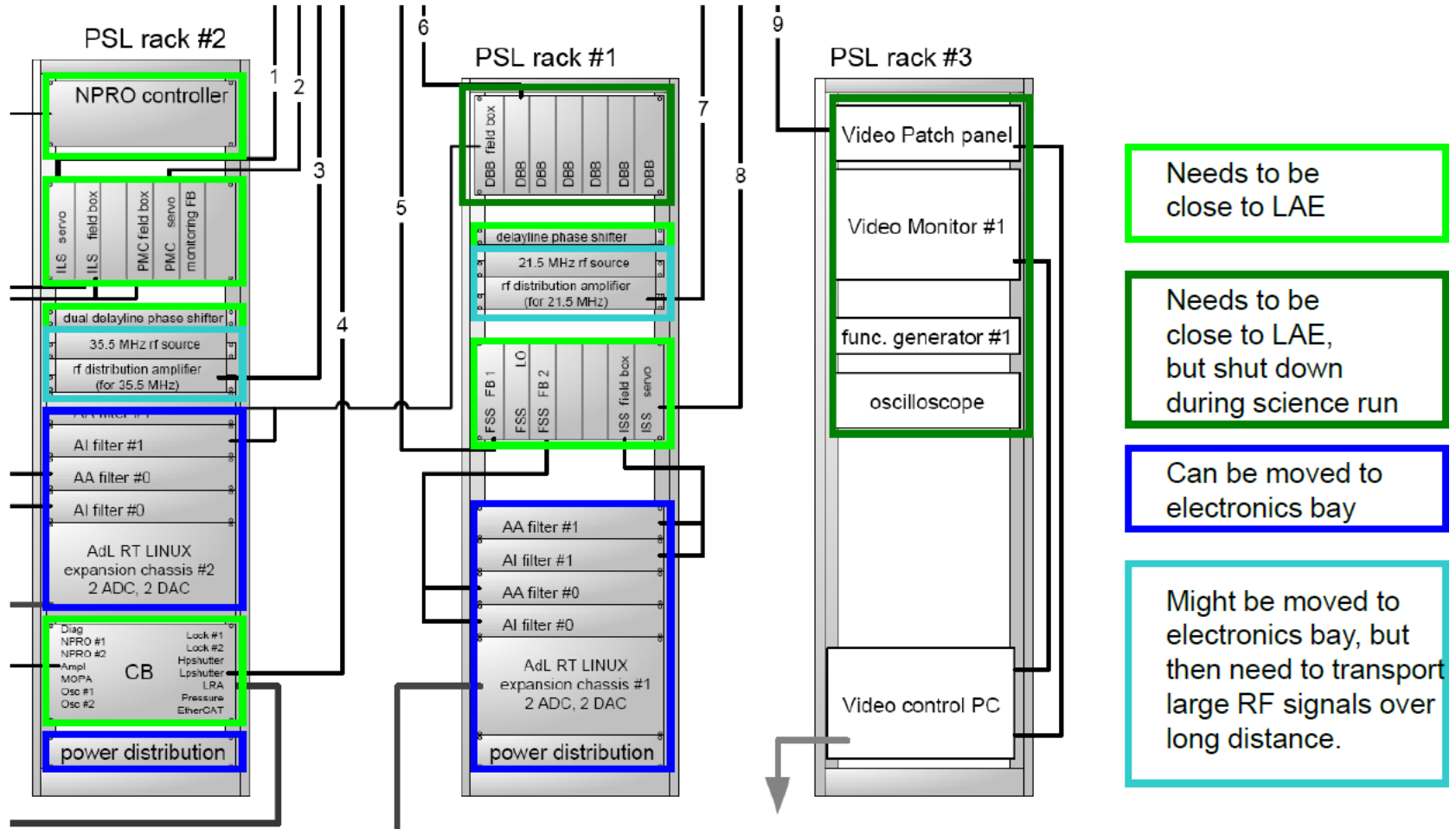



PSL RACKS - L1-PSL-01- ILS and PMC

L1-PSL-01
Front NPRO
Controller

Eurocard
Crate
ECC-1 (ILS
and PMC)

DXXXXXXXXX Delay Line Chassis

DXXXXXXXXX 35.5MHz Amplifier Chassis

DXXXXXXXXX 35.5MHz Amplifier Chassis

D1000305 AI Chassis
D1000305 AI Chassis
D0902783 AA Chassis
D0902783 AA Chassis

I/O Extension
2 ADC
2 DAC

Control Box
(CB)

NPRO
Controller

Eurocard
Crate
ECC-1 (ILS
and PMC)

DXXXXXXXXX SYYYYYYYYY

DXXXXXXXXX SYYYYYYYYY

DXXXXXXXXX SYYYYYYYYY

D1000305 SYYYYYYYYY
D1000305 SYYYYYYYYY
D0902783 SYYYYYYYYY
D0902783 SYYYYYYYYY

Control Box
(CB)

L1-PSL-01
Rear

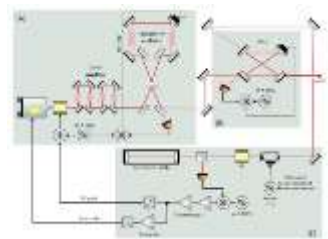

PSL Racks - L1-PSL-1-ECC-1 (ILS and PMC)

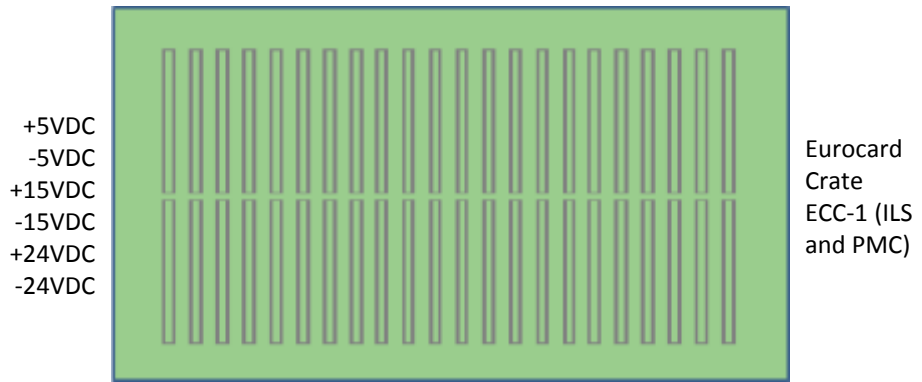
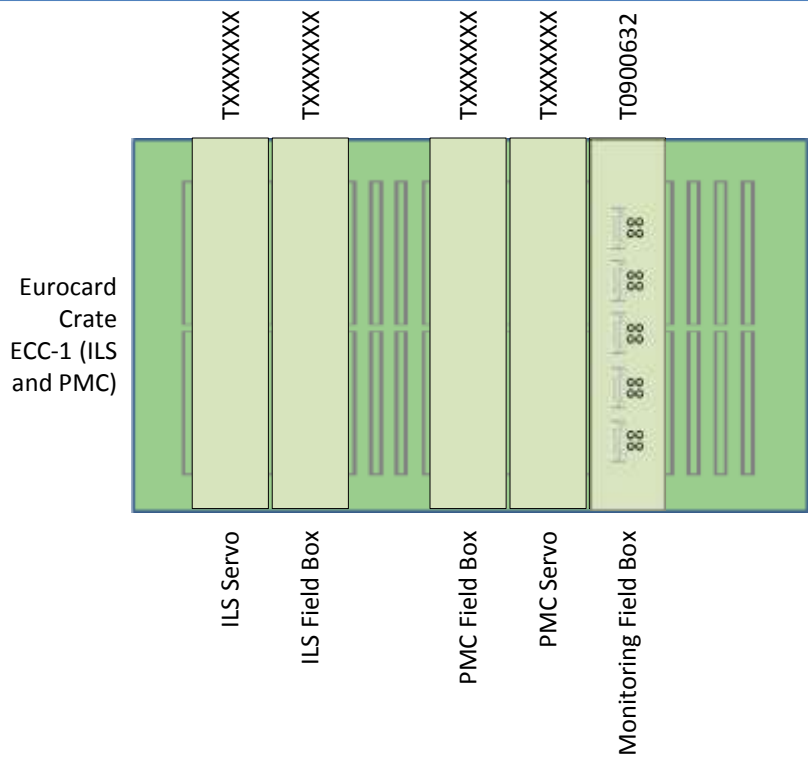



PSL RACKS - L1-PSL-02 (DBB, FSS, and ISS)

L1-PSL-02
Front Eurocard
Crate
ECC-1 (DBB)

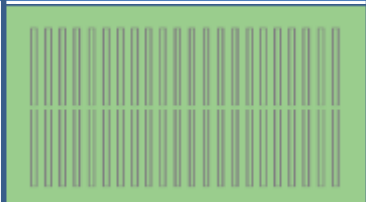

Eurocard
Crate
ECC-2 (FSS
and ISS)

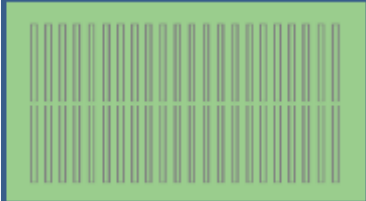

DXXXXXXXX Delay Line Chassis



DXXXXXXXX 21.5MHz Amplifier Chassis



DXXXXXXXX 21.5MHz Amplifier Chassis



D1000305 AI Chassis
D1000305 AI Chassis
D0902783 AA Chassis
D0902783 AA Chassis



I/O Extension
2 ADC
2 DAC



Frequency Stabilization Servo
Intensity Stabilization Servo
Diagnostic Breadboard

L1-PSL-02
Rear

Eurocard
Crate
ECC-1 (DBB)

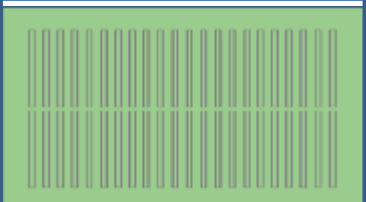

Eurocard
Crate
ECC-2 (FSS
and ISS)

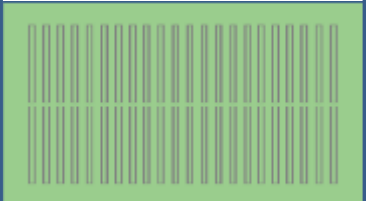

DXXXXXXXX SYYYYYYYY



DXXXXXXXX SYYYYYYYY



DXXXXXXXX SYYYYYYYY



D1000305 SYYYYYYYY
D1000305 SYYYYYYYY
D0902783 SYYYYYYYY
D0902783 SYYYYYYYY

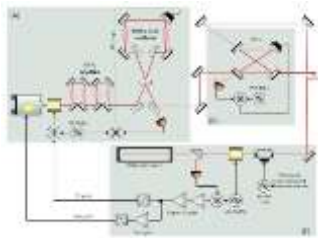
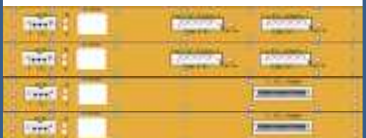

L1-PSL-02-ECC-1 (DBB)

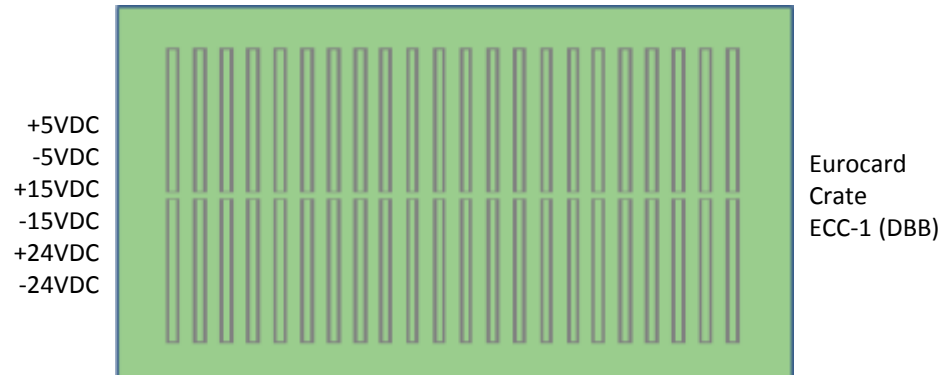
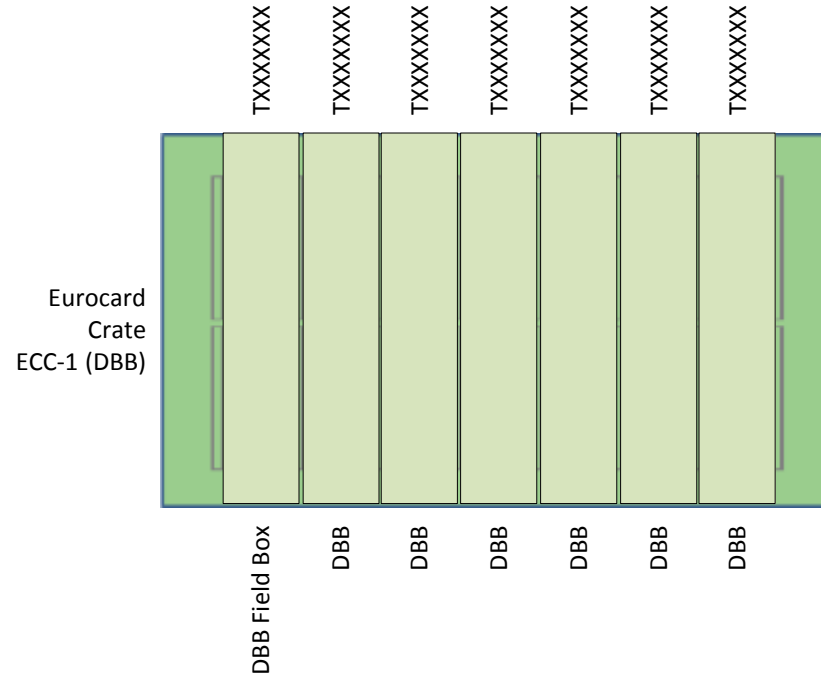

L1-PSL-02-ECC-2 (FSS and ISS)

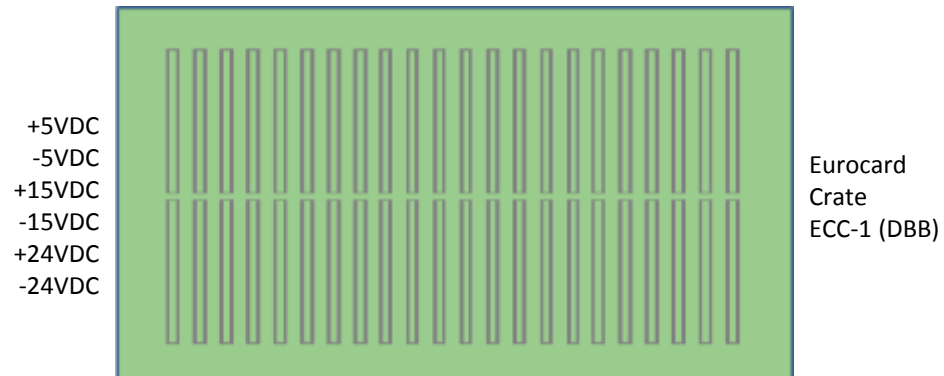
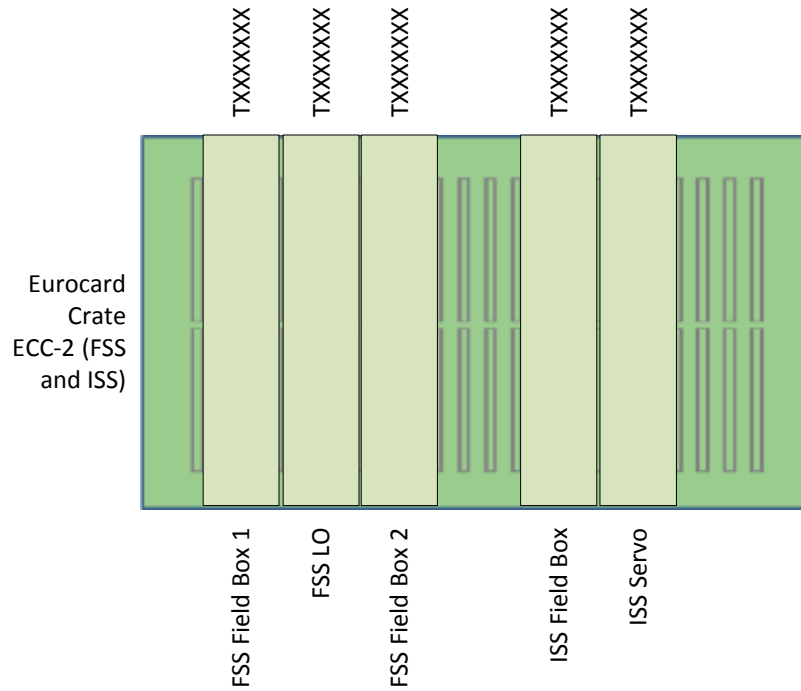



NPRO Controller

NPRO Controller

L1-PSL-01 Front

L1-PSL-01 Rear

Eurocard Crate ECC-1 (DBB)

Eurocard Crate ECC-1 (DBB)

Eurocard Crate ECC-2 (FSS and ISS)

Eurocard Crate ECC-2 (FSS and ISS)

Eurocard Crate ECC-3 (ILS and PMC)

Eurocard Crate ECC-3 (ILS and PMC)

DXXXXXXXXX Delay Line Chassis

DXXXXXXXXX SYYYYYYYY

DXXXXXXXXX 21.5MHz Amplifier Chassis

DXXXXXXXXX SYYYYYYYY

DXXXXXXXXX 21.5MHz Amplifier Chassis

DXXXXXXXXX SYYYYYYYY

DXXXXXXXXX Delay Line Chassis

DXXXXXXXXX SYYYYYYYY

DXXXXXXXXX 35.5MHz Amplifier Chassis

DXXXXXXXXX SYYYYYYYY

DXXXXXXXXX 35.5MHz Amplifier Chassis

DXXXXXXXXX SYYYYYYYY

Control Box (CB)

Control Box (CB)

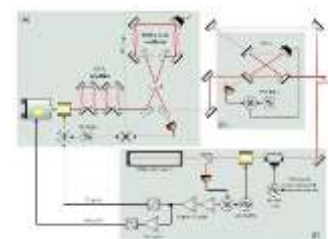

LDR Rack 1 Layout (Dxxxxxxx)



LDR Rack 2 Layout (Dxxxxxxx)

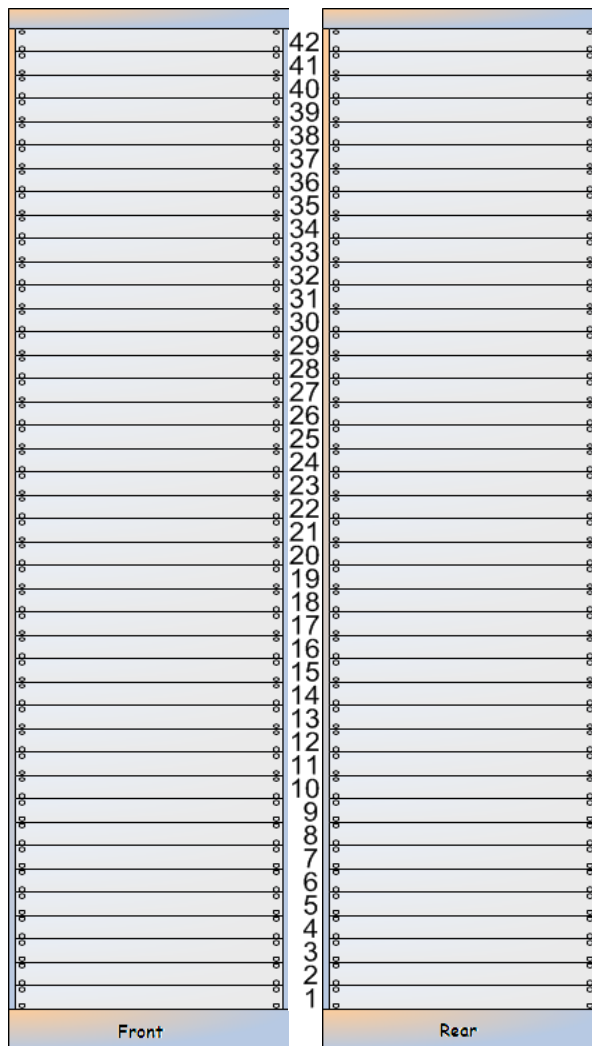

LDR Rack 3 Layout (Chillers) (Dxxxxxxx)

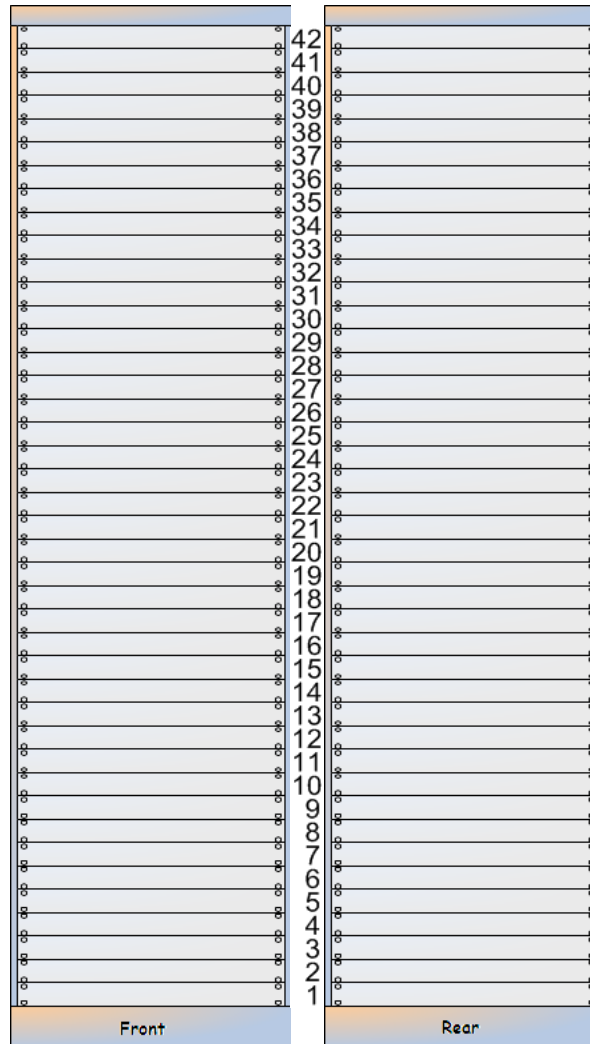

Spare Chiller

[<< LDR](#)

LDR Rack 4 Layout (Chillers) (Dxxxxxxx)

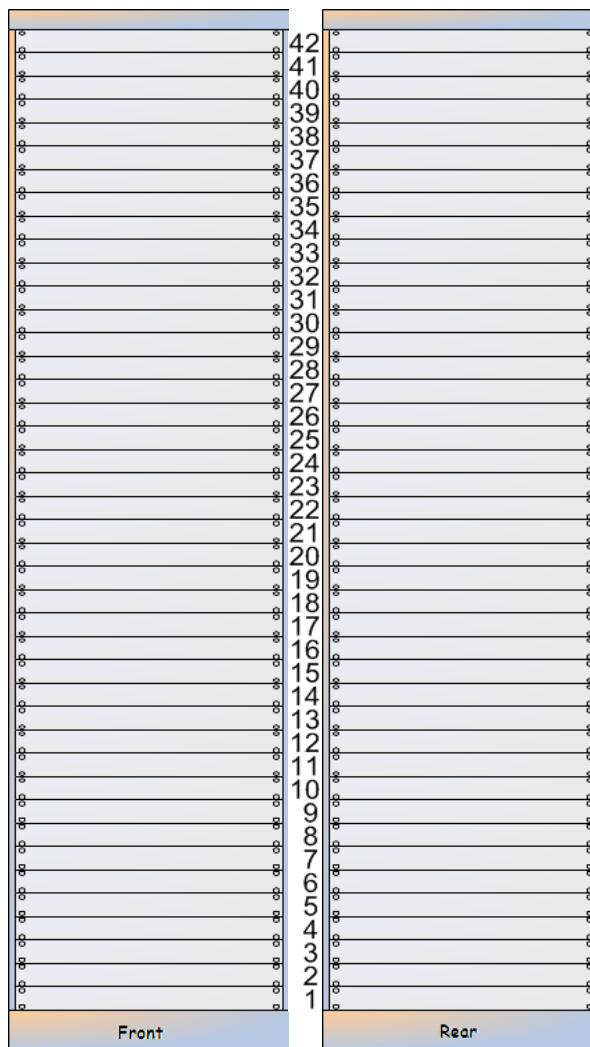

Subsystem: SEI (Seismic Isolation)

<< LLO Racks by Subsystem

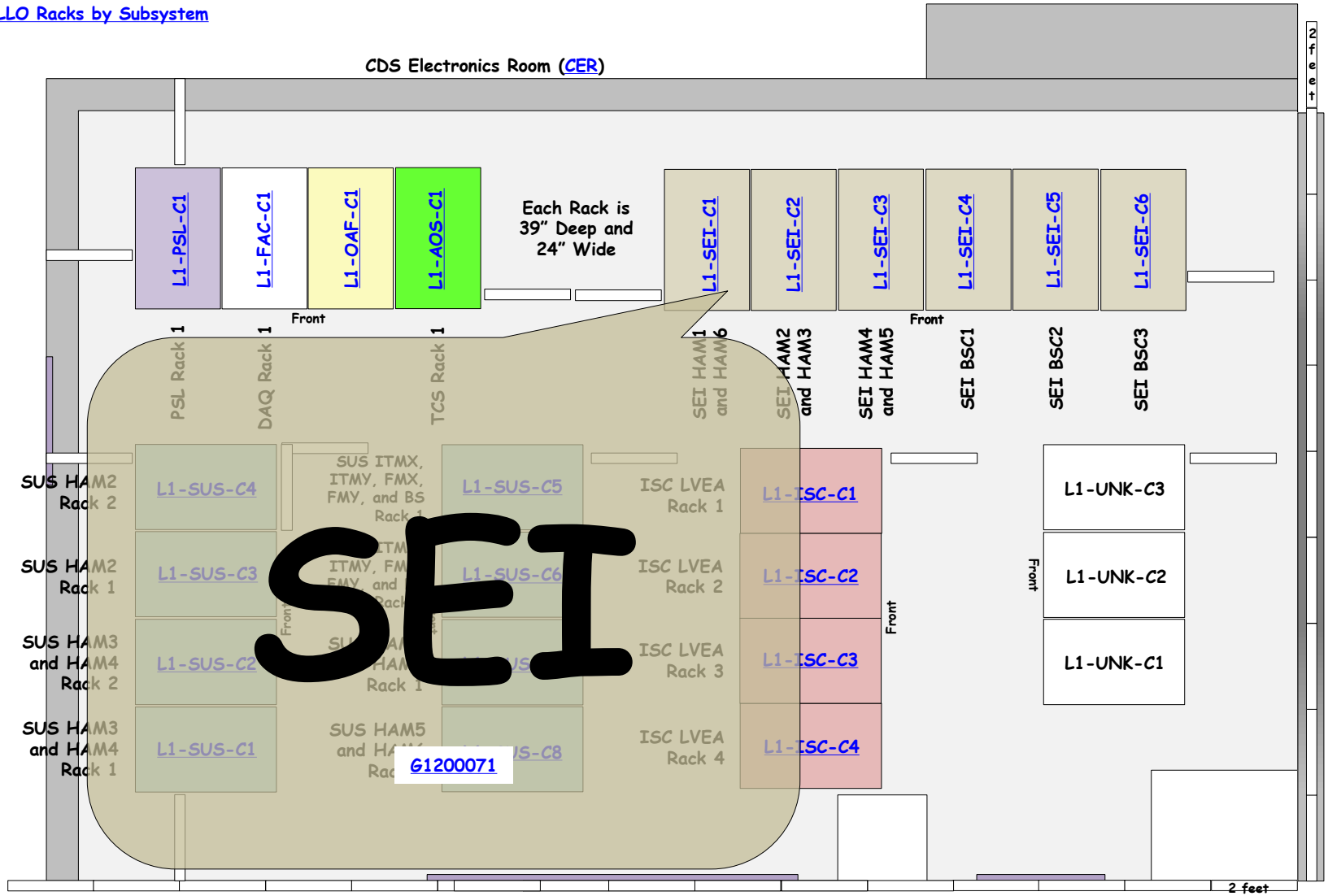

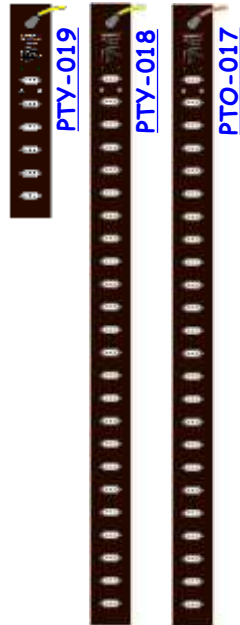
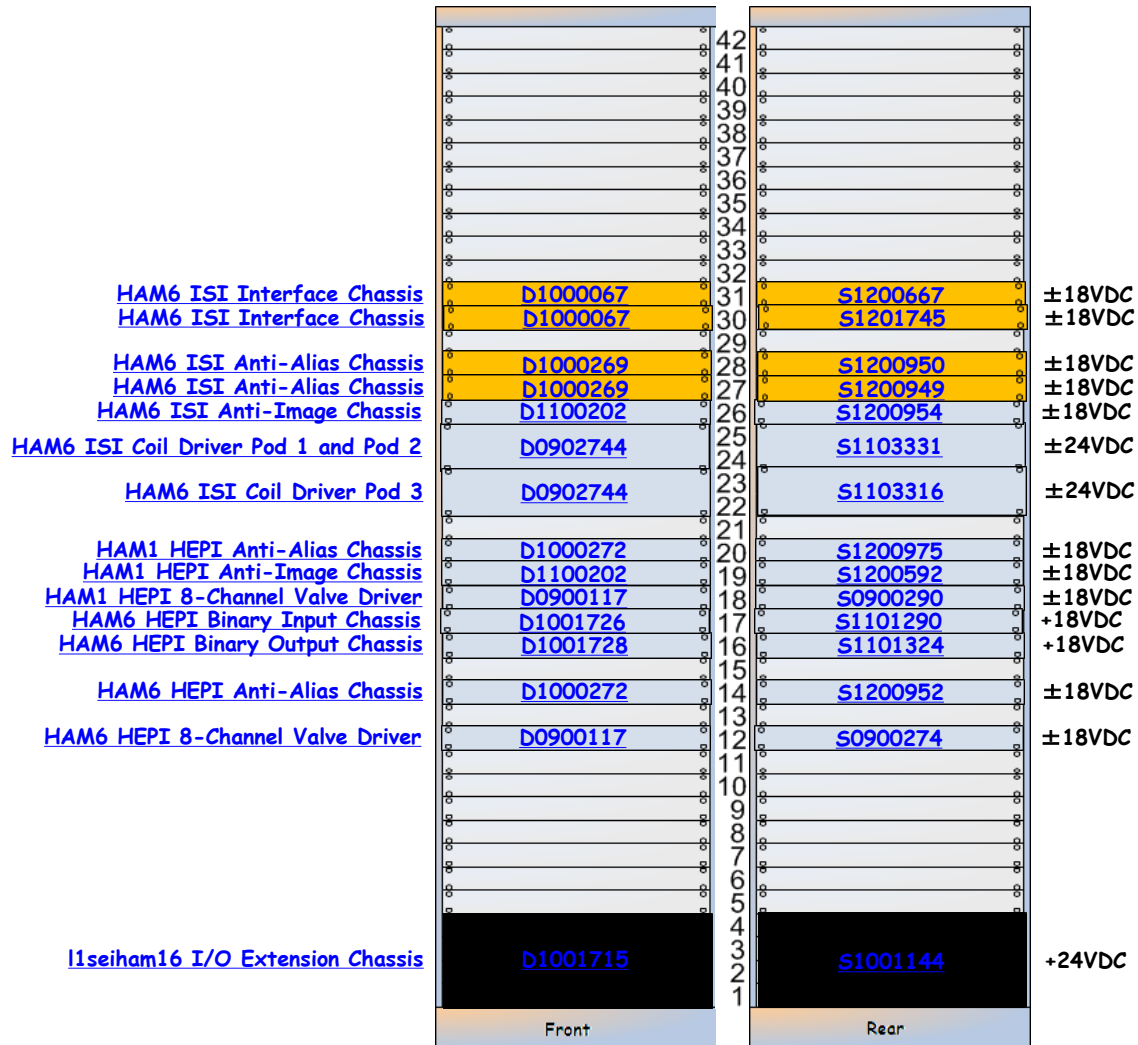

SEI-C1 is part of [D1101584](#)

L1-SEI-C1 Details

SEI-C1 is part of [D1101584](#)



[D1000067](#)

Front

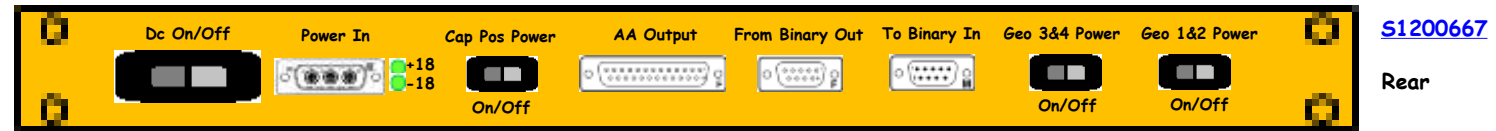

[S1200667](#)

Rear

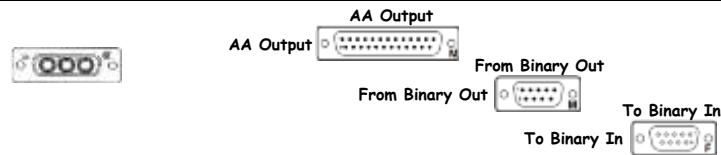



[D1000067](#)

Front

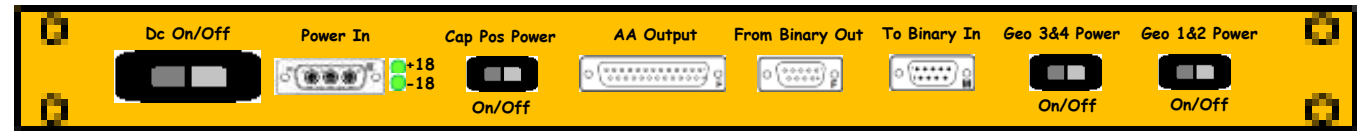

[S1201745](#)

Rear

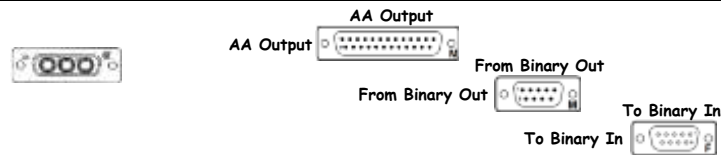

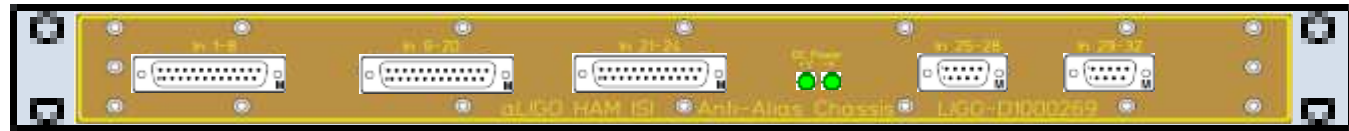

D1000269

Front

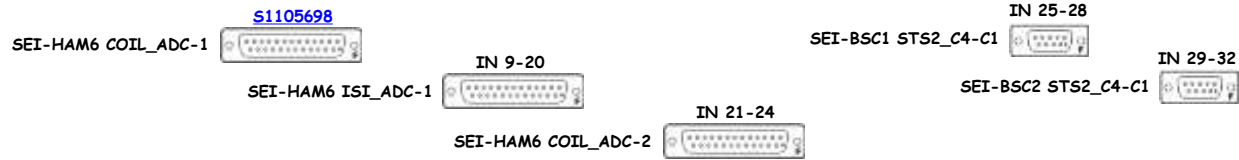

S1200950

Rear

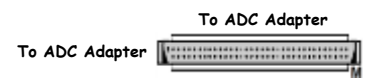

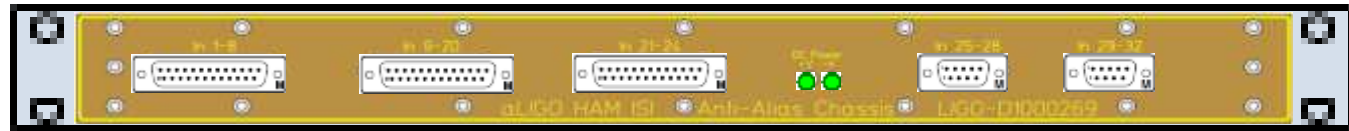

D1000269

Front

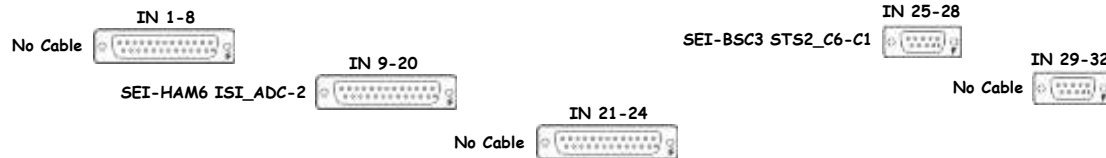

S1200949

Rear

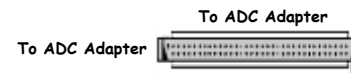

D1100202 - S1200954



<< L1-SEI-C1

HAM6 ISI Anti-Image Chassis D1100202 S1200954 ±18VDC

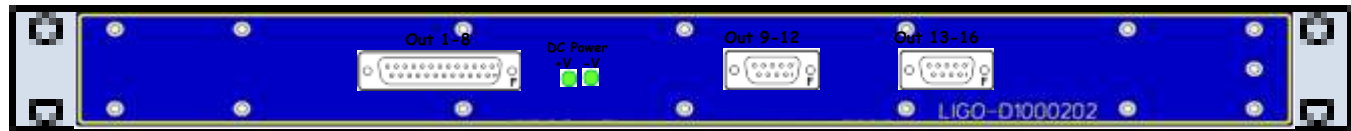

D1100202

Front



S1200954

Rear

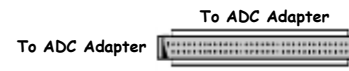

<< L1-SEI-C1

HAM6 ISI Coil Driver Pod 1 and Pod 2

D0902744

S1103331

±24VDC



D0902744

Front



S1103331

Rear

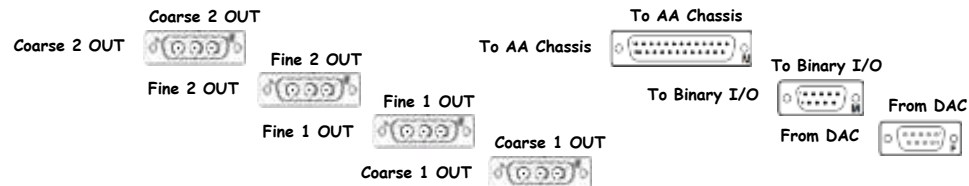

<< L1-SEI-C1

HAM6 ISI Coil Driver Pod 1 and Pod 2

D0902744

S1103316

±24VDC



D0902744

Front



S1103316

Rear

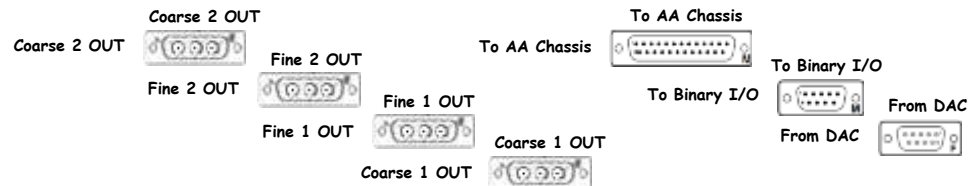



D1000272

Front

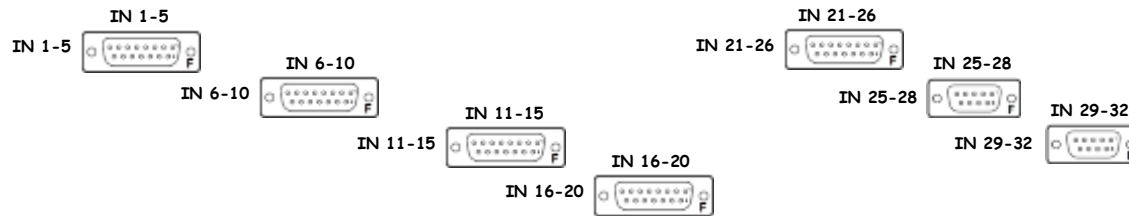

S1200975

Rear

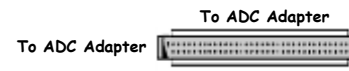

D1100202 - S1200592

HAM1 HEPI Anti-Image Chassis D1100202 S1200592 ±18VDC

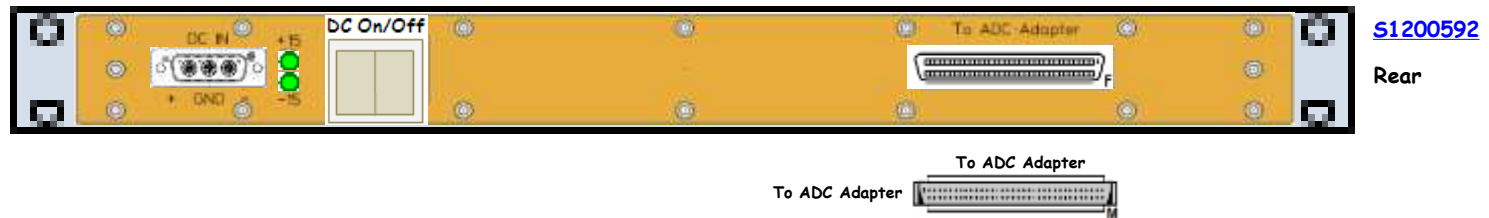
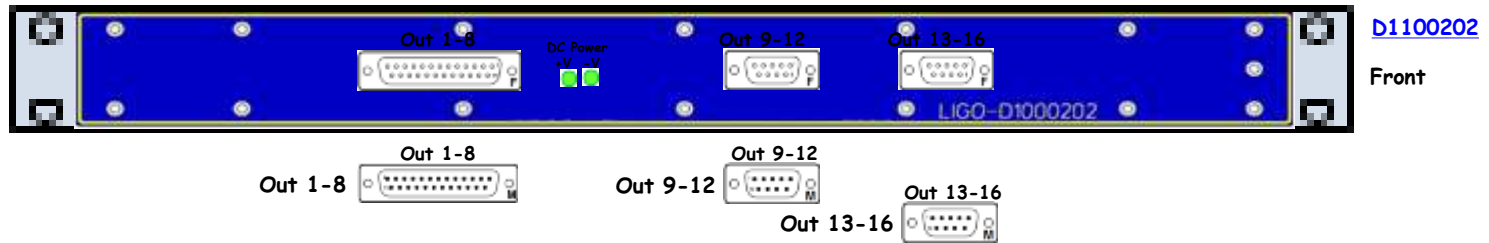



[D0900117](#)

Front

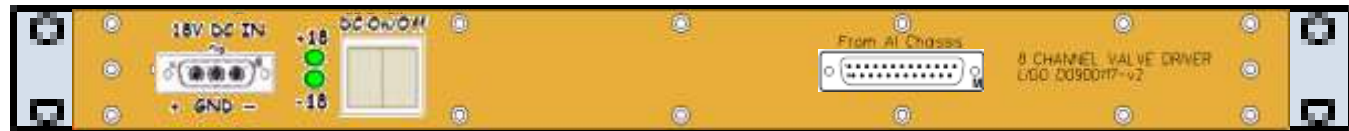
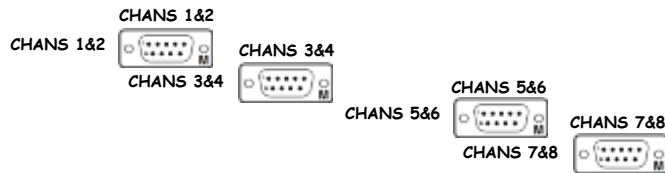

[S0900274](#)

Rear



[D0900117](#) is part of [D0901338](#)



D1001726

Front

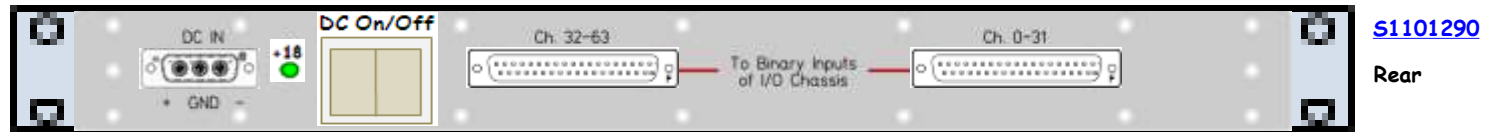
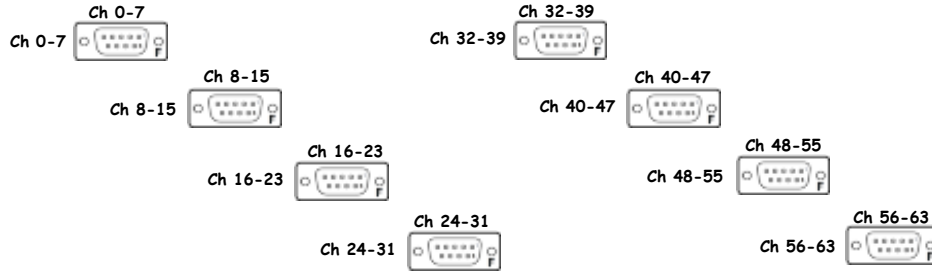

S1101290

Rear



HAM6 HEPI Binary Output Chassis D1001728 S1101324 +18VDC

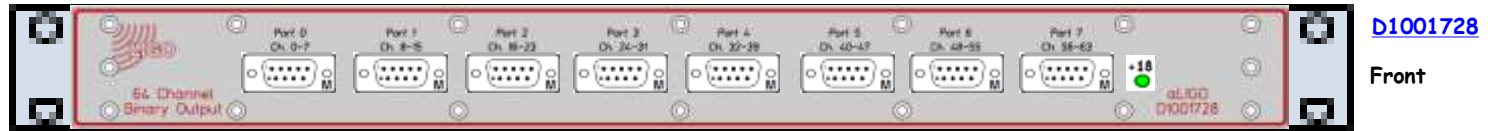

D1001728

Front

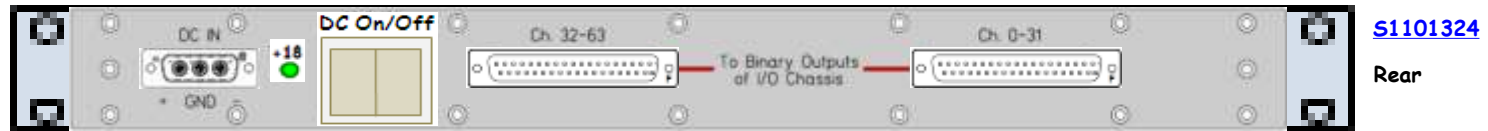
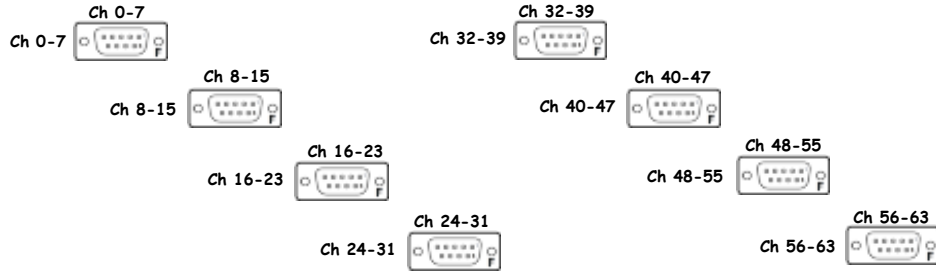

S1101324

Rear





D1000272

Front

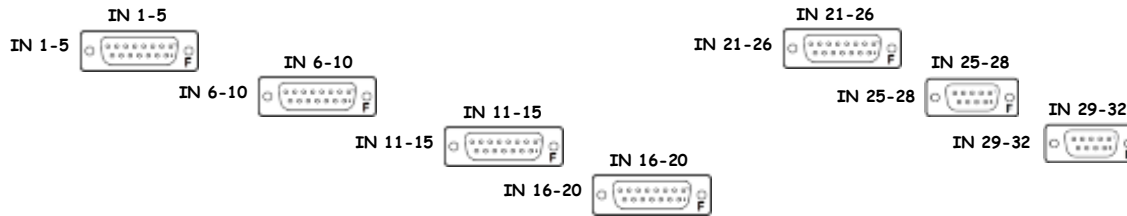

S1200952

Rear

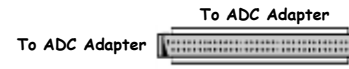



D0900117

Front

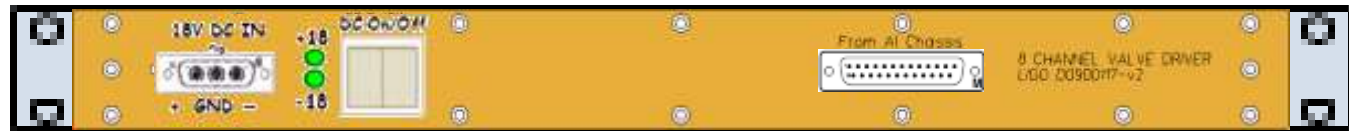
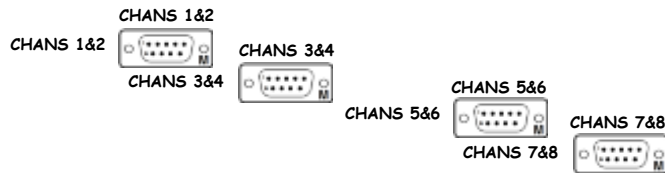

S0900274

Rear



[D0900117](#) is part of [D0901338](#)

<< L1-SEI-C1

I1seiham16 I/O Extension Chassis

D1001715

S1001144

+24VDC

D1001715

Front

Timing Slot

I1seiham16 is part of D1400014

I1seiham16 – I/O Extender

S1001144

Rear

Uplink  L1:FE-IO-07

Slot E1  Open

Slot E2  Open

Slot E3  Open

Slot P1  Open

Slot P2  Open

Slot P3  Open

Slot P4  Open

Slot P5  Open

Slot P6  Open

Slot P7  Open

Slot P8  Open

Slot P9  Open

Slot P10  Open

L1:FE-IO-07

Binary IO Card

ADC Card

DAC16 Card

ADC Card

ADC Card

DAC16 Card

Slot P10

Slot P9

Slot P8

Slot P7

Slot P6

Slot P5

Slot P4

Slot P3

Slot P2

Slot P1

Slot E3

Slot E2

Slot E1

PTY-019

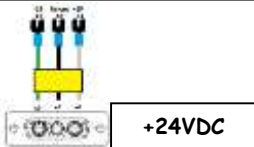

+24VDC

HAM2 ISI Interface Chassis	D1000067	42	S1107434	±18VDC
HAM2 ISI Interface Chassis	D1000067	41	S1107435	±18VDC
		40		
HAM2 ISI Anti-Alias Chassis	D1000269	39	S1104621	±18VDC
HAM2 ISI Anti-Alias Chassis	D1000269	38	S1104638	±18VDC
HAM2 HEPI Anti-Image Chassis	D1100202	37	S1104572	±18VDC
HAM2 ISI Coil Driver Pod 1 and Pod 2	D0902744	36	S1103300	±24VDC
		35		
HAM2 ISI Coil Driver Pod 3	D0902744	34	S1103332	±24VDC
		33		
		32		
HAM3 ISI Interface Chassis	D1000067	31	S1107436	±18VDC
HAM3 ISI Interface Chassis	D1000067	30	S1200668	±18VDC
		29		
HAM3 ISI Anti-Alias Chassis	D1000269	28	S1104632	±18VDC
HAM3 ISI Anti-Alias Chassis	D1000269	27	S1104635	±18VDC
HAM3 HEPI Anti-Image Chassis	D1100202	26	S1104573	±18VDC
HAM3 ISI Coil Driver Pod 1 and Pod 2	D0902744	25	S1103306	±24VDC
		24		
HAM3 ISI Coil Driver Pod 3	D0902744	23	S1103304	±24VDC
		22		
		21		
HAM2 HEPI Anti-Alias Chassis	D1000272	20	S1104616	±18VDC
		19		
HAM2 HEPI 8-Channel Valve Driver	D0900117	18	S0900275	±18VDC
HAM2 HEPI Binary Input Chassis	D1001726	17	S1101286	+18VDC
HAM2/3 HEPI Binary Output Chassis	D1001728	16	S1101321	+18VDC
		15		
HAM3 HEPI Anti-Alias Chassis	D1000272	14	S1104615	±18VDC
		13		
HAM3 HEPI 8-Channel Valve Driver	D0900117	12	S0900291	±18VDC
		11		
		10		
		9		
		8		
		7		
		6		
		5		
		4		
11seiham23 I/O Extension Chassis	D1001715	3	S1001145	+24VDC
		2		
		1		

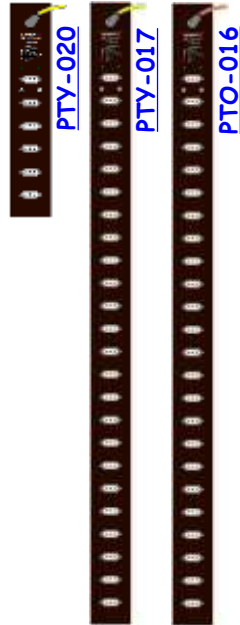

SEI-C2 is part of [D1101576](#)

Front

Rear

L1-SEI-C2 Details

SEI-C2 is part of [D1101576](#)



D1000067

Front

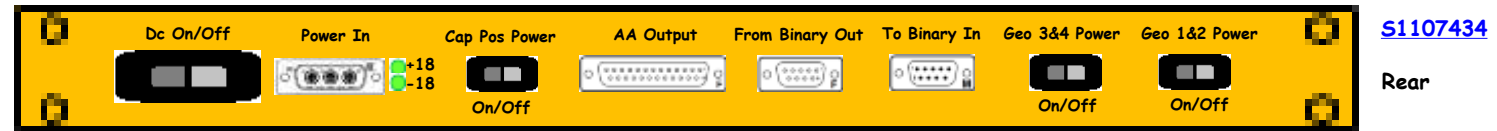

S1107434

Rear

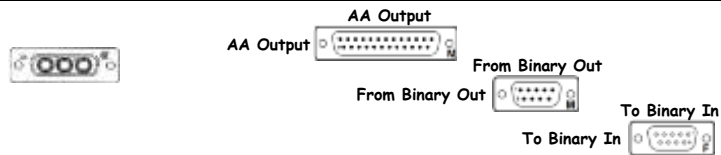



D1000067

Front

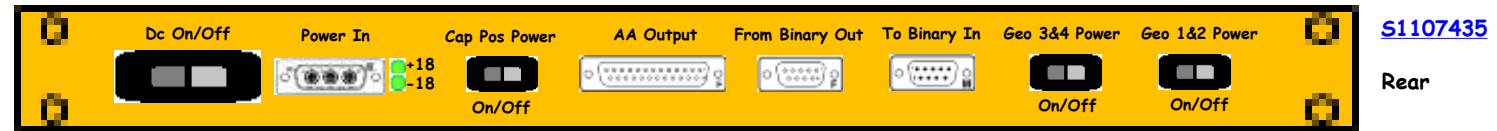

S1107435

Rear

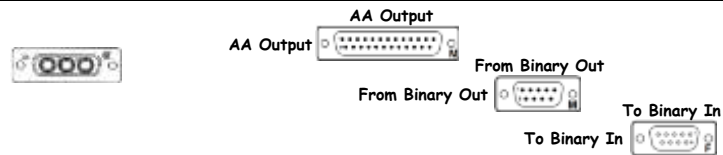

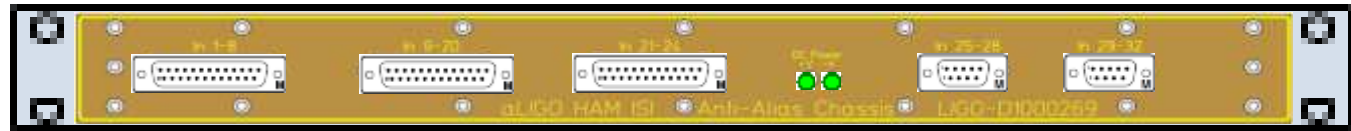

D1000269

Front

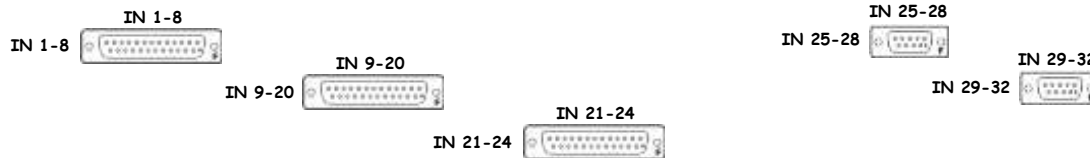

S1104621

Rear

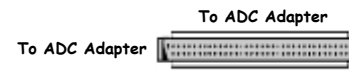

D1000269 - S1104638



<< L1-SEI-C2

HAM2 ISI Anti-Alias Chassis

D1000269

S1104638

±18VDC

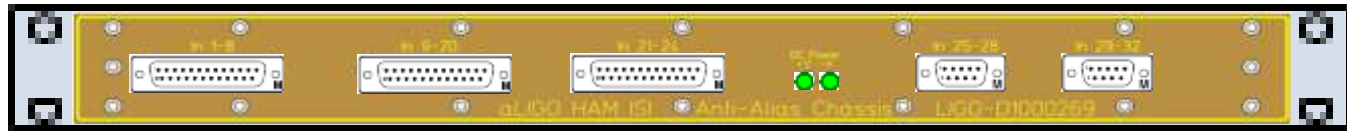

D1000269

Front

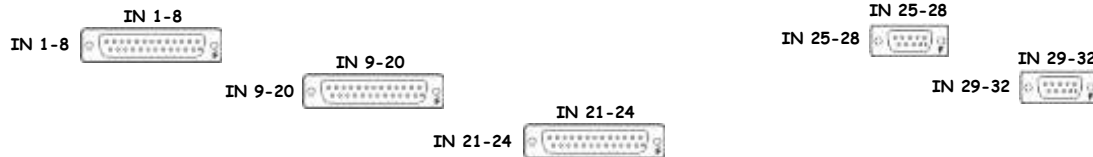

S1104638

Rear

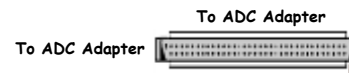

HAM2 HEPI Anti-Image Chassis D1100202 S1104572 ±18VDC

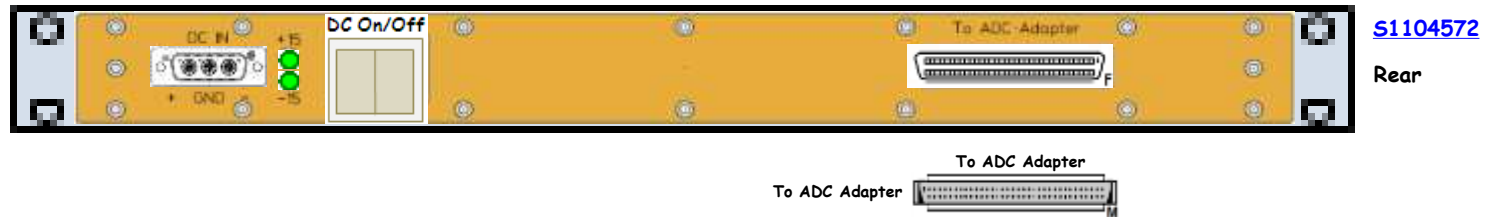
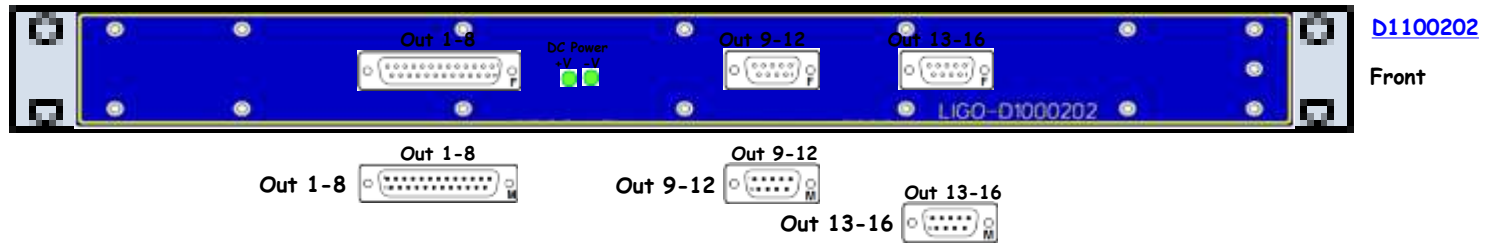



D0902744

Front



S1103300

Rear

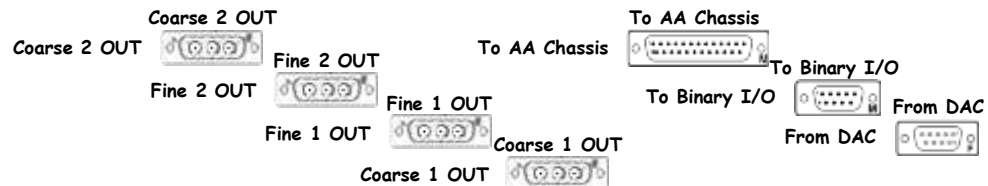



D0902744

Front

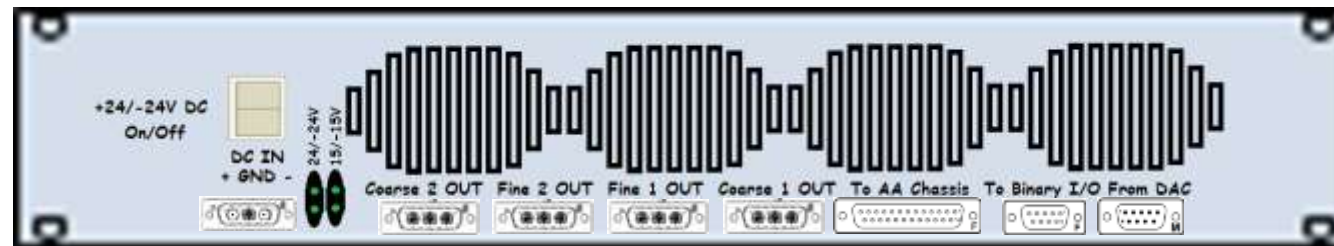

S1103332

Rear

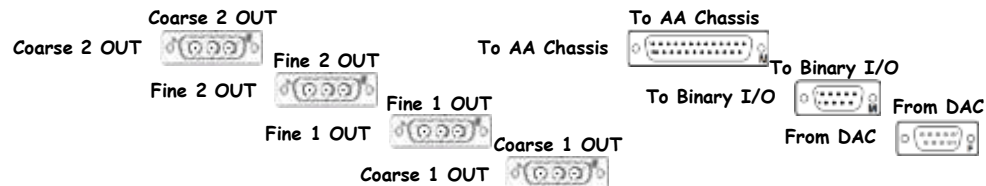



[D1000067](#)

Front

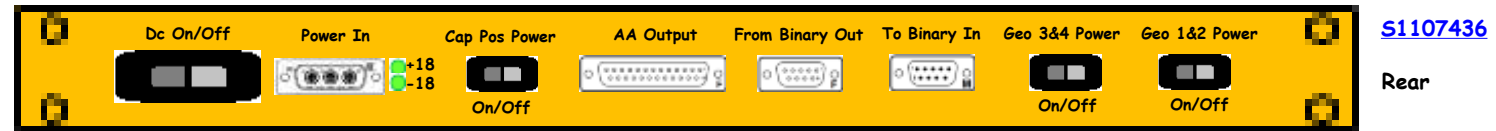

[S1107436](#)

Rear

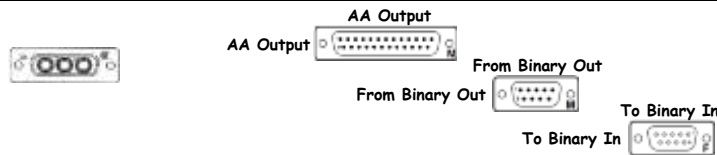

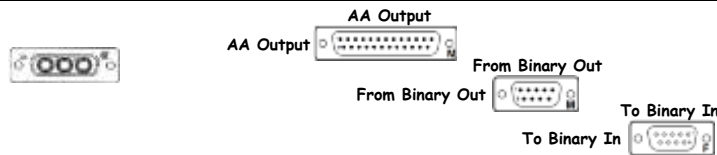
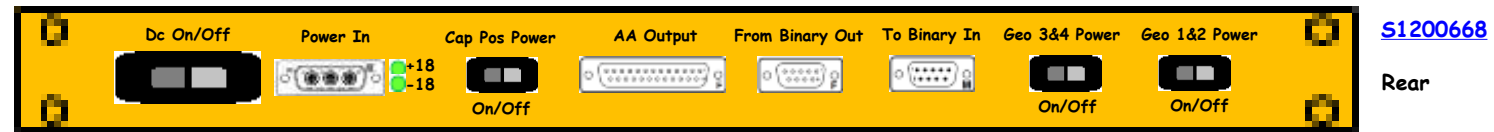

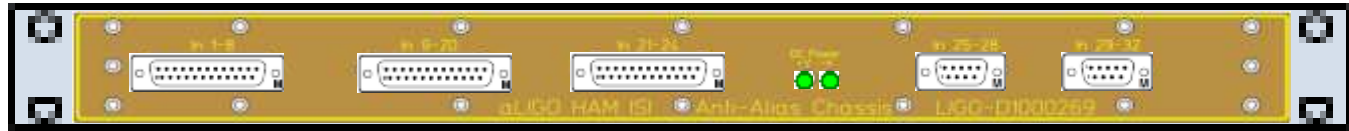

D1000269

Front

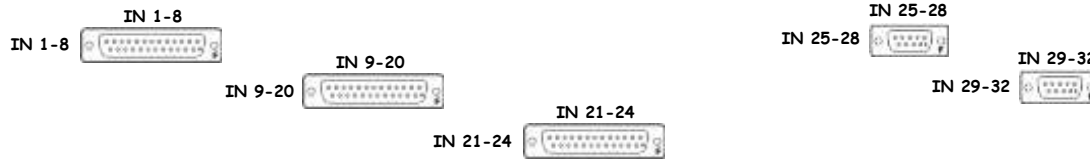

S1104632

Rear

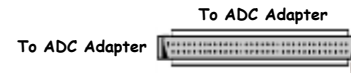

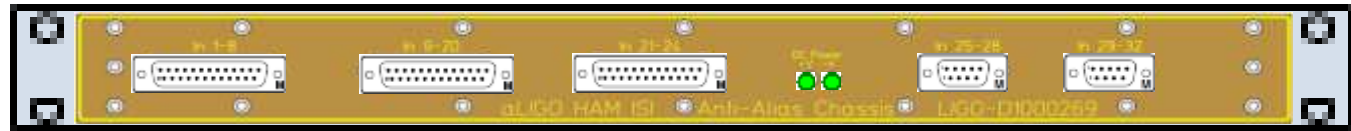

D1000269

Front

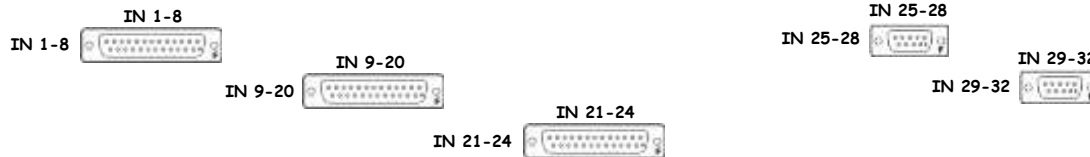

S1104635

Rear

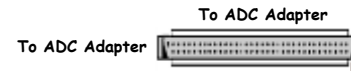

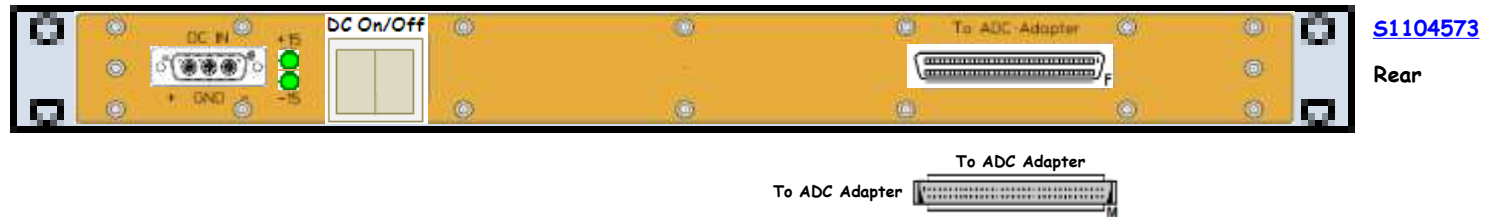
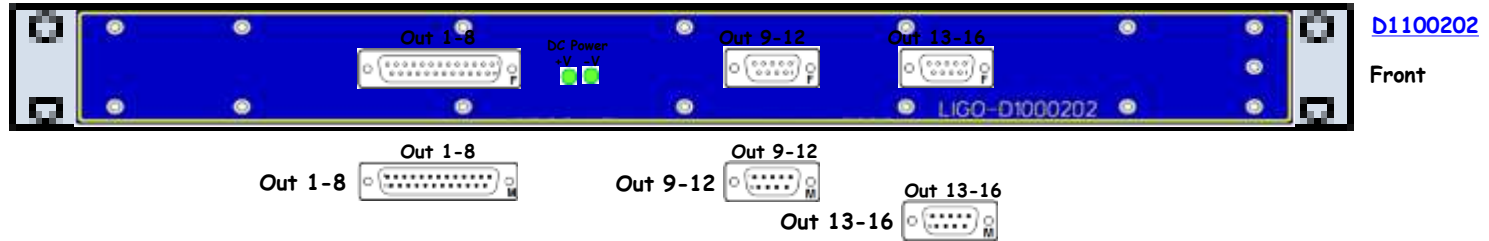



D0902744

Front

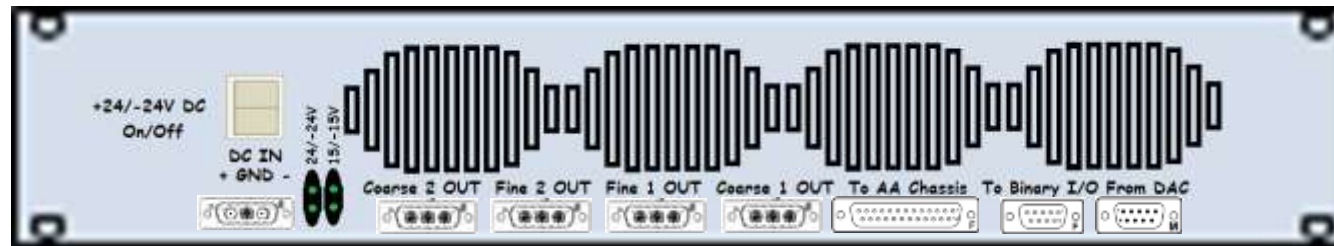

S1103306

Rear

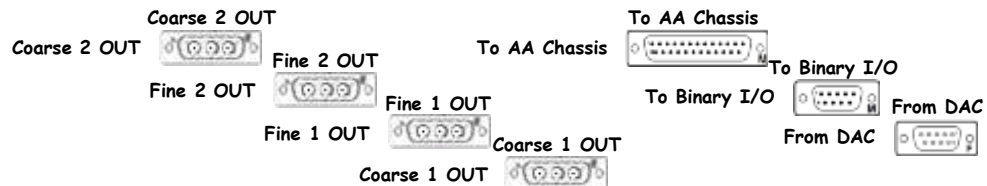



D0902744

Front

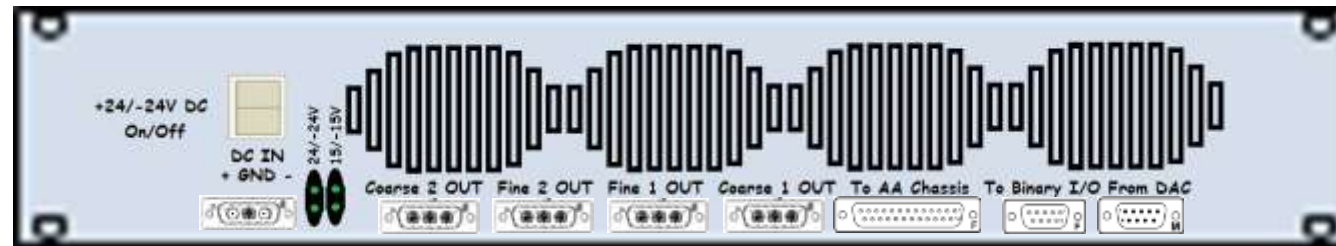

S1103304

Rear

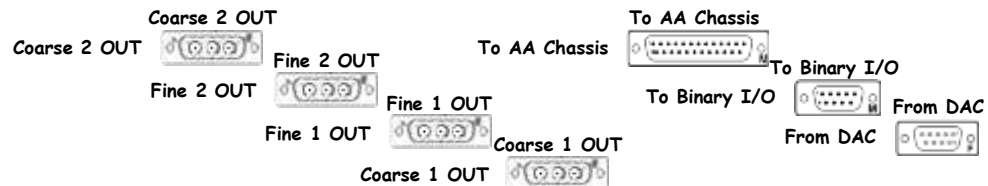



D1000272

Front

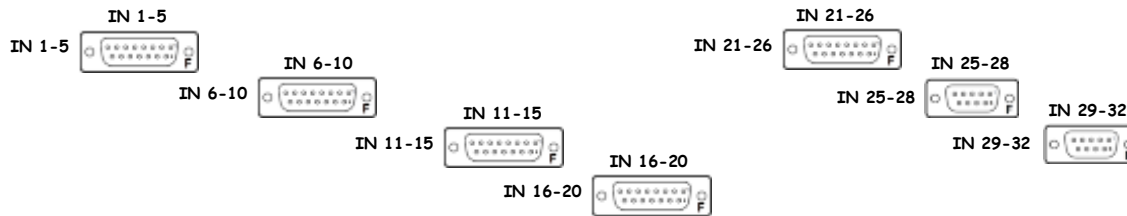

S1104616

Rear

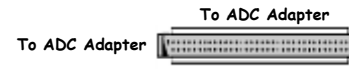



D0900117

Front

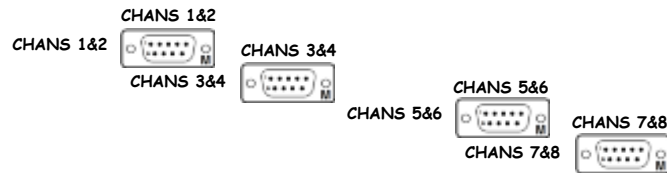

S0900275

Rear



[D0900117](#) is part of [D0901338](#)



D1001726

Front

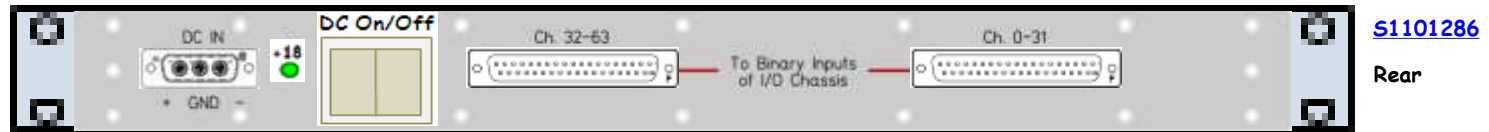
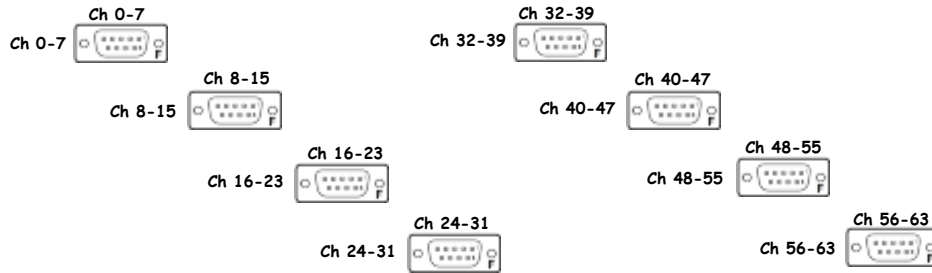

S1101286

Rear



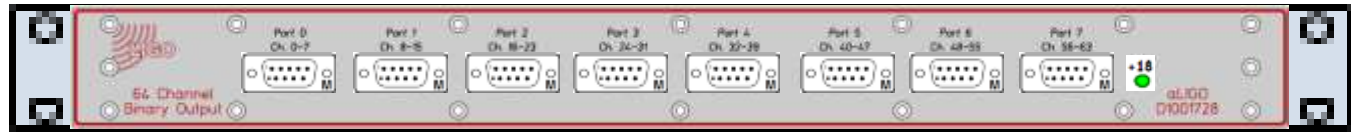

D1001728

Front

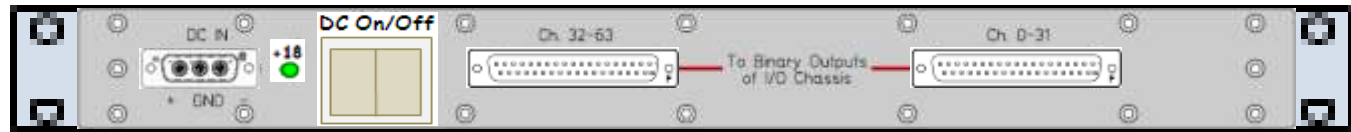
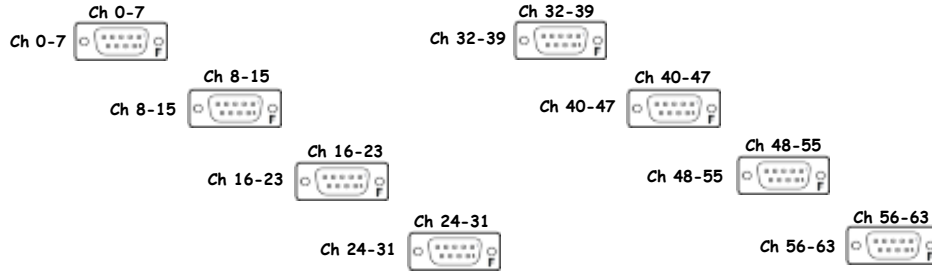

S1101321

Rear





D1000272

Front

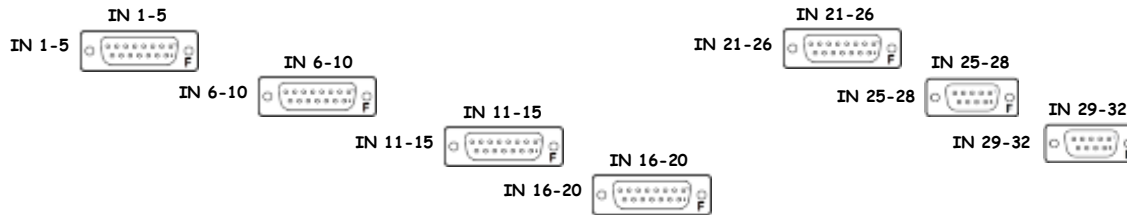

S1104615

Rear

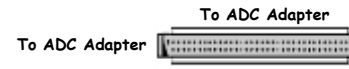

D0900117 - S0900291



<< L1-SEI-C2

HAM3 HEPI 8-Channel Valve Driver ±18VDC

HAM3



D0900117

Front

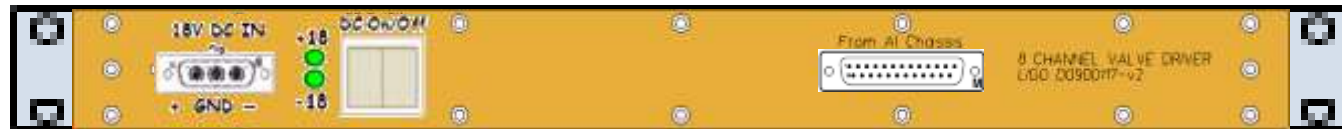
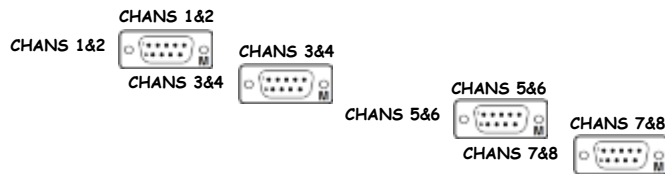

S0900291

Rear



[D0900117](#) is part of [D0901338](#)

I1seiham23 - I/O Extension Chassis

D1001715

S1001145

+24VDC

D1001715

Front

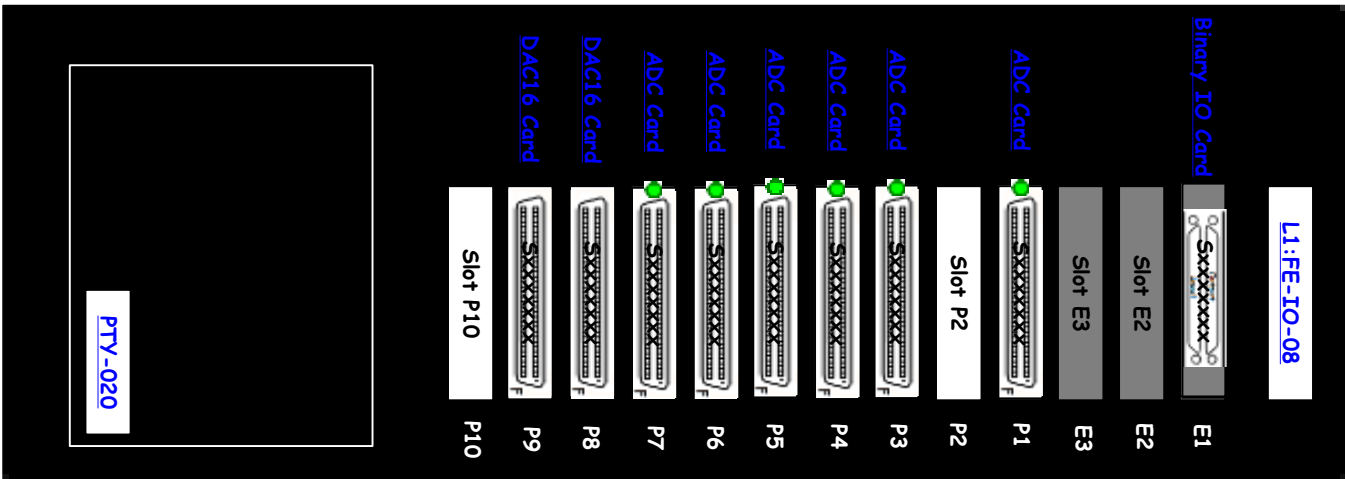
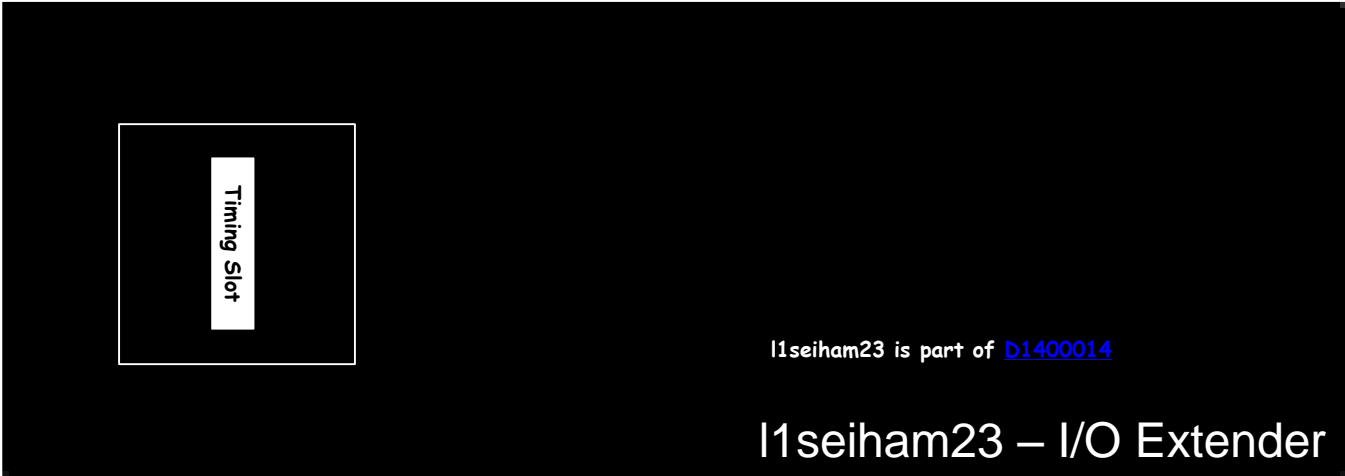

S1001145

Rear

Uplink		L1:FE-IO-08
Slot E1		Open
Slot E2		Open
Slot E3		Open
Slot P1		Open
Slot P2		Open
Slot P3		Open
Slot P4		Open
Slot P5		Open
Slot P6		Open
Slot P7		Open
Slot P8		Open
Slot P9		Open
Slot P10		Open



HAM4 ISI Interface Chassis Pod 1	D1002432	42	S1107866	±18VDC
HAM4 ISI Interface Chassis Pod 2	D1002432	41	S1107867	±18VDC
HAM4 ISI Interface Chassis Pod 3	D1002432	40	S1107868	±18VDC
		39		
HAM4 ISI Anti-Alias Chassis	D1000269	38	S1200313	±18VDC
HAM4 ISI Anti-Alias Chassis	D1000269	37	S1107529	±18VDC
HAM4 HEPI Anti-Image Chassis	D1100202	36	S1200319	±18VDC
HAM4 ISI Coil Driver Pod 1 and Pod 2	D0902744	35	S1103308	±24VDC
		34		
HAM4 ISI Coil Driver Pod 3	D0902744	33	S1103325	±24VDC
		32		
		31		
HAM5 ISI Interface Chassis Pod 1	D1002432	30	S1107869	±18VDC
HAM5 ISI Interface Chassis Pod 2	D1002432	29	S1107870	±18VDC
HAM5 ISI Interface Chassis Pod 3	D1002432	28	S1107871	±18VDC
		27		
HAM5 ISI Anti-Alias Chassis	D1000269	26	S1107530	±18VDC
HAM5 ISI Anti-Alias Chassis	D1000269	25	S1107531	±18VDC
HAM5 HEPI Anti-Image Chassis	D1100202	24	S1200318	±18VDC
HAM5 ISI Coil Driver Pod 1 and Pod 2	D0902744	23	S1103326	±24VDC
		22		
HAM5 ISI Coil Driver Pod 3	D0902744	21	S1103324	±24VDC
		20		
		19		
HAM4 HEPI Anti-Alias Chassis	D1000272	18	S1200310	±18VDC
		17		
HAM4 HEPI 8-Channel Valve Driver	D0900117	16	S0900266	±18VDC
HAM4 HEPI Binary Input Chassis	D1001726	15	S1101288	+18VDC
HAM4/5 HEPI Binary Output Chassis	D1001728	14	S1101323	+18VDC
		13		
HAM5 HEPI Anti-Alias Chassis	D1000272	12	S1200311	±18VDC
		11		
HAM5 HEPI 8-Channel Valve Driver	D0900117	10	S0900272	±18VDC
HAM5 HEPI Binary Input Chassis	D1001726	9	S1101289	+18VDC
		8		
		7		
		6		
		5		
		4		
l1seiham45 - I/O Extension Chassis	D1001715	3	S1001146	+24VDC
		2		
		1		

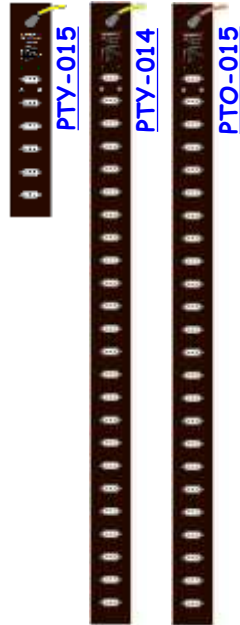

SEI-C3 is part of [D1000298](#)

Front

Rear

L1-SEI-C3 Details

SEI-C3 is part of [D1000298](#)

D1002432 - S1107866



<< L1-SEI-C3

HAM4 ISI Interface Chassis Pod 1 D1002432 S1107866 ±18VDC

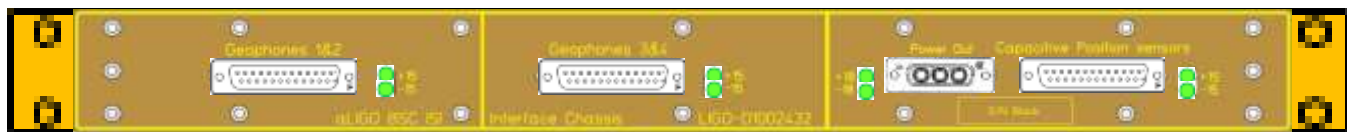

[D1002432](#)

Front

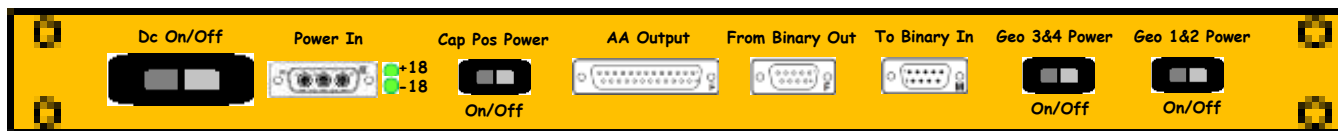

[S1107866](#)

Rear

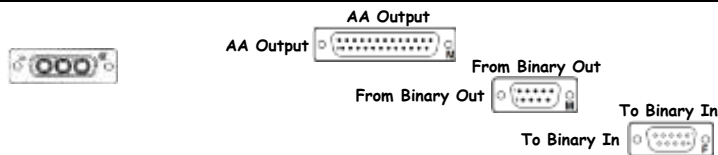

D1002432 - S1107867



<< L1-SEI-C3

HAM4 ISI Interface Chassis Pod 2 D1002432 S1107867 ±18VDC

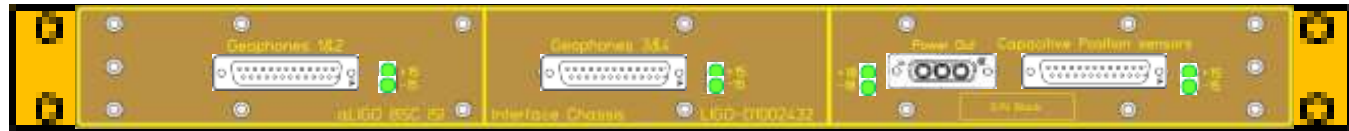

[D1002432](#)

Front

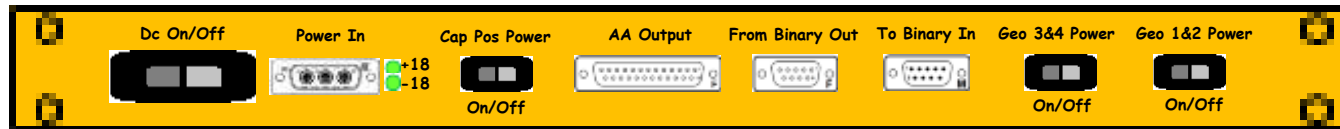

[S1107867](#)

Rear

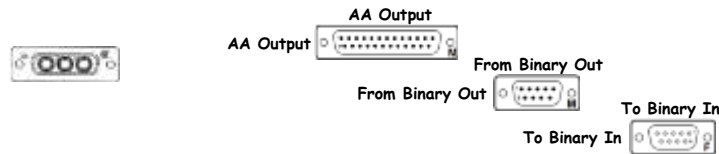

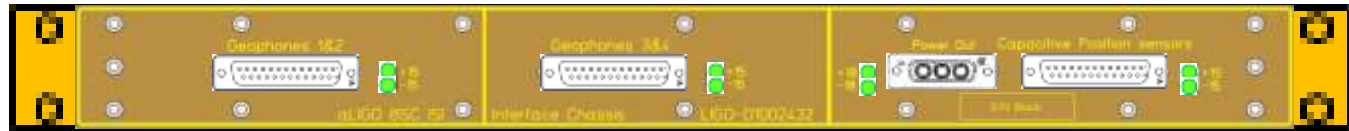

[D1002432](#)

Front

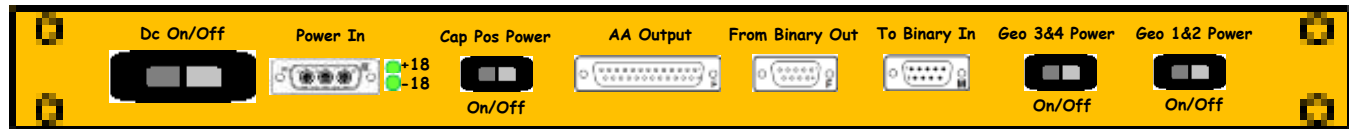

[S1107868](#)

Rear

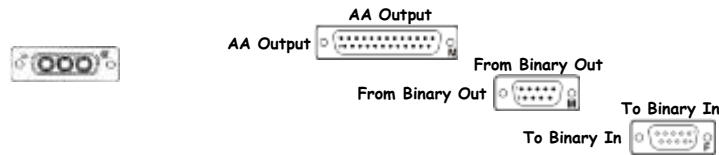

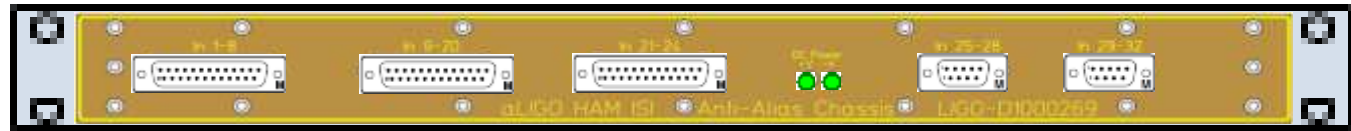

D1000269

Front

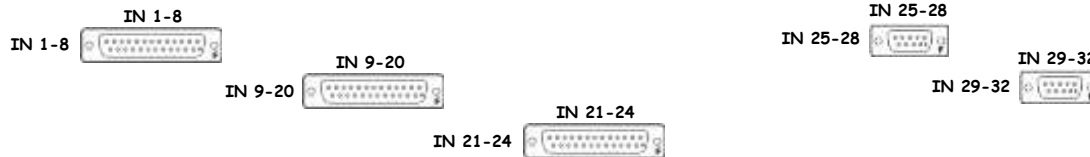

S1200313

Rear

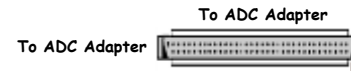

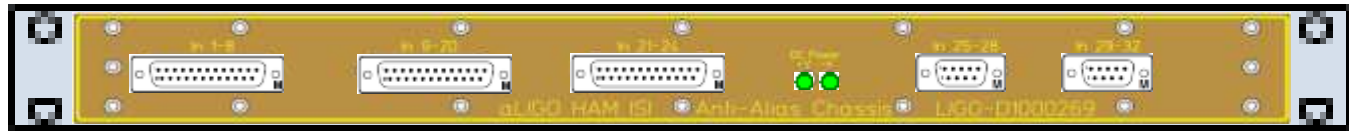

D1000269

Front

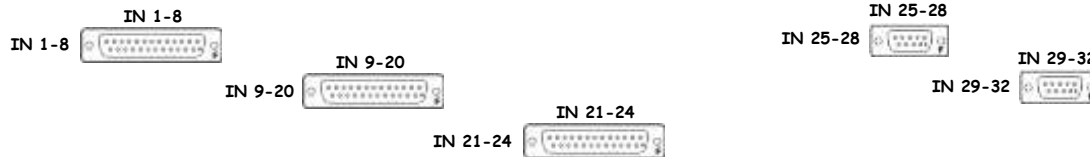

S1107529

Rear

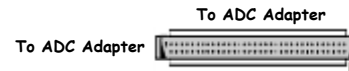

HAM4 HEPI Anti-Image Chassis D1100202 S1200319 ±18VDC

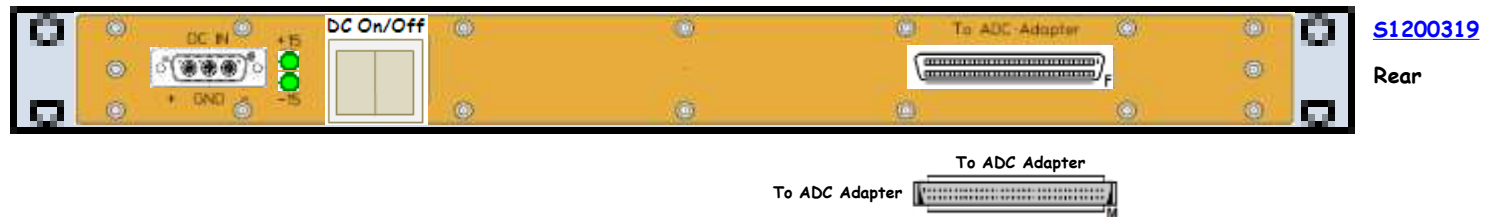
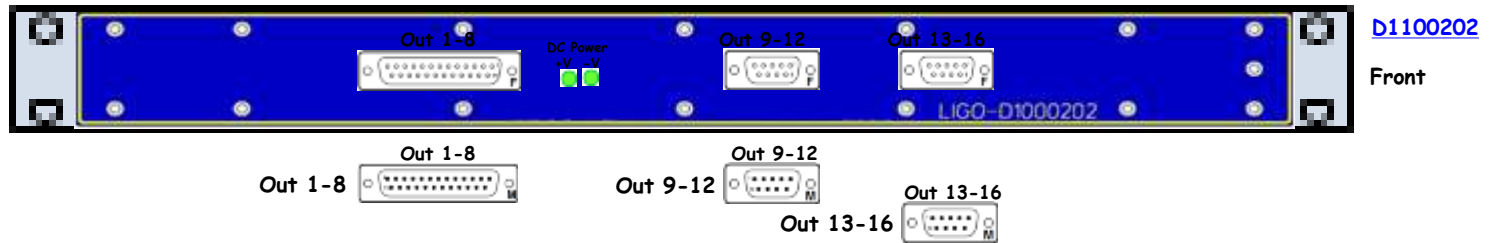



D0902744

Front



S1103308

Rear

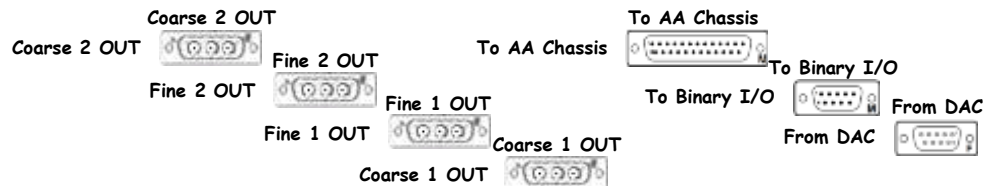



D0902744

Front

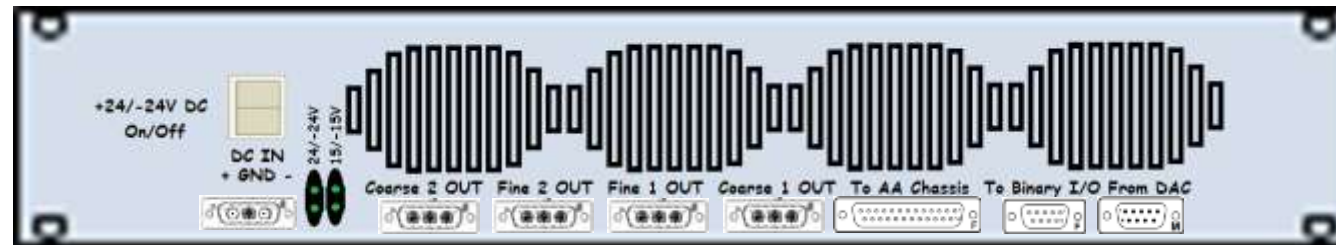

S1103325

Rear

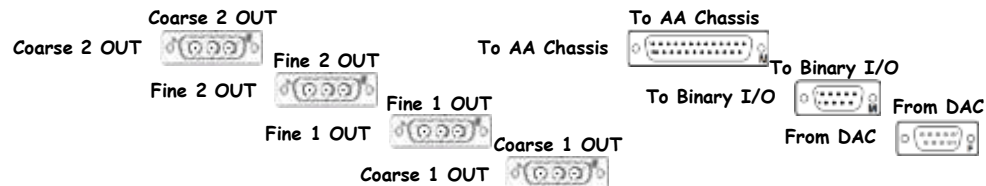

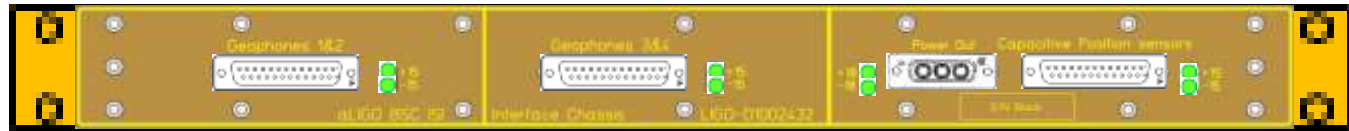

[D1002432](#)

Front

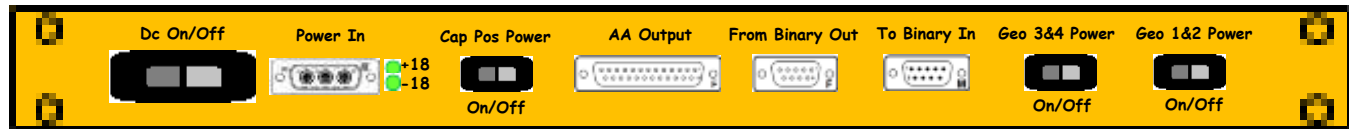

[S1107869](#)

Rear

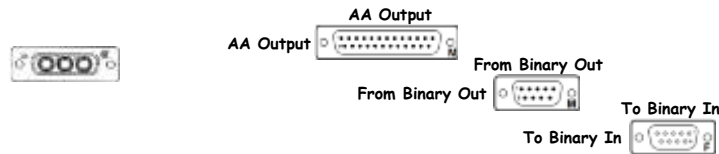

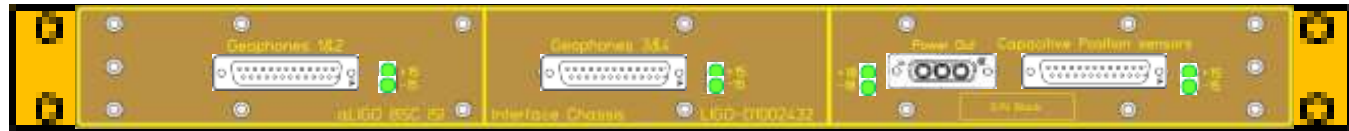

[D1002432](#)

Front

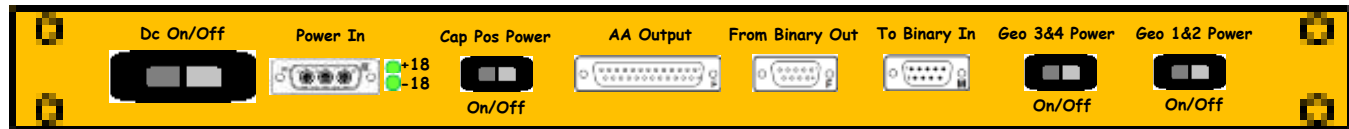

[S1107870](#)

Rear

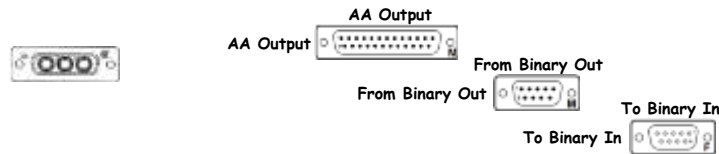

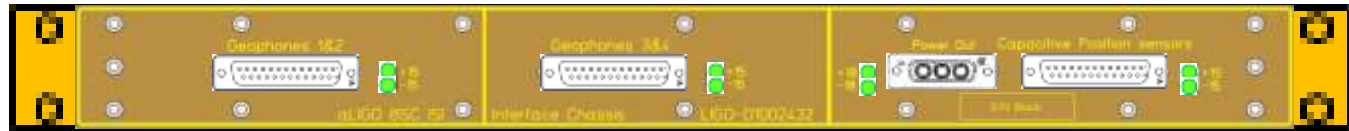

[D1002432](#)

Front

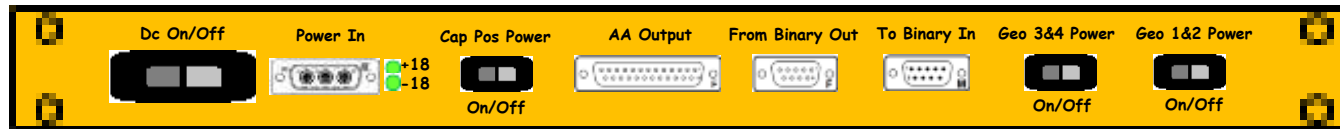

[S1107871](#)

Rear

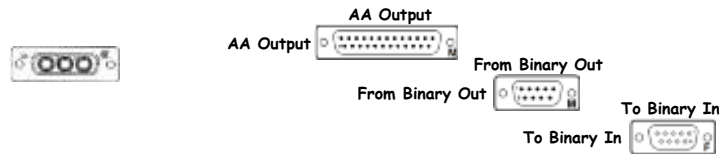

D1000269 - S1107530

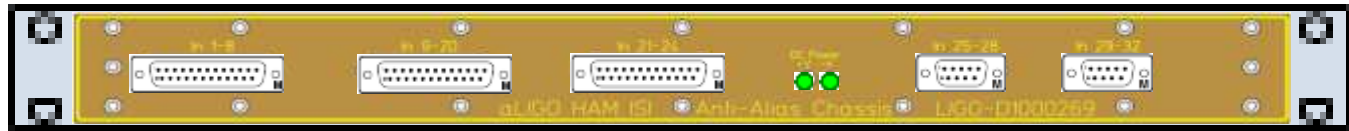

D1000269

Front

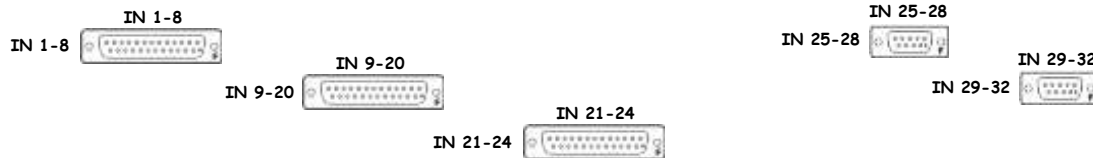

S1107530

Rear

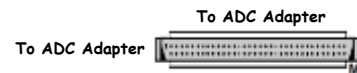

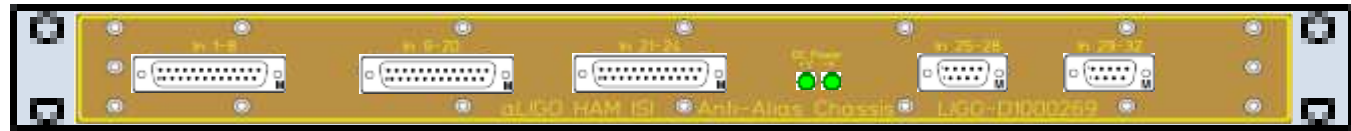

D1000269

Front

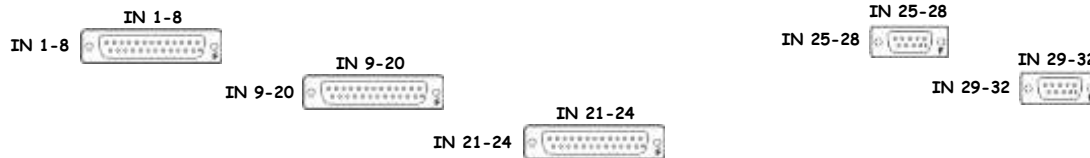

S1107531

Rear

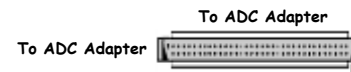

HAM5 HEPI Anti-Image Chassis D1100202 S1200318 ±18VDC

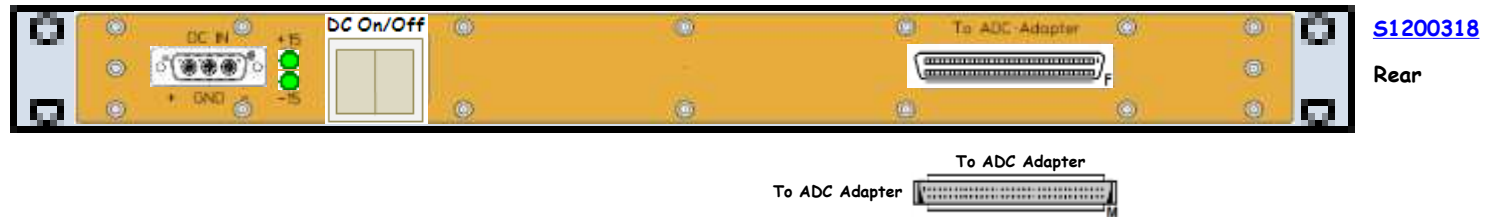
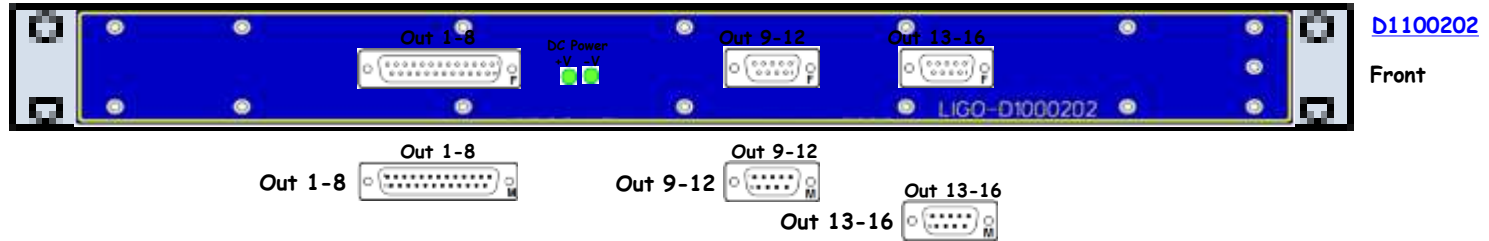



D0902744

Front

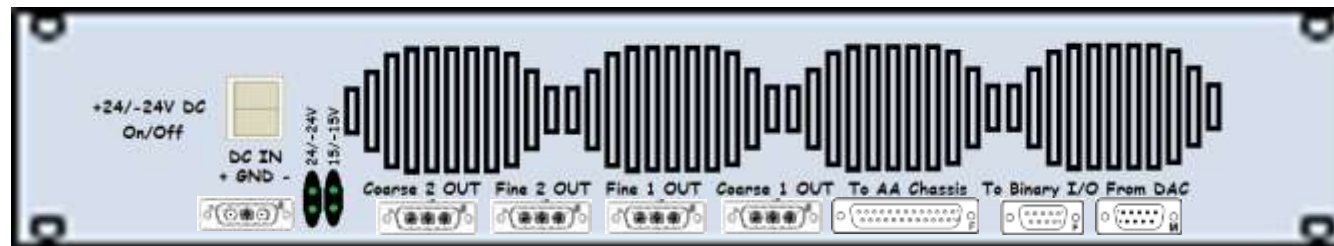

S1103326

Rear

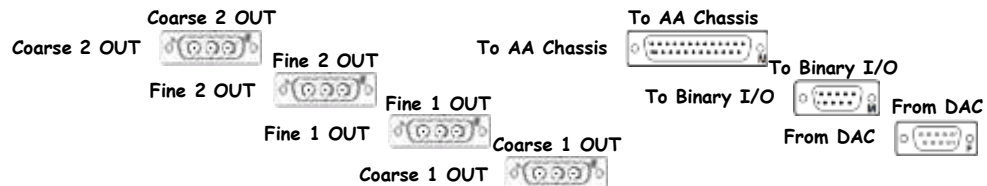



D0902744

Front



S1103324

Rear

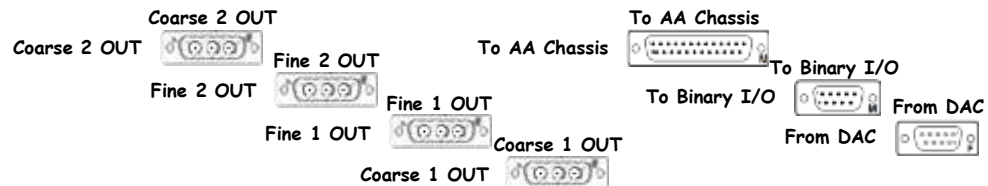

D1000272 - S1200310



<< L1-SEI-C3

HAM4 HEPI Anti-Alias Chassis D1000272 S1200310 ±18VDC



D1000272

Front

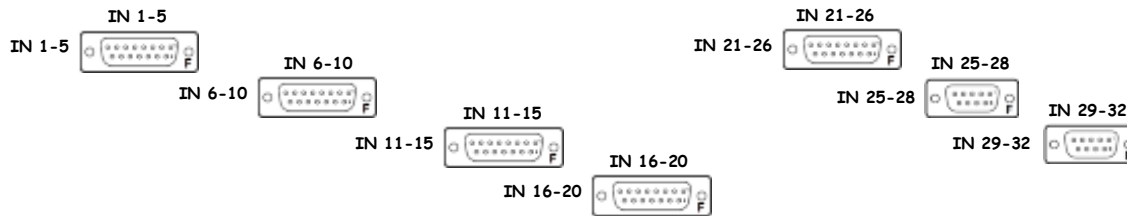

S1200310

Rear

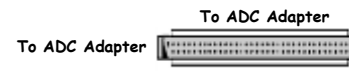



D0900117

Front

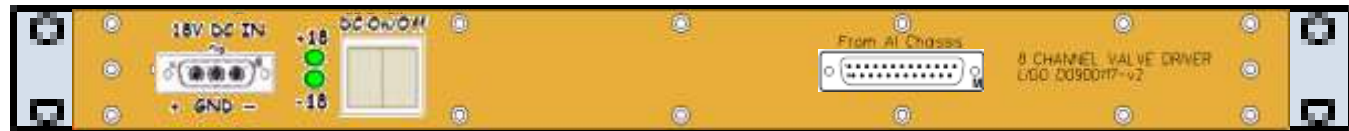
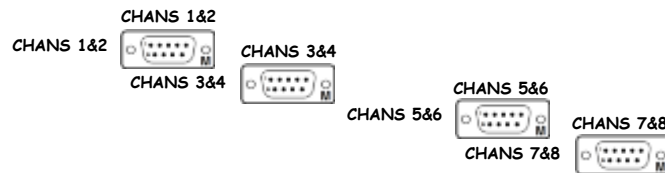

S0900266

Rear



[D0900117](#) is part of [D0901338](#)

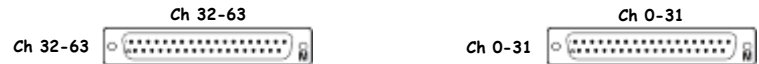
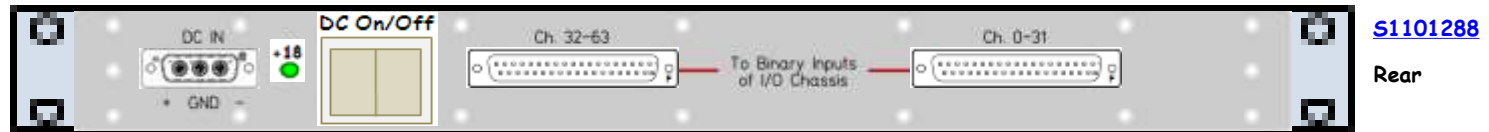
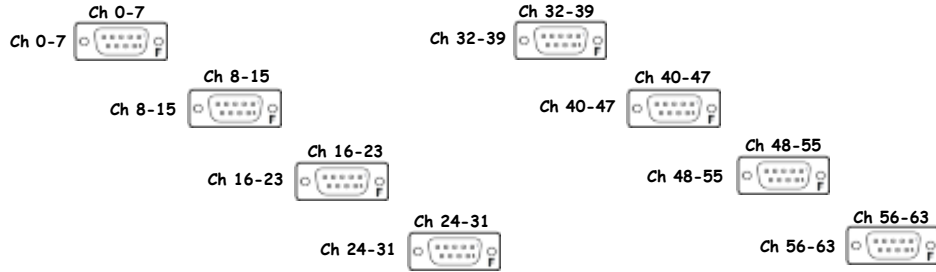

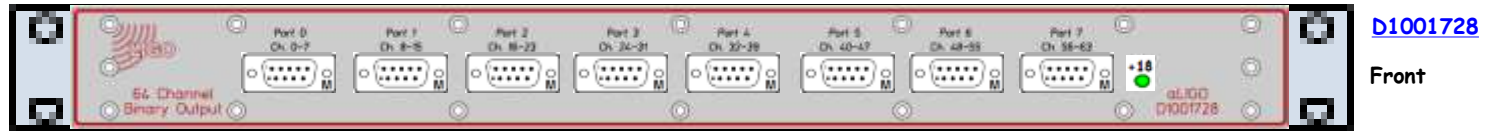

D1001728

Front

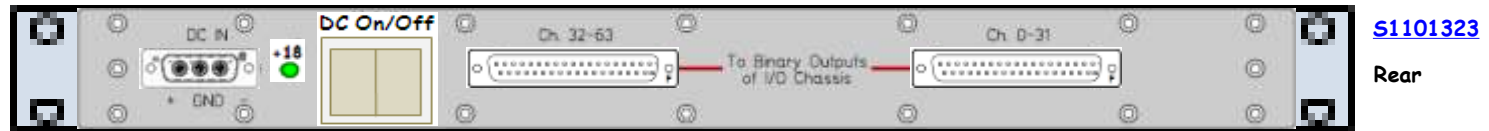
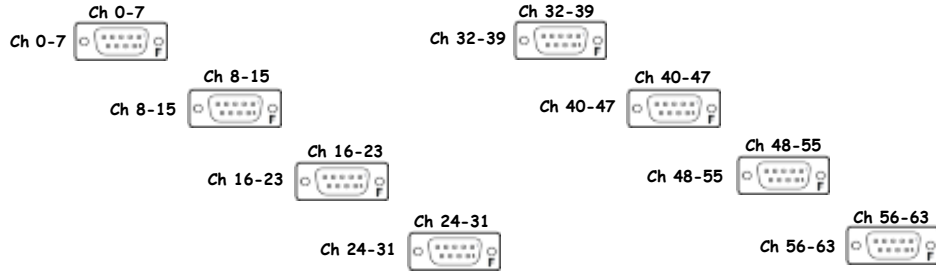

S1101323

Rear





D1000272

Front

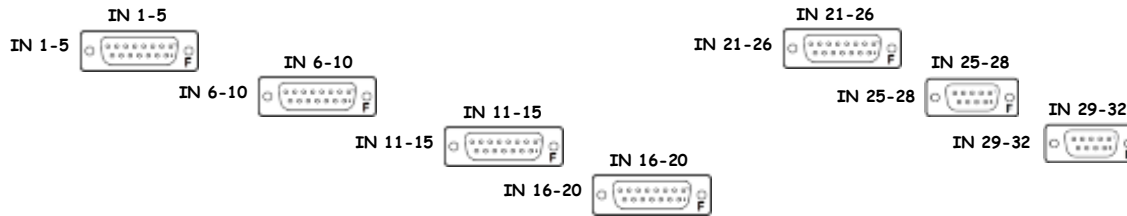

S1200311

Rear

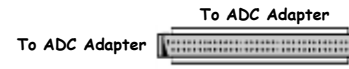



D0900117

Front

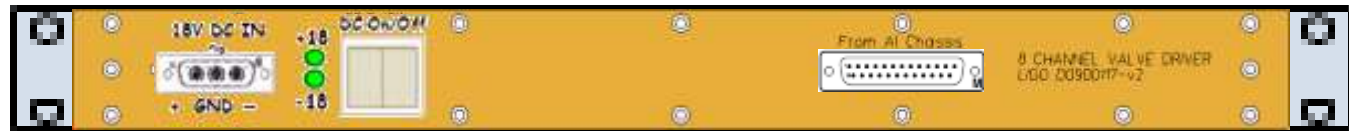
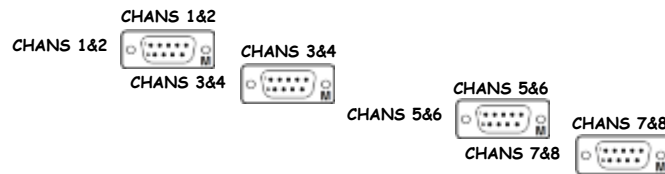

S0900272

Rear



[D0900117](#) is part of [D0901338](#)

HAM5 HEPI Binary Input Chassis D1001726 S1101289 +18VDC

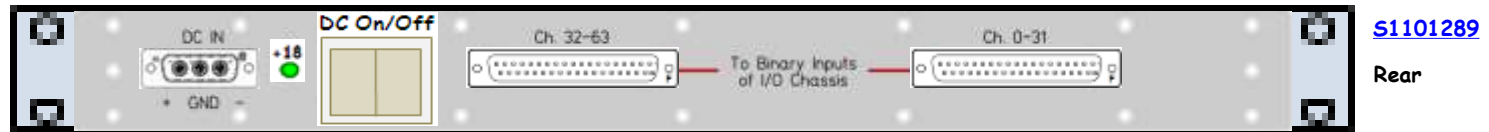
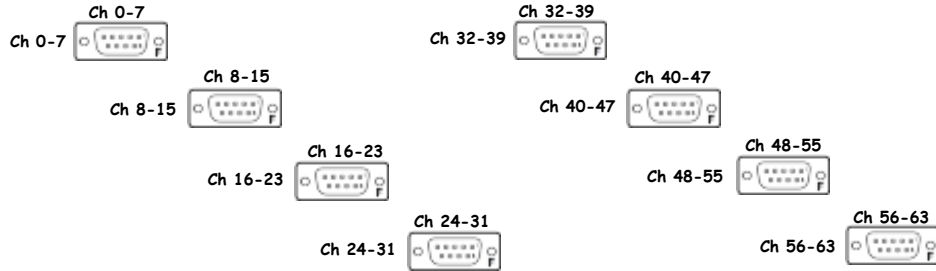

<< L1-SEI-C3

I1seiham45 - I/O Extension Chassis

D1001715

S1001146

+24VDC

D1001715

Front

Timing Slot













I1seiham45 is part of [D1400014](#)

I1seiham45 – I/O Extender

S1001146

Rear

Uplink  [L1:FE-IO-09](#)

- Slot E1  Open
- Slot E2  Open
- Slot E3  Open
- Slot P1  Open
- Slot P2  Open
- Slot P3  Open
- Slot P4  Open
- Slot P5  Open
- Slot P6  Open
- Slot P7  Open
- Slot P8  Open
- Slot P9  Open
- Slot P10  Open

PTY-015

- Slot P10
- Slot P9
- Slot P8
- Slot P7
- Slot P6
- Slot P5
- Slot P4
- Slot P3
- Slot P2
- Slot P1
- Slot E3
- Slot E2
- Slot E1

DACT16 Card

ADC Card

ADC Card

ADC Card

ADC Card

ADC Card

ADC Card

ADC Card

ADC Card

ADC Card

ADC Card

ADC Card

ADC Card

Binary IO Card

Binary IO Card

L1:FE-IO-09



+24VDC

		42			
		41			
BSC1 ISI Interface Chassis Pod 1	D1002432	40	S1201326	±18VDC	
BSC1 ISI Interface Chassis Pod 2	D1002432	39	S1201325	±18VDC	
BSC1 ISI Interface Chassis Pod 3	D1002432	38	S1201329	±18VDC	
		37			
		36			
BSC1 ISI Anti-Alias Chassis	D1002693	35	S1203001	±18VDC	
BSC1 ISI Anti-Alias Chassis	D1002693	34	S1203000	±18VDC	
		33			
BSC1 ISI Anti-Alias Chassis	D1002693	32	S1202999	±18VDC	
		31			
BSC1 HEPI Anti-Alias Chassis	D1000272	30	S1200951	±18VDC	
BSC1 HEPI Anti-Image Chassis	D1100202	29	S1203003	±18VDC	
		28			
BSC1 HEPI 8-Channel Valve Driver	D0900117	27	S0900279	±18VDC	
		26			
BSC1 HEPI Binary Input Chassis	D1001726	25	S1101295	+18VDC	
BSC1 HEPI Binary Input Chassis	D1001726	24	S1101296	+18VDC	
BSC1 HEPI Binary Output Chassis	D1001728	23	S1101327	+18VDC	
		22			
BSC1 T-240 Interface Chassis Pod 1	D1002694	21	S1201402	±18VDC	
BSC1 T-240 Interface Chassis Pod 2	D1002694	20	S1201391	±18VDC	
BSC1 T-240 Interface Chassis Pod 3	D1002694	19	S1201386	±18VDC	
		18			
BSC1 STS-2 Distribution Chassis	D0900351	17	S0900137	±18VDC	
BSC1 STS-2 Interface Chassis	D080535	16	S0900097	±18VDC	
		15			
		14			
l1seibsc1 - I/O Extension Chassis	D1001715	12	S1001147	+24VDC	
		11			
		10			
BSC1 Anti-Image Chassis	D1000305	9	S1203007	±18VDC	
		8			
BSC1 ISI Coil Driver Pod 1	D0902744	6	S1103328	±24VDC	
BSC1 ISI Coil Driver Pod 2	D0902744	4	S1103322	±24VDC	
BSC1 ISI Coil Driver Pod 3	D0902744	2	S1103311	±24VDC	
		1			
	Front		Rear		

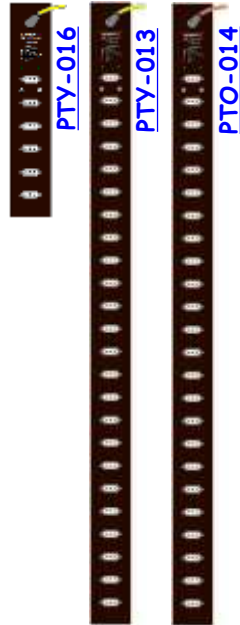

SEI-C4 is part of [D0901301](#)

L1-SEI-C4 Details

SEI-C4 is part of [D0901301](#)

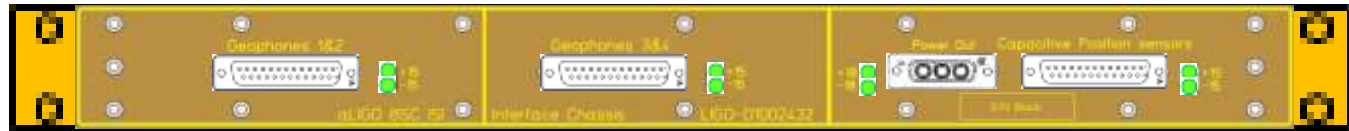

[D1002432](#)

Front

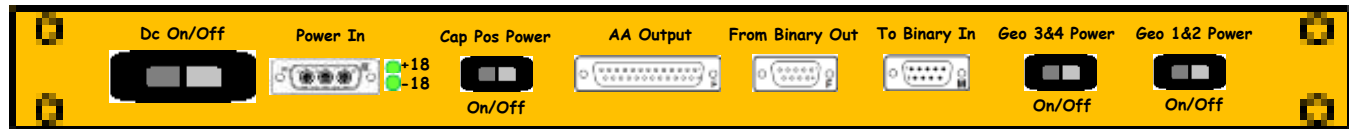

[S1201326](#)

Rear

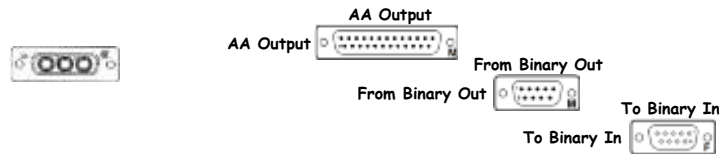

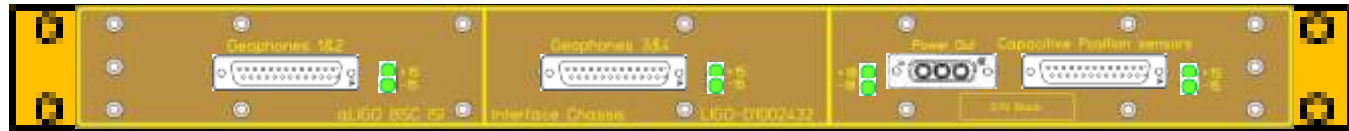

[D1002432](#)

Front

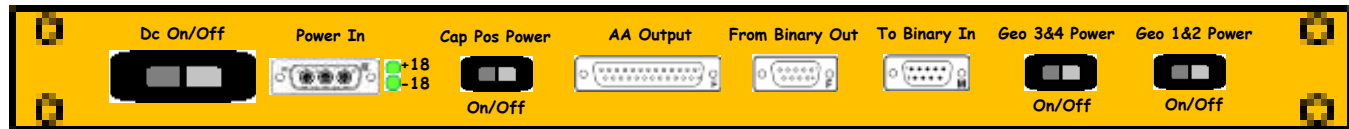

[S1201325](#)

Rear

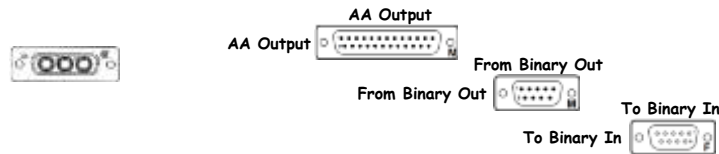

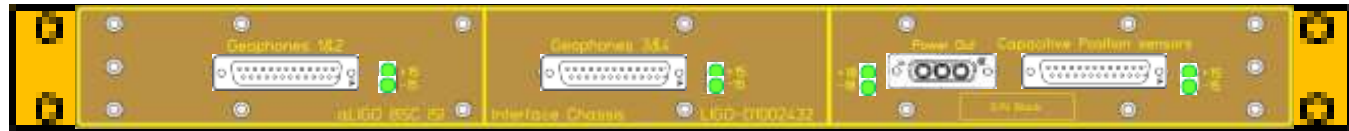

[D1002432](#)

Front

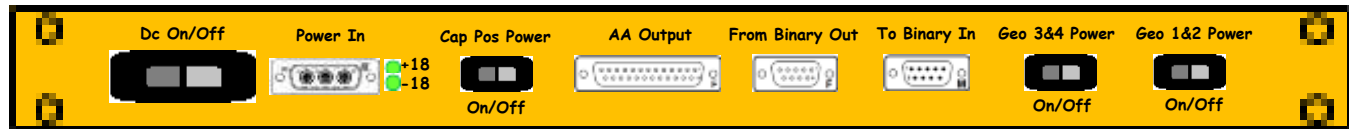

[S1201329](#)

Rear

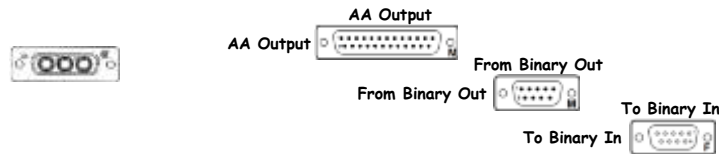

BSC1 ISI Anti-Alias Chassis D1002693 S1203001 ±18VDC

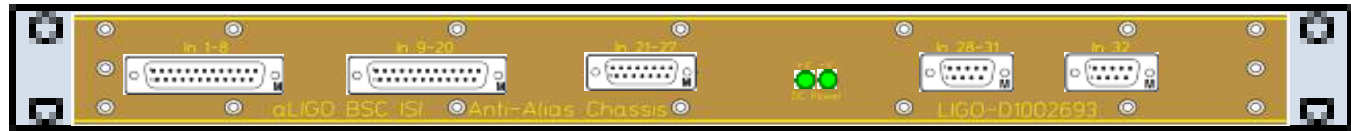

D1002693

Front

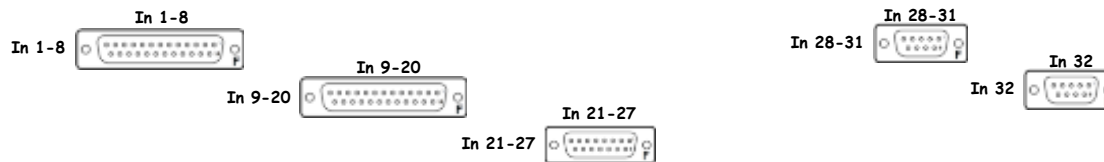

S1203001

Rear

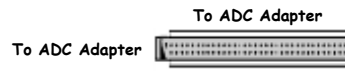

BSC1 ISI Anti-Alias Chassis D1002693 S1203000 ±18VDC

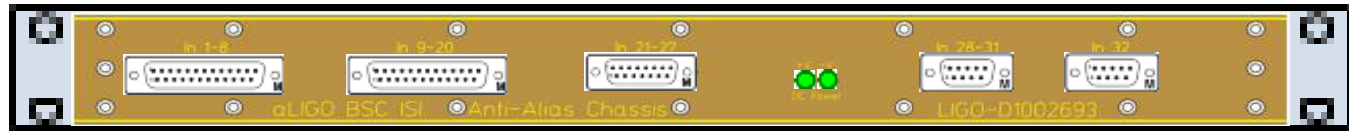

D1002693

Front

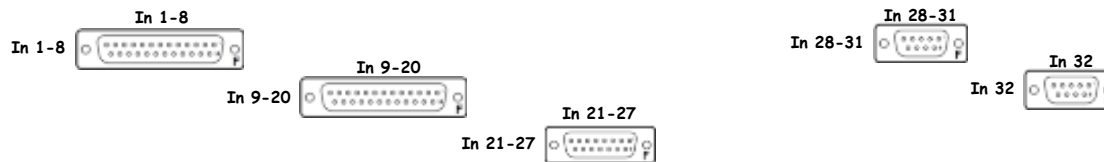

S1203000

Rear

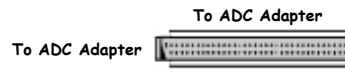

BSC1 ISI Anti-Alias Chassis D1002693 S1202999 ±18VDC

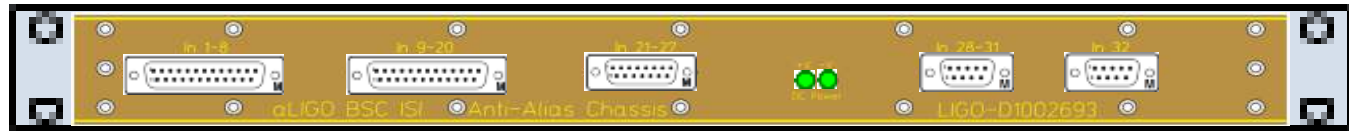

D1002693

Front

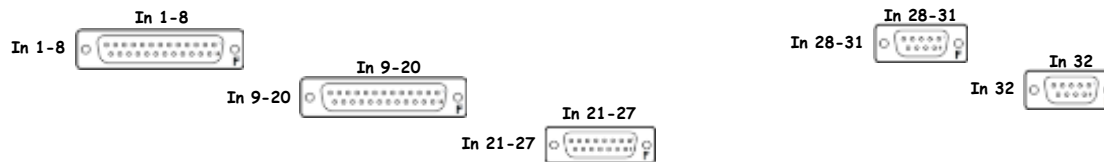

S1202999

Rear

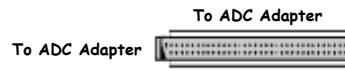

D1000272 - S1200951

BSC1 HEPI Anti-Alias Chassis D1000272 S1200951 ±18VDC



D1000272

Front

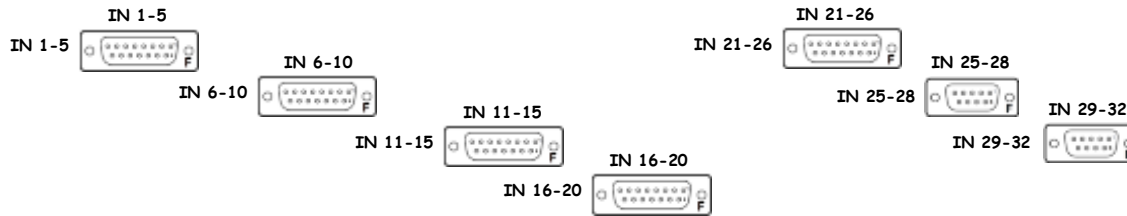

S1200951

Rear

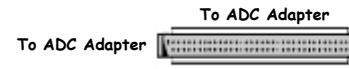

D1100202 - S1203003

BSC1 HEPI Anti-Image Chassis D1100202 S1203003 ±18VDC

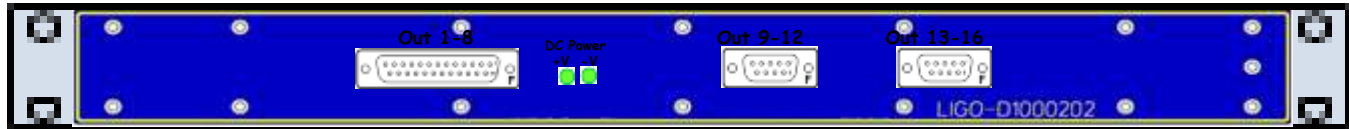

D1100202

Front



S1203003

Rear

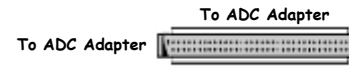



[D0900117](#)

Front

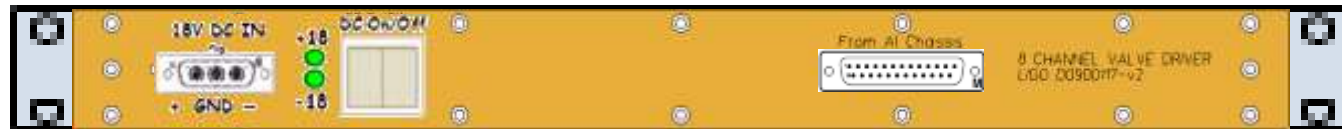
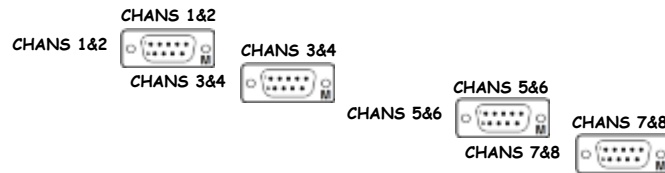

[S0900279](#)

Rear



[D0900117](#) is part of [D0901338](#)

BSC1 HEPI Binary Input Chassis D1001726 S1101295 +18VDC

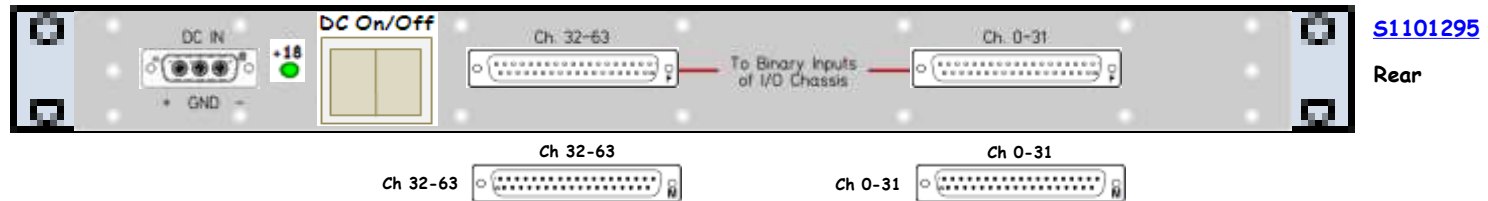

BSC1 HEPI Binary Input Chassis D1001726 S1101296 +18VDC



D1001726

Front

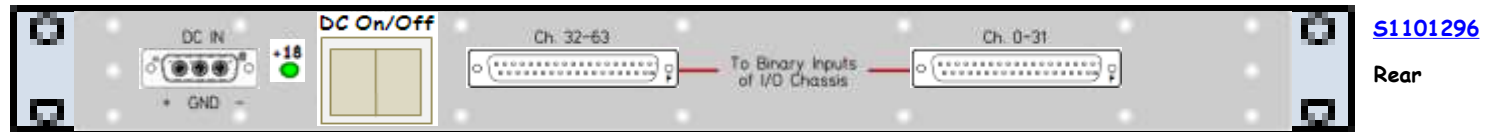
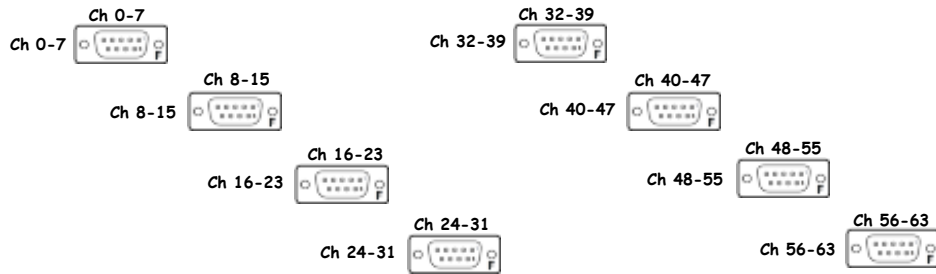

S1101296

Rear



BSC1 HEPI Binary Output Chassis D1001728 S1101327 +18VDC

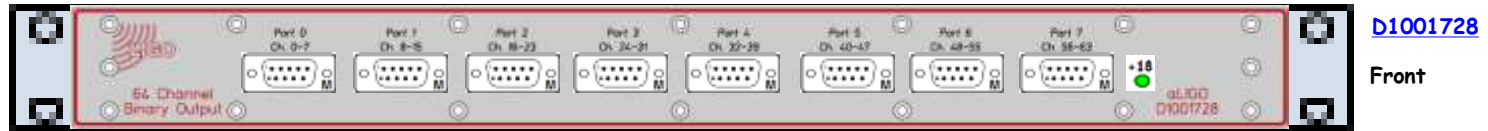

D1001728

Front

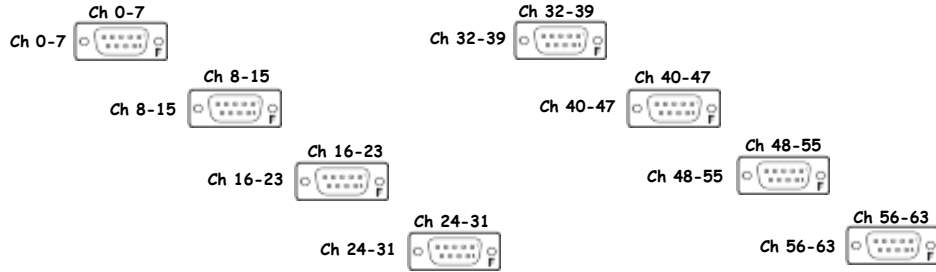

S1101327

Rear





D1002694

Front

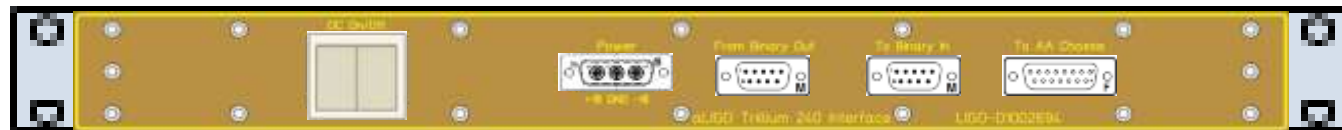
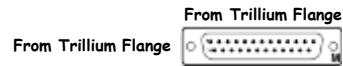

S1201402

Rear

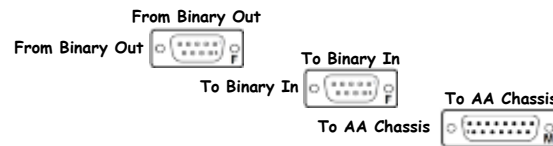



D1002694

Front

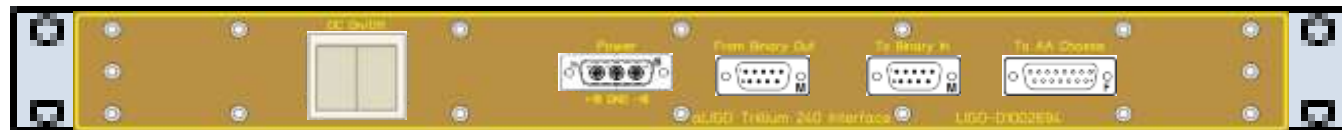
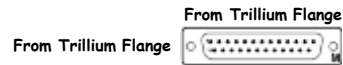

S1201391

Rear

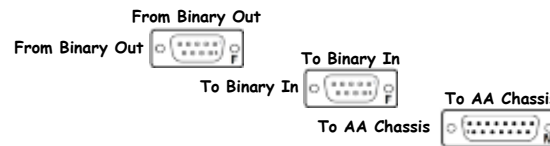



D1002694

Front

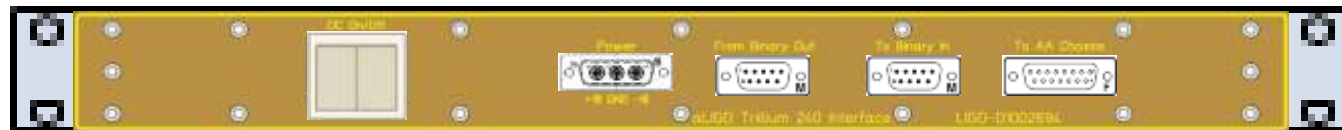
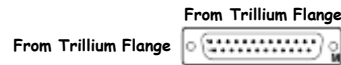

S1201386

Rear

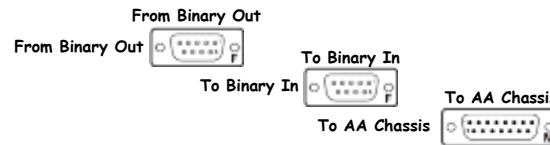

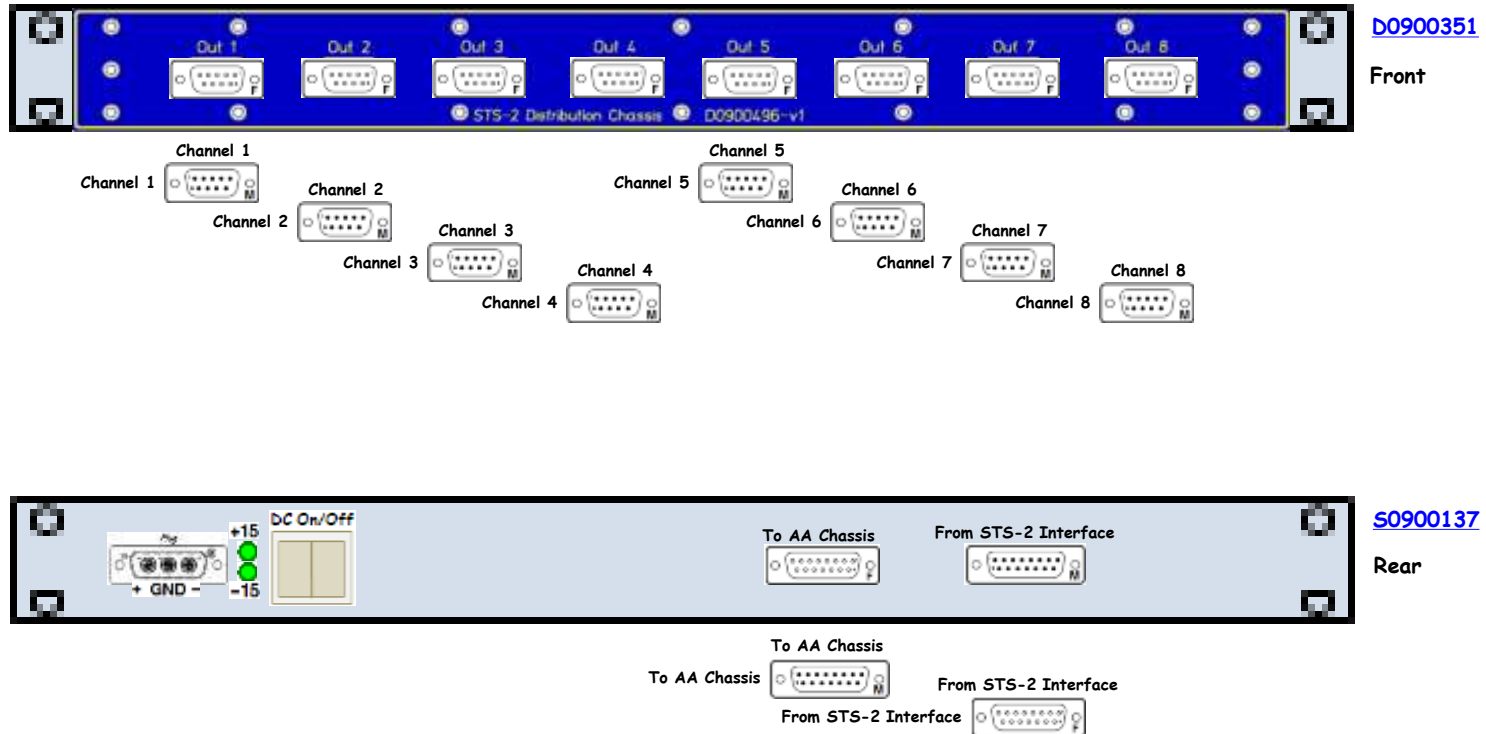

BSC1 STS-2 Interface Chassis

D080535

S0900097

±18VDC

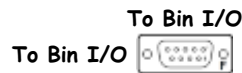
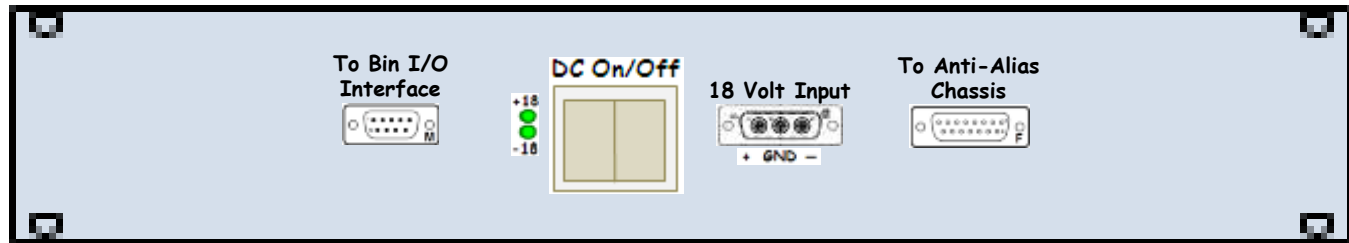
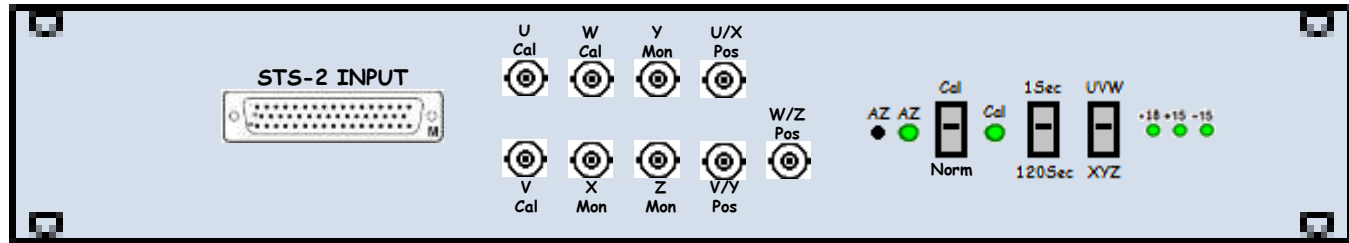

<< L1-SEI-C4

l1seibsc1 - I/O Extension Chassis

D1001715

S1001147

+24VDC

D1001715

Front

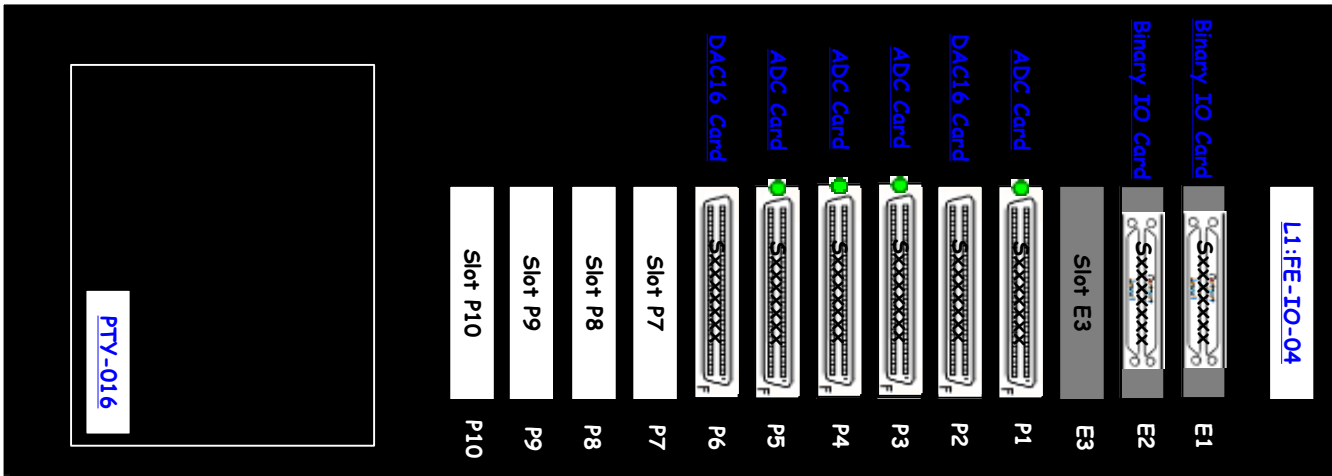

S1001147

Rear

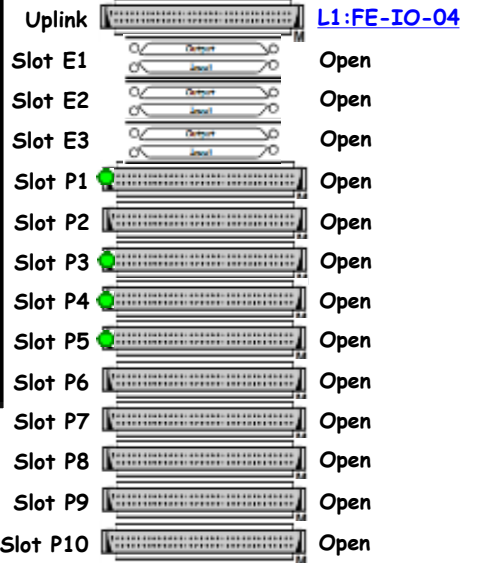

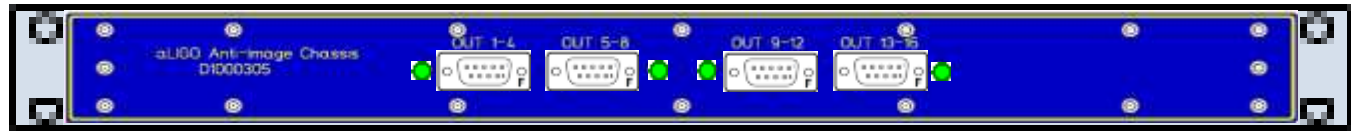

D1000305

Front

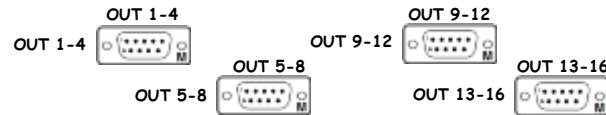

S1203007

Rear

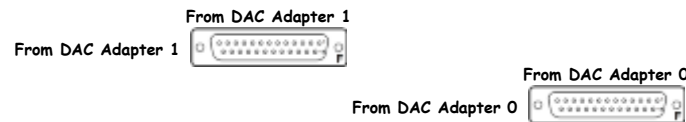



D0902744

Front



S1103328

Rear

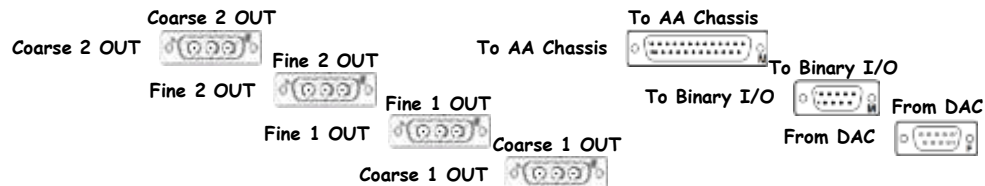



D0902744

Front

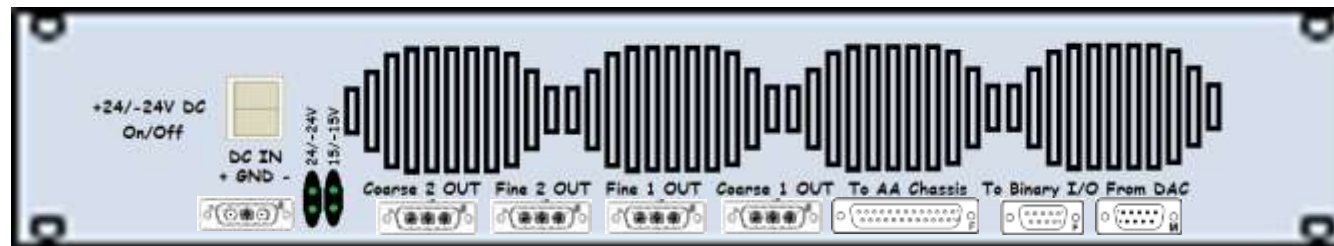

S1103322

Rear

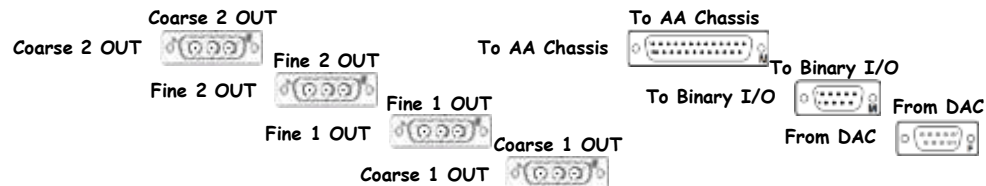



D0902744

Front



S1103311

Rear

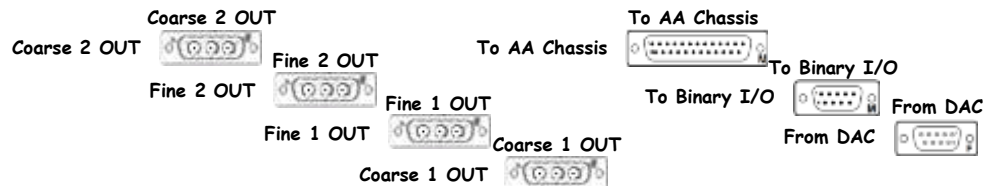

		42			
		41			
BSC2 ISI Interface Chassis Pod 1	D1002432	40	S1106357	±18VDC	
BSC2 ISI Interface Chassis Pod 2	D1002432	39	S1200666	±18VDC	
BSC2 ISI Interface Chassis Pod 3	D1002432	38	S1200665	±18VDC	
		37			
		36			
BSC2 ISI Anti-Alias Chassis	D1002693	35	S1200947	±18VDC	
BSC2 ISI Anti-Alias Chassis	D1002693	34	S1200946	±18VDC	
		33			
BSC2 ISI Anti-Alias Chassis	D1002693	32	S1200948	±18VDC	
		31			
BSC2 HEPI Anti-Alias Chassis	D1000272	30	S1200312	±18VDC	
BSC2 HEPI Anti-Image Chassis	D1100202	29	S1200953	±18VDC	
		28			
BSC2 HEPI 8-Channel Valve Driver	D0900117	27	S0900285	±18VDC	
		26			
BSC2 HEPI Binary Input Chassis	D1001726	25	S1101291	+18VDC	
BSC2 HEPI Binary Input Chassis	D1001726	24	S1101292	+18VDC	
BSC2 HEPI Binary Output Chassis	D1001728	23	S1101325	+18VDC	
		22			
BSC2 T-240 Interface Chassis Pod 1	D1002694	21	S1104427	±18VDC	
BSC2 T-240 Interface Chassis Pod 2	D1002694	20	S1104425	±18VDC	
BSC2 T-240 Interface Chassis Pod 3	D1002694	19	S1104421	±18VDC	
		18			
BSC2 STS-2 Distribution Chassis	D0900351	17	S0900132	±18VDC	
BSC2 STS-2 Interface Chassis	D080535	16	S0900094	±18VDC	
		15			
		14			
I1seibsc2 - I/O Extension Chassis	D1001715	12	S1001148	+24VDC	
		11			
		10			
BSC2 Anti-Image Chassis	D1000305	9	S1200955	±18VDC	
		8			
BSC2 ISI Coil Driver Pod 1	D0902744	6	S1103305	±24VDC	
BSC2 ISI Coil Driver Pod 2	D0902744	4	S1103337	±24VDC	
BSC2 ISI Coil Driver Pod 3	D0902744	2	S1103353	±24VDC	
		1			
	Front		Rear		

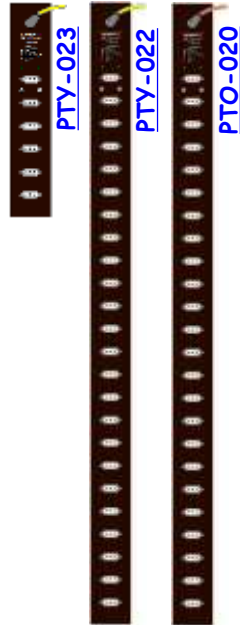

SEI-C5 is part of [D0901301](#)

L1-SEI-C5 Details

SEI-C5 is part of [D0901301](#)

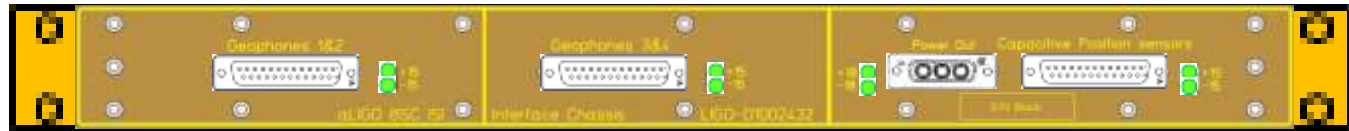

[D1002432](#)

Front

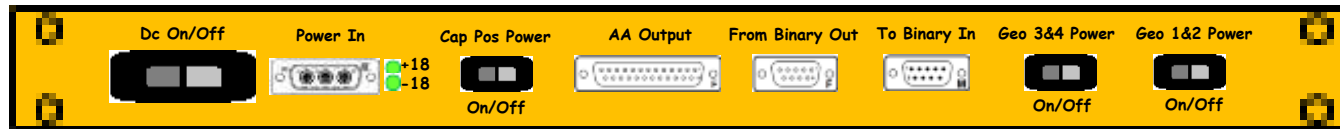

[S1106357](#)

Rear

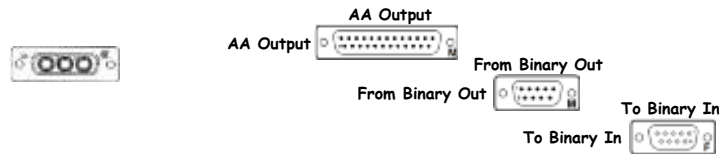

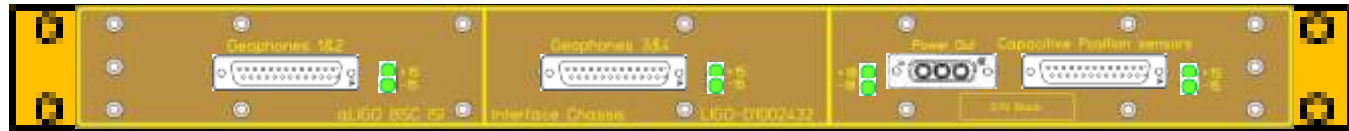

[D1002432](#)

Front

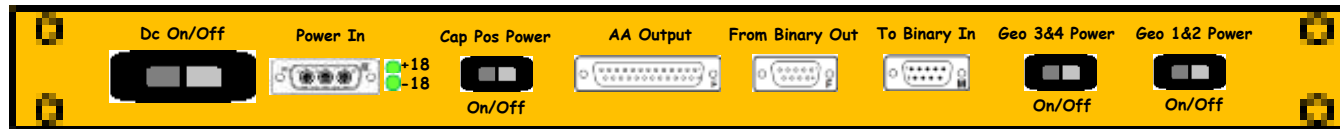

[S1200666](#)

Rear

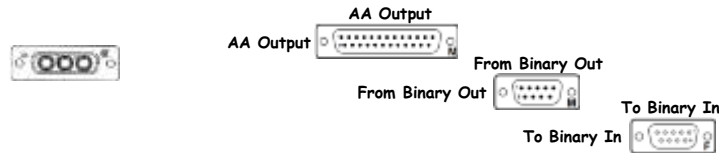

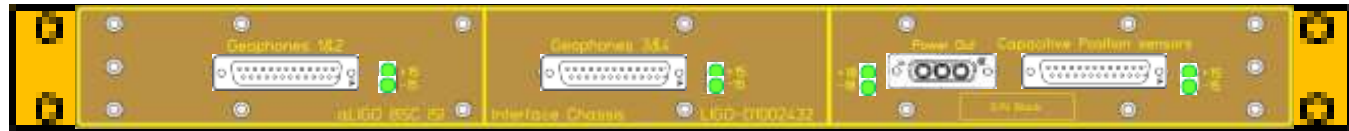

[D1002432](#)

Front

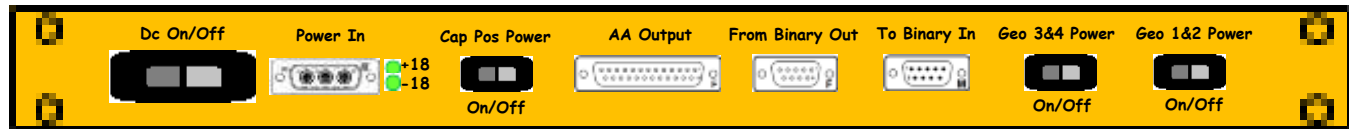

[S1200665](#)

Rear

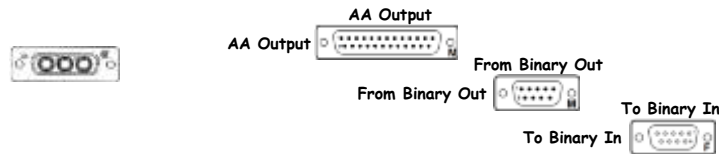

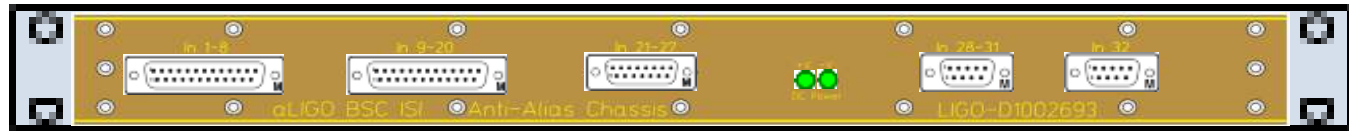

D1002693

Front

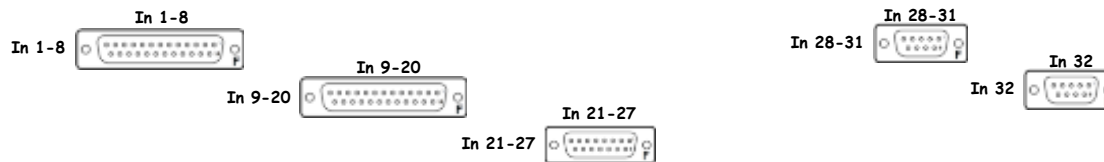

S1200947

Rear

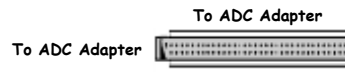

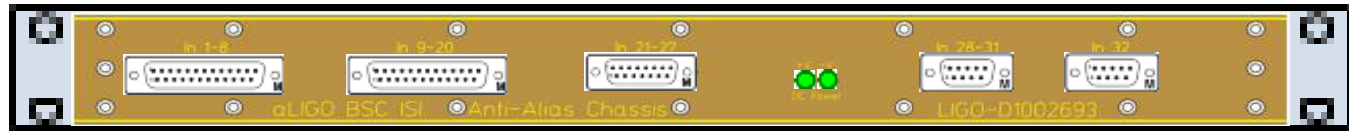

D1002693

Front

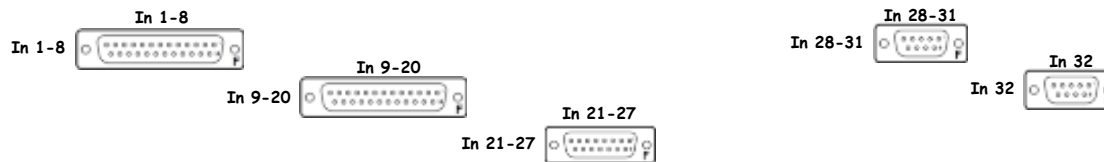

S1200946

Rear

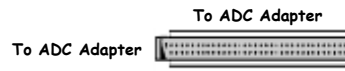

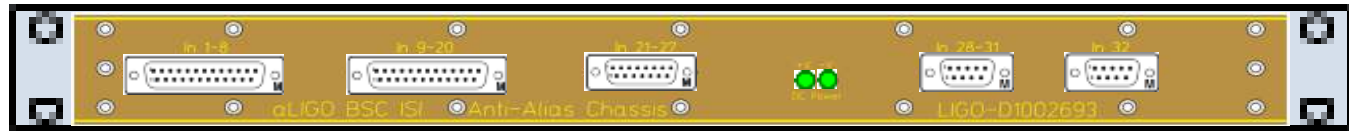

D1002693

Front

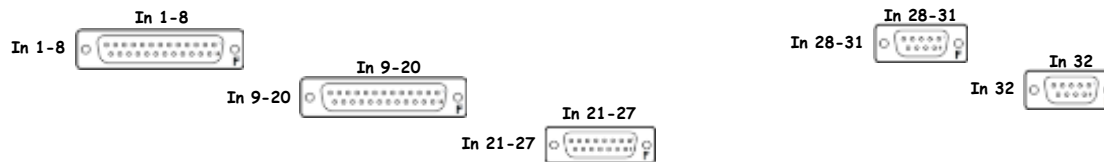

S1200948

Rear

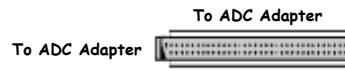

D1000272 - S1200312



<< L1-SEI-C5

BSC2 HEPI Anti-Alias Chassis D1000272 S1200312 ±18VDC



D1000272

Front

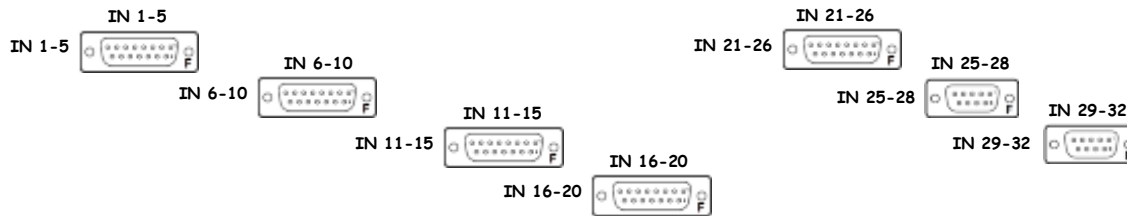

S1200312

Rear

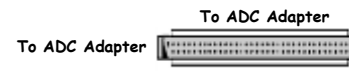

D1100202 - S1200953

BSC2 HEPI Anti-Image Chassis D1100202 S1200953 ±18VDC

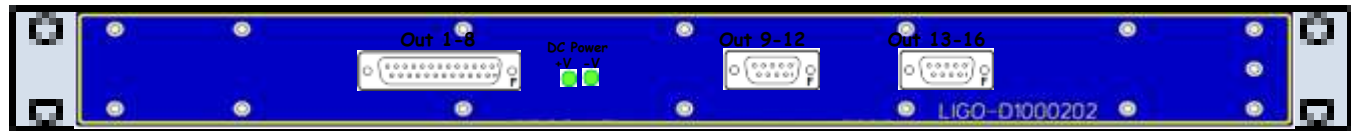

D1100202

Front



S1200953

Rear

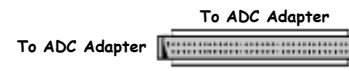



[D0900117](#)

Front

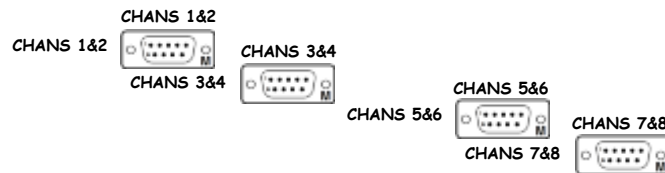

[S0900285](#)

Rear



[D0900117](#) is part of [D0901338](#)

BSC2 HEPI Binary Input Chassis D1001726 S1101291 +18VDC



D1001726

Front

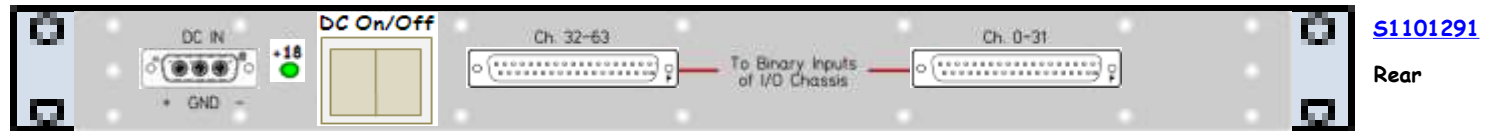
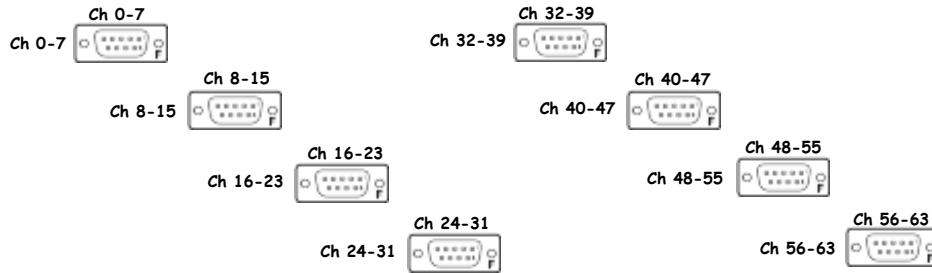

S1101291

Rear



BSC2 HEPI Binary Input Chassis D1001726 S1101292 +18VDC

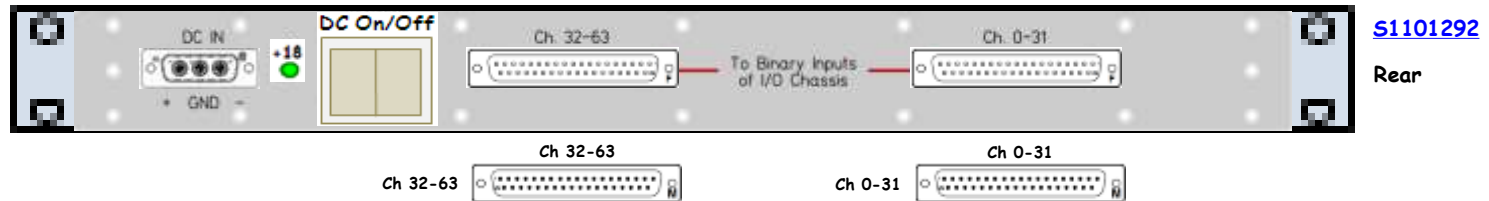

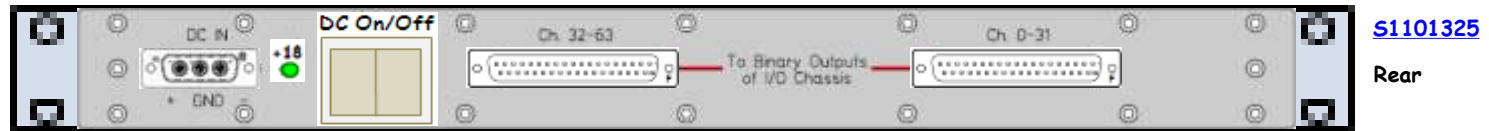
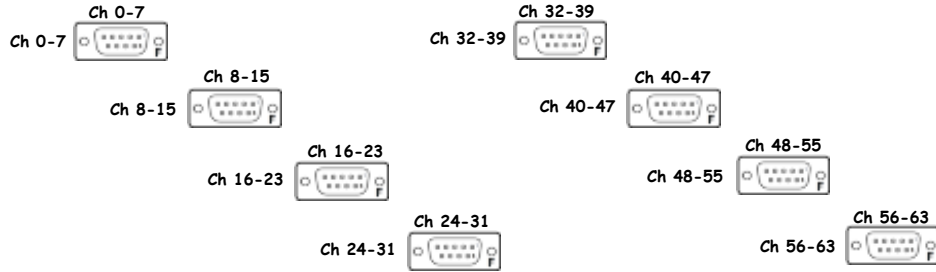
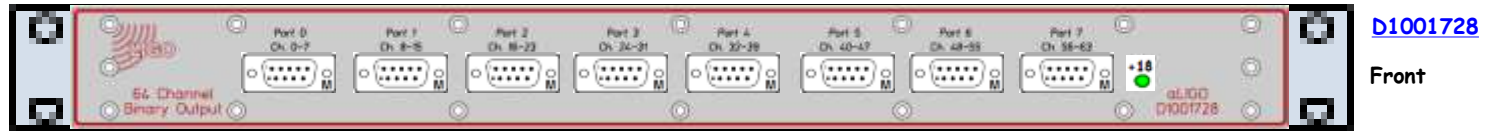



D1002694

Front

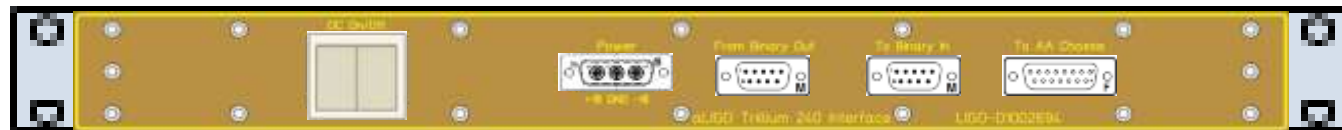
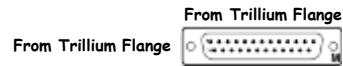

S1104427

Rear

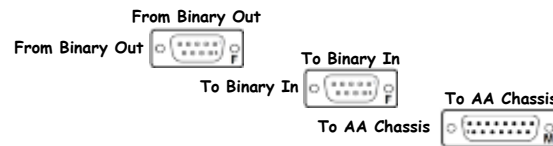



D1002694

Front

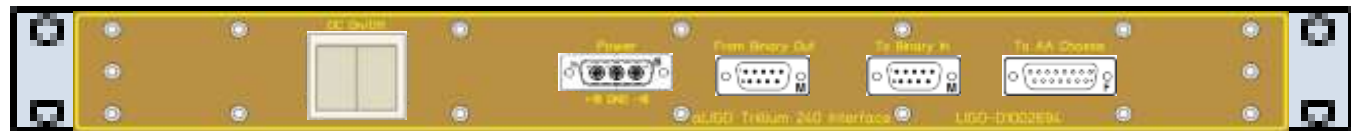
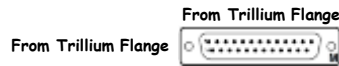

S1104425

Rear

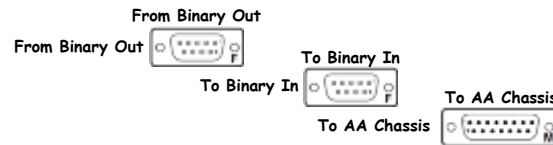



D1002694

Front

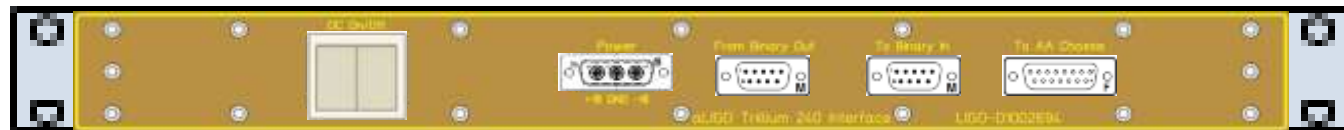
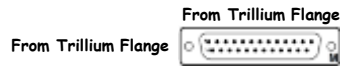

S1104421

Rear

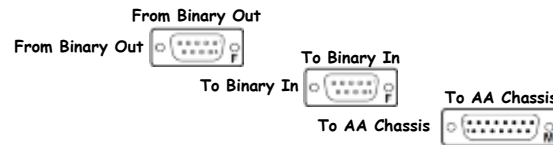

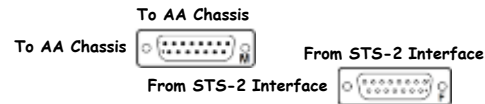
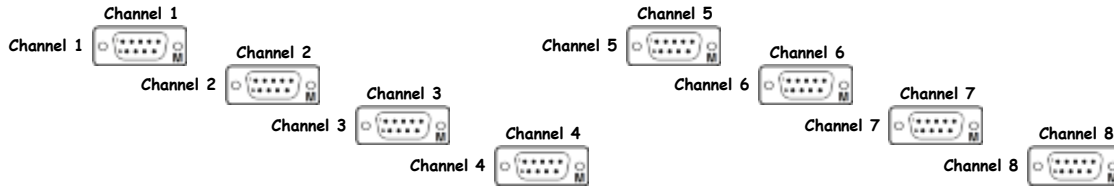

BSC2 STS-2 Interface Chassis

D080535

S0900094

±18VDC

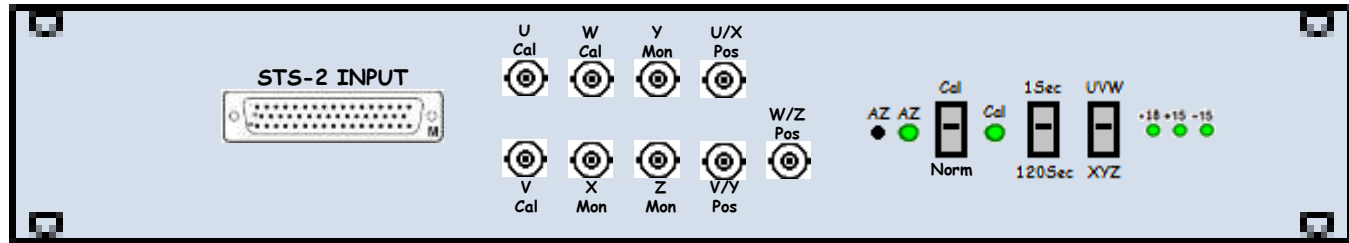

D080535

Front

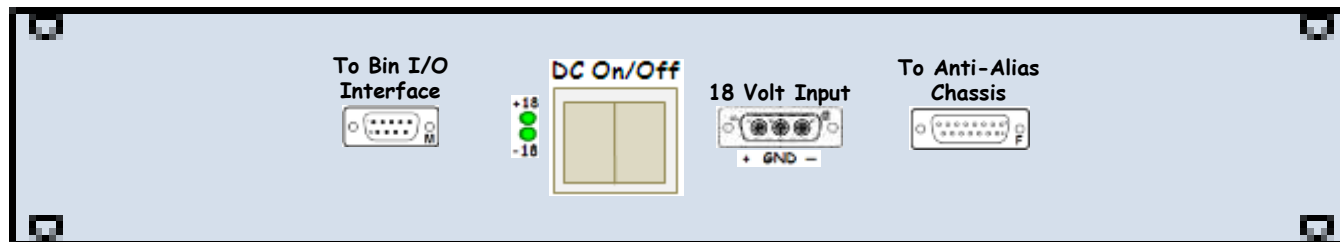

S0900094

Rear

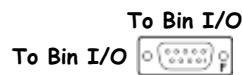

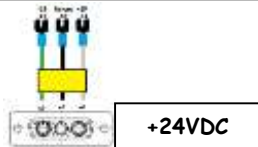
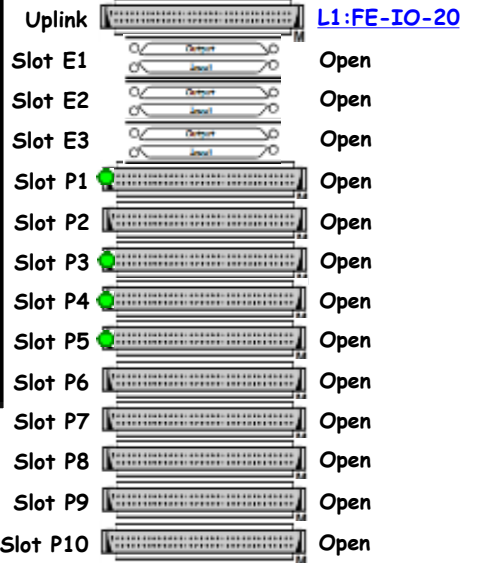
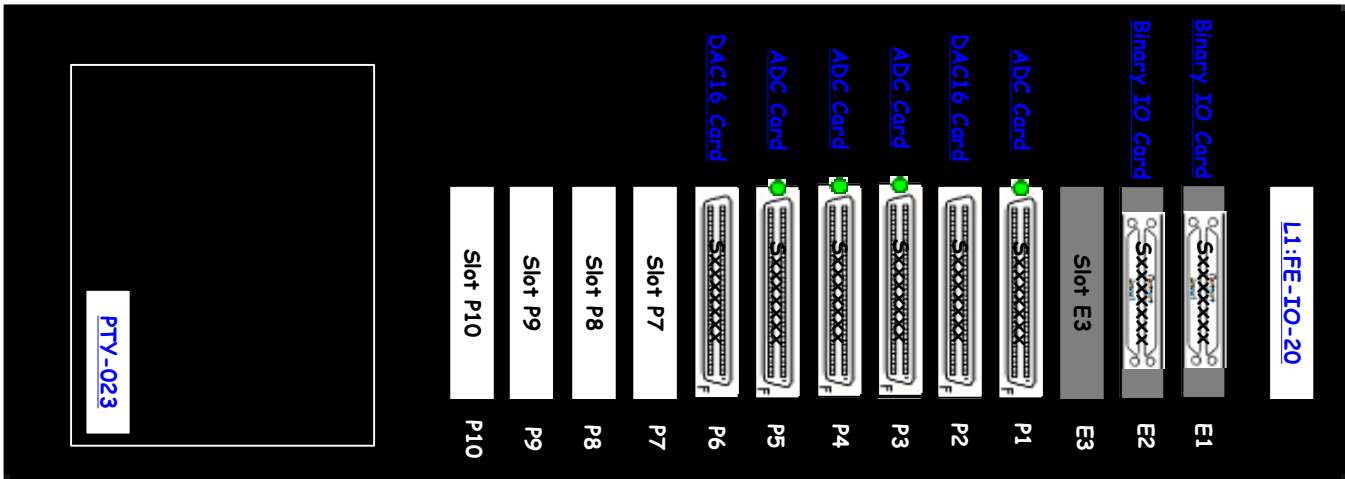

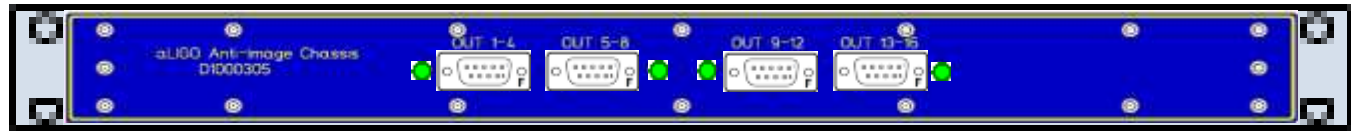

D1000305

Front

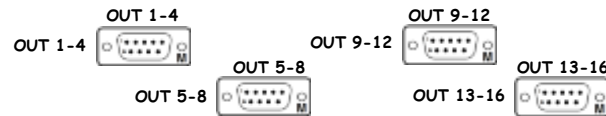

S1200955

Rear

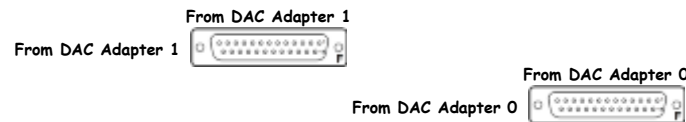



D0902744

Front

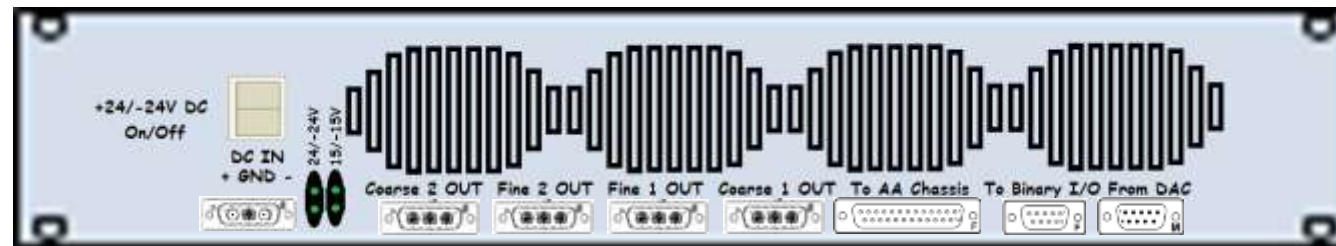

S1103305

Rear

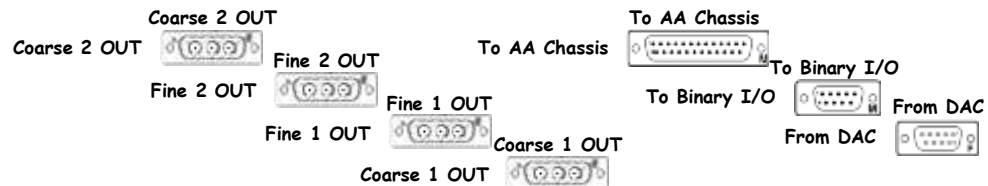



D0902744

Front



S1103337

Rear

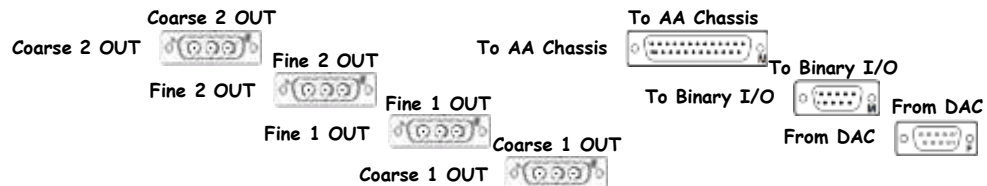



D0902744

Front



S1103353

Rear

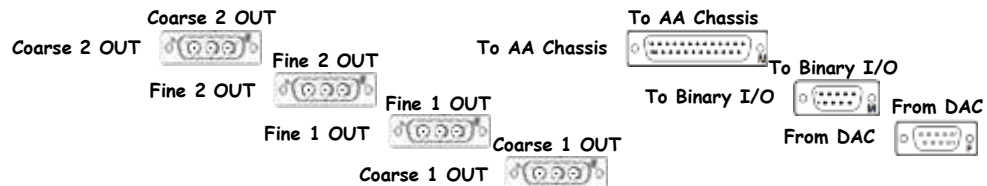

		42			
		41			
BSC3 ISI Interface Chassis Pod 1	D1002432	40	S1201323	±18VDC	
BSC3 ISI Interface Chassis Pod 2	D1002432	39	S1201322	±18VDC	
BSC3 ISI Interface Chassis Pod 3	D1002432	38	S1201327	±18VDC	
		37			
		36			
BSC3 ISI Anti-Alias Chassis	D1002693	35	S1203102	±18VDC	
BSC3 ISI Anti-Alias Chassis	D1002693	34	S1203101	±18VDC	
		33			
BSC3 ISI Anti-Alias Chassis	D1002693	32	S1203100	±18VDC	
		31			
BSC3 HEPI Anti-Alias Chassis	D1000272	30	S1203002	±18VDC	
BSC3 HEPI Anti-Image Chassis	D1100202	29	S1203132	±18VDC	
		28			
BSC3 HEPI 8-Channel Valve Driver	D0900117	27	S0900280	±18VDC	
		26			
BSC3 HEPI Binary Input Chassis	D1001726	25	S1101299	+18VDC	
BSC3 HEPI Binary Input Chassis	D1001726	24	S1101298	+18VDC	
BSC3 HEPI Binary Output Chassis	D1001728	23	S1101328	+18VDC	
		22			
BSC3 T-240 Interface Chassis Pod 1	D1002694	21	S1201892	±18VDC	
BSC3 T-240 Interface Chassis Pod 2	D1002694	20	S1104429	±18VDC	
BSC3 T-240 Interface Chassis Pod 3	D1002694	19	S1104428	±18VDC	
		18			
BSC3 STS-2 Distribution Chassis	D0900351	17	S0900130	±18VDC	
BSC3 STS-2 Interface Chassis	D080535	16	S0900092	±24VDC	
		15			
		14			
l1seibsc3 - I/O Extension Chassis	D1001715	12	S1100946	+24VDC	
		11			
		10			
BSC3 Anti-Image Chassis	D1000305	9	S1203269	±18VDC	
		8			
BSC3 ISI Coil Driver Pod 1	D0902744	6	S1103565	±24VDC	
BSC3 ISI Coil Driver Pod 2	D0902744	4	S1103315	±24VDC	
BSC3 ISI Coil Driver Pod 3	D0902744	2	S1103329	±24VDC	
		1			
	Front		Rear		

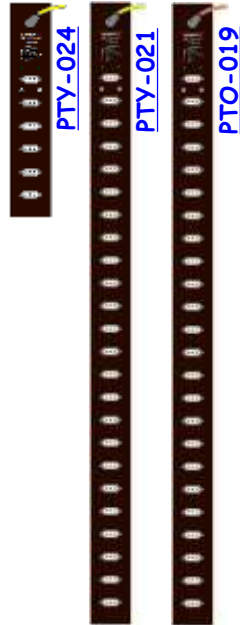

SEI-C6 is part of [D0901301](#)

L1-SEI-C6 Details

SEI-C6 is part of [D0901301](#)

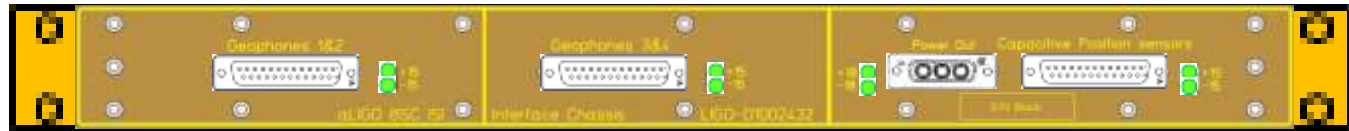

[D1002432](#)

Front

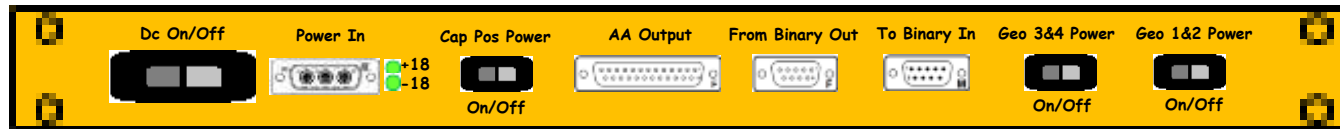

[S1201323](#)

Rear

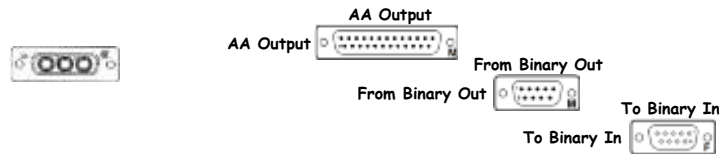

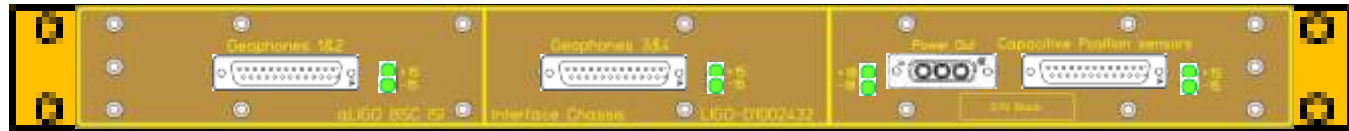

[D1002432](#)

Front

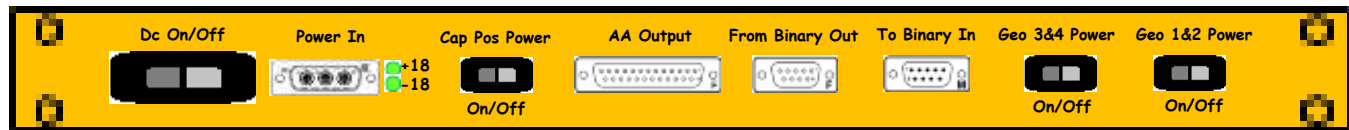

[S1201322](#)

Rear

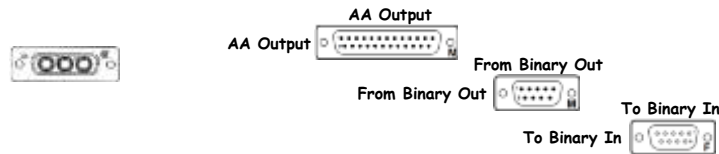

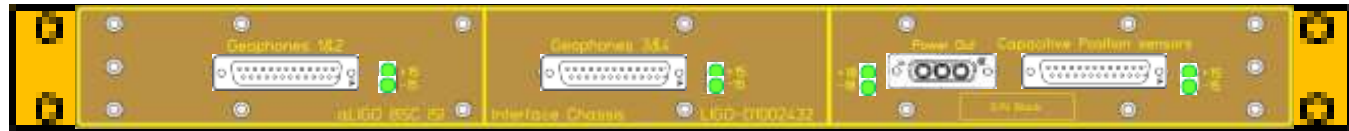

[D1002432](#)

Front

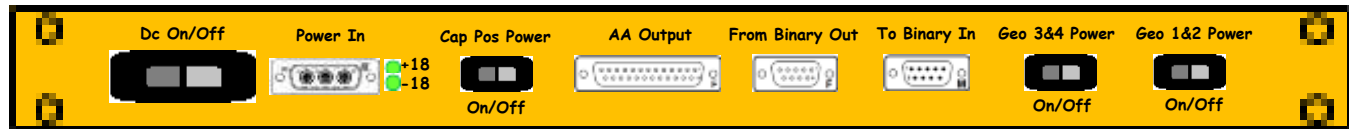

[S1201327](#)

Rear

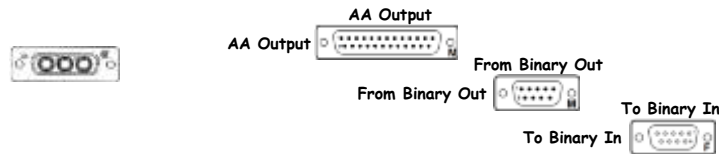

D1002693 - S1203102



<< L1-SEI-C6

BSC3 ISI Anti-Alias Chassis D1002693 S1203102 ±18VDC

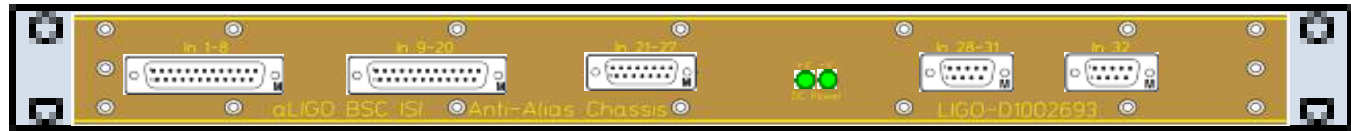

D1002693

Front

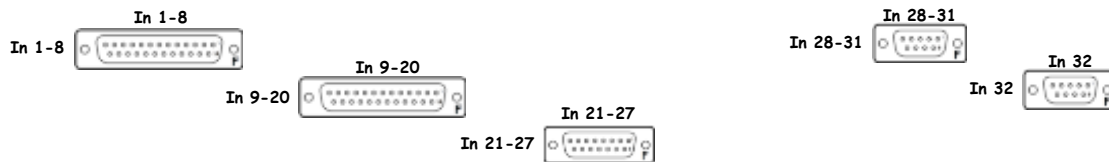

S1203102

Rear



BSC3 ISI Anti-Alias Chassis D1002693 S1203101 ±18VDC

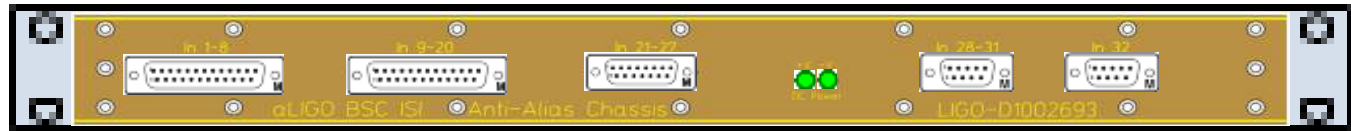

D1002693

Front

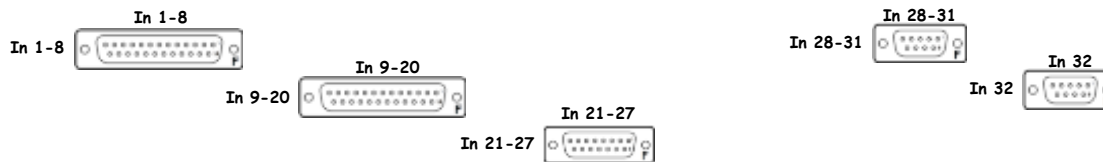

S1203101

Rear

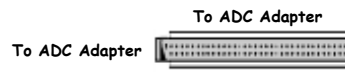

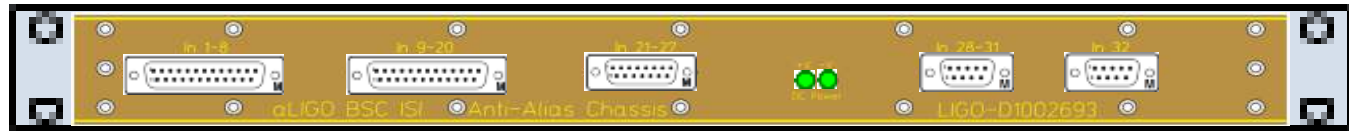

D1002693

Front

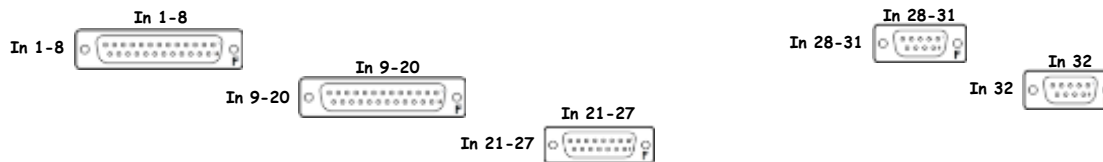

S1203100

Rear

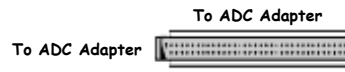



D1000272

Front

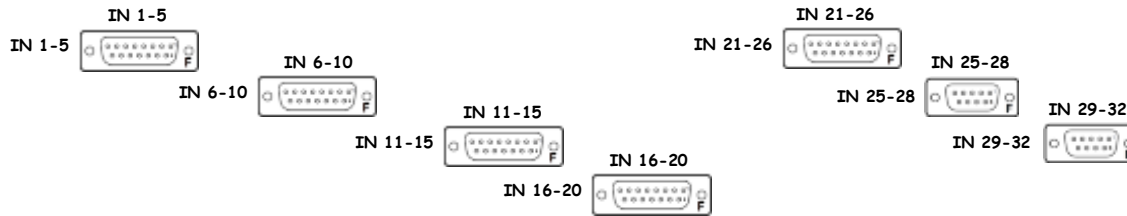

S1203002

Rear

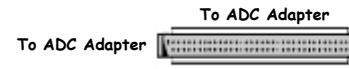

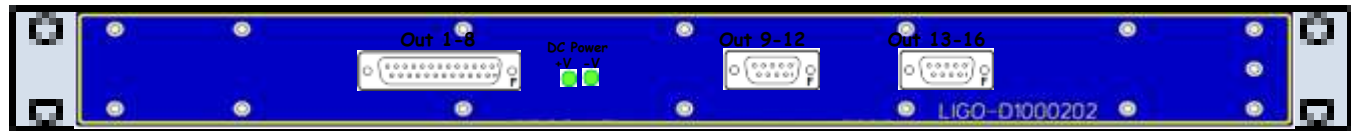

D1100202

Front



S1203132

Rear

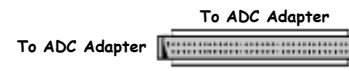



[D0900117](#)

Front

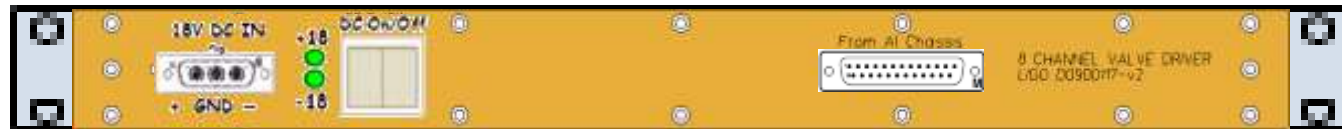
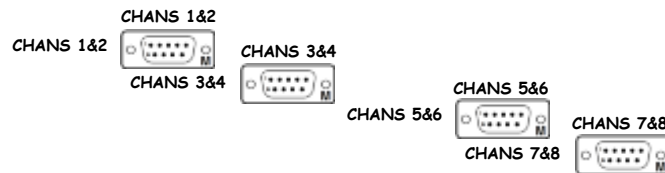

[S0900280](#)

Rear



[D0900117](#) is part of [D0901338](#)

BSC3 HEPI Binary Input Chassis D1001726 S1101299 +18VDC

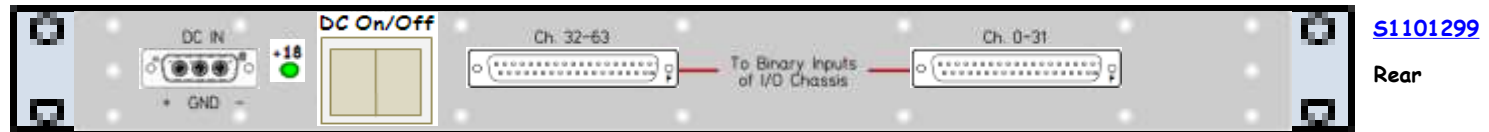
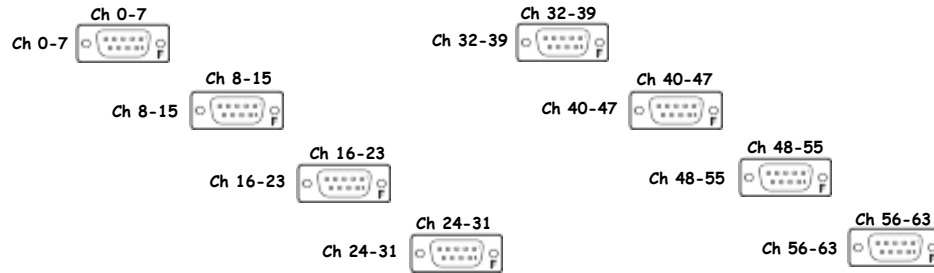

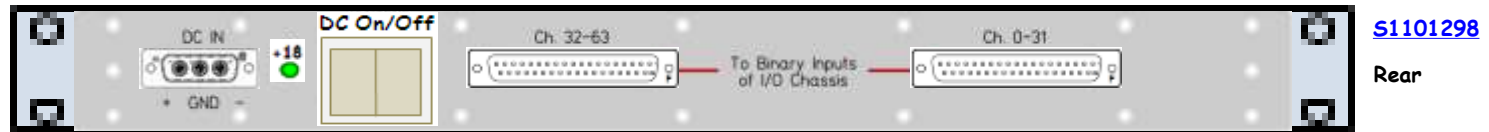
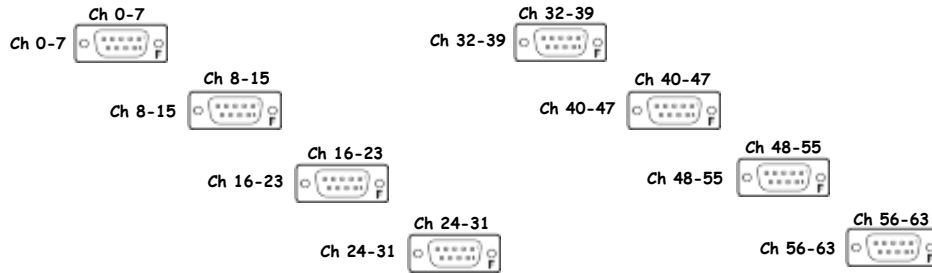

BSC3 HEPI Binary Output Chassis D1001728 S1101328 +18VDC

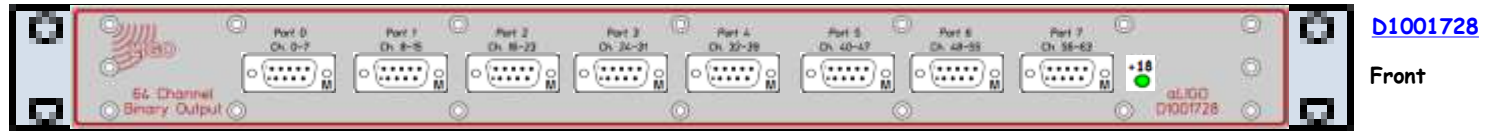

D1001728

Front

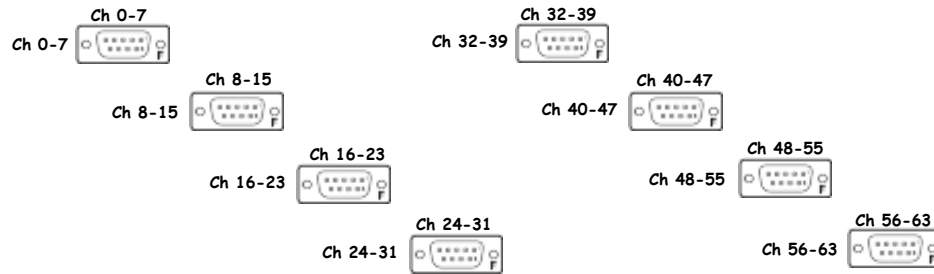

S1101328

Rear



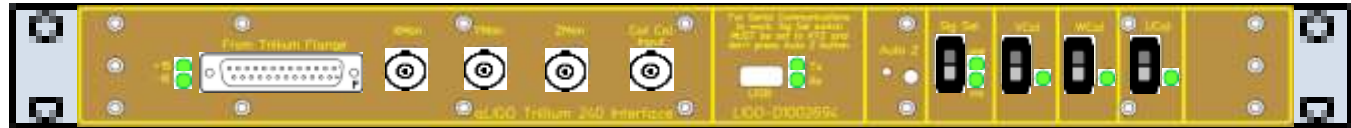

D1002694

Front

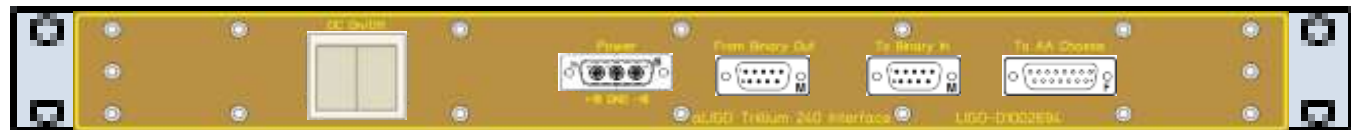
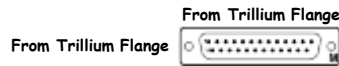

S1201892

Rear

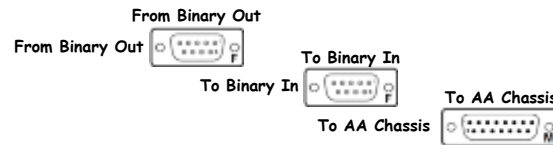



[D1002694](#)

Front

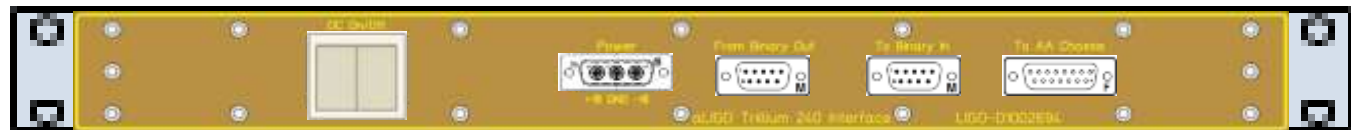
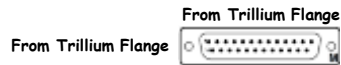

[S1104429](#)

Rear

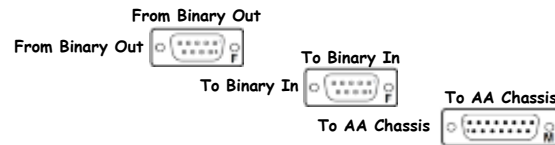



D1002694

Front

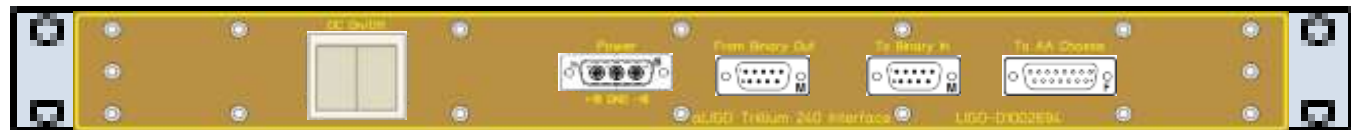
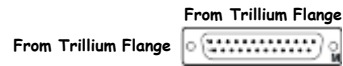

S1104428

Rear

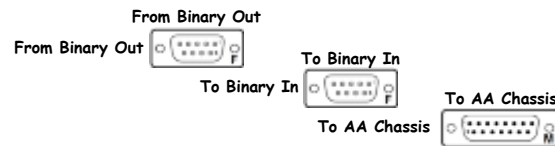

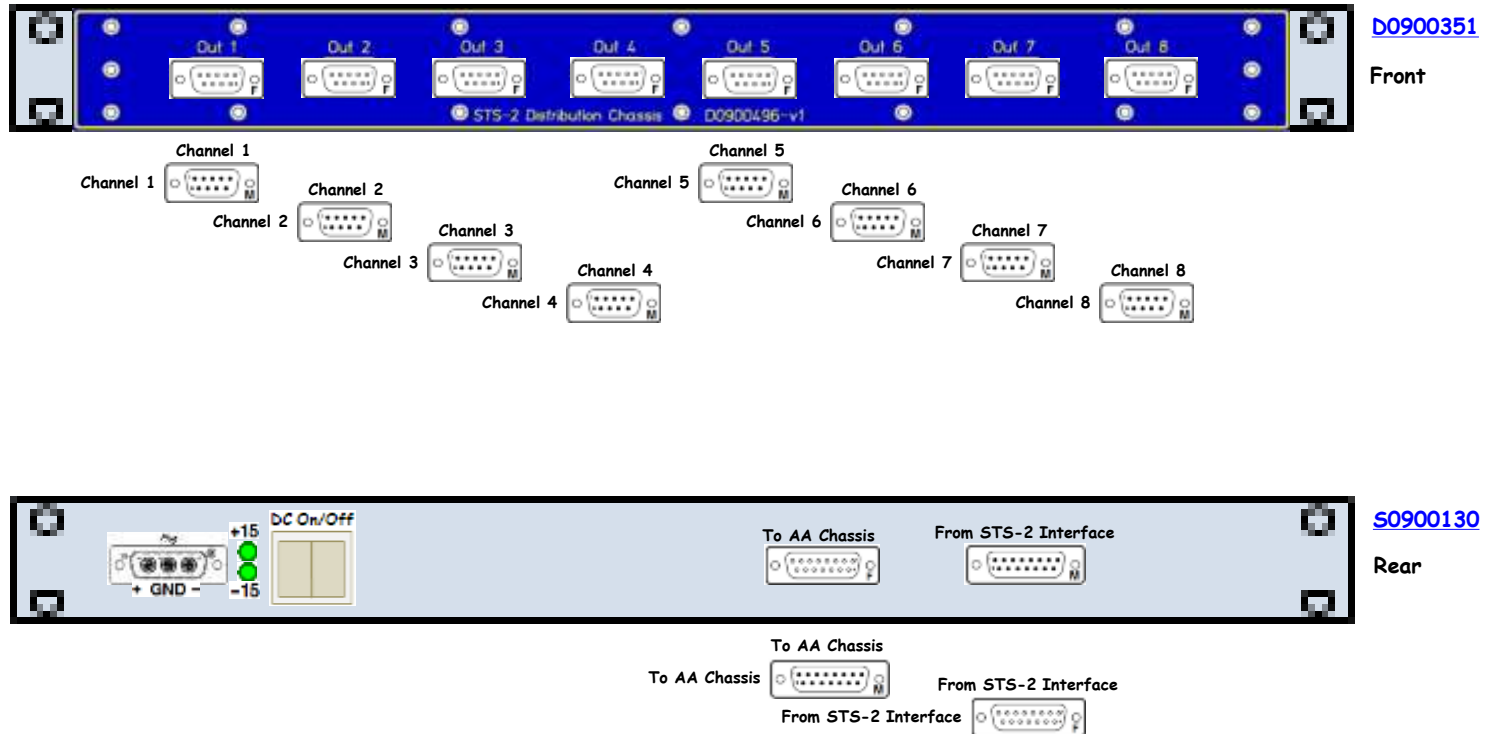

BSC3 STS-2 Interface Chassis

D080535

S0900092

±18VDC

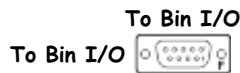
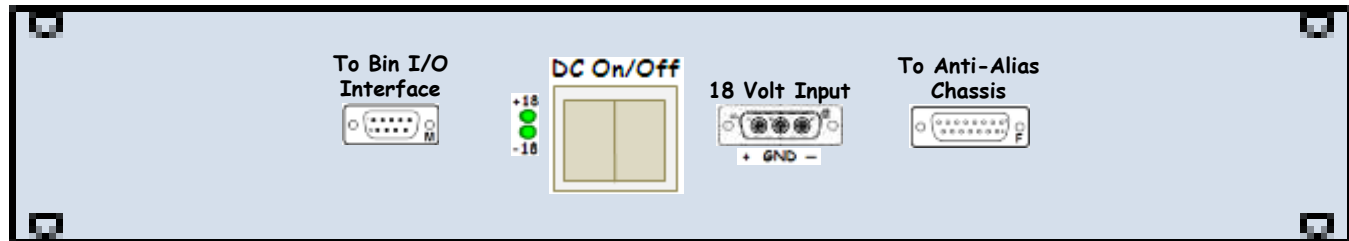
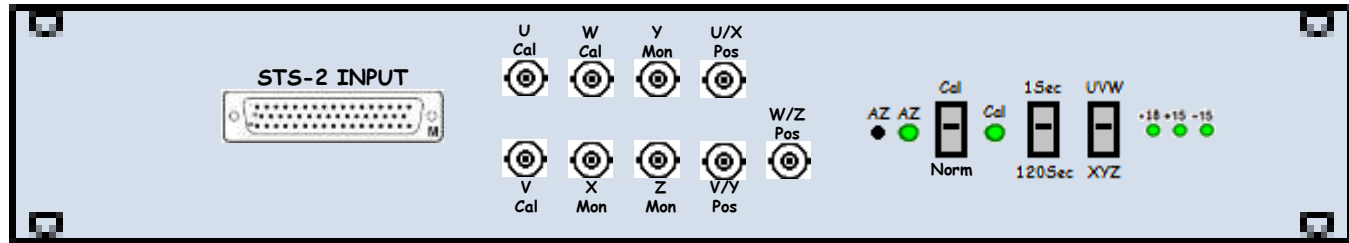

<< L1-SEI-C6

I1seibsc3 - I/O Extension Chassis

D1001715

S1100946

+24VDC

D1001715

Front

Timing Slot

I1seibsc3 – I/O Extender

S1100946

Rear

Uplink  L1:FE-IO-23

Slot E1  Open

Slot E2  Open

Slot E3  Open

Slot P1  Open

Slot P2  Open

Slot P3  Open

Slot P4  Open

Slot P5  Open

Slot P6  Open

Slot P7  Open

Slot P8  Open

Slot P9  Open

Slot P10  Open

L1:FE-IO-23

E1

E2

E3

P1

P2

P3

P4

P5

P6

P7

P8

P9

P10

Binary IO Card

Binary IO Card

ADC Card

ADC Card

ADC Card

ADC Card

ADC Card

ADC Card

ADC Card

ADC Card

ADC Card

ADC Card

PTY-024

+24VDC

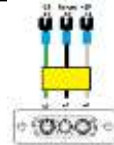

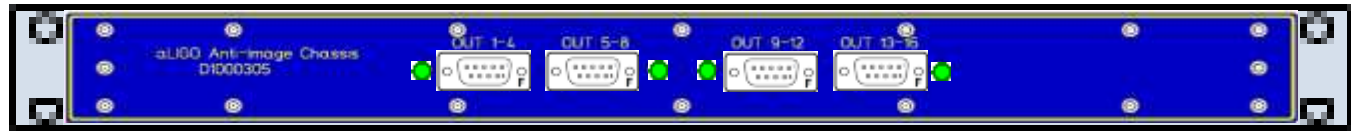

D1000305

Front

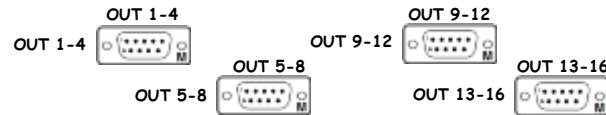

S1203269

Rear

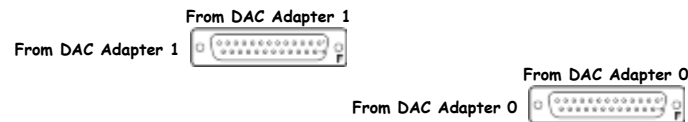



D0902744

Front



S1103565

Rear

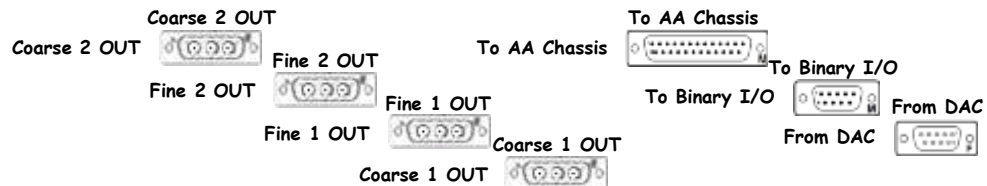

D0902744 - S1103315



<< L1-SEI-C6

BSC3 ISI Coil Driver Pod 2

D0902744

S1103315

±24VDC



D0902744

Front



S1103315

Rear

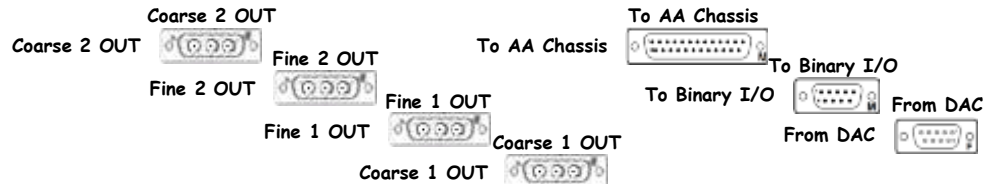



[D0902744](#)

Front

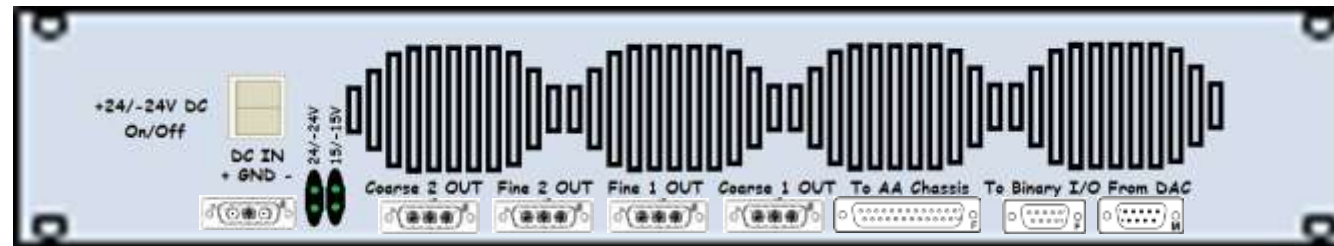

[S1103329](#)

Rear

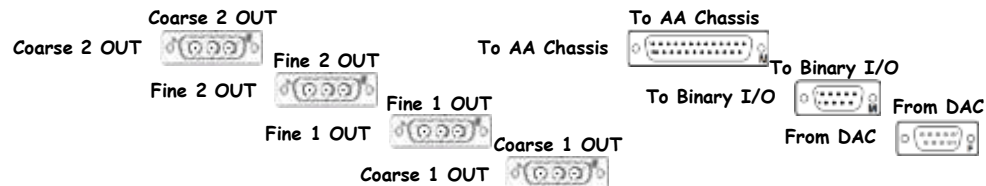

<< LLO Racks by Subsystem

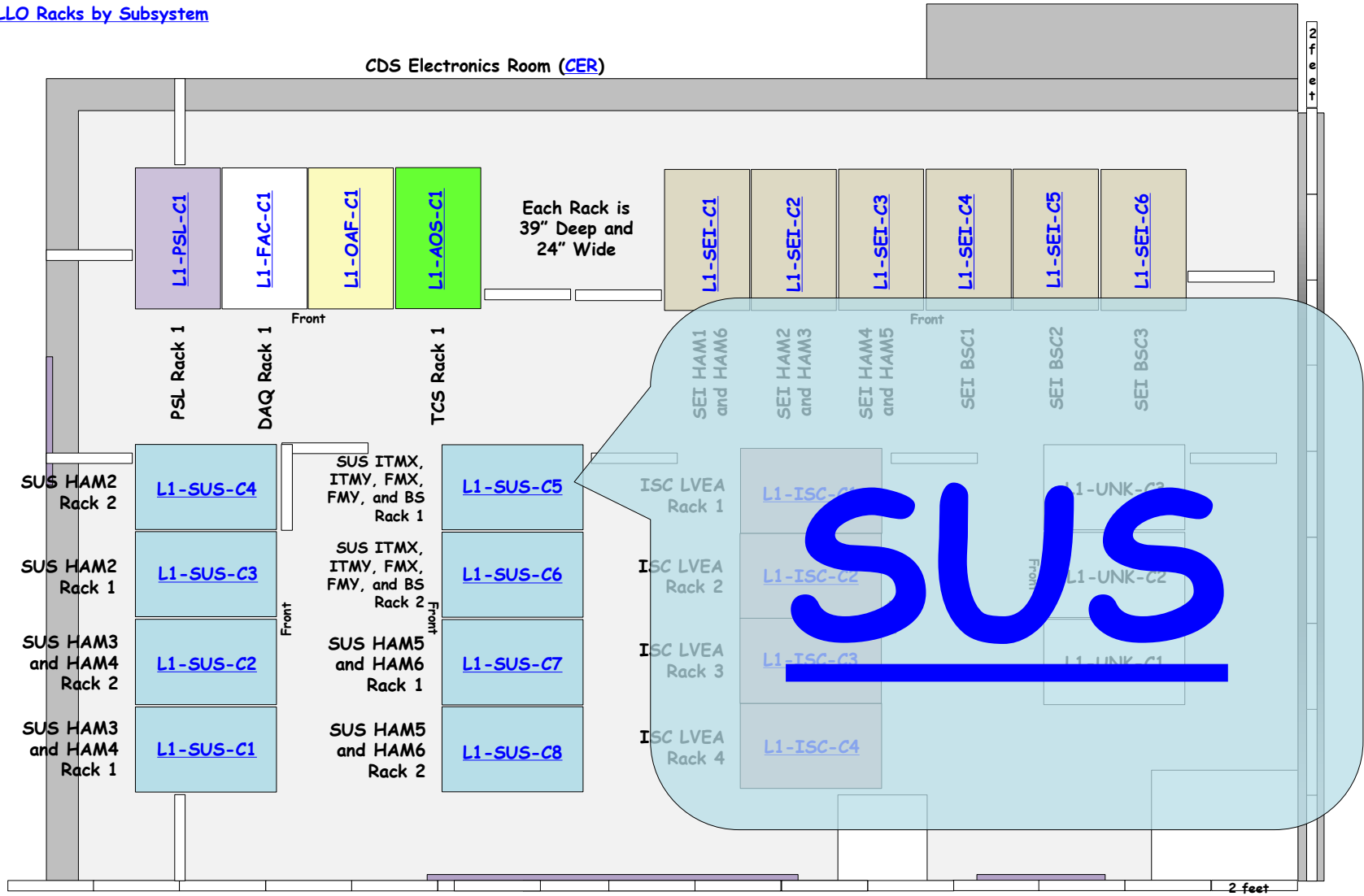

		42			
MC2-PR2 Triple Top Coil Driver Chassis	D1001242	41	S1000260		±18VDC
MC2-PR2 Triple Top Coil Driver Chassis	D1001242	40	S1000264		±18VDC
MC2-PR2 Triple Top Coil Driver Chassis	D1001242	39	S1000721		±18VDC
		38			
SR2 Triple Top Coil Driver Chassis	D1001242	37	S1000722		±18VDC
SR2 Triple Top Coil Driver Chassis	D1001242	36	S1000273		±18VDC
		35			
FE ADC0 Anti-Alias Chassis	D0902783	34	S1001157		±18VDC
FE ADC1 Anti-Alias Chassis	D0902783	33	S1100327		±18VDC
		32			
FE DAC0, FE DAC1 Anti-Image Chassis	D1000305	31	S1001197		±18VDC
FE DAC2, FE DAC3 Anti-Image Chassis	D1000305	30	S1001198		±18VDC
		29			
MC2 Mid Triple Acq Driver Chassis	D0900006	28	S1000347		±18VDC
MC2 Bot Triple Acq Driver Chassis	D0900006	27	S1000348		±18VDC
PR2 Mid Triple Acq Driver Chassis	D0900006	26	S1000349		±18VDC
		25			
FE DAC4, FE DAC5 Anti-Image Chassis	D1000305	24	S1101815		±18VDC
		23			
PR2 Bot Triple Acq Driver Chassis	D0900006	22	S1001186		±18VDC
SR2 Mid Triple Acq Driver Chassis	D0900006	21	S1001187		±18VDC
SR2 Bot Triple Acq Driver Chassis	D0900006	20	S1001188		±18VDC
		19			
BIO1 Binary Output Chassis	D1000725	18	S1101781		±18VDC
BIO1 Binary Input Chassis	D1000726	17	S1101805		±18VDC
BIO2 Binary Output Chassis	D1000725	16	S1101782		±18VDC
BIO2 Binary Input Chassis	D1000726	15	S1101802		±18VDC
		14			
		13			
		12			
		11			
		10			
		9			
		8			
		7			
		6			
		5			
		4			
		3			
		2			
		1			
	Front		Rear		



SUS-C1 is part of [D1000599](#).

L1-SUS-C1 Details

D1001242 - S1000260



<< L1-SUS-C1

MC2-PR2 Triple Top Coil Driver Chassis D1001242 S1000260 ±18VDC

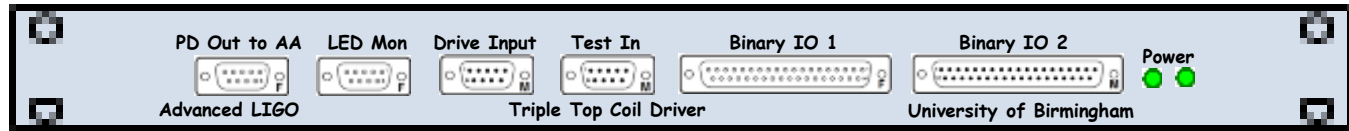

D1001242

Front

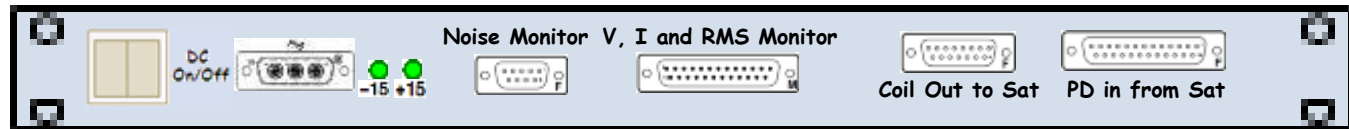
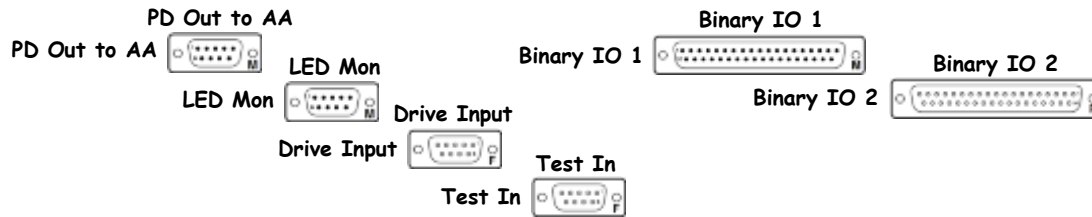

S1000260

Rear

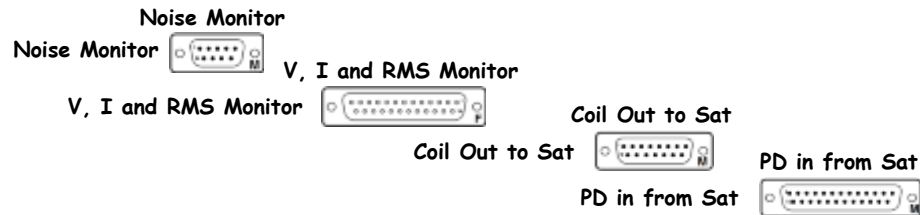

[Driver Board: D0902747](#)

[Monitor Board: D070480](#)

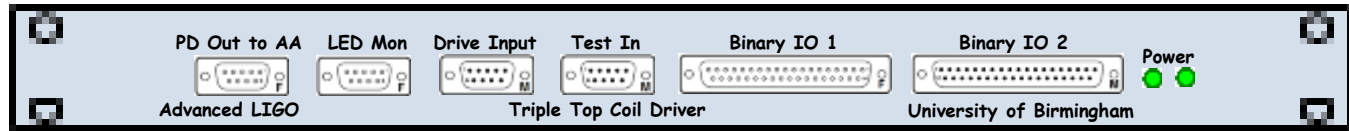

D1001242

Front

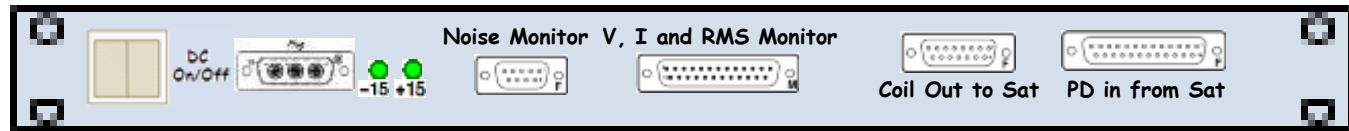
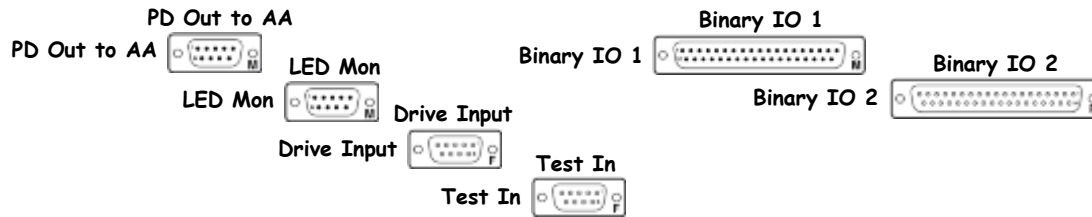

S1000264

Rear

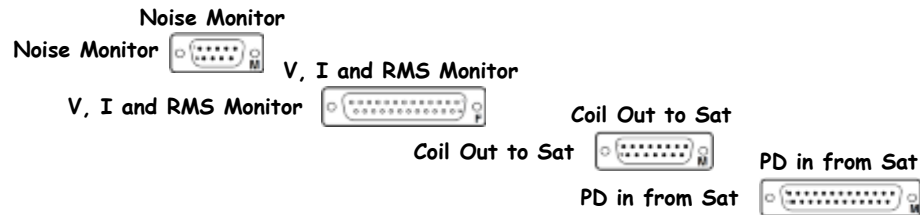

[Driver Board: D0902747](#)

[Monitor Board: D070480](#)

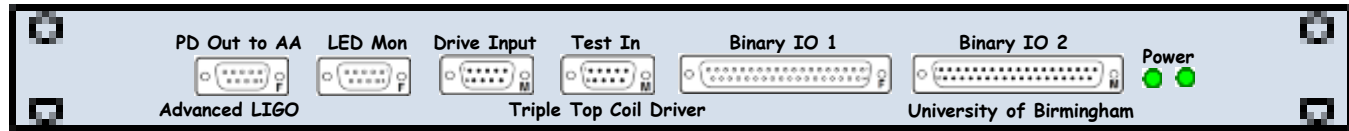

[D1001242](#)

Front

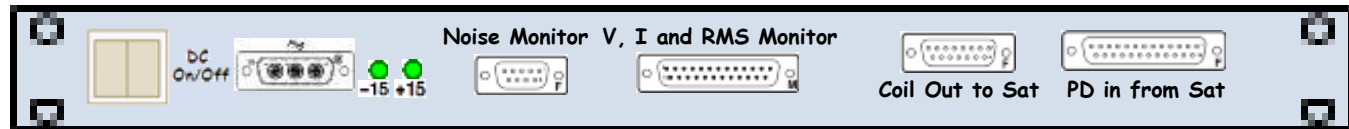
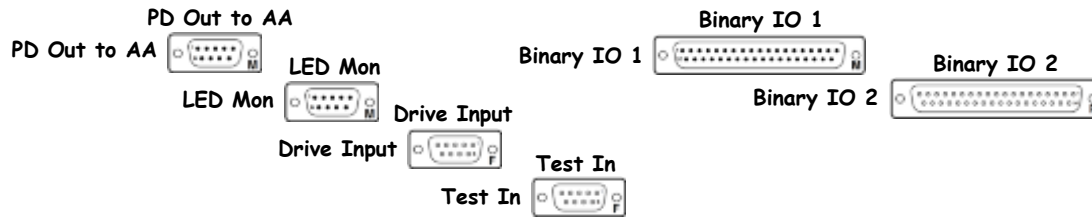

[S1000721](#)

Rear

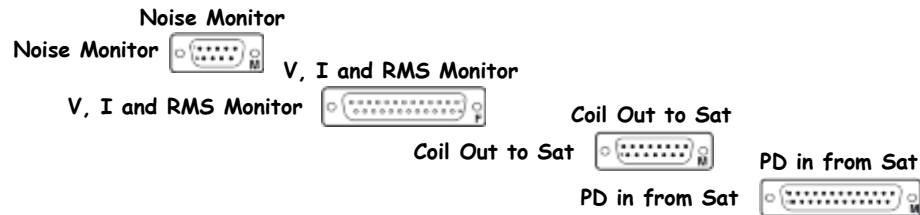

[Driver Board: D0902747](#)

[Monitor Board: D070480](#)

D1001242 - S1000722



<< L1-SUS-C1

SR2 Triple Top Coil Driver Chassis D1001242 S1000722 ±18VDC

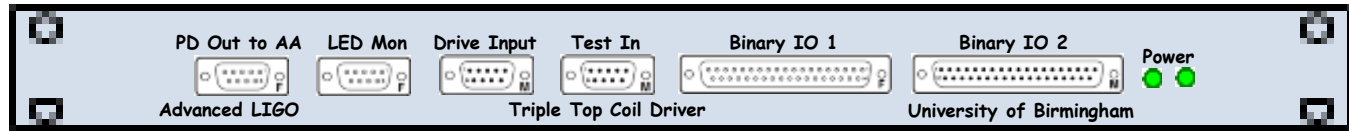

[D1001242](#)

Front

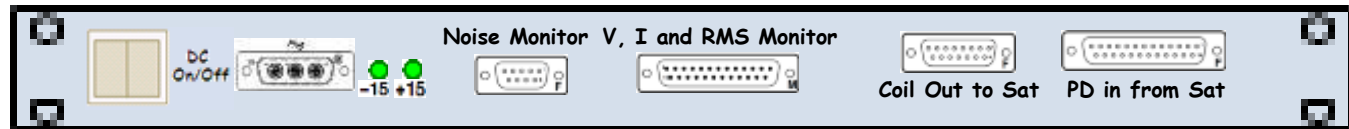
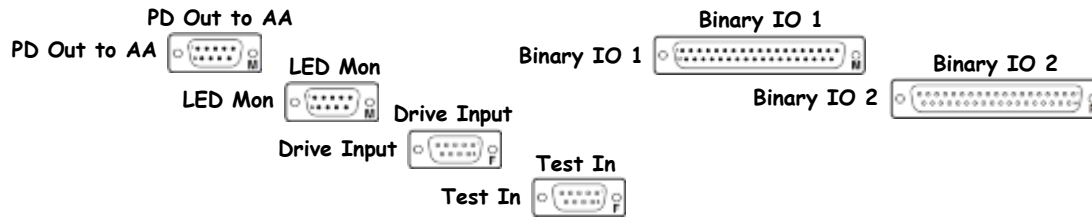

[S1000722](#)

Rear

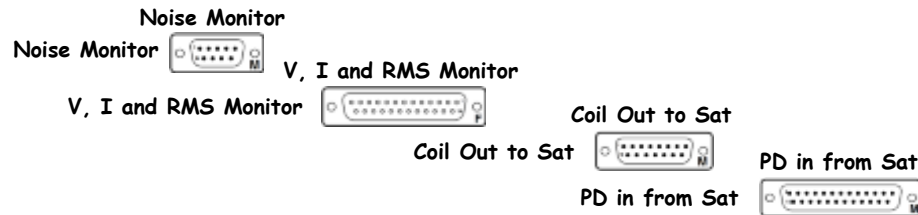

[Driver Board: D0902747](#)

[Monitor Board: D070480](#)

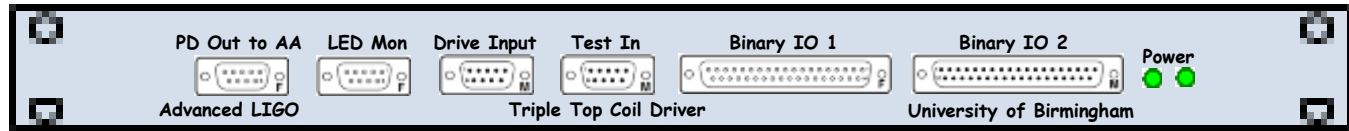

[D1001242](#)

Front

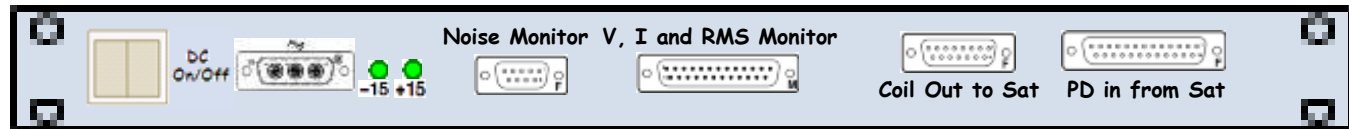
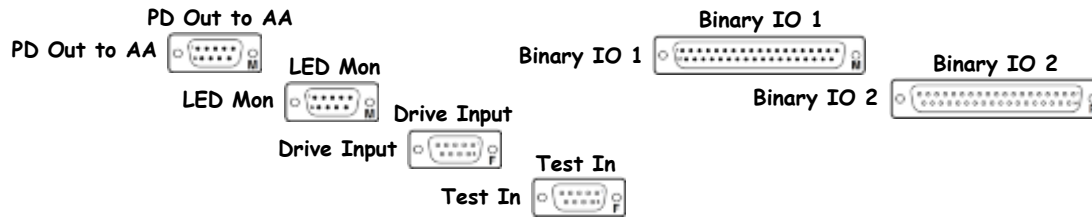

[S1000273](#)

Rear

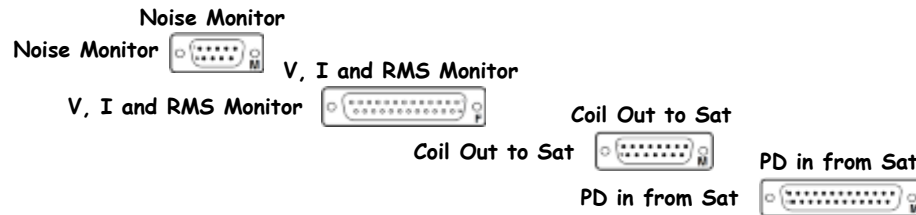

[Driver Board: D0902747](#)

[Monitor Board: D070480](#)



[D0902783](#)

Front

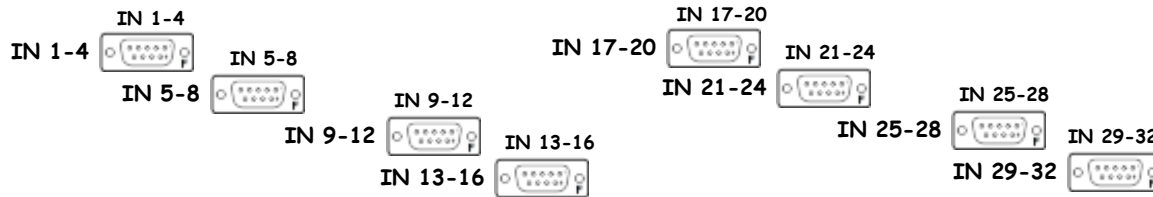

[S1001157](#)

Rear



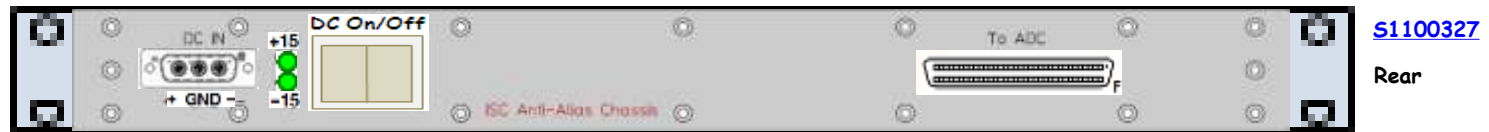
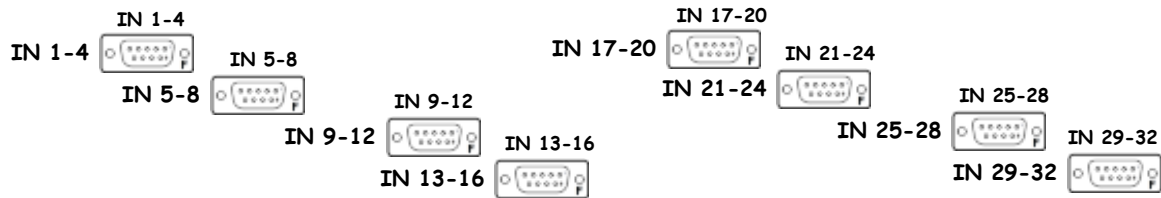
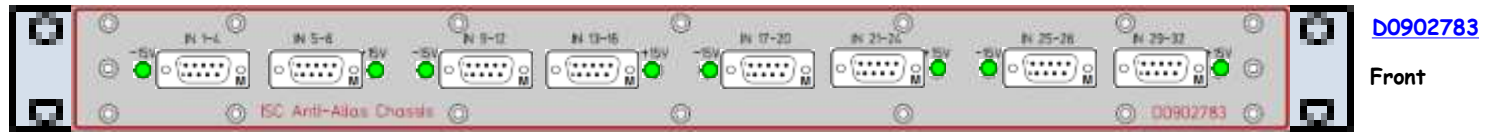

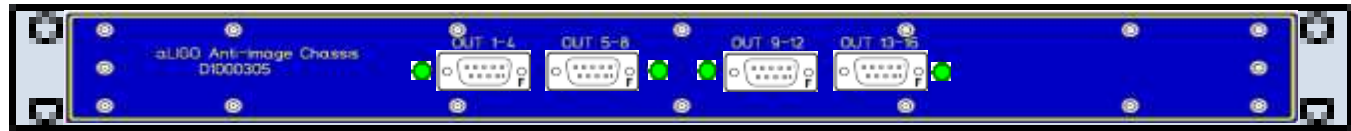

D1000305

Front

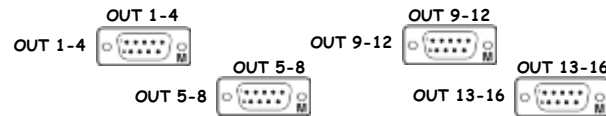

S1001197

Rear

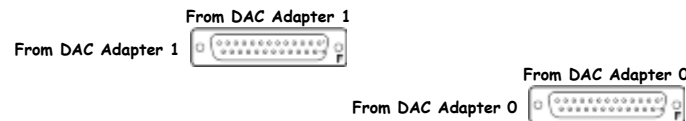

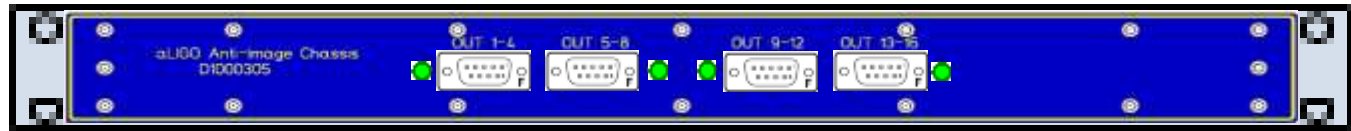

D1000305

Front

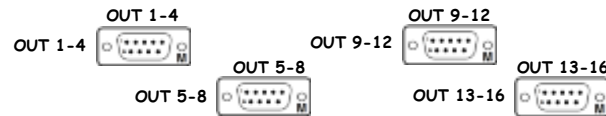

S1001198

Rear

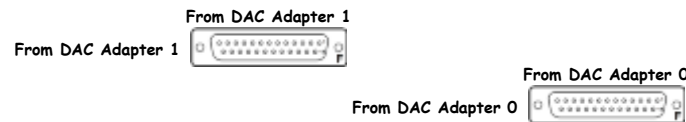

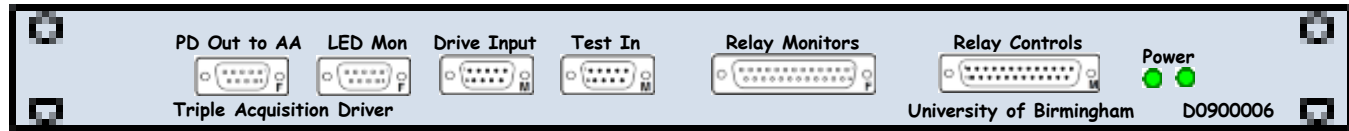

[D0900006](#)

Front

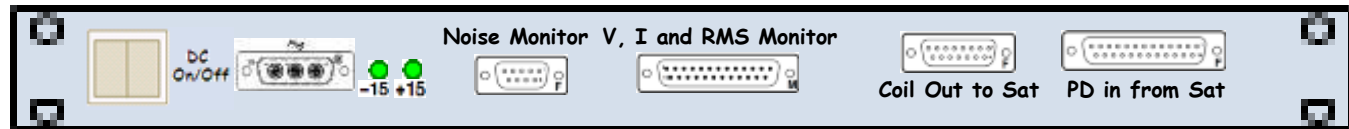
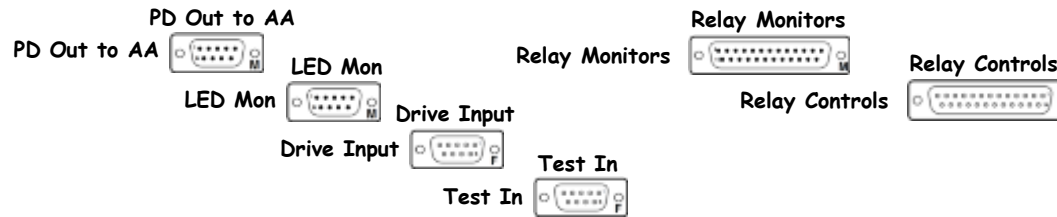

[S1000347](#)

Rear

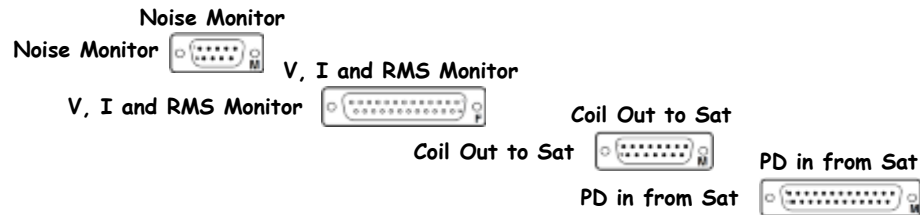

[Driver Board: D0901047](#)
[Monitor Board: D070480](#)

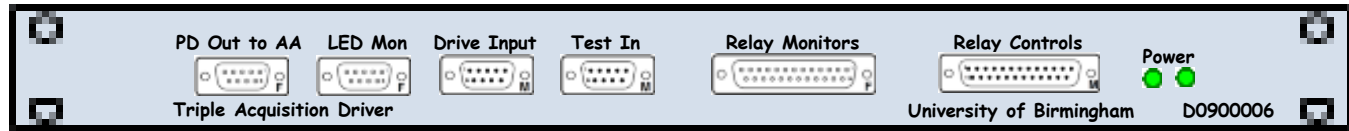

[D0900006](#)

Front

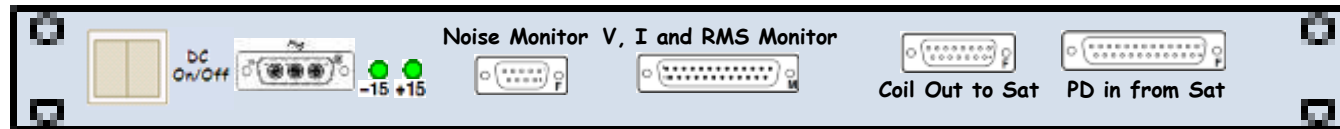
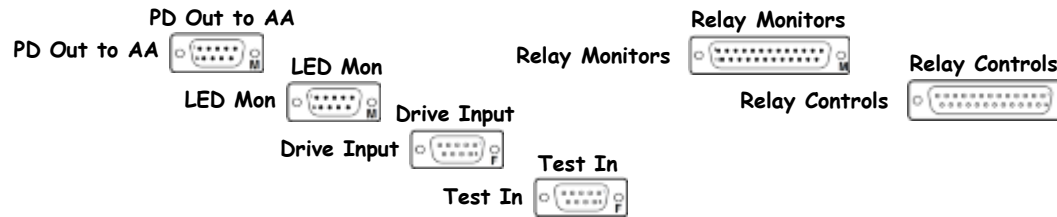

[S1000348](#)

Rear

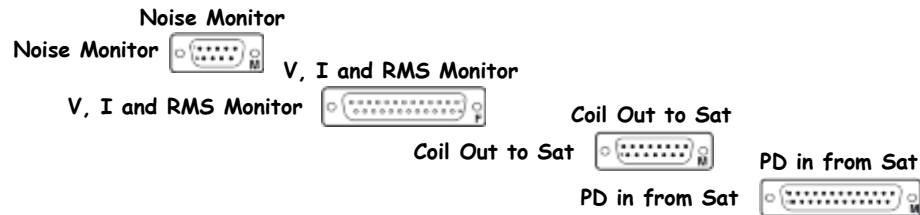

[Driver Board: D0901047](#)
[Monitor Board: D070480](#)

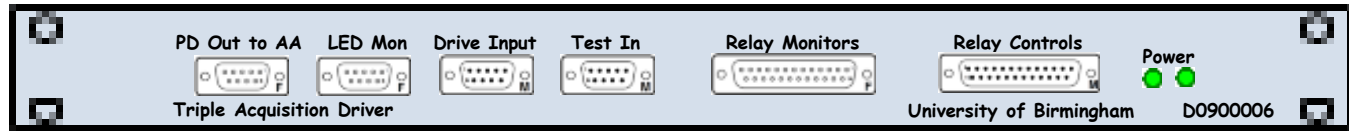

[D0900006](#)

Front

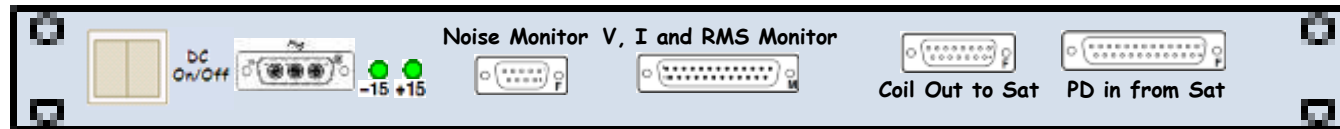
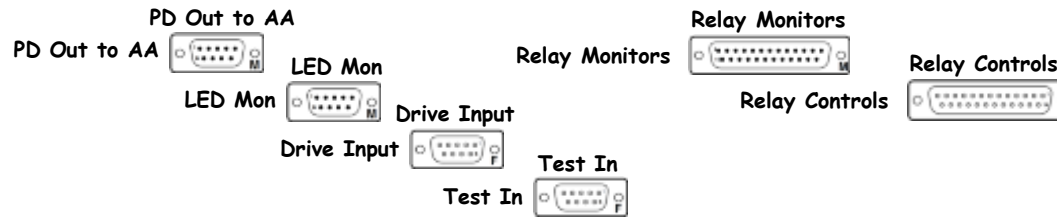

[S1000349](#)

Rear

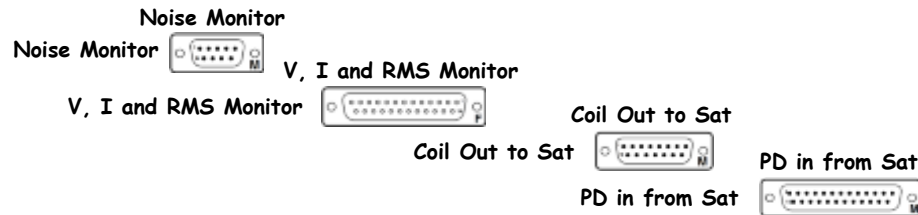

[Driver Board: D0901047](#)
[Monitor Board: D070480](#)

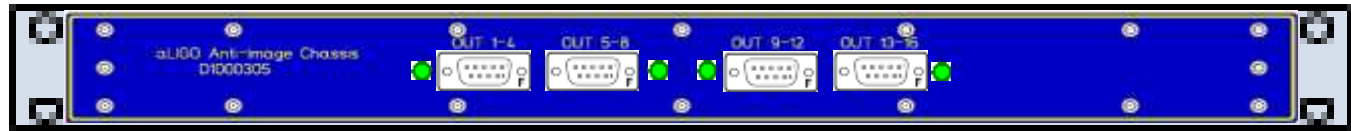

D1000305

Front

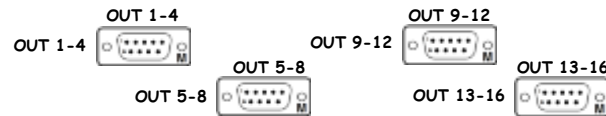

S1101815

Rear

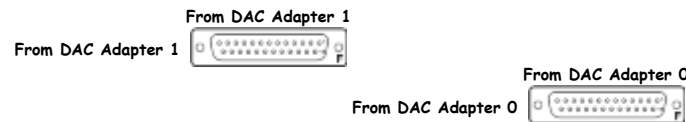

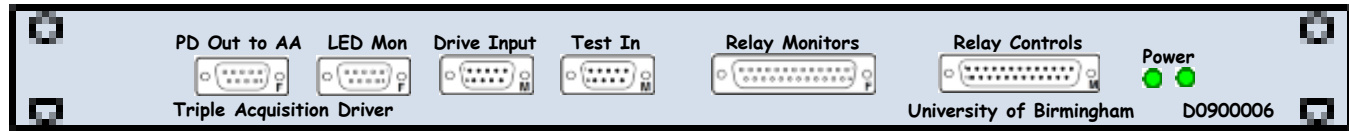

D0900006

Front

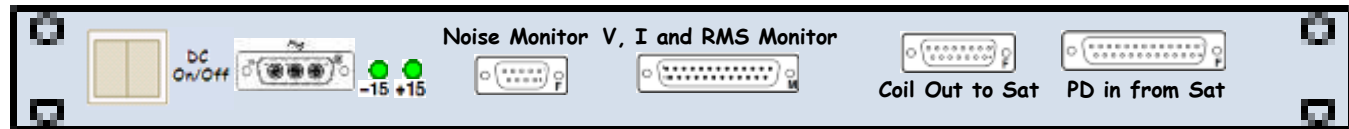
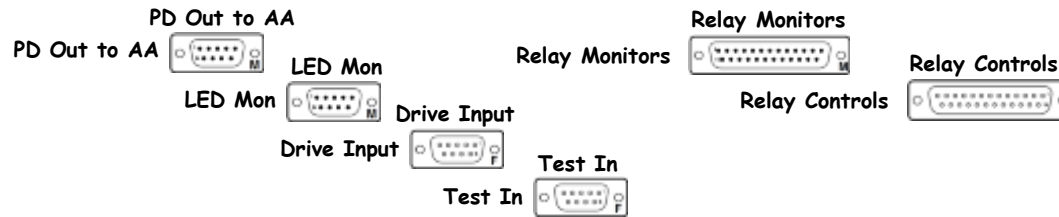

S1001186

Rear

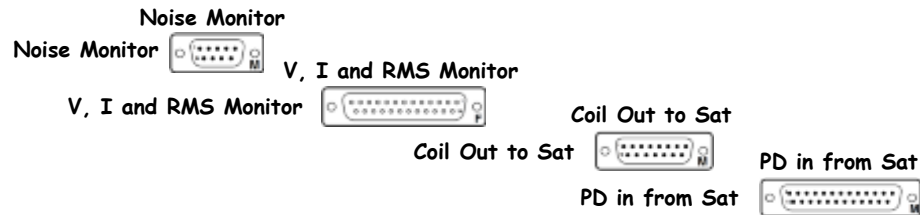

[Driver Board: D0901047](#)

[Monitor Board: D070480](#)

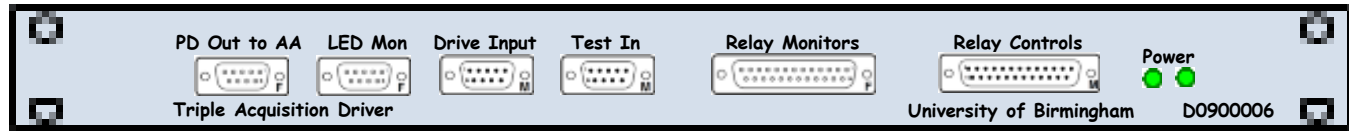

[D0900006](#)

Front

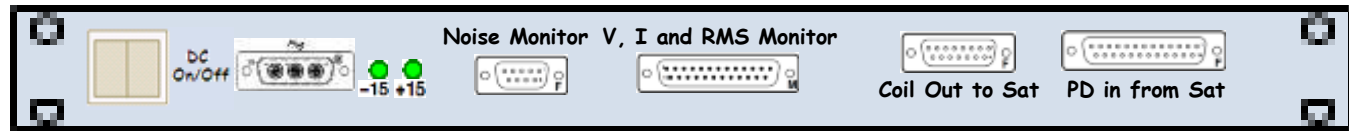
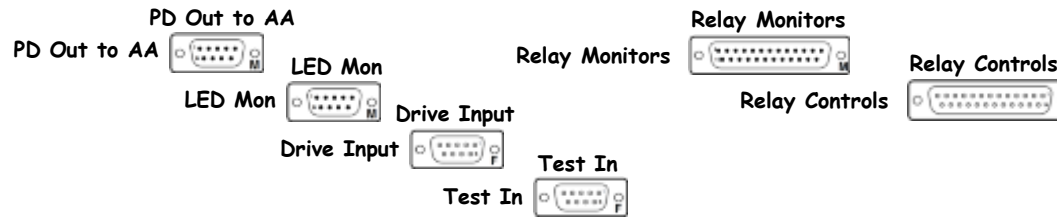

[S1001187](#)

Rear

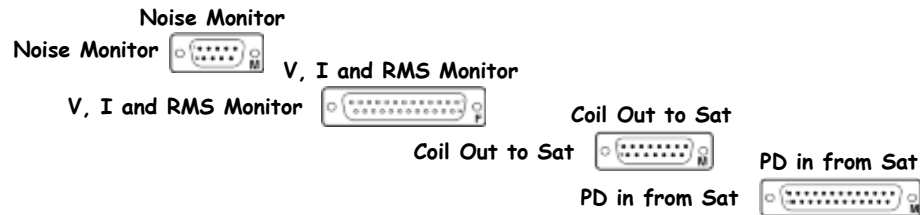

[Driver Board: D0901047](#)

[Monitor Board: D070480](#)

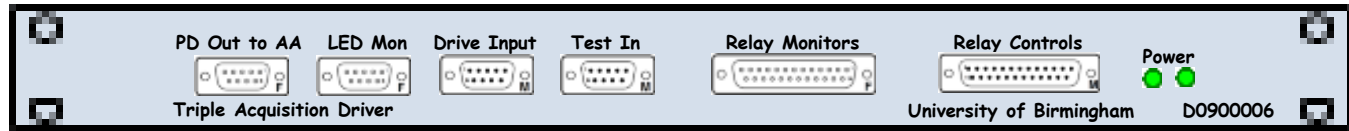

[D0900006](#)

Front

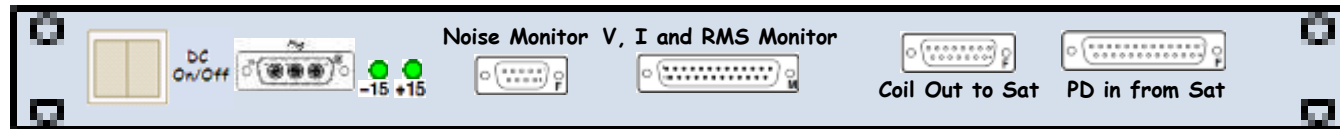
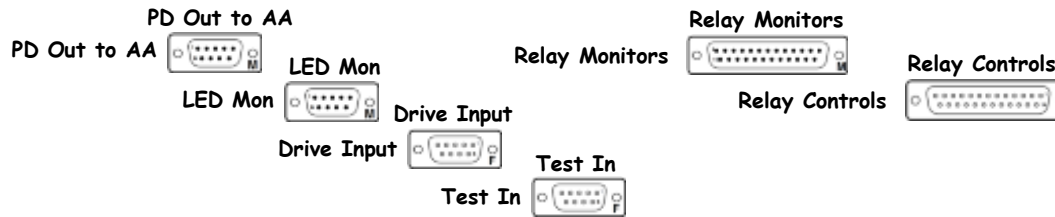

[S1001188](#)

Rear

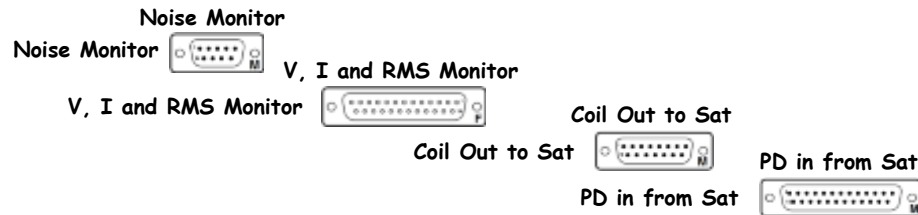

[Driver Board: D0901047](#)

[Monitor Board: D070480](#)

BIO1 Binary Output Chassis D1000725 S1101781 ±18VDC



[D1000725](#)

Front

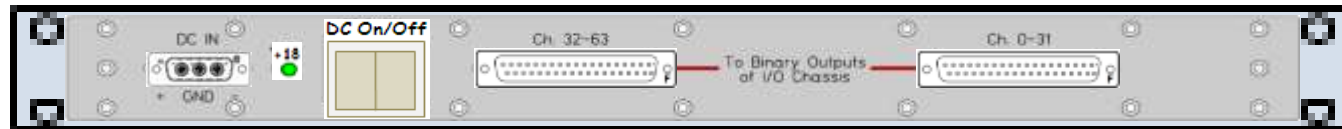
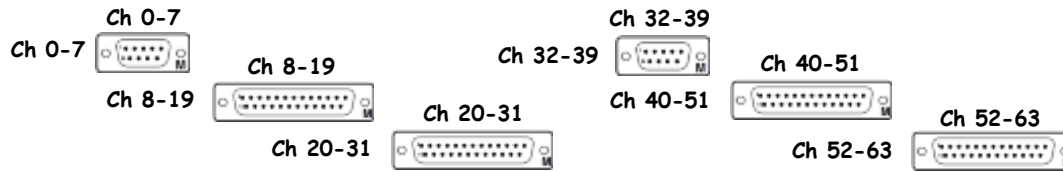

[S1101781](#)

Rear

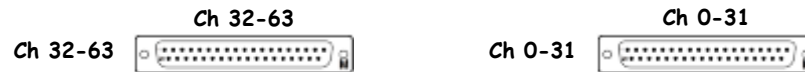



D1000726

Front

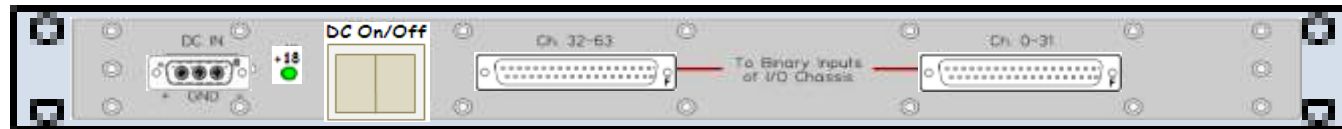
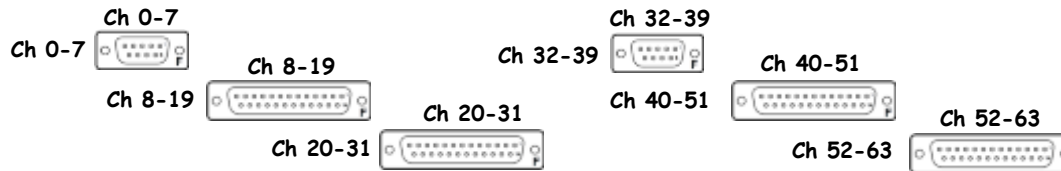

S1101805

Rear



BIO2 Binary Output Chassis D1000725 S1101782 ±18VDC



D1000725

Front

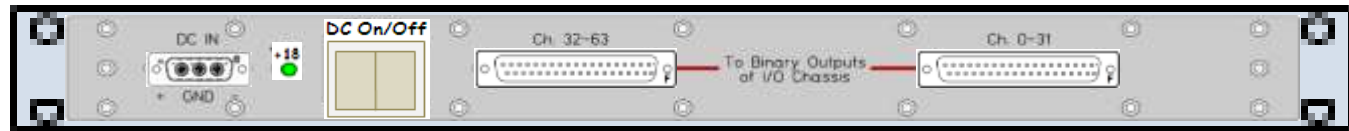
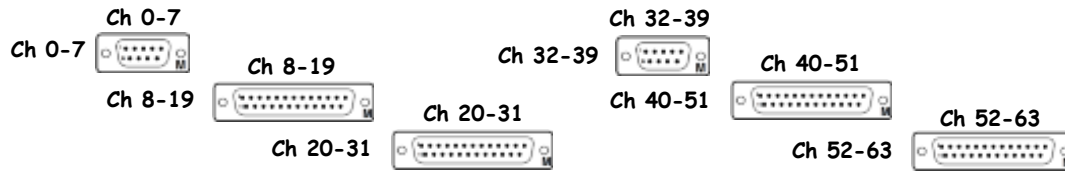

S1101782

Rear





D1000726

Front

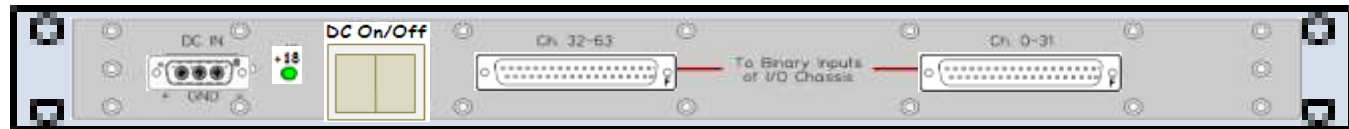
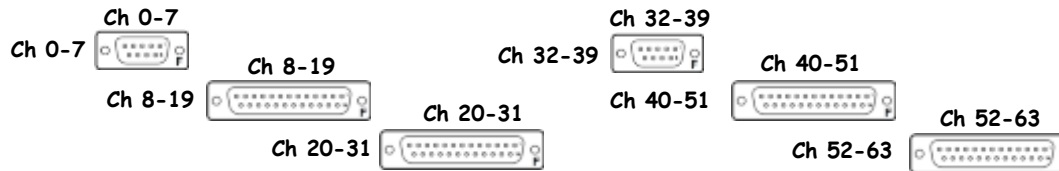

S1101802

Rear



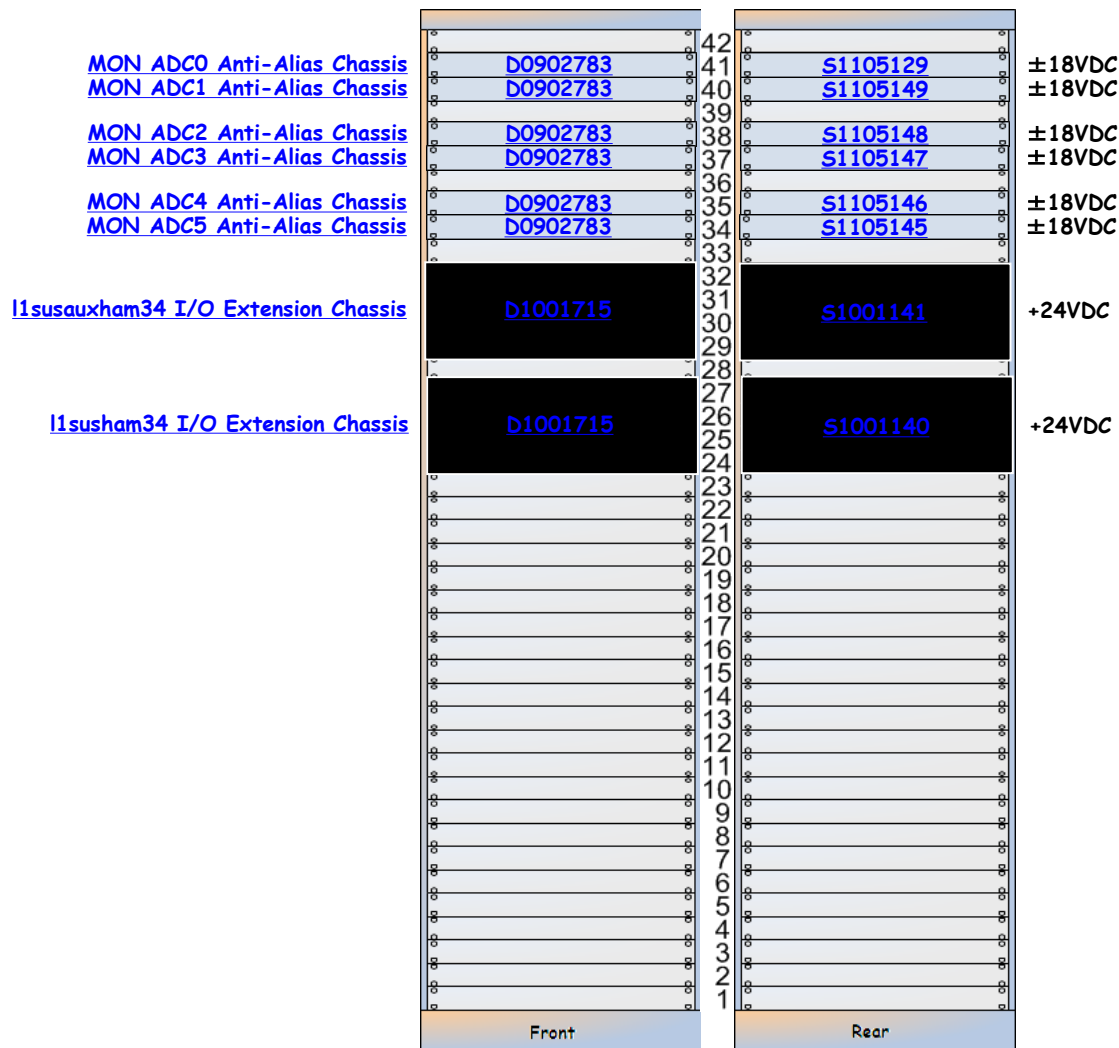

SUS-C2 is part of [D1000599](#).

L1-SUS-C2 Details



[D0902783](#)

Front

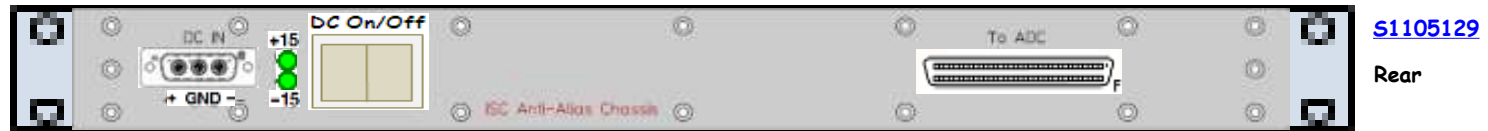
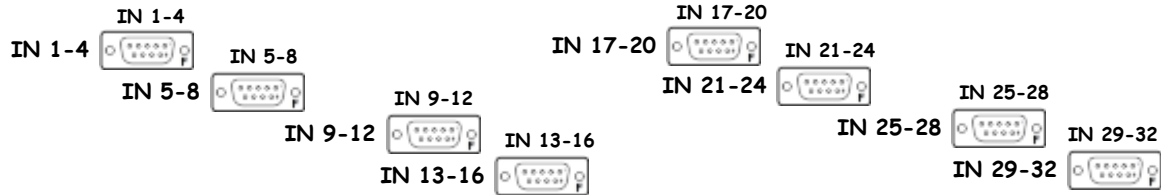

[S1105129](#)

Rear



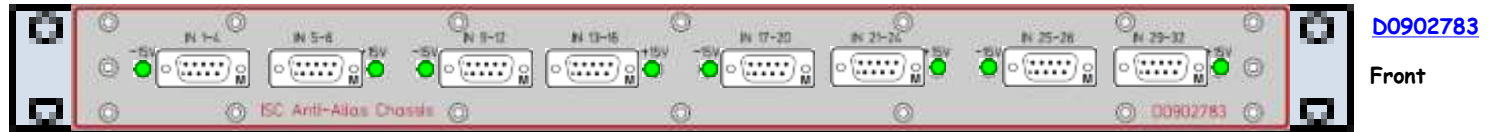

[D0902783](#)

Front

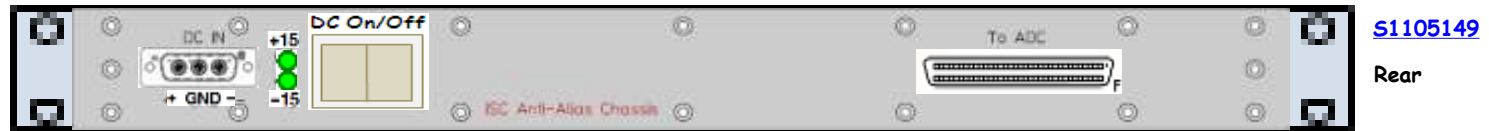
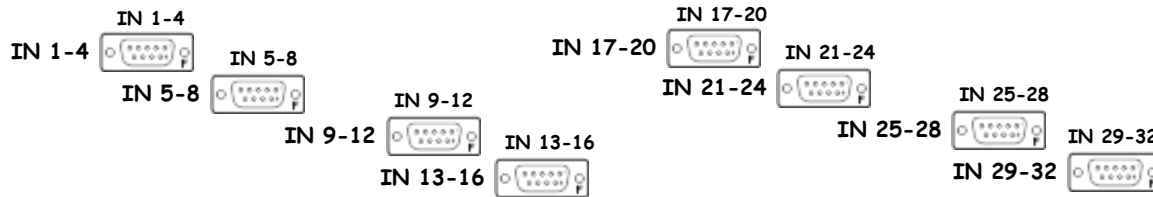

[S1105149](#)

Rear



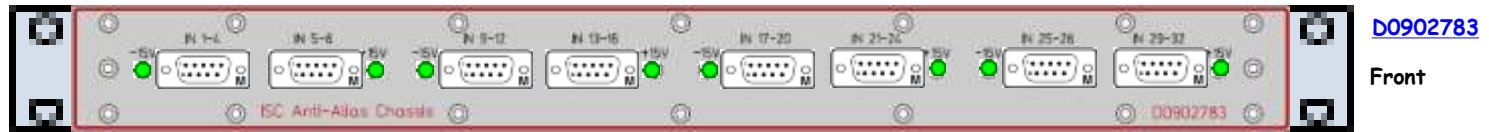

[D0902783](#)

Front

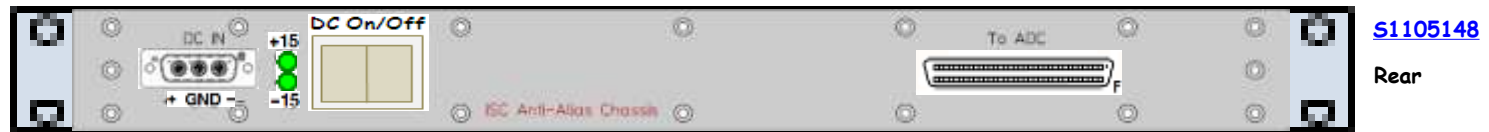
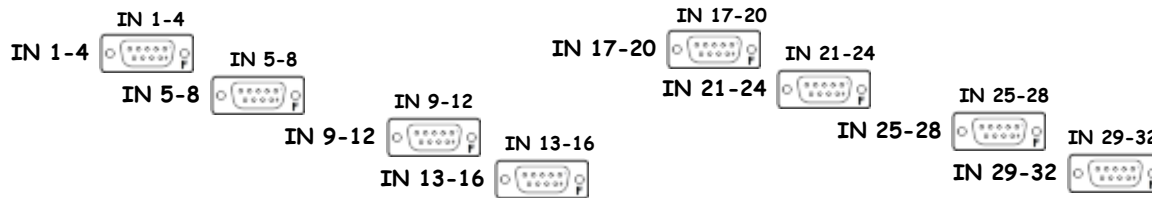

[S1105148](#)

Rear





[D0902783](#)

Front

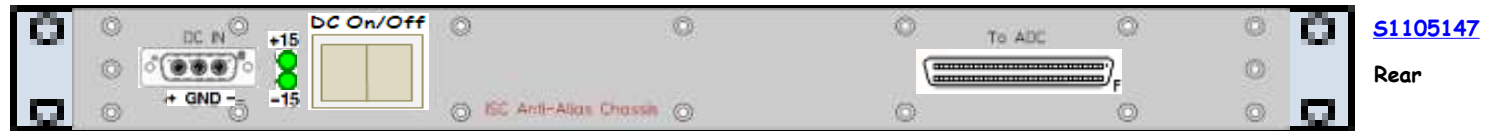
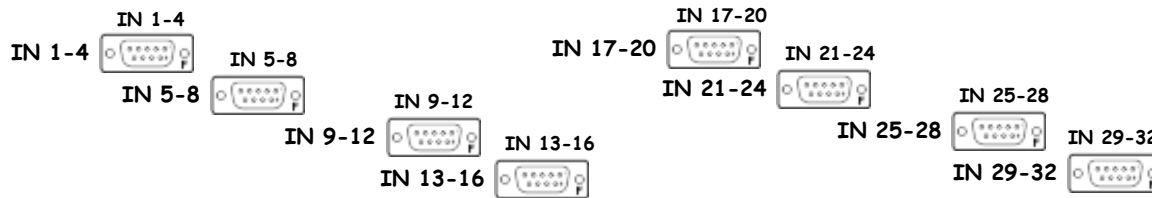

[S1105147](#)

Rear



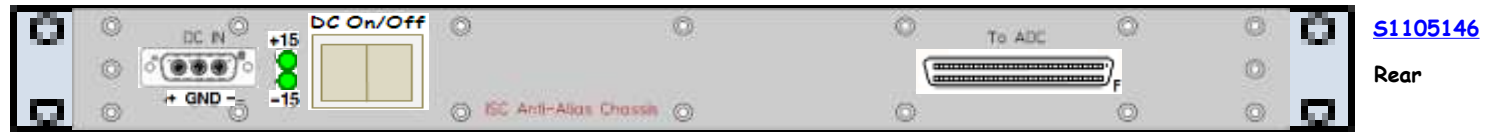
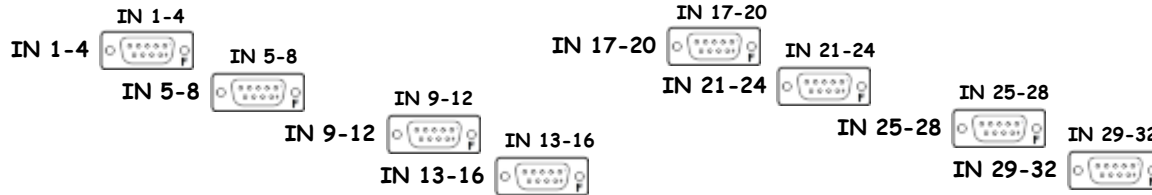



[D0902783](#)

Front

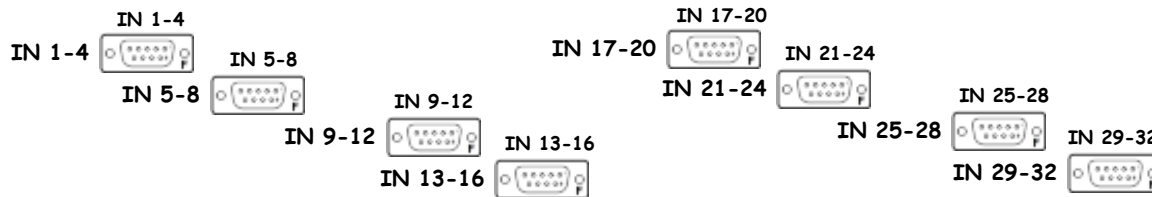

[S1105145](#)

Rear



Timing Slot

I1susauxham34 – I/O Extender

TB-03

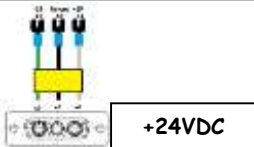
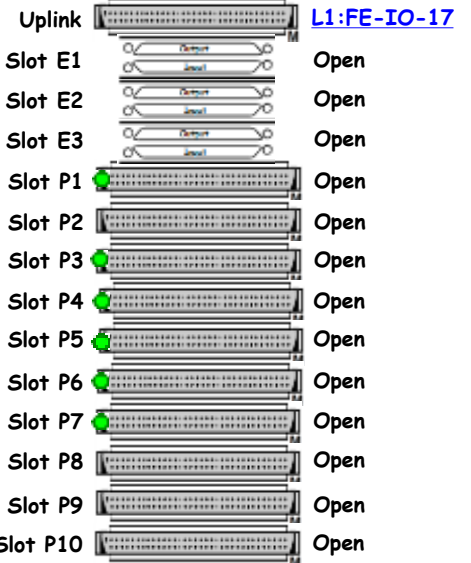
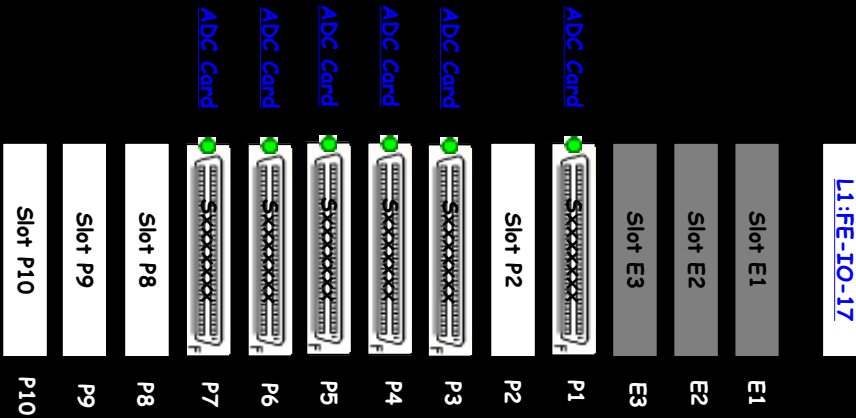

<< L1-SUS-C2

I1susham34 I/O Extension Chassis

D1001715

S1001140

+24VDC

D1001715

Front

Timing Slot

I1susham34 – I/O Extender

S1001140

Rear

Uplink [L1:FE-IO-13](#)

Slot E1 Open

Slot E2 Open

Slot E3 Open

Slot P1 Open

Slot P2 Open

Slot P3 Open

Slot P4 Open

Slot P5 Open

Slot P6 Open

Slot P7 Open

Slot P8 Open

Slot P9 Open

Slot P10 Open

L1:FE-IO-13

Sxxxxxxx

Binary IO Card

Sxxxxxxx

E1

Binary IO Card

Sxxxxxxx

E2

Slot E3

E3

ADC Card

Sxxxxxxx

P1

DAC18 Card

Sxxxxxxx

P2

ADC Card

Sxxxxxxx

P3

DAC18 Card

Sxxxxxxx

P4

DAC18 Card

Sxxxxxxx

P5

DAC18 Card

Sxxxxxxx

P6

DAC18 Card

Sxxxxxxx

P7

DAC18 Card

Sxxxxxxx

P8

Slot P9

P9

Slot P10

P10

TB-03

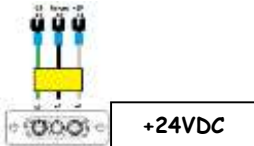

		42			
MON ADC0 Anti-Alias Chassis	D1000721	41	S1105265	$\pm 18\text{VDC}$	
MON ADC1 Anti-Alias Chassis	D1000721	40	S1105289	$\pm 18\text{VDC}$	
		39			
MON ADC2 Anti-Alias Chassis	D1000721	38	S1105290	$\pm 18\text{VDC}$	
MON ADC3 Anti-Alias Chassis	D1000721	37	S1105291	$\pm 18\text{VDC}$	
		36			
MON ADC4 Anti-Alias Chassis	D1000721	35	S1105292	$\pm 18\text{VDC}$	
MON ADC5 Anti-Alias Chassis	D1000721	34	S1105293	$\pm 18\text{VDC}$	
		33			
MON ADC6 Anti-Alias Chassis	D1000721	32	S1105294	$\pm 18\text{VDC}$	
MON ADC7 Anti-Alias Chassis (8*DB9)	D0902783	31	S1100335	$\pm 18\text{VDC}$	
		30			
		29			
		28			
		27			
l1susauxham2 I/O Extension Chassis	D1001715	26	S1103891	+24VDC	
		25			
		24			
l1susham2a I/O Extension Chassis	D1001715	23	S1001133	+24VDC	
		22			
		21			
		20			
l1susham2b I/O Extension Chassis	D1001715	19	S1001139	+24VDC	
		18			
		17			
		16			
FE1 BIO0 Binary Output Chassis	D1000725	15	S1104838	$\pm 18\text{VDC}$	
FE1 BIO0 Binary Input Chassis	D1000726	14	S1104460	$\pm 18\text{VDC}$	
FE1 BIO1 Binary Output Chassis	D1000725	13	S1104841	$\pm 18\text{VDC}$	
FE1 BIO1 Binary Input Chassis	D1000726	12	S1104457	$\pm 18\text{VDC}$	
FE1 BIO2 Binary Output Chassis (8*DB9)	D1002593	11	S1101772	$\pm 18\text{VDC}$	
FE1 BIO2 Binary Input Chassis (8*DB9)	D1001726	10	S1101283	$\pm 18\text{VDC}$	
		9			
		8			
FE2 BIO0 Binary Output Chassis (8*DB9)	D1002593	7	S1101773	$\pm 18\text{VDC}$	
FE2 BIO0 Binary Input Chassis (8*DB9)	D1001726	6	S1101315	$\pm 18\text{VDC}$	
		5			
		4			
		3			
		2			
		1			
	Front		Rear		

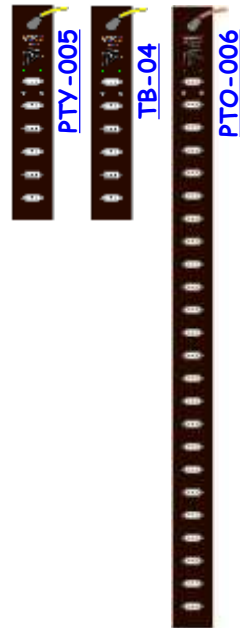

SUS-C3 is part of [D0902810](#).

L1-SUS-C3 Details

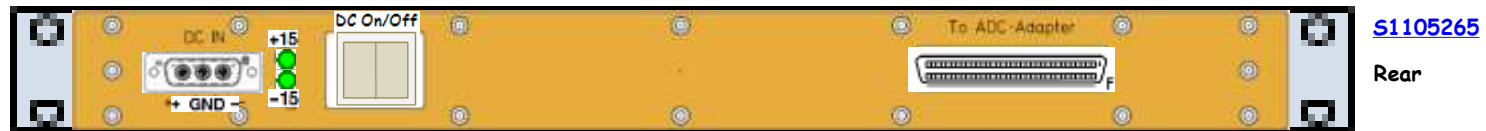
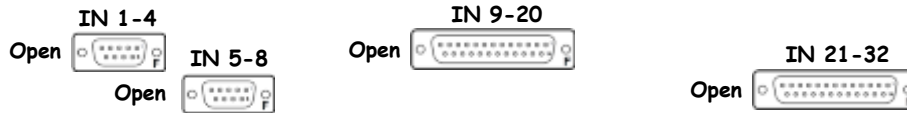

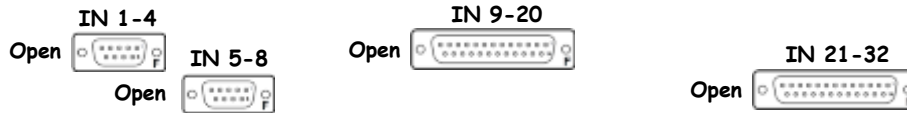

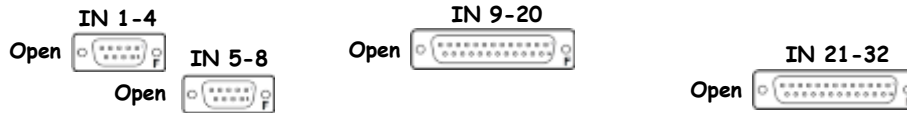

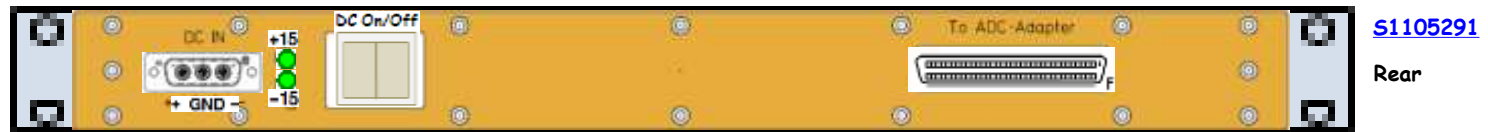
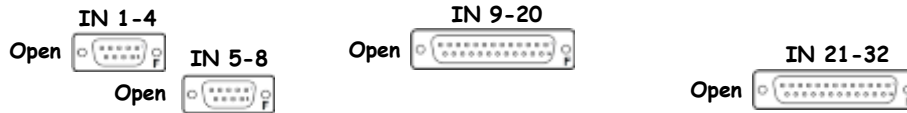

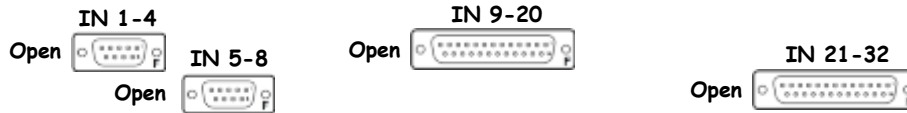

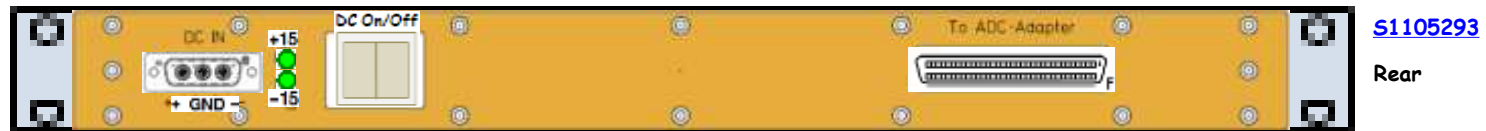
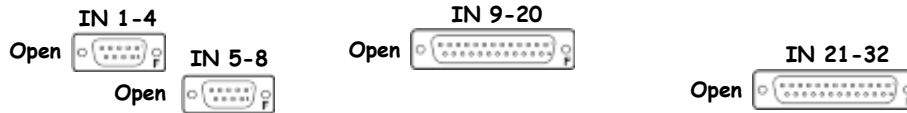

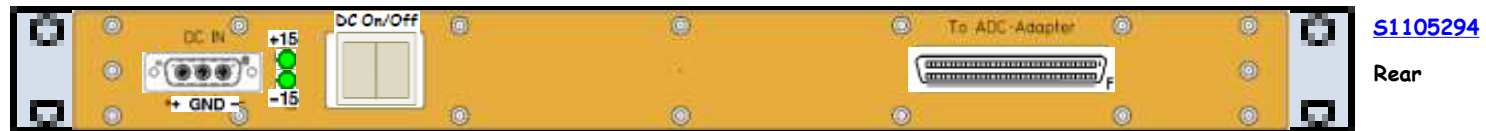
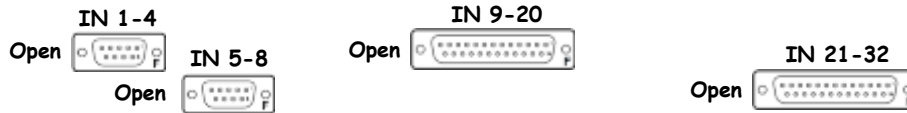

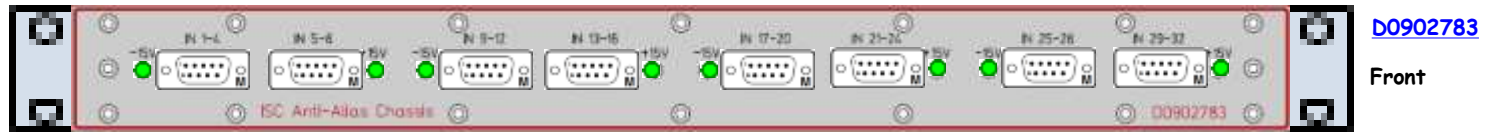

D0902783

Front

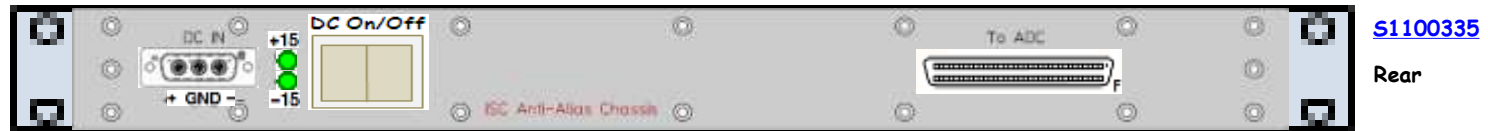
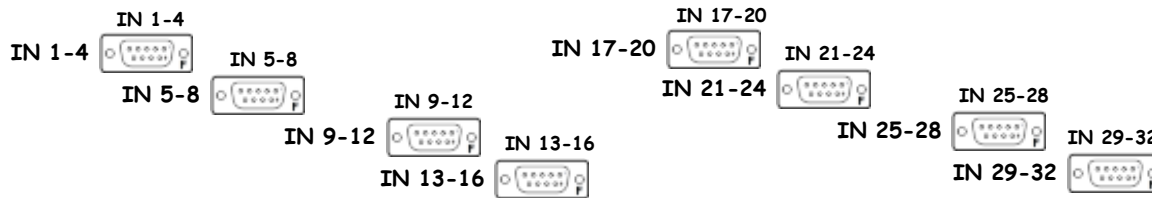

S1100335

Rear



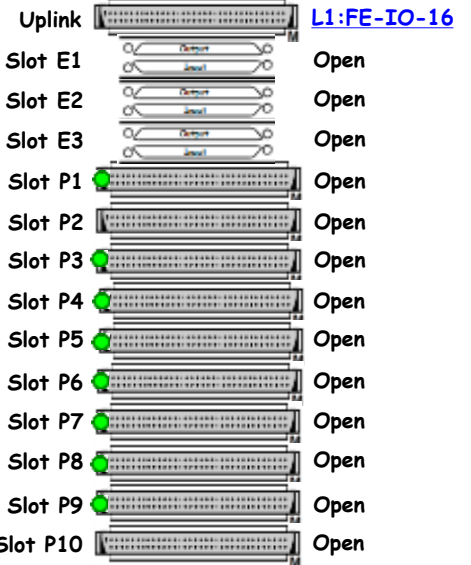
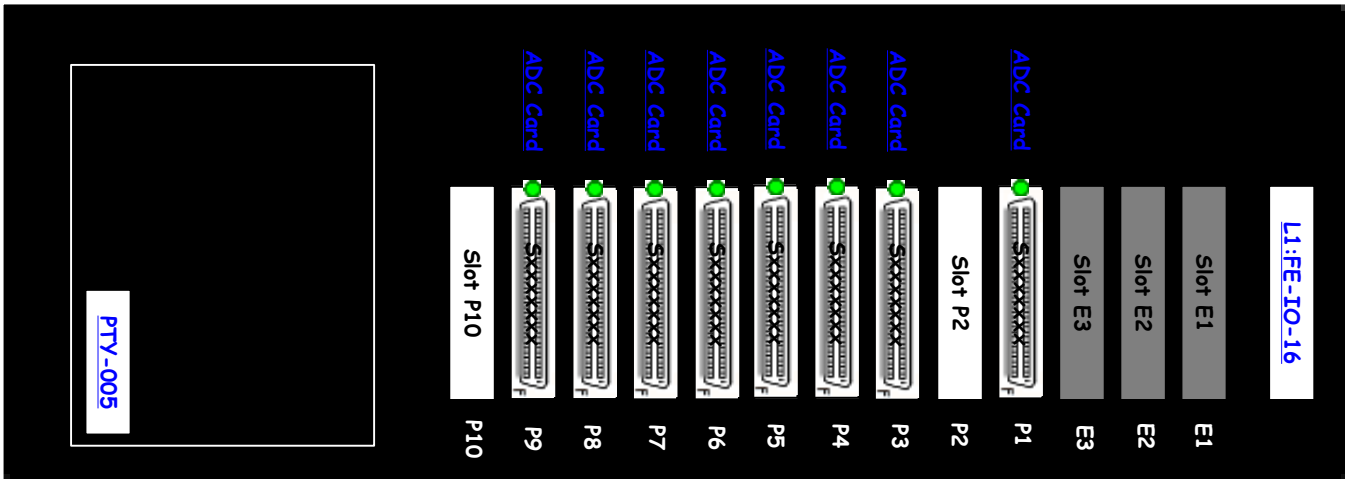

I1susham2a IO Extension Chassis

D1001715

S1001133

+24VDC

D1001715

Front

Timing Slot

I1susham2a – I/O Extender

TB-04

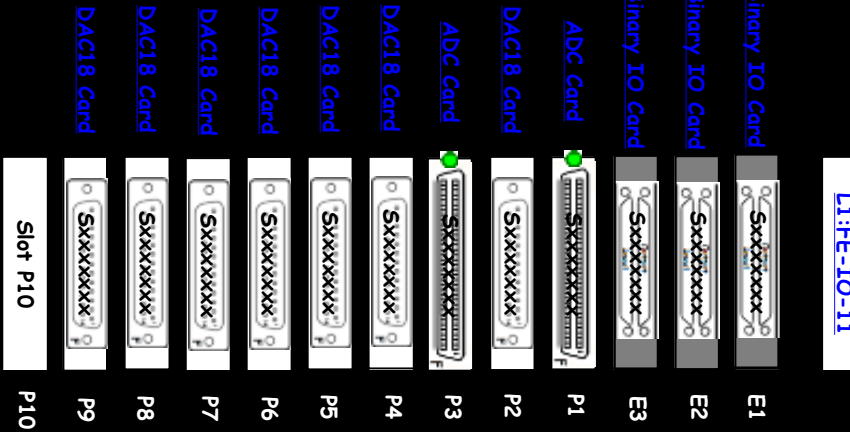

S1001133

Rear

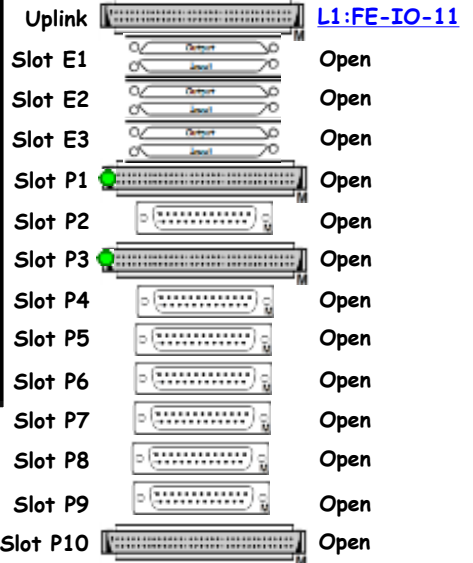

I1susham2b IO Extension Chassis

D1001715

S1001139

+24VDC

D1001715

Front

Timing Slot

I1susham2b – I/O Extender

S1001139

Rear

Uplink  L1:FE-IO-12

Slot E1  Open

Slot E2  Open

Slot E3  Open

Slot P1  Open

Slot P2  Open

Slot P3  Open

Slot P4  Open

Slot P5  Open

Slot P6  Open

Slot P7  Open

Slot P8  Open

Slot P9  Open

Slot P10  Open

Binary IO Card

L1:FE-IO-12

Slot E2

Slot E3

Slot P1

ADC Card

Slot P2

DAC18 Card

Slot P3

DAC18 Card

Slot P4

Slot P5

Slot P6

Slot P7

Slot P8

Slot P9

Slot P10

TB-04

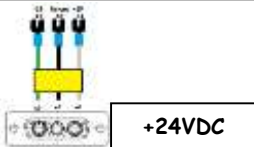

D1000725 - S1104838



<< L1-SUS-C3

FE1 B100 Binary Output Chassis D1000725 S1104838 ±18VDC

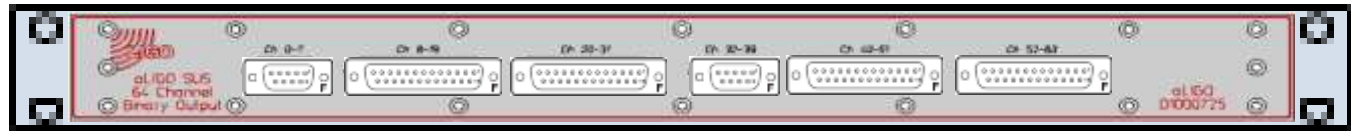

D1000725

Front

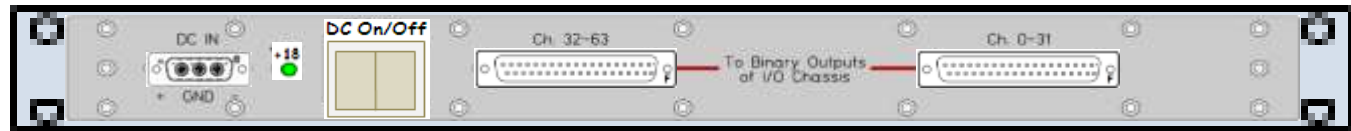
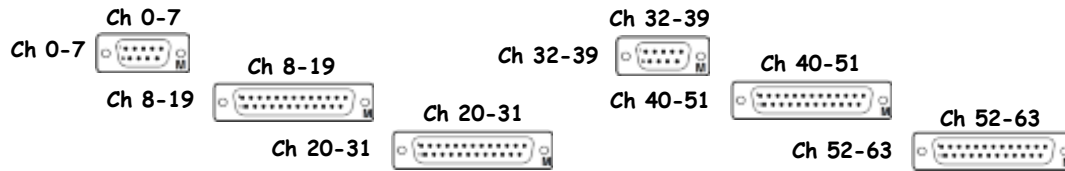

S1104838

Rear



D1000726 - S1104460



<< L1-SUS-C3

FE1 B100 Binary Input Chassis D1000726 S1104460 ±18VDC



D1000726

Front

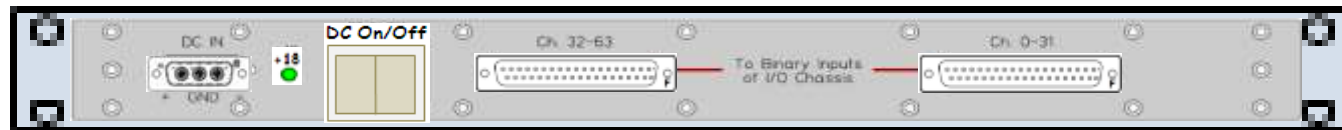
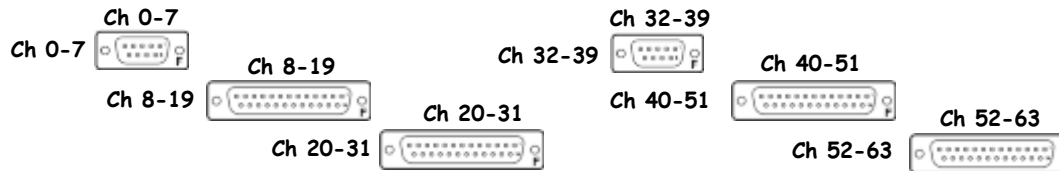

S1104460

Rear



FE1 BIO1 Binary Output Chassis D1000725 S1104841 ±18VDC



[D1000725](#)

Front

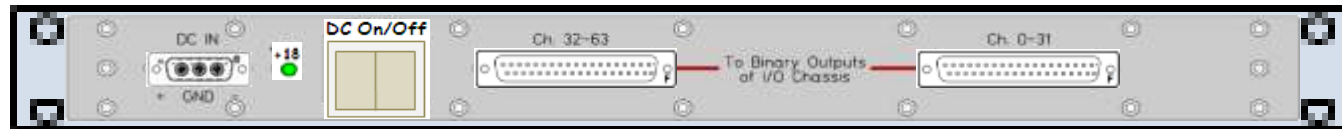
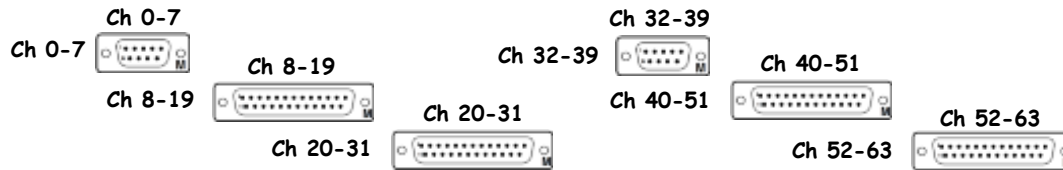

[S1104841](#)

Rear



FE1 BIO1 Binary Input Chassis D1000726 S1104457 ±18VDC



D1000726

Front

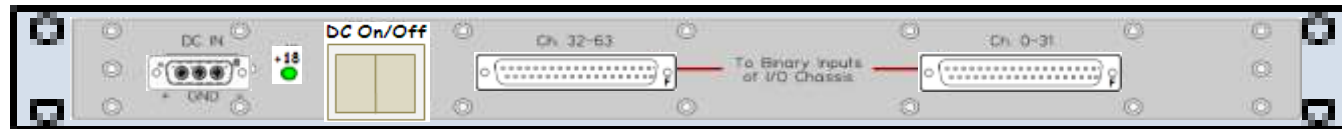
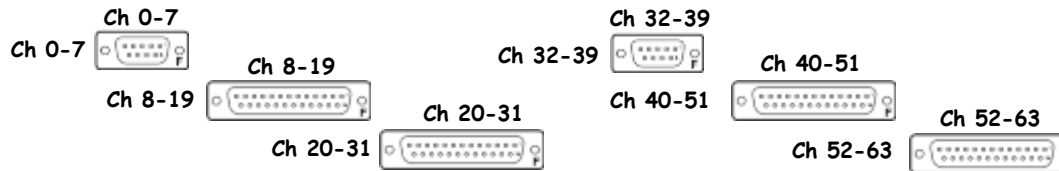

S1104457

Rear



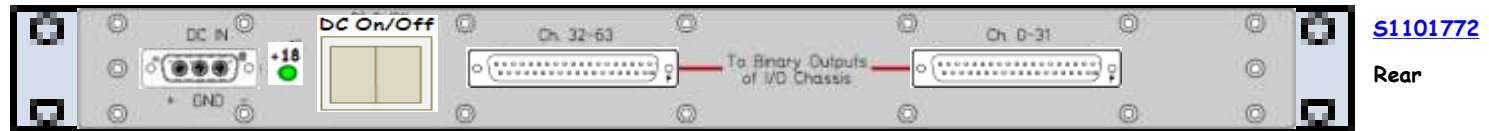
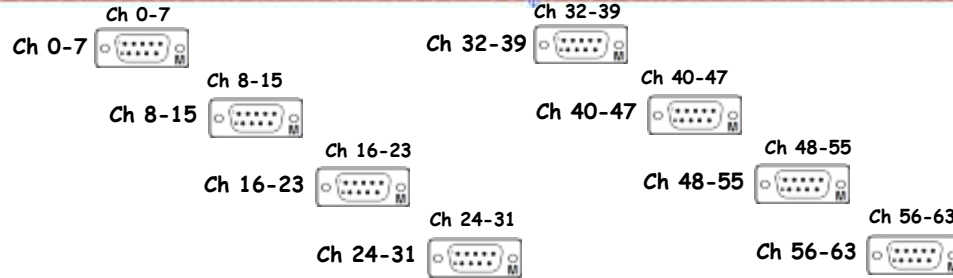

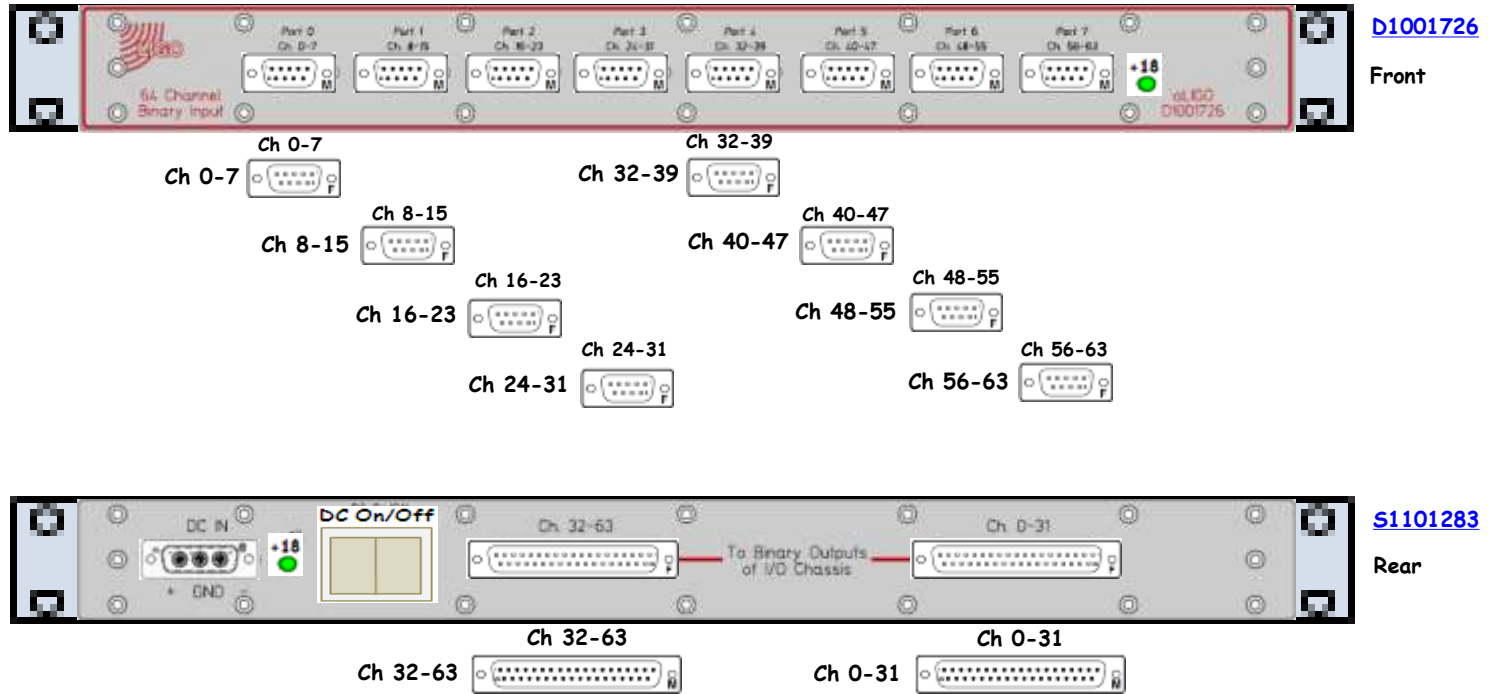

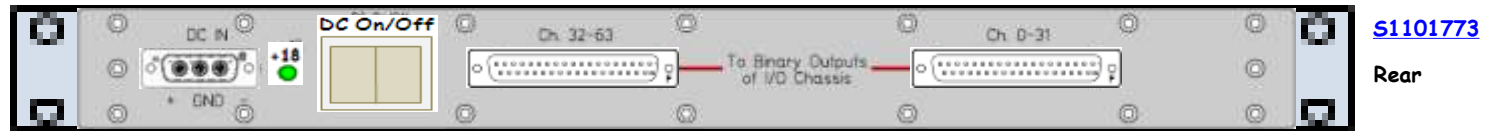
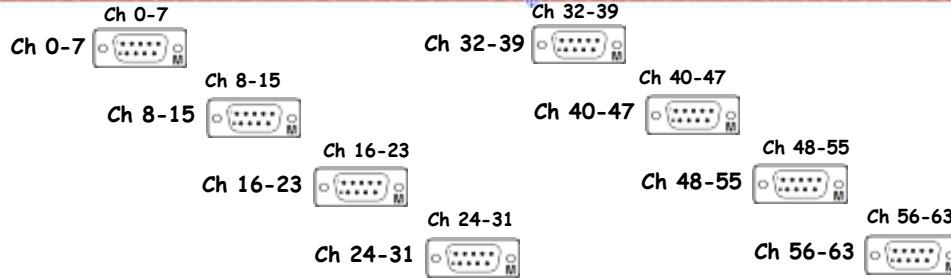

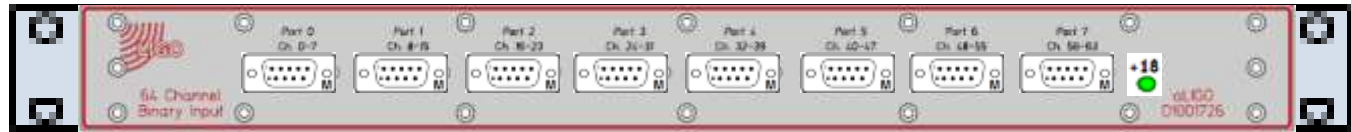

D1001726

Front

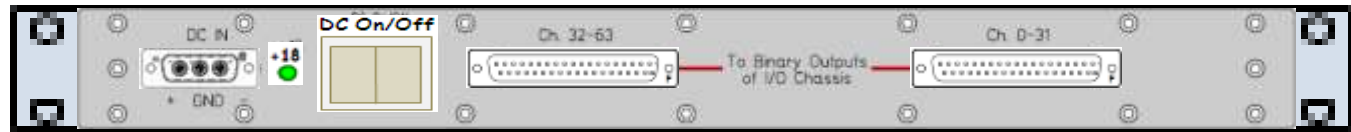
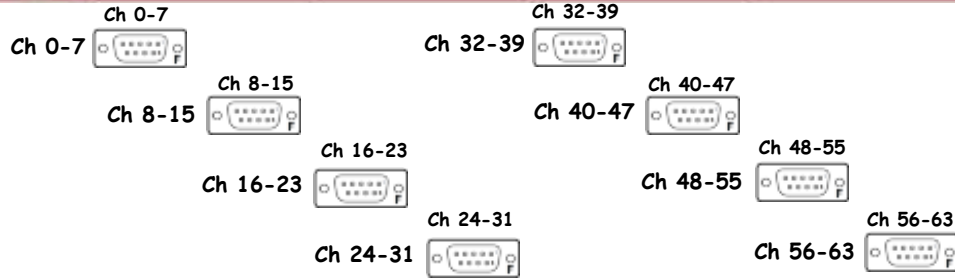

S1101315

Rear



MC1-MC3 Triple Top Coil Driver Chassis	D1001242	42	S1000253	±18VDC
MC1-MC3 Triple Top Coil Driver Chassis	D1001242	41	S1000261	±18VDC
MC1-MC3 Triple Top Coil Driver Chassis	D1001242	40	S1000262	±18VDC
		39		
		38		
PRM-PR3 Triple Top Coil Driver Chassis	D1001242	37	S1000257	±18VDC
PRM-PR3 Triple Top Coil Driver Chassis	D1001242	36	S1000726	±18VDC
PRM-PR3 Triple Top Coil Driver Chassis	D1001242	35	S1000723	±18VDC
		34		
FE1 ADC0 Anti-Alias Chassis (8*DB9)	D0902783	33	S1100332	±18VDC
FE1 ADC1 Anti-Alias Chassis (8*DB9)	D0902783	32	S1100333	±18VDC
		31		
FE1 DAC0, FE1 DAC1 Anti-Image Chassis	D1000305	30	S1105313	±18VDC
FE1 DAC2, FE1 DAC3 Anti-Image Chassis	D1000305	29	S1001200	±18VDC
		28		
MC1 Mid Triple Acq Driver Chassis	D0900006	27	S1001112	±18VDC
MC1 Bot Triple Acq Driver Chassis	D0900006	26	S1000352	±18VDC
MC3 Mid Triple Acq Driver Chassis	D0900006	25	S1000353	±18VDC
MC3 Bot Triple Acq Driver Chassis	D0900006	24	S1000354	±18VDC
		23		
FE1 DAC4, FE1 DAC5 Anti-Image Chassis	D1000305	22	S1104363	±18VDC
FE1 DAC6 Anti-Image Chassis	D1000305	21	S1101806	±18VDC
		20		
PRM Mid Triple Acq Driver Chassis	D0900006	19	S1001103	±18VDC
PRM Bot Triple Acq Driver Chassis	D0900006	18	S1001191	±18VDC
PR3 Mid Triple Acq Driver Chassis	D0900006	17	S1001192	±18VDC
PR3 Bot Triple Acq Driver Chassis	D0900006	16	S1001193	±18VDC
		15		
SM1 8-Channel Coil Driver Chassis	D1100687	14	S1200590	±18VDC
SM2 8-Channel Coil Driver Chassis	D1100687	13	S1200589	±18VDC
		12		
FE2 ADC0 Anti-Alias Chassis	D0902783	11	S1200818	±18VDC
FE2 DAC0 Anti-Image Chassis	D1000305	10	S1101807	±18VDC
		9		
PMMT1 8-Channel Coil Driver Chassis	D1100687	8	S1200585	±18VDC
PMMT2 8-Channel Coil Driver Chassis	D1100687	7	S1200617	±18VDC
		6		
		5		
		4		
		3		
		2		
		1		



SUS-C4 is part of [D0902810](#).

L1-SUS-C4 Details

D1001242 - S1000253



<< L1-SUS-C4

MC1-MC3 Triple Top Coil Driver Chassis D1001242 S1000253 ±18VDC

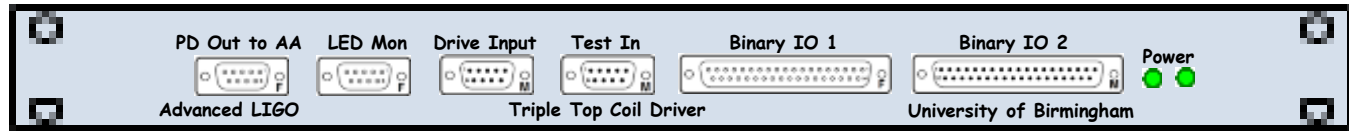

D1001242

Front

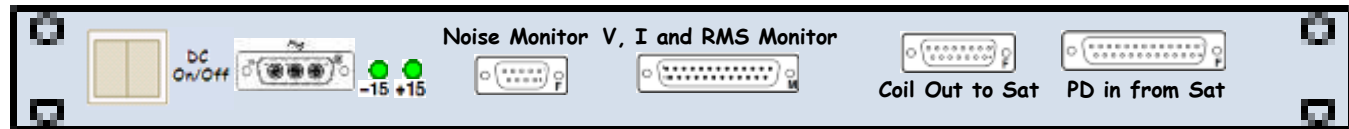
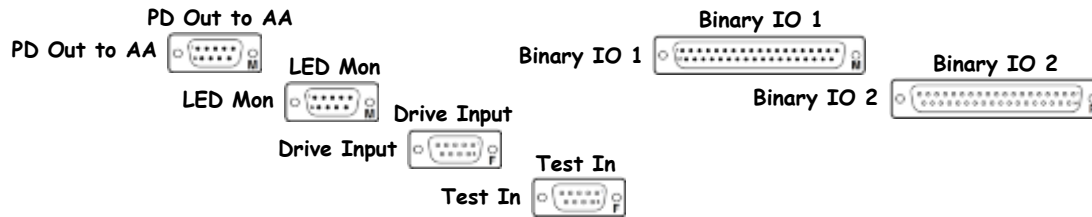

S1000253

Rear

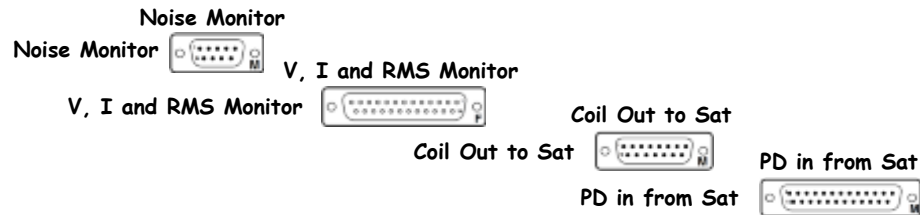

[Driver Board: D0902747](#)

[Monitor Board: D070480](#)

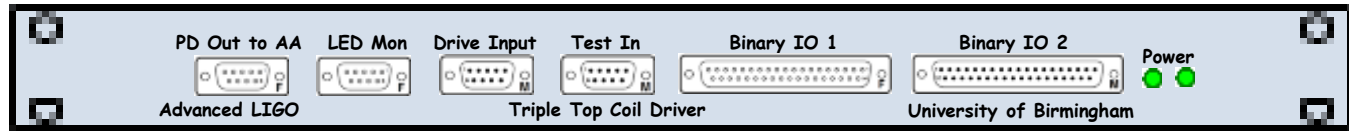

[D1001242](#)

Front

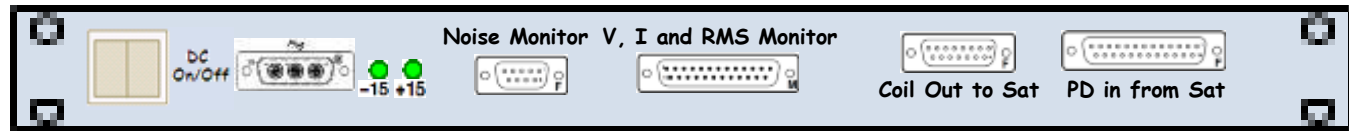
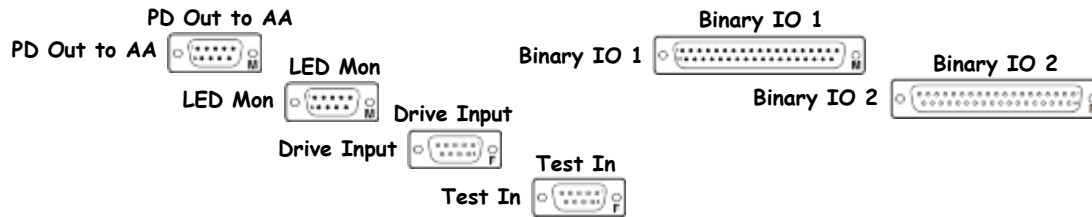

[S1000261](#)

Rear

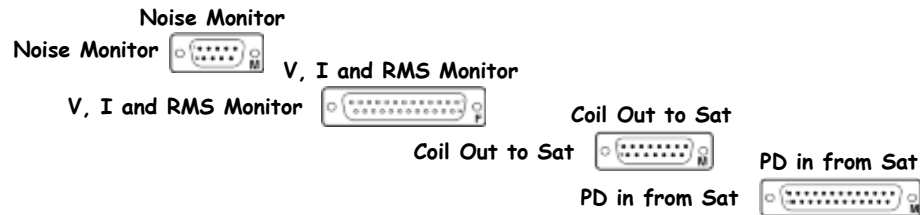

[Driver Board: D0902747](#)

[Monitor Board: D070480](#)

D1001242 - S1000262



<< L1-SUS-C4

MC1-MC3 Triple Top Coil Driver Chassis D1001242 S1000262 ±18VDC

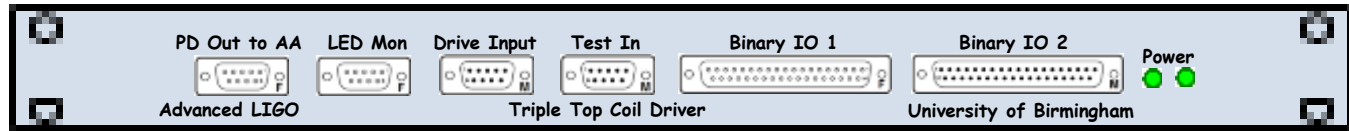

[D1001242](#)

Front

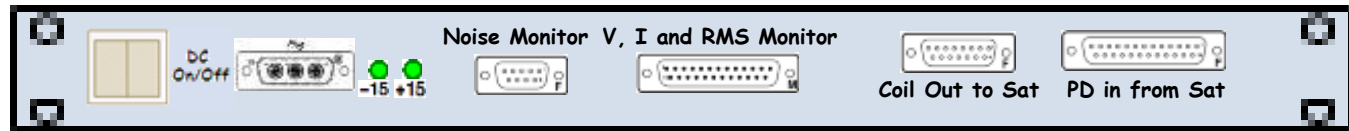
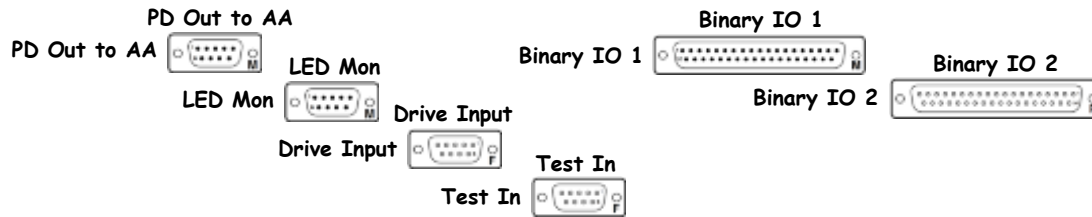

[S1000262](#)

Rear

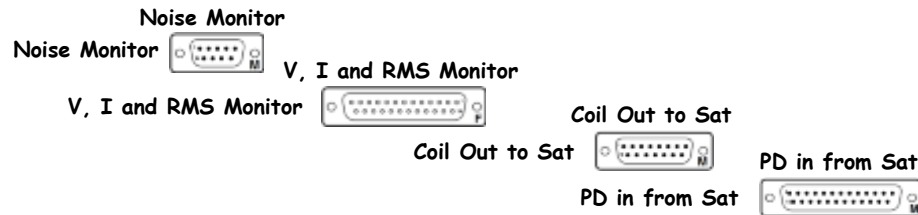

[Driver Board: D0902747](#)

[Monitor Board: D070480](#)

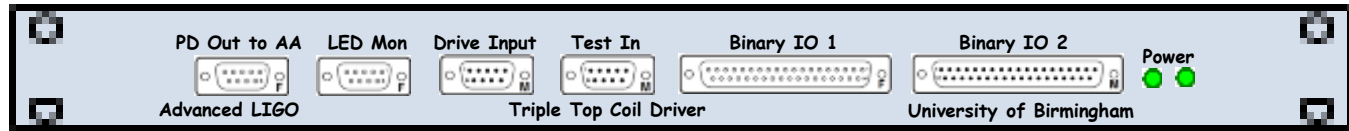

[D1001242](#)

Front

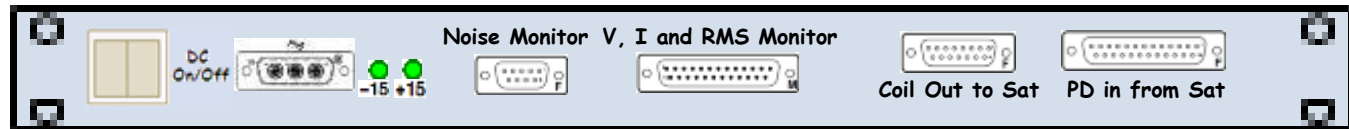
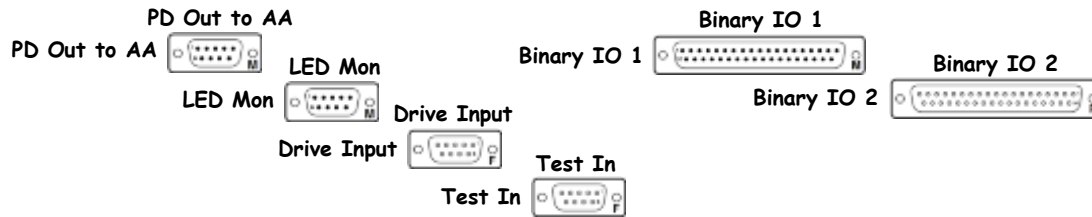

[S1000257](#)

Rear

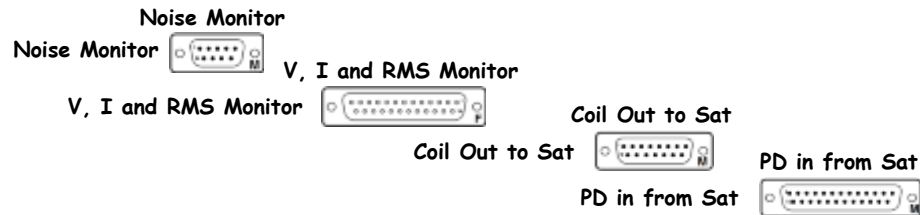

[Driver Board: D0902747](#)

[Monitor Board: D070480](#)

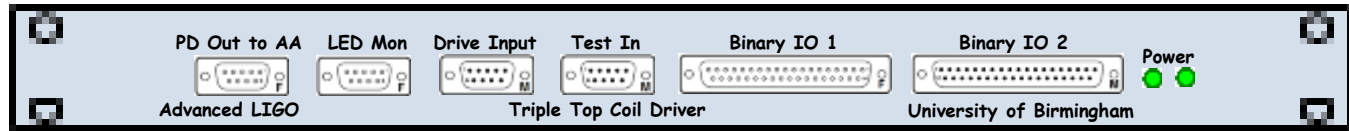

[D1001242](#)

Front

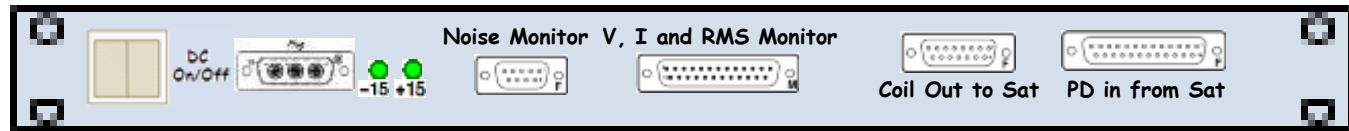
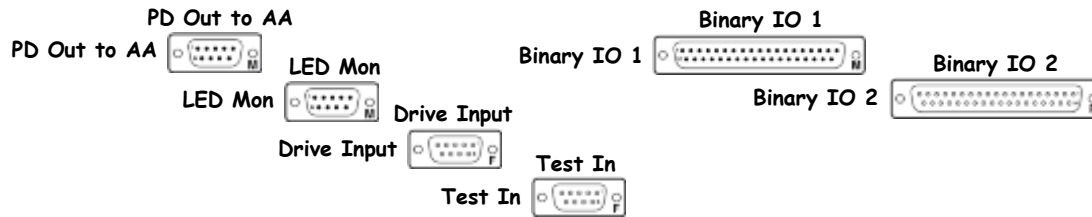

[S1000726](#)

Rear

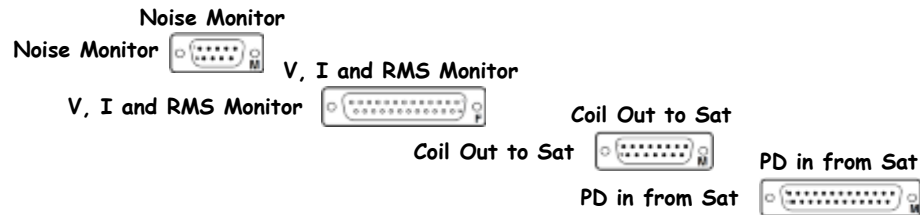

[Driver Board: D0902747](#)

[Monitor Board: D070480](#)

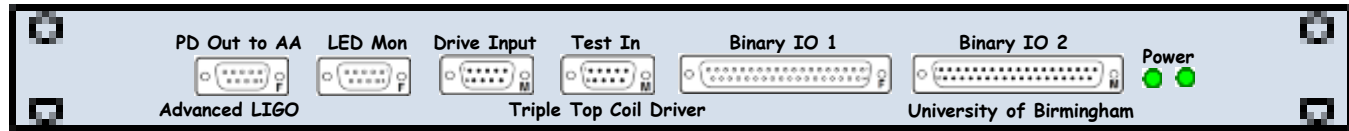

[D1001242](#)

Front

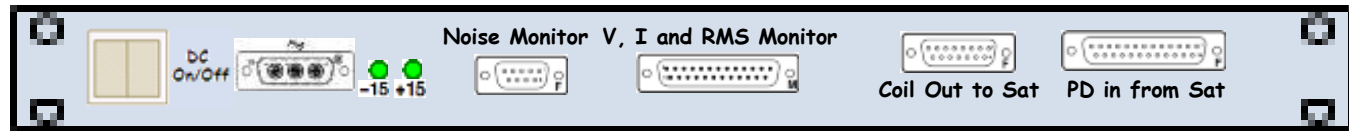
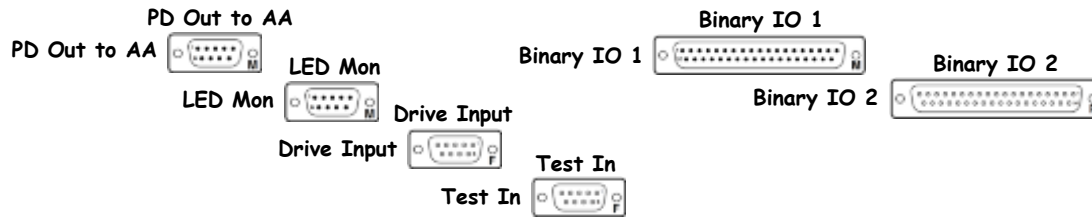

[S1000723](#)

Rear

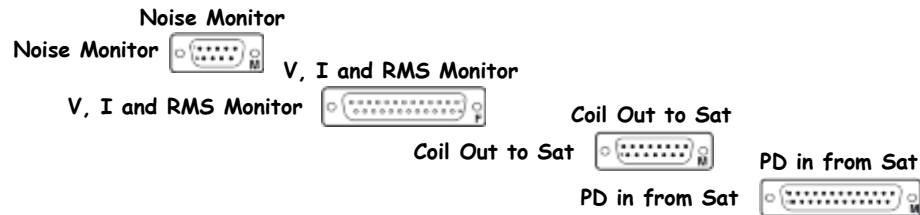

[Driver Board: D0902747](#)

[Monitor Board: D070480](#)

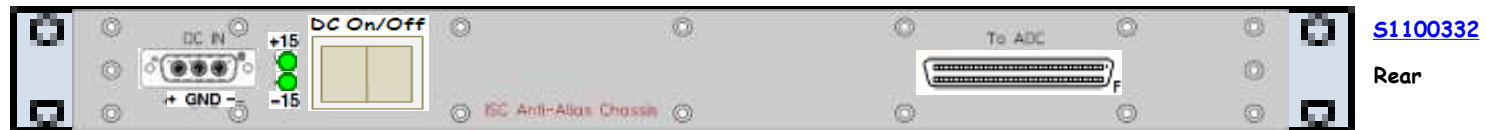
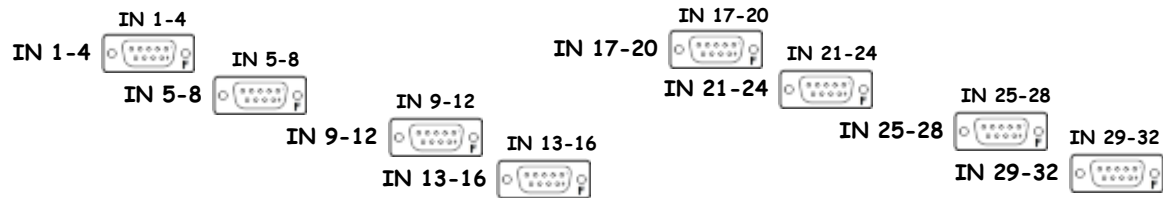
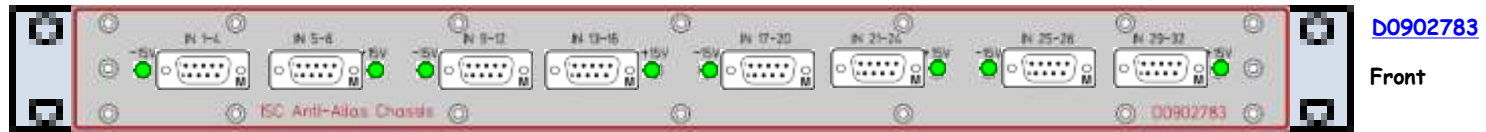

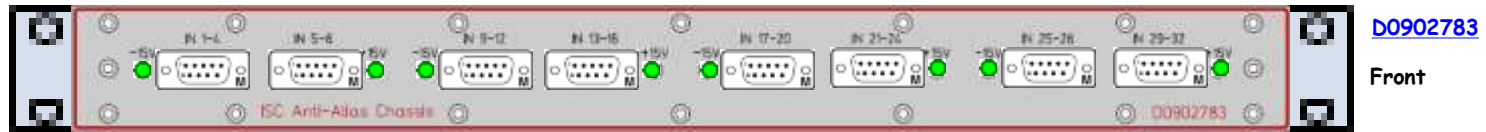

[D0902783](#)

Front

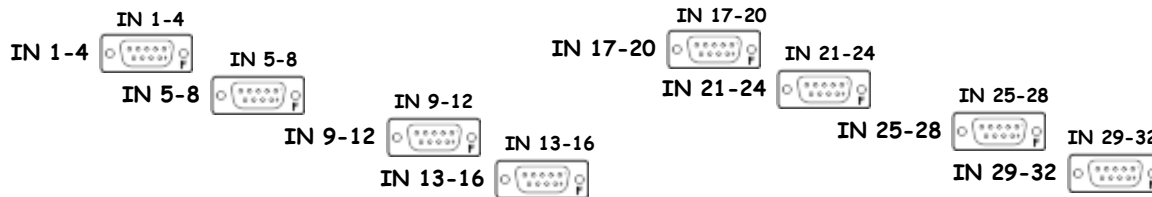

[S1100333](#)

Rear



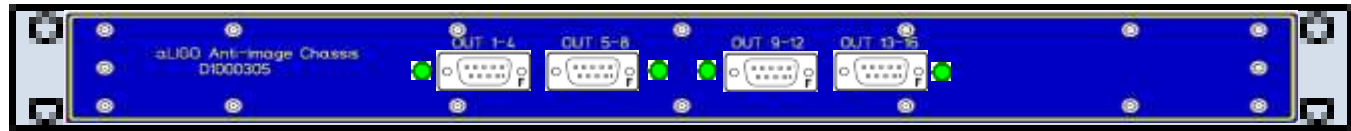

D1000305

Front

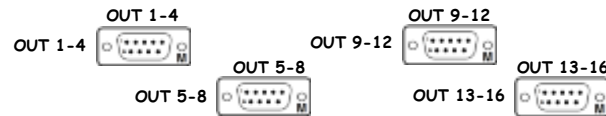

S1105313

Rear

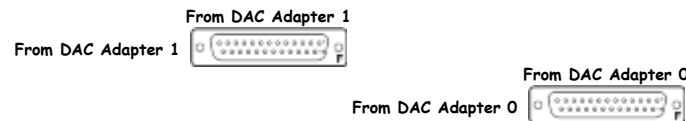

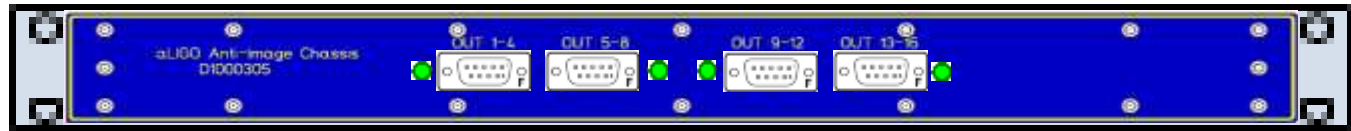

D1000305

Front

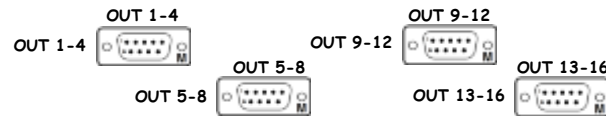

S1001200

Rear

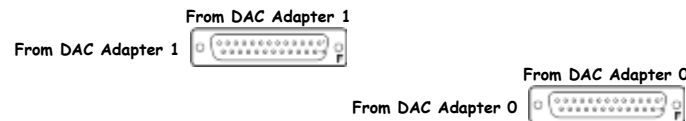

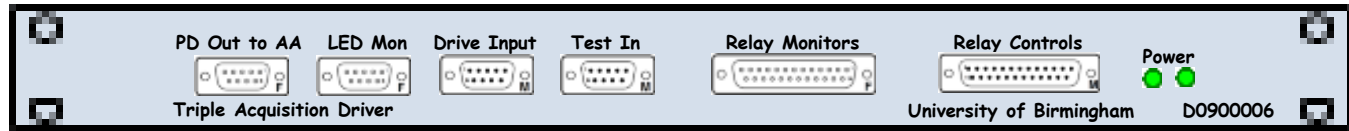

[D0900006](#)

Front

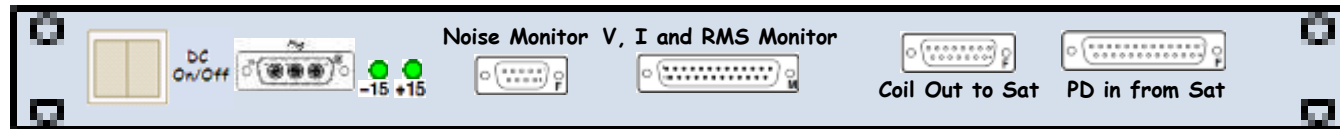
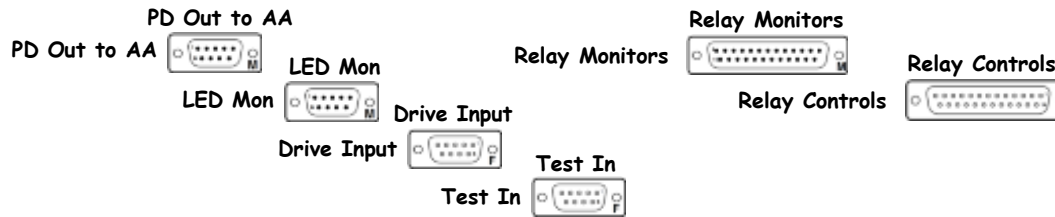

[S1001112](#)

Rear

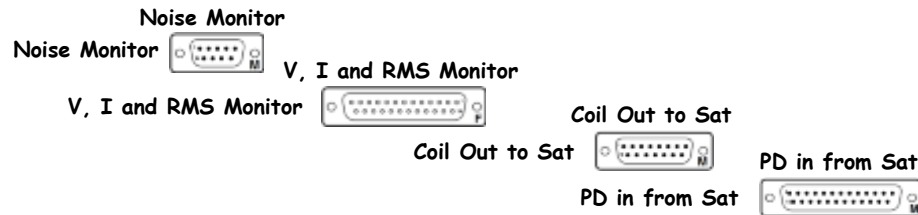

[Driver Board: D0901047](#)
[Monitor Board: D070480](#)

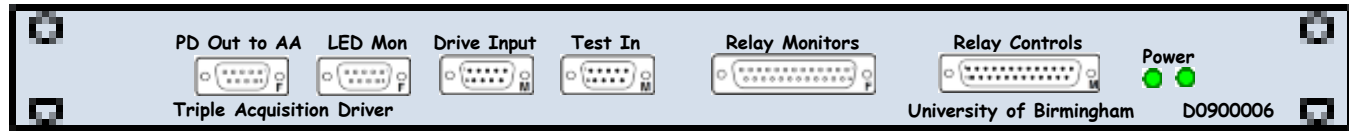

[D0900006](#)

Front

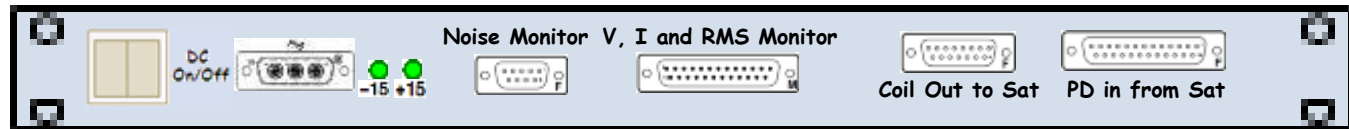
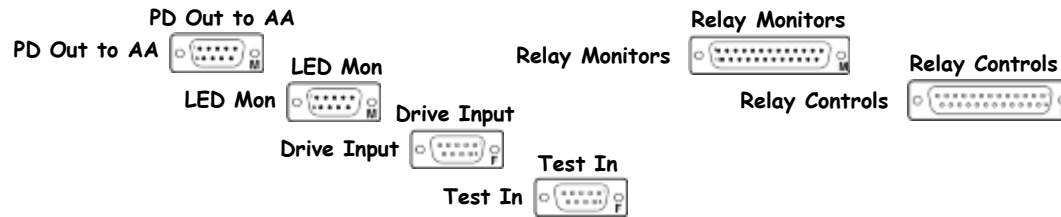

[S1000352](#)

Rear

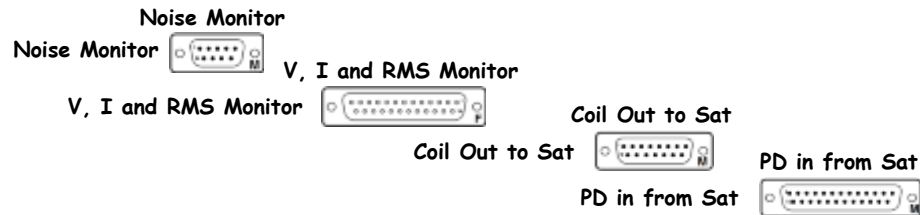

[Driver Board: D0901047](#)
[Monitor Board: D070480](#)

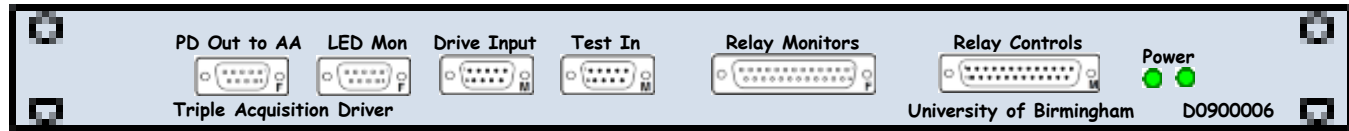

[D0900006](#)

Front

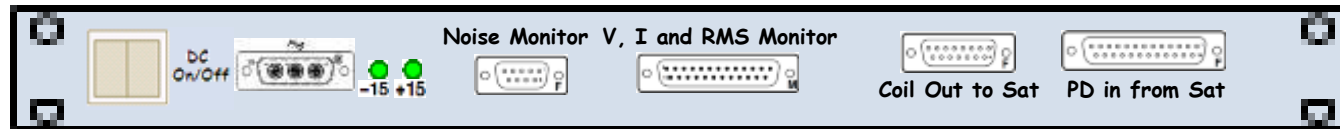
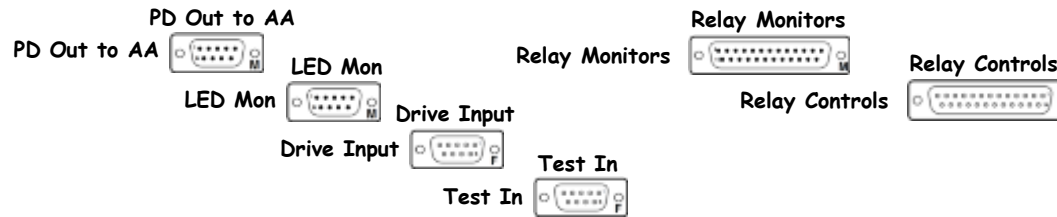

[S1000353](#)

Rear

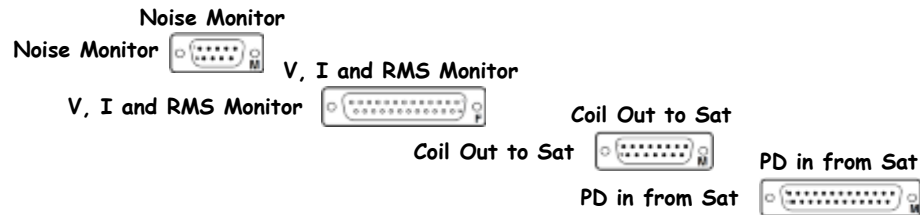

[Driver Board: D0901047](#)

[Monitor Board: D070480](#)

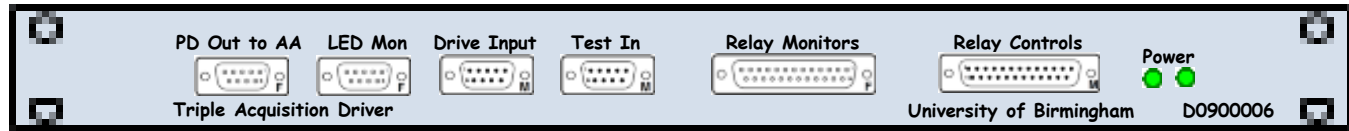

[D0900006](#)

Front

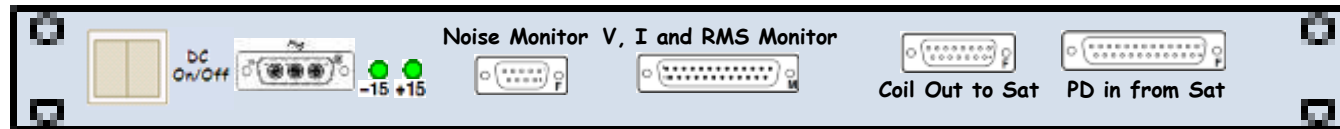
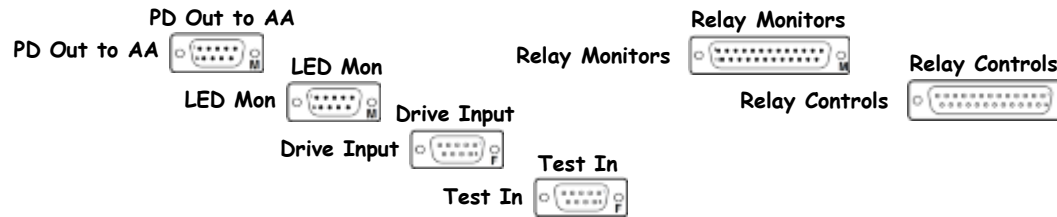

[S1000354](#)

Rear

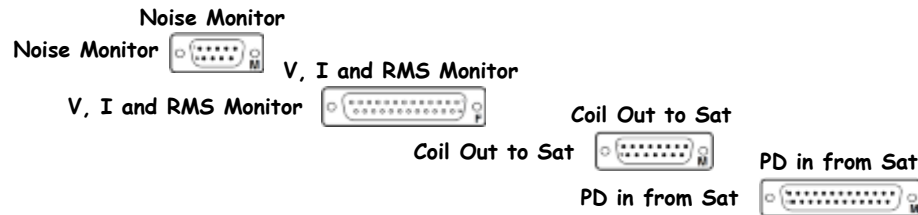

[Driver Board: D0901047](#)
[Monitor Board: D070480](#)

D1000305 - S1104363



<< L1-SUS-C4

FE1 DAC4, FE1 DAC5 Anti-Image Chassis ±18VDC

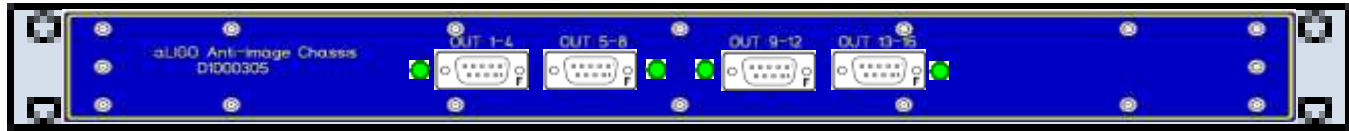

D1000305

Front

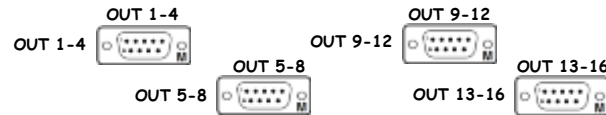

S1104363

Rear

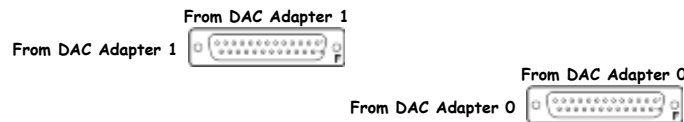

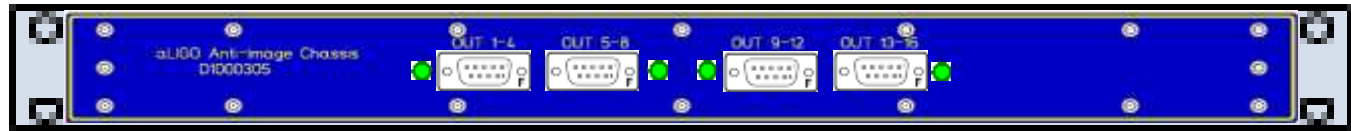

D1000305

Front

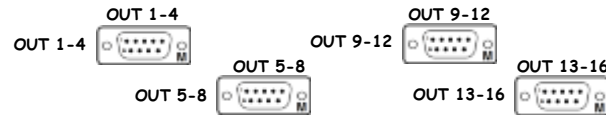

S1101806

Rear

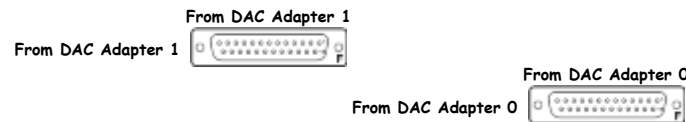

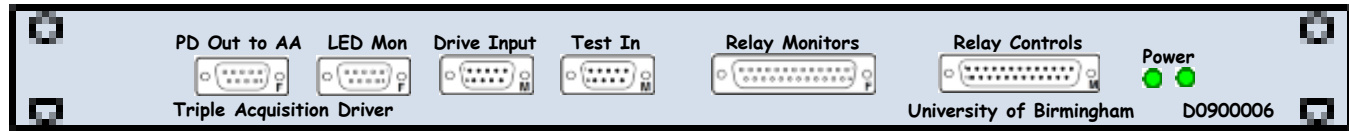

D0900006

Front

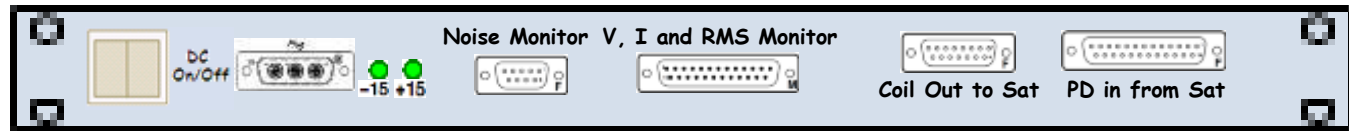
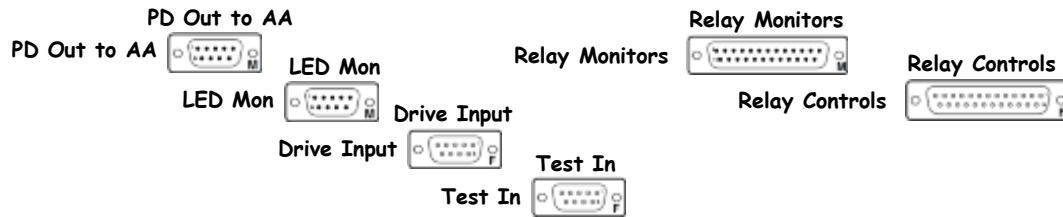

S1001103

Rear

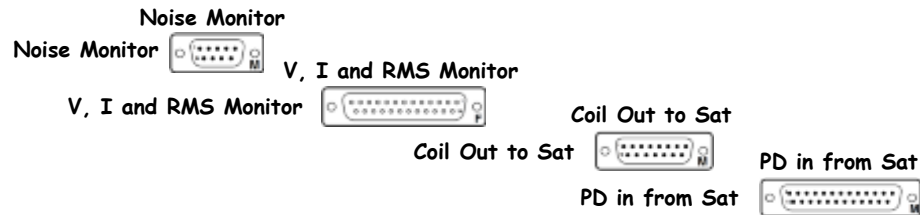

Driver Board: [D0901047](#)
Monitor Board: [D070480](#)

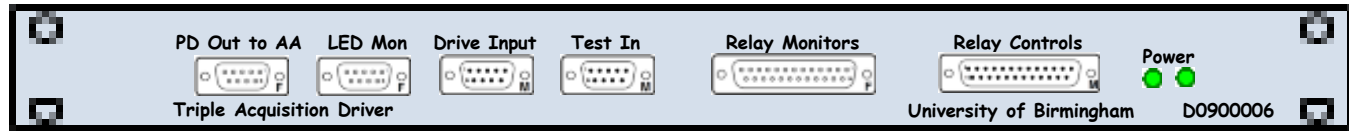

[D0900006](#)

Front

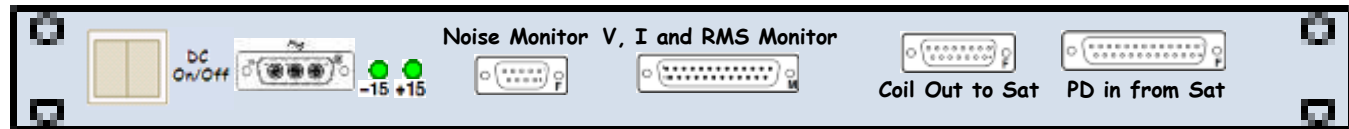
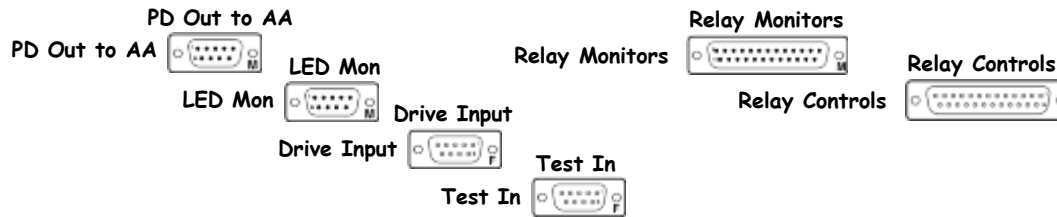

[S1001191](#)

Rear

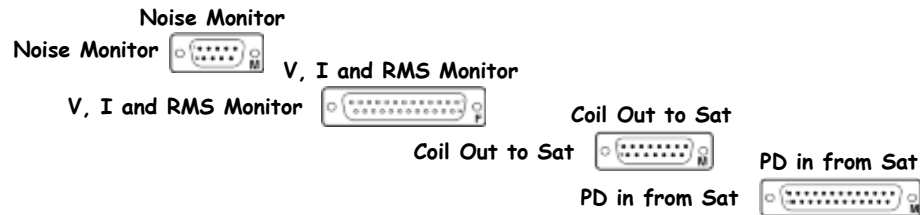

[Driver Board: D0901047](#)

[Monitor Board: D070480](#)

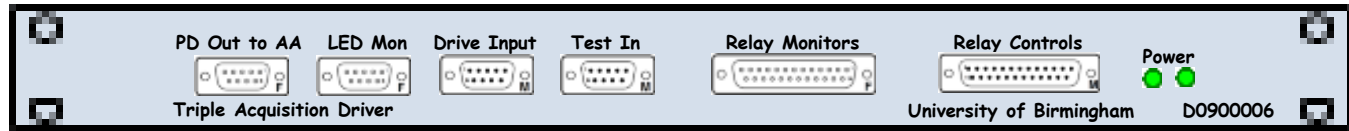

[D0900006](#)

Front

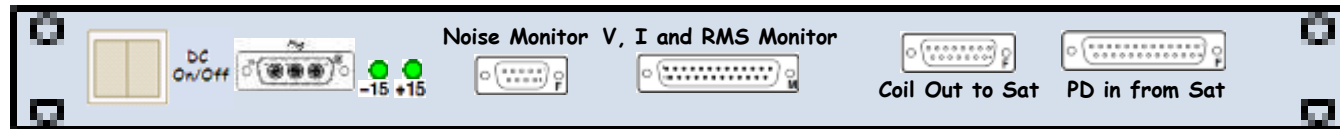
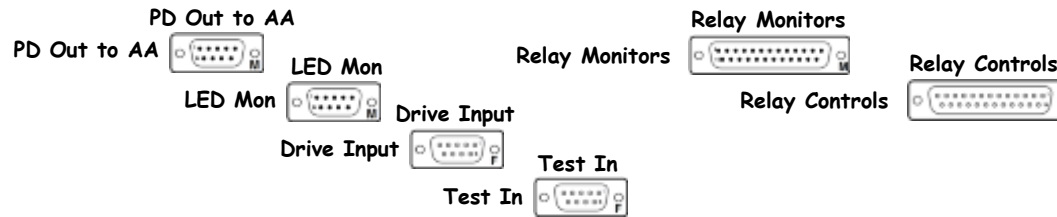

[S1001192](#)

Rear

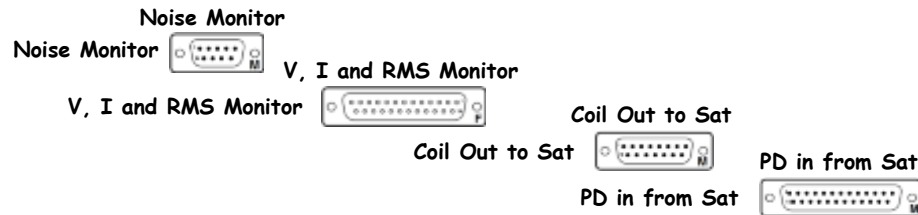

[Driver Board: D0901047](#)
[Monitor Board: D070480](#)

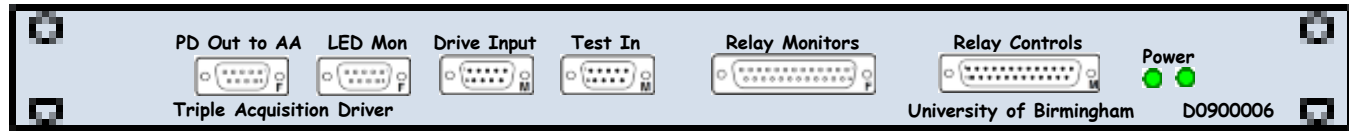

[D0900006](#)

Front

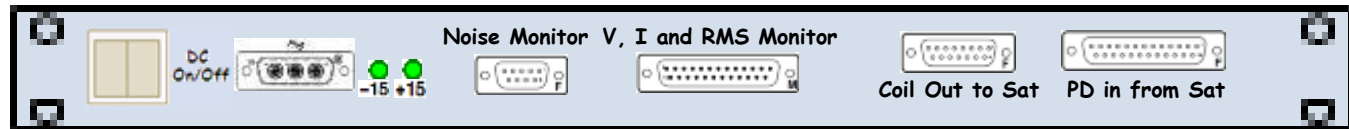
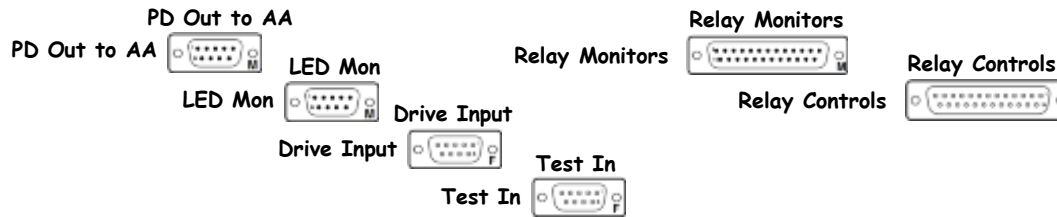

[S1001193](#)

Rear

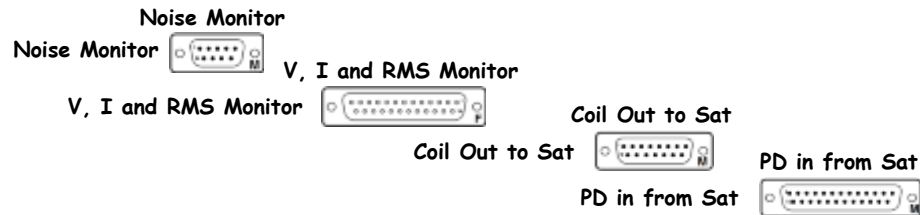

[Driver Board: D0901047](#)
[Monitor Board: D070480](#)

SM1 8-Channel Coil Driver Chassis D1100687 S1200590 ±18VDC

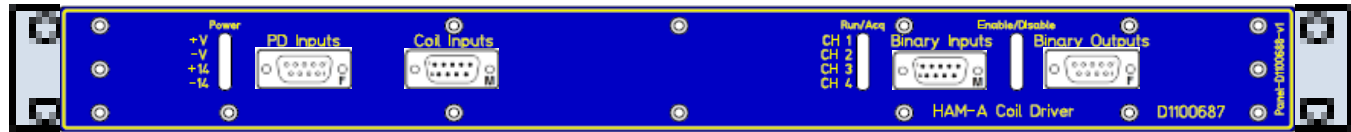

[D1100687](#)

Front

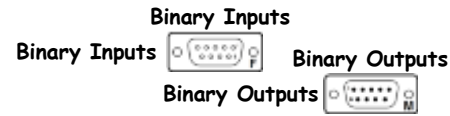
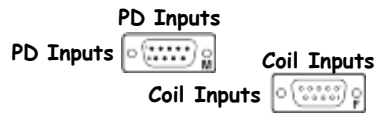

[S1200590](#)

Rear

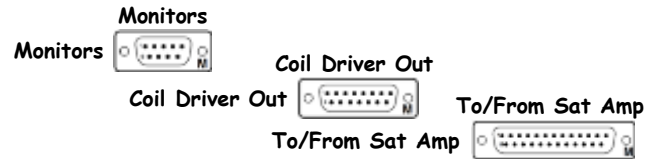

SM2 8-Channel Coil Driver Chassis D1100687 S1200589 ±18VDC

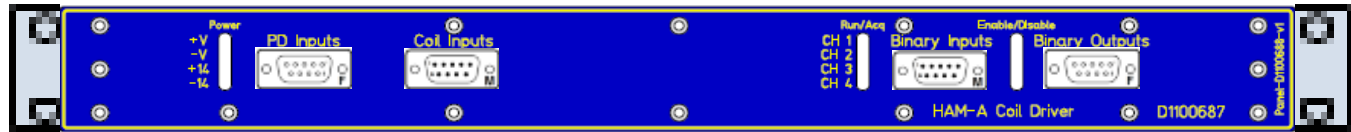

[D1100687](#)

Front

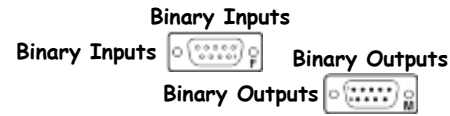
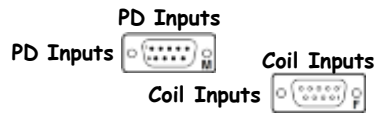

[S1200589](#)

Rear

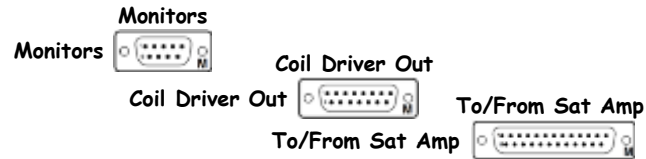

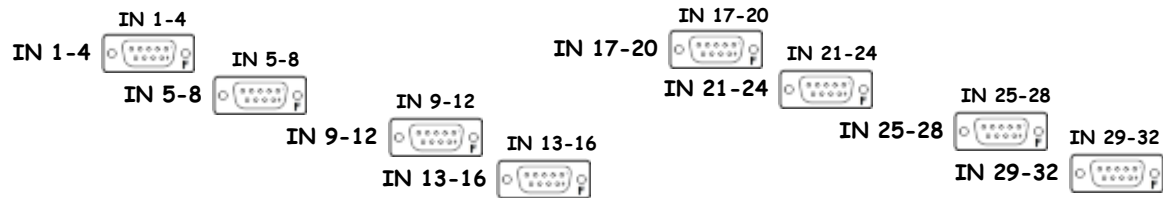

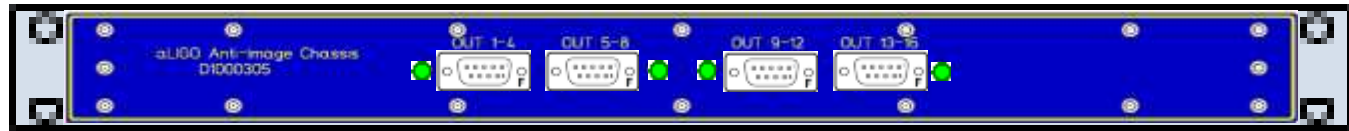

D1000305

Front

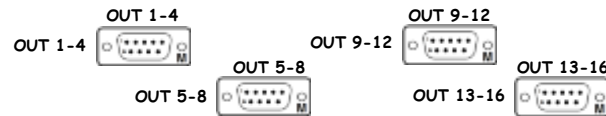

S1101807

Rear

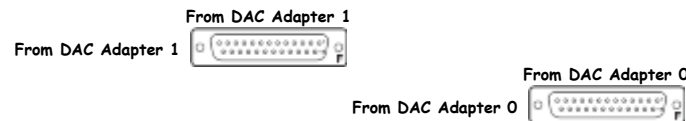

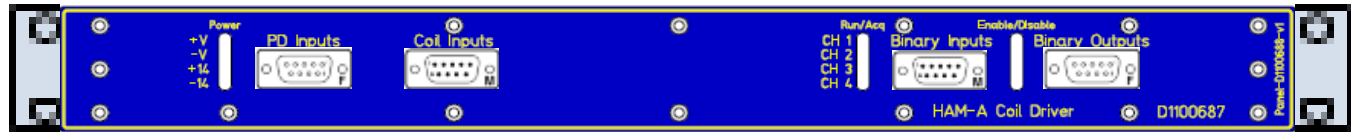

D1100687

Front

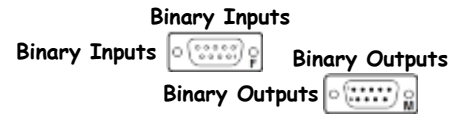
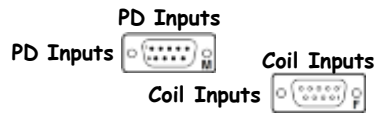

S1200585

Rear

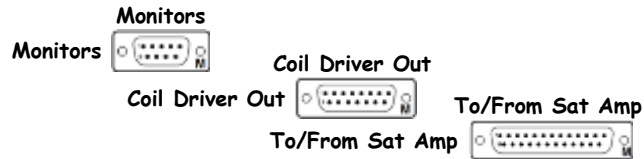

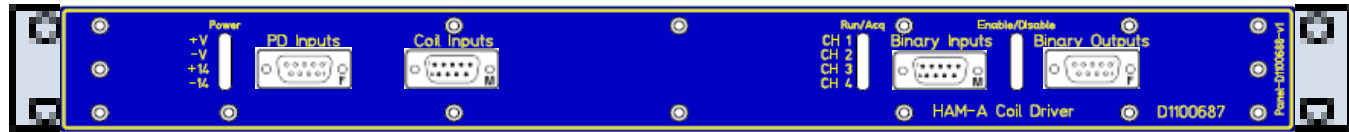

[D1100687](#)

Front



[S1200617](#)

Rear

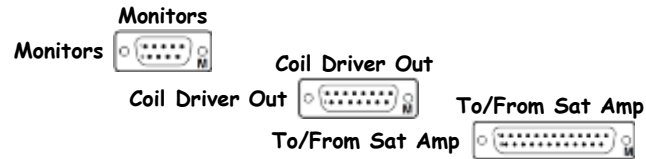

L1-SUS-C5 - S1105375

<< CER

SUS ITMX, ITMY, and BS Rack 1 (of 2) Layout ([D1200874](#)) ([S1105375](#))

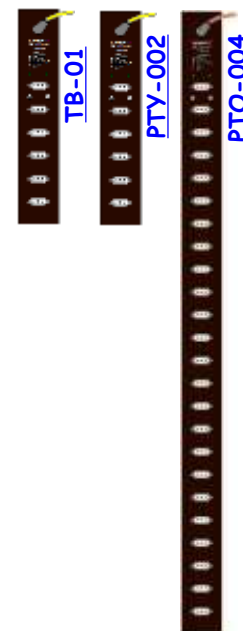
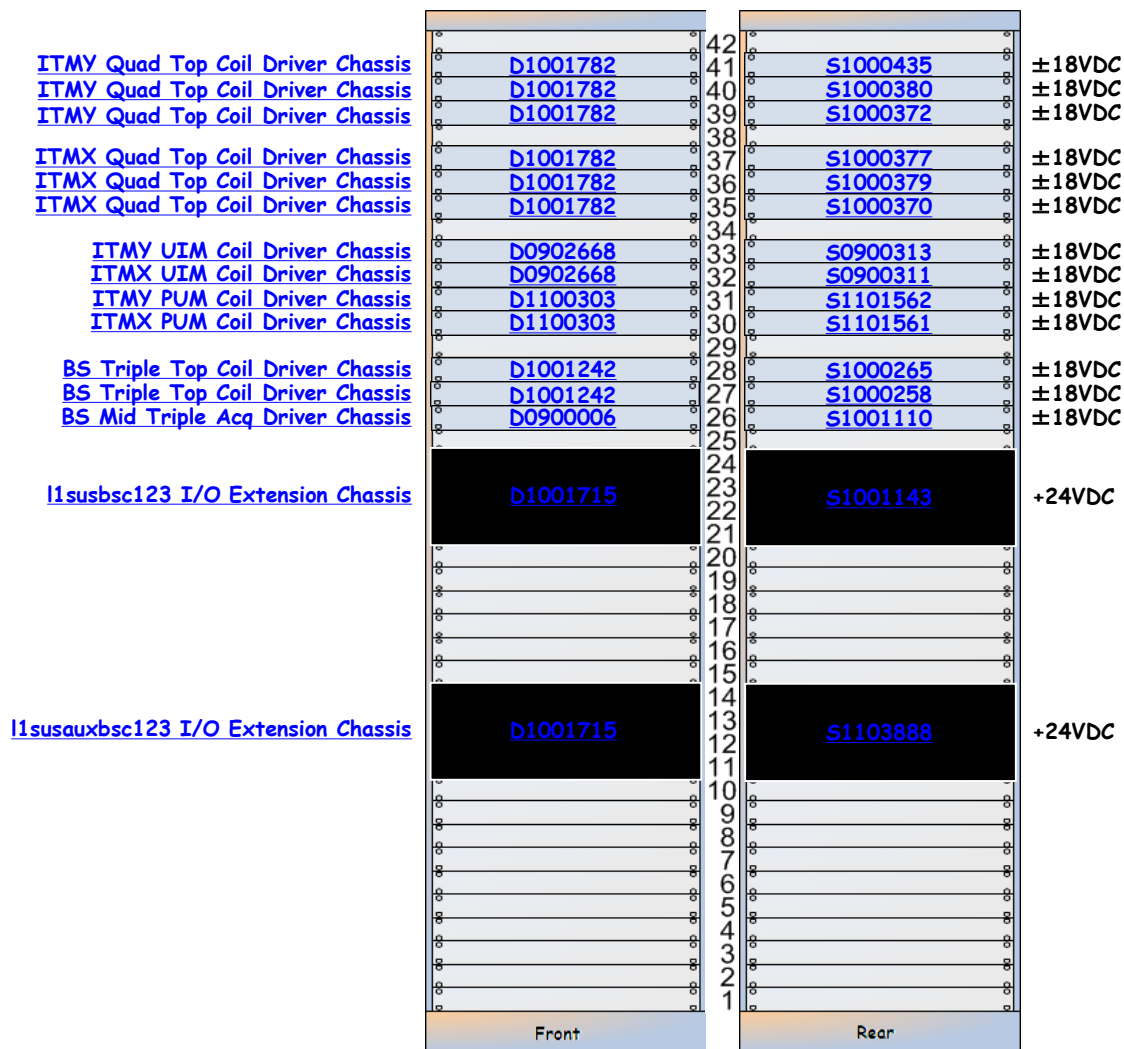

SUS-C5 is part of [D1100022](#).

L1-SUS-C5 Details

SUS-C5 is part of [D1100022](#).

D1001782 - S1000435



<< L1-SUS-C5

ITMY Quad Top Coil Driver Chassis D1001782 S1000435 ±18VDC

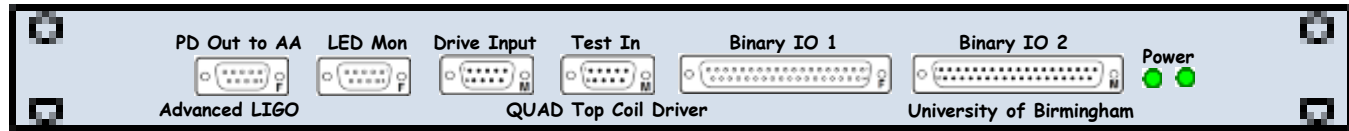

D1001782

Front

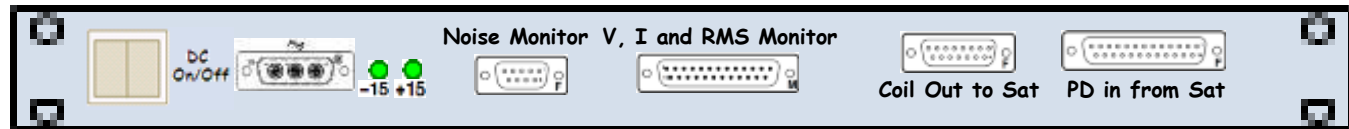
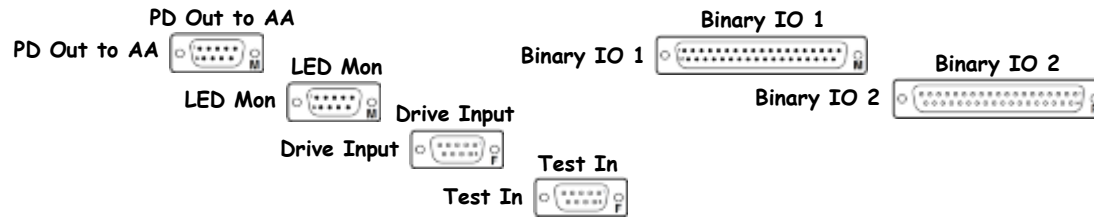

S1000435

Rear

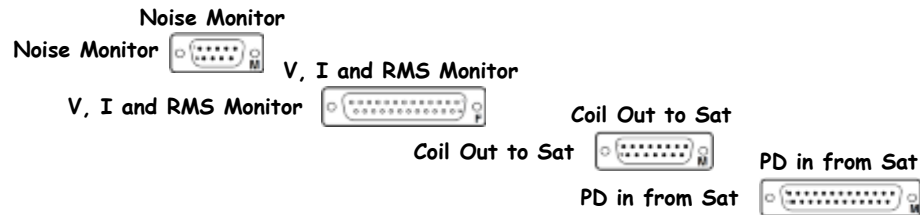

[Driver Board: D0902747](#)

[Monitor Board: D070480](#)

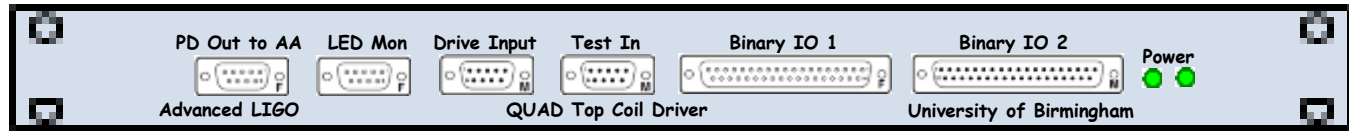

[D1001782](#)

Front

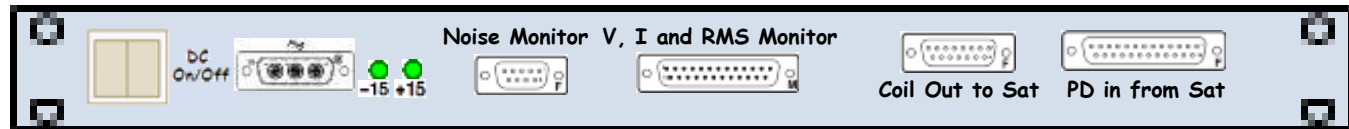
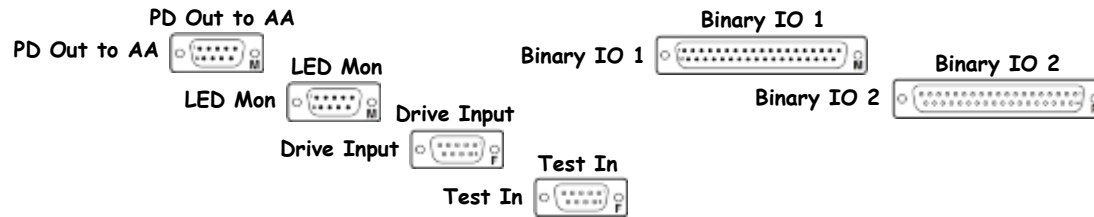

[S1000380](#)

Rear

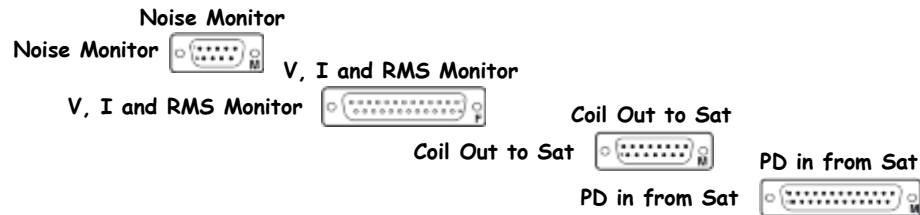

[Driver Board: D0902747](#)

[Monitor Board: D070480](#)

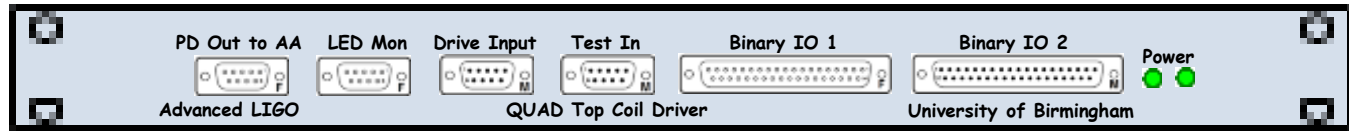

D1001782

Front

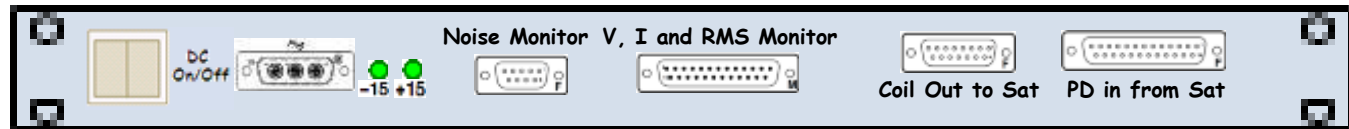
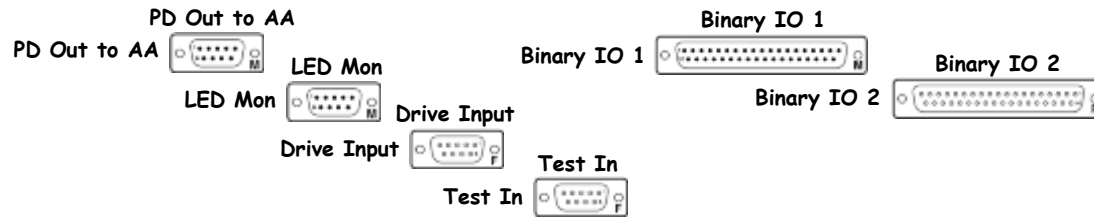

S1000372

Rear

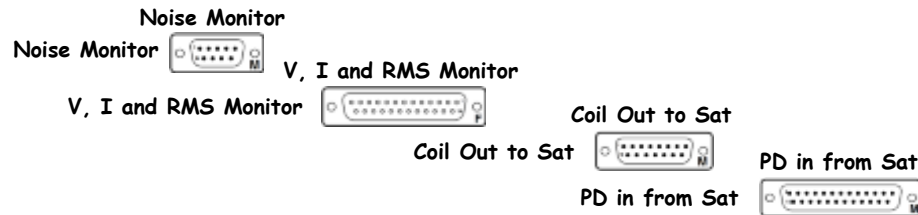

[Driver Board: D0902747](#)

[Monitor Board: D070480](#)

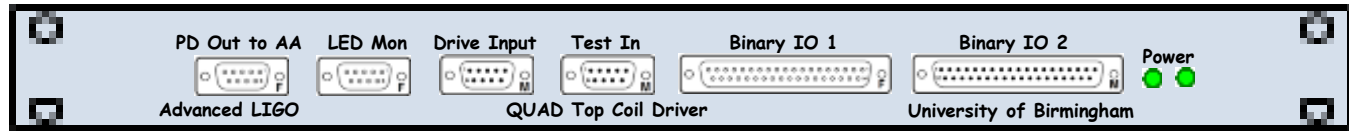

[D1001782](#)

Front

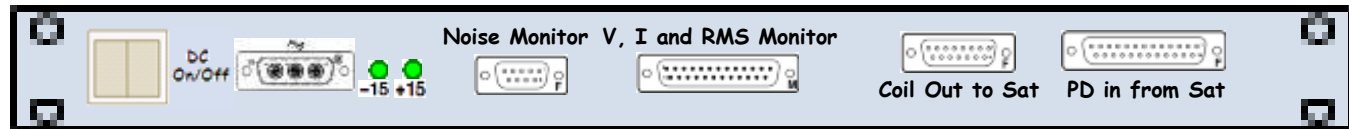
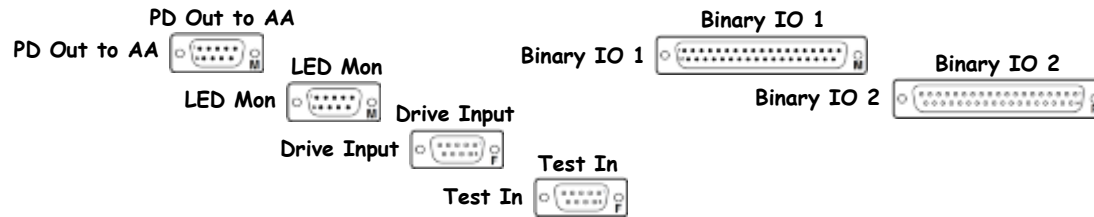

[S1000377](#)

Rear

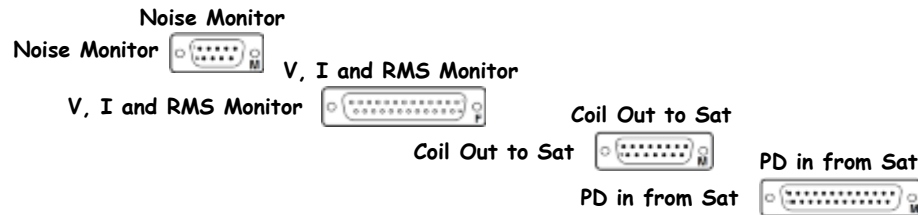

[Driver Board: D0902747](#)

[Monitor Board: D070480](#)

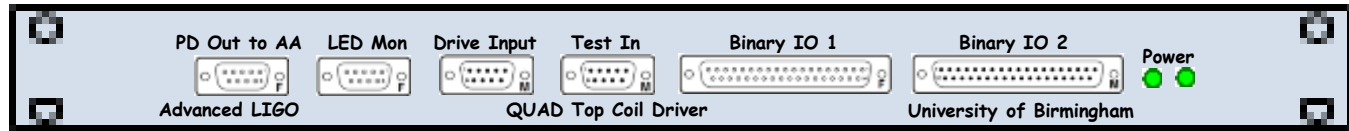

D1001782

Front

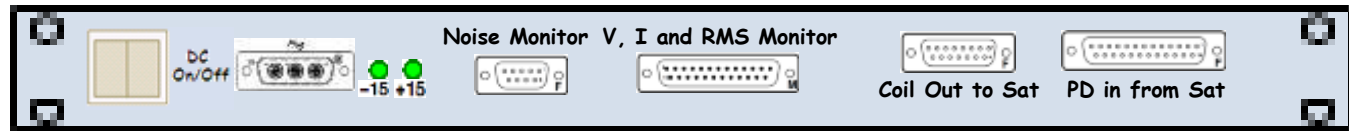
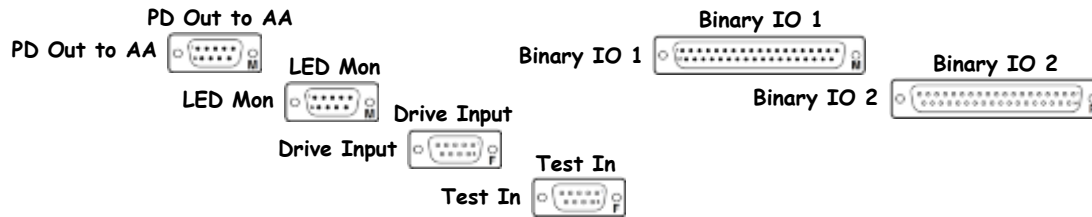

S1000379

Rear

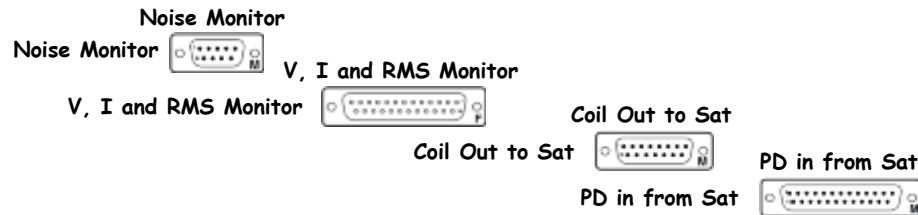

Driver Board: [D0902747](#)
 Monitor Board: [D070480](#)

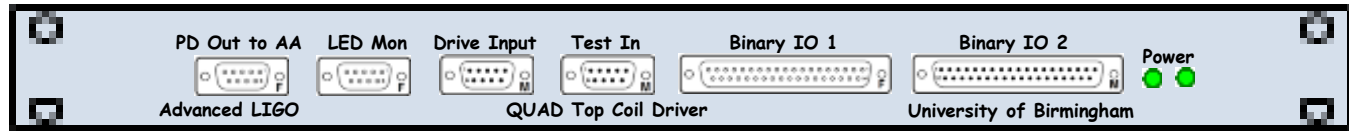

[D1001782](#)

Front

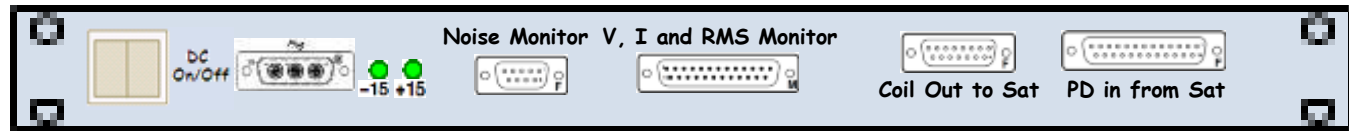
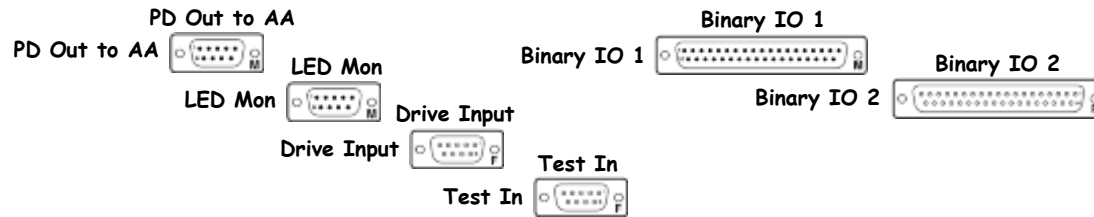

[S1000370](#)

Rear

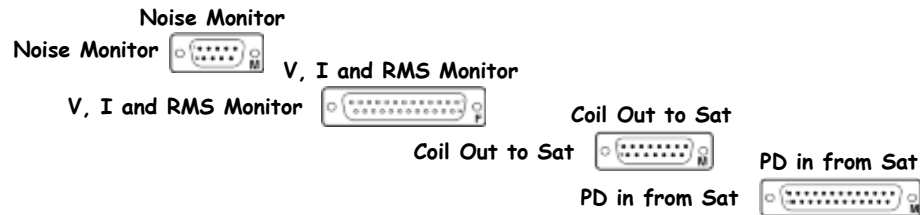

[Driver Board: D0902747](#)

[Monitor Board: D070480](#)



[D070481](#)
[D070480](#)
Front

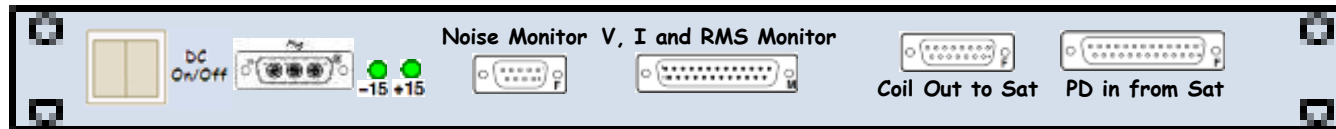
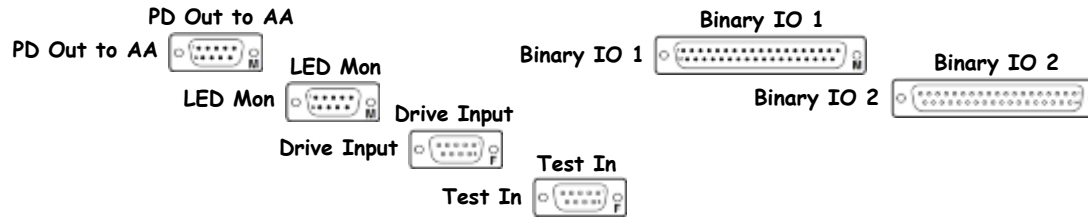

[S0900313](#)
Rear

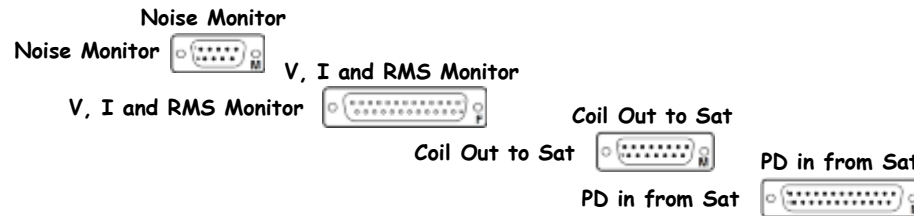

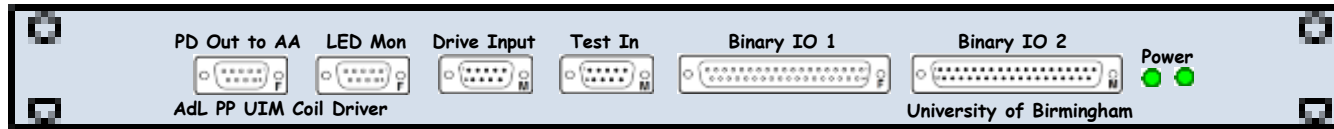

[D070481](#)
[D070480](#)
Front

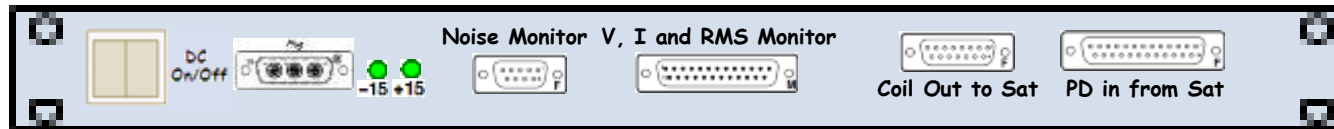
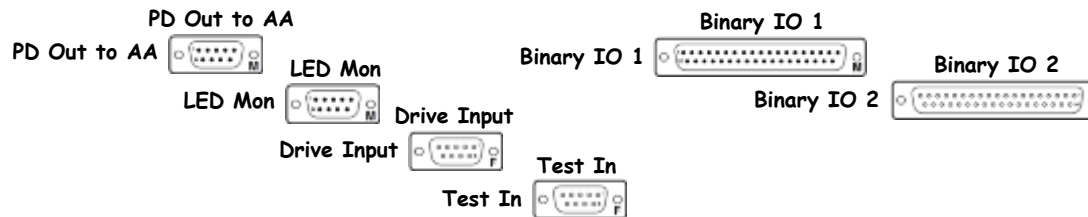

[S0900311](#)
Rear

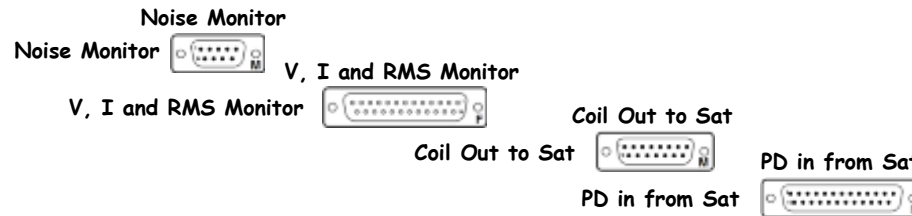

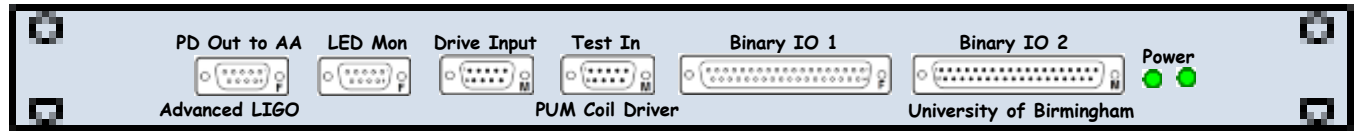

[D070483](#)
[D070480](#)
Front

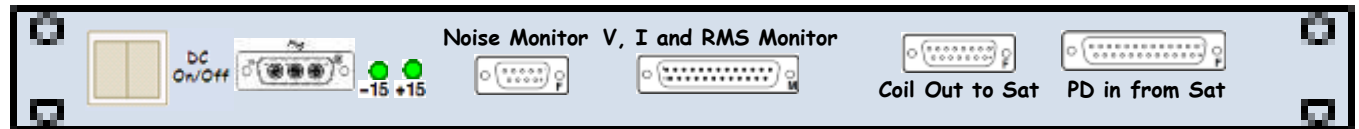
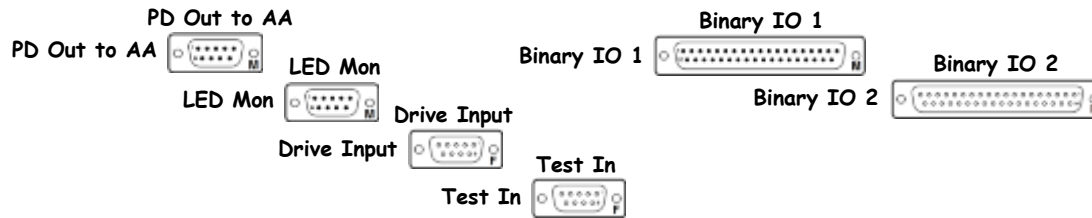

[S1101562](#)
Rear

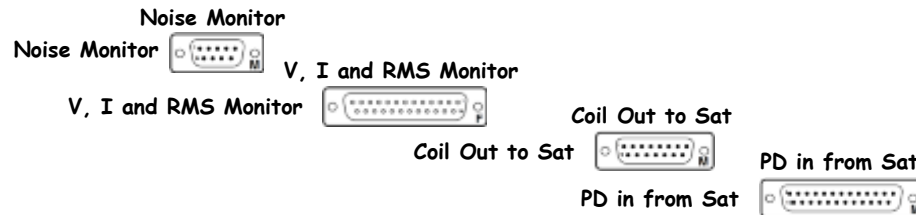

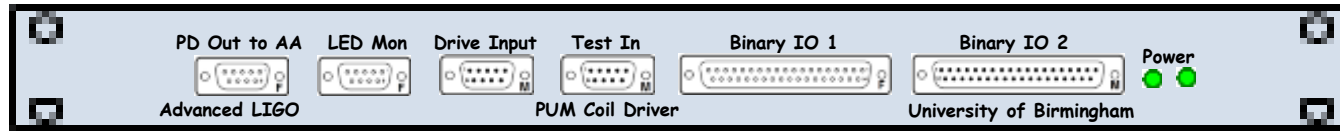

[D070483](#)
[D070480](#)
Front

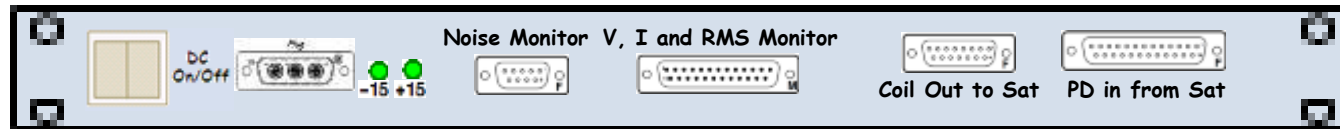
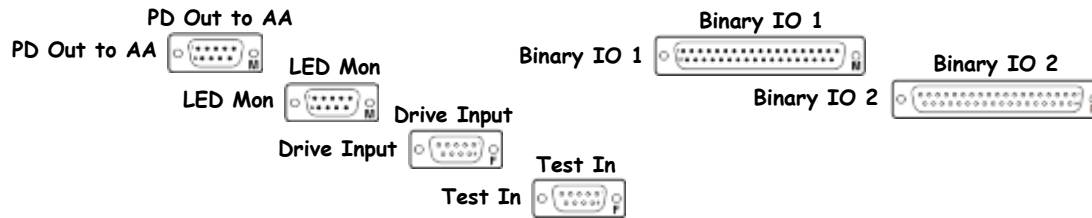

[S1101561](#)
Rear

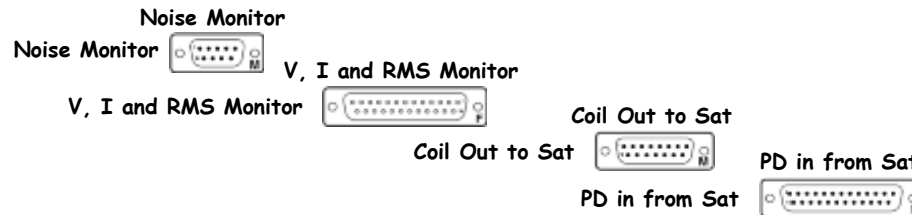

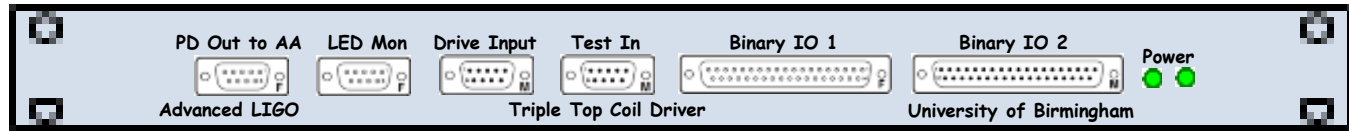

D1001242

Front

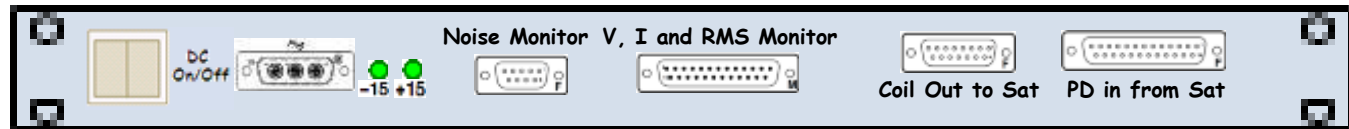
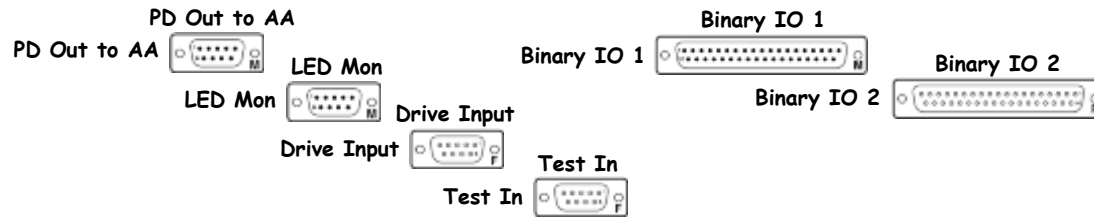

S1000265

Rear

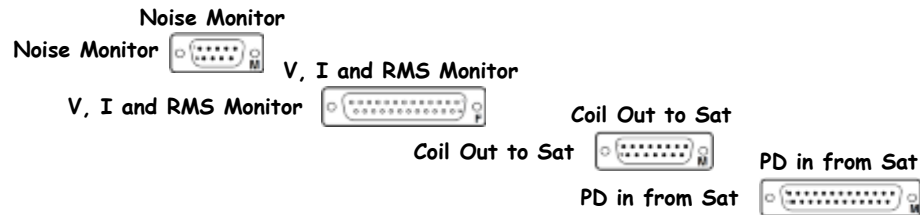

[Driver Board: D0902747](#)

[Monitor Board: D070480](#)

D1001242 - S1000258



<< L1-SUS-C5

BS Triple Top Coil Driver Chassis D1001242 S1000258 ±18VDC

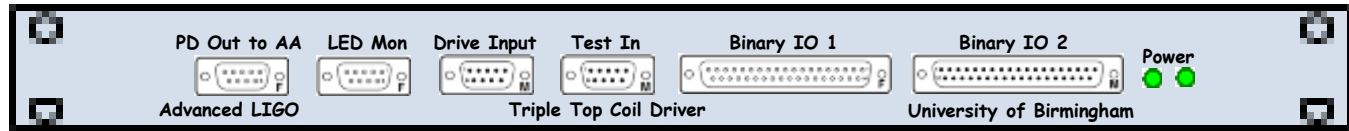

D1001242

Front

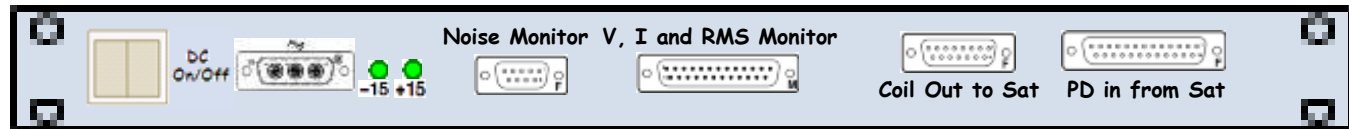
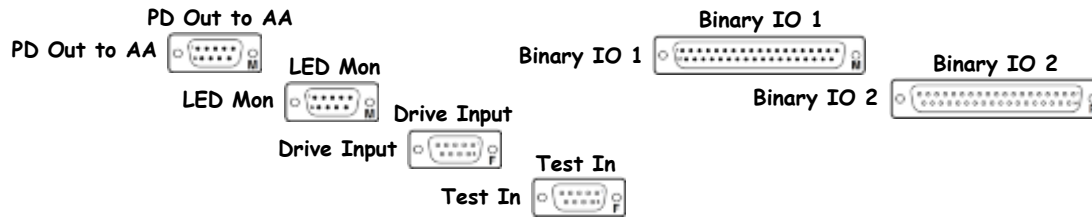

S1000258

Rear

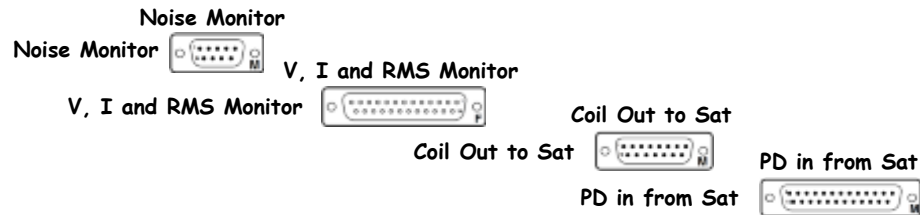

[Driver Board: D0902747](#)

[Monitor Board: D070480](#)

BS Mid Triple Acq Driver Chassis ±18VDC

This number is actually correct. The DocDB part number is erroneously D090006 because it got assigned before the Wizards decided there would be 5 digits, and they won't fix it. I've asked.

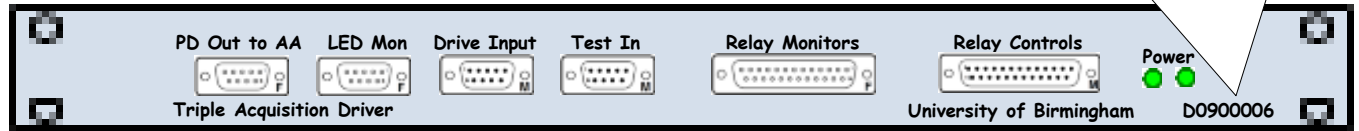

D0900006

Front

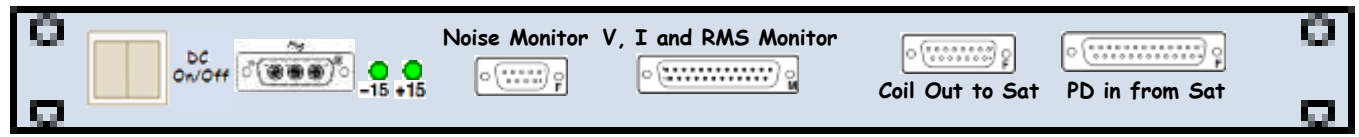
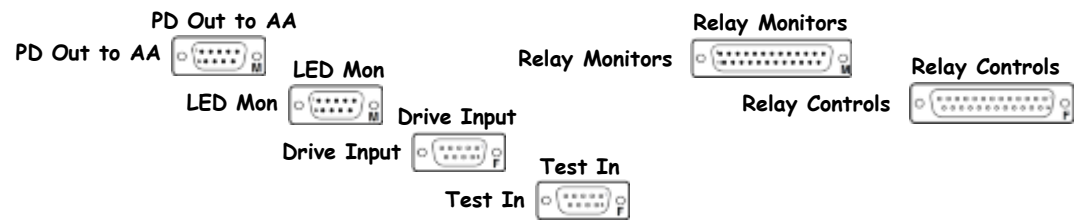

S1001110

Rear

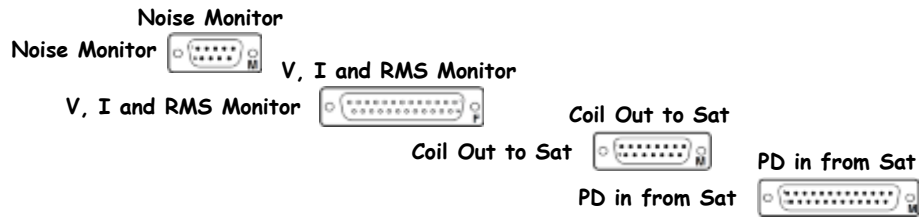

Driver Board: [D0901047](#)
Monitor Board: [D070480](#)

I1susbsc123 I/O Extension Chassis

D1001715

S1001143

+24VDC

D1001715

Front

Timing Slot

I1susbsc123 – I/O Extender

TB-01

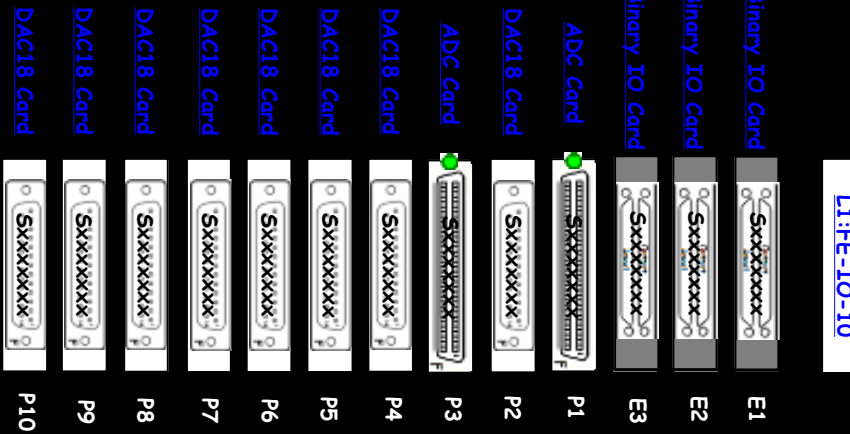

S1001143

Rear

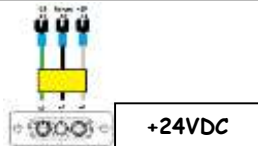
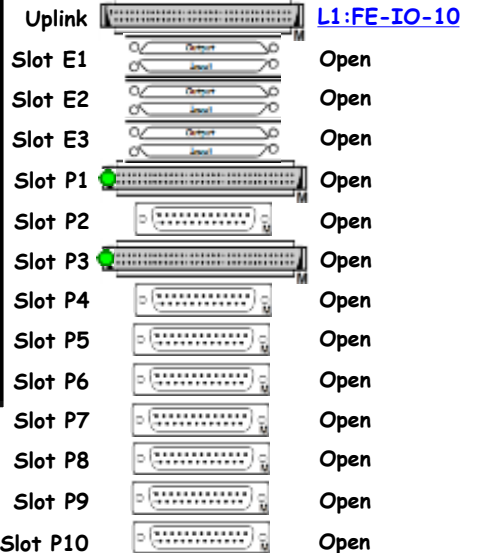

<< L1-SUS-C5

I1susauxbsc123 I/O Extension Chassis

D1001715

S1103888

+24VDC

D1001715

Front

Timing Slot

I1susauxbsc123 – I/O Extender

S1103888

Rear

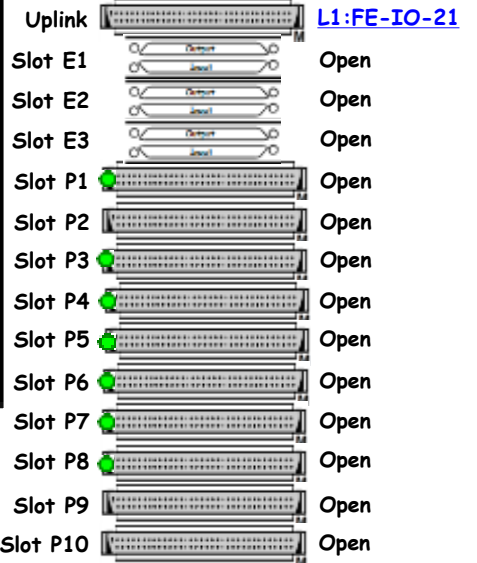

L1:FE-IO-21

E1

E2

E3

P1

P2

P3

P4

P5

P6

P7

P8

P9

P10

ADC Card

ADC Card

ADC Card

ADC Card

ADC Card

ADC Card

ADC Card

ADC Card

P1

P2

P3

P4

P5

P6

P7

P8

P9

P10

PTY-002

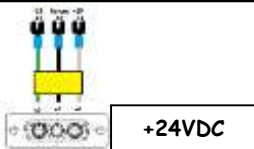

+24VDC

L1-SUS-C6 - S1105376

<< CER

SUS ITMX, ITMY, and BS Rack 2 (of 2) Layout (D1200875) (S1105376)

		42			
FE ADC0 Anti-Alias Chassis	D0902783	41	S1107600		±18VDC
FE ADC1 Anti-Alias Chassis	D0902783	40	S1100330		±18VDC
		39			
FE DAC0, FE DAC1 Anti-Image Chassis	D1000305	38	S1101808		±18VDC
FE DAC2, FE DAC3 Anti-Image Chassis	D1000305	37	S1101809		±18VDC
		36			
FE DAC4, FE DAC5 Anti-Image Chassis	D1000305	35	S1101810		±18VDC
		34			
Binary Output Chassis (4*DB9, 2*DB37)	D1001270	33	S1101754		±18VDC
Binary Input Chassis (4*DB9, 2*DB37)	D1001269	32	S1101791		±18VDC
Binary Output Chassis (4*DB9, 2*DB37)	D1001270	31	S1101751		±18VDC
Binary Input Chassis (4*DB9, 2*DB37)	D1001269	30	S1101793		±18VDC
Binary Output Chassis	D1000725	29	S1101783		±18VDC
Binary Input Chassis	D1000726	28	S1101803		±18VDC
		27			
		26			
		25			
		24			
FE DAC6, FE DAC7 Anti-Image Chassis	D1100815	23	S1103828		±18VDC
		22			
		21			
		20			
MON ADC0 Anti-Alias Chassis	D1000721	19	S1107502		±18VDC
MON ADC1 Anti-Alias Chassis	D1000721	18	S1107501		±18VDC
		17			
MON ADC2 Anti-Alias Chassis	D1000721	16	S1107463		±18VDC
MON ADC3 Anti-Alias Chassis	D1000721	15	S1107499		±18VDC
		14			
MON ADC4 Anti-Alias Chassis	D1000721	13	S1107498		±18VDC
MON ADC5 Anti-Alias Chassis	D1000721	12	S1107504		±18VDC
		11			
MON ADC6 Anti-Alias Chassis	D1000721	10	S1107497		±18VDC
		9			
Laser Power Monitor Marshaling Chassis	Dxxxxxxx	8	Sxxxxxxx		±18VDC
FE2 ADC0 Anti-Alias Chassis	D1000721	7	S1201132		±18VDC
		6			
		5			
		4			
		3			
		2			
		1			
	Front		Rear		



SUS-C6 is part of [D1100022](#).

L1-SUS-C6 Details



D0902783

Front

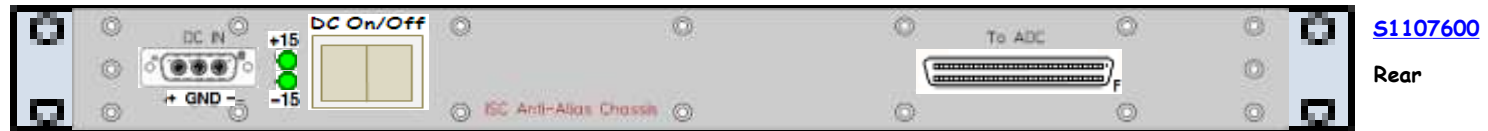
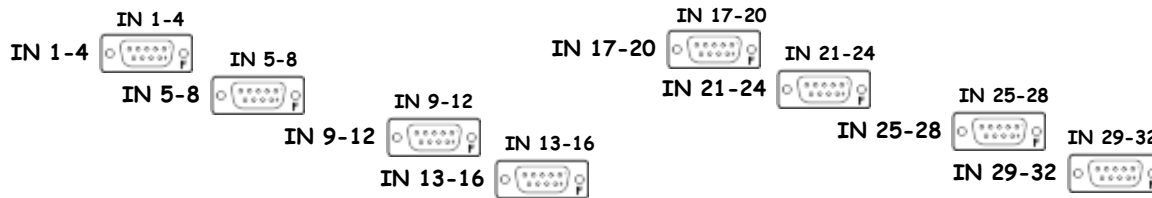

S1107600

Rear





D0902783

Front

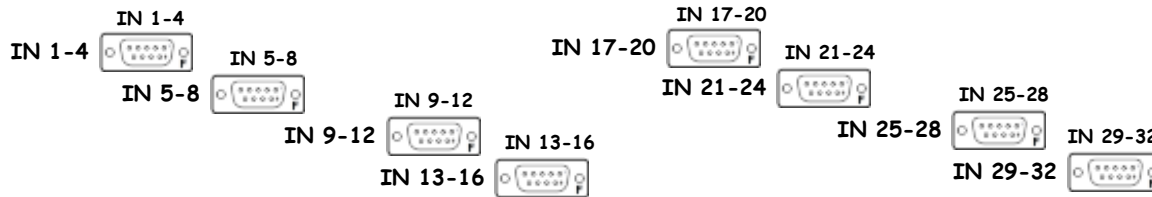

S1100330

Rear



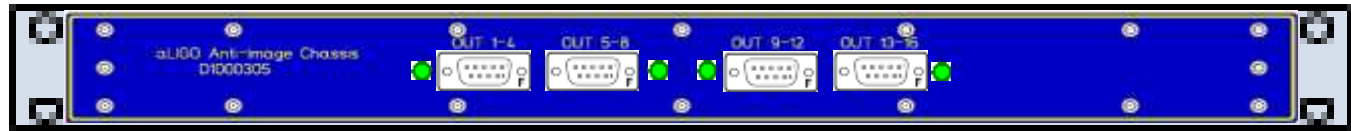

D1000305

Front

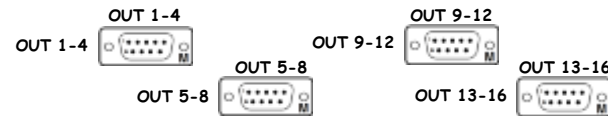

S1101808

Rear

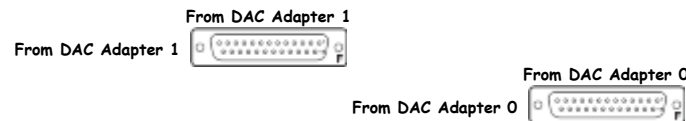

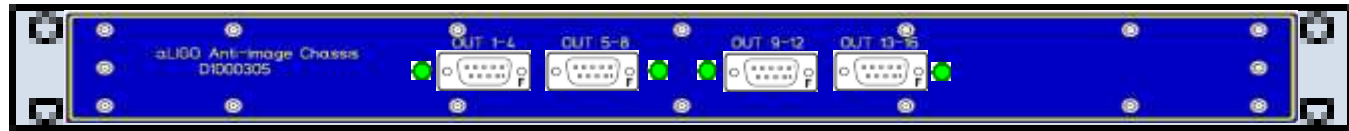

D1000305

Front

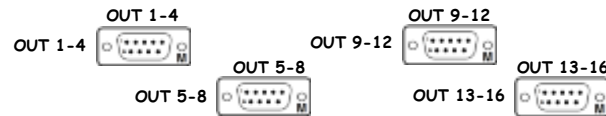

S1101809

Rear

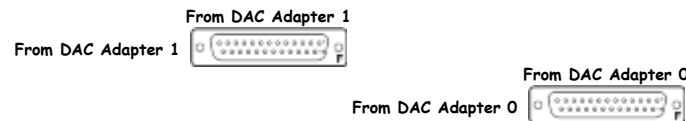

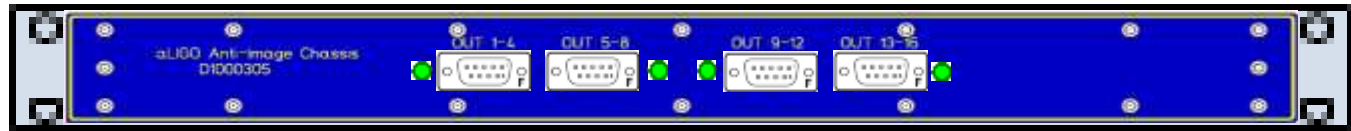

D1000305

Front

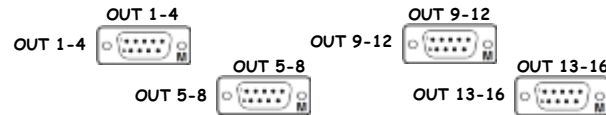

S1101810

Rear

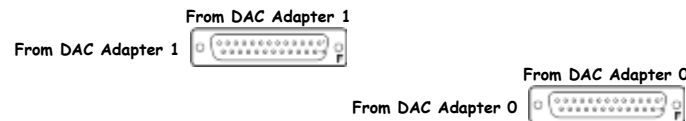

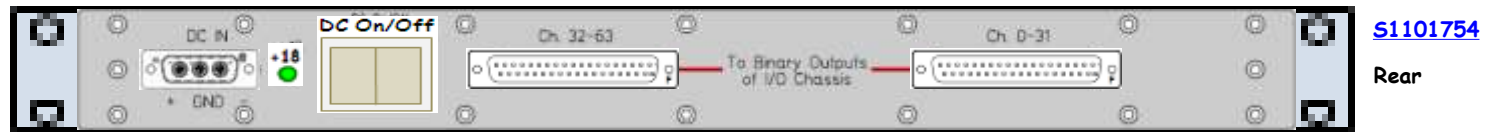
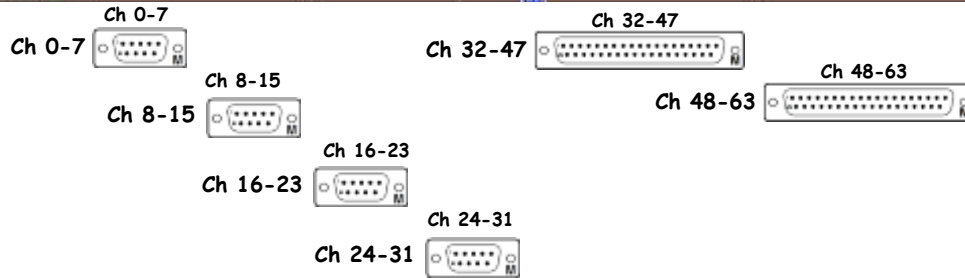

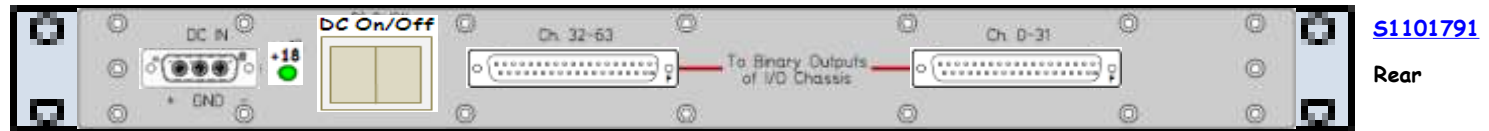
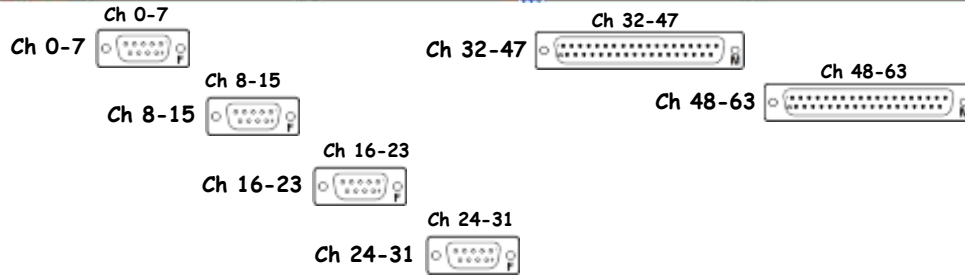
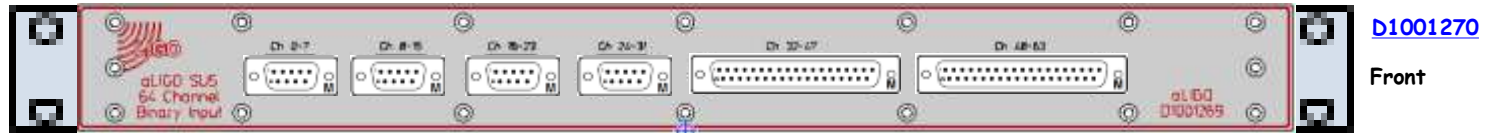

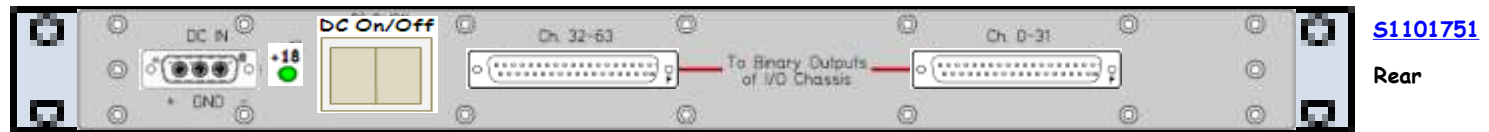
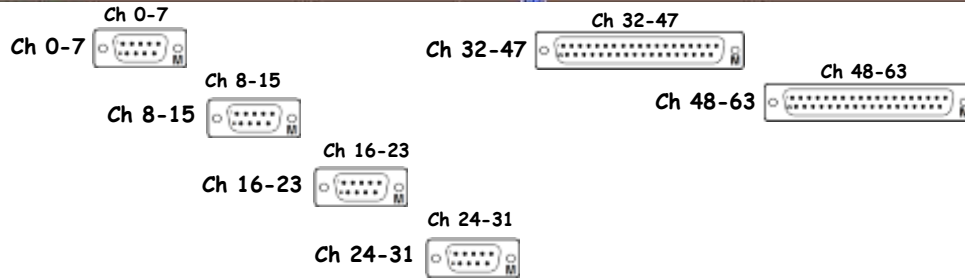

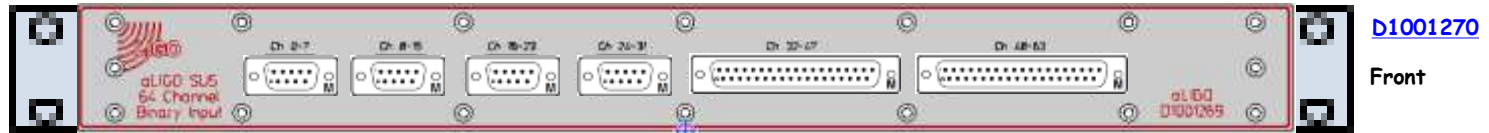

D1001270

Front

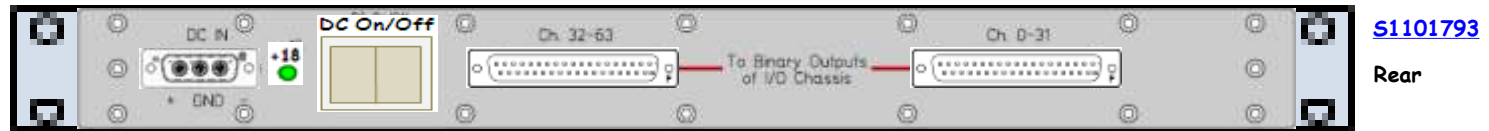
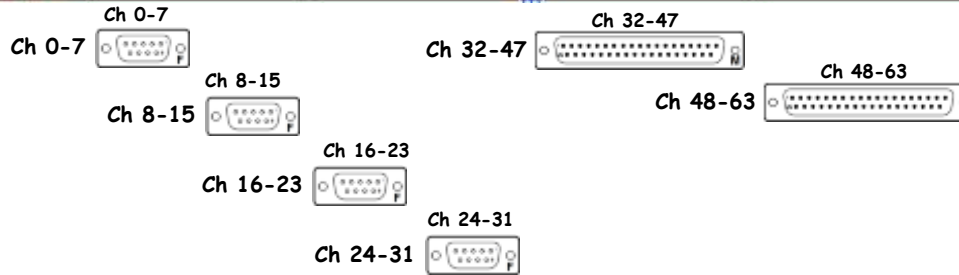

S1101793

Rear



Binary Output Chassis D1000725 S1101783 ±18VDC



D1000725

Front

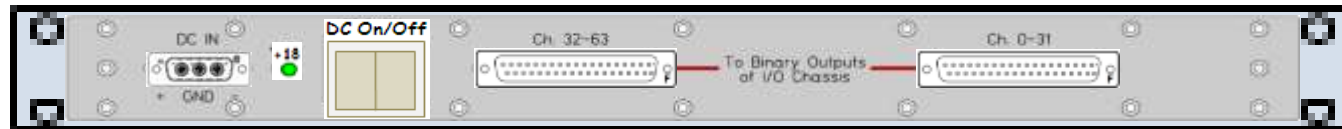
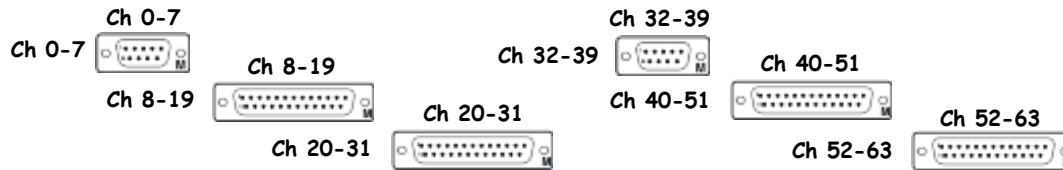

S1101783

Rear



Binary Input Chassis D1000726 S1101803 ±18VDC



D1000726

Front

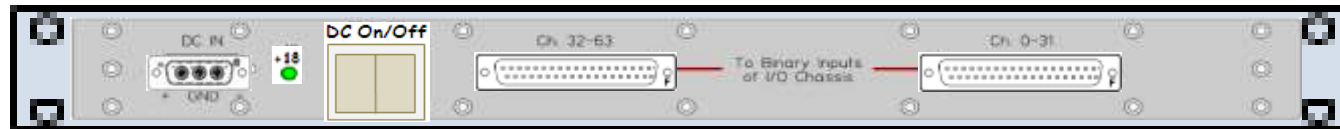
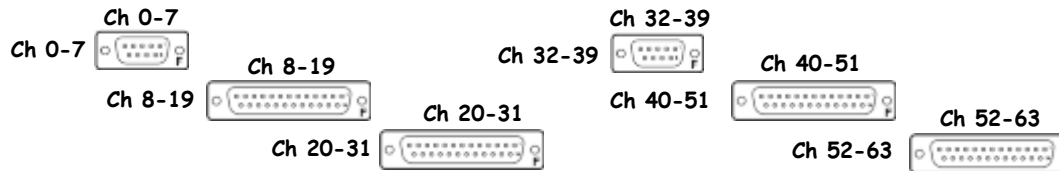

S1101803

Rear



D1100815 is an AI, which means it has OUTPUTS, not INPUTS. The labels are incorrect.

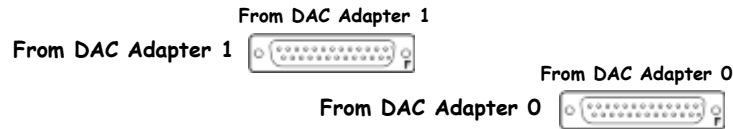
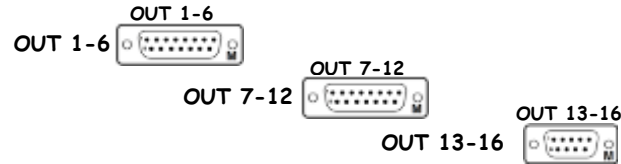

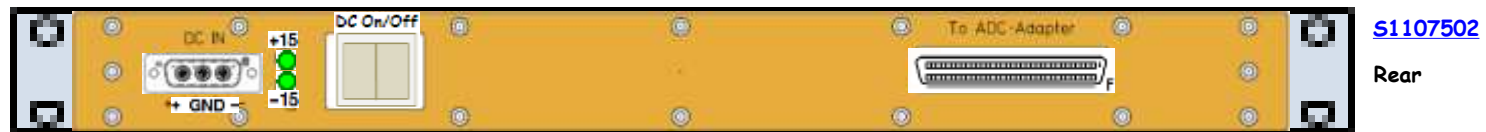
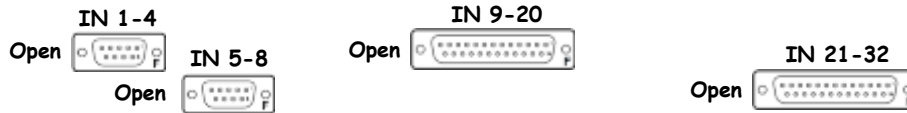

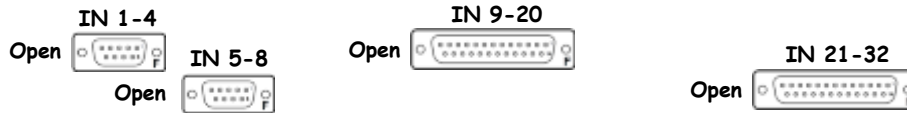

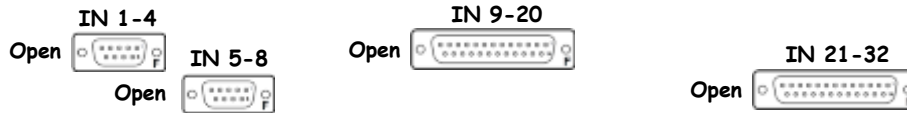

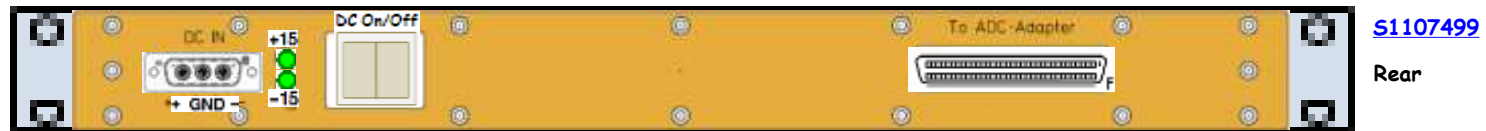
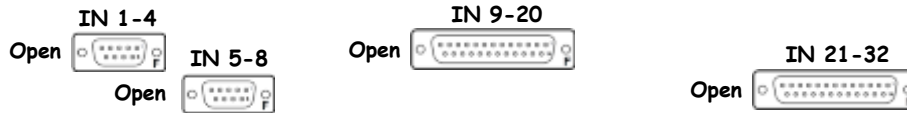

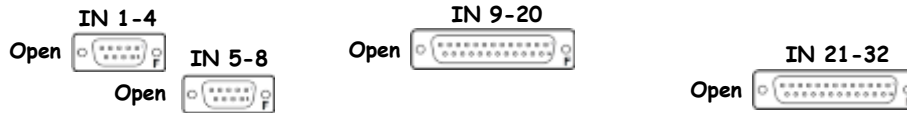

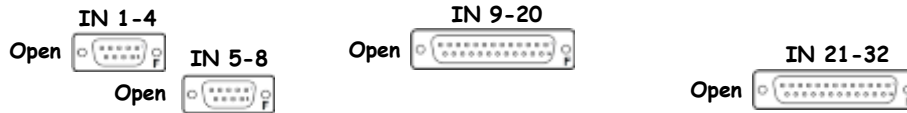

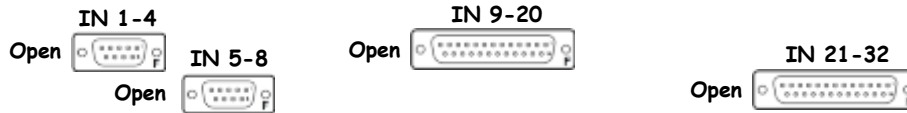

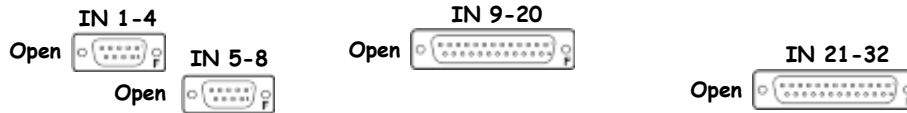

SR3-SRM Triple Top Coil Driver Chassis	D1001242	42	S1000255	±18VDC
SR3-SRM Triple Top Coil Driver Chassis	D1001242	41	S1000268	±18VDC
SR3-SRM Triple Top Coil Driver Chassis	D1001242	40	S1100254	±18VDC
		39		
OMC Triple Top Coil Driver Chassis	D1100304	38	S1101565	±18VDC
OMC Triple Top Coil Driver Chassis	D1100304	37	S1101567	±18VDC
		36		
		35		
FE ADC0 Anti-Alias Chassis	D0902783	34	S1001149	±18VDC
FE ADC1 Anti-Alias Chassis	D0902783	33	S1100328	±18VDC
		32		
FE DAC0, FE DAC1 Anti-Image Chassis	D1000305	31	S1101812	±18VDC
FE DAC2, FE DAC3 Anti-Image Chassis	D1000305	30	S1101813	±18VDC
		29		
SR3 Mid Triple Acq Driver Chassis	D0900006	28	S1001190	±18VDC
SR3 Bot Triple Acq Driver Chassis	D0900006	27	S1001105	±18VDC
SRM Mid Triple Acq Driver Chassis	D0900006	26	S1001189	±18VDC
		25		
FE DAC4 Anti-Image Chassis	D1000305	24	S1101814	±18VDC
		23		
SRM Bot Triple Acq Driver Chassis	D0900006	22	S1001106	±18VDC
		21		
Binary Output Chassis	D1000725	20	S1201244	±18VDC
Binary Input Chassis	D1000726	19	S1201497	±18VDC
Binary Output Chassis (8*DB9)	D1002593	18	S1101774	±18VDC
Binary Input Chassis (8*DB9)	D1001726	17	S1101316	±18VDC
		16		
		15		
		14		
		13		
		12		
		11		
		10		
		9		
		8		
		7		
		6		
		5		
		4		
		3		
		2		
		1		



SUS-C7 is part of [D1002740](#).

L1-SUS-C7 Details

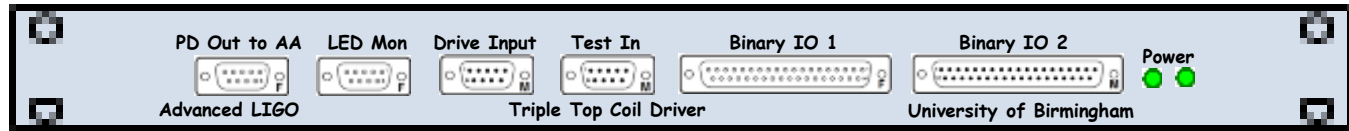

[D1001242](#)

Front

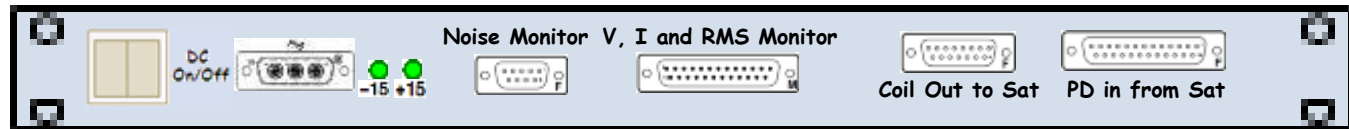
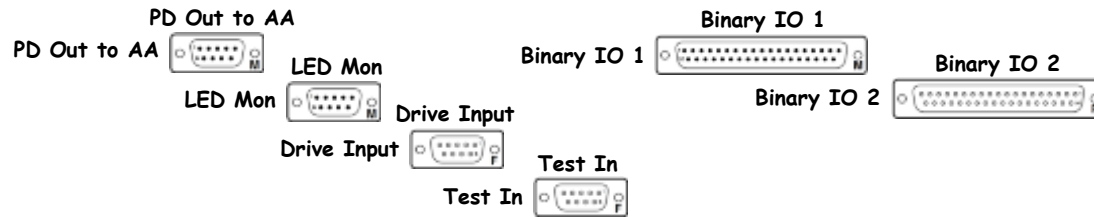

[S1000255](#)

Rear

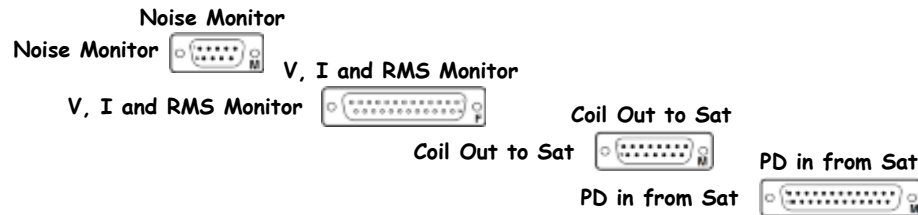

[Driver Board: D0902747](#)

[Monitor Board: D070480](#)

D1001242 - S1000268



<< L1-SUS-C7

SR3-SRM Triple Top Coil Driver Chassis D1001242 S1000268 ±18VDC

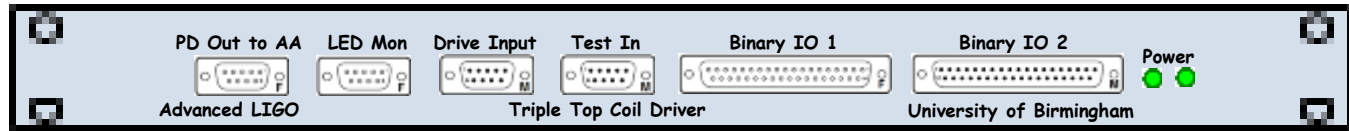

D1001242

Front

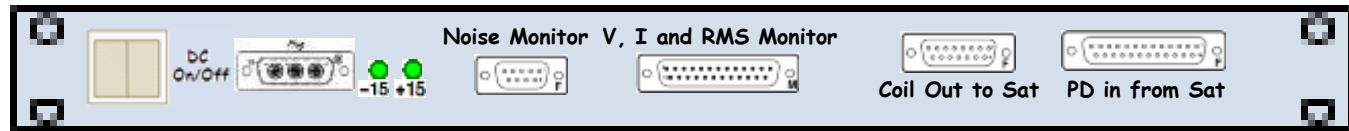
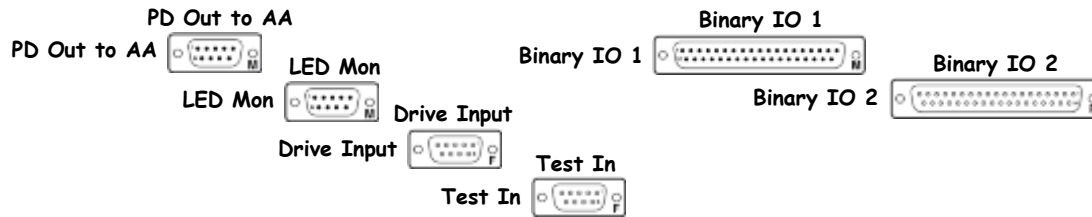

S1000268

Rear

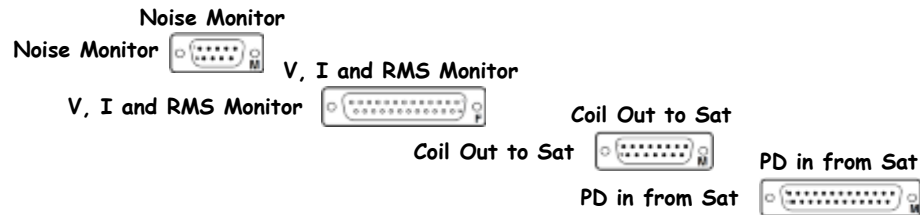

[Driver Board: D0902747](#)

[Monitor Board: D070480](#)

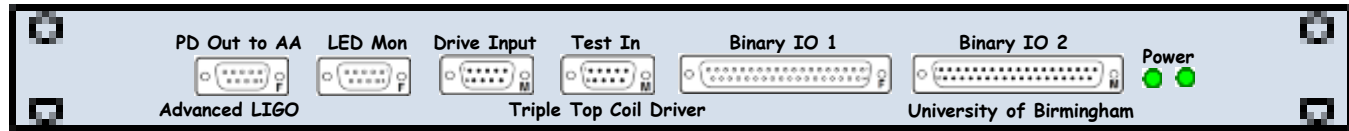

D1001242

Front

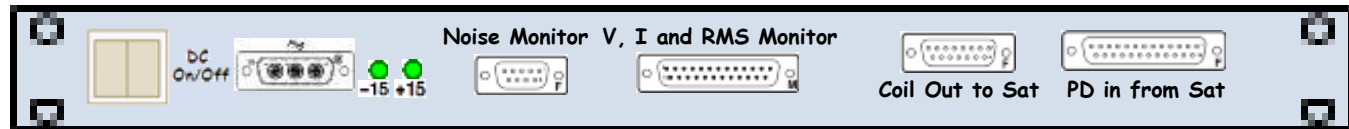
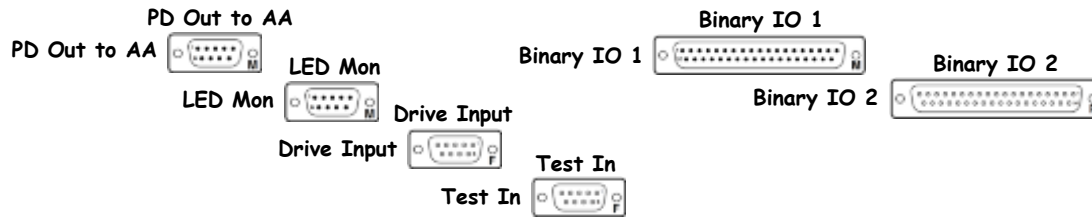

S1100254

Rear

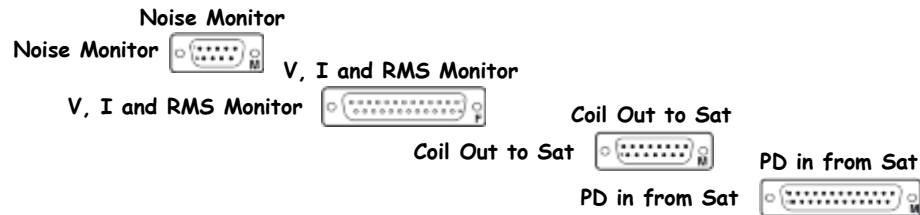

[Driver Board: D0902747](#)

[Monitor Board: D070480](#)

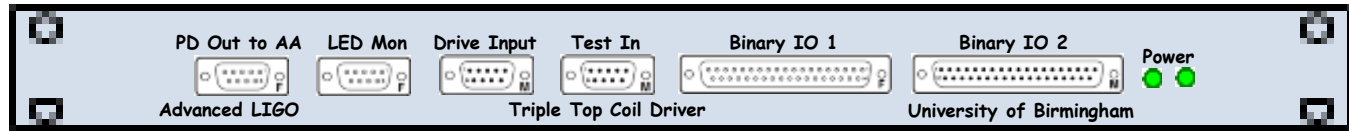

D1100304

Front

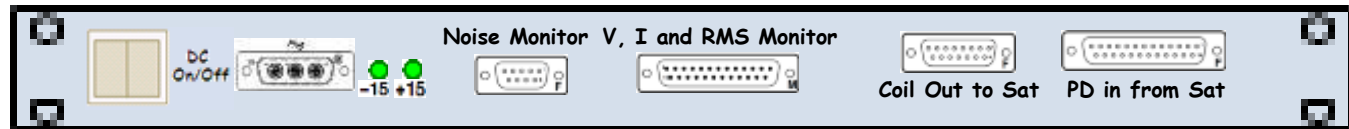
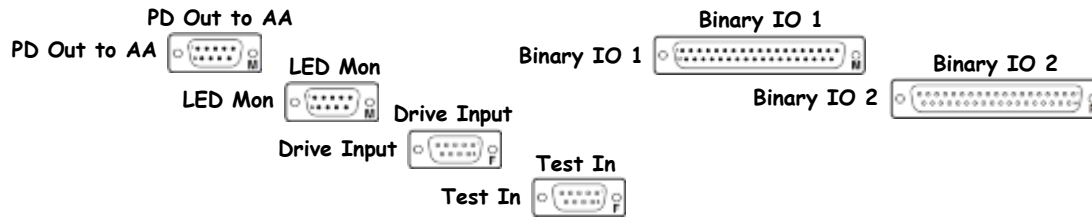

S1101565

Rear

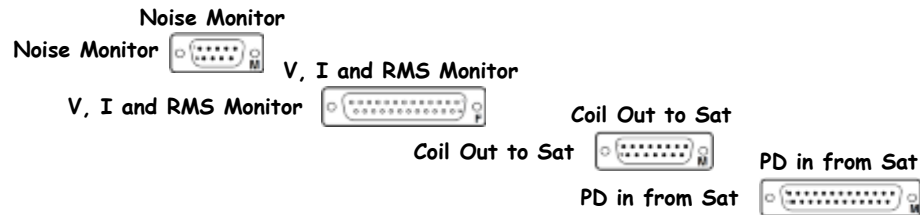

[Driver Board: D0902747](#)

[Monitor Board: D070480](#)

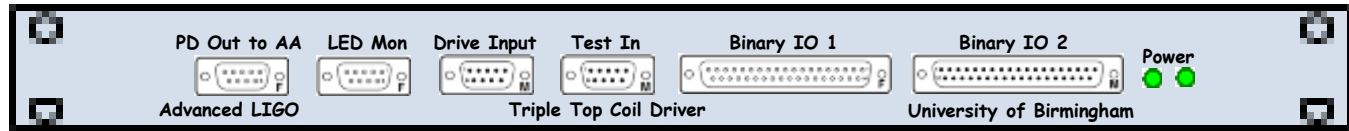

D1100304

Front

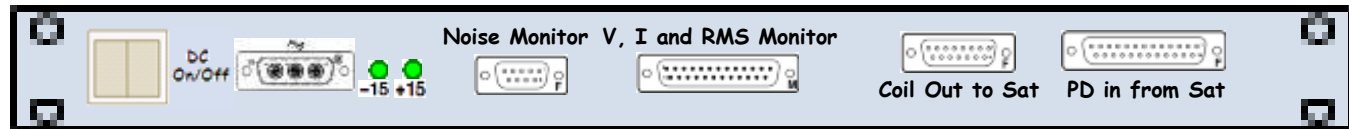
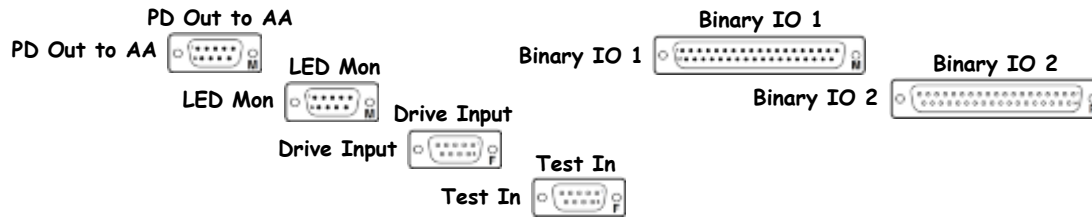

S1101567

Rear

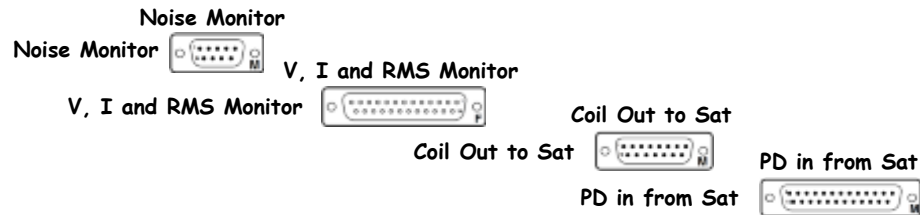

[Driver Board: D0902747](#)

[Monitor Board: D070480](#)



[D0902783](#)

Front

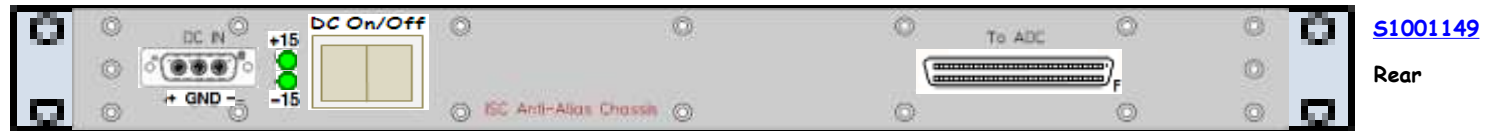
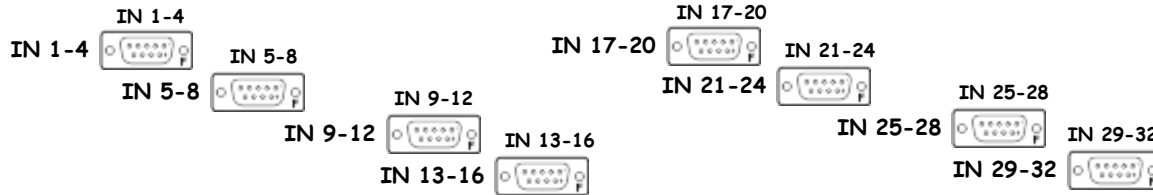

[S1001149](#)

Rear



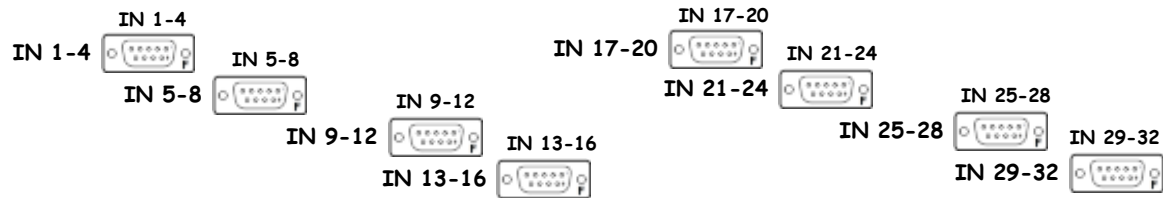
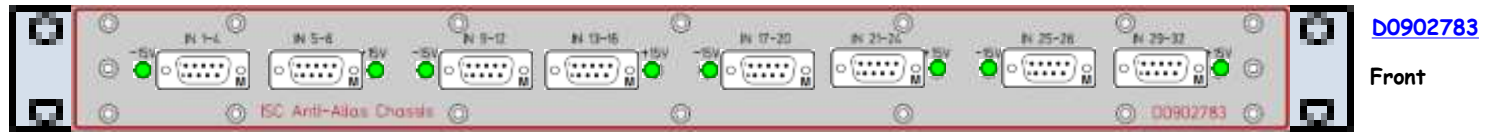

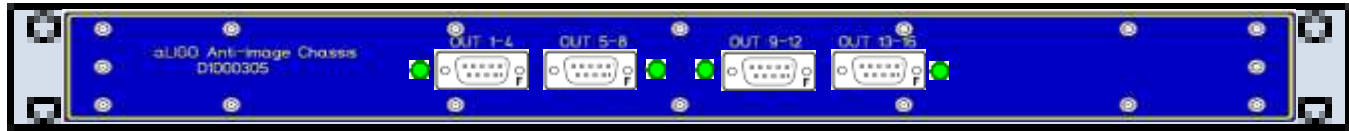

D1000305

Front

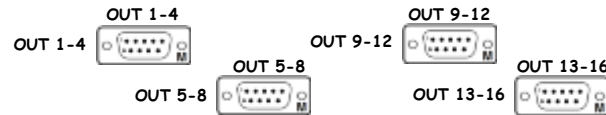

S1101812

Rear

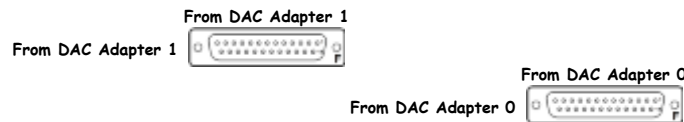

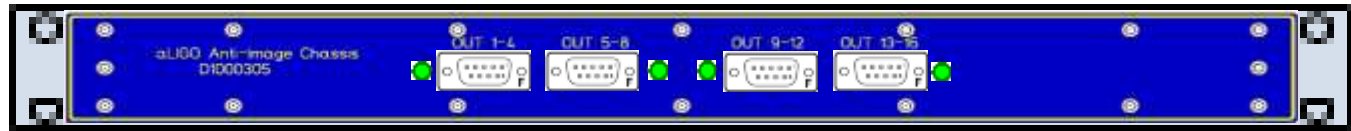

D1000305

Front

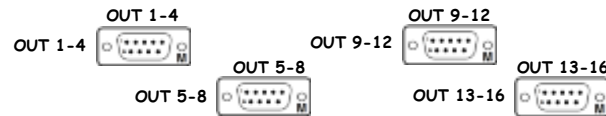

S1101813

Rear

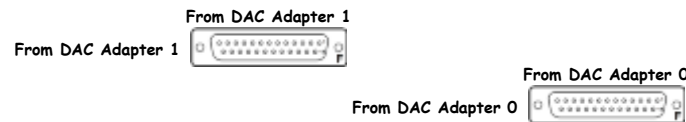

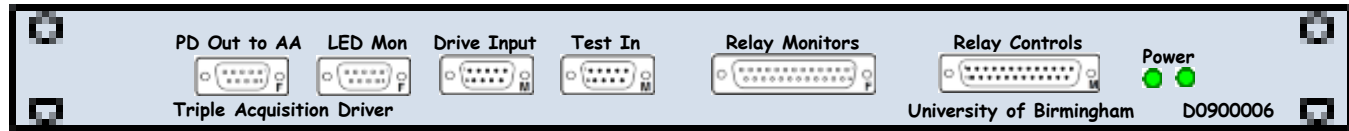

[D0900006](#)

Front

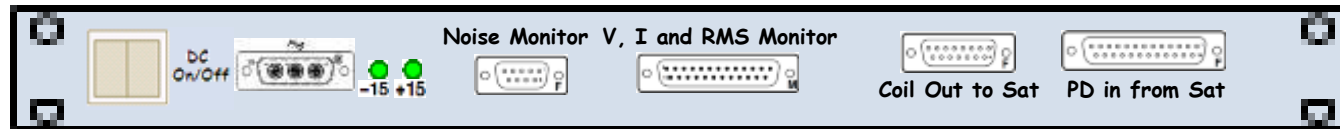
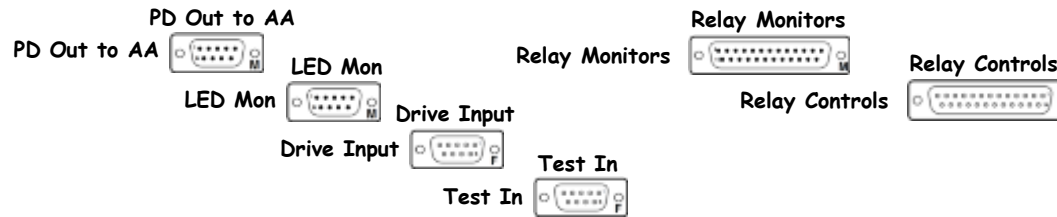

[S1001190](#)

Rear

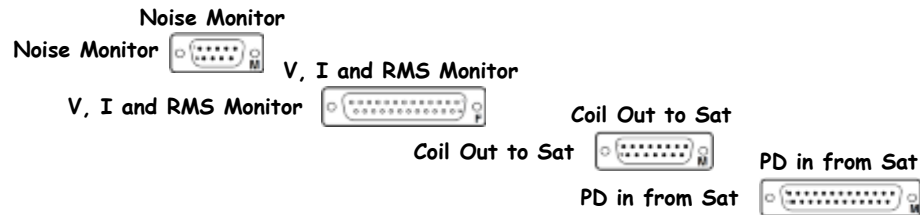

[Driver Board: D0901047](#)

[Monitor Board: D070480](#)

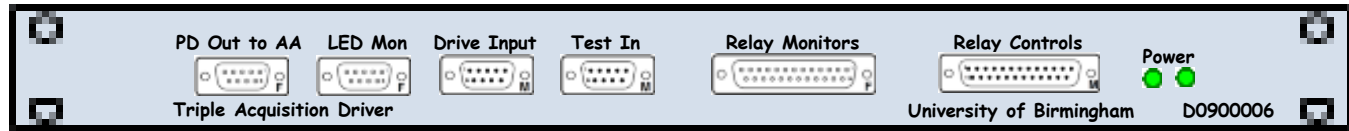

D0900006

Front

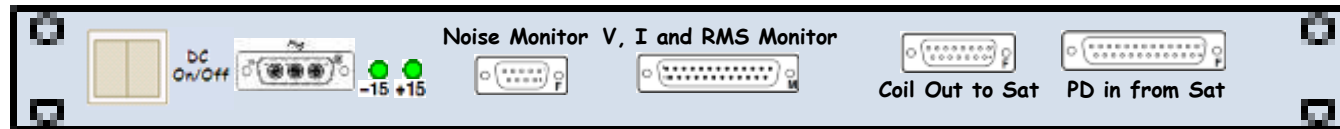
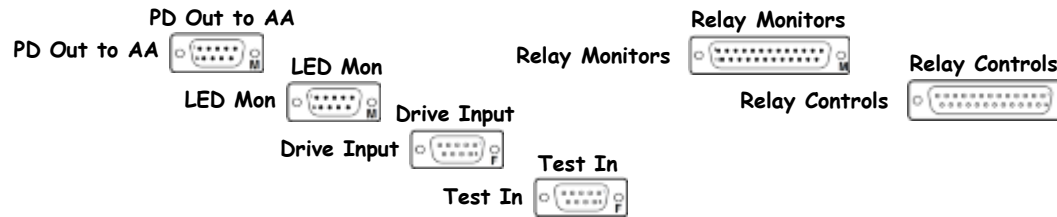

S1001105

Rear

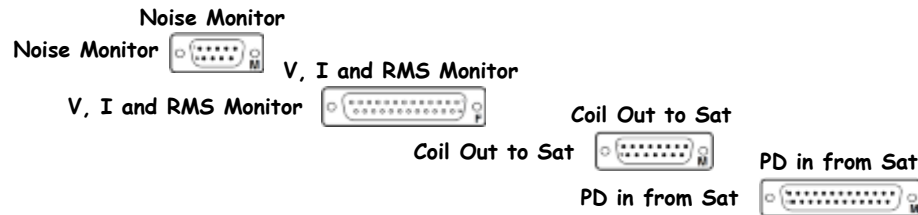

[Driver Board: D0901047](#)

[Monitor Board: D070480](#)

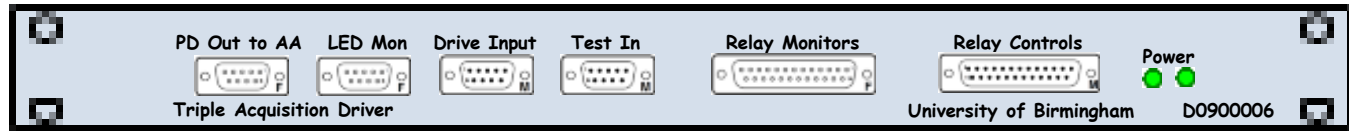

[D0900006](#)

Front

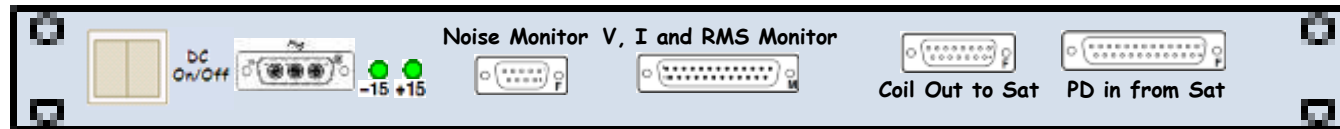
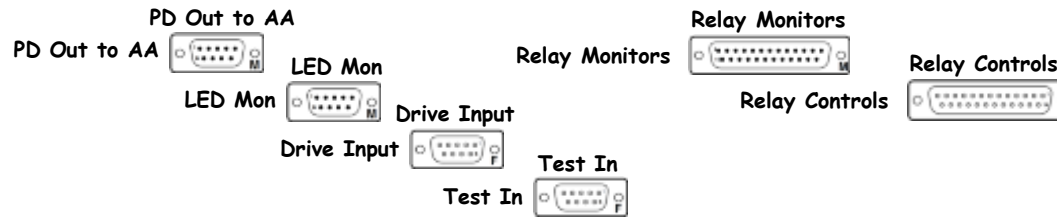

[S1001189](#)

Rear

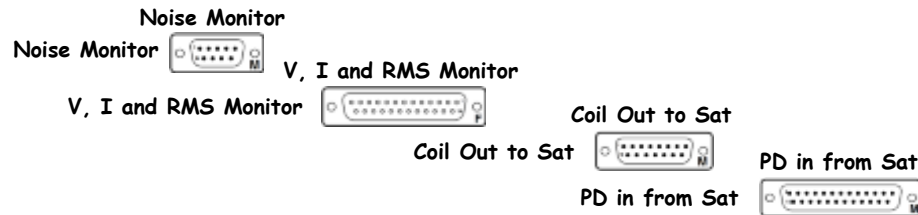

[Driver Board: D0901047](#)

[Monitor Board: D070480](#)

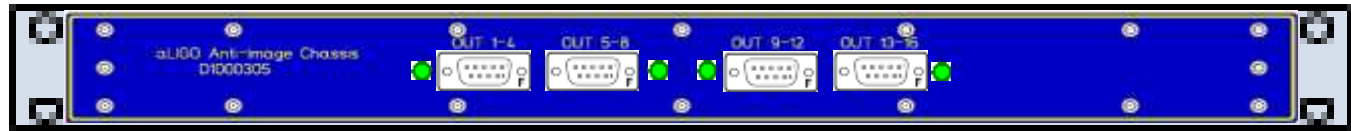

D1000305

Front

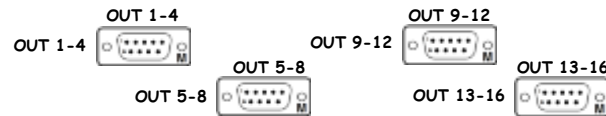

S1101814

Rear

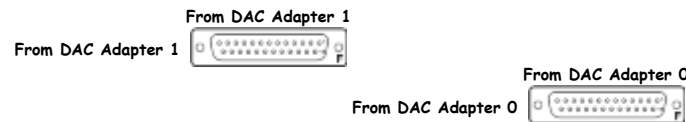

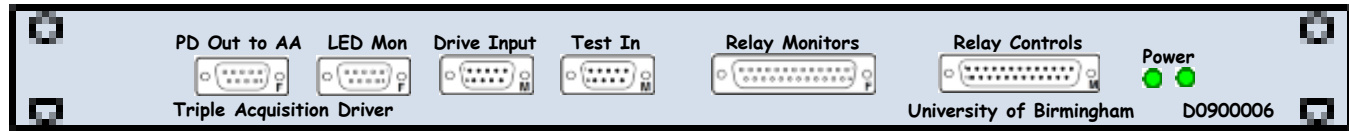

[D0900006](#)

Front

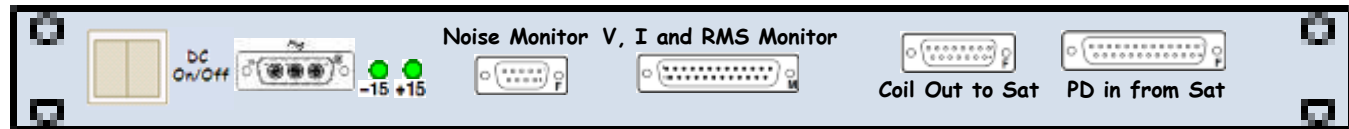
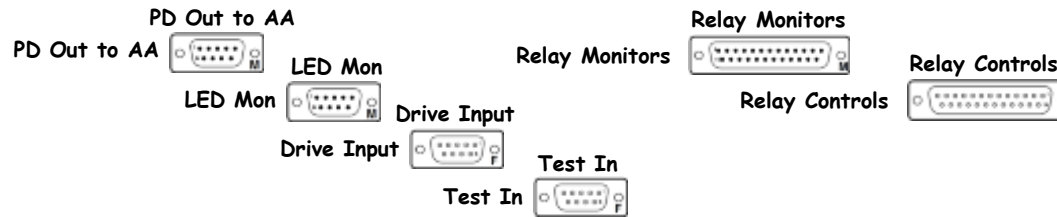

[S1001106](#)

Rear

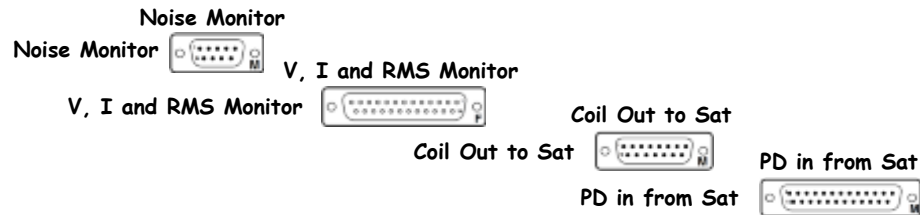

[Driver Board: D0901047](#)

[Monitor Board: D070480](#)

D1000725 - S1201244



<< L1-SUS-C7

Binary Output Chassis D1000725 S1201244 ±18VDC

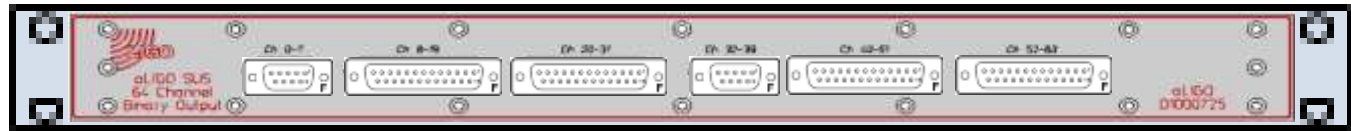

D1000725

Front

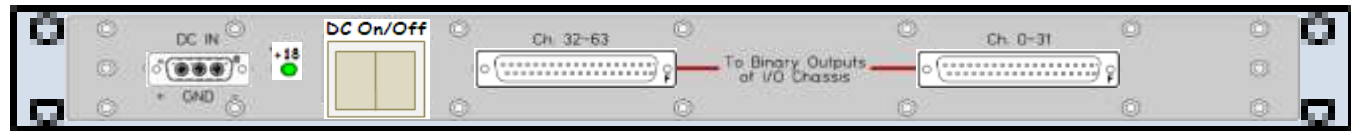
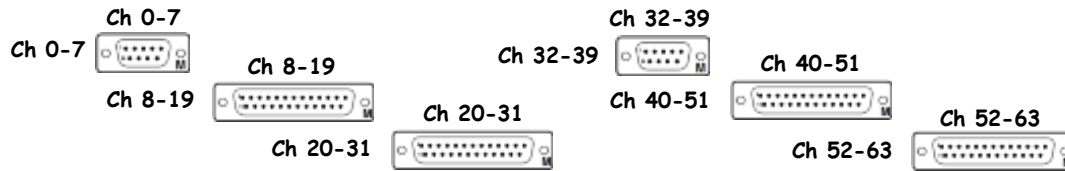

S1201244

Rear



D1000726 - S1201497



<< L1-SUS-C7

Binary Input Chassis D1000726 S1201497 ±18VDC



D1000726

Front

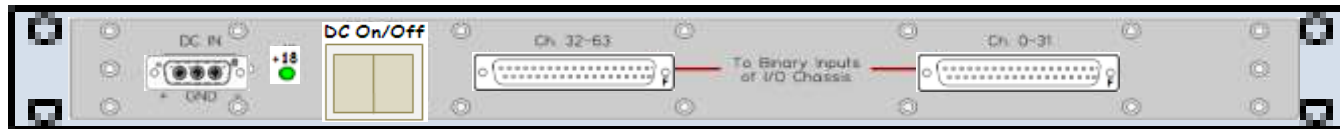
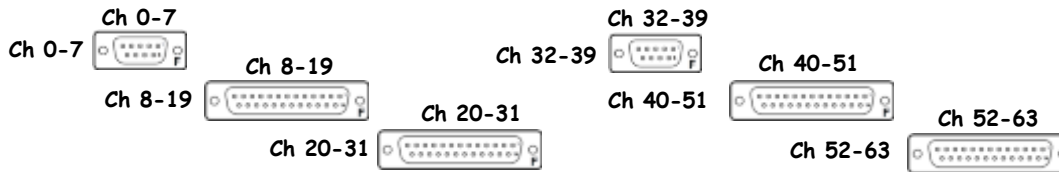

S1201497

Rear



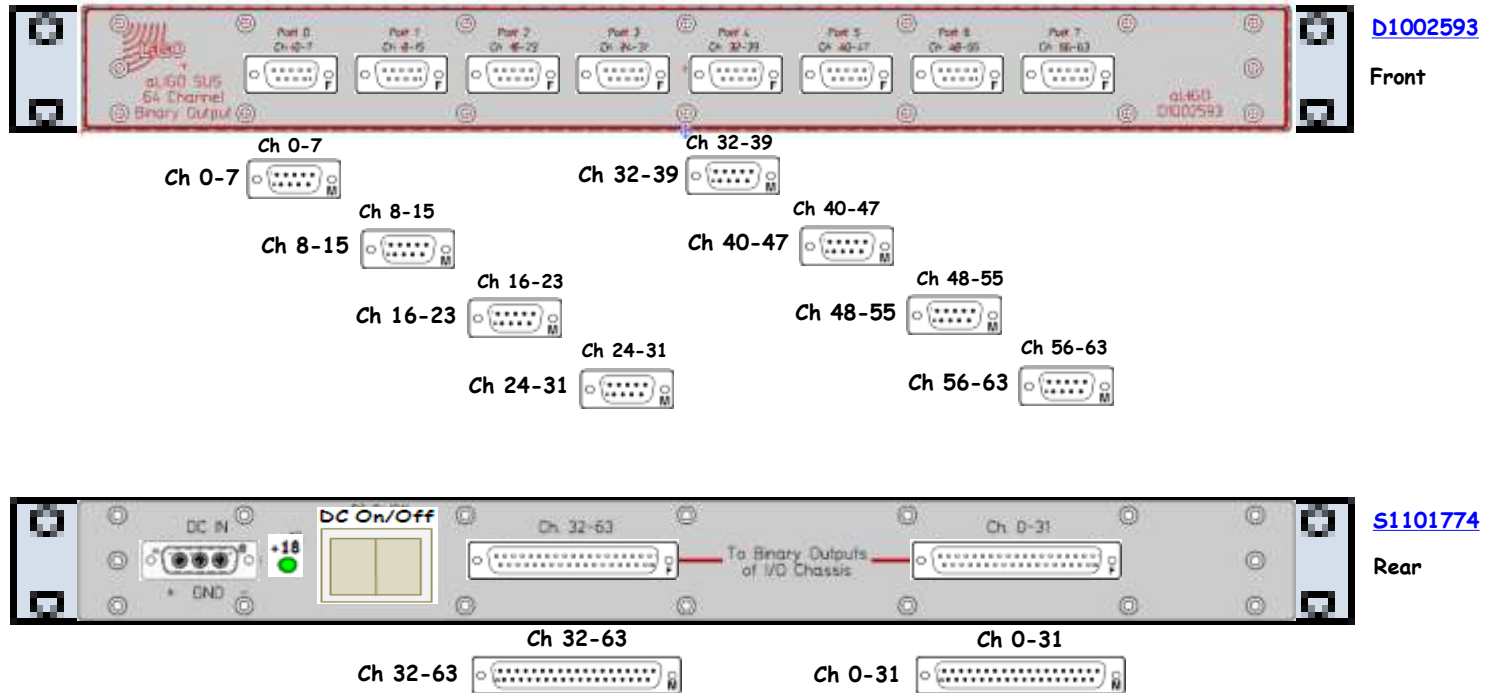

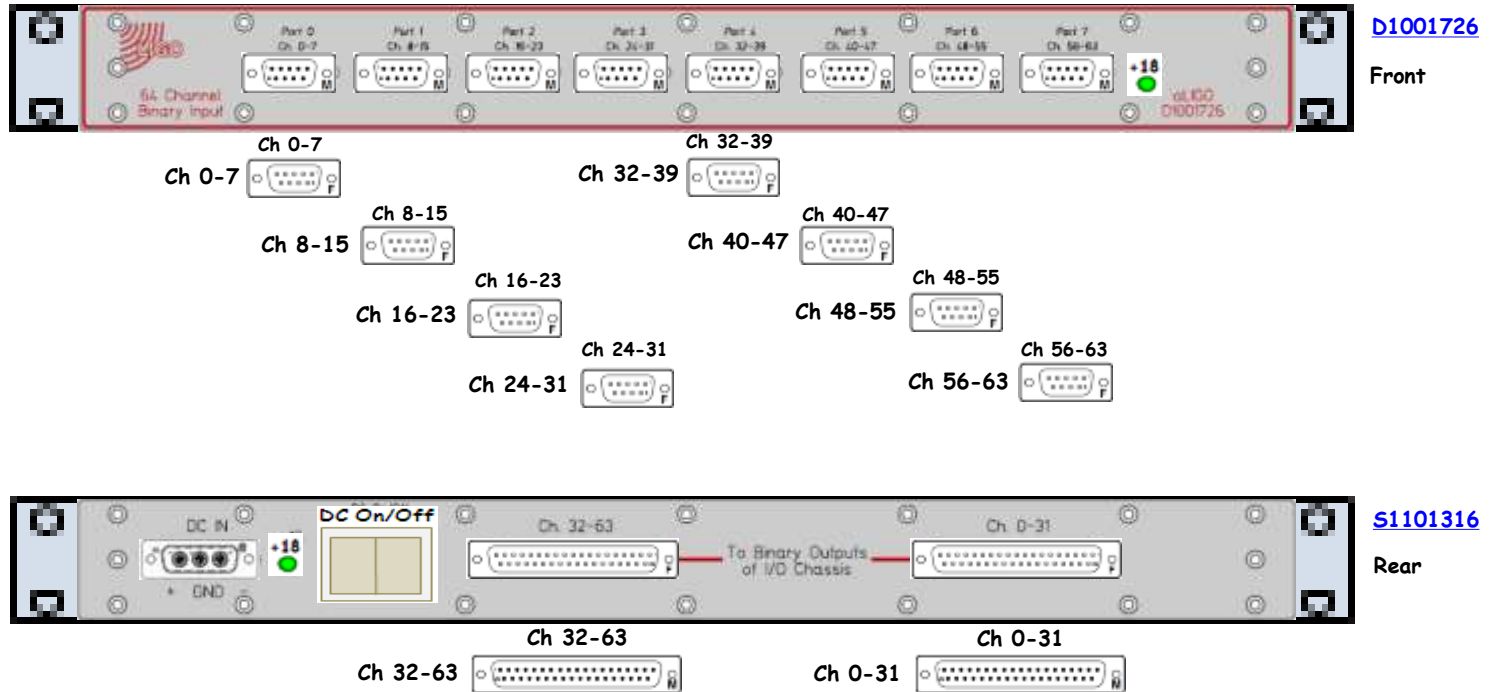

D1001726

Front

S1101316

Rear

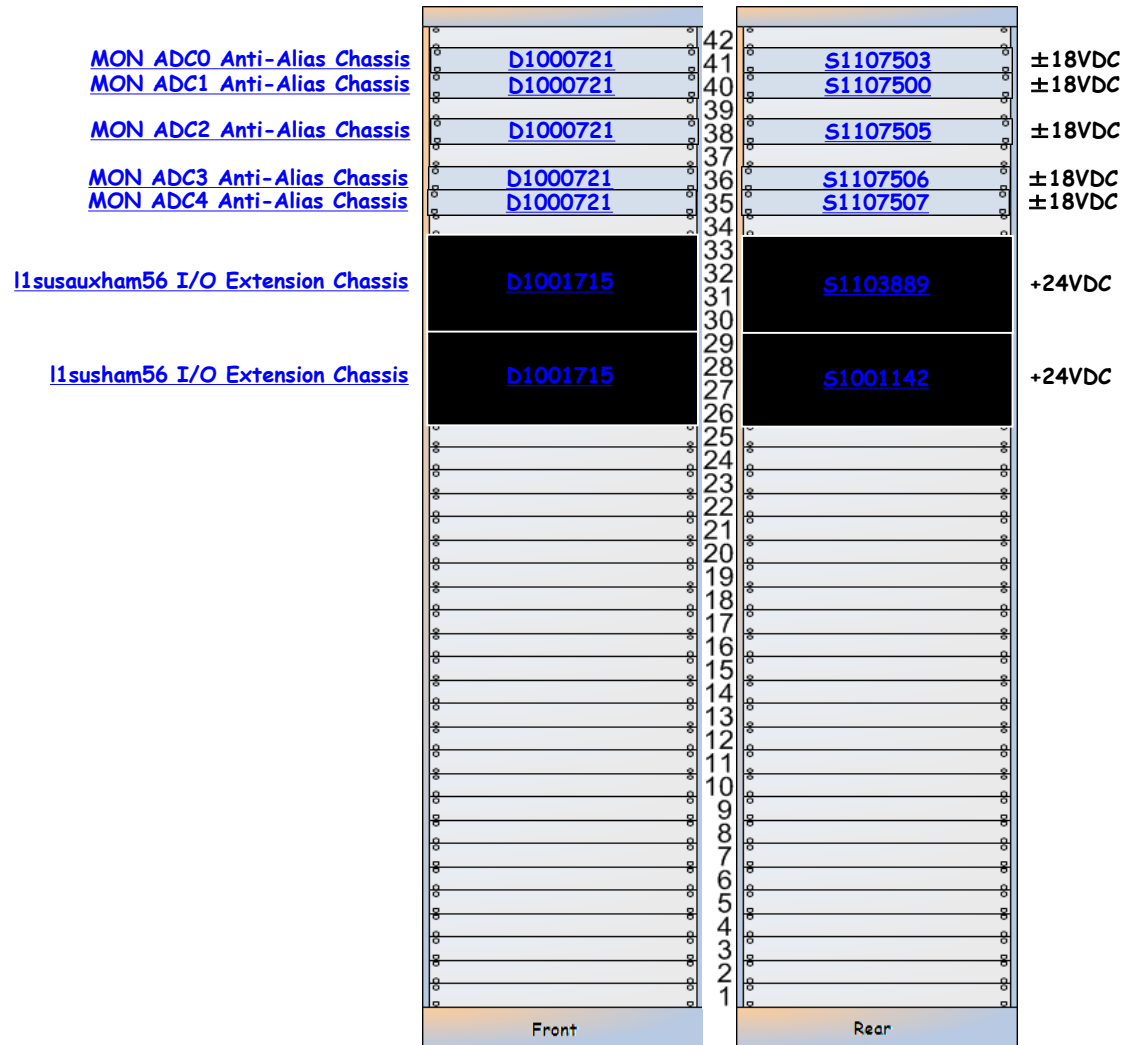

SUS-C8 is part of [D1002740](#).



L1-SUS-C8 Details

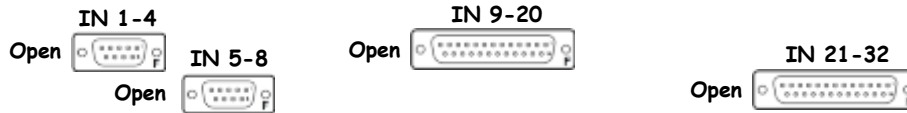

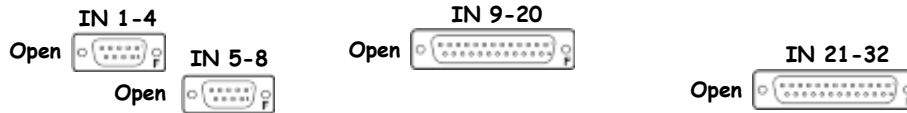

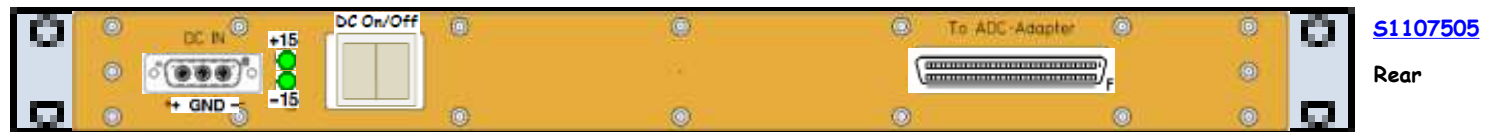
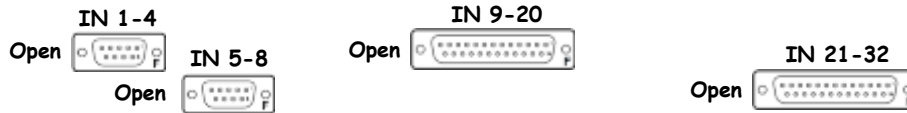

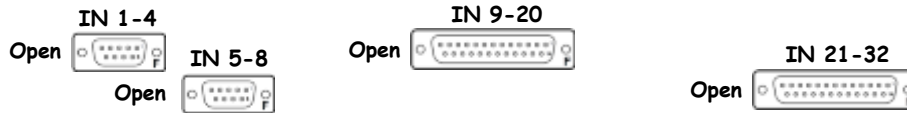

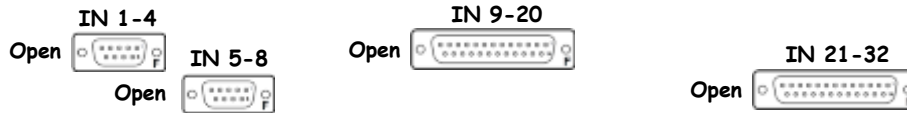

Timing Slot

I1susauxham56 – I/O Extender

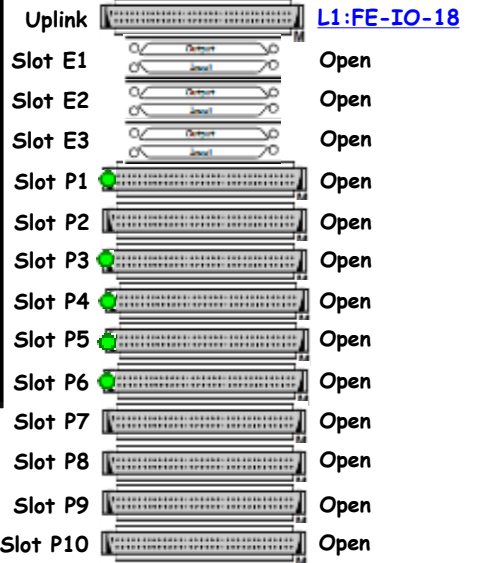

L1:FE-IO-18

E1

E2

E3

P1

P2

P3

P4

P5

P6

P7

P8

P9

P10

ADC Card

ADC Card

ADC Card

ADC Card

ADC Card

Slot P10

Slot P9

Slot P8

Slot P7

Slot P6

Slot P5

Slot P4

Slot P3

Slot P2

Slot E3

Slot E2

Slot E1

PTY-001

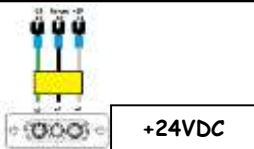

+24VDC

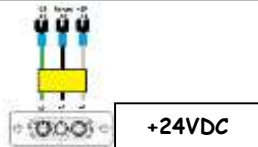
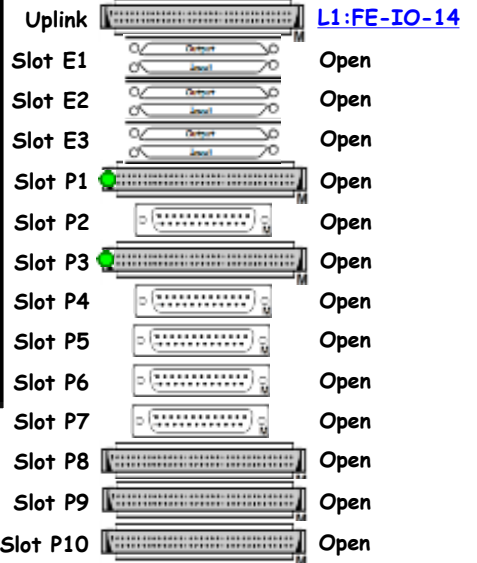
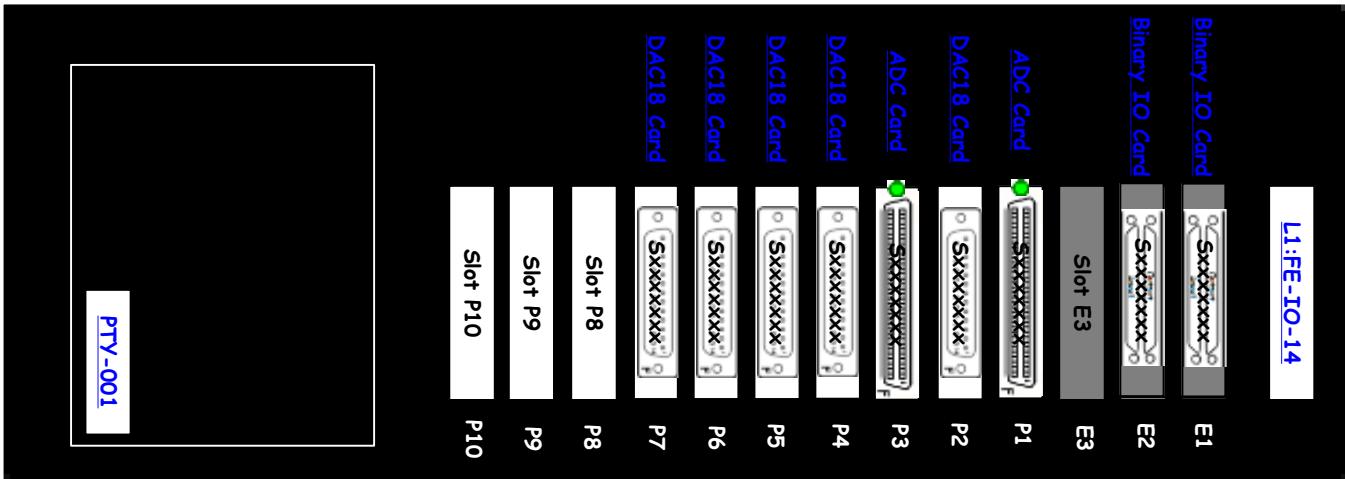
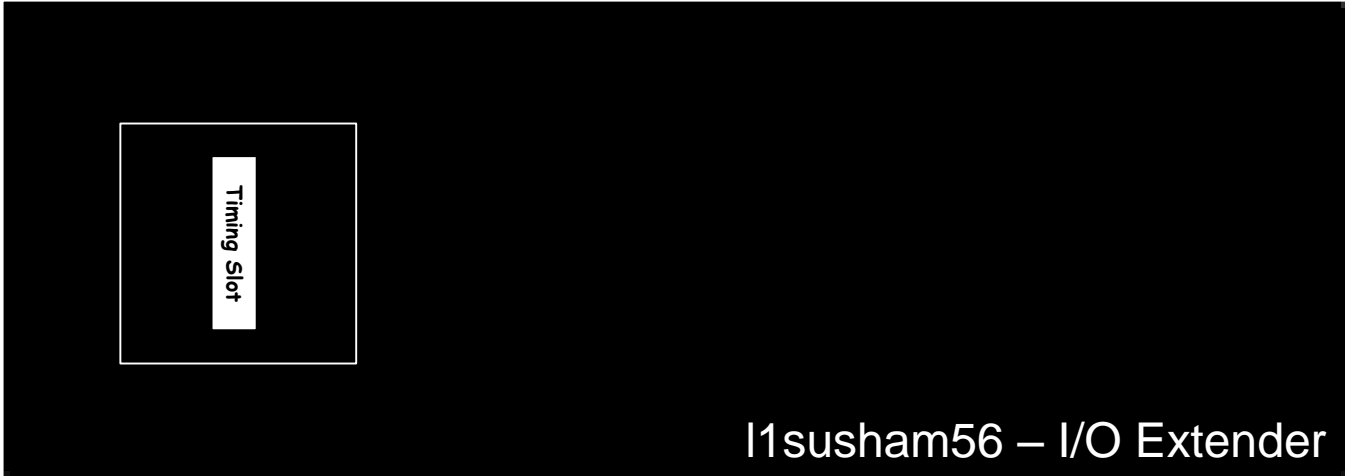

[<< LLO Corner Station](#)

[<< LLO Racks by AREA](#)

[<< LLO CDS Components](#)

LVEA

17 Field Racks are in the LVEA, including the Vacuum Racks.
See [D1003141](#)) at LLO and [D1002704](#) at LHO.

LVEA Access Points

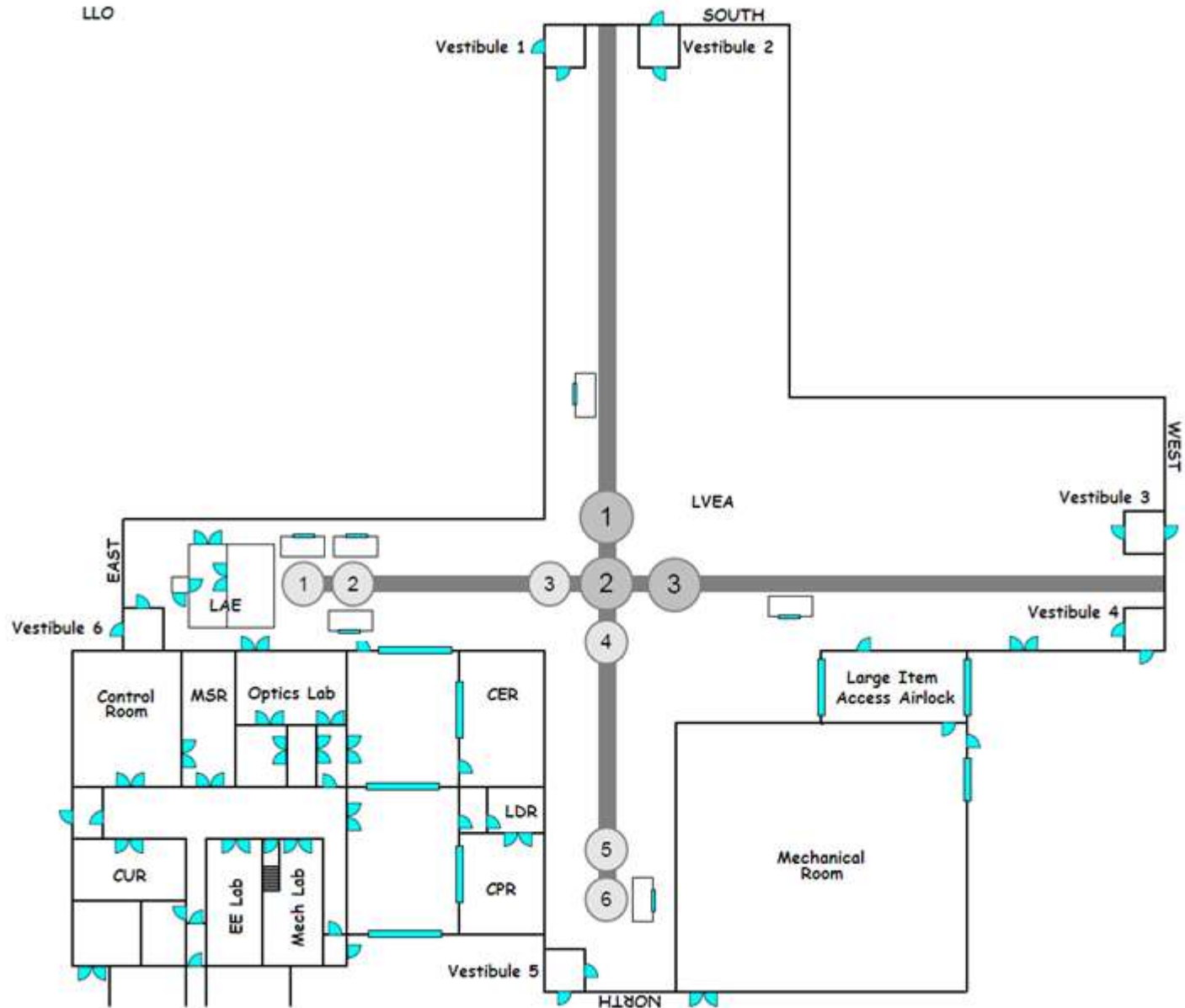

PSL / LDR Laser Hazard Zones

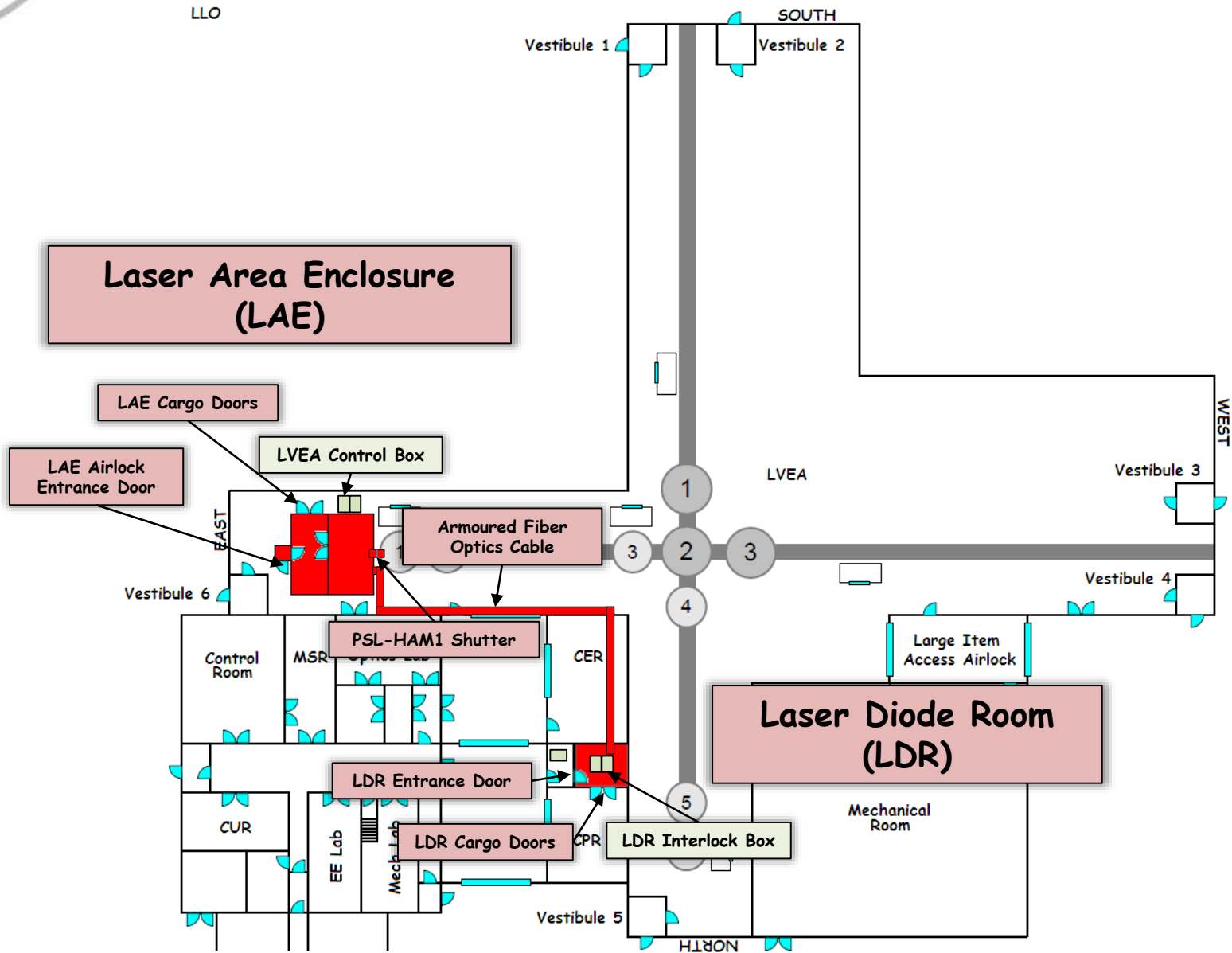

<< LLO Corner Station

18 Field Racks are in the LVEA, including the Vacuum Racks.
See [D1003141](#)) at LLO and [D1002704](#) at LHO.

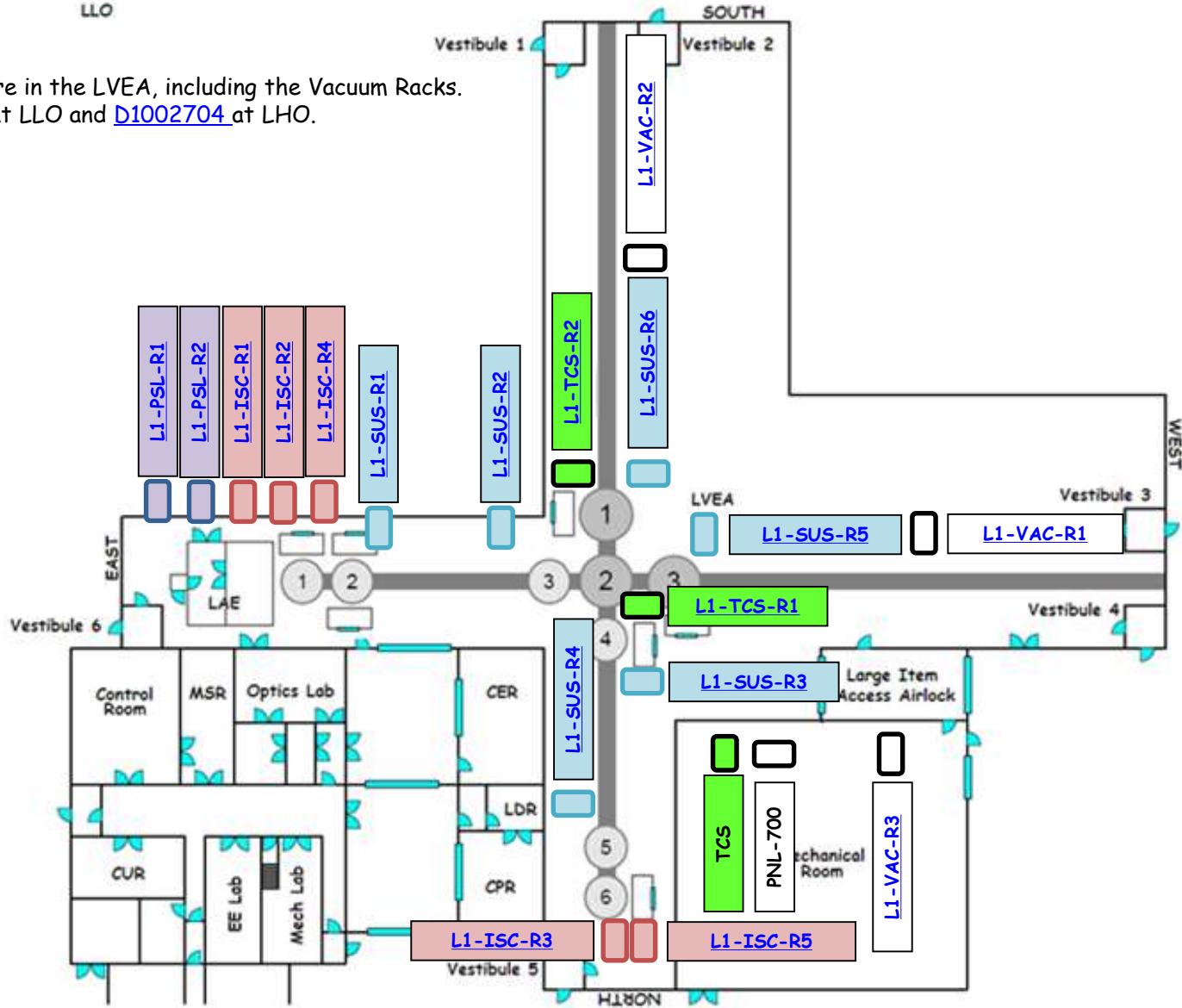

[<< LLO Racks by AREA](#)

[<< LLO Racks by Subsystems](#)

PSL Rack 1 (L1-PSL-R1)	ISC IMC/ALS Rack (L1-ISC-R1)	SUS HAM2 Rack (L1-SUS-R1)	TCS X Rack (L1-TCS-R1)	LVEA X-ARM VAC (L1-VAC-R1)
PSL Rack 2 (L1-PSL-R2)	ISC HAM1 and HAM3 Rack (L1-ISC-R2)	SUS HAM3 and BSC2 (BS) Rack (L1-SUS-R2)	TCS Y Rack (L1-TCS-R2)	LVEA Y-ARM VAC (L1-VAC-R2)
	ISC HAM6 Rack (L1-ISC-R3)	SUS HAM4 Rack (L1-SUS-R3)	TCS Chillers Rack (L1-TCS-M1)	LVEA Mech VAC (L1-VAC-R3)
	ISC HAM1 and HAM3 Racks (L1-ISC-R4)	SUS HAM5 Rack (L1-SUS-R4)		Vacuum ION PUMP Controllers (L1-PNL-600)
	ISC HAM6 Rack (L1-ISC-R5)	SUS BSC3 (ITMX and FMX) Rack (L1-SUS-R5)		
		SUS BSC1 (ITMY and FMY) Rack (L1-SUS-R6)		

<< LLO Corner Station

18 Field Racks are in the LVEA, including the Vacuum Racks.
See [D1003141](#)) at LLO and [D1002704](#) at LHO.

Tables are named in [E1200808](#).

Tables Patch Panels are listed in [E1200613](#).

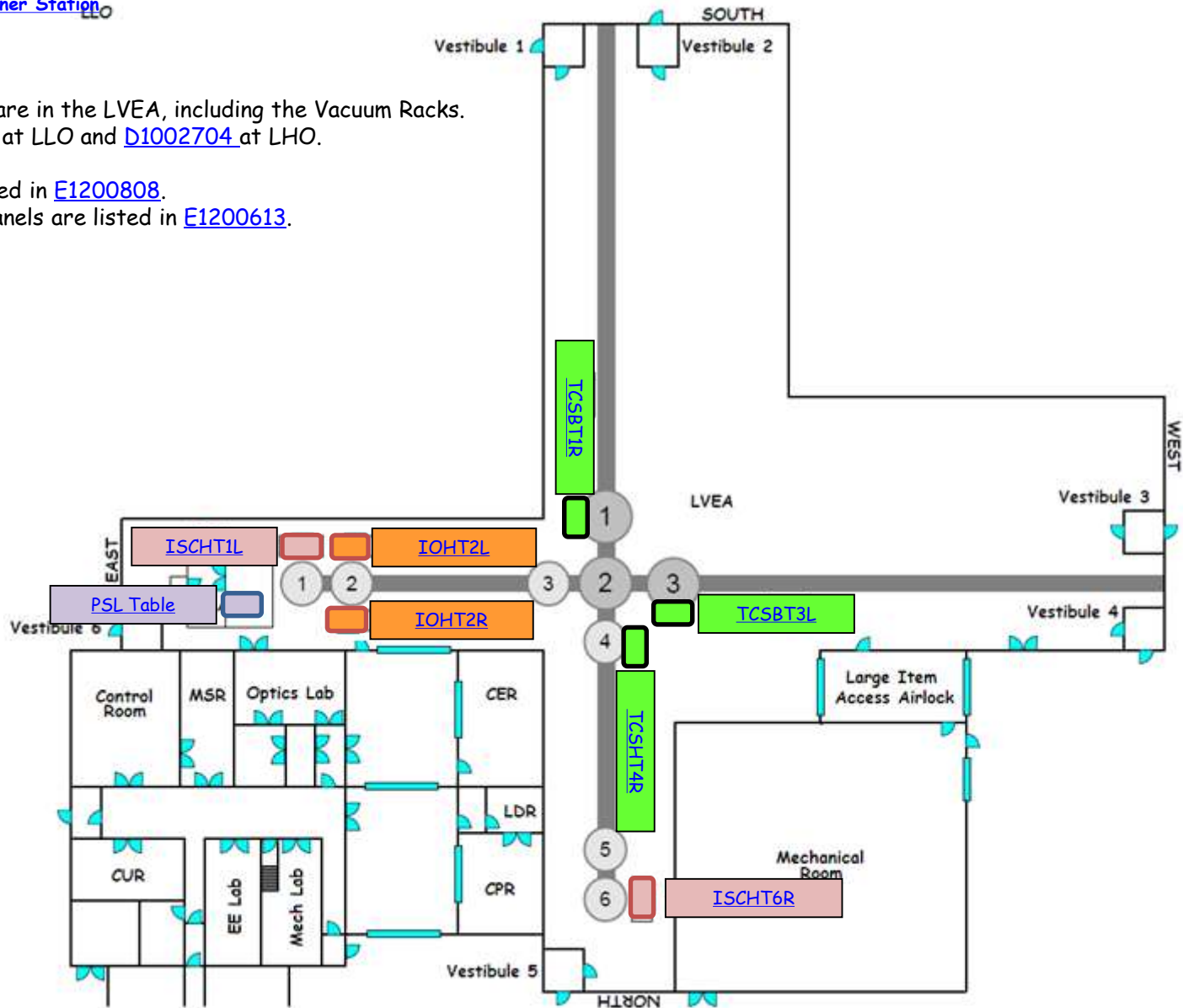

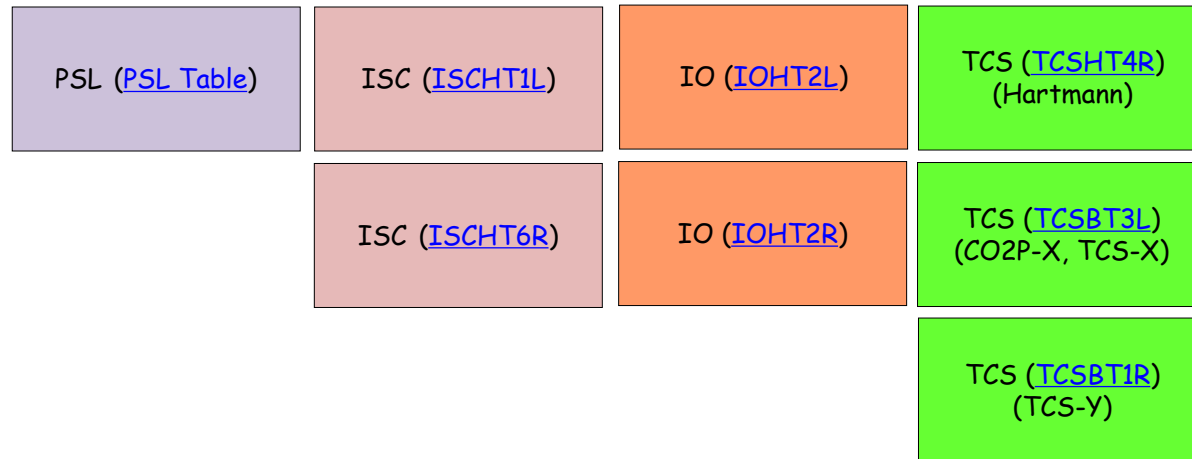

3' X 5' Table Layout ([D1200973](#))

4' X 8' Table Layout ([D1201022](#))

[ISS, TTFSS, and VCO VME Crate](#)

[Delay Line Phase Shifter](#)
[PSL CCD Breakout Panel](#)
[Delay Line Phase Shifter](#)

Solid Shelf

[ILS and PMC VME Crate](#)

[PSL VCO Amplifier](#)

Innolight Laser (Spare 2)

[PSL Control Box](#)

Digi-pak 270 Physical Electronics
 Power Supply

[UPS1](#)

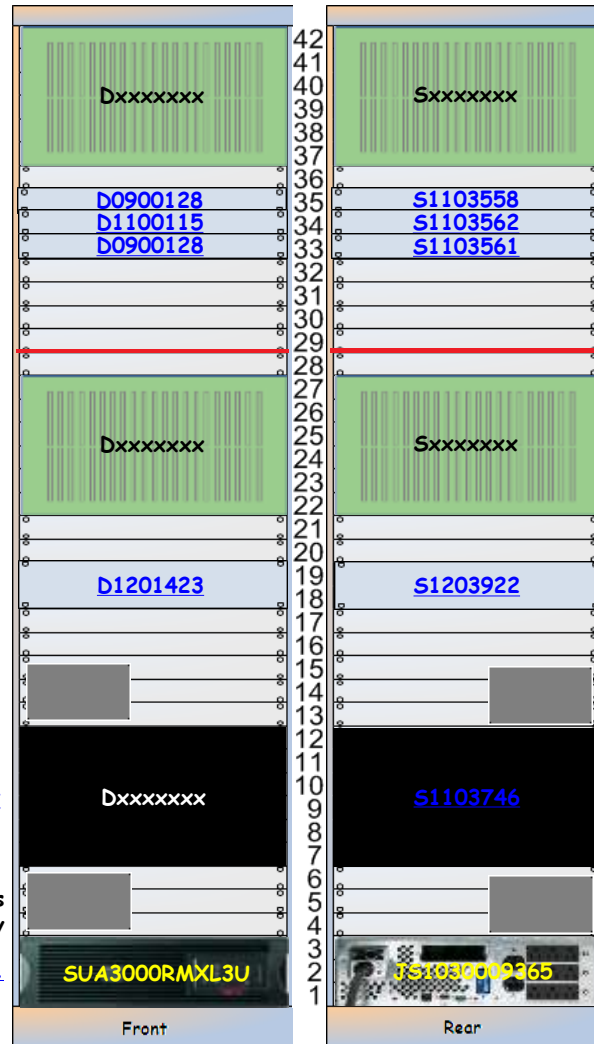

L1-PSL-R1 Details

ISS, TTFSS, and VCO VME Crate

<< L1-PSL-R1

ISS, TTFSS, and VCO VME Crate

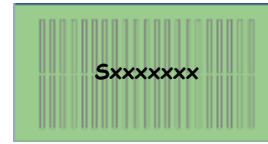

+24VDC

S1103556

S1300304

Sxxxxxxx

S1103554

Sxxxxxxx

VME Crate

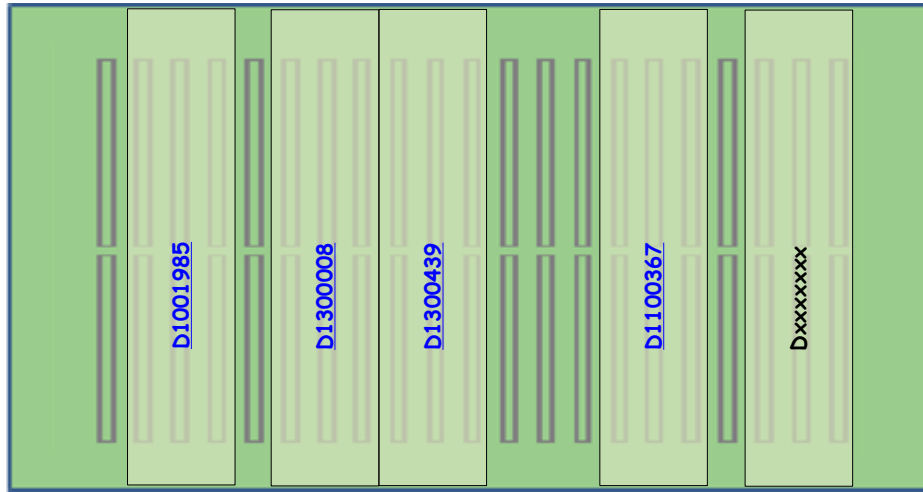

VME Crate
Front

Intensity Stabilization Servo (ISS) Module

PSL IO Field Box

ISS Second Loop Servo

TTFSS Field Box

FSS Heater Field Box

[<< ISS, TTFSS, and VCO VME Crate](#)

Intensity Stabilization
Servo (ISS) Module

[D1001985](#)

[S1103556](#)

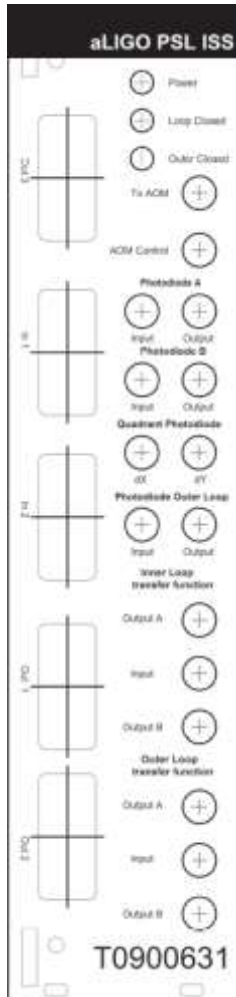

See also Txxxxxxx

[<< ISS, TTFSS, and VCO VME Crate](#)

PSL IO Field Box

[D1300008](#)

[S1300304](#)

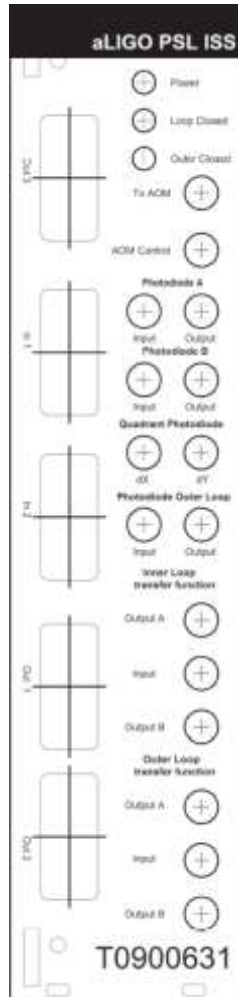

See also Txxxxxxx

[<< ISS, TTFSS, and VCO VME Crate](#)

ISS Second Loop Servo

[D1300439](#)

Sxxxxxxx

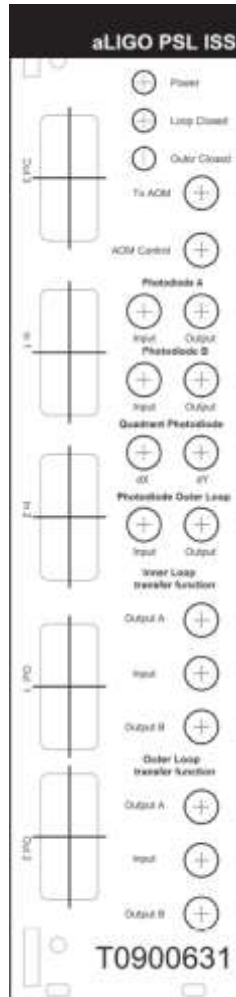

See also Txxxxxxx

<< [ISS, TTFSS, and VCO VME Crate](#)

TTFSS Field Box

[D1100367](#)

[S1103554](#)

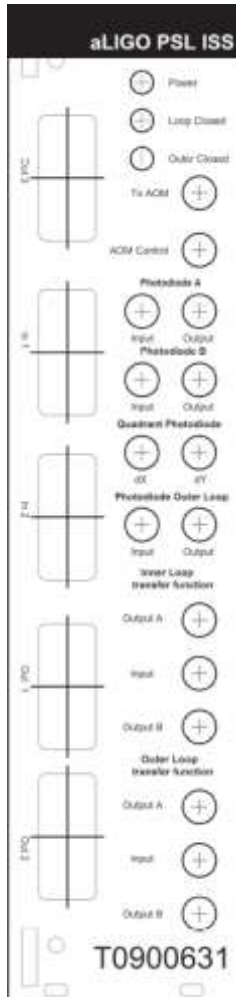

See also Txxxxxxx

<< [ISS, TTFSS, and VCO VME Crate](#)

FSS Heater Field Box

Dxxxxxxx

Sxxxxxxx

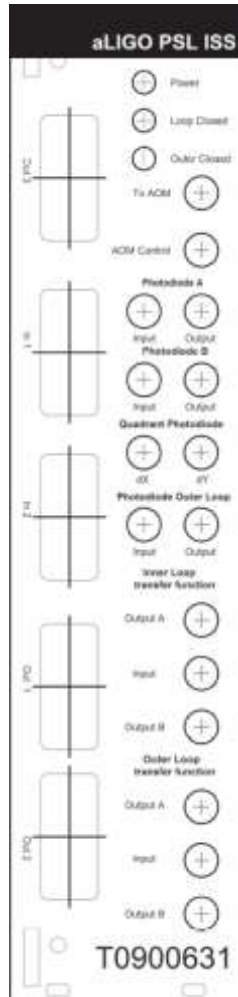

See also Txxxxxxx

D0900128 - S1103558



<< L1-PSL-R1

Delay Line Phase Shifter +15VDC



D0900128

Front



S1103558

Rear

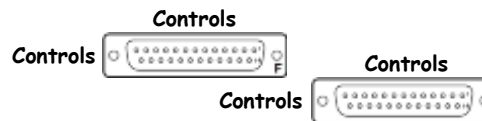

<< L1-PSL-R1

PSL CCD Breakout Panel D1100115 S1103562 ±12VDC

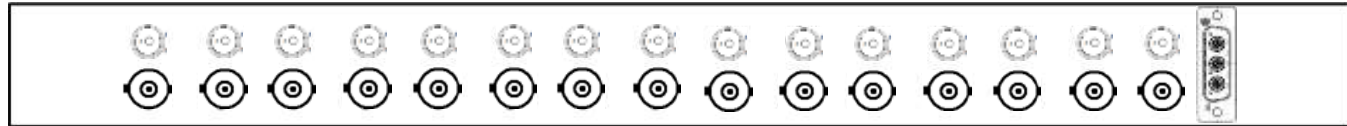

D1100115

Front

±12VDC

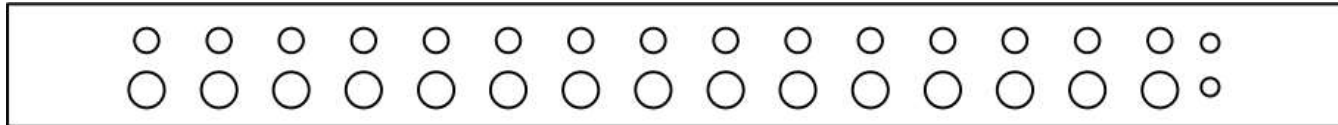

S1103562

Rear

<< L1-PSL-R1

Delay Line Phase Shifter +15VDC



D0900128

Front



S1103561

Rear

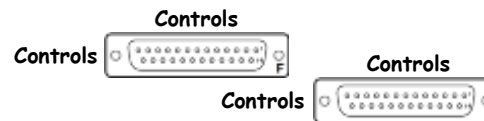

ILS and PMC VME Crate

<< [L1-PSL-R1](#)

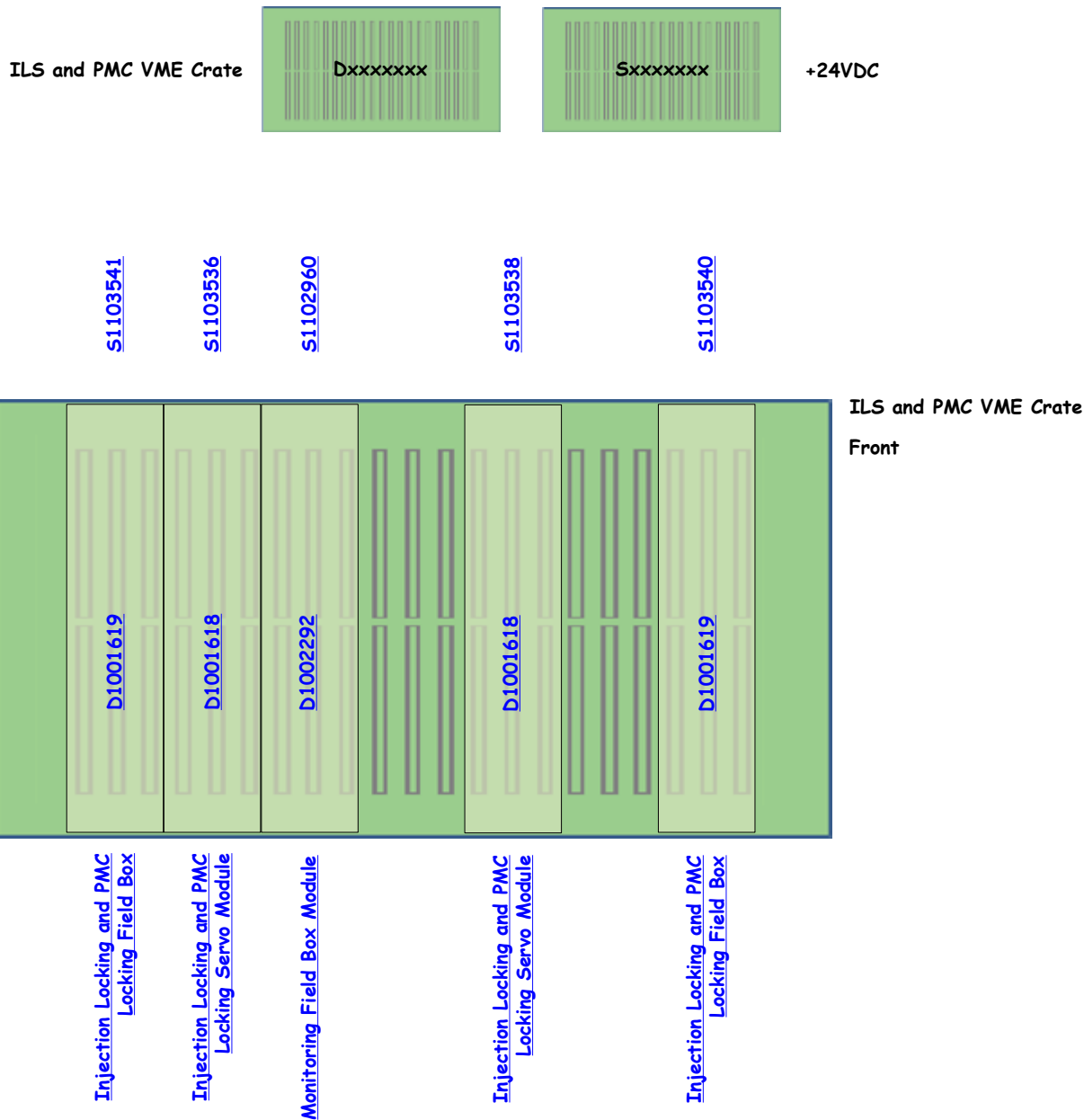

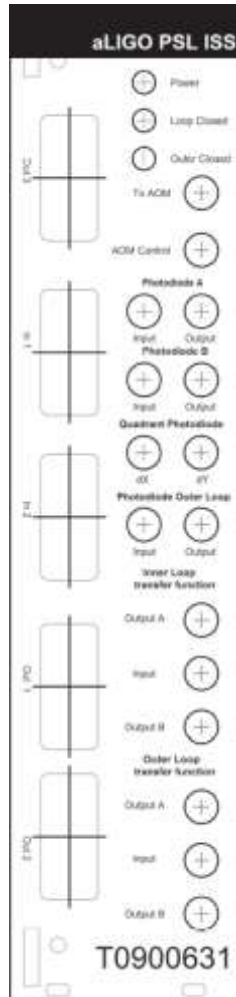
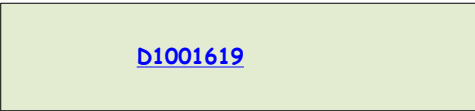

See also Txxxxxxx

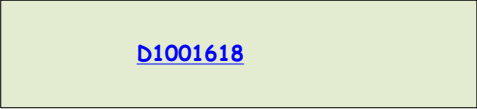

[D1001618](#)

[S1103536](#)

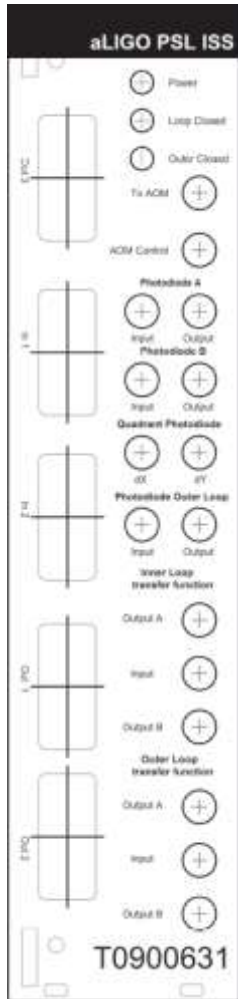

See also Txxxxxxx

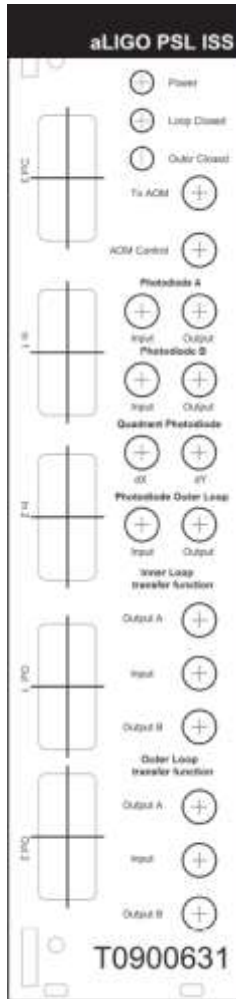
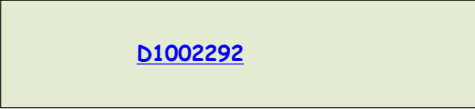

See also Txxxxxxx

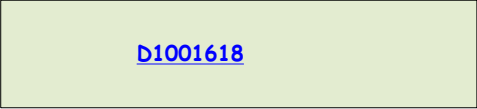

[D1001618](#)

[S1103538](#)

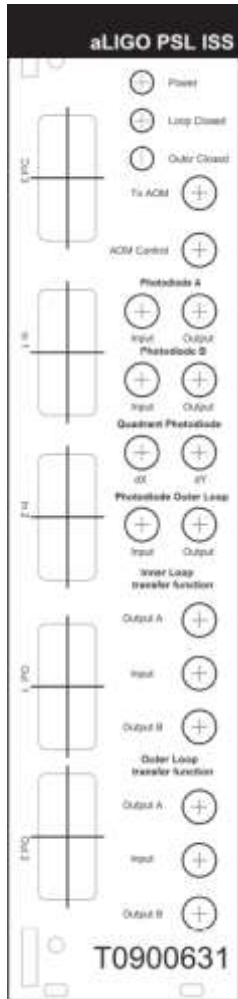

See also Txxxxxxx

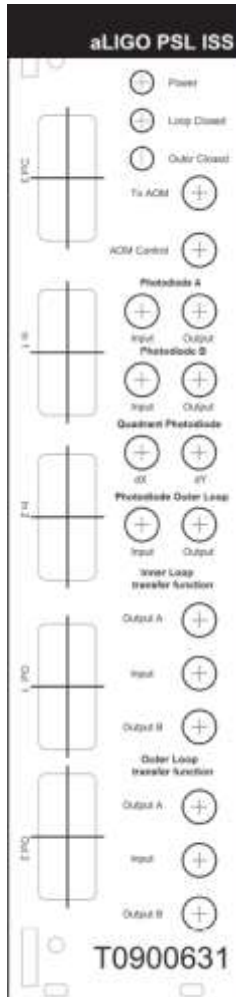

See also Txxxxxxx

<< L1-PSL-R1

PSL VCO Amplifier

[D1201423](#)

[S1203922](#)

Power

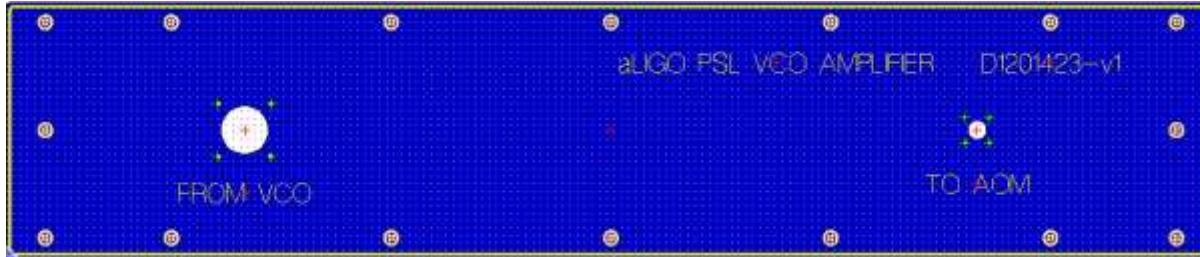

[D1201423](#)

Front



[S1203922](#)

Rear

[<< L1-PSL-R1](#)

PSL Control Box

Dxxxxxxx

[S1103746](#)

+24VDC

PSL Control Box

[S1103746](#)

Front

SUA3000RMXL3U - JS1030009365 UPS

<< L1-PSL-R1

UPS1

SUA3000RMXL3U

JS1030009365

120VAC, 30A



NEMA L5-30P

Camera Power Supplies ...

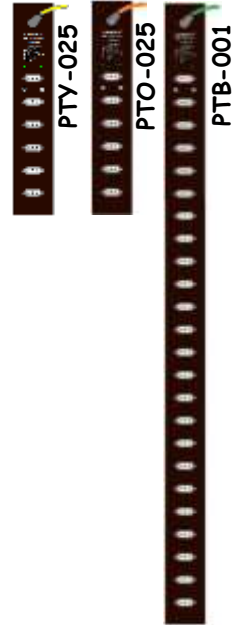
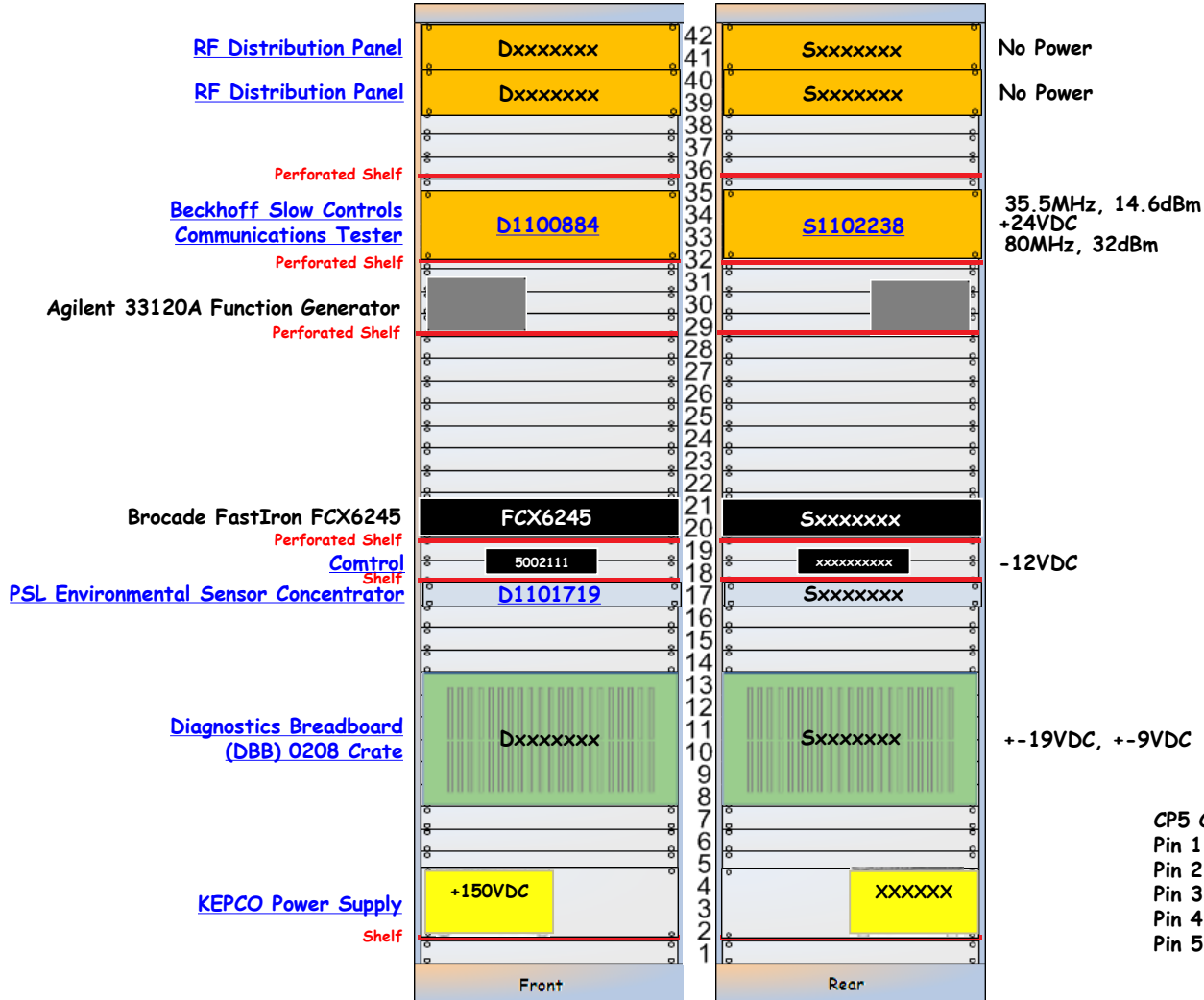

CP5 Connector:
Pin 1: -19VDC
Pin 2: -9VDC
Pin 3: Ground
Pin 4: +9VDC
Pin 5: +19VDC

RF Distribution Panel

<< L1-PSL-R2

RF Distribution Panel

Dxxxxxxx

Sxxxxxxx

No Power

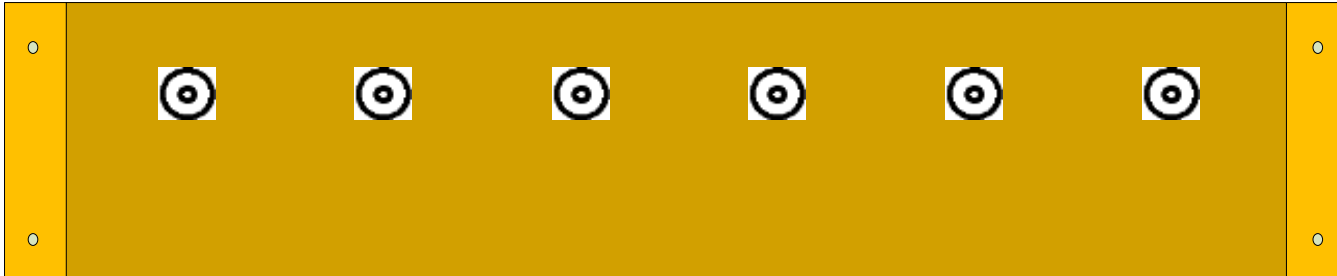

Dxxxxxxx

Front

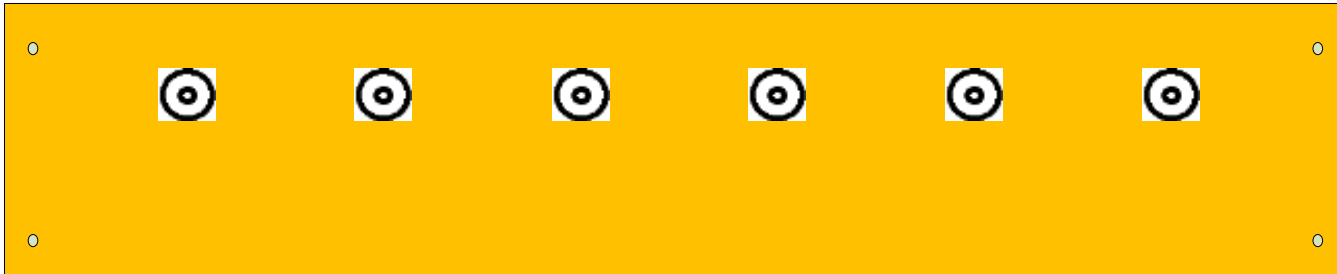

Sxxxxxxx

Rear

RF Distribution Panel

<< L1-PSL-R2

RF Distribution Panel

Dxxxxxxx

Sxxxxxxx

No Power

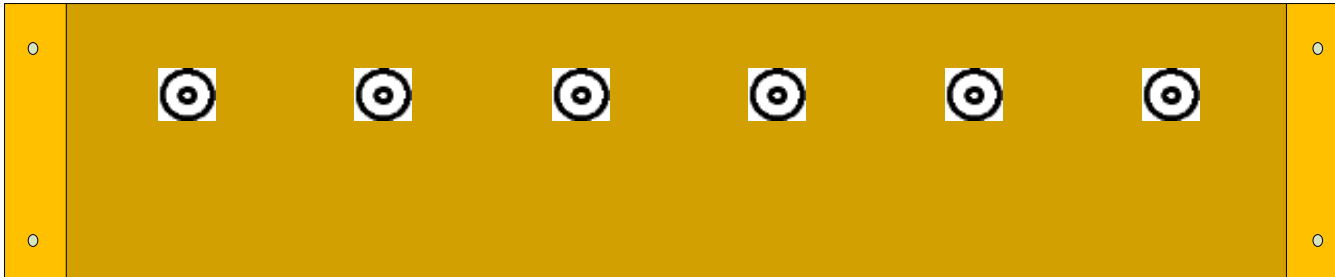

Dxxxxxxx

Front

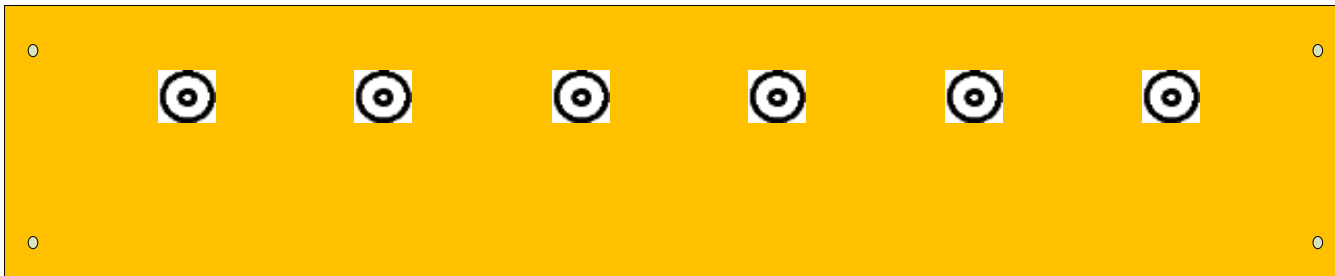

Sxxxxxxx

Rear

<< L1-PSL-R2

Beckhoff Slow Controls
Communications Tester

[D1100884](#)

[S1102238](#)

+24VDC



[D1100884](#)

Front: [D1100890](#)

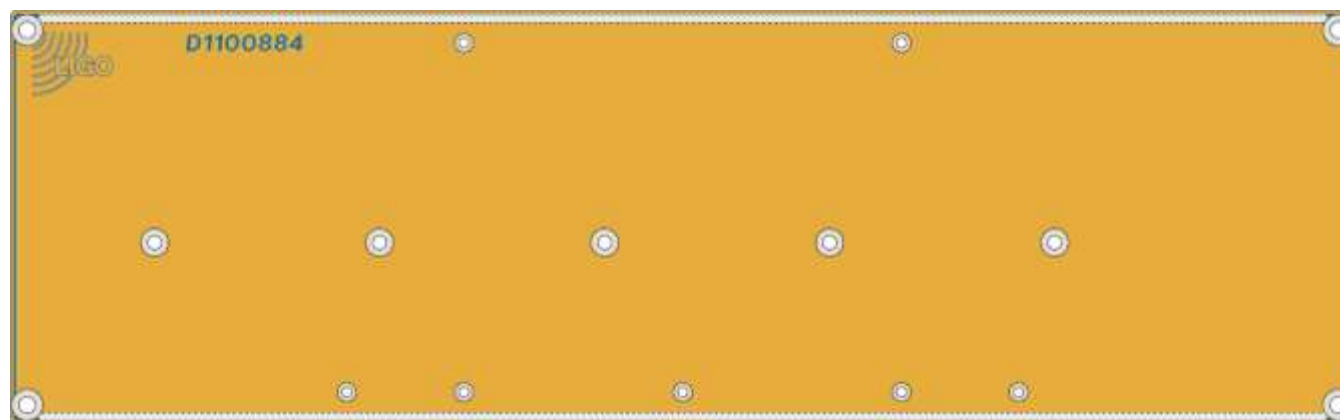

[S1102238](#)

Rear: [D1100891](#)

D1101719 - Sxxxxxxx

<< [L1-PSL-R2](#)

PSL Environmental Sensor Concentrator

[D1101719](#)

Sxxxxxxx

±18VDC



[D1101719](#)

Front



Sxxxxxxx

Rear ([D1101728](#))

Control DeviceMaster 4 with DB9 Ports

MAC Address:
00-C0-4E-07-3F-5D

IP Address:
10/110.60.??

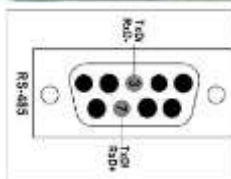

4-Port Power Supply

This table provides the specifications for the power supply shipped with the DeviceMaster 4-port.

Control Power Supply: 4-Port	
Input line frequency	47 - 63 Hz
Input line voltage	90 - 260 VAC
Output voltage	24VDC
Output current	500 mA @ 24VDC

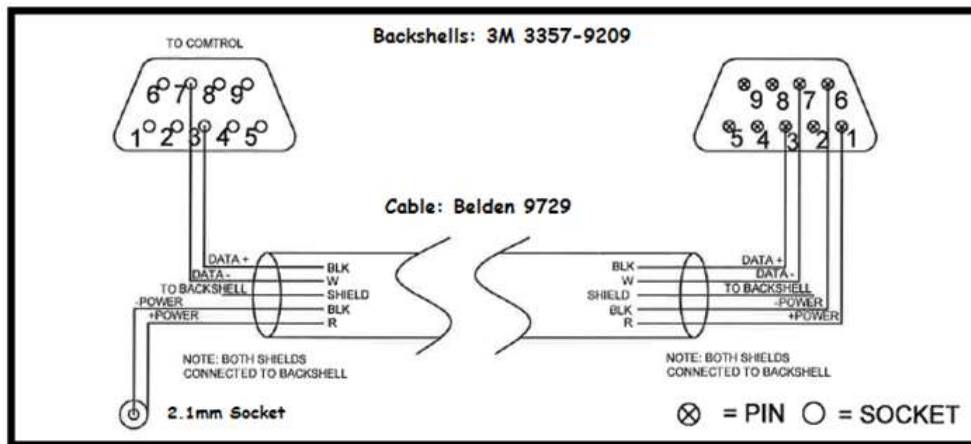
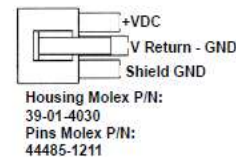

3M Shell 3357-9209

3M Shell 3357-9209



2.1mm Socket
(Note polarity)

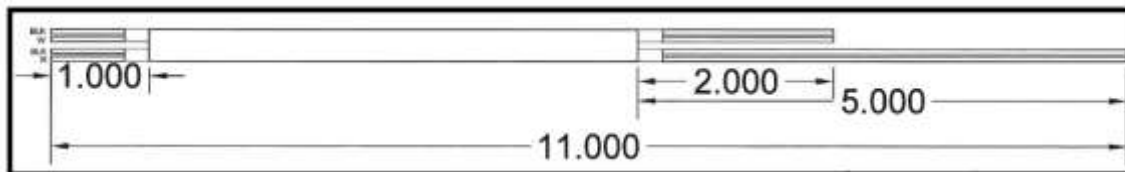

2.1mm Plug
(Note polarity)

Diagnostics Breadboard (DBB) 0208 Crate

<< L1-PSL-R2

Diagnostics Breadboard
(DBB) VME Crate

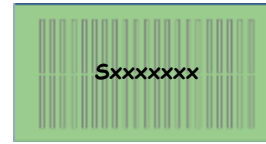

+24VDC

[S1103545](#)

[S1103546](#)

[S1103548](#)

[S1103550](#)

[S1103551](#)

Diagnostics Breadboard
(DBB) VME Crate

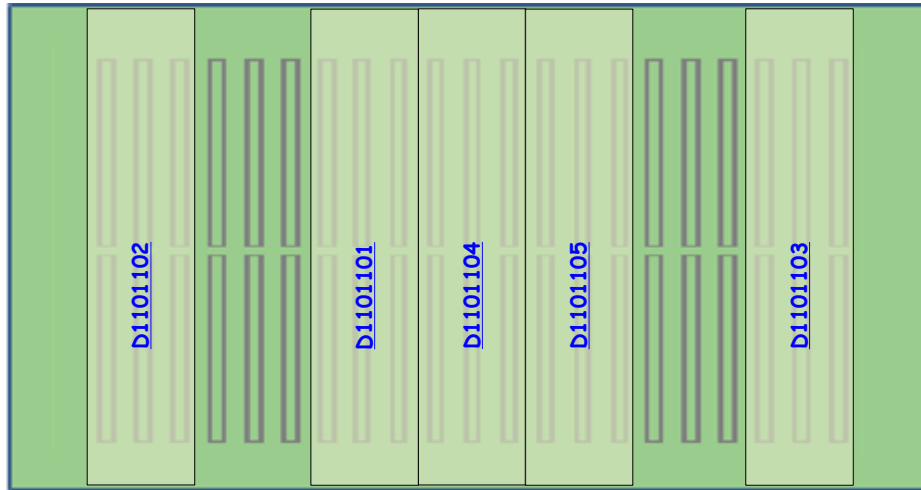

Diagnostics Breadboard
(DBB) VME Crate
Front

PSL Diagnostics Breadboard
High Voltage Module

PSL Diagnostics Breadboard
Field Box

PSL Diagnostics Breadboard
Demodulator Module

PSL Diagnostics Breadboard
Miscellaneous Module

PSL Diagnostics Breadboard
Calibration Module

[<< Diagnostics Breadboard \(DBB\) VME Crate](#)

PSL Diagnostics Breadboard
High Voltage Module

[D1101102](#)

[S1103545](#)

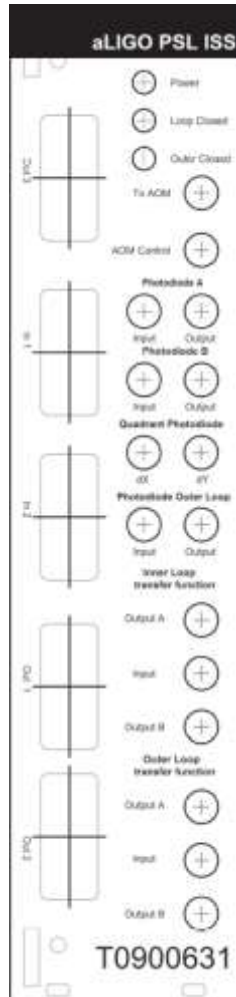

[See also T0900631](#)

[<< Diagnostics Breadboard \(DBB\) VME Crate](#)

PSL Diagnostics Breadboard
Field Box

[D1101101](#)

[S1103546](#)

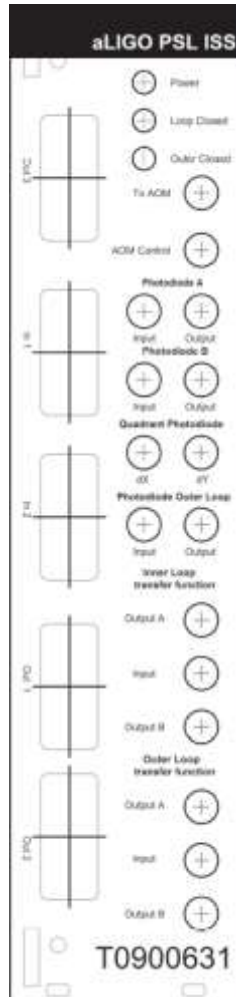

[See also T0900631](#)

<< [Diagnostics Breadboard \(DBB\) VME Crate](#)

PSL Diagnostics Breadboard
Demodulator Module

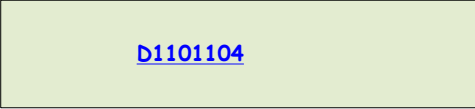

[D1101104](#)

[S1103548](#)

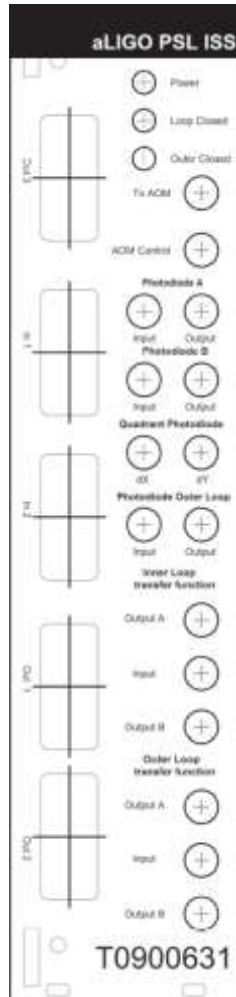

See also [T0900631](#)

[<< Diagnostics Breadboard \(DBB\) VME Crate](#)

PSL Diagnostics Breadboard
Miscellaneous Module

[D1101105](#)

[S1103550](#)

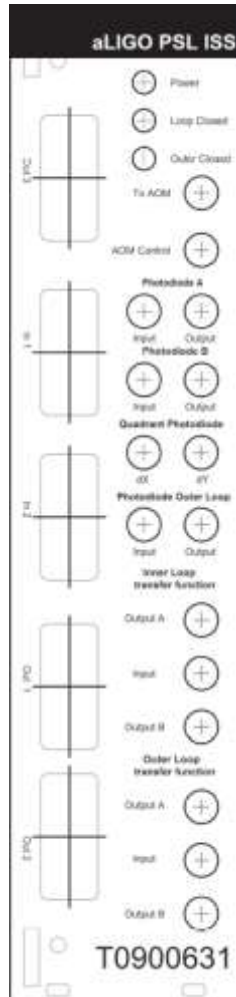

See also [T0900631](#)

<< [Diagnostics Breadboard \(DBB\) VME Crate](#)

PSL Diagnostics Breadboard
Calibration Module

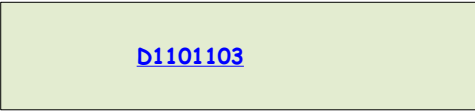

[D1101103](#)

[S1103551](#)

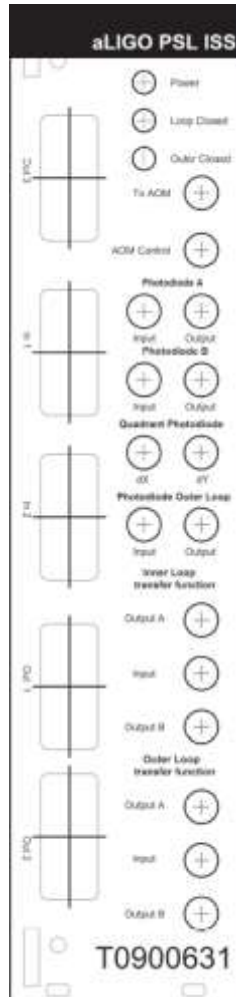

See also [T0900631](#)

<< L1-PSL-R2

KEPCO Power Supply



JQE

Front

KEPCO JQE 150-1.5
+150VDC

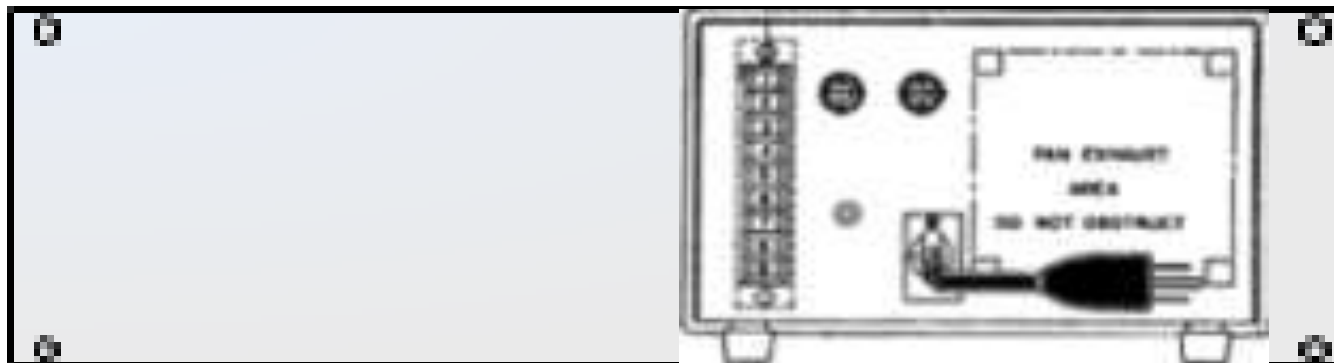

Rear

KEPCO JQE 150-1.5
Hxxxxx

BSC1 Chamber Elements (ITMY)

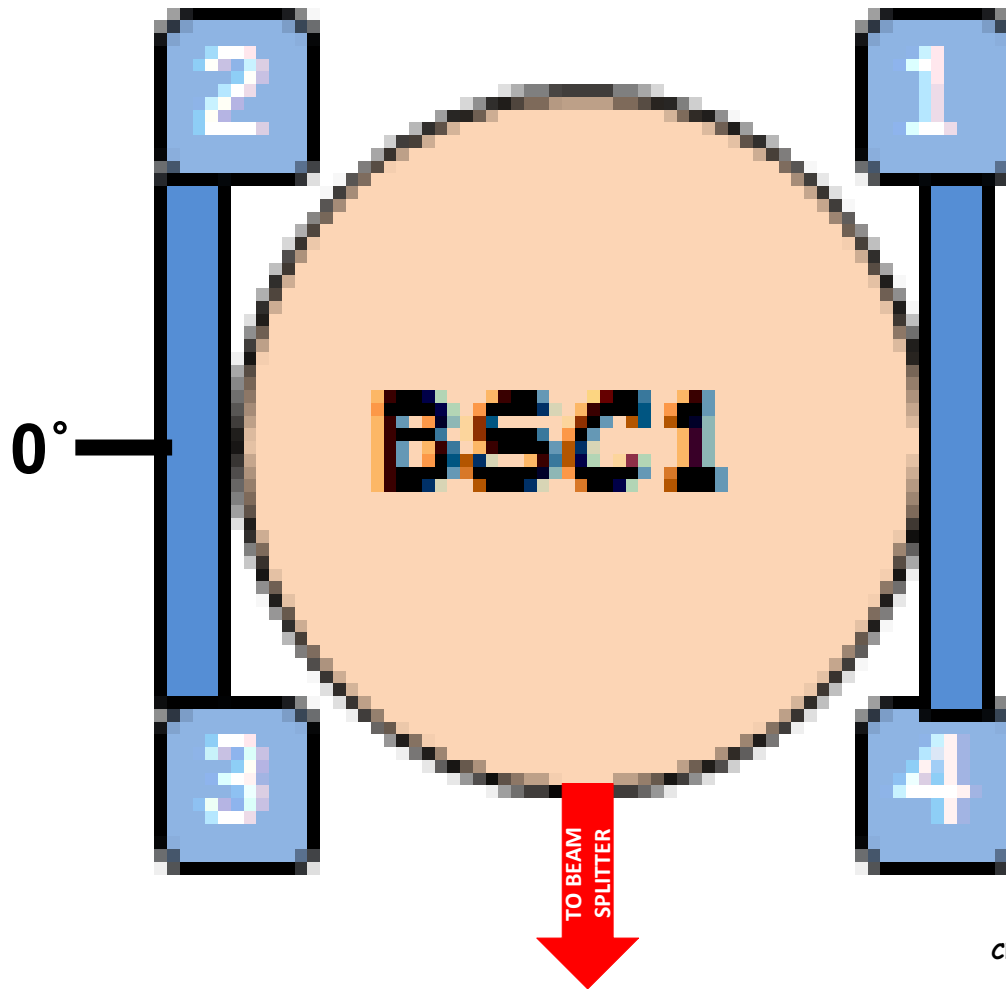

BSC1 Mid-size ION Pump	75IP-BSC1
BSC1 Turbo Pump	75IP-BSC1
BSC1 Scroll Pump	75IP-BSC1

BSC1 Annulus ION Pump	75IP-BSC1
BSC1 Parani Gauge	75IPBSC1
BSC1 Cold Cathode	75IPBSC1

BSC1 Top Level Chamber Assembly	D0900442
BSC1 Drawing	D0900443
BSC1 Viewports	T1000746
BSC1 Flanges	D1003088
BSC1 HEPI	75IP-BSC1
BSC1 CPS	75IP-BSC1

BSC1 Annulus Ion Pump

[<< BSC1 Chamber Elements](#)

BSC` Annulus ION Pump

[Controller](#)

MiniVac Controller

Model 929-0196
Model 929-0197



Input/Output Interconnections

All input/output signals are accessible at J001 accessory connector. With the provided P001 mating connector, make the connections with AWG 24 (0.2 mm²) - or smaller wire - to the pins indicated in the following figure to obtain the desired capability.

Input signals

Pin 3-7 Remote high voltage ON/OFF or high voltage interlock; requires a permanent closed pin contact.

NOTE

Pin 3-7 must be shorted to allow the high voltage output if no remote/interlock contact is connected.

Output signals

Pin 1-6 Current recorder output 1 (pin 1 signal out, pin 6 ground). The output voltage 0 to + 10 Vdc is proportional to the pump current 0 to 10 mA (e.g. 10 Vdc correspond to 10 mA). The resolution is 10 mV minimum (corresponding to 10 μ A).

The front panel REC. OUT connector is a duplicate of this signal on a BNC connector.

Pin 2-6 Current recorder output 2 (pin 2 signal out, pin 6 ground). The output voltage 0 to + 10 Vdc is proportional to the pump current 0 to 1 mA (e.g. 10 Vdc correspond to 1 mA). The resolution is 10 mV minimum (corresponding to 1 μ A).

Pin 4-8 Voltage recorder output (pin 4 signal out, pin 8 ground). The output voltage 0 to 5 V is proportional to the controller high voltage output 0 to 5 kV (e.g. 1 V corresponds to 1 kV in linear mode).

Pin 5-9 High voltage indication contact. This pure contact (which carries 1 A at 250 Vac and 0.2 A at 30 Vdc) is open when the high voltage is off and closes when the high voltage is on.

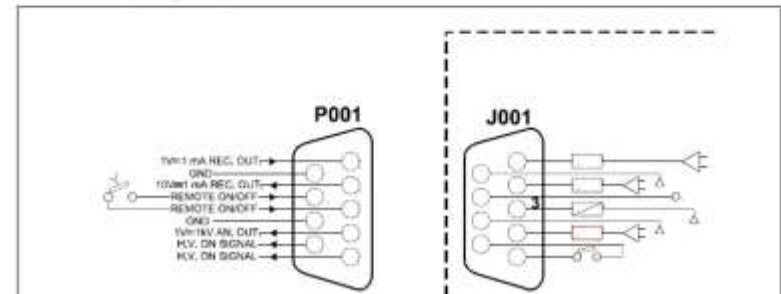

BSC1 Chamber Drawing (ITMY)

[<< BSC1 Chamber Elements](#)

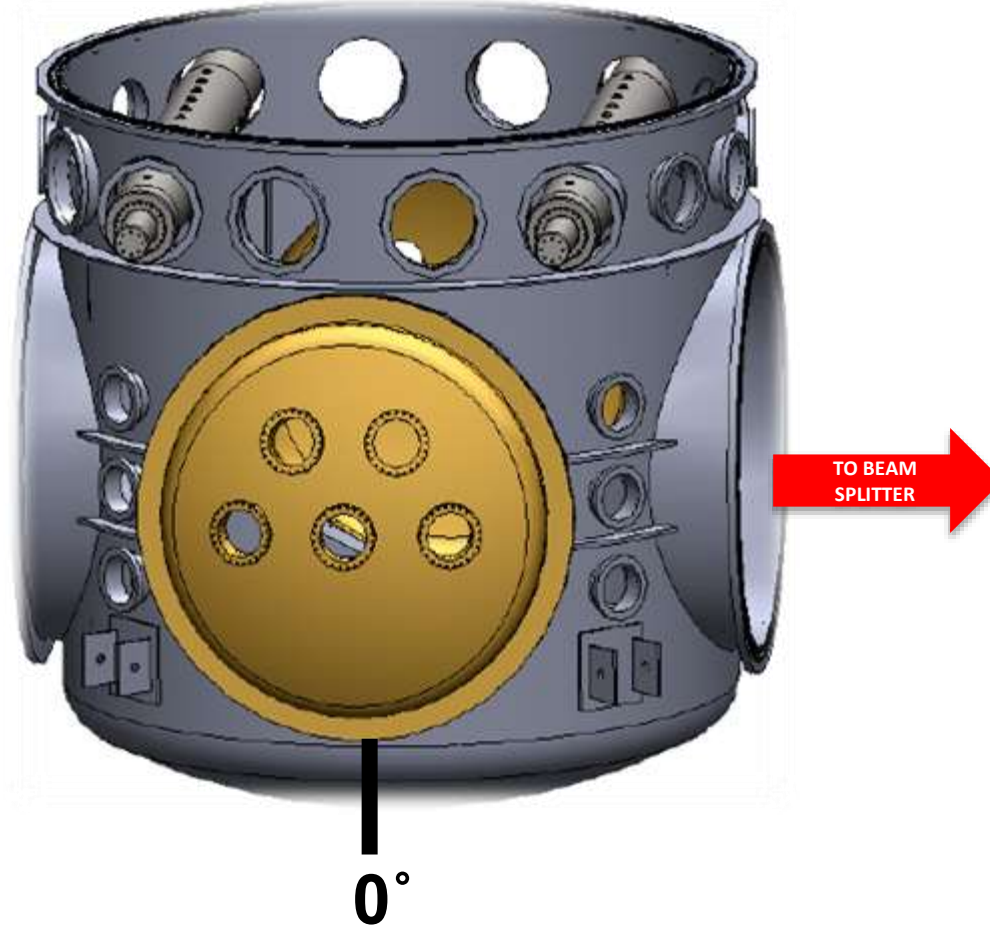

BSC1 Chamber Viewports (ITMY)

<< BSC1 Chamber Elements

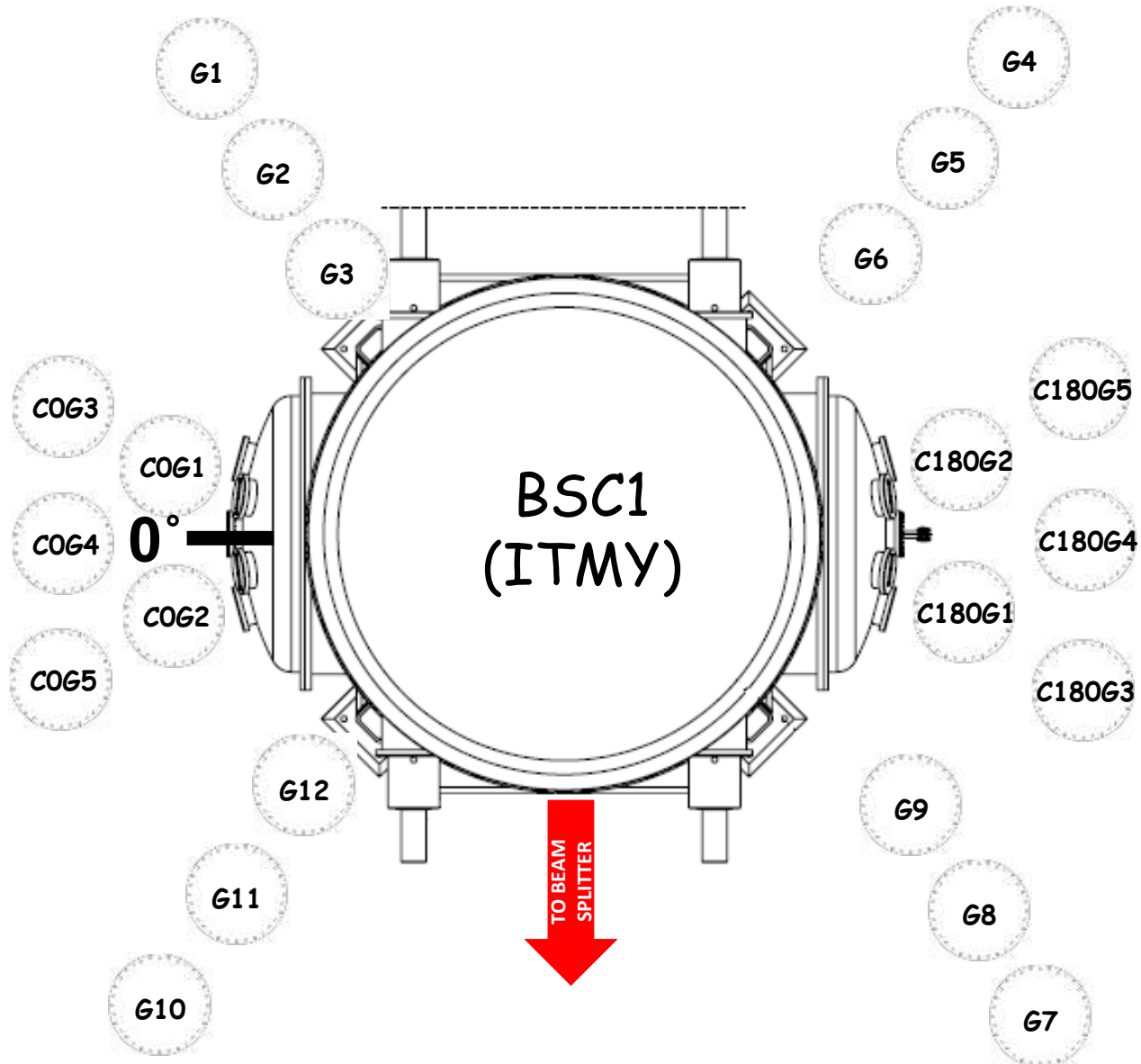

BSC1 Chamber Flanges (ITMY)

<< BSC1 Chamber Elements

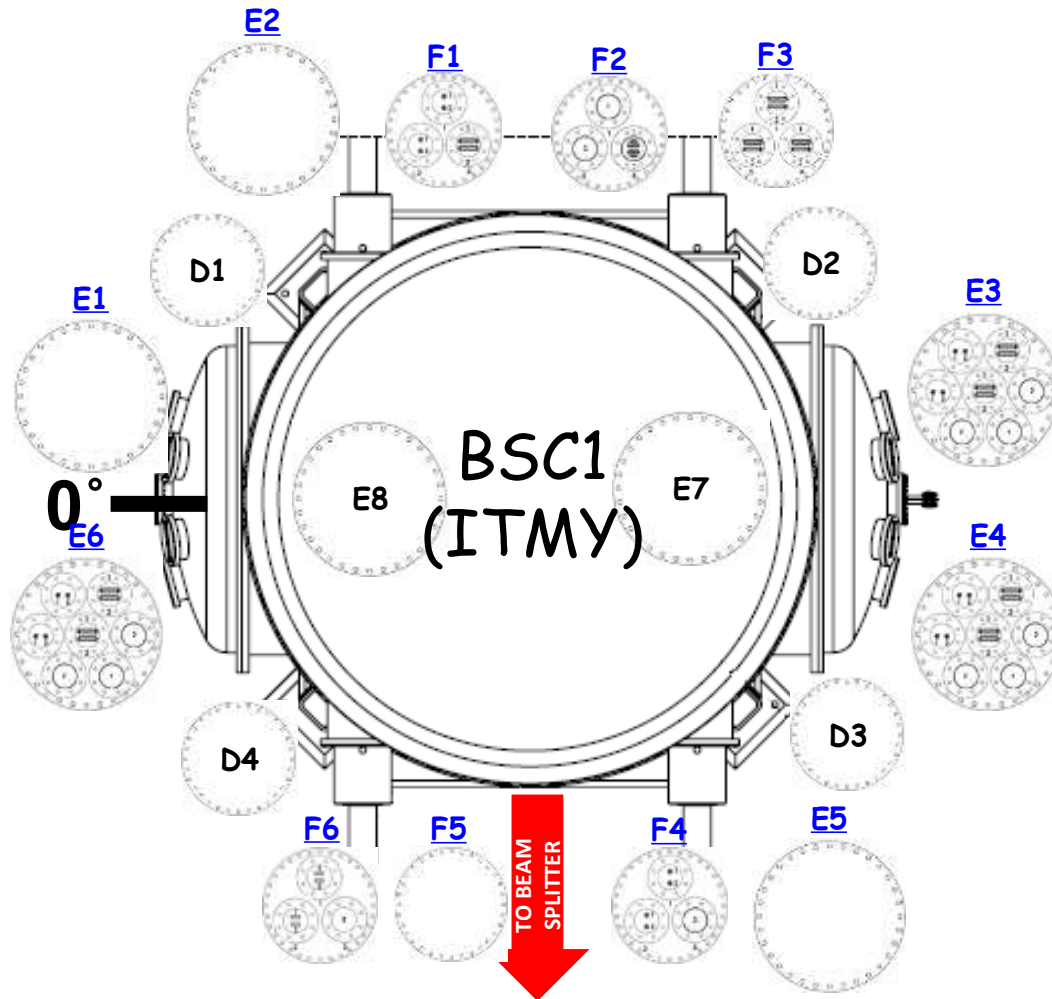

E1

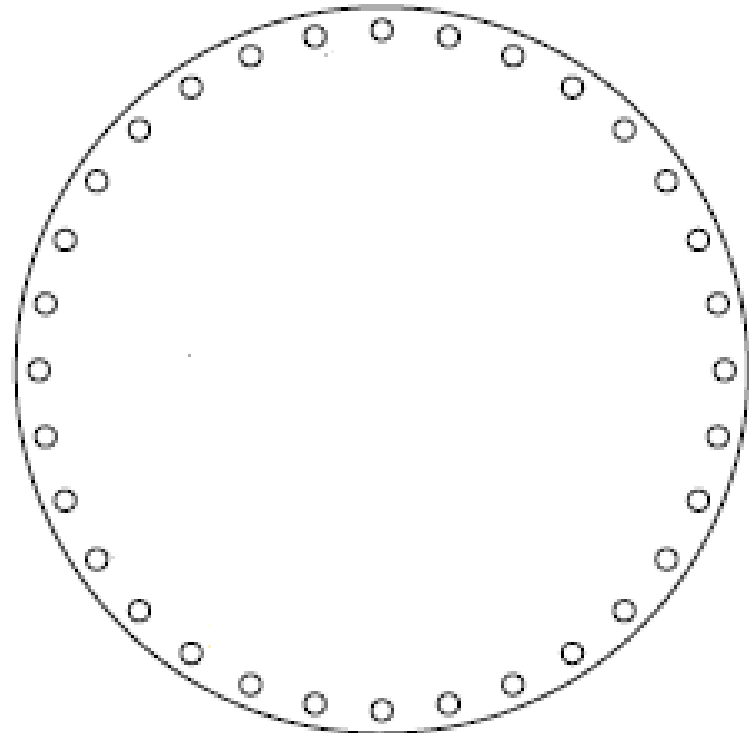

E2

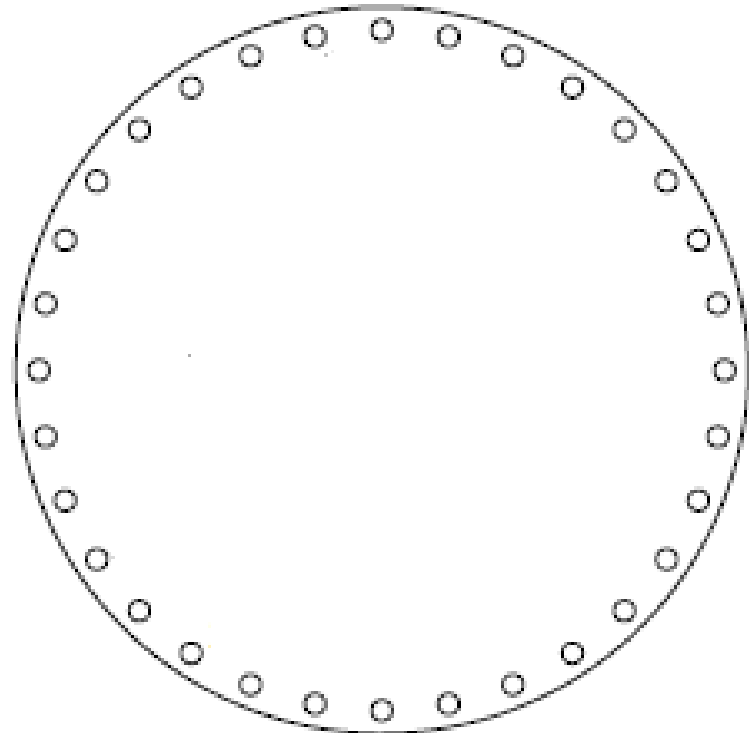

BSC1 Chamber Flange E3

E3

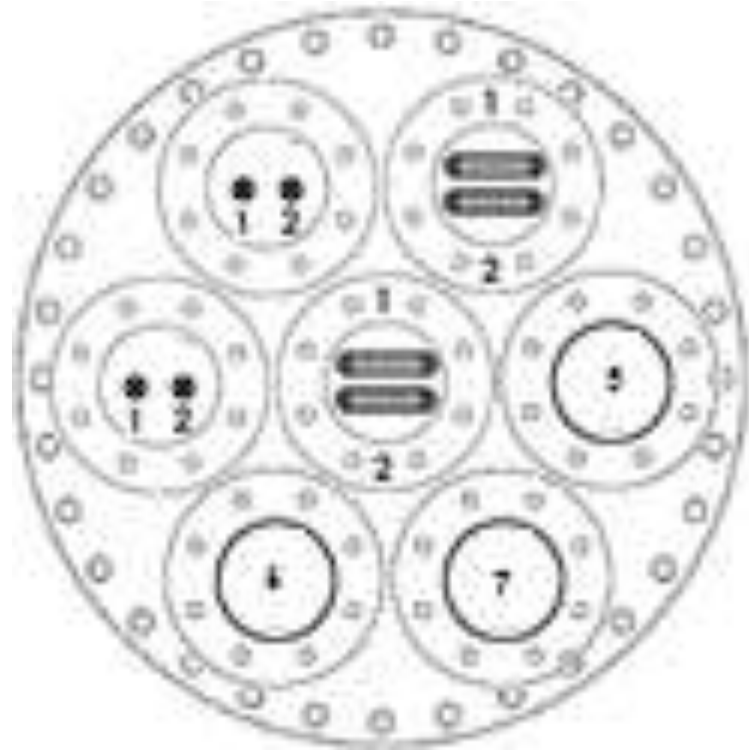

E4

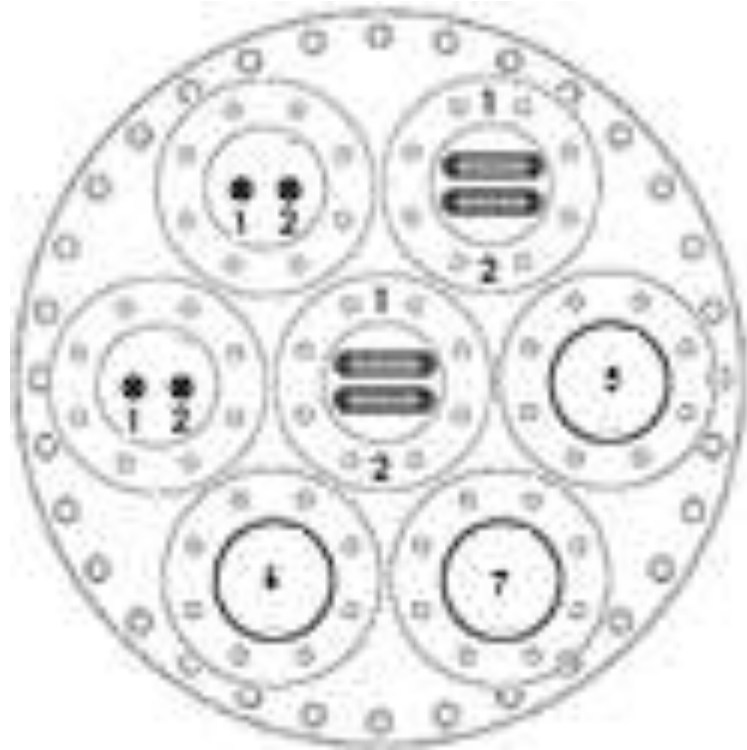

E5

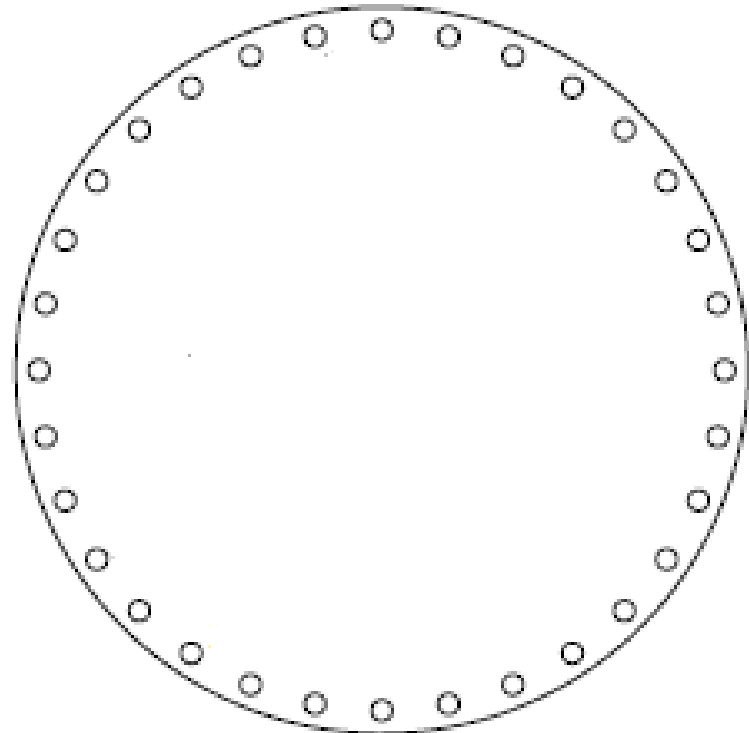

BSC1 Chamber Flange E6

E6

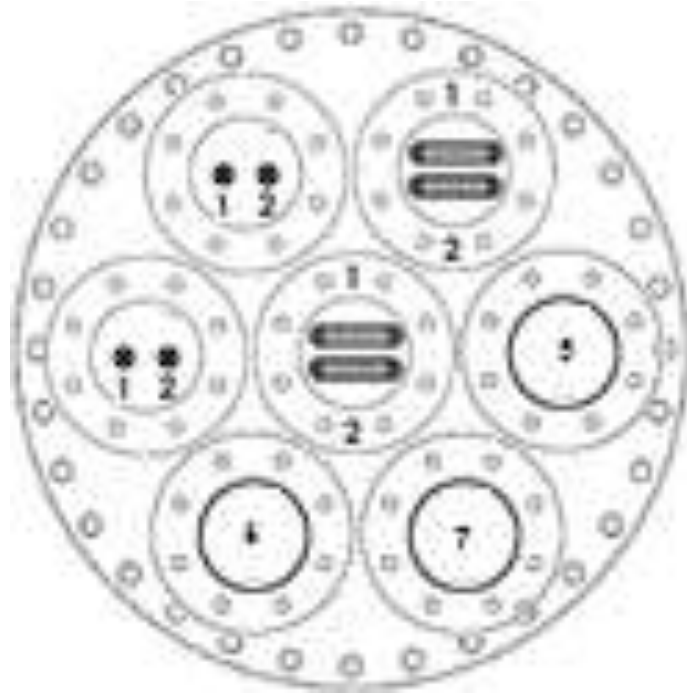

F1

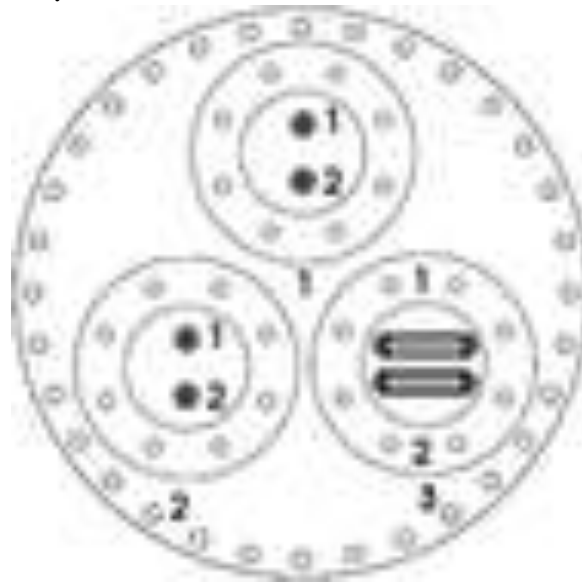

F2

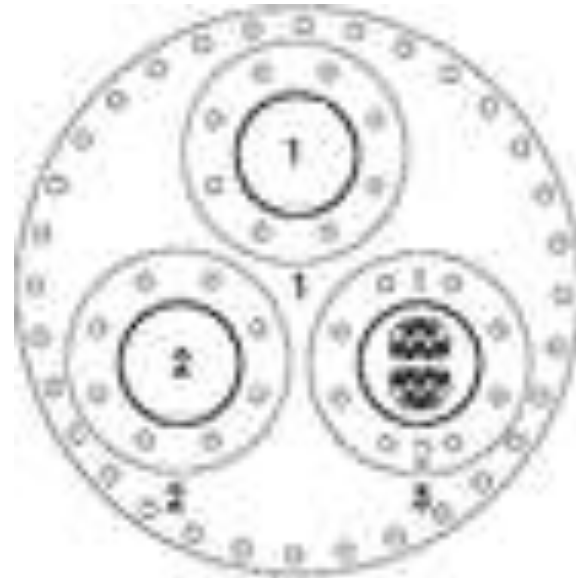

F3

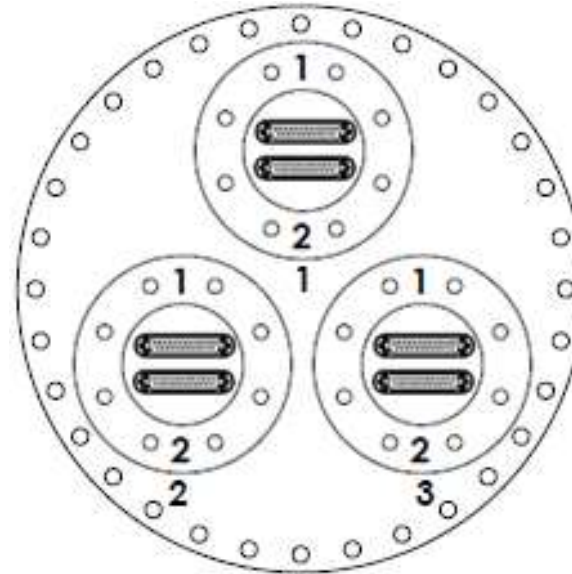

F4

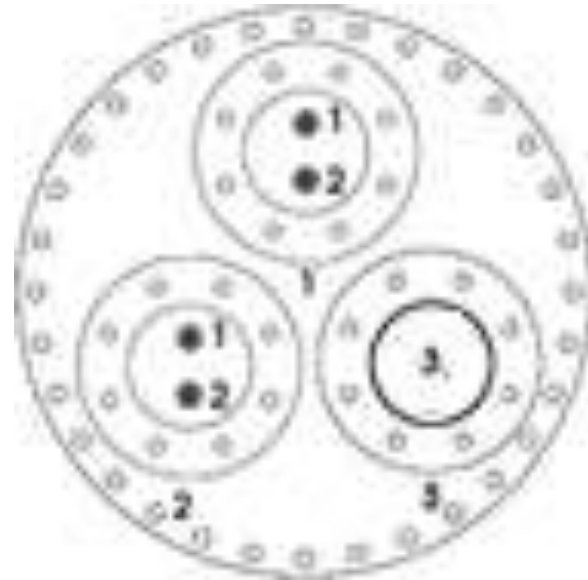



BSC1 Chamber Flange F5

[<< BSC1 Chamber Flanges](#)

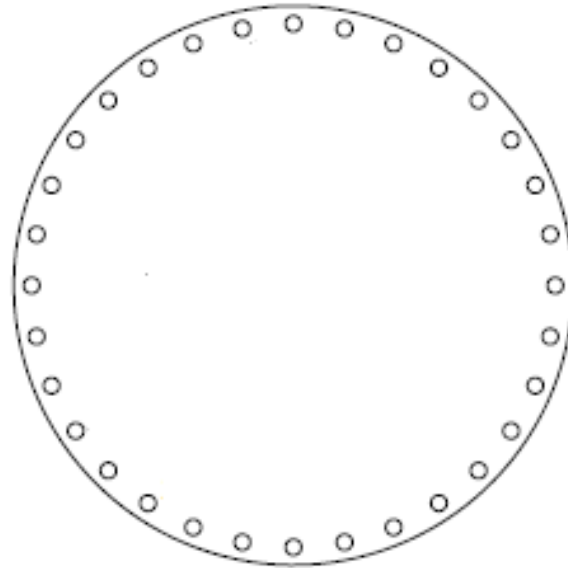
F5

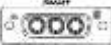
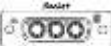
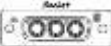

- F6-1-1  F6-1-1
- F6-1-2  F6-1-2
- F6-2-1  F6-2-1
- F6-2-2  F6-2-2

F6

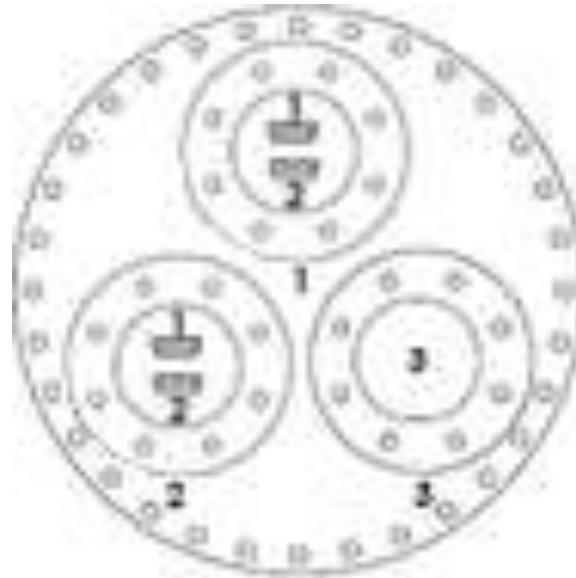

<< BSC1 Chamber Elements

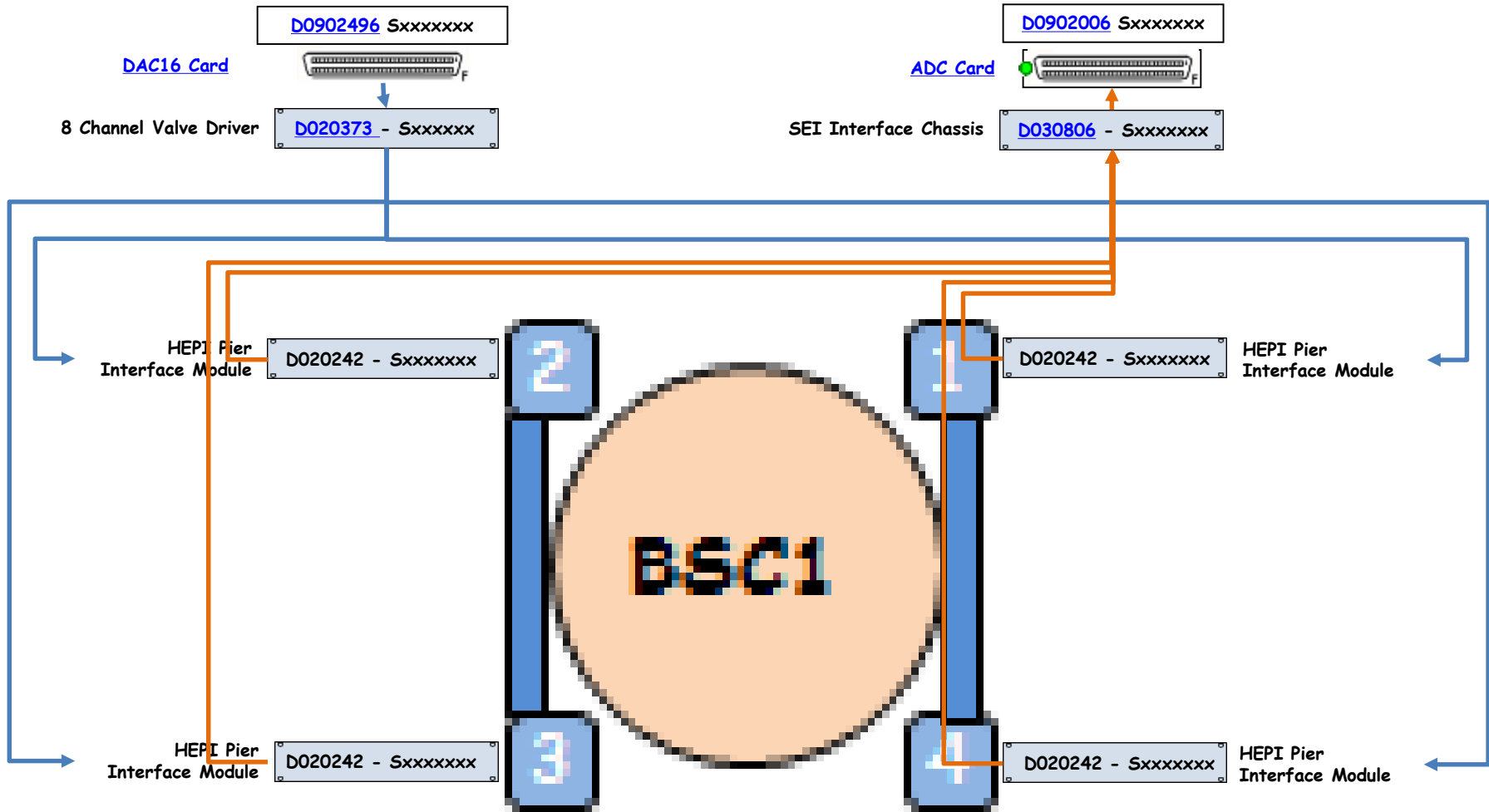

BSC2 Chamber Elements (BS)

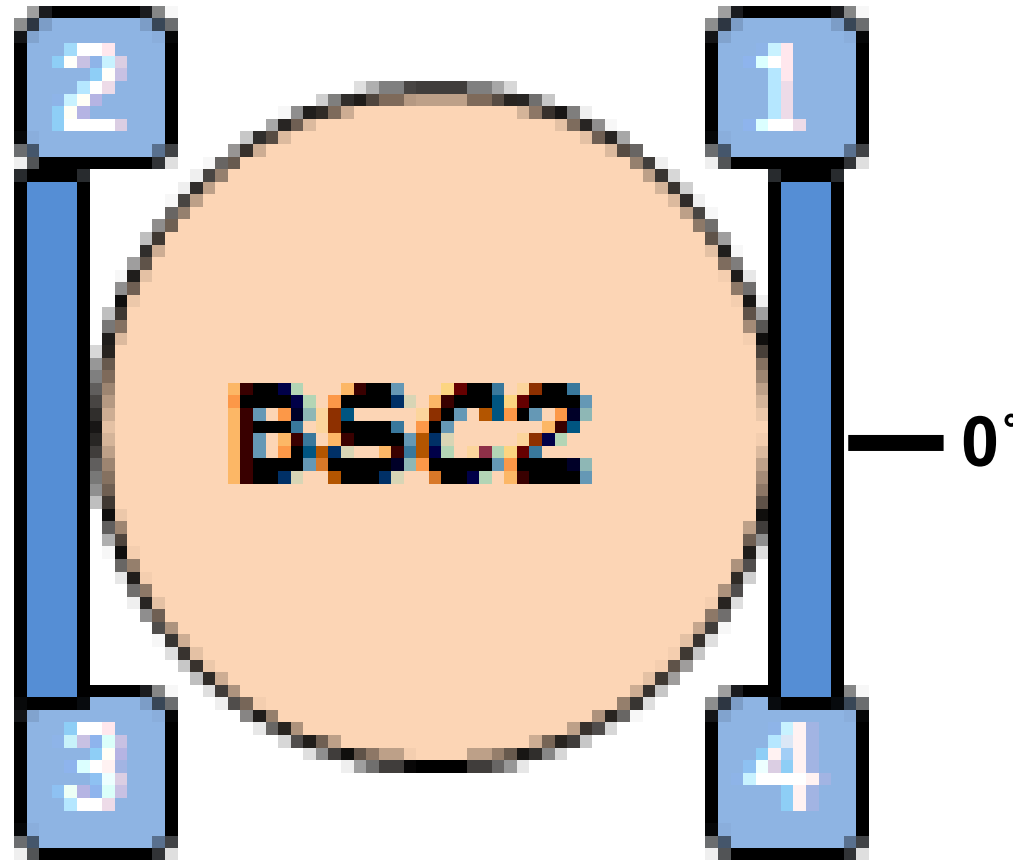

BSC2 Mid-size ION Pump

75IP-BSC2

BSC2 Turbo Pump

75IP-BSC2

BSC2 Scroll Pump

75IP-BSC2

BSC2 Annulus ION Pump

75IP-BSC2

BSC2 Parani Gauge

75IPBSC2

BSC2 Cold Cathode

75IPBSC2

BSC2 Top Level Chamber Assembly

[D0900428](#)

BSC2 Drawing

[D0900429](#)

BSC2 Viewports

[T1000746](#)

BSC2 Flanges

[D1003089](#)

BSC2 HEPI

75IP-BSC2

BSC2 CPS

75IP-BSC2

BSC2 Annulus Ion Pump

[<< BSC2 Chamber Elements](#)

BSC2 Annulus ION Pump

[Controller](#)

MiniVac Controller

Model 929-0196
Model 929-0197



Input/Output Interconnections

All input/output signals are accessible at J001 accessory connector. With the provided P001 mating connector - make the connections with AWG 24 (0.2 mm²) - or smaller wire - to the pins indicated in the following figure to obtain the desired capability.

Input signals

Pin 3-7 Remote high voltage ON/OFF or high voltage interlock; requires a permanent closed pin contact.

NOTE

Pin 3-7 must be shorted to allow the high voltage output if no remote/interlock contact is connected.

Output signals

Pin 1-6 Current recorder output 1 (pin 1 signal out, pin 6 ground). The output voltage 0 to + 10 Vdc is proportional to the pump current 0 to 10 mA (e.g. 10 Vdc correspond to 10 mA). The resolution is 10 mV minimum (corresponding to 10 μ A).

The front panel REC. OUT connector is a duplicate of this signal on a BNC connector.

Pin 2-6 Current recorder output 2 (pin 2 signal out, pin 6 ground). The output voltage 0 to + 10 Vdc is proportional to the pump current 0 to 1 mA (e.g. 10 Vdc correspond to 1 mA). The resolution is 10 mV minimum (corresponding to 1 μ A).

Pin 4-8 Voltage recorder output (pin 4 signal out, pin 8 ground). The output voltage 0 to 5 V is proportional to the controller high voltage output 0 to 5 kV (e.g. 1 V corresponds to 1 kV in linear mode).

Pin 5-9 High voltage indication contact. This pure contact (which carries 1 A at 250 Vac and 0.2 A at 30 Vdc) is open when the high voltage is off and closes when the high voltage is on.

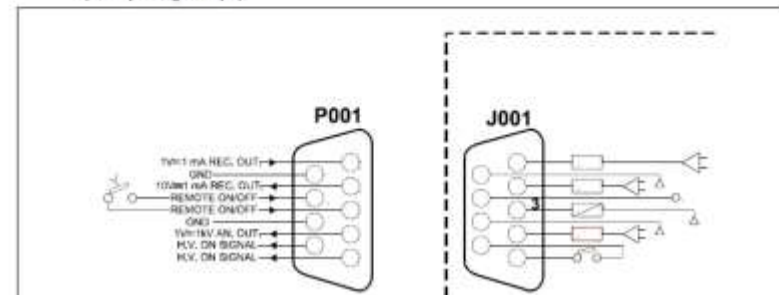

BSC2 Chamber Drawing (BS)

[<< BSC2 Chamber Elements](#)

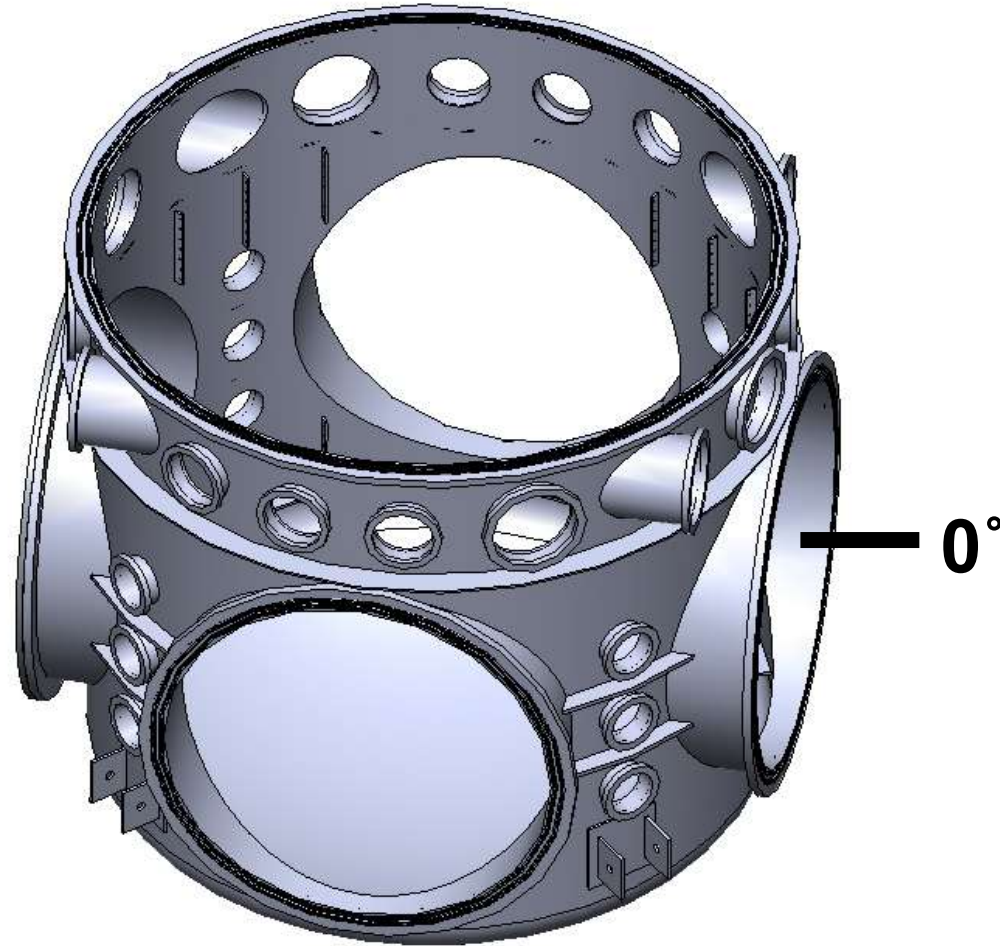

BSC2 Chamber Viewports (BS)

<< [BSC2 Chamber Elements](#)

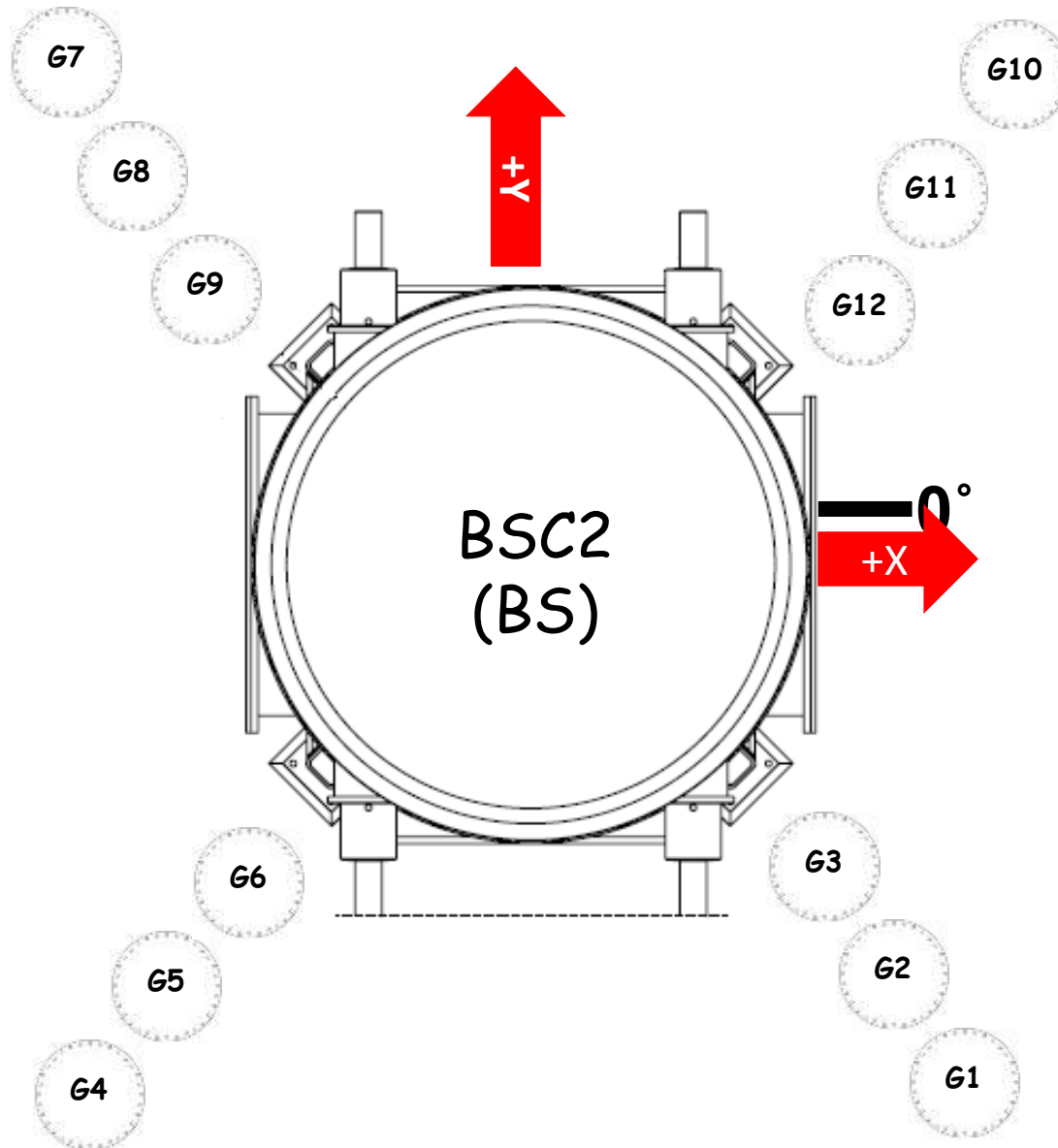

BSC2 Chamber Flanges (BS)

<< BSC2 Chamber Elements

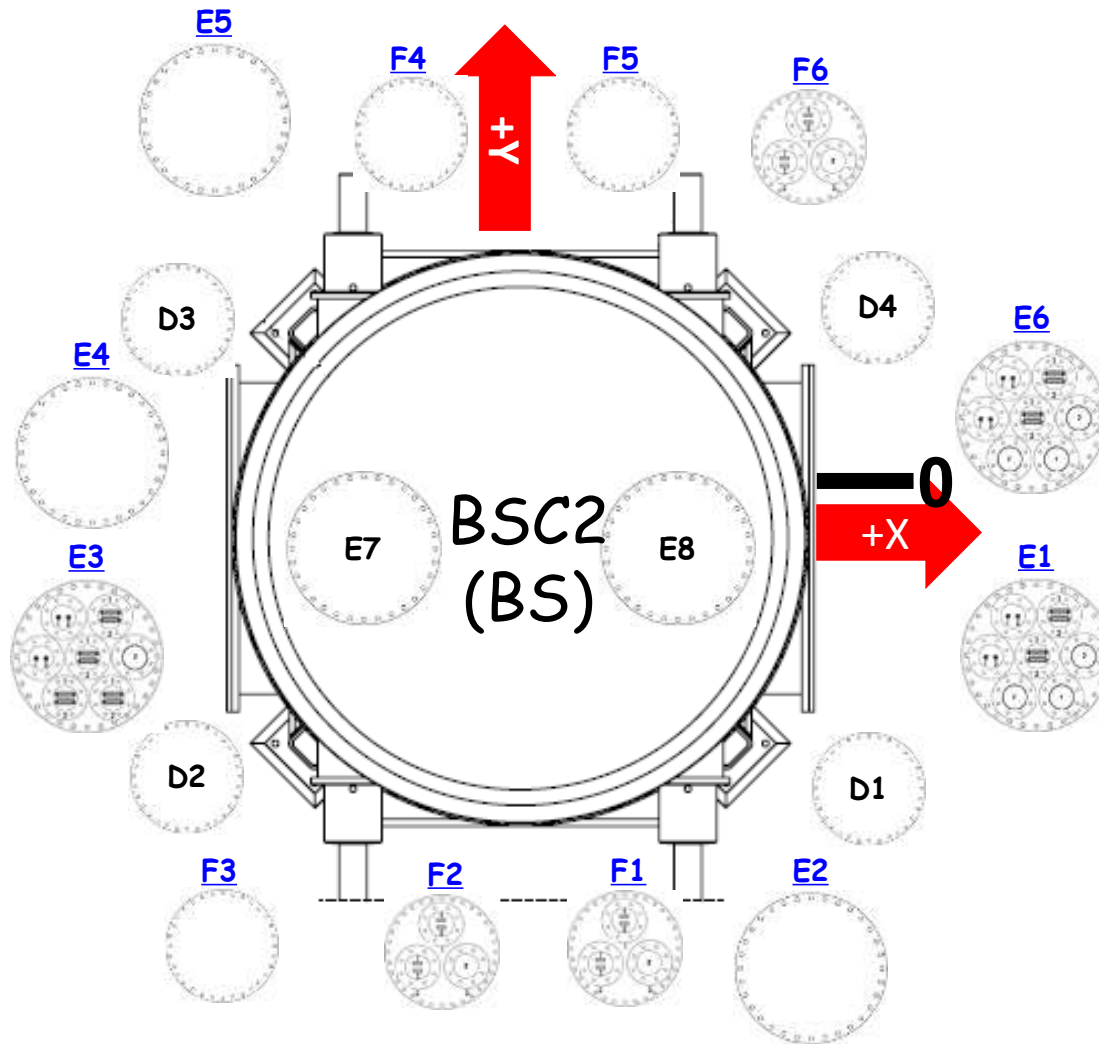

E1

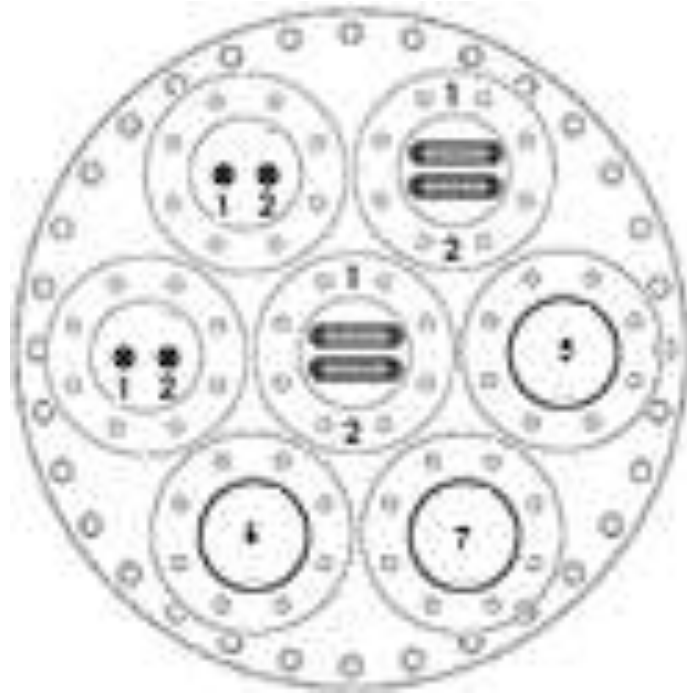

E2

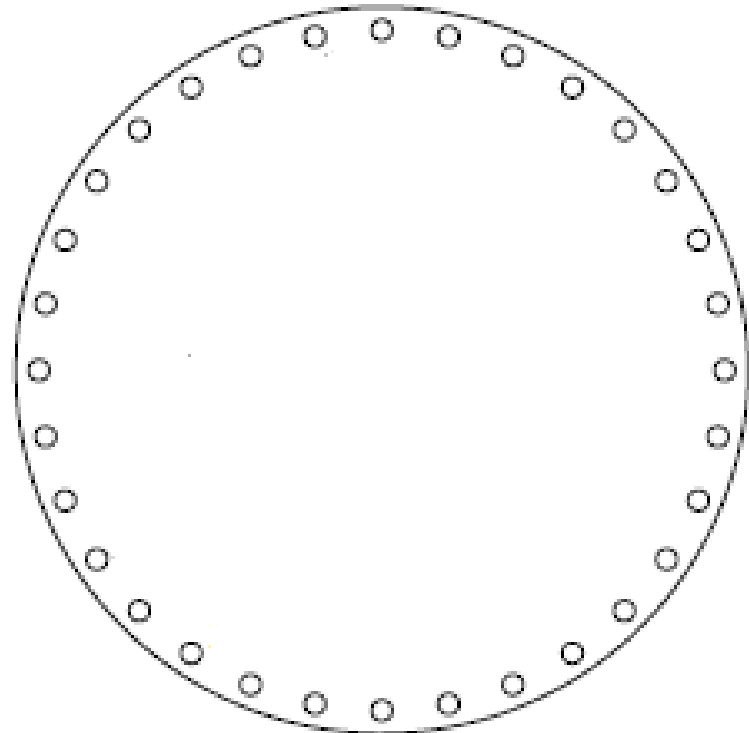

E3

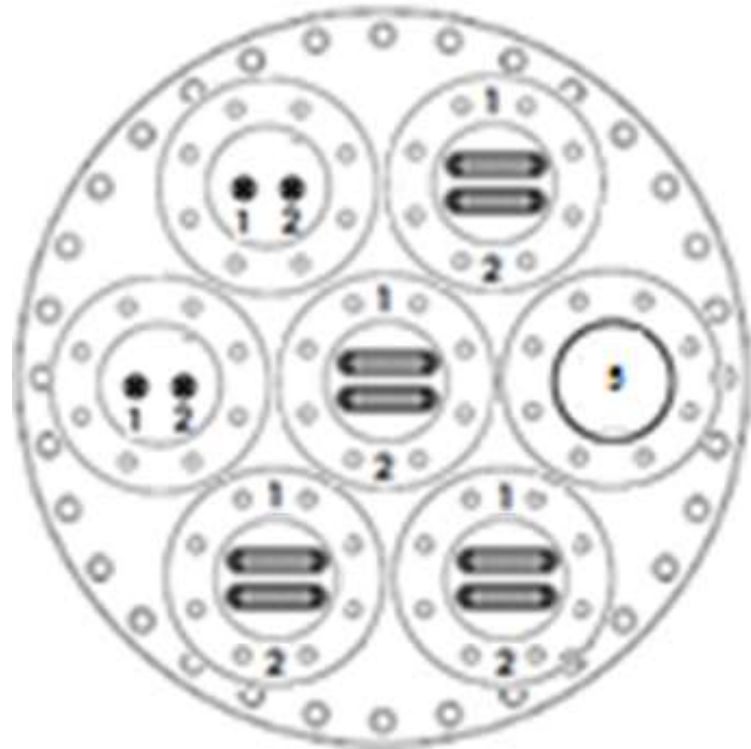

BSC2 Chamber Flange E4

[<< BSC2 Chamber Flanges](#)

E4

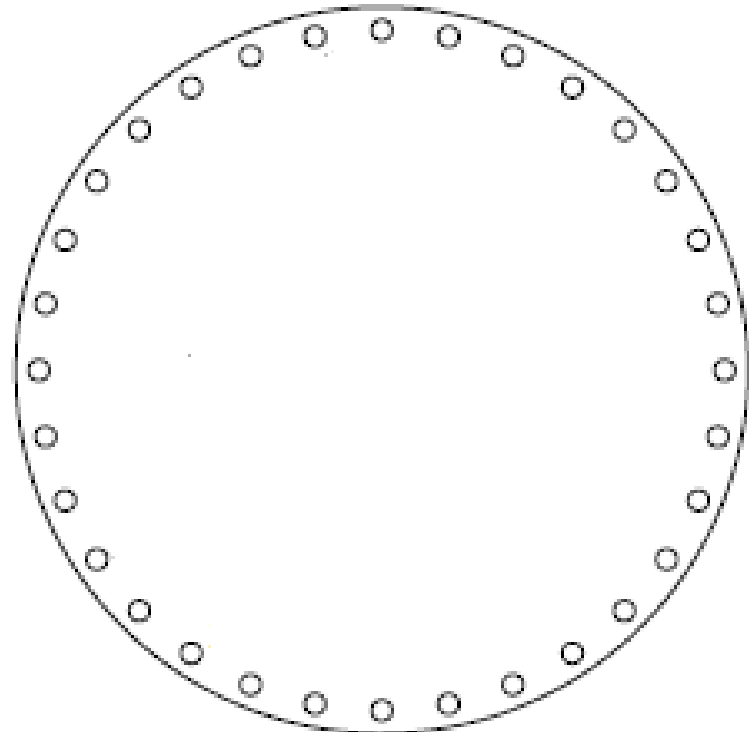

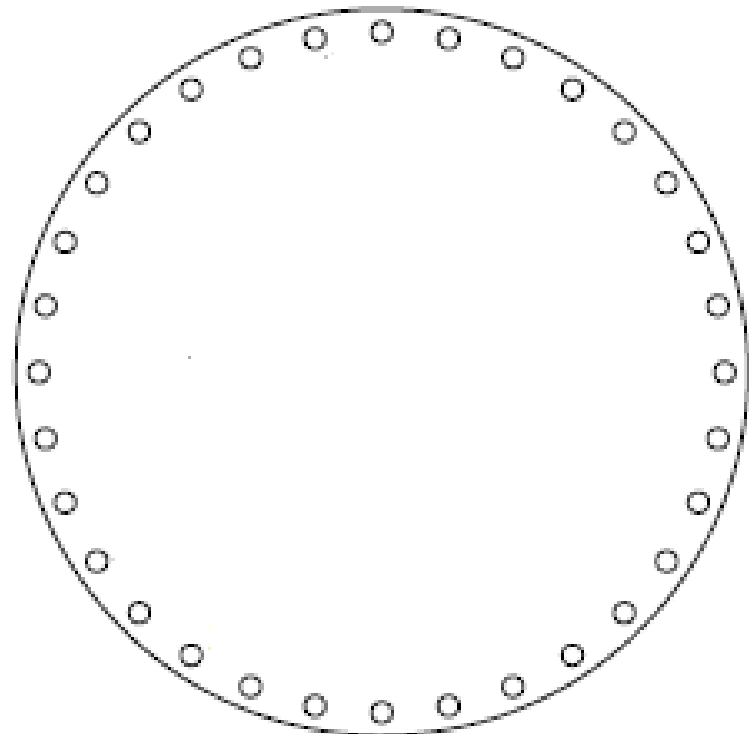

E5



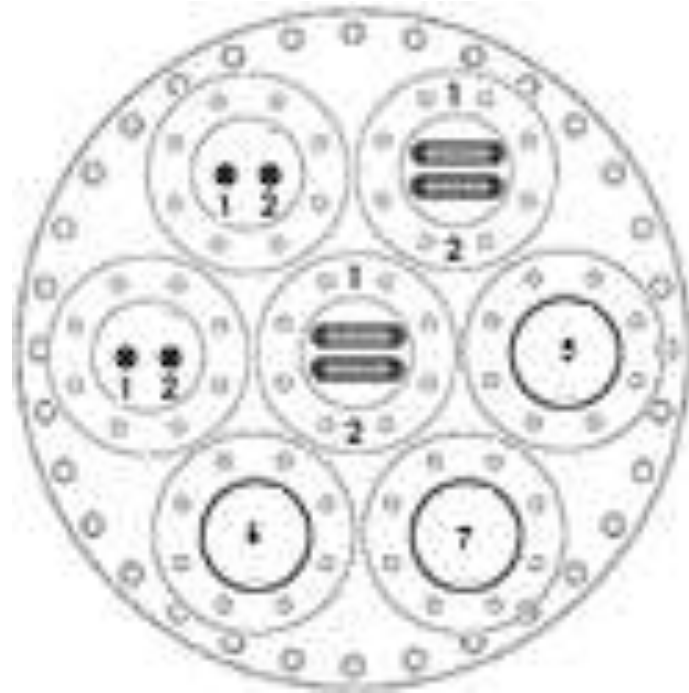

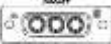
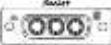
E6

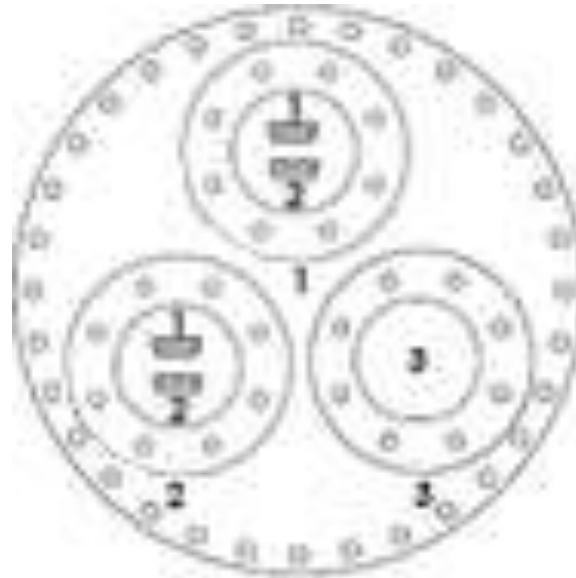

- F6-1-1  F6-1-1
- F6-1-2  F6-1-2
- F6-2-1  F6-2-1
- F6-2-2  F6-2-2

F1

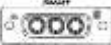
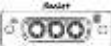
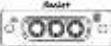

- F6-1-1  F6-1-1
- F6-1-2  F6-1-2
- F6-2-1  F6-2-1
- F6-2-2  F6-2-2

F2

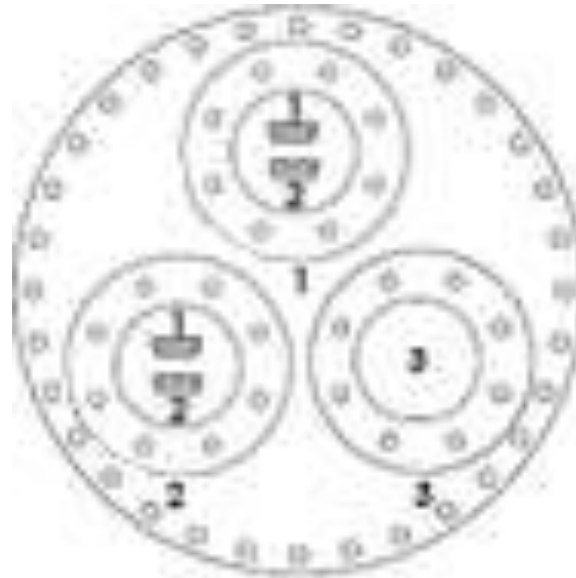

F3

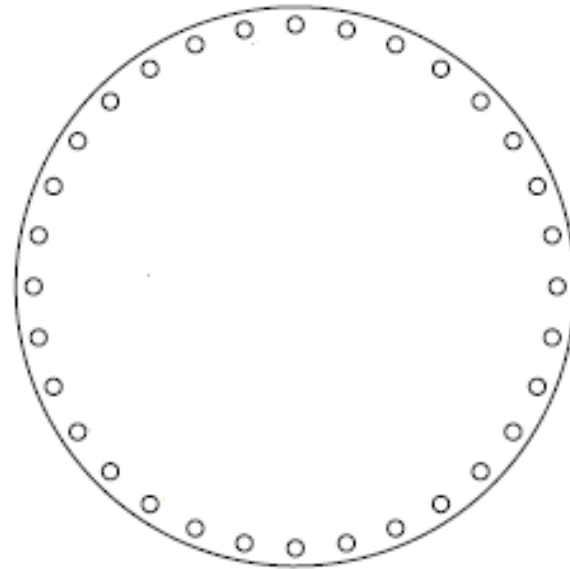

F4

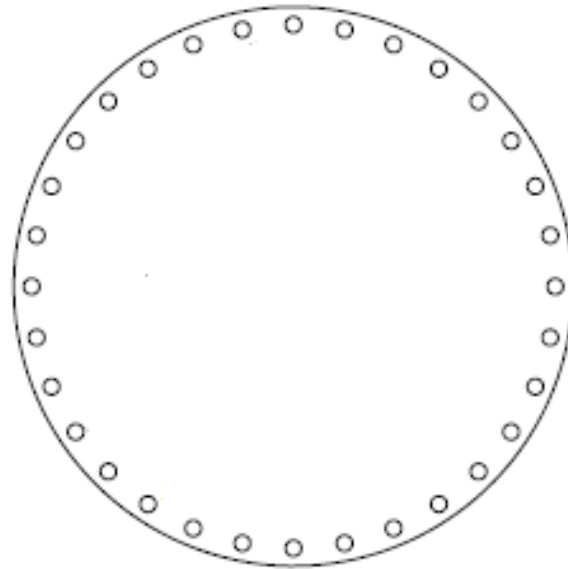



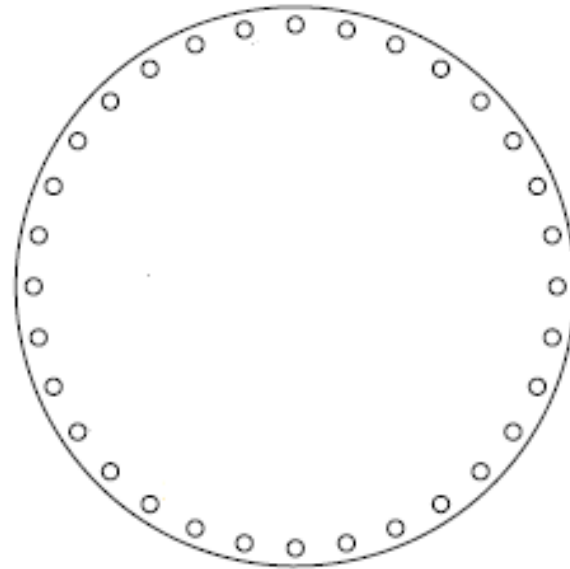

BSC2 Chamber Flange F5

[<< BSC2 Chamber Flanges](#)

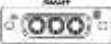
F5

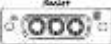

- F6-1-1  F6-1-1
- F6-1-2  F6-1-2
- F6-2-1  F6-2-1
- F6-2-2  F6-2-2

F6

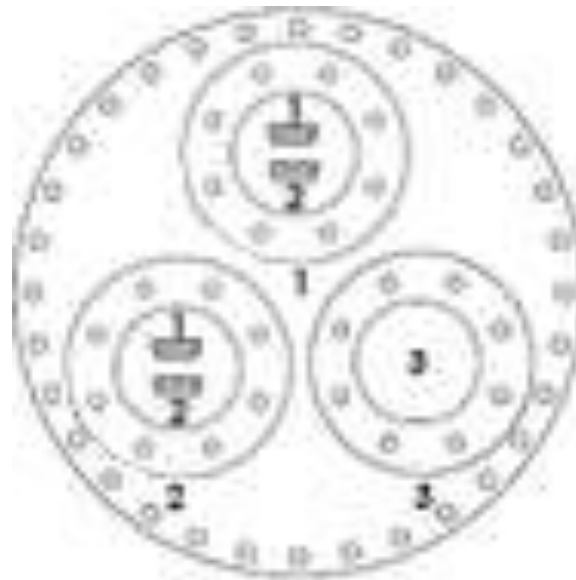

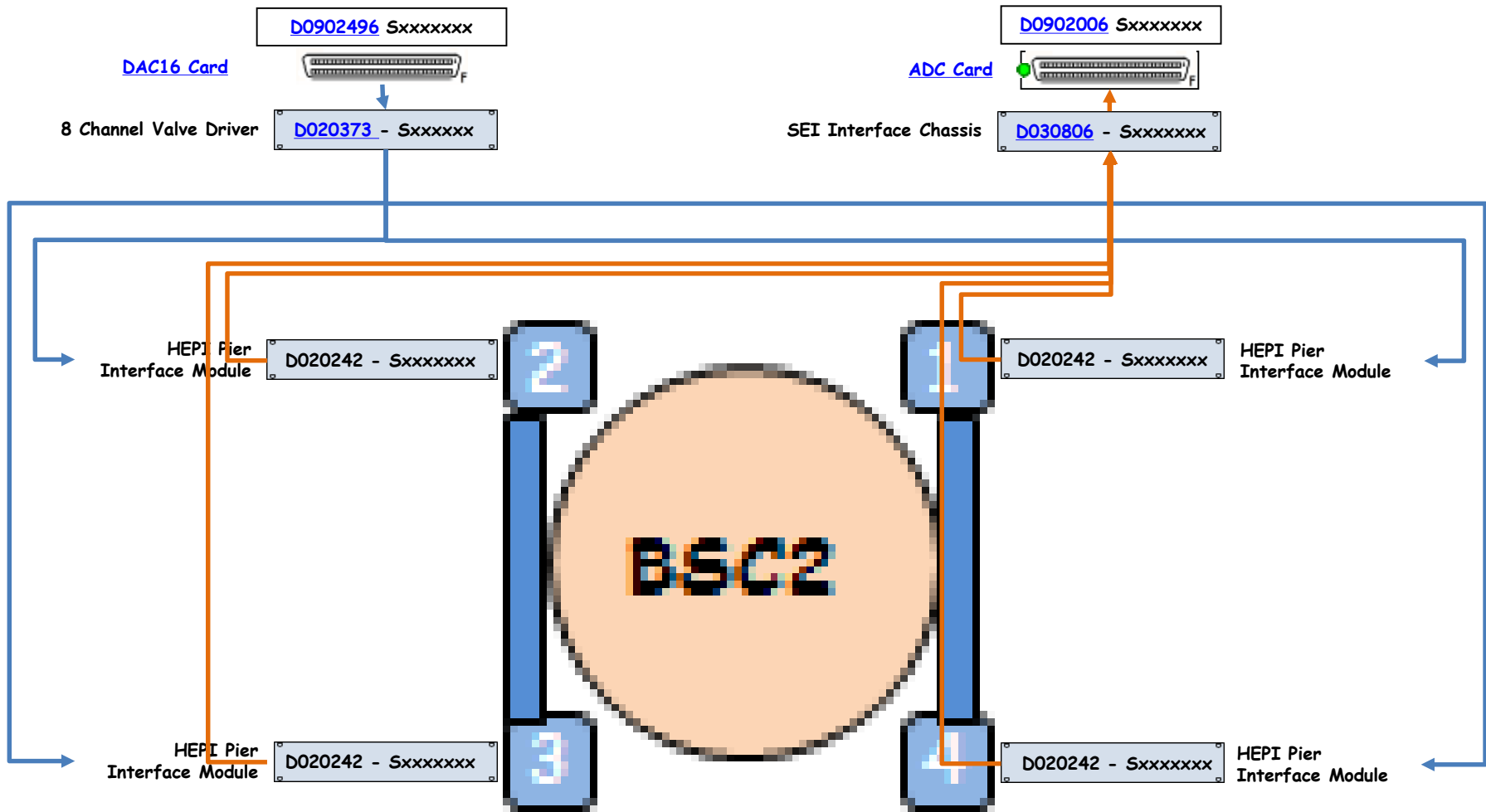

BSC3 Chamber Elements (ITMX)

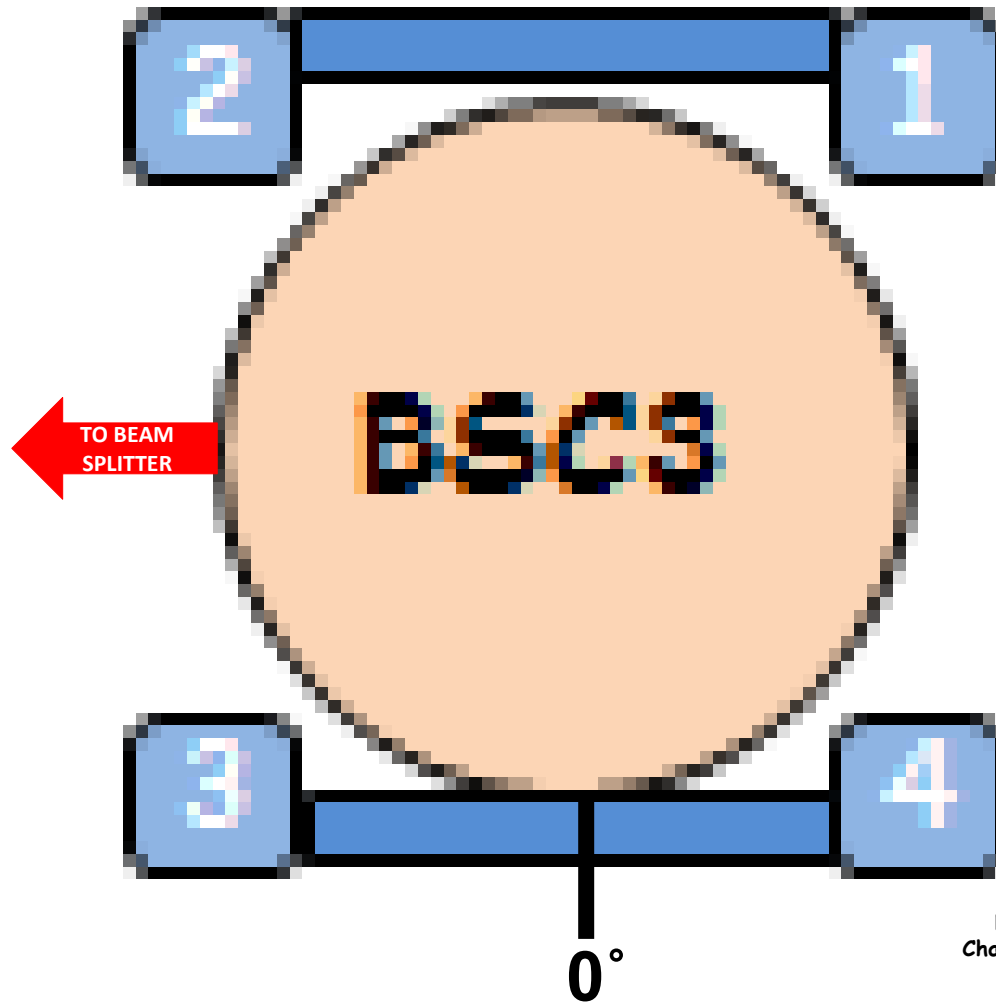

BSC3 Mid-size ION Pump	75IP-BSC3
BSC3 Turbo Pump	75IP-BSC3
BSC3 Scroll Pump	75IP-BSC3

BSC3 Annulus ION Pump	75IP-BSC3
BSC3 Parani Gauge	75IPBSC3
BSC3 Cold Cathode	75IPBSC3

BSC3 Top Level Chamber Assembly	D0900492
BSC3 Drawing	D0900493
BSC3 Viewports	T1000746
BSC3 Flanges	D1003090
BSC3 HEPI	75IP-BSC3
BSC3 CPS	75IP-BSC3

BSC3 Annulus Ion Pump

[<< BSC3 Chamber Elements](#)

BSC3 Annulus ION Pump

[Controller](#)

MiniVac Controller

Model 929-0196
Model 929-0197



Input/Output Interconnections

All input/output signals are accessible at J001 accessory connector. With the provided P001 mating connector - make the connections with AWG 24 (0.2 mm²) - or smaller wire - to the pins indicated in the following figure to obtain the desired capability.

Input signals

Pin 3-7 Remote high voltage ON/OFF or high voltage interlock; requires a permanent closed pin contact.

NOTE

Pin 3-7 must be shorted to allow the high voltage output if no remote/interlock contact is connected.

Output signals

Pin 1-6 Current recorder output 1 (pin 1 signal out, pin 6 ground). The output voltage 0 to + 10 Vdc is proportional to the pump current 0 to 10 mA (e.g. 10 Vdc correspond to 10 mA). The resolution is 10 mV minimum (corresponding to 10 μ A).

The front panel REC. OUT connector is a duplicate of this signal on a BNC connector.

Pin 2-6 Current recorder output 2 (pin 2 signal out, pin 6 ground). The output voltage 0 to + 10 Vdc is proportional to the pump current 0 to 1 mA (e.g. 10 Vdc correspond to 1 mA). The resolution is 10 mV minimum (corresponding to 1 μ A).

Pin 4-8 Voltage recorder output (pin 4 signal out, pin 8 ground). The output voltage 0 to 5 V is proportional to the controller high voltage output 0 to 5 kV (e.g. 1 V corresponds to 1 kV in linear mode).

Pin 5-9 High voltage indication contact. This pure contact (which carries 1 A at 250 Vac and 0.2 A at 30 Vdc) is open when the high voltage is off and closes when the high voltage is on.

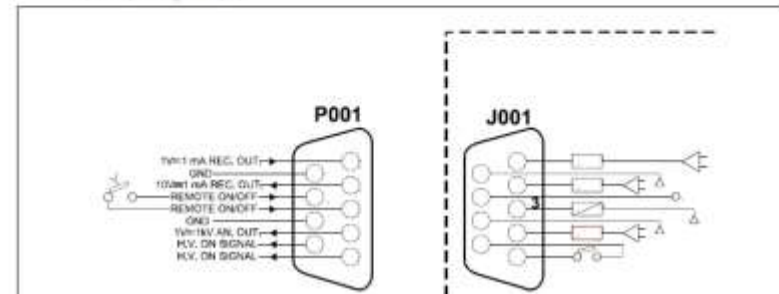

BSC3 Chamber Drawing (ITMX)

<< [BSC3 Chamber Elements](#)

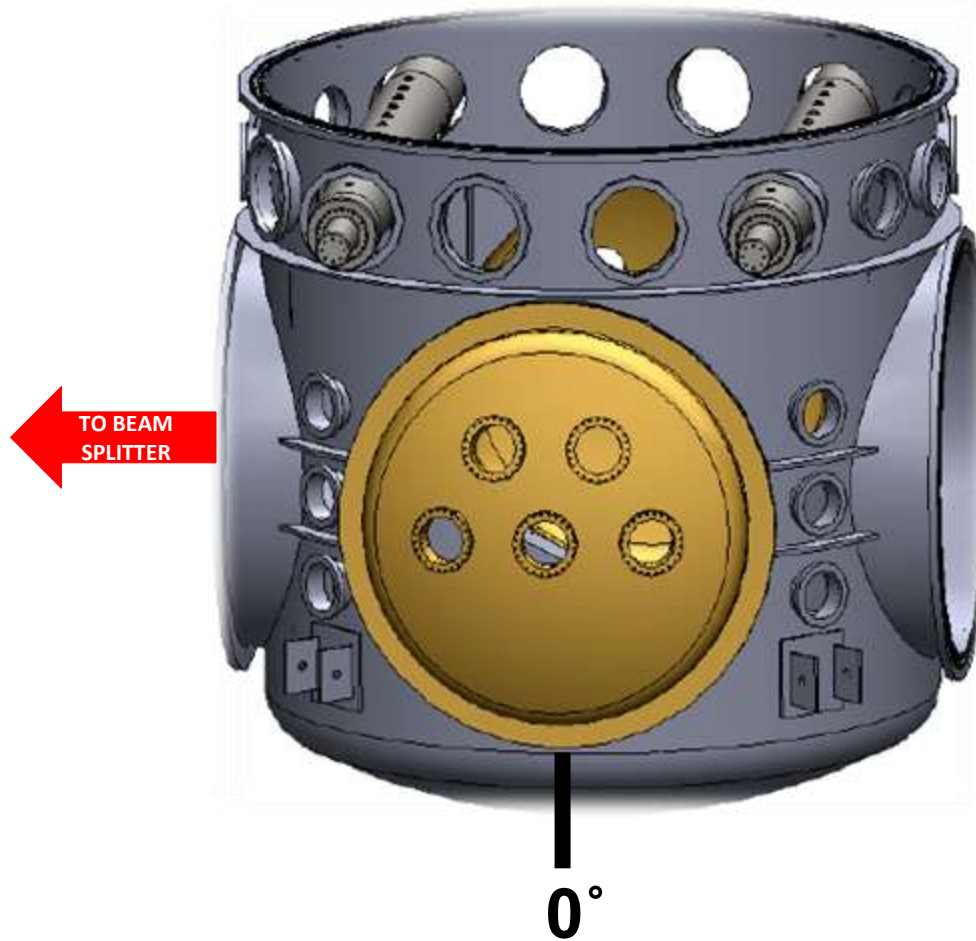

BSC3 Chamber Viewports (ITMX)

<< BSC3 Chamber Elements

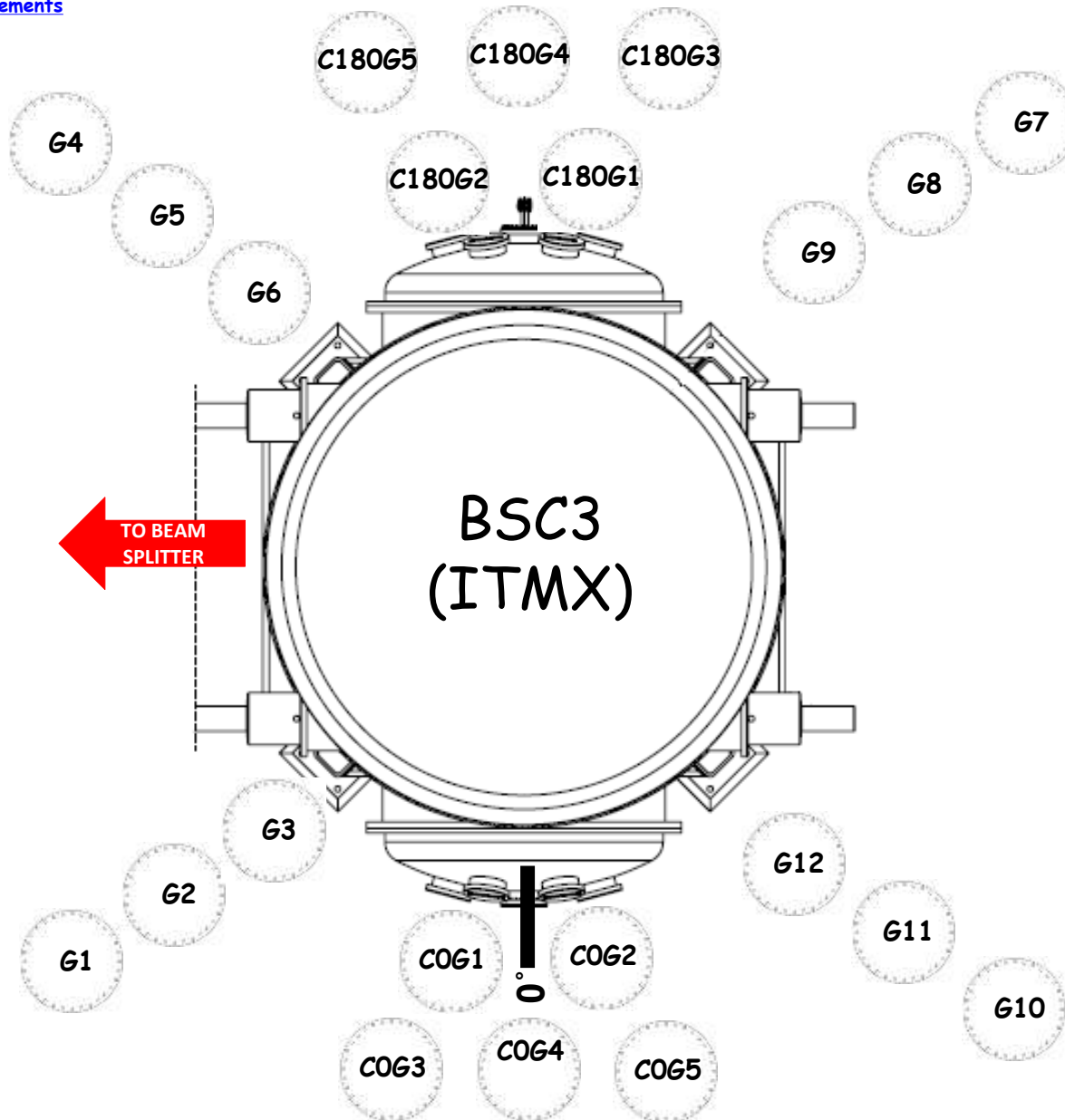

BSC3 Chamber Flanges (ITMX)

<< [BSC3 Chamber Elements](#)

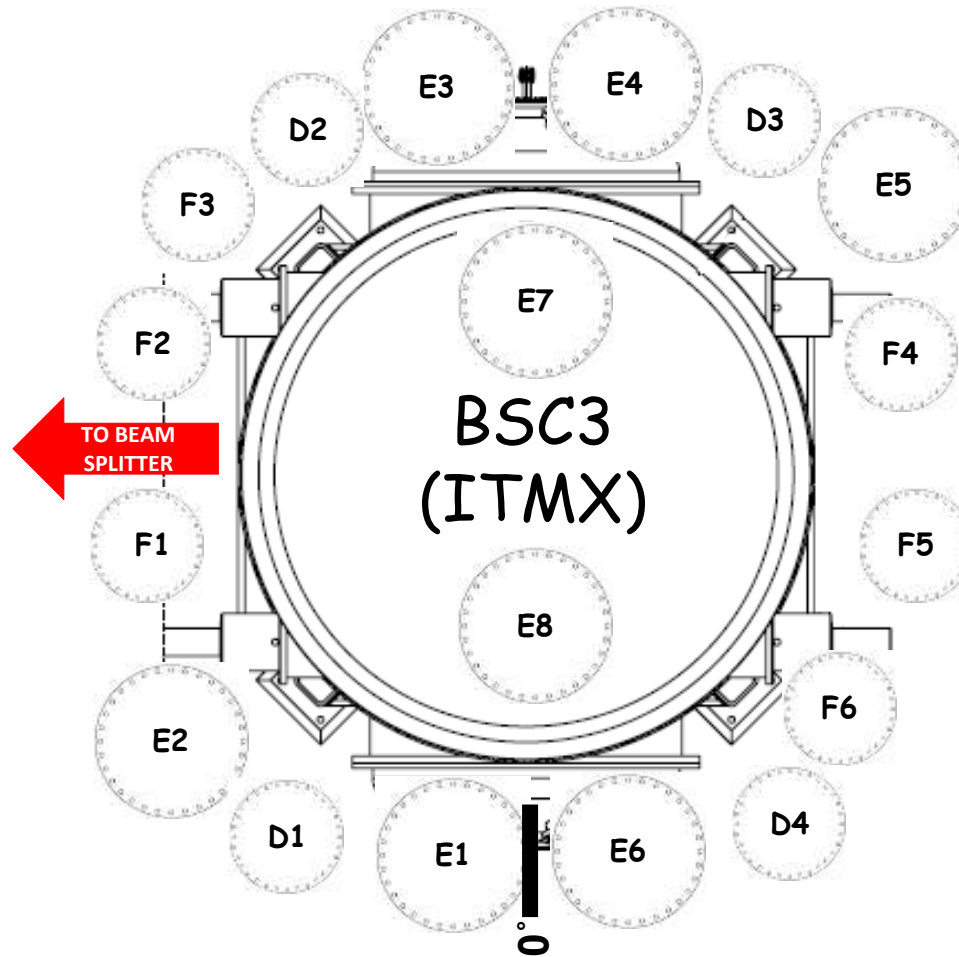

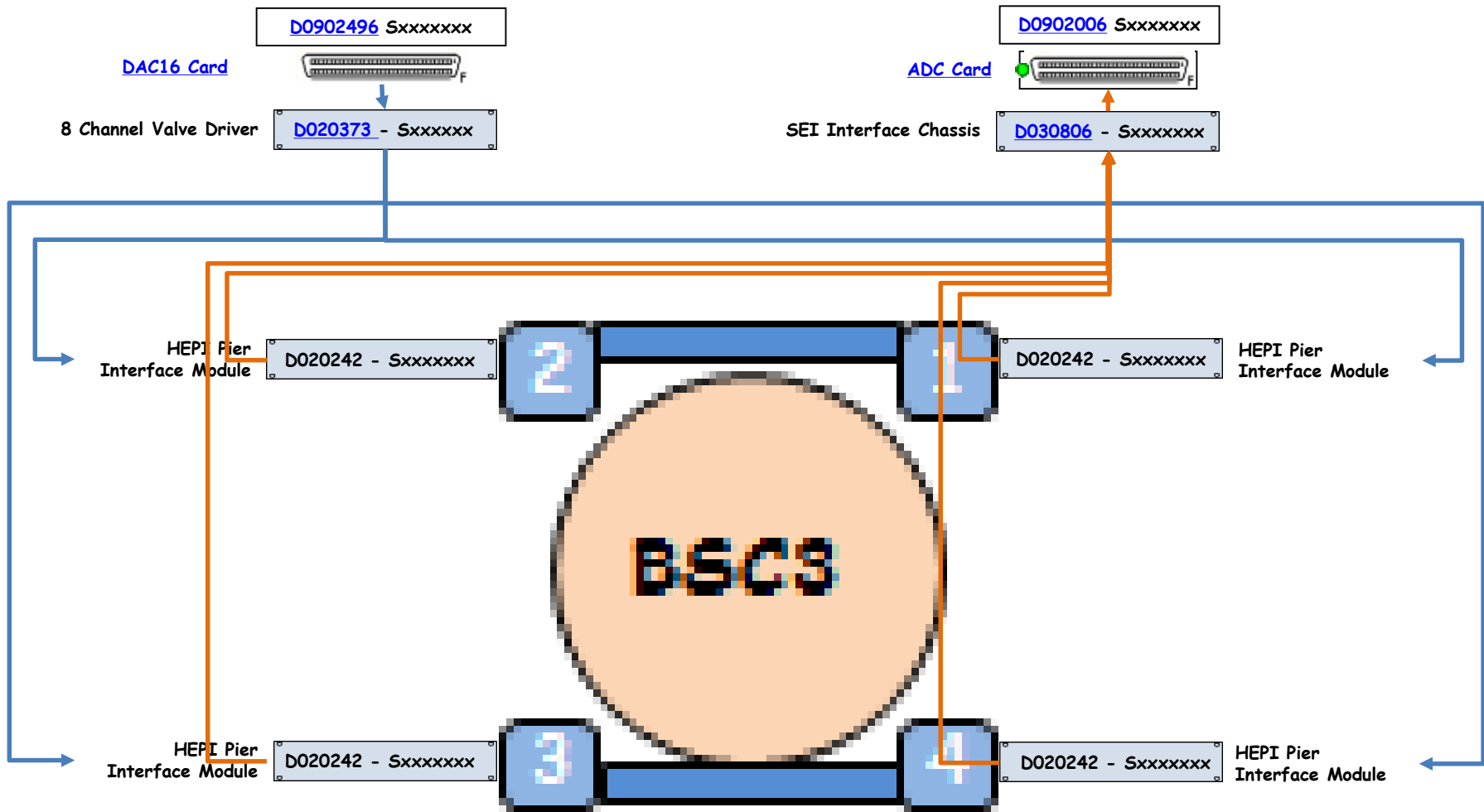

BSC4 Chamber Elements (ETMX)

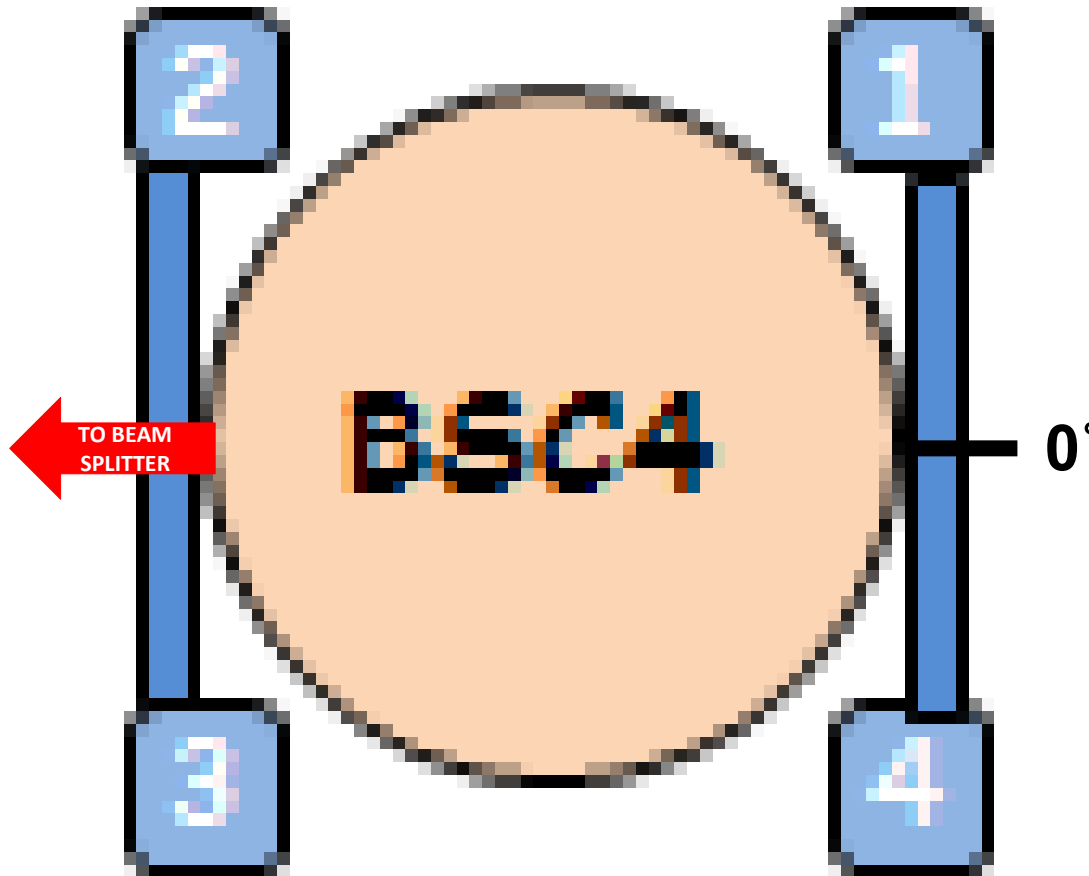

BSC4 Mid-size ION Pump	75IP-BSC4
BSC4 Turbo Pump	75IP-BSC4
BSC4 Scroll Pump	75IP-BSC4

<u>BSC4 Annulus ION Pump</u>	75IP-BSC4
BSC4 Parani Gauge	75IPBSC4
BSC4 Cold Cathode	75IPBSC4

BSC4 Top Level Chamber Assembly	D0900471
<u>BSC4 Drawing</u>	D0900473
<u>BSC4 Viewports</u>	T1000746
<u>BSC4 Flanges</u>	D1003091
<u>BSC4 HEPI</u>	75IP-BSC4
BSC4 CPS	75IP-BSC4

BSC4 Annulus Ion Pump

[<< BSC4 Chamber Elements](#)

BSC4 Annulus ION Pump

[Controller](#)

MiniVac Controller

Model 929-0196
Model 929-0197



Input/Output Interconnections

All input/output signals are accessible at J001 accessory connector. With the provided P001 mating connector - make the connections with AWG 24 (0.2 mm²) - or smaller wire - to the pins indicated in the following figure to obtain the desired capability.

Input signals

Pin 3-7 Remote high voltage ON/OFF or high voltage interlock; requires a permanent closed pin contact.

NOTE

Pin 3-7 must be shorted to allow the high voltage output if no remote/interlock contact is connected.

Output signals

Pin 1-6 Current recorder output 1 (pin 1 signal out, pin 6 ground). The output voltage 0 to + 10 Vdc is proportional to the pump current 0 to 10 mA (e.g. 10 Vdc correspond to 10 mA). The resolution is 10 mV minimum (corresponding to 10 μ A).

The front panel REC. OUT connector is a duplicate of this signal on a BNC connector.

Pin 2-6 Current recorder output 2 (pin 2 signal out, pin 6 ground). The output voltage 0 to + 10 Vdc is proportional to the pump current 0 to 1 mA (e.g. 10 Vdc correspond to 1 mA). The resolution is 10 mV minimum (corresponding to 1 μ A).

Pin 4-8 Voltage recorder output (pin 4 signal out, pin 8 ground). The output voltage 0 to 5 V is proportional to the controller high voltage output 0 to 5 kV (e.g. 1 V corresponds to 1 kV in linear mode).

Pin 5-9 High voltage indication contact. This pure contact (which carries 1 A at 250 Vac and 0.2 A at 30 Vdc) is open when the high voltage is off and closes when the high voltage is on.

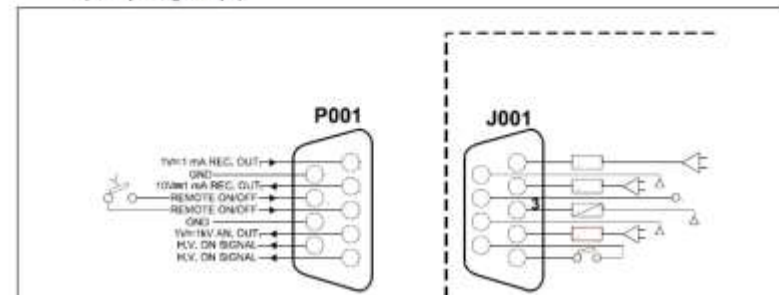

BSC4 Chamber Drawing (ETMX)

<< [BSC4 Chamber Elements](#)

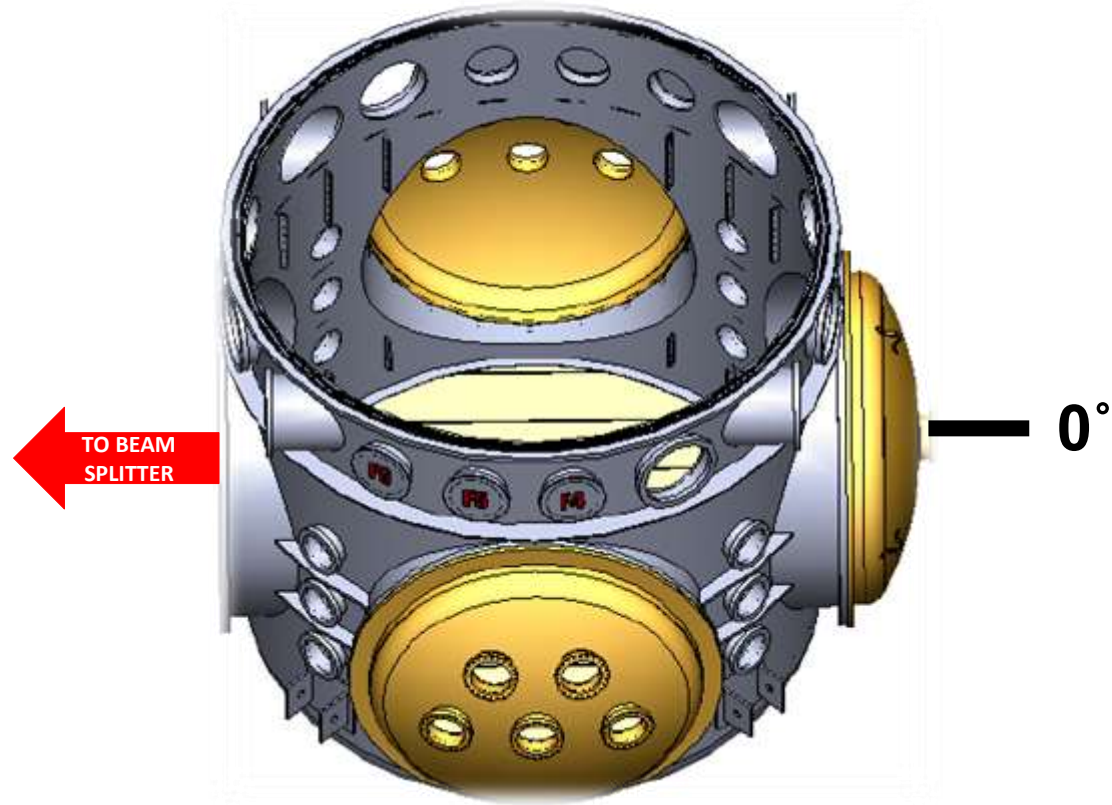

BSC4 Chamber Viewports (ETMX)

<< BSC4 Chamber Elements

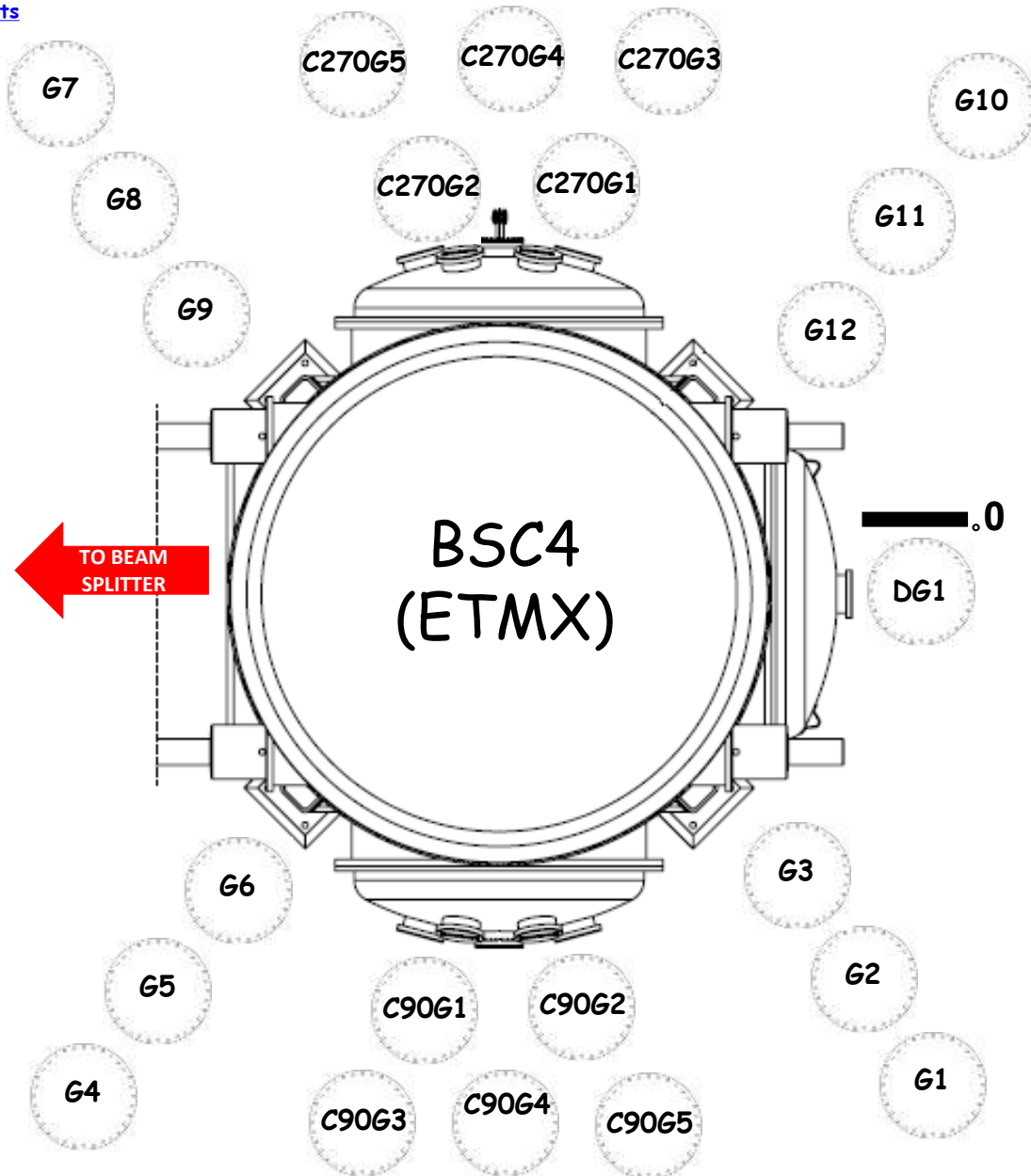

BSC4 Chamber Flanges (ETMX)

<< [BSC4 Chamber Elements](#)

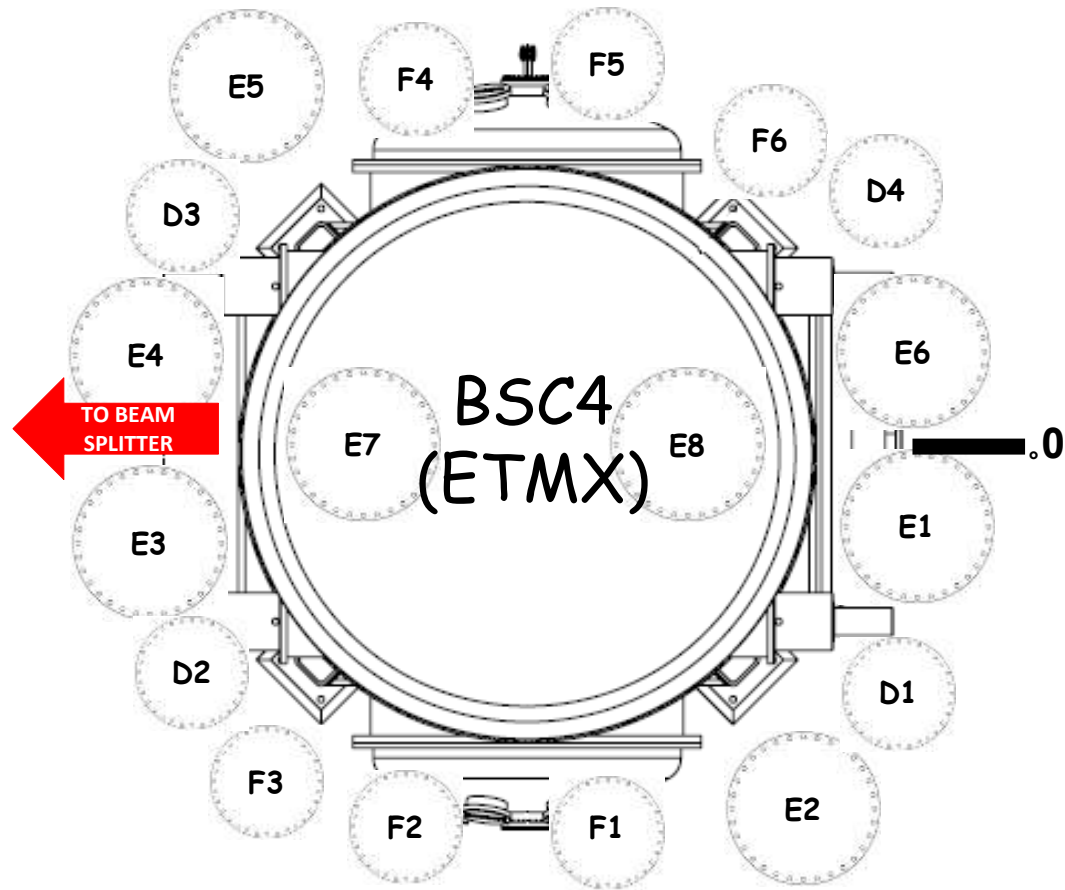

<< BSC4 Chamber Elements

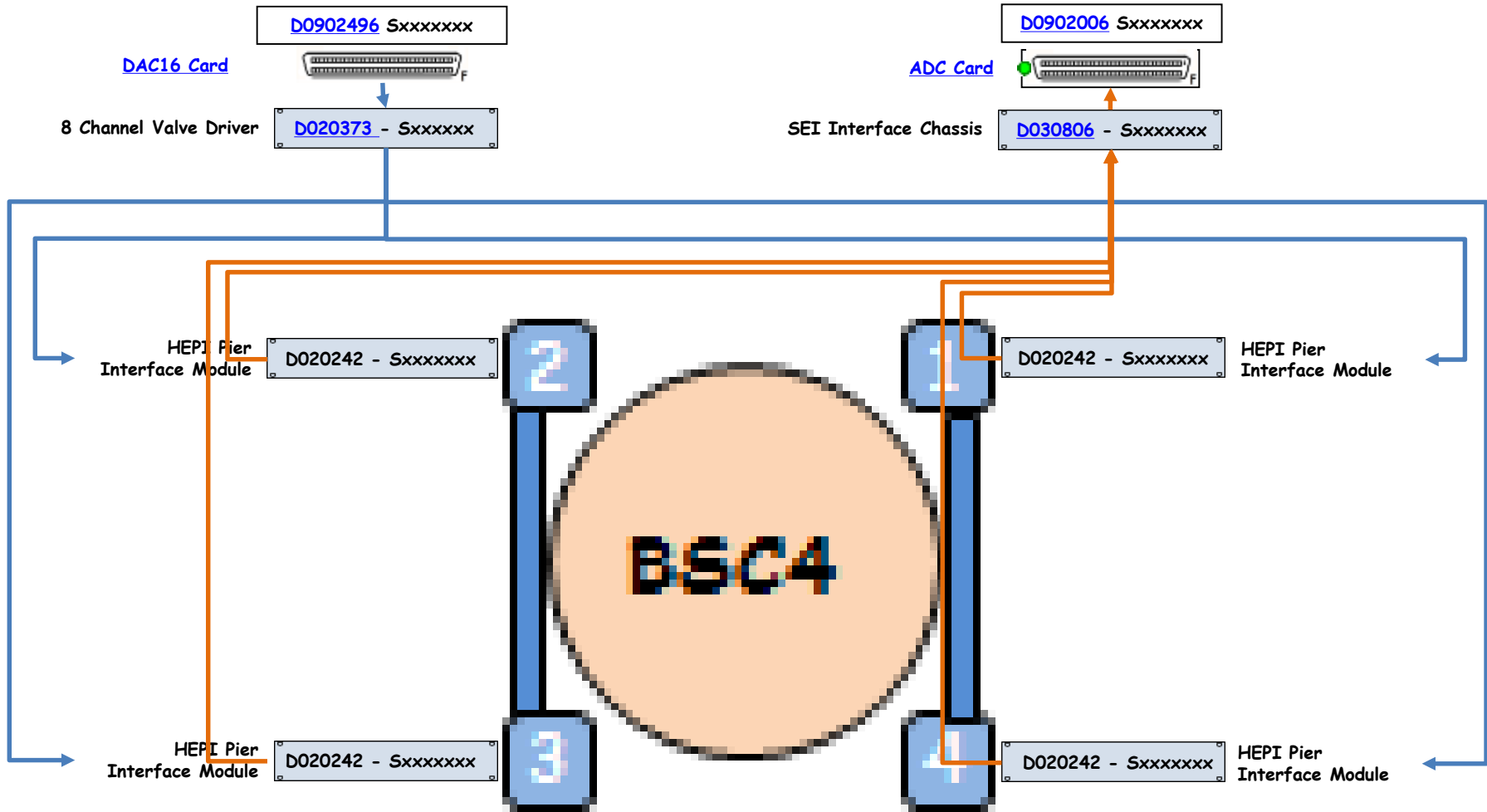

BSC5 Chamber Elements (ETMY)

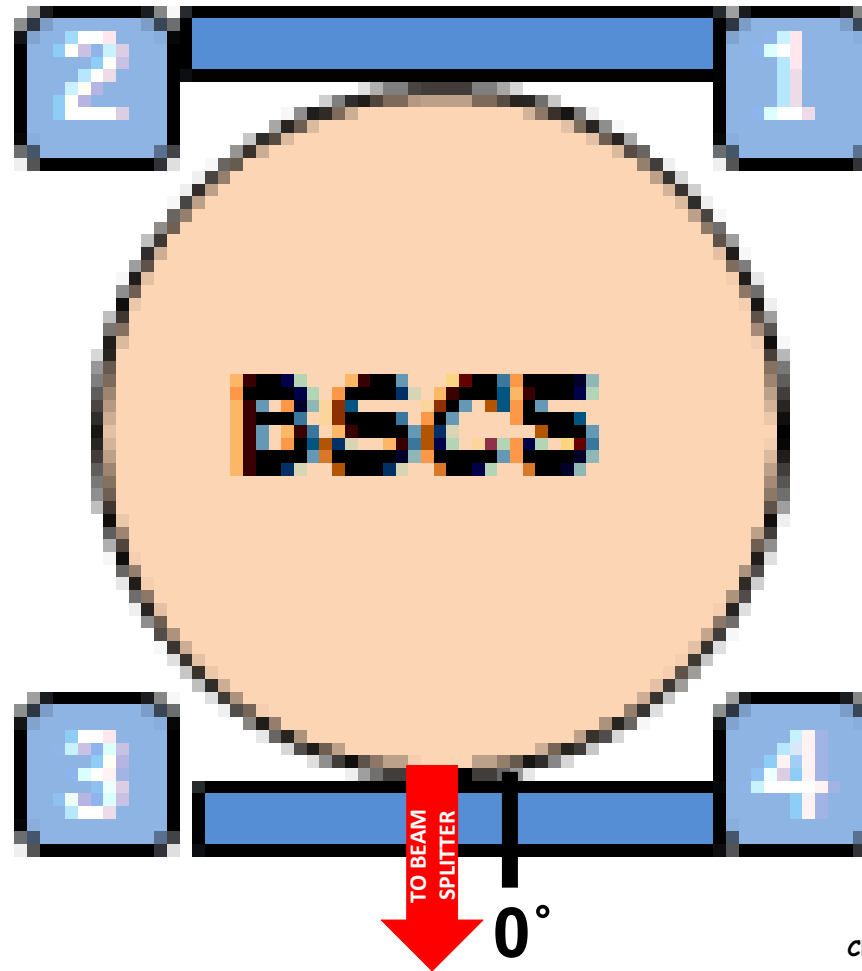

BSC5 Mid-size ION Pump	75IP-BSC5
BSC5 Turbo Pump	75IP-BSC5
BSC5 Scroll Pump	75IP-BSC5

BSC5 Annulus ION Pump	75IP-BSC5
BSC5 Parani Gauge	75IPBSC5
BSC5 Cold Cathode	75IPBSC5

BSC5 Top Level Chamber Assembly	D0900506
BSC5 Drawing	D0900507
BSC5 Viewports	T1000746
BSC5 Flanges	D1003092
BSC5 HEPI	75IP-BSC5
BSC5 CPS	75IP-BSC5

BSC5 Annulus Ion Pump

[<< BSC5 Chamber Elements](#)

BSC5 Annulus ION Pump

[Controller](#)

MiniVac Controller

Model 929-0196
Model 929-0197



Input/Output Interconnections

All input/output signals are accessible at J001 accessory connector. With the provided P001 mating connector, make the connections with AWG 24 (0.2 mm²) - or smaller wire - to the pins indicated in the following figure to obtain the desired capability.

Input signals

Pin 3-7 Remote high voltage ON/OFF or high voltage interlock; requires a permanent closed pin contact.

NOTE

Pin 3-7 must be shorted to allow the high voltage output if no remote/interlock contact is connected.

Output signals

Pin 1-6 Current recorder output 1 (pin 1 signal out, pin 6 ground). The output voltage 0 to + 10 Vdc is proportional to the pump current 0 to 10 mA (e.g. 10 Vdc correspond to 10 mA). The resolution is 10 mV minimum (corresponding to 10 μ A).

The front panel REC. OUT connector is a duplicate of this signal on a BNC connector.

Pin 2-6 Current recorder output 2 (pin 2 signal out, pin 6 ground). The output voltage 0 to + 10 Vdc is proportional to the pump current 0 to 1 mA (e.g. 10 Vdc correspond to 1 mA). The resolution is 10 mV minimum (corresponding to 1 μ A).

Pin 4-8 Voltage recorder output (pin 4 signal out, pin 8 ground). The output voltage 0 to 5 V is proportional to the controller high voltage output 0 to 5 kV (e.g. 1 V corresponds to 1 kV in linear mode).

Pin 5-9 High voltage indication contact. This pure contact (which carries 1 A at 250 Vac and 0.2 A at 30 Vdc) is open when the high voltage is off and closes when the high voltage is on.

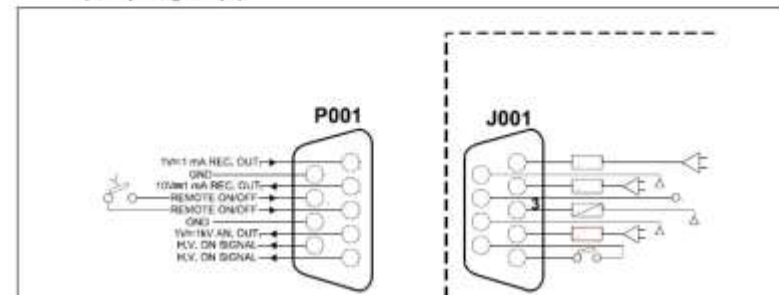

BSC5 Chamber Drawing (ETMY)

[<< BSC5 Chamber Elements](#)

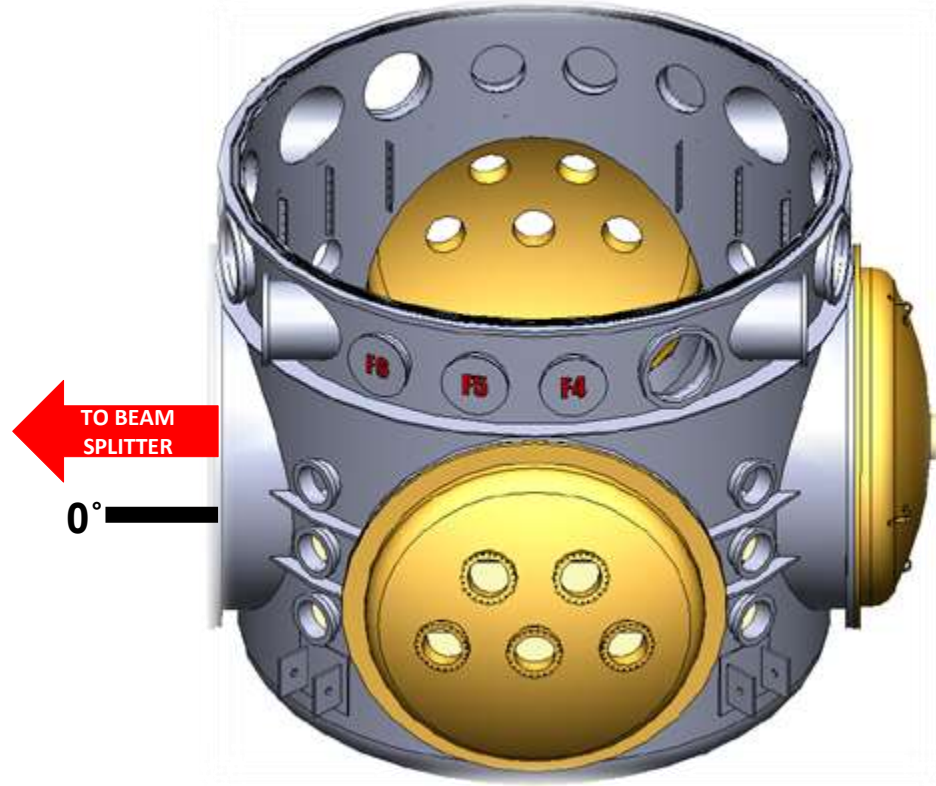

BSC5 Chamber Viewports (ETMY)

<< BSC5 Chamber Elements

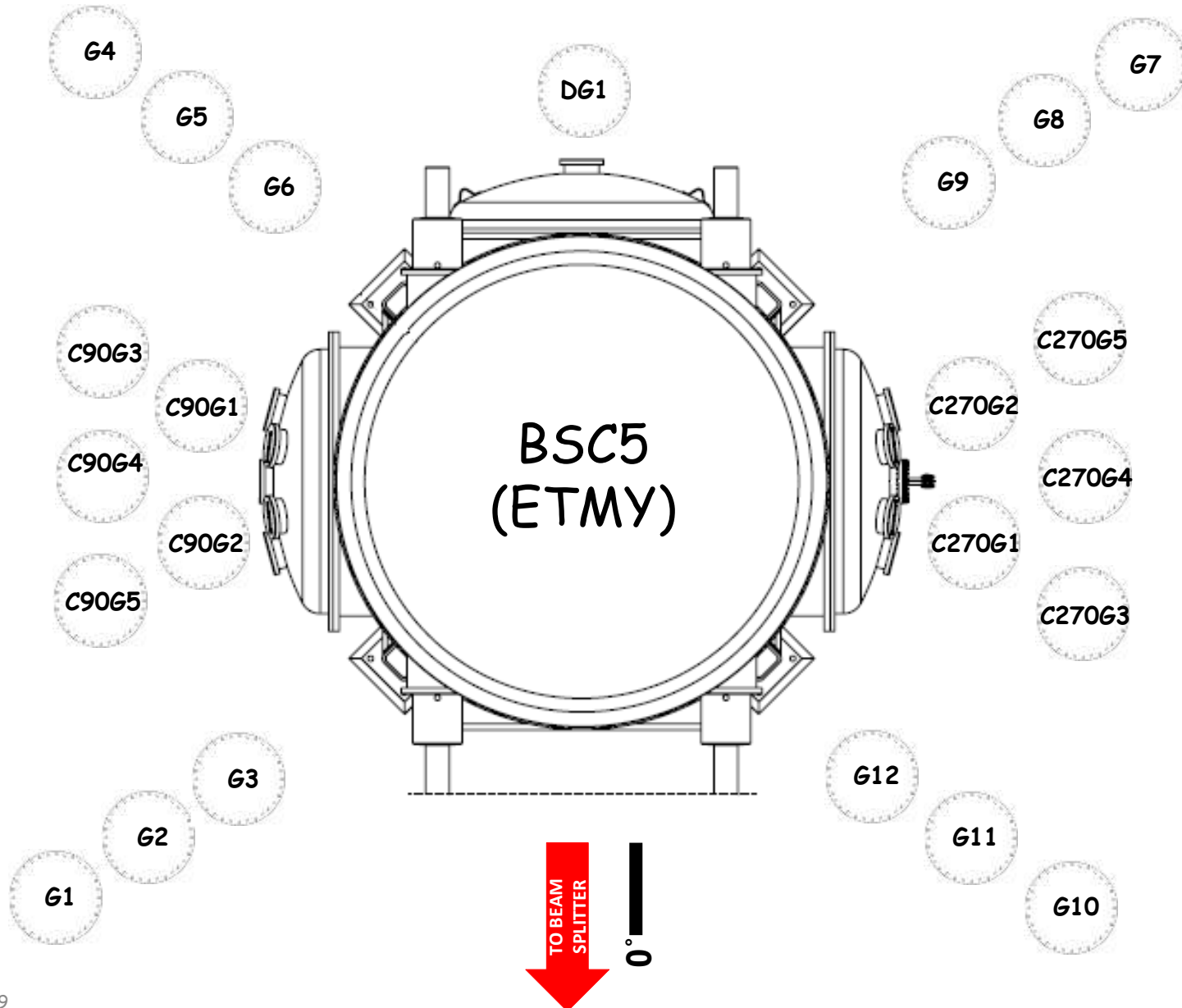

BSC5 Chamber Flanges (ETMY)

<< [BSC5 Chamber Elements](#)

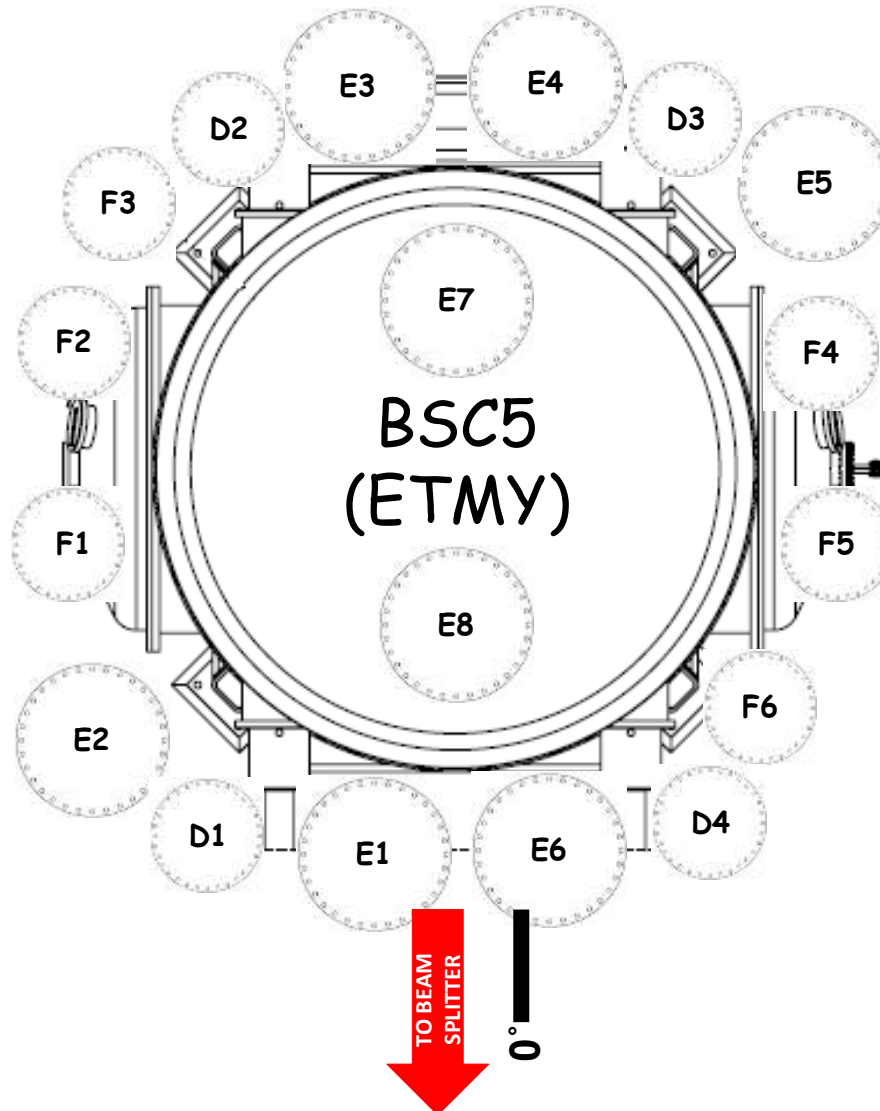

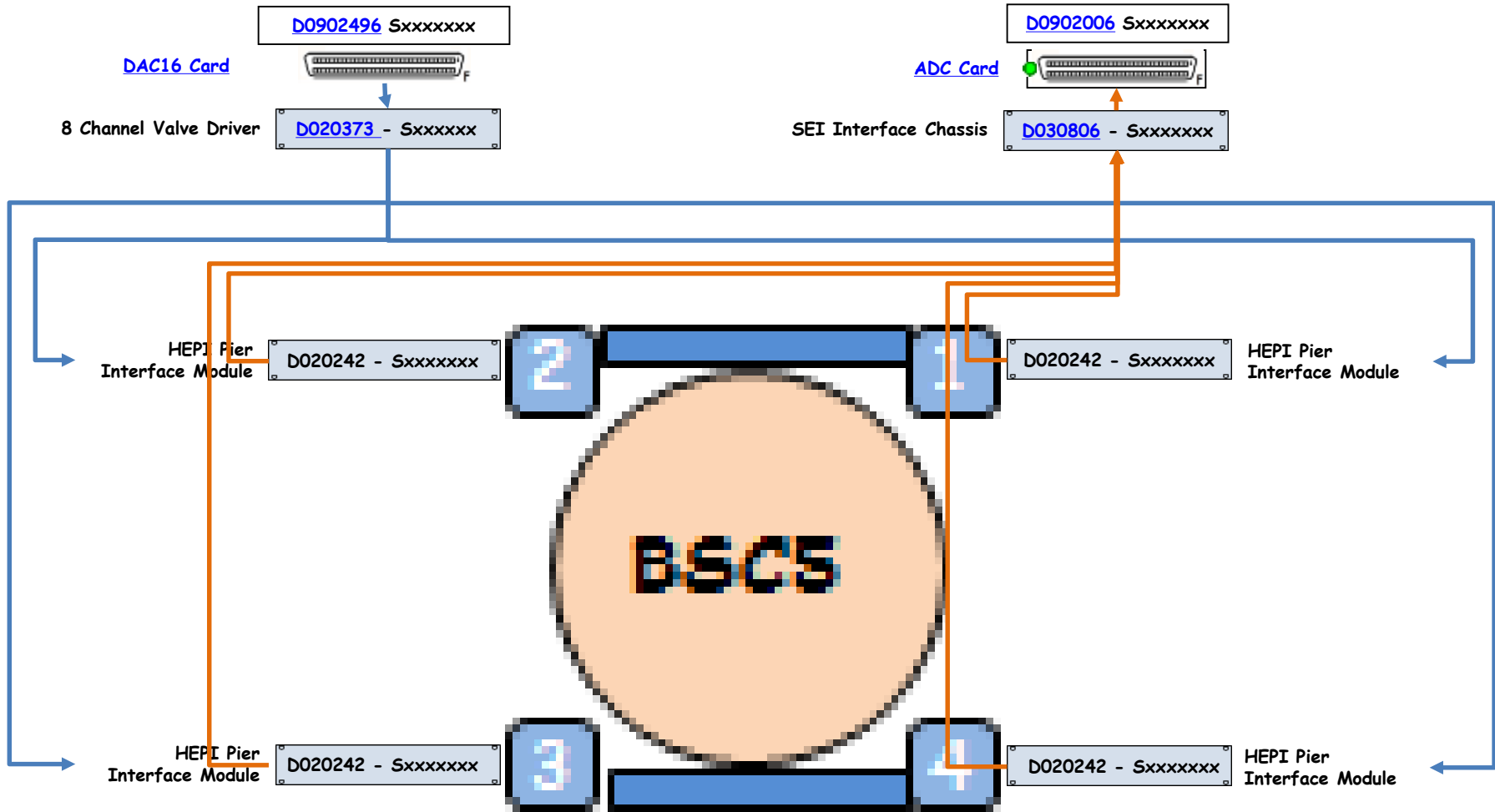

HAM1 Chamber Elements

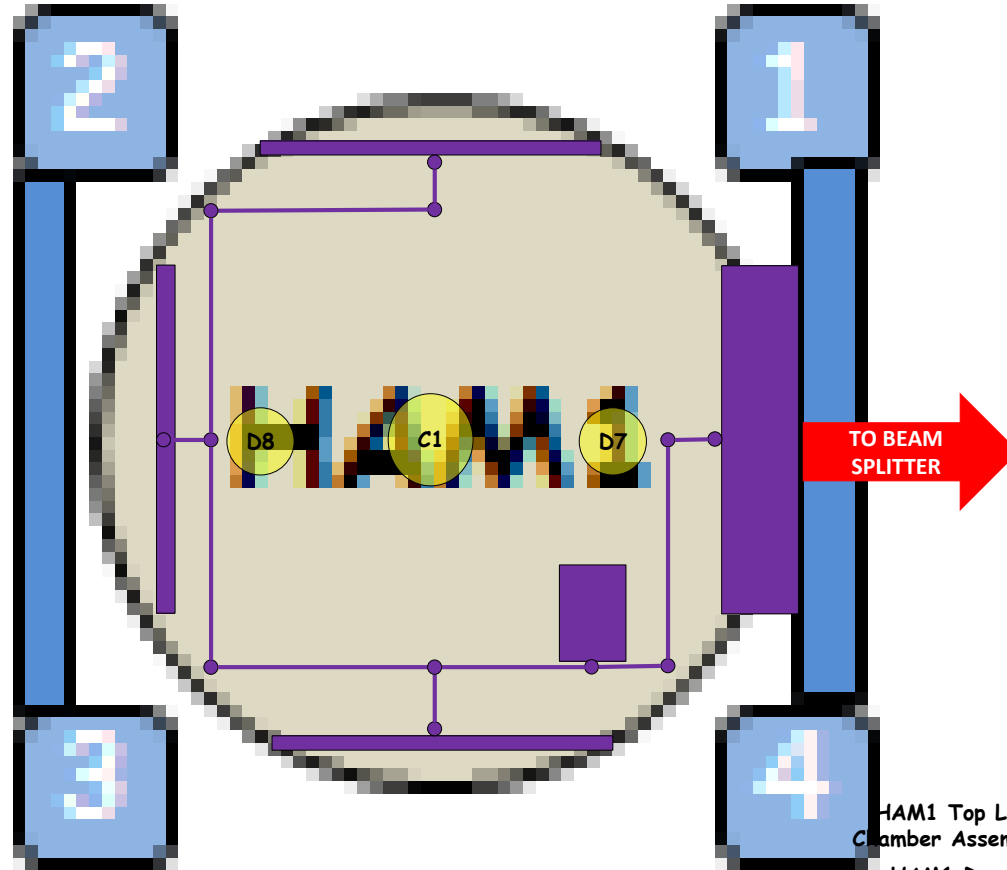

HAM1 Mid-size ION Pump	75IP-HAM1
HAM1 Turbo Pump	75IP-HAM1
HAM1 Scroll Pump	75IP-HAM1

<u>HAM1 Annulus ION Pump</u>	75IP-HAM1
HAM1 Parani Gauge	75IPHAM1
HAM1 Cold Cathode	75IPHAM1

HAM1 Top Level Chamber Assembly	D0901809
HAM1 Drawing	D0901810
<u>HAM1 Viewports</u>	T1000746
<u>HAM1 Flanges</u>	D1002884
<u>HAM1 HEPI</u>	75IP-HAM1
HAM1 CPS	75IP-HAM1

HAM1 Annulus Ion Pump

[<< HAM1 Chamber Elements](#)

HAM1 Annulus ION Pump

[Controller](#)

MiniVac Controller

Model 929-0196
Model 929-0197



Input/Output Interconnections

All input/output signals are accessible at J001 accessory connector. With the provided P001 mating connector - make the connections with AWG 24 (0.2 mm²) - or smaller wire - to the pins indicated in the following figure to obtain the desired capability.

Input signals

Pin 3-7 Remote high voltage ON/OFF or high voltage interlock; requires a permanent closed pin contact.

NOTE

Pin 3-7 must be shorted to allow the high voltage output if no remote/interlock contact is connected.

Output signals

Pin 1-6 Current recorder output 1 (pin 1 signal out, pin 6 ground). The output voltage 0 to + 10 Vdc is proportional to the pump current 0 to 10 mA (e.g. 10 Vdc correspond to 10 mA). The resolution is 10 mV minimum (corresponding to 10 μ A).

The front panel REC. OUT connector is a duplicate of this signal on a BNC connector.

Pin 2-6 Current recorder output 2 (pin 2 signal out, pin 6 ground). The output voltage 0 to + 10 Vdc is proportional to the pump current 0 to 1 mA (e.g. 10 Vdc correspond to 1 mA). The resolution is 10 mV minimum (corresponding to 1 μ A).

Pin 4-8 Voltage recorder output (pin 4 signal out, pin 8 ground). The output voltage 0 to 5 V is proportional to the controller high voltage output 0 to 5 kV (e.g. 1 V corresponds to 1 kV in linear mode).

Pin 5-9 High voltage indication contact. This pure contact (which carries 1 A at 250 Vac and 0.2 A at 30 Vdc) is open when the high voltage is off and closes when the high voltage is on.

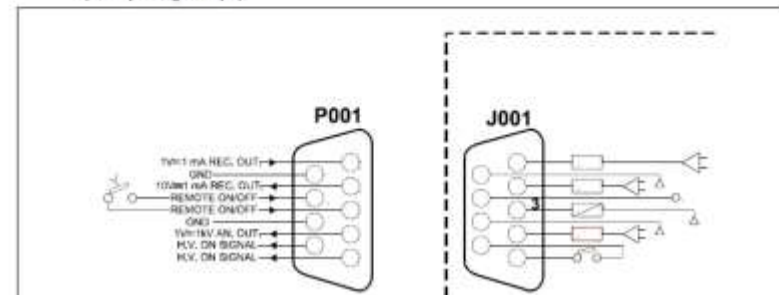

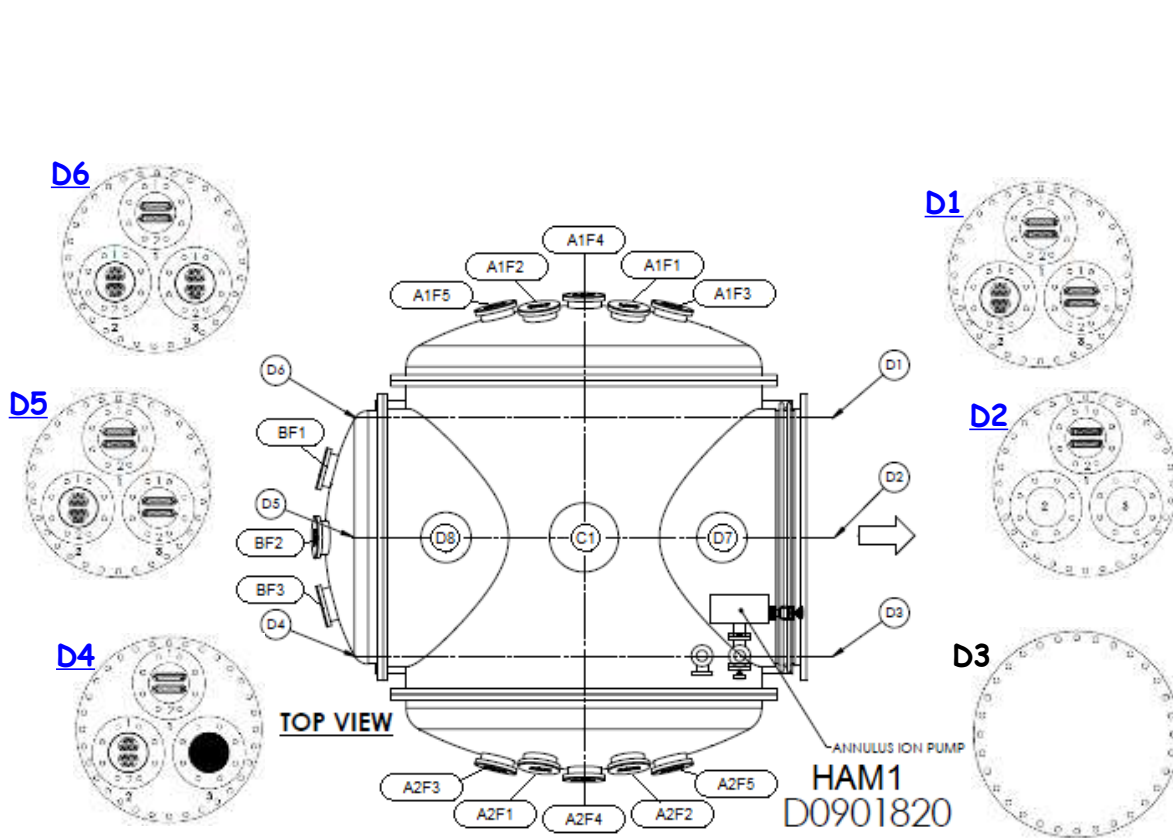

Drawing: [D0901820](#)

Flanges: [D1002884](#)

Viewports: [D1002884](#)

HAM1 D1 Flange

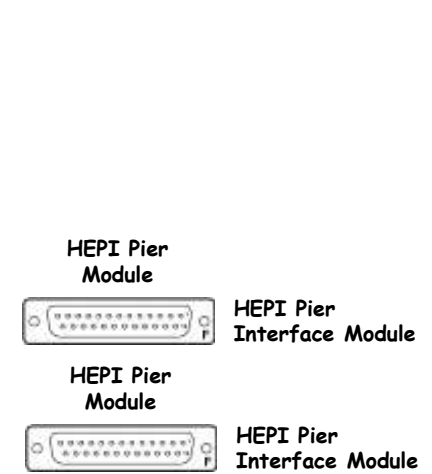
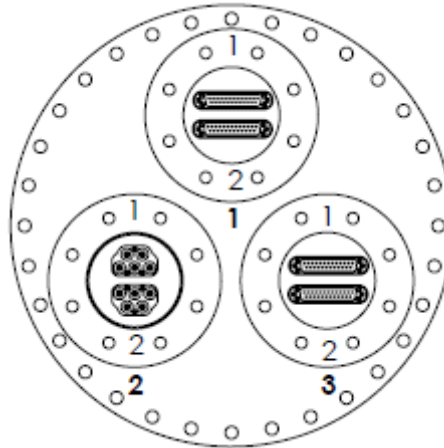

HAM1 D2 Flange

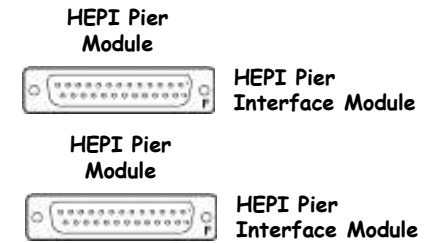
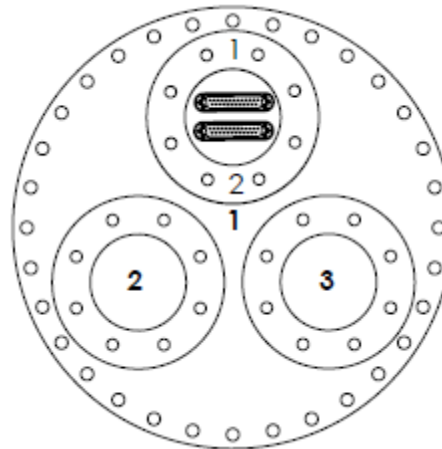

HAM1 D4 Flange

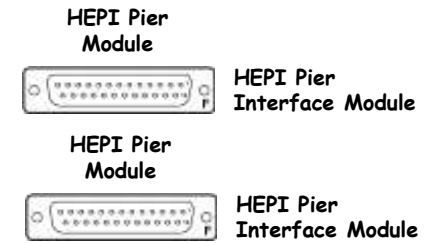
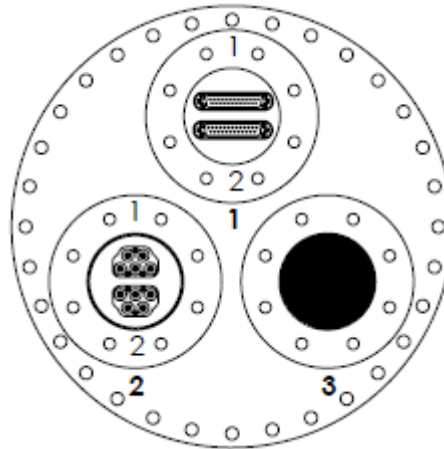

HAM1 D5 Flange

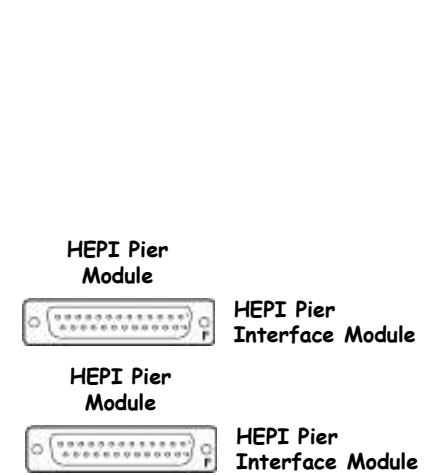
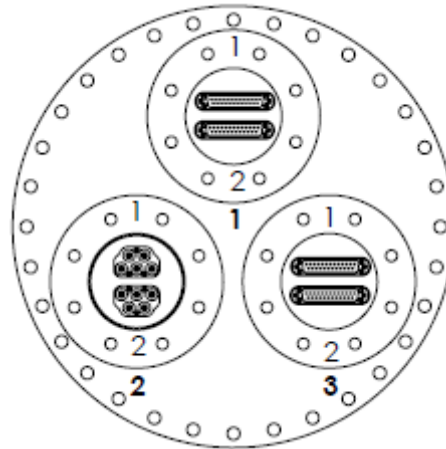

HAM1 D6 Flange

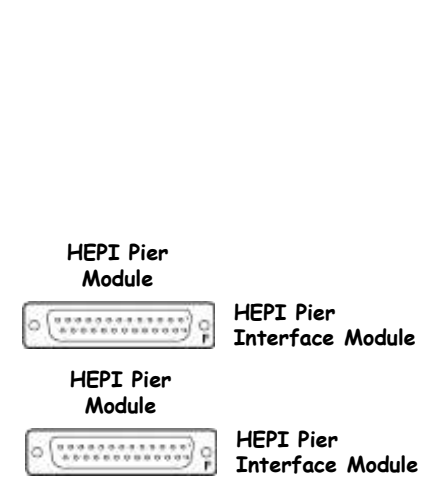
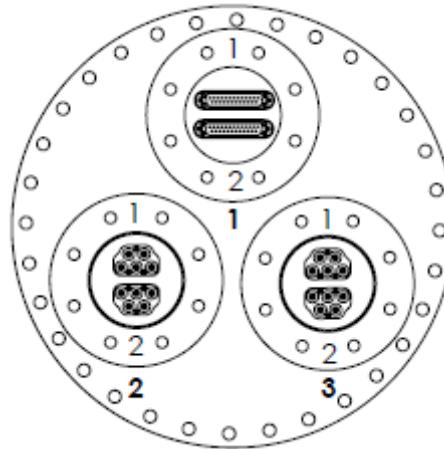

HAM1 Viewports

<< [HAM1 Chamber Elements](#)

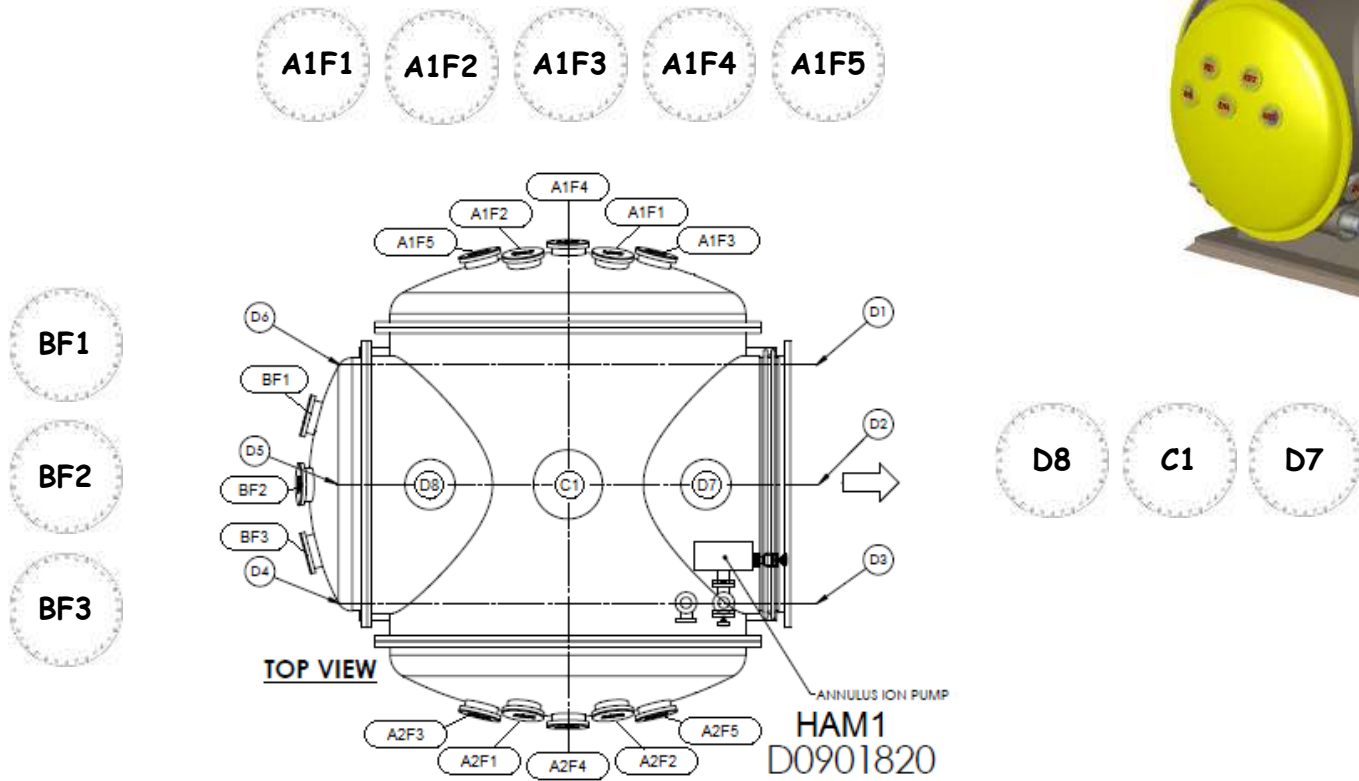

Drawing: [D0901820](#)

Viewports: [T1000746](#)

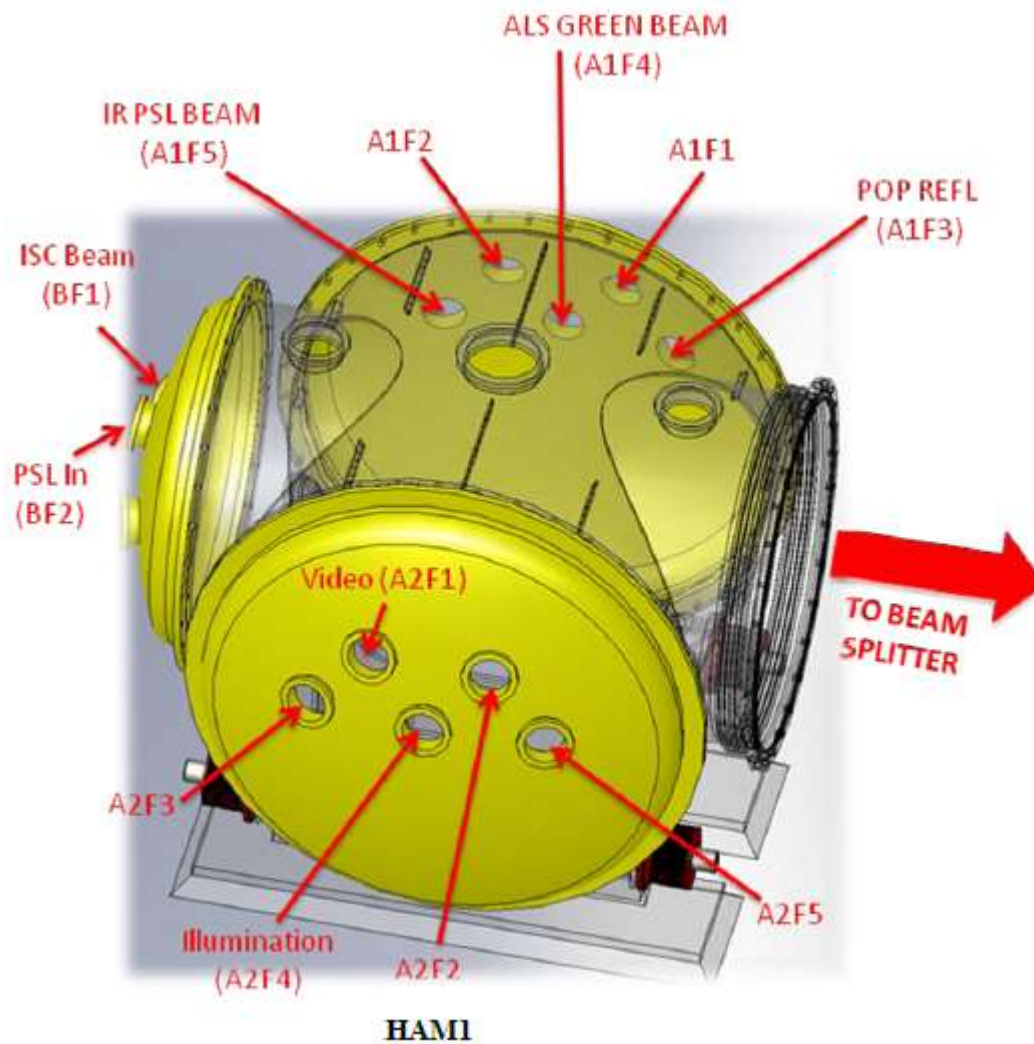

<< HAM1 Chamber Elements

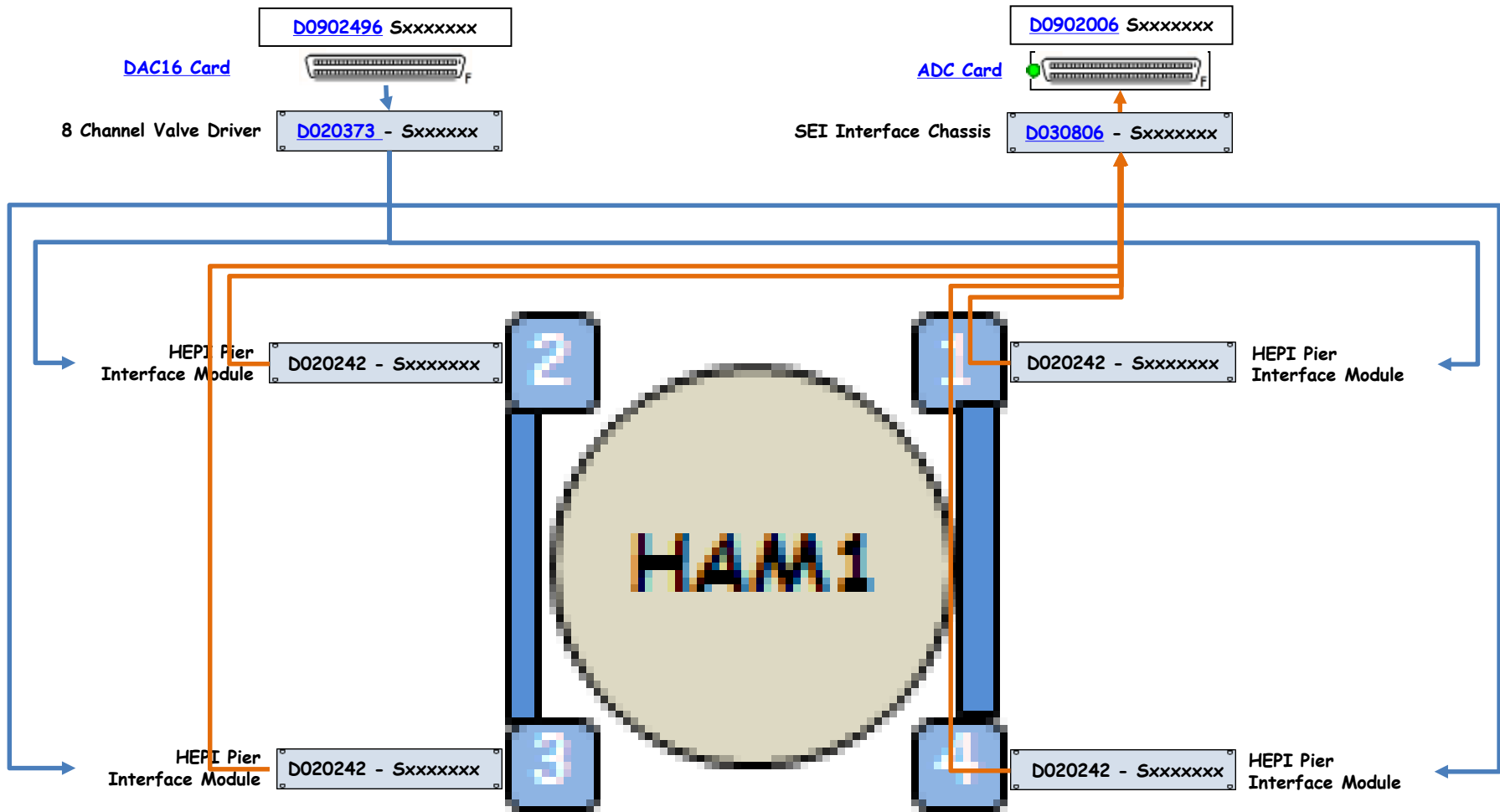

HAM2 Chamber Elements

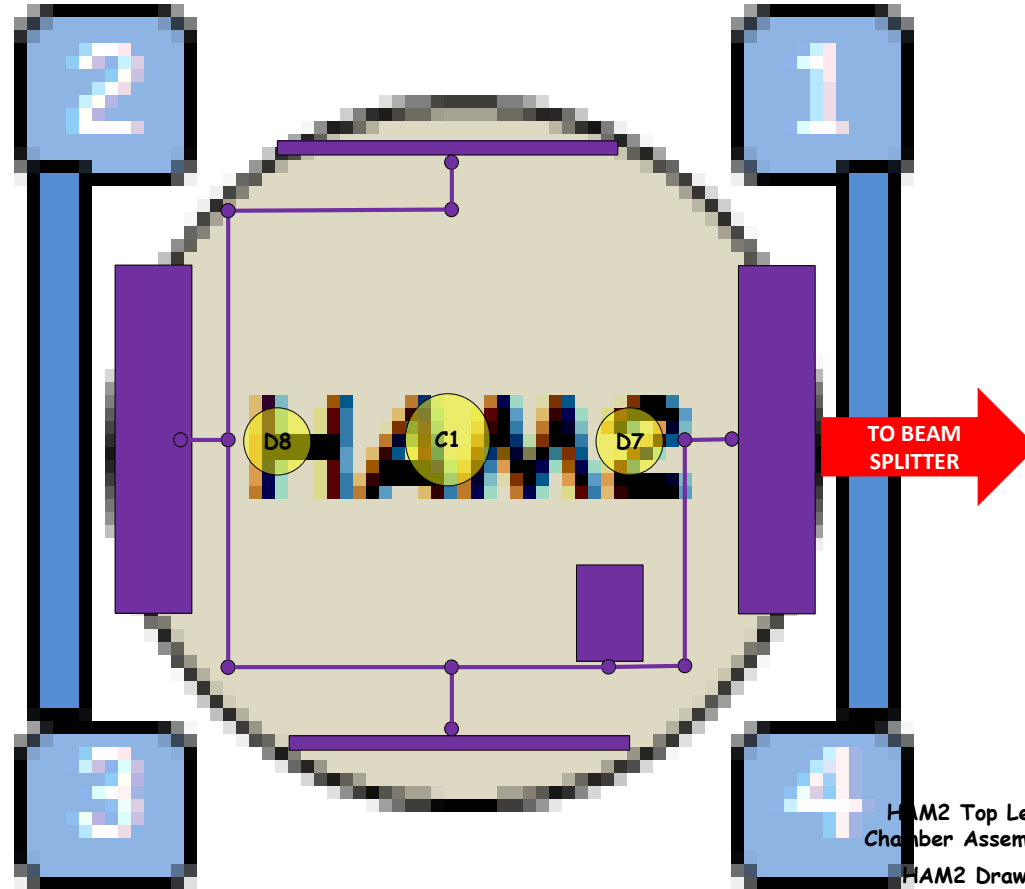

HAM2 Mid-size ION Pump

75IP-HAM2

HAM2 Turbo Pump

75IP-HAM2

HAM2 Scroll Pump

75IP-HAM2

HAM2 Annulus ION Pump

75IP-HAM2

HAM2 Parani Gauge

75IPHAM2

HAM2 Cold Cathode

75IPHAM2

HAM2 Top Level Chamber Assembly

D0900365

HAM2 Drawing

D0900366

HAM2 Viewports

T1000746

HAM2 Flanges

D1002885

HAM2 HEPI

75IP-HAM2

HAM2 CPS

75IP-HAM2

HAM2 Annulus Ion Pump

[<< HAM2 Chamber Elements](#)

HAM2 Annulus ION Pump

[Controller](#)

MiniVac Controller

Model 929-0196
Model 929-0197



Input/Output Interconnections

All input/output signals are accessible at J001 accessory connector. With the provided P001 mating connector, make the connections with AWG 24 (0.2 mm²) - or smaller wire - to the pins indicated in the following figure to obtain the desired capability.

Input signals

Pin 3-7 Remote high voltage ON/OFF or high voltage interlock; requires a permanent closed pin contact.

NOTE

Pin 3-7 must be shorted to allow the high voltage output if no remote/interlock contact is connected.

Output signals

Pin 1-6 Current recorder output 1 (pin 1 signal out, pin 6 ground). The output voltage 0 to + 10 Vdc is proportional to the pump current 0 to 10 mA (e.g. 10 Vdc correspond to 10 mA). The resolution is 10 mV minimum (corresponding to 10 μ A).

The front panel REC. OUT connector is a duplicate of this signal on a BNC connector.

Pin 2-6 Current recorder output 2 (pin 2 signal out, pin 6 ground). The output voltage 0 to + 10 Vdc is proportional to the pump current 0 to 1 mA (e.g. 10 Vdc correspond to 1 mA). The resolution is 10 mV minimum (corresponding to 1 μ A).

Pin 4-8 Voltage recorder output (pin 4 signal out, pin 8 ground). The output voltage 0 to 5 V is proportional to the controller high voltage output 0 to 5 kV (e.g. 1 V corresponds to 1 kV in linear mode).

Pin 5-9 High voltage indication contact. This pure contact (which carries 1 A at 250 Vac and 0.2 A at 30 Vdc) is open when the high voltage is off and closes when the high voltage is on.

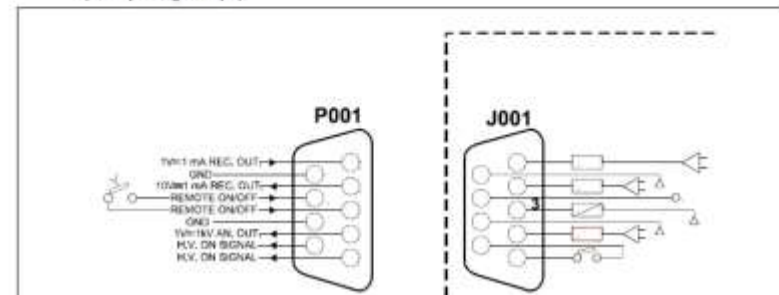

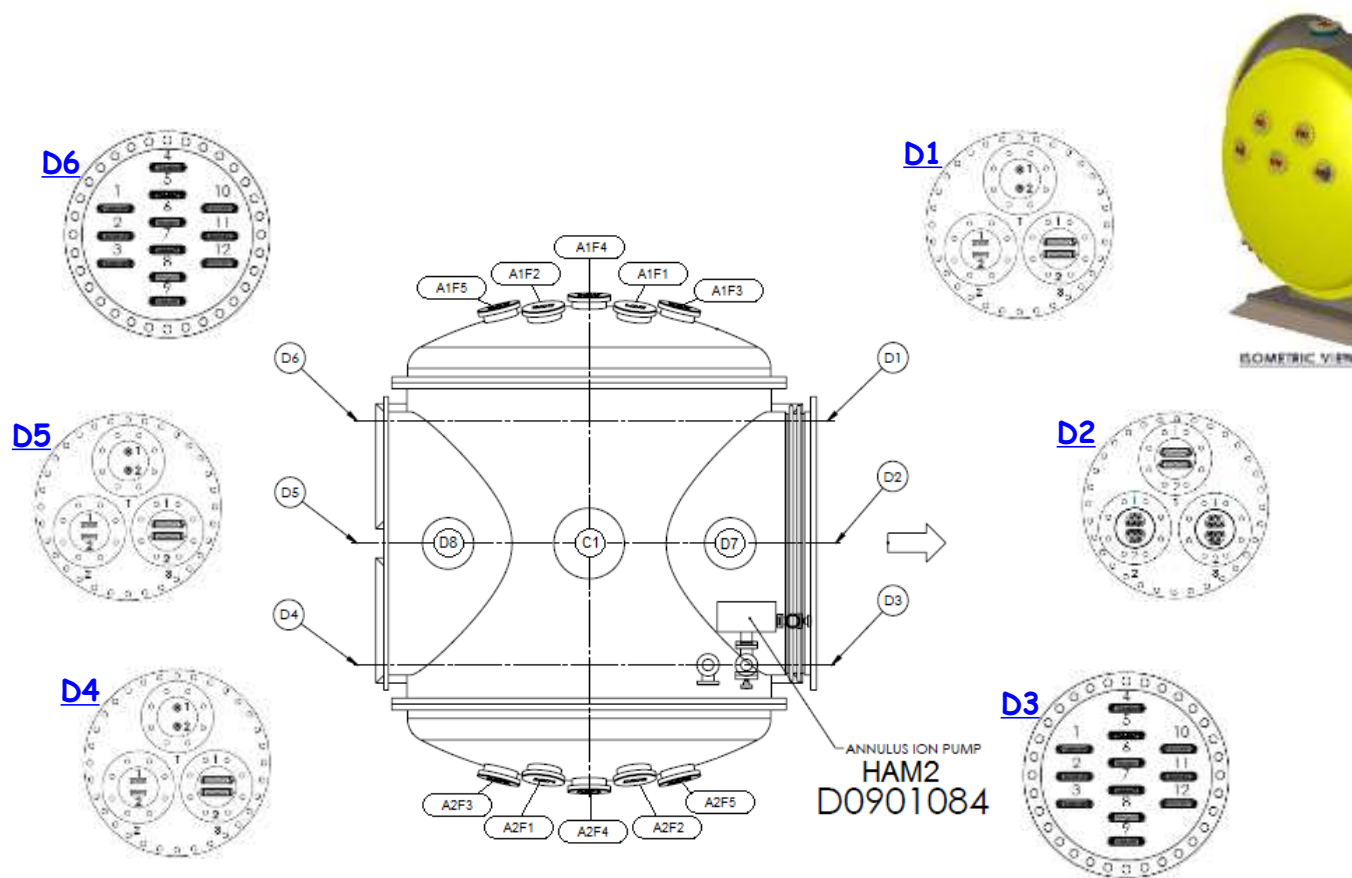

Drawing: [D0901084](#)
Flanges: [D1002885](#)

HAM2 D1 Flange

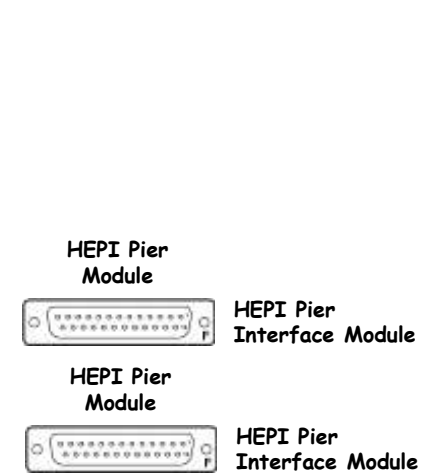
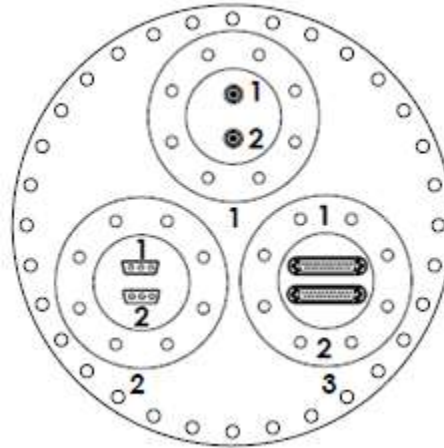

HAM2 D2 Flange

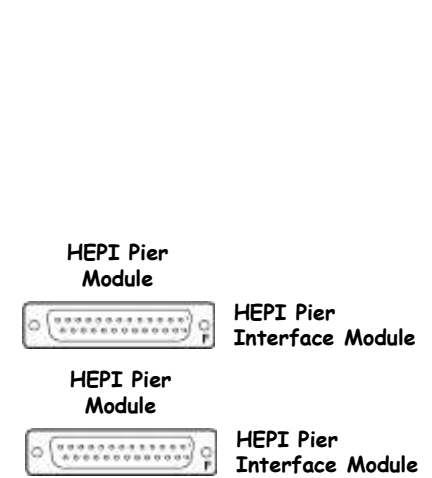
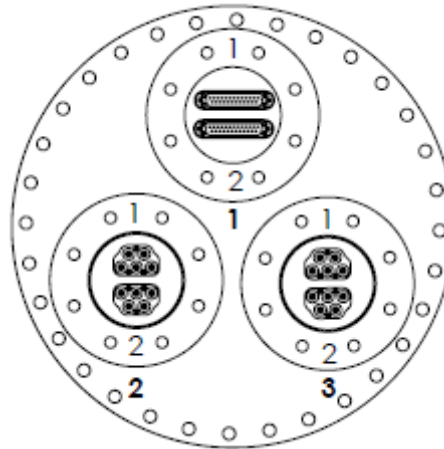

HAM2 D3 Flange

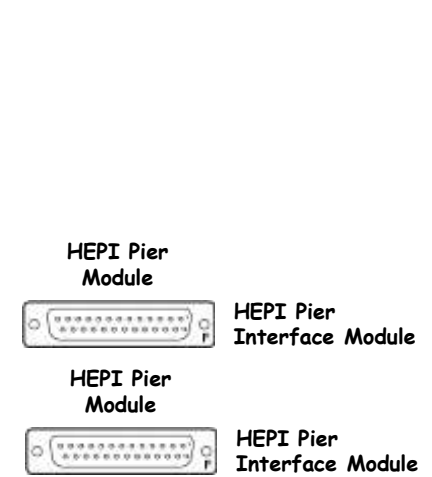
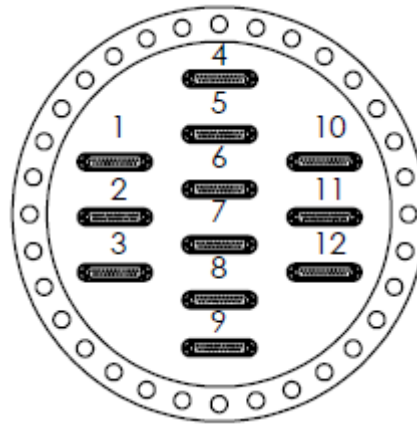

HAM2 D4 Flange

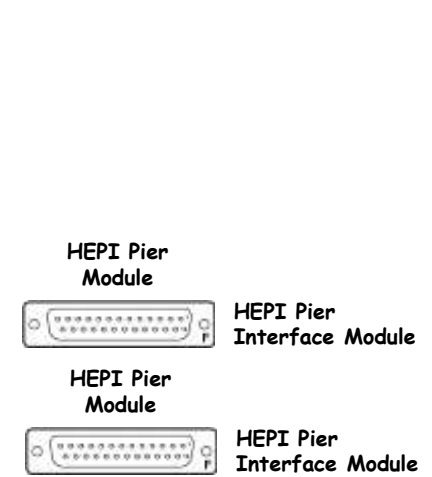
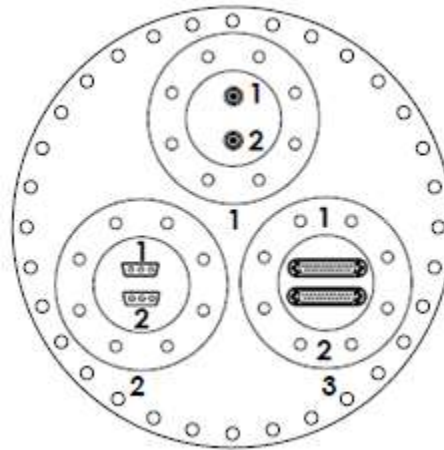

HAM2 D5 Flange

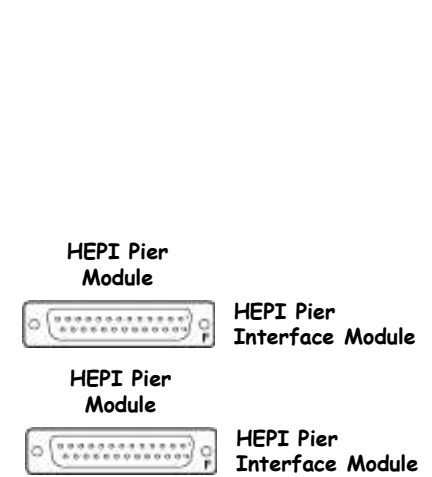
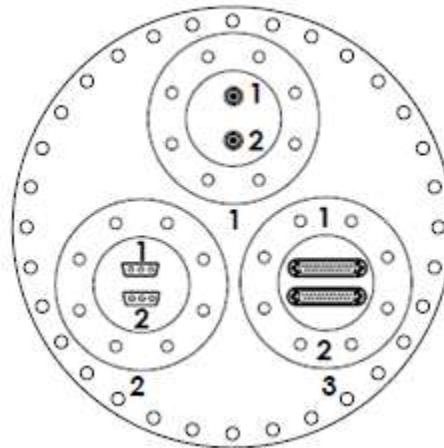

HAM2 D6 Flange

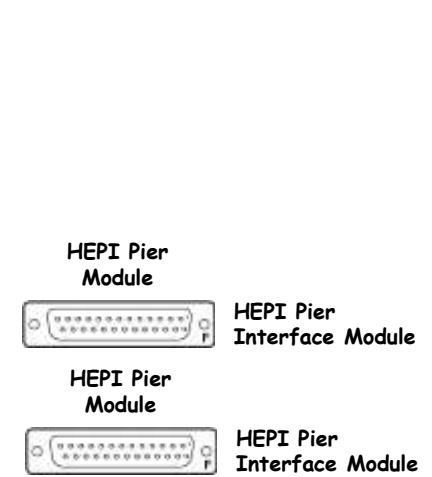
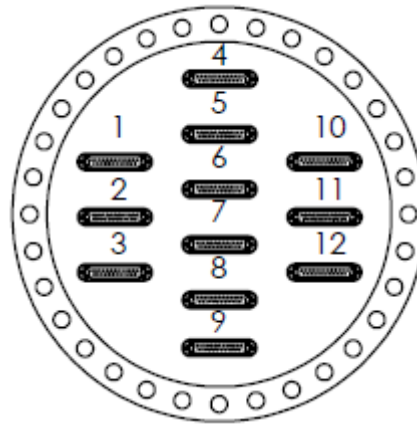

HAM2 Viewports

<< [HAM2 Chamber Elements](#)

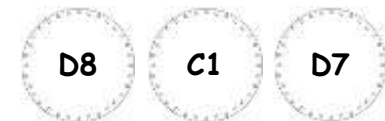
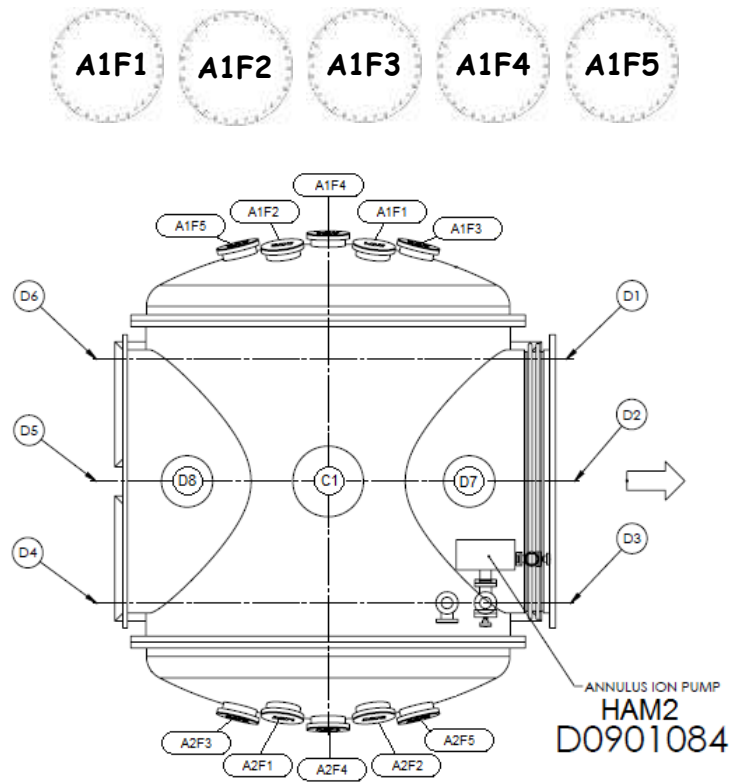

Drawing: [D0901084](#)
Viewports: [T1000746](#)



<< HAM2 Chamber Elements

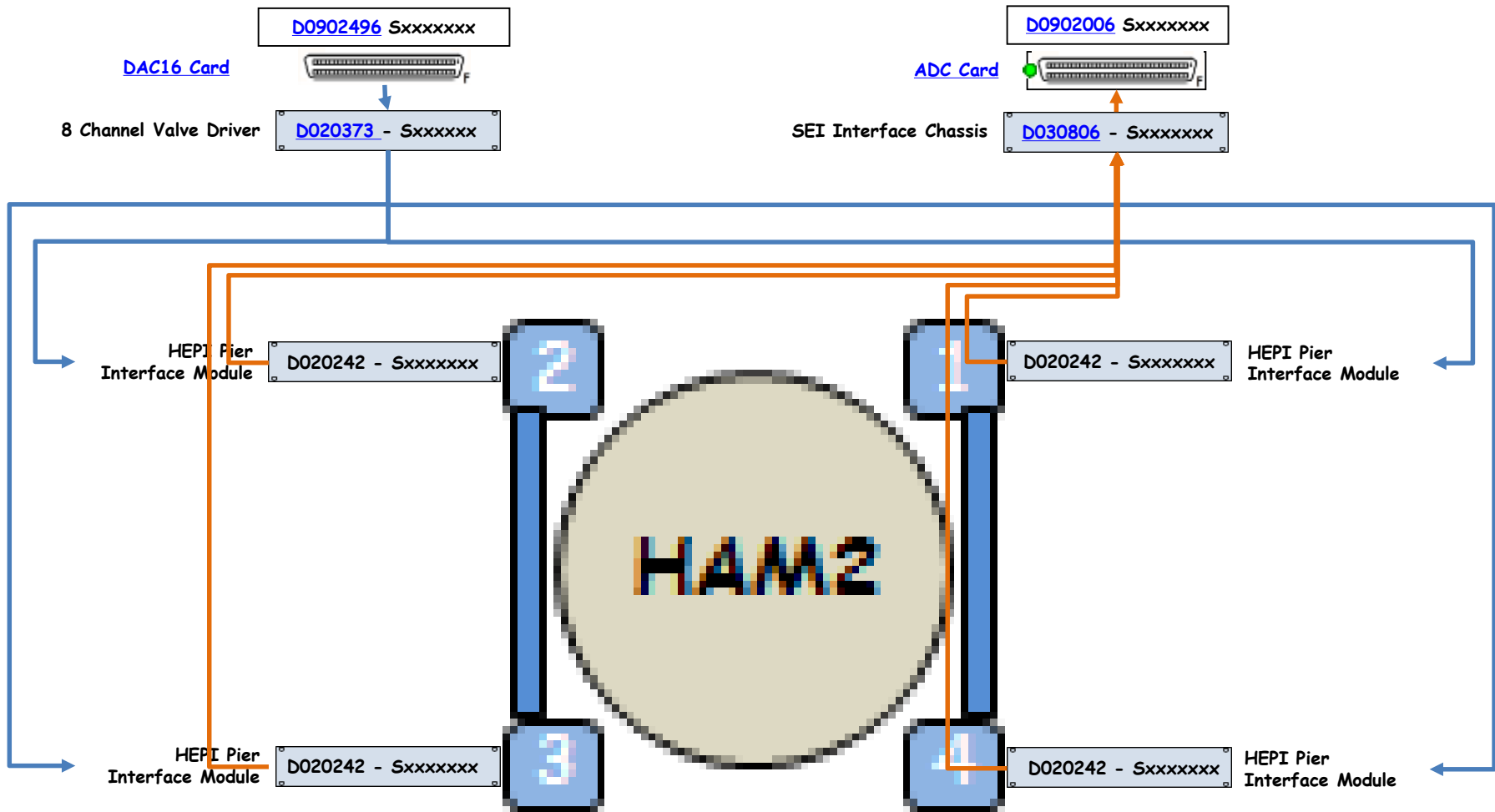

HAM3 Chamber Elements

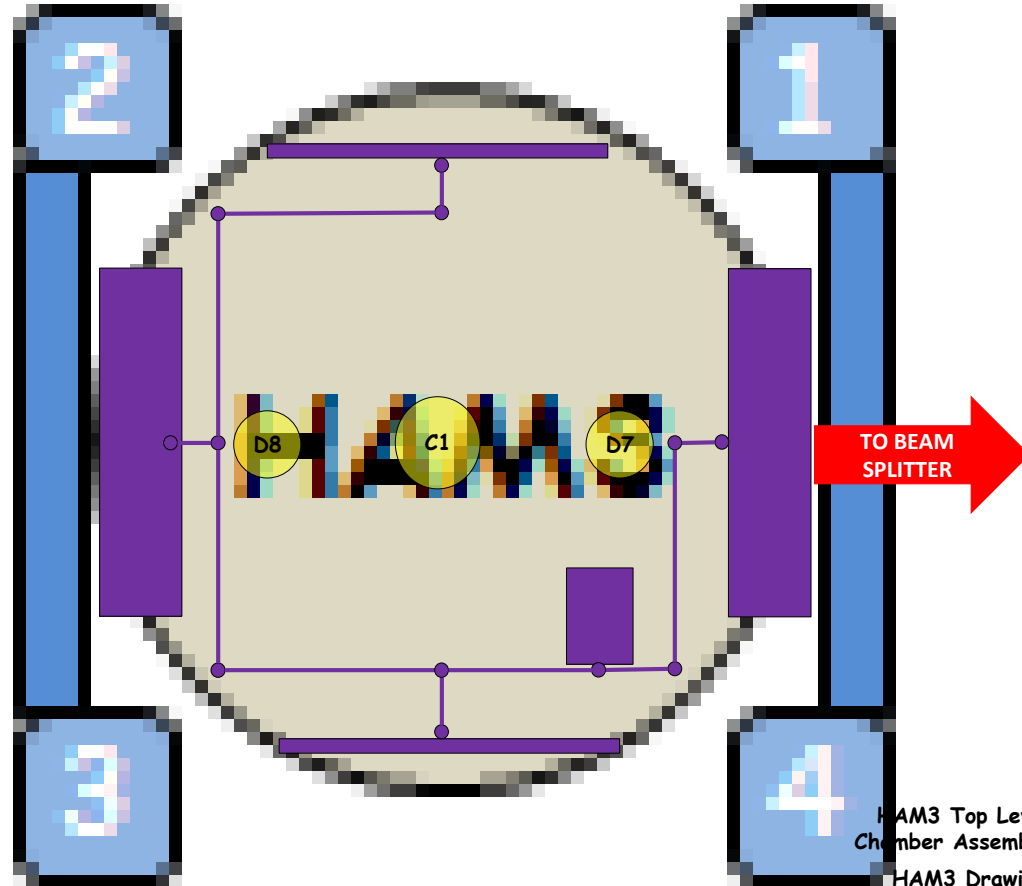

HAM3 Mid-size ION Pump

75IP-HAM3
75IP-HAM3
75IP-HAM3

HAM3 Turbo Pump

HAM3 Scroll Pump

HAM3 Annulus ION Pump

HAM3 Parani Gauge

HAM3 Cold Cathode

75IP-HAM3
75IPHAM3
75IPHAM3

HAM3 Top Level Chamber Assembly

HAM3 Drawing

HAM3 Viewports

HAM3 Flanges

HAM3 HEPI

HAM3 CPS

D0900520
D0900521
T1000746
D1002886
75IP-HAM3
75IP-HAM3

HAM3 Annulus Ion Pump

[<< HAM3 Chamber Elements](#)

HAM3 Annulus ION Pump

[Controller](#)

MiniVac Controller

Model 929-0196
Model 929-0197



Input/Output Interconnections

All input/output signals are accessible at J001 accessory connector. With the provided P001 mating connector, make the connections with AWG 24 (0.2 mm²) - or smaller wire - to the pins indicated in the following figure to obtain the desired capability.

Input signals

Pin 3-7 Remote high voltage ON/OFF or high voltage interlock; requires a permanent closed pin contact.

NOTE

Pin 3-7 must be shorted to allow the high voltage output if no remote/interlock contact is connected.

Output signals

Pin 1-6 Current recorder output 1 (pin 1 signal out, pin 6 ground). The output voltage 0 to + 10 Vdc is proportional to the pump current 0 to 10 mA (e.g. 10 Vdc correspond to 10 mA). The resolution is 10 mV minimum (corresponding to 10 μ A).

The front panel REC. OUT connector is a duplicate of this signal on a BNC connector.

Pin 2-6 Current recorder output 2 (pin 2 signal out, pin 6 ground). The output voltage 0 to + 10 Vdc is proportional to the pump current 0 to 1 mA (e.g. 10 Vdc correspond to 1 mA). The resolution is 10 mV minimum (corresponding to 1 μ A).

Pin 4-8 Voltage recorder output (pin 4 signal out, pin 8 ground). The output voltage 0 to 5 V is proportional to the controller high voltage output 0 to 5 kV (e.g. 1 V corresponds to 1 kV in linear mode).

Pin 5-9 High voltage indication contact. This pure contact (which carries 1 A at 250 Vac and 0.2 A at 30 Vdc) is open when the high voltage is off and closes when the high voltage is on.

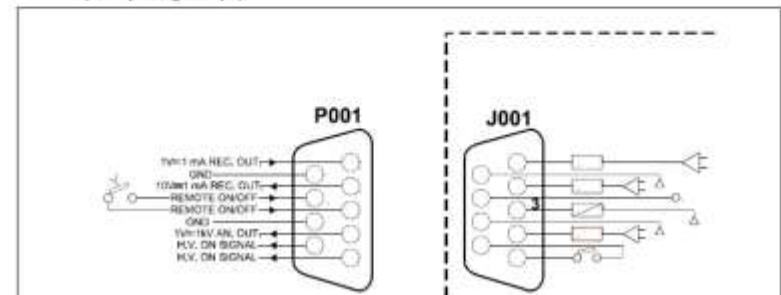

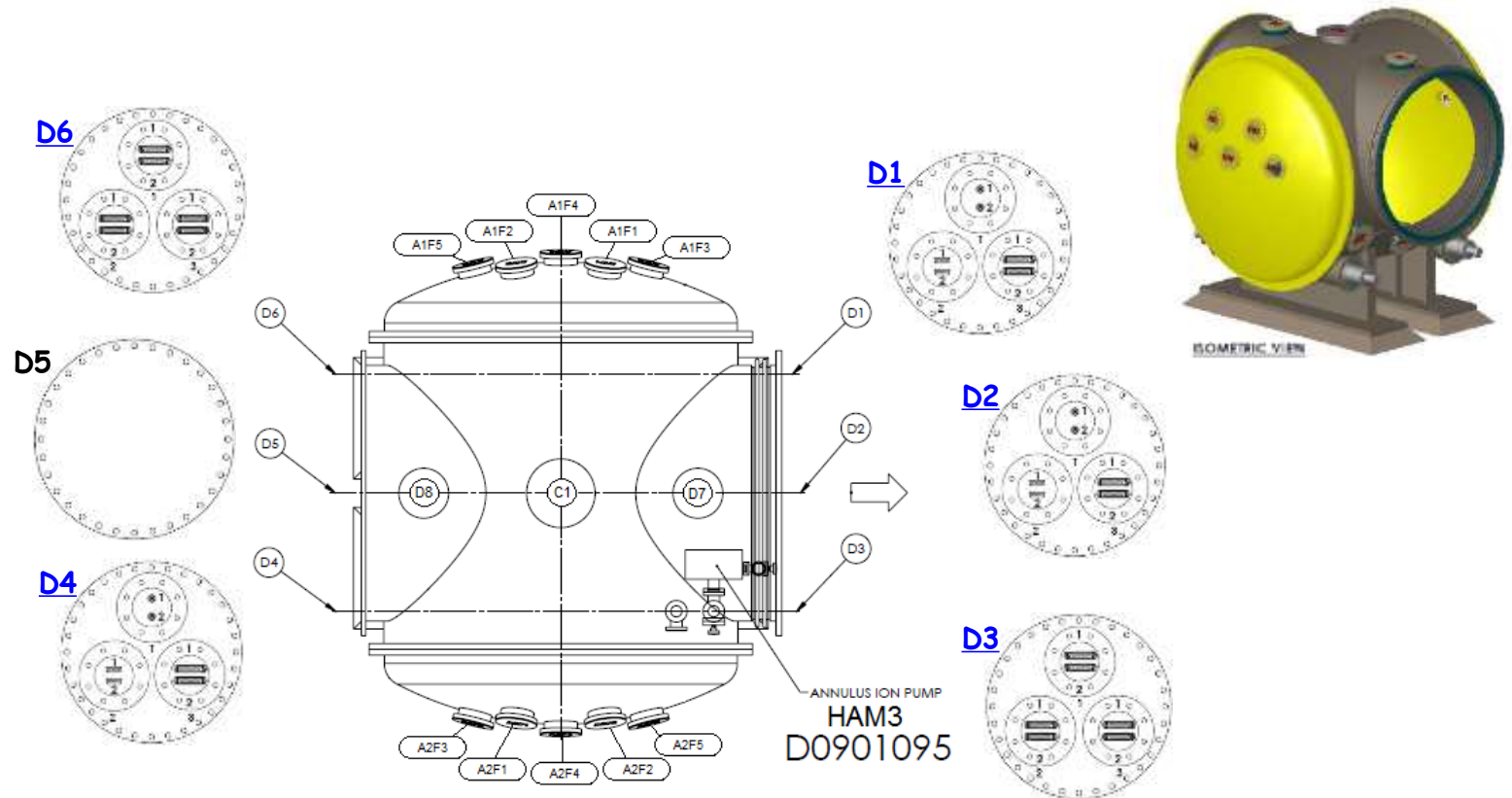

Drawing: [D0901095](#)
Flanges: [D1002886](#)

HAM3 D1 Flange

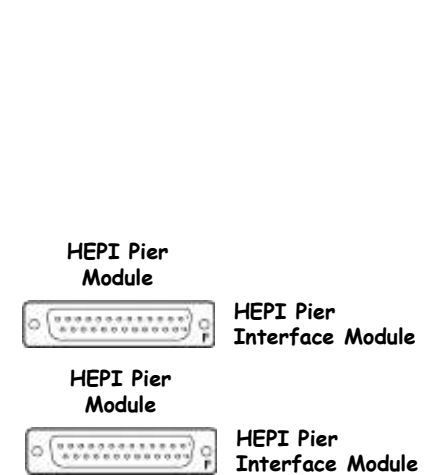
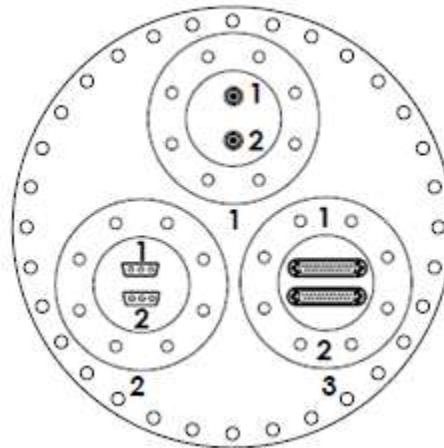

HAM3 D2 Flange

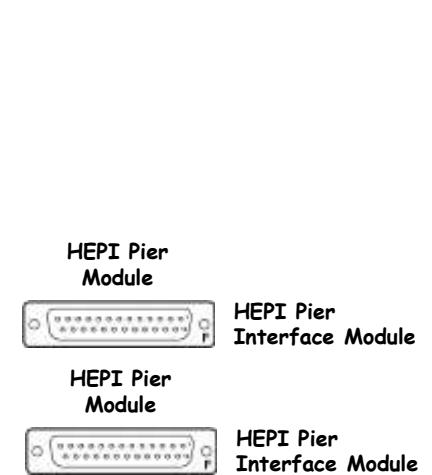
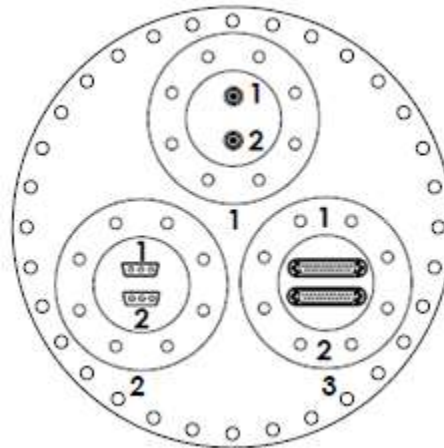

HAM3 D3 Flange

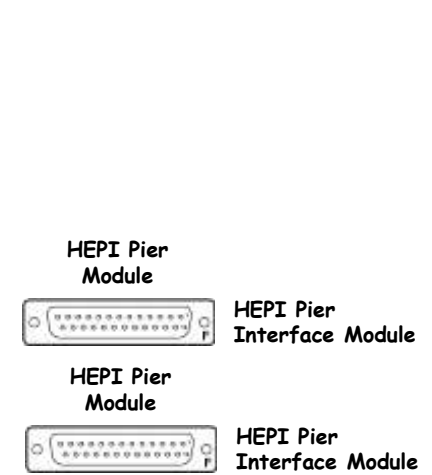
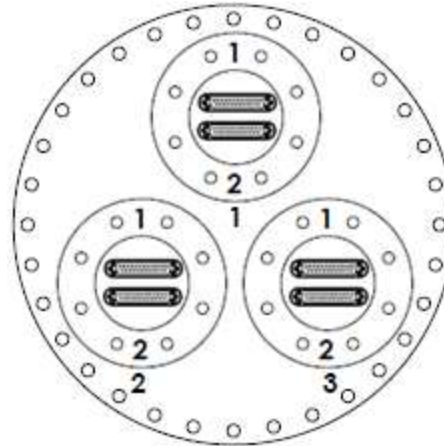

HAM3 D4 Flange

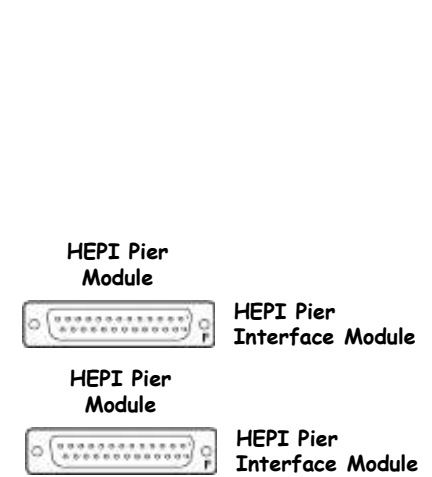
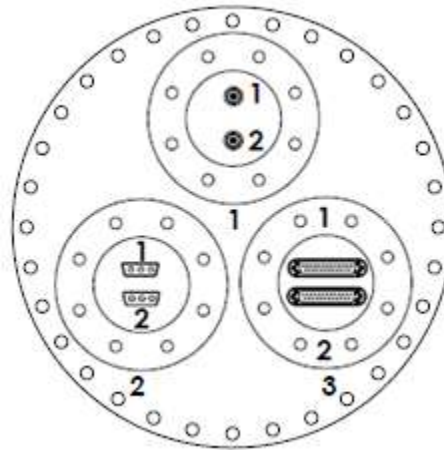

HAM3 D6 Flange

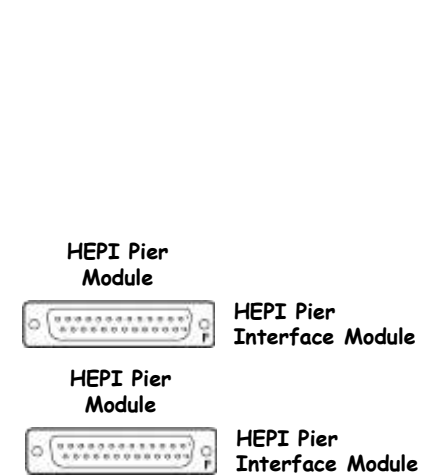
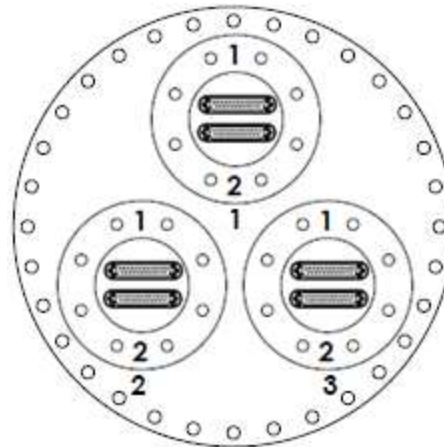

HAM3 Viewports

<< [HAM3 Chamber Elements](#)

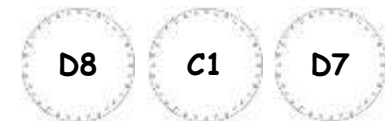
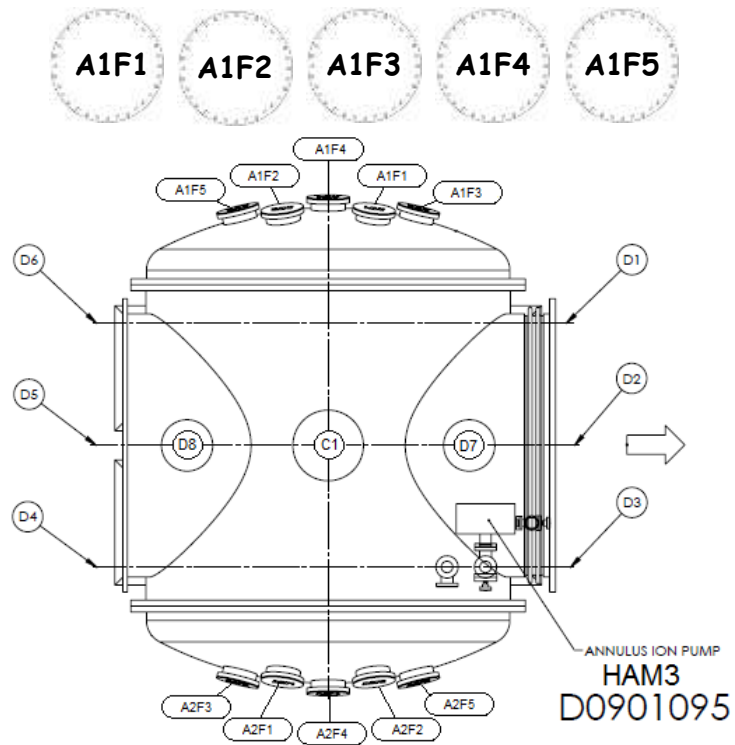

Drawing: [D0901095](#)
Viewports: [T1000746](#)



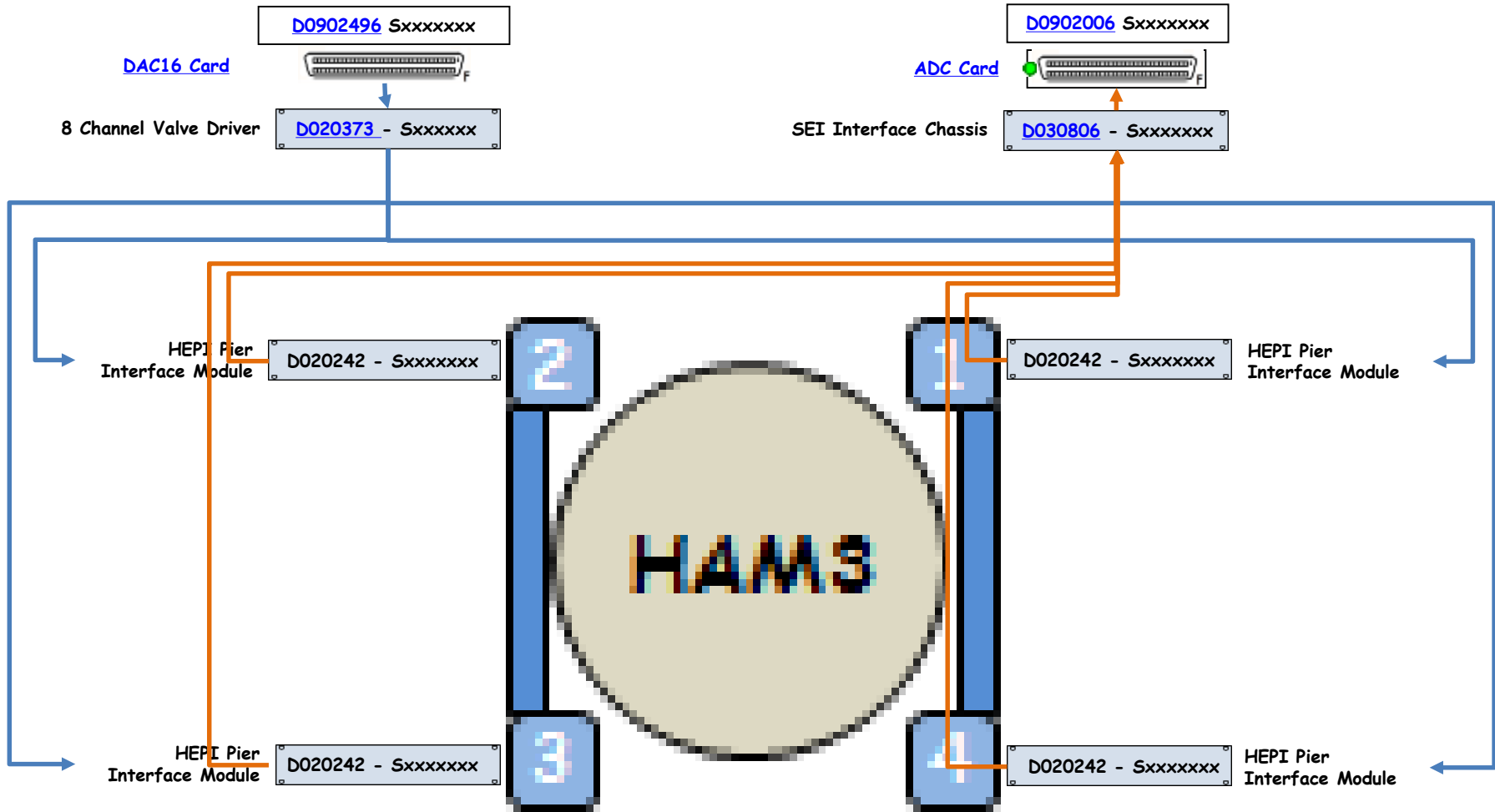

HAM4 Chamber Elements

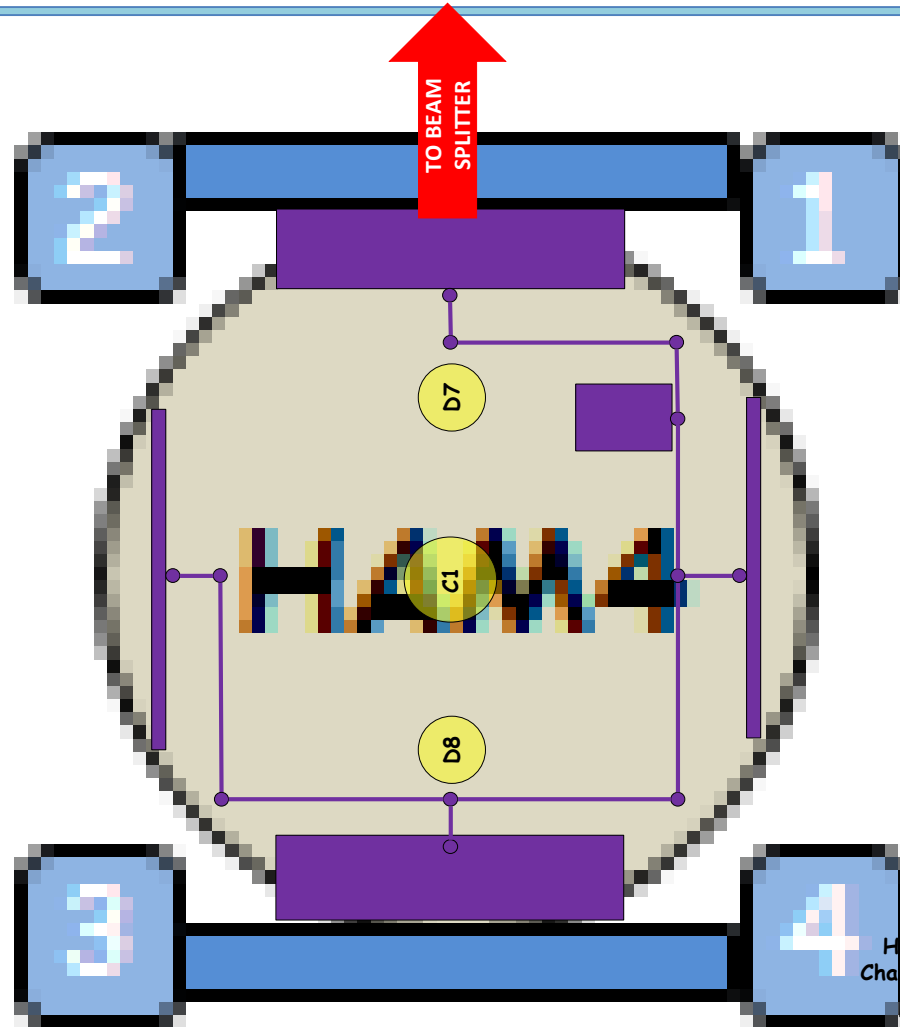

HAM4 Mid-size ION Pump

75IP-HAM4

HAM4 Turbo Pump

75IP-HAM4

HAM4 Scroll Pump

75IP-HAM4

HAM4 Annulus ION Pump

75IP-HAM4

HAM4 Parani Gauge

75IPHAM4

HAM4 Cold Cathode

75IPHAM4

HAM4 Top Level Chamber Assembly

[D0900421](#)

HAM4 Drawing

[D0900422](#)

HAM4 Viewports

[T1000746](#)

HAM4 Flanges

[D1002887](#)

HAM4 HEPI

75IP-HAM4

HAM4 CPS

75IP-HAM4

HAM4 Annulus Ion Pump

[<< HAM4 Chamber Elements](#)

HAM4 Annulus ION Pump

[Controller](#)

MiniVac Controller

Model 929-0196
Model 929-0197



Input/Output Interconnections

All input/output signals are accessible at J001 accessory connector. With the provided P001 mating connector, make the connections with AWG 24 (0.2 mm²) - or smaller wire - to the pins indicated in the following figure to obtain the desired capability.

Input signals

Pin 3-7 Remote high voltage ON/OFF or high voltage interlock; requires a permanent closed pin contact.

NOTE

Pin 3-7 must be shorted to allow the high voltage output if no remote/interlock contact is connected.

Output signals

Pin 1-6 Current recorder output 1 (pin 1 signal out, pin 6 ground). The output voltage 0 to + 10 Vdc is proportional to the pump current 0 to 10 mA (e.g. 10 Vdc correspond to 10 mA). The resolution is 10 mV minimum (corresponding to 10 μ A).

The front panel REC. OUT connector is a duplicate of this signal on a BNC connector.

Pin 2-6 Current recorder output 2 (pin 2 signal out, pin 6 ground). The output voltage 0 to + 10 Vdc is proportional to the pump current 0 to 1 mA (e.g. 10 Vdc correspond to 1 mA). The resolution is 10 mV minimum (corresponding to 1 μ A).

Pin 4-8 Voltage recorder output (pin 4 signal out, pin 8 ground). The output voltage 0 to 5 V is proportional to the controller high voltage output 0 to 5 kV (e.g. 1 V corresponds to 1 kV in linear mode).

Pin 5-9 High voltage indication contact. This pure contact (which carries 1 A at 250 Vac and 0.2 A at 30 Vdc) is open when the high voltage is off and closes when the high voltage is on.

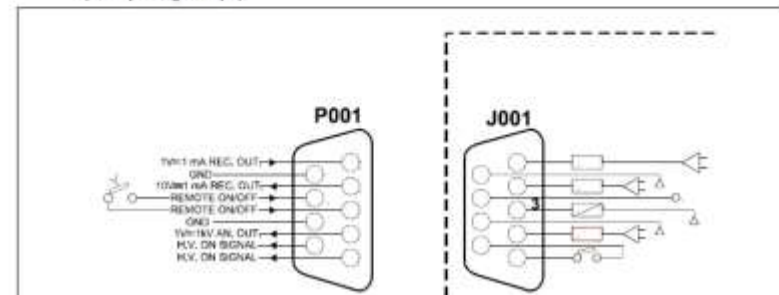

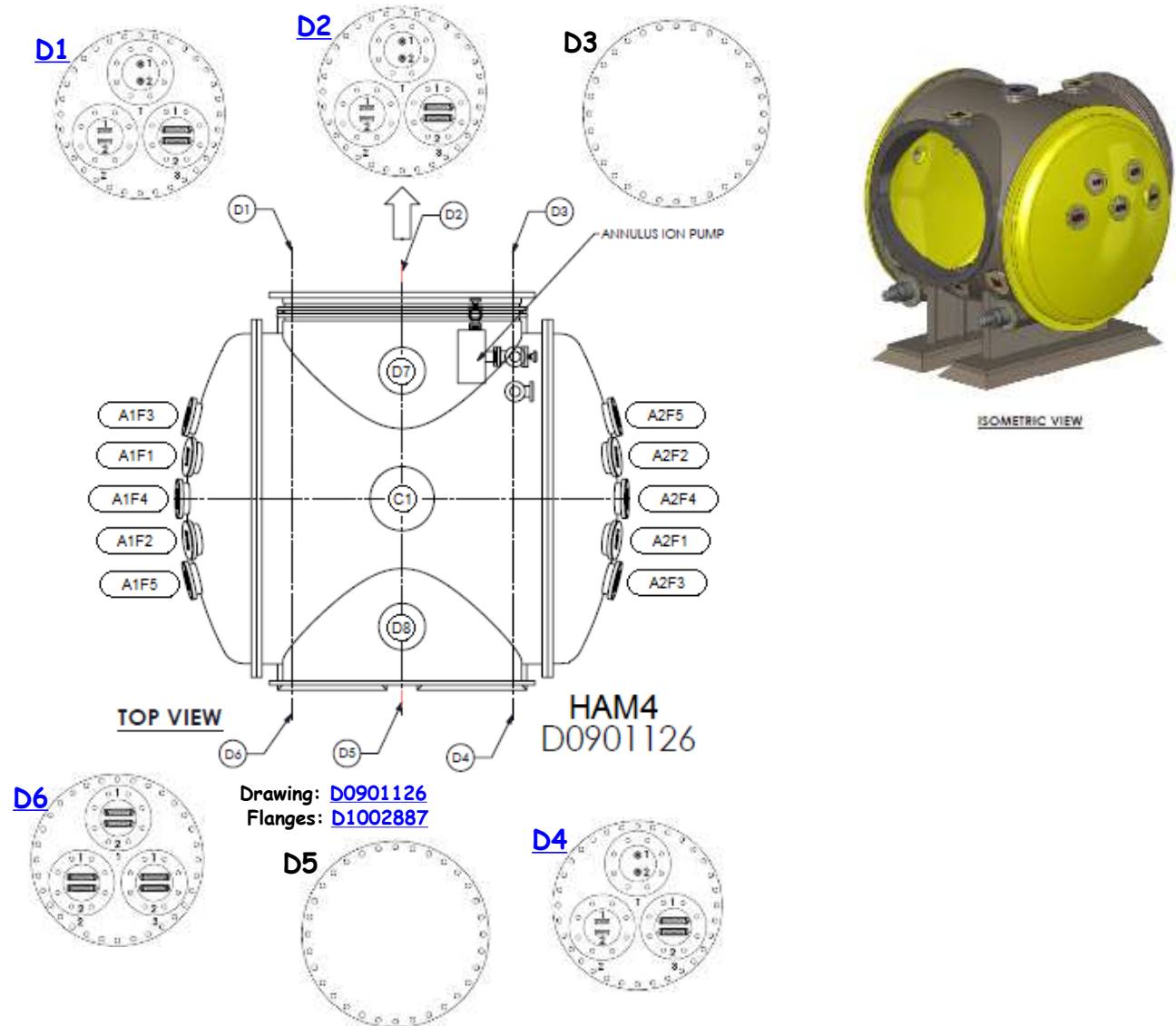

HAM4 D1 Flange

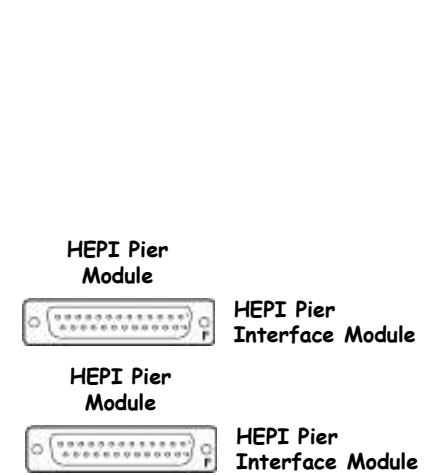
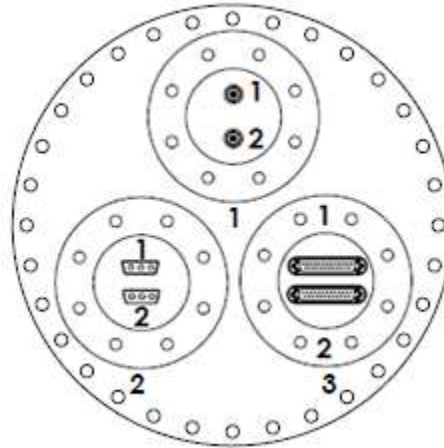

HAM4 D2 Flange

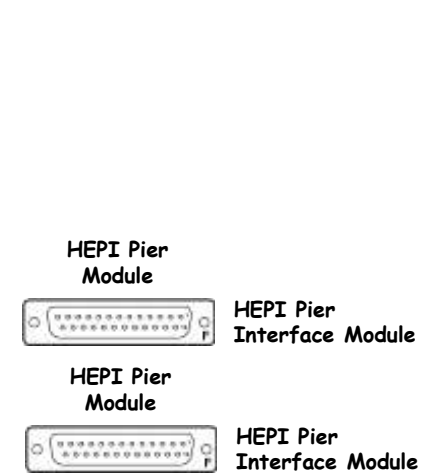
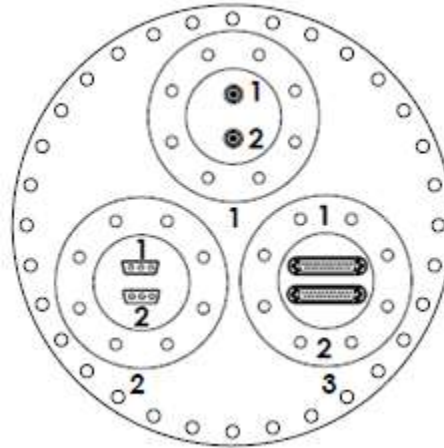

HAM4 D4 Flange

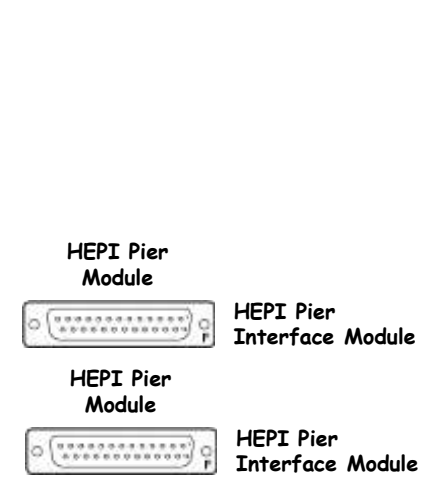
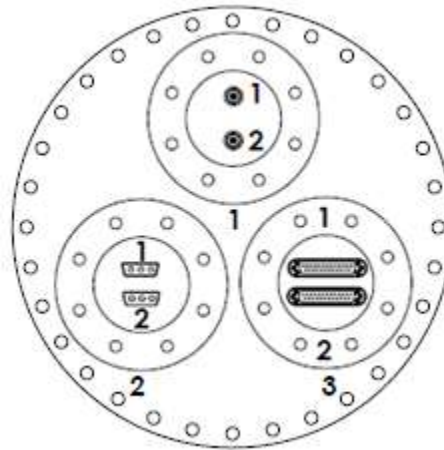

HAM4 D6 Flange

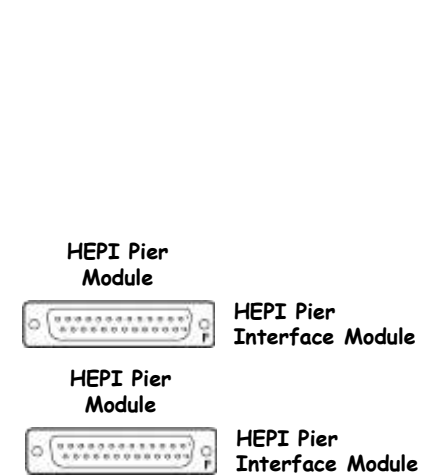
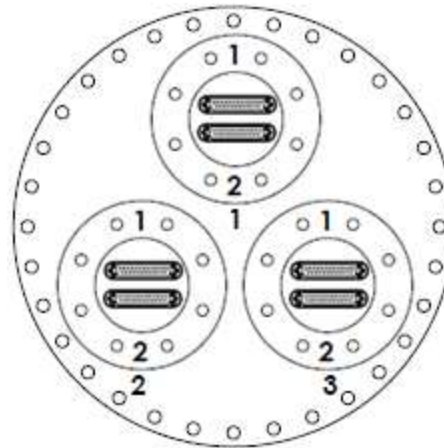

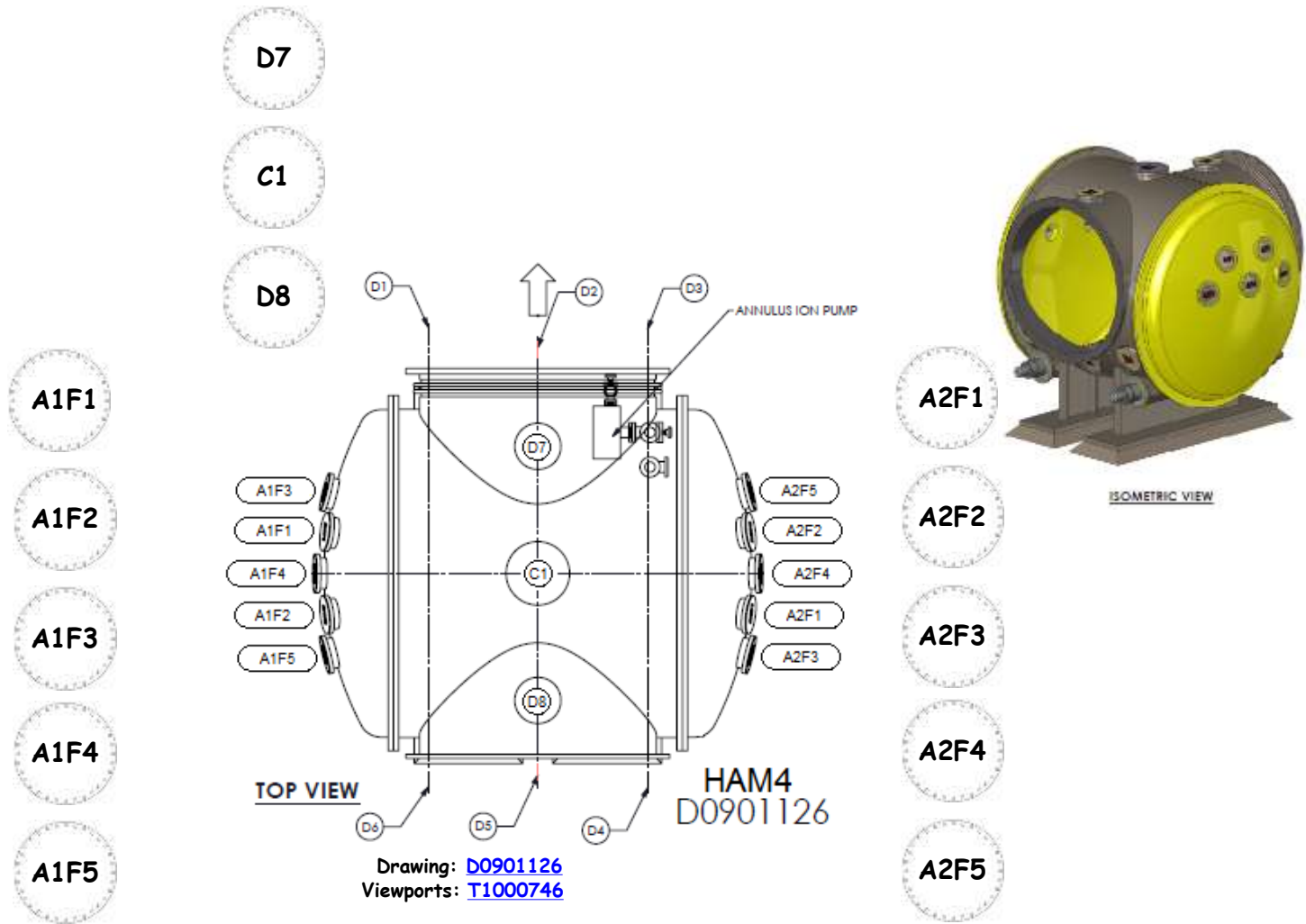

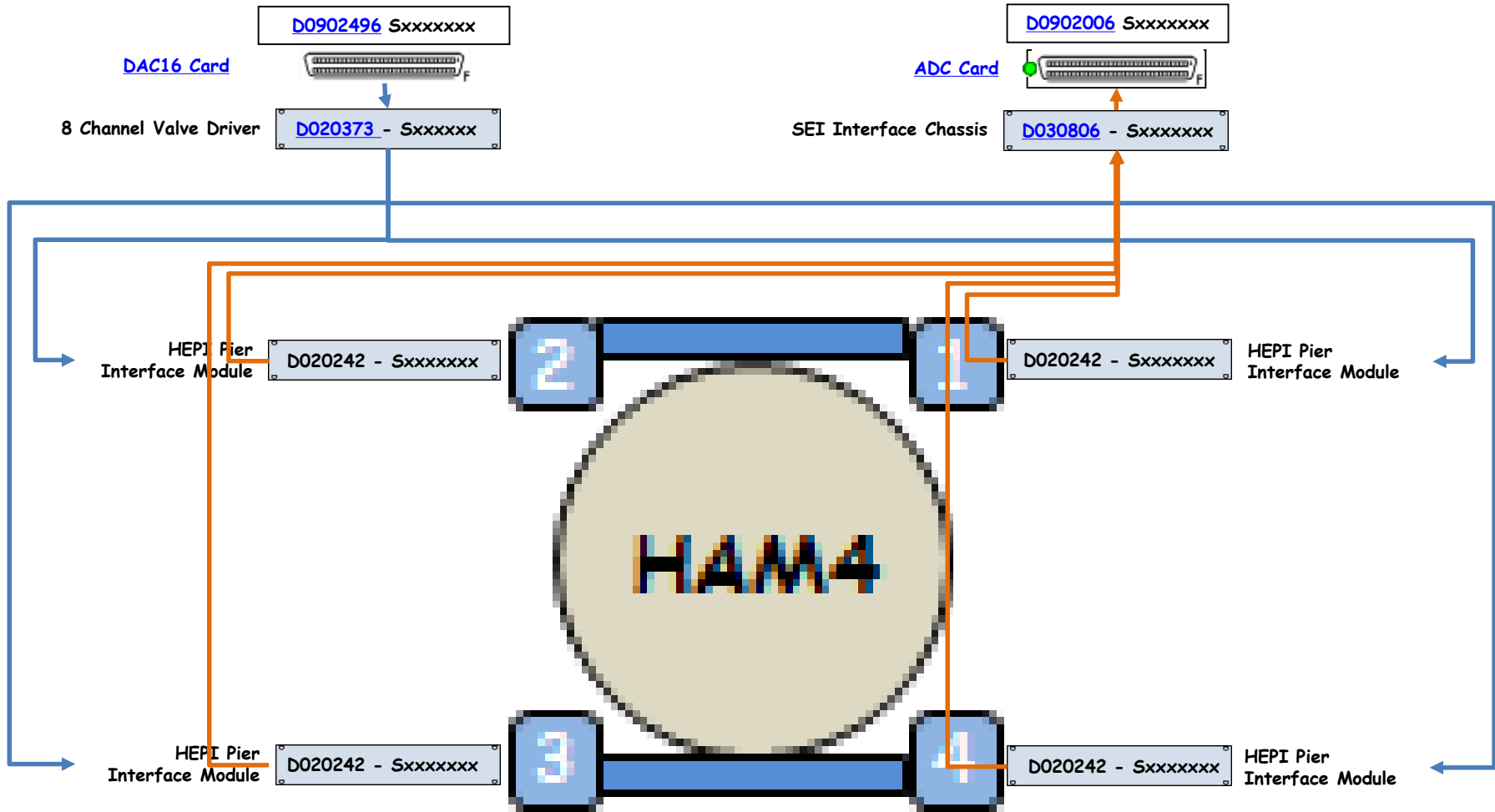

HAM5 Chamber Elements

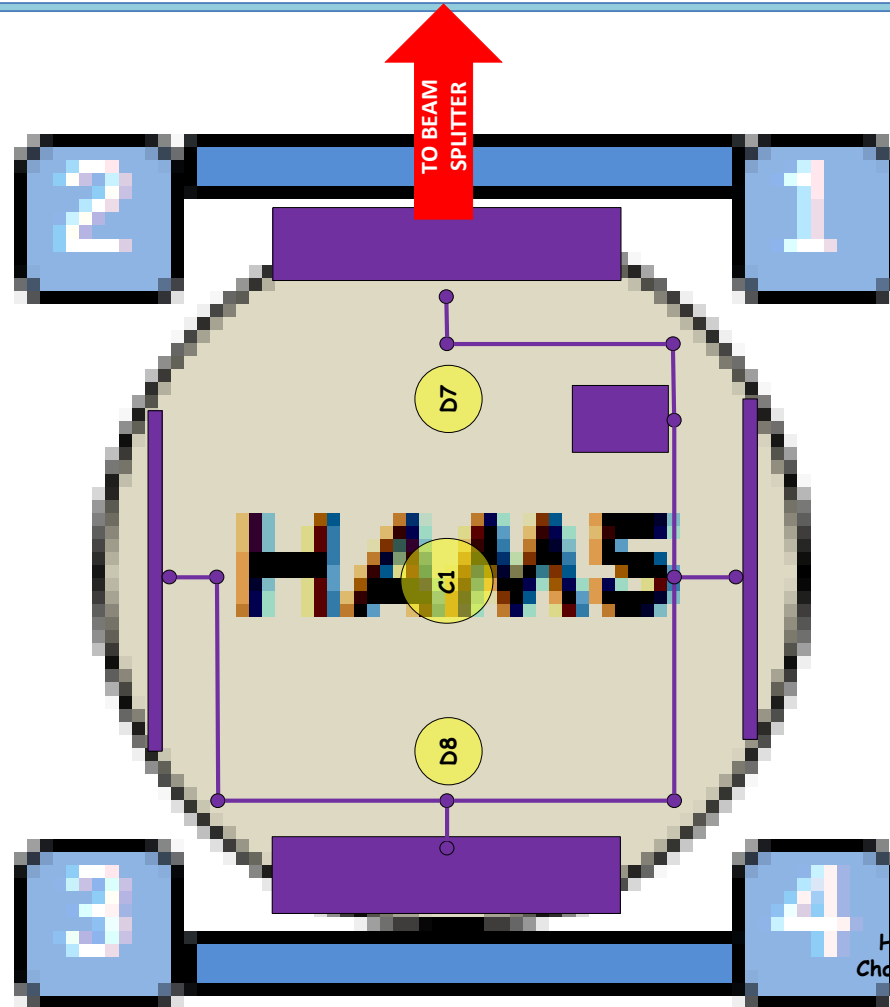

HAM5 Mid-size ION Pump

75IP-HAM5

HAM5 Turbo Pump

75IP-HAM5

HAM5 Scroll Pump

75IP-HAM5

HAM5 Annulus ION Pump

75IP-HAM5

HAM5 Parani Gauge

75IPHAM5

HAM5 Cold Cathode

75IPHAM5

HAM5 Top Level Chamber Assembly

D0900456

HAM5 Drawing

D0900457

HAM5 Viewports

T1000746

HAM5 Flanges

D1002888

HAM5 HEPI

75IP-HAM5

HAM5 CPS

75IP-HAM5

HAM5 Annulus Ion Pump

[<< HAM5 Chamber Elements](#)

HAM5 Annulus ION Pump

[Controller](#)

MiniVac Controller

Model 929-0196
Model 929-0197



Input/Output Interconnections

All input/output signals are accessible at J001 accessory connector. With the provided P001 mating connector, make the connections with AWG 24 (0.2 mm²) - or smaller wire - to the pins indicated in the following figure to obtain the desired capability.

Input signals

Pin 3-7 Remote high voltage ON/OFF or high voltage interlock; requires a permanent closed pin contact.

NOTE

Pin 3-7 must be shorted to allow the high voltage output if no remote/interlock contact is connected.

Output signals

Pin 1-6 Current recorder output 1 (pin 1 signal out, pin 6 ground). The output voltage 0 to + 10 Vdc is proportional to the pump current 0 to 10 mA (e.g. 10 Vdc correspond to 10 mA). The resolution is 10 mV minimum (corresponding to 10 μ A).

The front panel REC. OUT connector is a duplicate of this signal on a BNC connector.

Pin 2-6 Current recorder output 2 (pin 2 signal out, pin 6 ground). The output voltage 0 to + 10 Vdc is proportional to the pump current 0 to 1 mA (e.g. 10 Vdc correspond to 1 mA). The resolution is 10 mV minimum (corresponding to 1 μ A).

Pin 4-8 Voltage recorder output (pin 4 signal out, pin 8 ground). The output voltage 0 to 5 V is proportional to the controller high voltage output 0 to 5 kV (e.g. 1 V corresponds to 1 kV in linear mode).

Pin 5-9 High voltage indication contact. This pure contact (which carries 1 A at 250 Vac and 0.2 A at 30 Vdc) is open when the high voltage is off and closes when the high voltage is on.

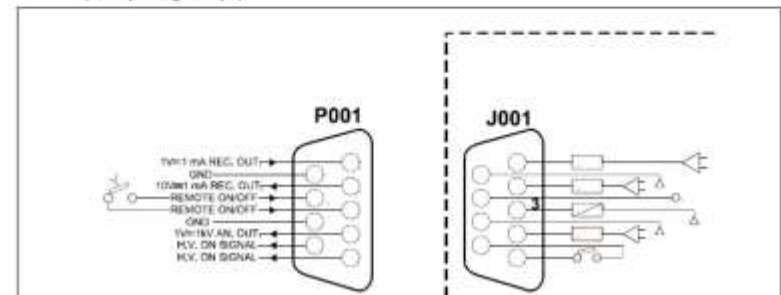

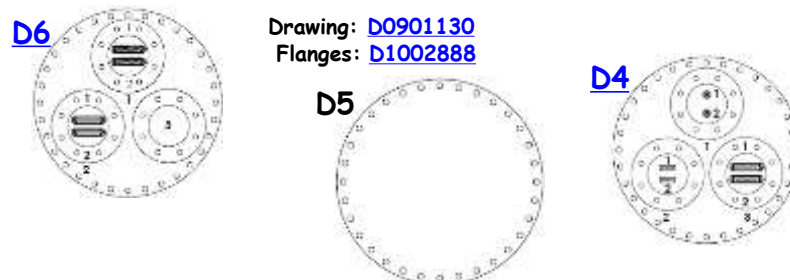
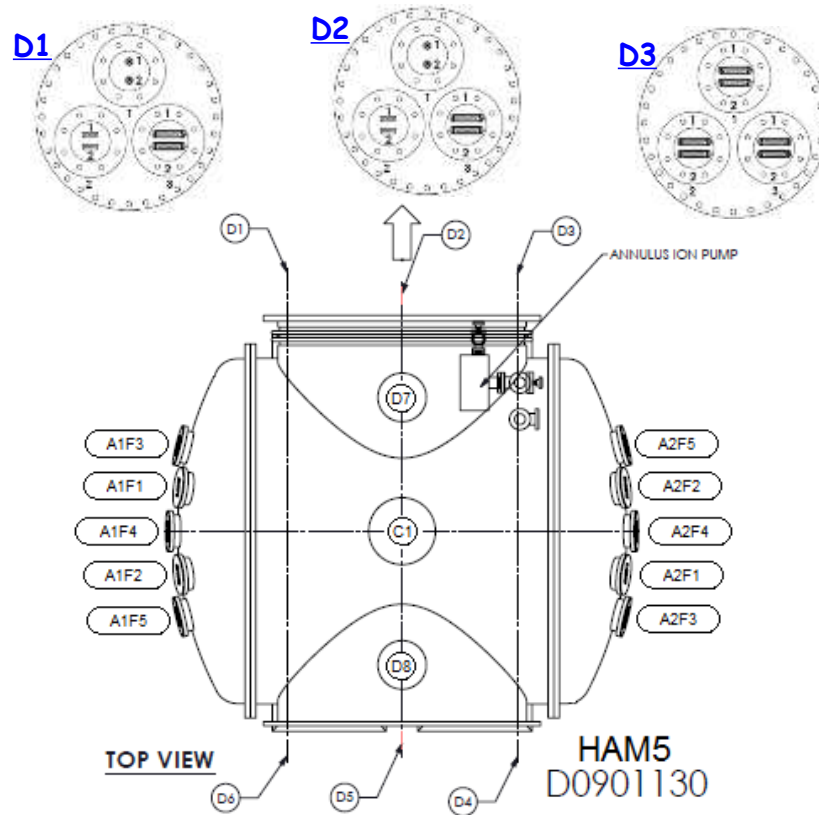

HAM5 D1 Flange

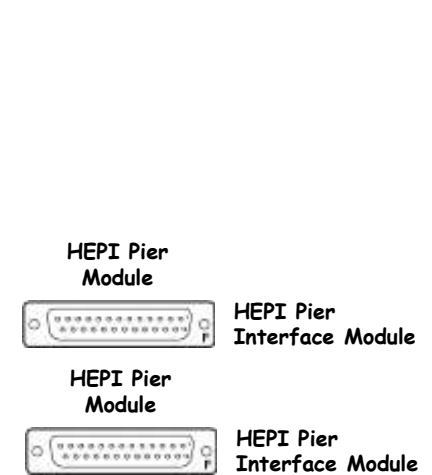
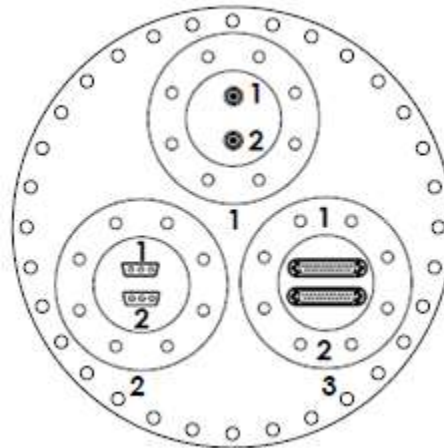

HAM5 D2 Flange

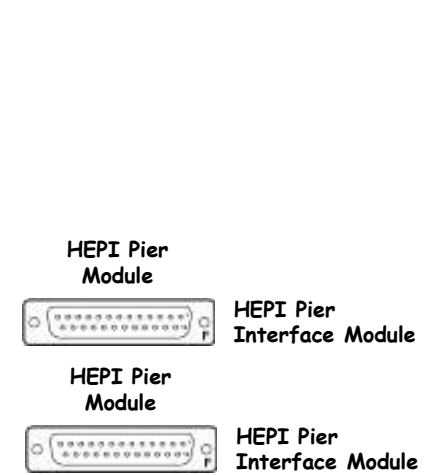
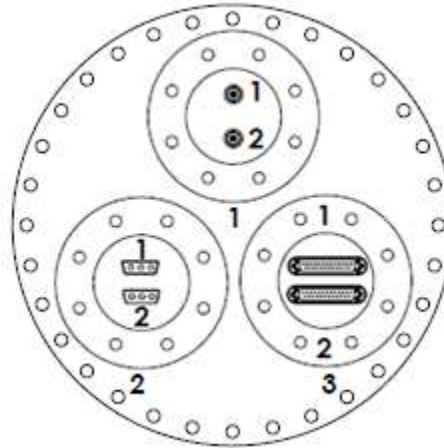

HAM5 D3 Flange

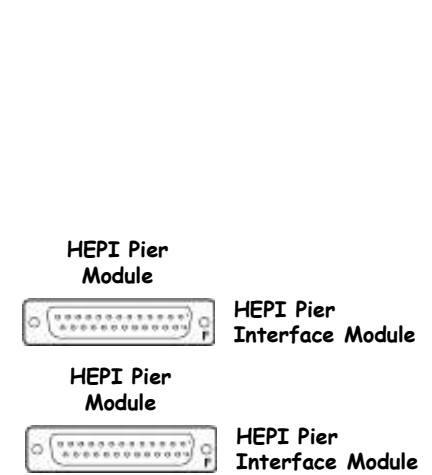
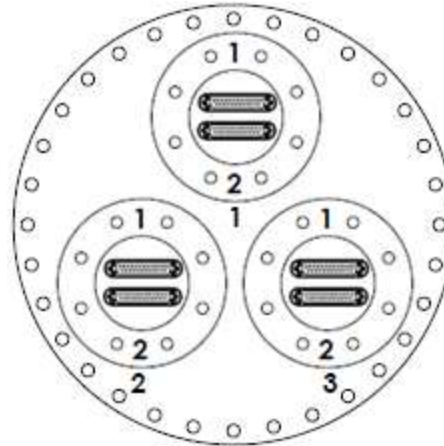

HAM5 D4 Flange

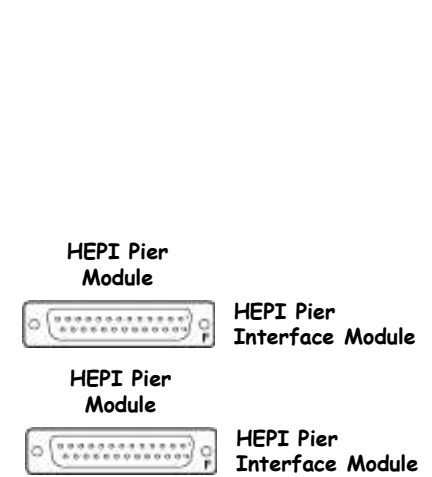
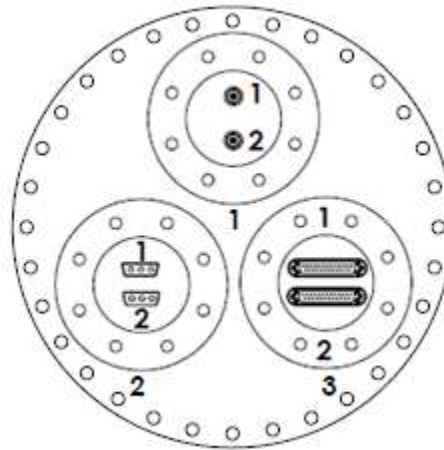

HAM5 D6 Flange

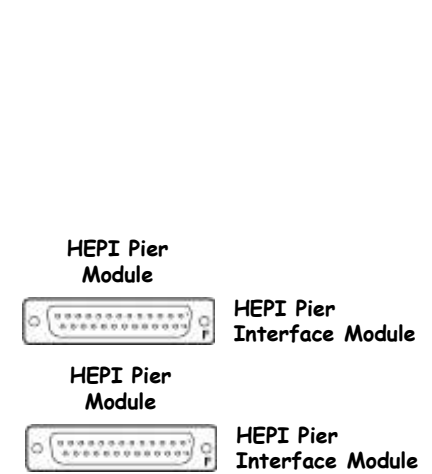
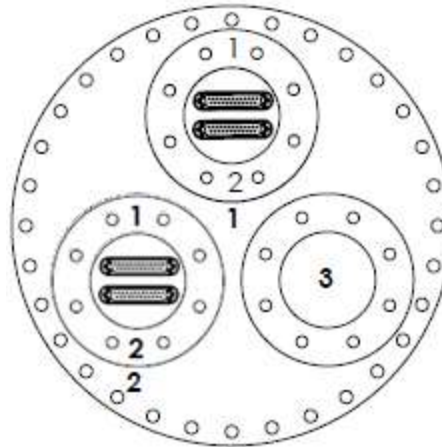

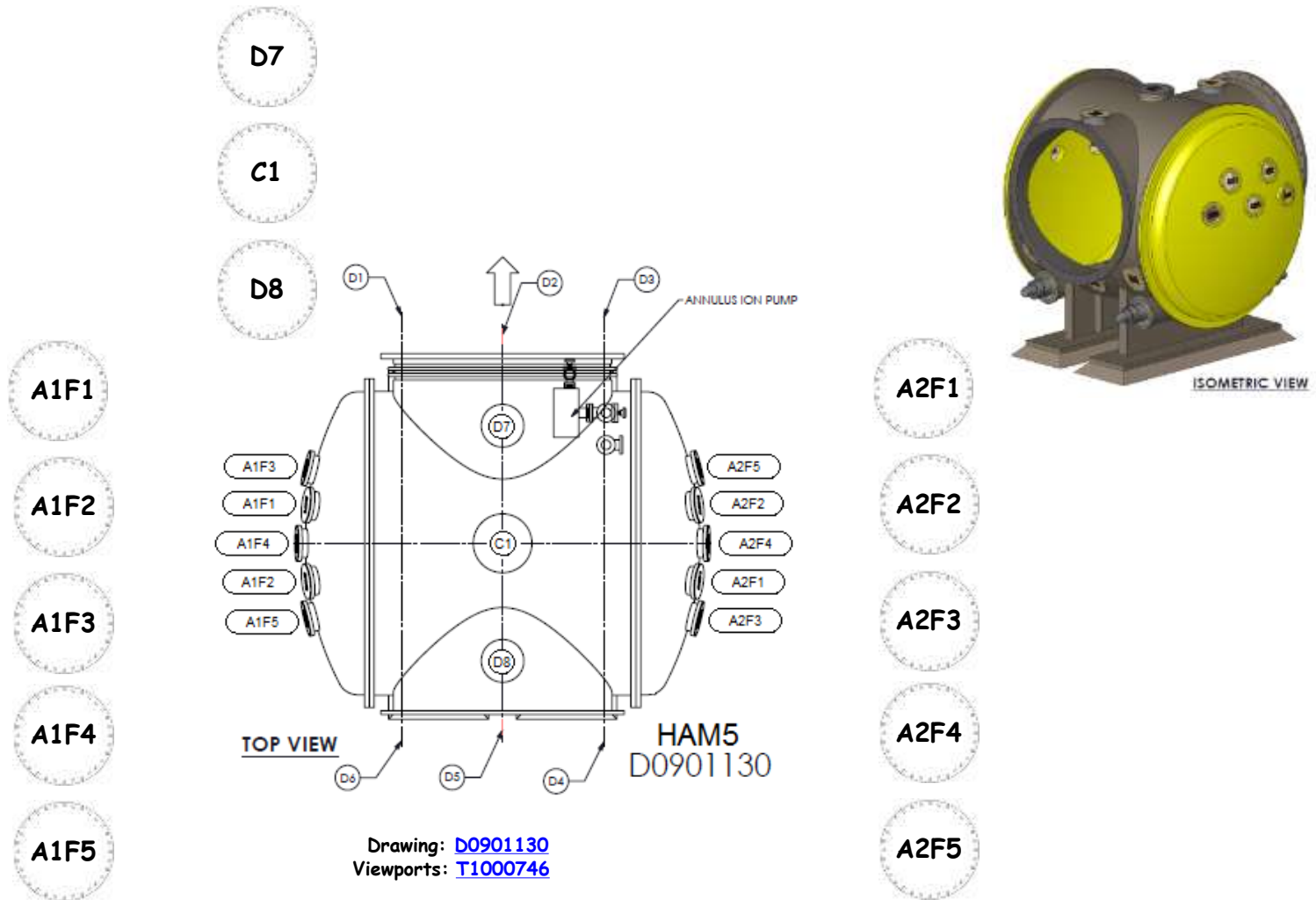

Drawing: [D0901130](#)
Viewports: [T1000746](#)

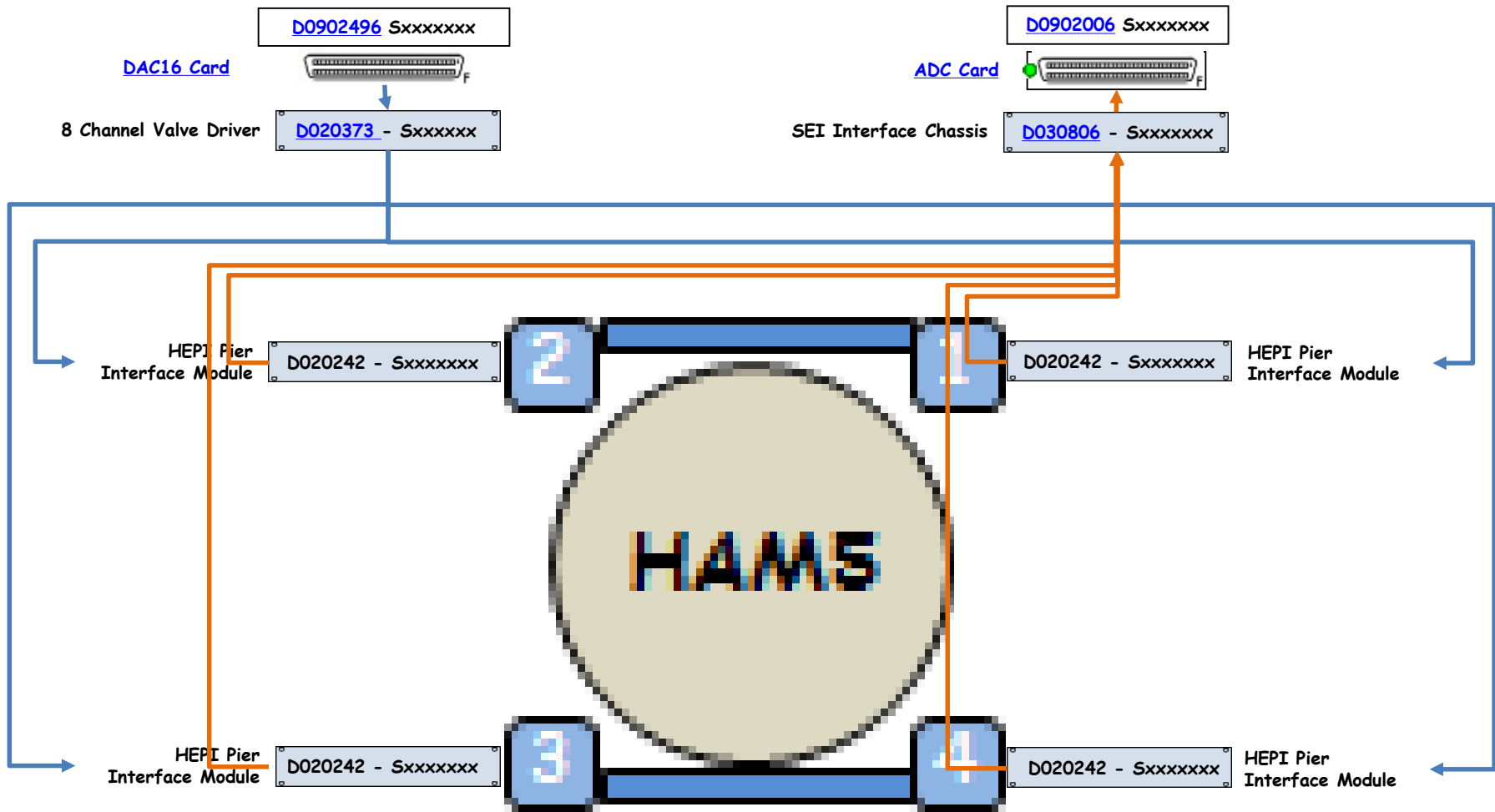

HAM6 Chamber Elements

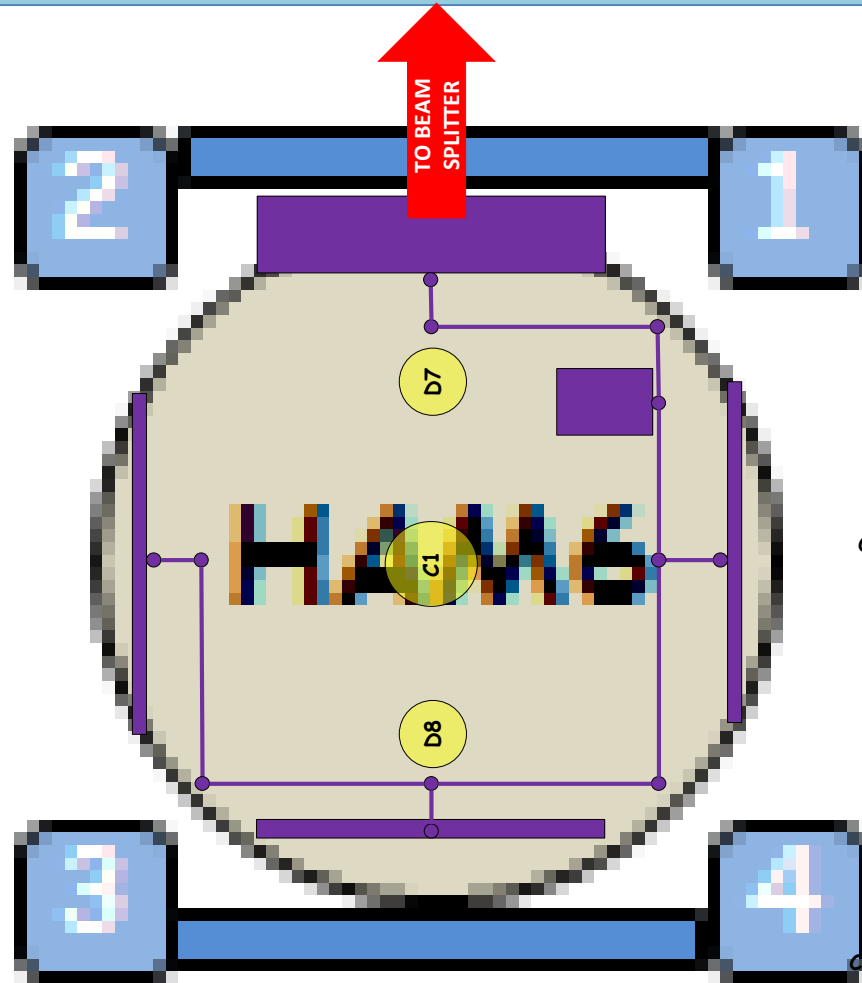

Output Optics Table ([ISCHT6R](#)): [D1000342](#)

HAM6 Mid-size ION Pump

75IP-HAM6

HAM6 Turbo Pump

75IP-HAM6

HAM6 Scroll Pump

75IP-HAM6

[HAM6 Annulus ION Pump](#)

75IP-HAM6

HAM6 Parani Gauge

75IPHAM6

HAM6 Cold Cathode

75IPHAM6

HAM6 Top Level Chamber Assembly

[D0901811](#)

HAM6 Drawing

[D0901812](#)

[HAM6 Viewports](#)

[T1000746](#)

[HAM6 Flanges](#)

[D1002890](#)

[HAM6 HEPI](#)

75IP-HAM6

HAM6 CPS

75IP-HAM6

HAM6 Annulus Ion Pump

[<< HAM6 Chamber Elements](#)

HAM6 Annulus ION Pump

[Controller](#)

MiniVac Controller

Model 929-0196
Model 929-0197



Input/Output Interconnections

All input/output signals are accessible at J001 accessory connector. With the provided P001 mating connector - make the connections with AWG 24 (0.2 mm²) - or smaller wire - to the pins indicated in the following figure to obtain the desired capability.

Input signals

Pin 3-7 Remote high voltage ON/OFF or high voltage interlock; requires a permanent closed pin contact.

NOTE

Pin 3-7 must be shorted to allow the high voltage output if no remote/interlock contact is connected.

Output signals

Pin 1-6 Current recorder output 1 (pin 1 signal out, pin 6 ground). The output voltage 0 to + 10 Vdc is proportional to the pump current 0 to 10 mA (e.g. 10 Vdc correspond to 10 mA). The resolution is 10 mV minimum (corresponding to 10 μ A).

The front panel REC. OUT connector is a duplicate of this signal on a BNC connector.

Pin 2-6 Current recorder output 2 (pin 2 signal out, pin 6 ground). The output voltage 0 to + 10 Vdc is proportional to the pump current 0 to 1 mA (e.g. 10 Vdc correspond to 1 mA). The resolution is 10 mV minimum (corresponding to 1 μ A).

Pin 4-8 Voltage recorder output (pin 4 signal out, pin 8 ground). The output voltage 0 to 5 V is proportional to the controller high voltage output 0 to 5 kV (e.g. 1 V corresponds to 1 kV in linear mode).

Pin 5-9 High voltage indication contact. This pure contact (which carries 1 A at 250 Vac and 0.2 A at 30 Vdc) is open when the high voltage is off and closes when the high voltage is on.

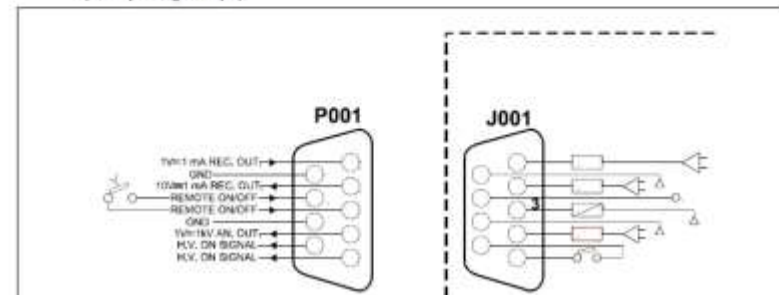

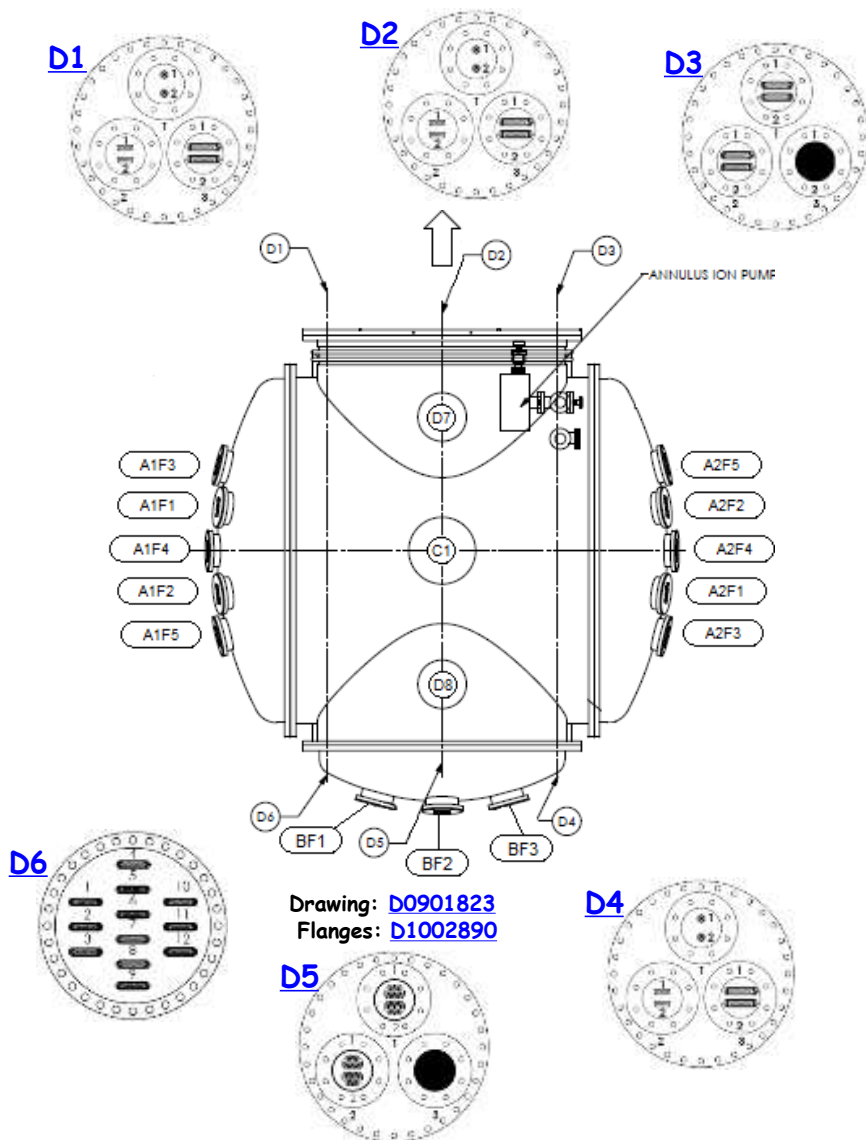

Drawing: [D0901823](#)
 Flanges: [D1002890](#)

D5

D4

HAM6 D1 Flange

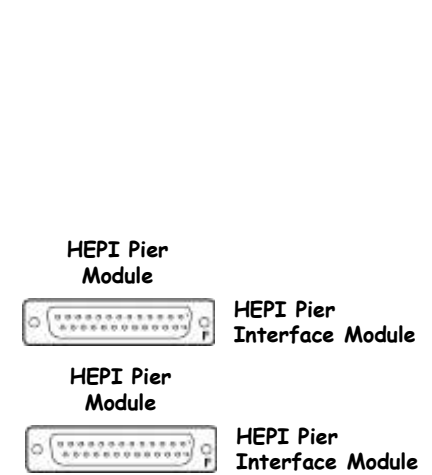
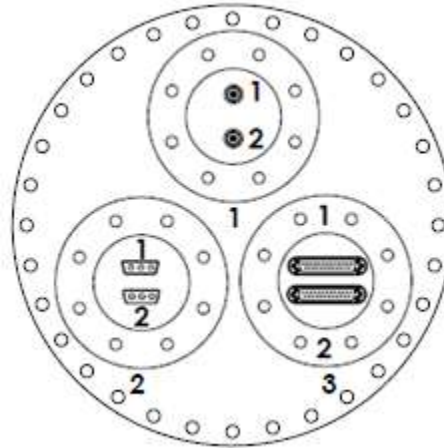

HAM6 D2 Flange

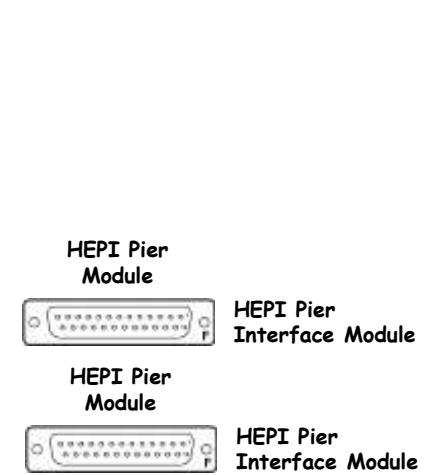
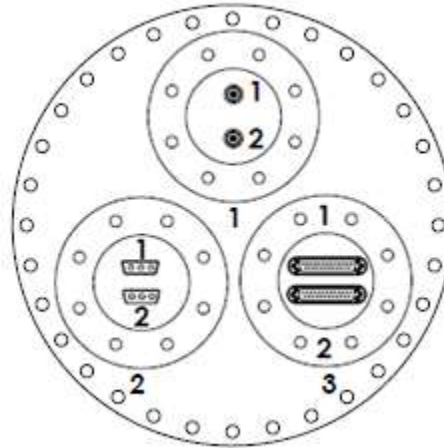

HAM6 D3 Flange

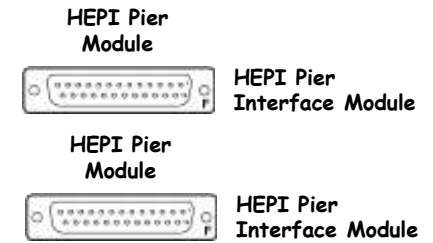
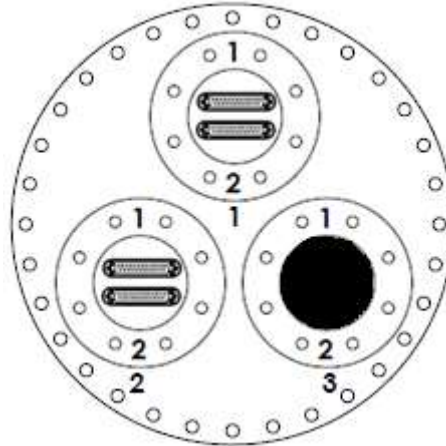

HAM6 D4 Flange

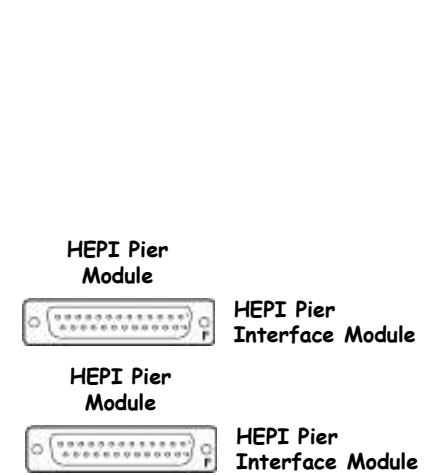
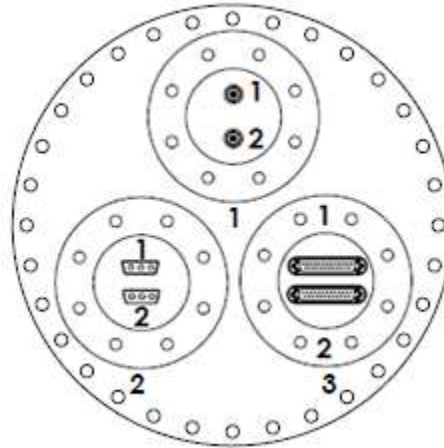

HAM6 D5 Flange

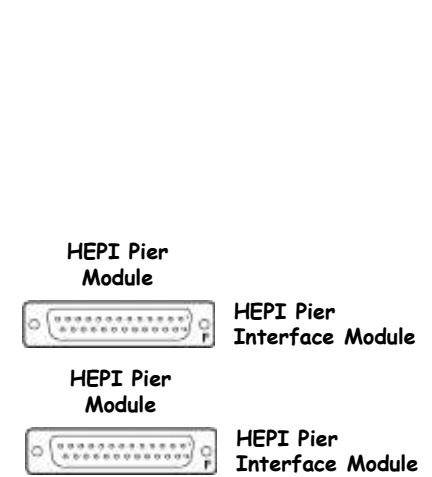
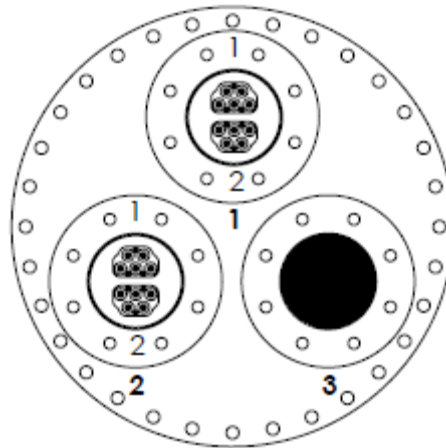

HAM6 D6 Flange

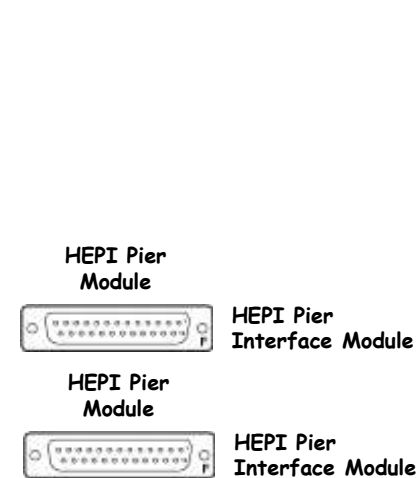
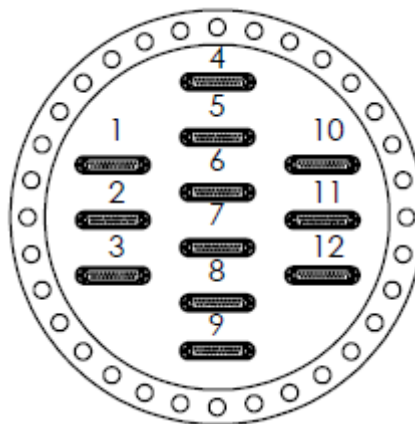

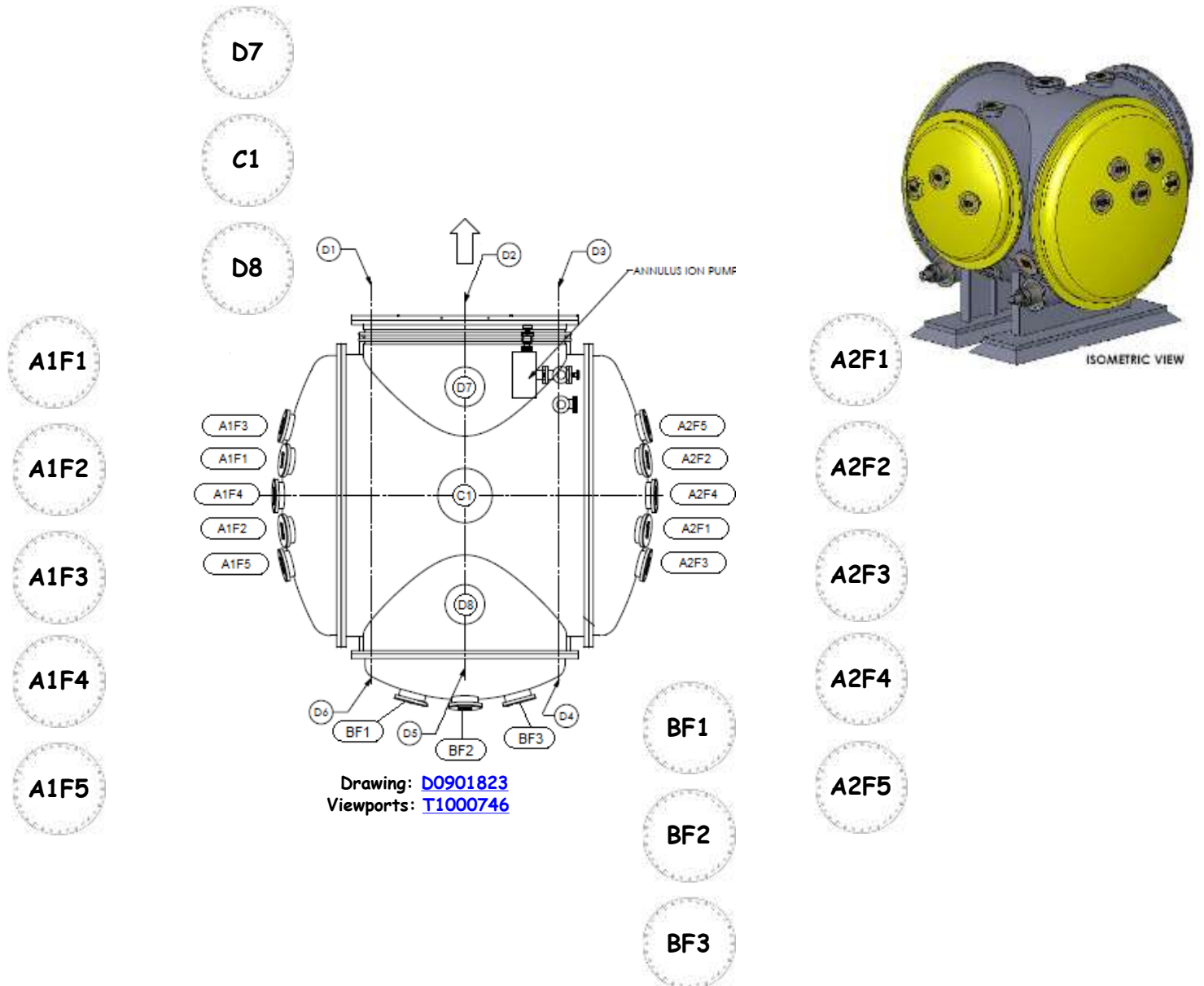

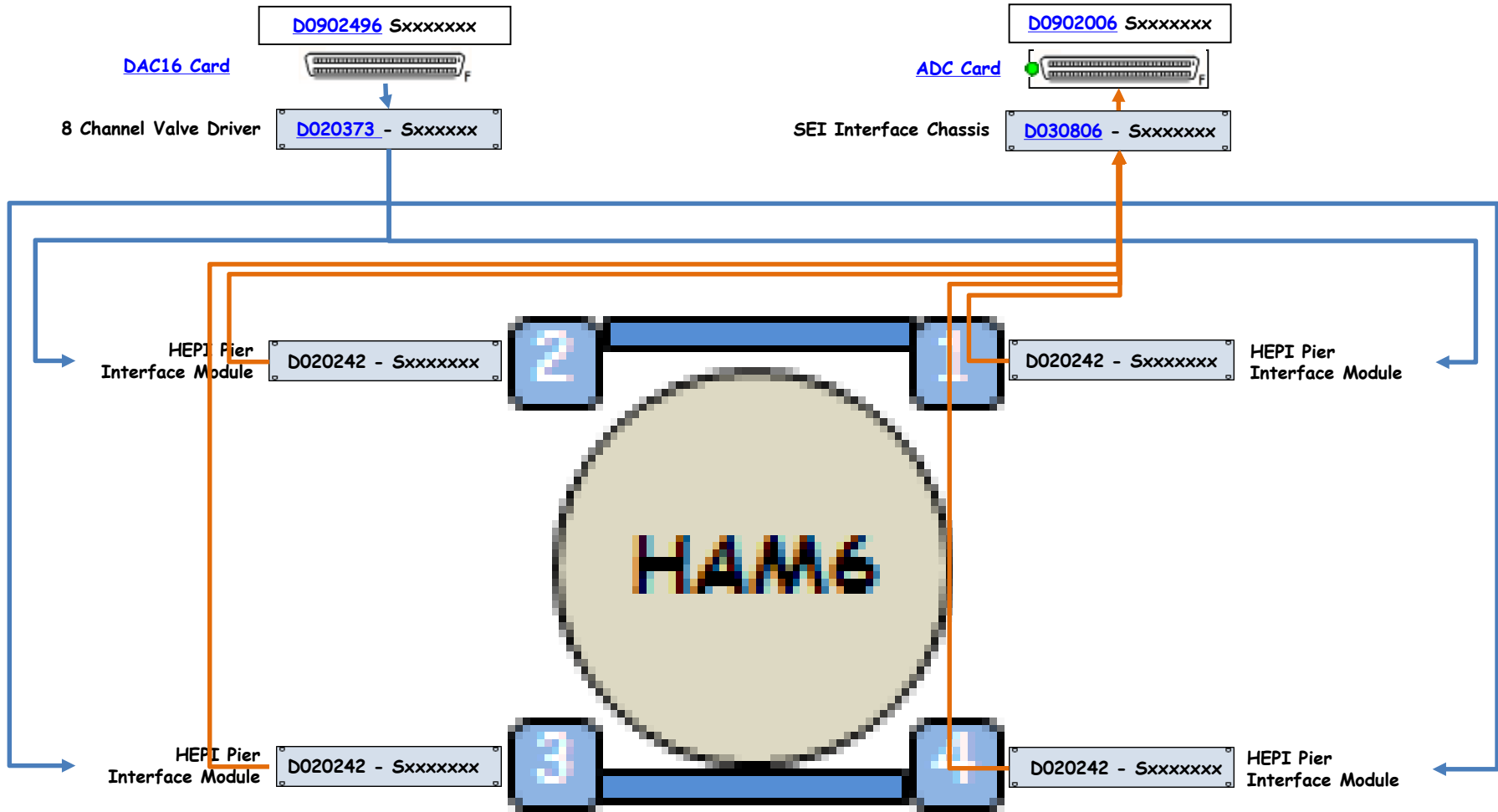

[<< Locations](#)
[<< Chambers](#)

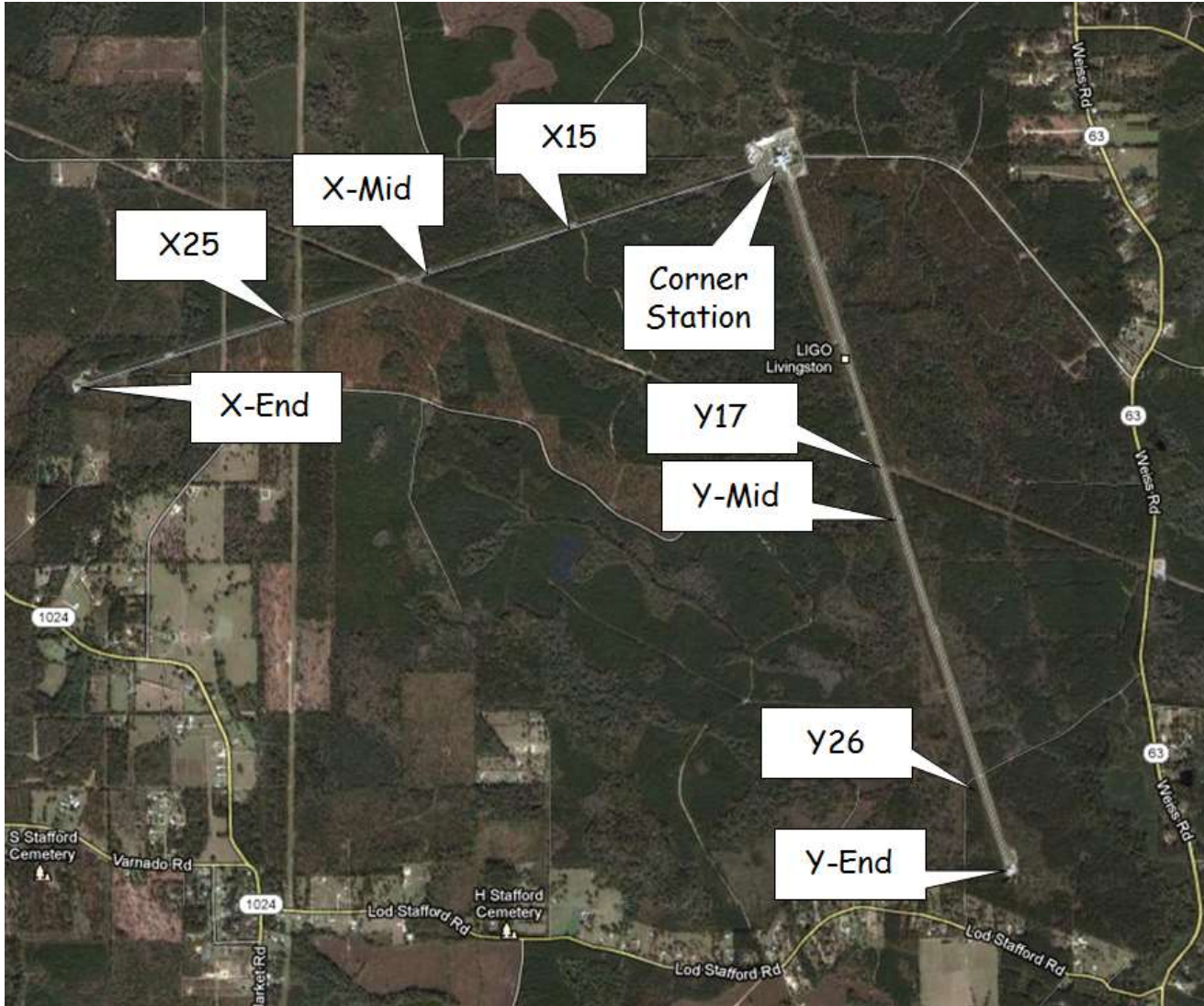

XARM Junctions

<< Locations
<< Chambers

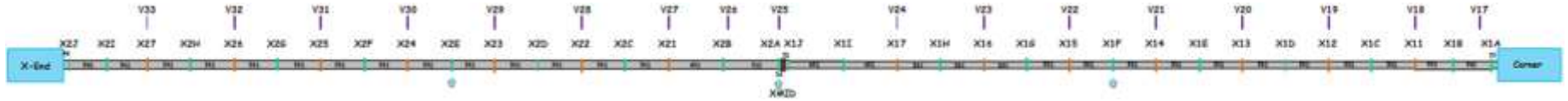

ARMX 4/18/2013	# of 10' Sections	Tunnel Length	Junction Width	From Center to Center	From Corner to Center	Under- ground Vault
Corner						
X1A	4+	50.5	10	55.5	55.5	17
X1B	33	330	10	340	395.5	
X11	34	340	10	350	745.5	18
X1C	38	380	10	390	1135.5	
X12	38	380	10	390	1525.5	19
X1D	38	380	10	390	1915.5	
X13	38	380	10	390	2305.5	20
X1E	38	380	10	390	2695.5	
X14	38	380	10	390	3085.5	21
X1F	38	380	10	390	3475.5	
X15	38	380	10	390	3865.5	22
X1G	38	380	10	390	4255.5	
X16	38	380	10	390	4645.5	23
X1H	38	380	10	390	5035.5	
X17	38	380	10	390	5425.5	24
X1I	48	480	10	490	5915.5	
X1J	48	480	10	490	6405.5	
XMID	2+	32	29.25	51.625	6457.125	25
X2A	1+	16.5	10	36.125	6493.25	
X2B	49	490	10	500	6993.25	
X21	48	480	10	490	7483.25	27
X2C	38	380	10	390	7873.25	
X22	38	380	10	390	8263.25	28
X2D	38	380	10	390	8653.25	
X23	38	380	10	390	9043.25	29
X2E	38	380	10	390	9433.25	
X24	38	380	10	390	9823.25	30
X2F	38	380	10	390	10213.25	
X25	38	380	10	390	10603.25	31
X2G	38	380	10	390	10993.25	
X26	38	380	10	390	11383.25	32
X2H	38	380	10	390	11773.25	
X27	38	380	10	390	12163.25	33
X2I	35	350	10	360	12523.25	
X2J	33	330	10	340	12863.25	
XEND	4+	45.5	84	92.5	12955.75	

YARM Junctions

- << [Locations](#)
- << [Chambers](#)

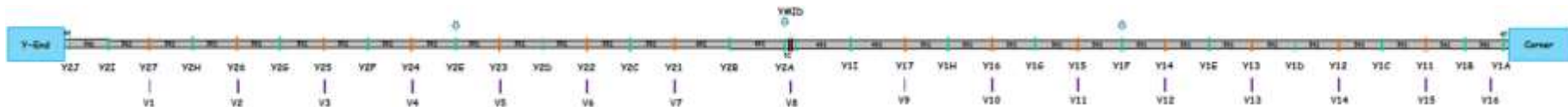

ARMY 4/18/2013	# of 10' Sections	Tunnel Length	Junction Width	From Center to Center	From Corner to Center	Under-ground Vault
Corner						
Y1A	3+	39.5	10	44.5	44.5	16
Y1B	33	330	10	340	384.5	
Y11	35	350	10	360	744.5	15
Y1C	38	380	10	390	1134.5	
Y12	38	380	10	390	1524.5	14
Y1D	38	380	10	390	1914.5	
Y13	38	380	10	390	2304.5	13
Y1E	38	380	10	390	2694.5	
Y14	38	380	10	390	3084.5	12
Y1F	38	380	10	390	3474.5	
Y15	38	380	10	390	3864.5	11
Y1G	38	380	10	390	4254.5	
Y16	38	380	10	390	4644.5	10
Y1H	38	380	10	390	5034.5	
Y17	38	380	10	390	5424.5	9
Y1I	48	480	10	490	5914.5	
Y1J	48	480	10	490	6404.5	
YMID	3	30	29.25	49.625	6454.125	8
Y2A	3	30	10	49.625	6503.75	
Y2B	48	480	10	490	6993.75	
Y21	48	480	10	490	7483.75	7
Y2C	38	380	10	390	7873.75	
Y22	38	380	10	390	8263.75	6
Y2D	38	380	10	390	8653.75	
Y23	38	380	10	390	9043.75	5
Y2E	38	380	10	390	9433.75	
Y24	38	380	10	390	9823.75	4
Y2F	38	380	10	390	10213.75	
Y25	38	380	10	390	10603.75	3
Y2G	38	380	10	390	10993.75	
Y26	38	380	10	390	11383.75	2
Y2H	38	380	10	390	11773.75	
Y27	38	380	10	390	12163.75	1
Y2I	35	350	10	360	12523.75	
Y2J	33	330	10	340	12863.75	
YEND	3+	43.5	84	90.5	12954.25	

IOHT2L is part of [E1201099](#).

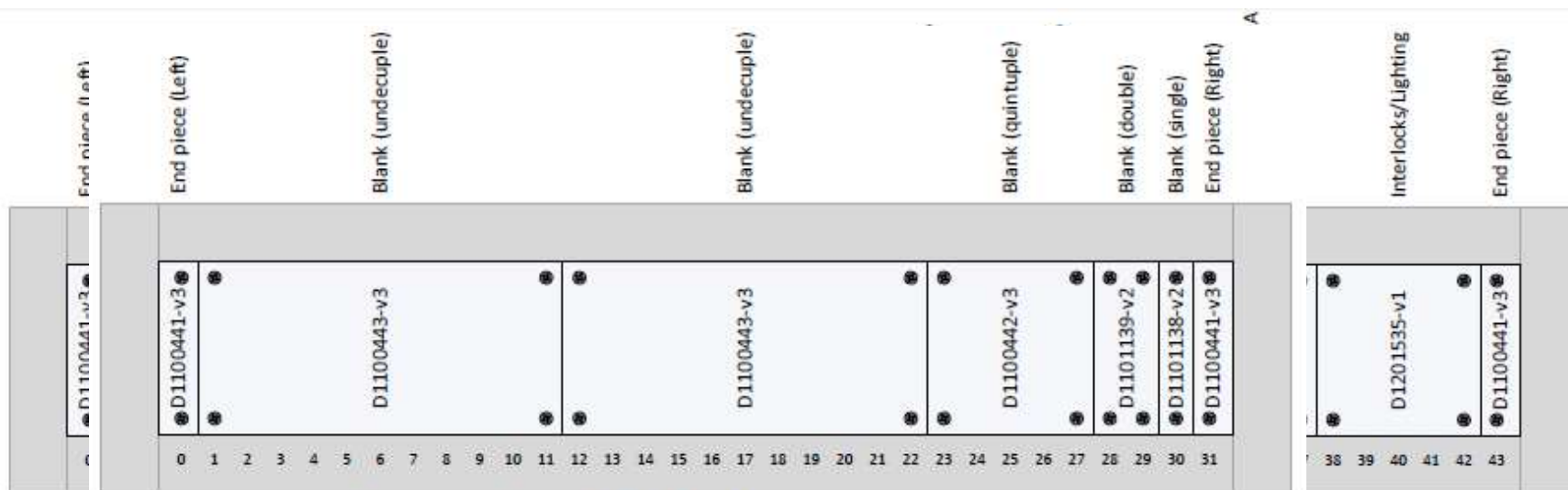

Left Side

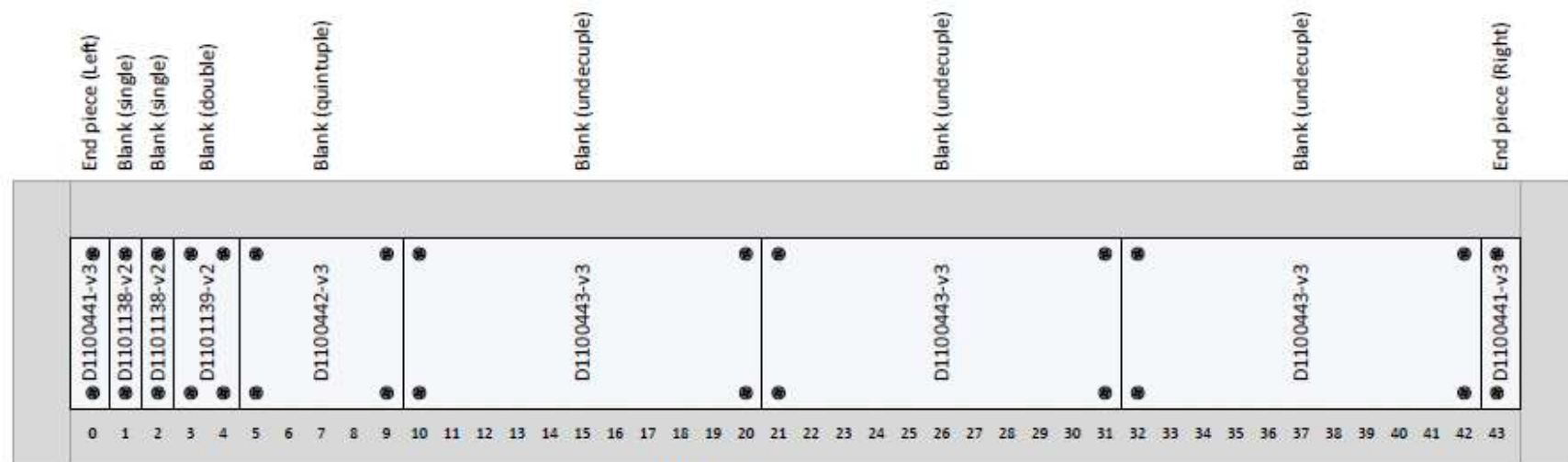

Right Side

IOHT2R is part of [E1201099](#).

L1-IOHT2R Panel Layout

[<< LVEA Tables](#)

IOHT2R Panel Layout ([D1201530](#))

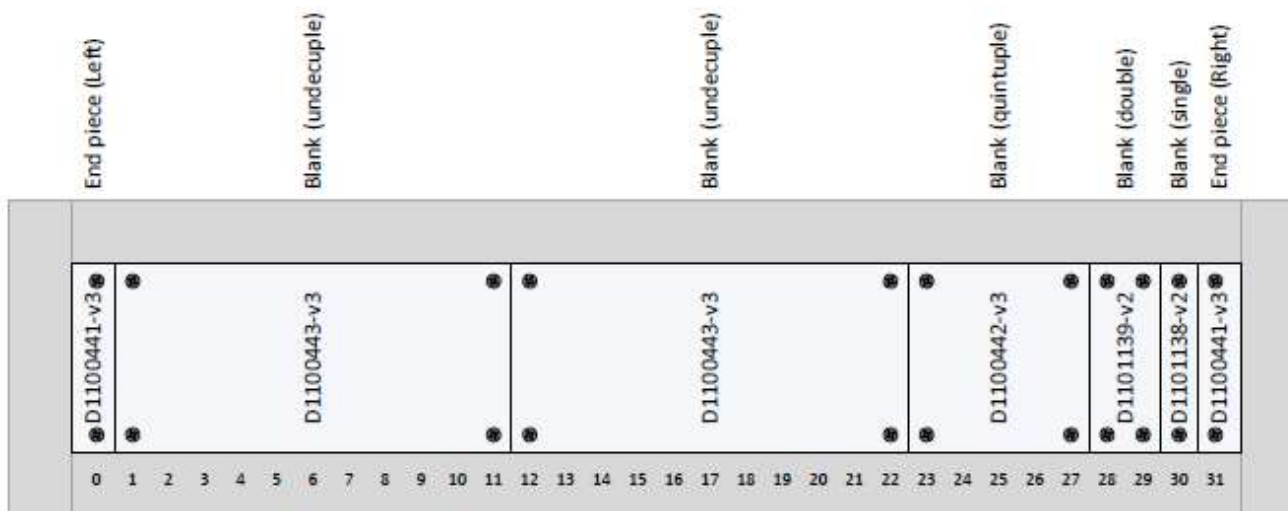

Left Side

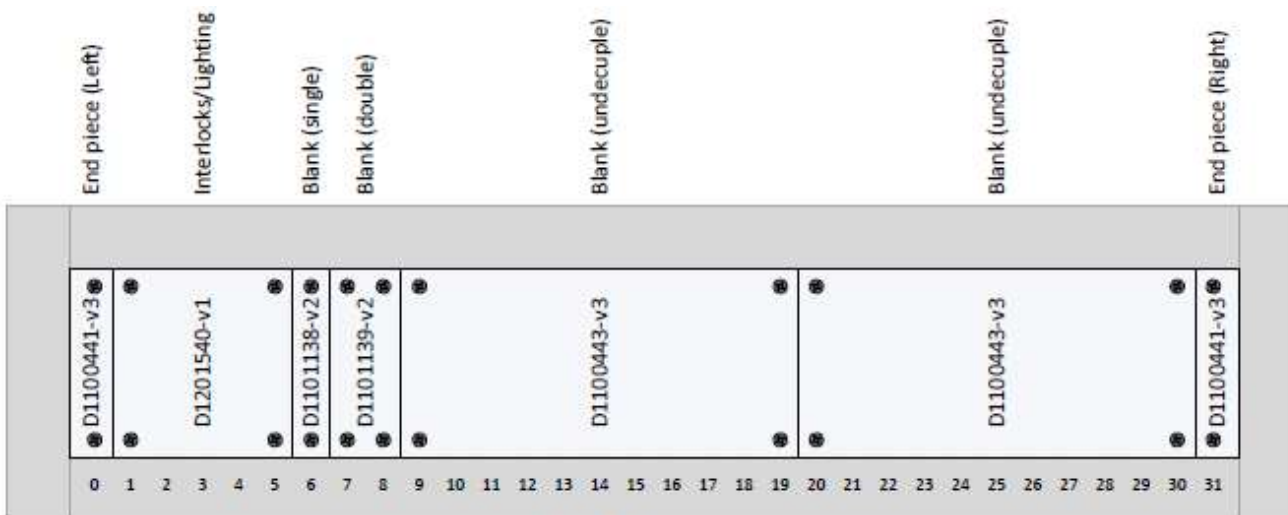

Right Side

ISCHT1L is part of [E1201099](#).

L1-ISCHT1L Panel Layout

<< LVEA Tables

ISCHT1L Panel Layout (D1201331)

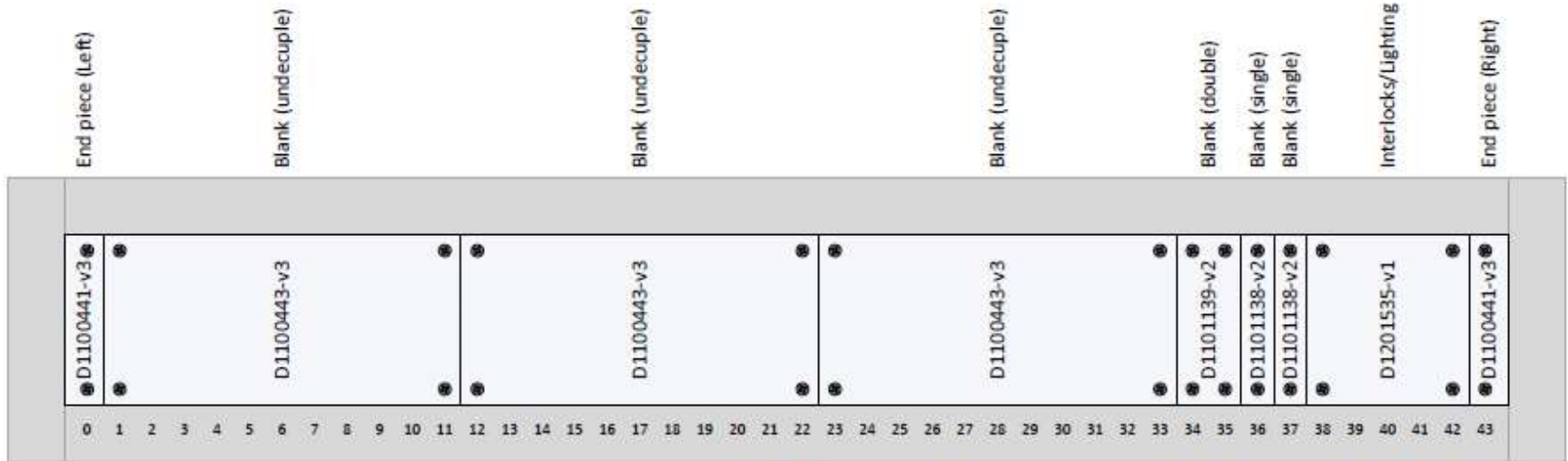

Left Side

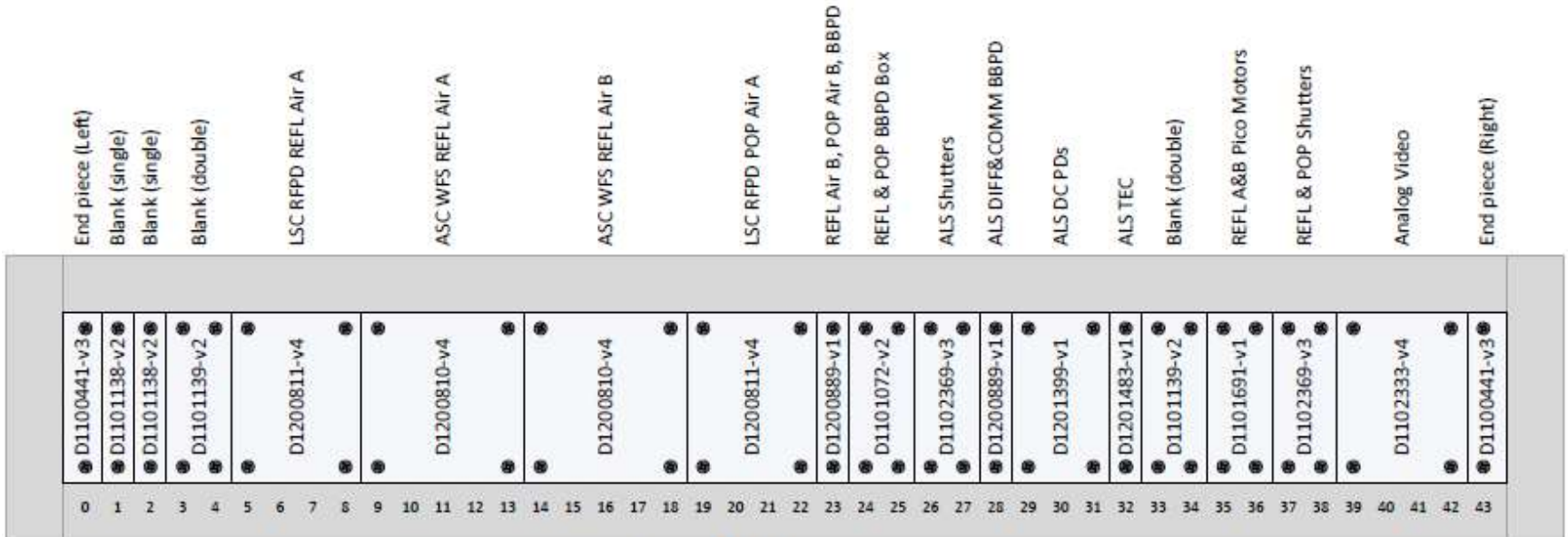

Right Side

ISCHT6R is part of [E1201099](#).

L1-ISCHT6R Panel Layout

[<< LVEA Tables](#)

ISCHT6R Panel Layout ([D1201496](#))

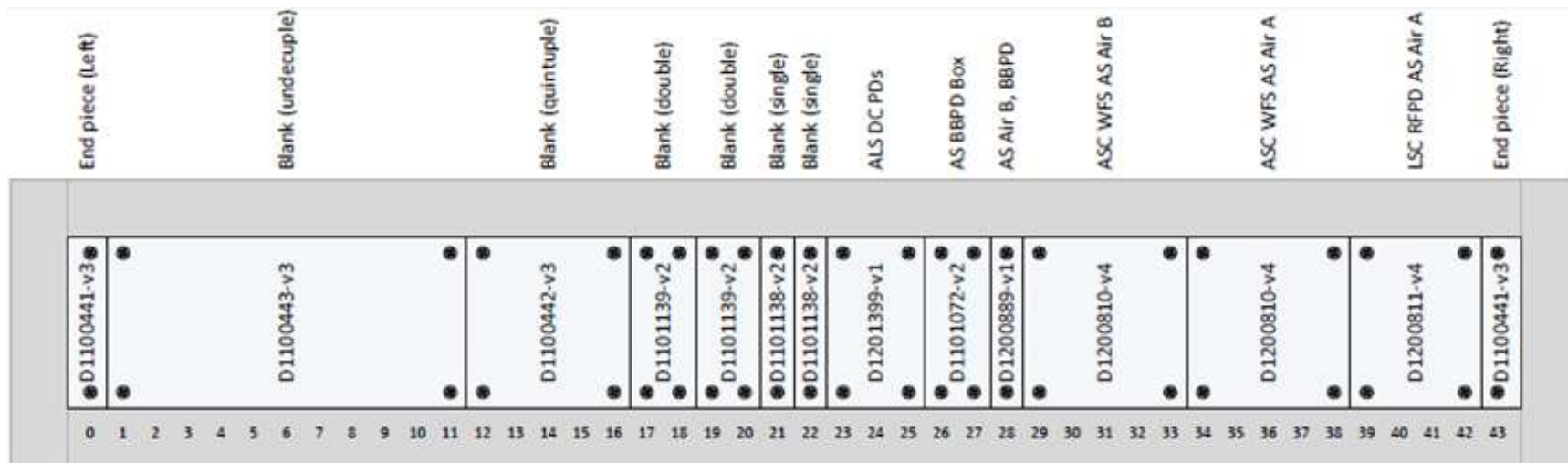

Left Side

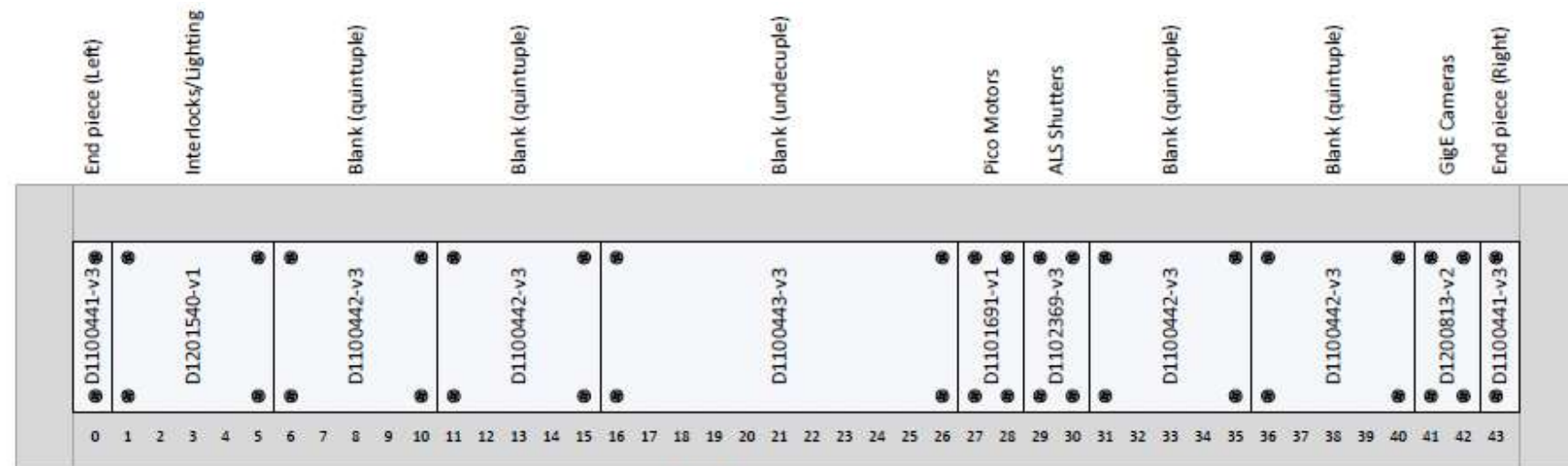

Right Side



[PSL Table \(T0900610\)](#)

TCSBT1R is part of [E1100892](#).

Flexible Aluminum-Armored Multiconductor Building Cable



NEC Type MC with Ground



NEC Type AC with Ground

white, four-conductor cable is black, blue, red, and white). Temperature range is 14° to 194° F. UL listed.

NEC Type MC with ground has solid Type TH-H copper conductors with PVC insulation and a green PVC-insulated grounding wire, wrapped in polyester tape and an aluminum jacket. For use in NEC Class I, Division 2; Class II, Division 2; and Class III, Division 1 and 2 hazardous locations. NEC Type AC with ground has solid Type TH-H copper conductors with PVC insulation and a fibrous covering, an un-insulated aluminum grounding wire, and an aluminum jacket.

To Order: Please select length from the available lengths listed. Maximum continuous length is 250 ft.

AWG	OD	Amps	VAC	Available Lengths, ft	Per Ft	
					1-249	250-Up
NEC Type MC with Ground						
14/2	0.44"	15	600	10, 25, 50, 100, 250	8864K21	\$0.86 \$0.68
14/3	0.47"	15	600	10, 25, 50, 100, 250	8864K22	1.26 .97
14/4	0.49"	15	600	10, 25, 50, 100, 250	8864K23	1.69 1.27
12/2	0.48"	20	600	10, 25, 50, 100, 250	8864K24	.87 .75
12/3	0.51"	20	600	10, 25, 50, 100, 250	8864K25	1.61 1.22
12/4	0.54"	20	600	10, 25, 50, 100, 250	8864K26	1.78 1.34
10/2	0.54"	30	600	10, 25, 50, 100, 250	8864K27	1.65 1.40
Product Detail						
Flexible Aluminum-Armored Cable (Type MC), 10/2 AWG, 54', 600 VAC, with Green Ground					<input type="checkbox"/> Ft.	
You ordered 250 each on 08/27/13.					<input type="button" value="Add to order"/>	
					In stock	
10/3	0.56"	30	600	10, 25, 50, 100, 250	8864K28	2.54 2.06
10/4	0.62"	30	600	10, 25, 50, 100, 250	8864K29	3.68 2.78

TCSBT3L is part of [E1100892](#).

TCSHT4R is part of Exxxxxxx.

End Blank Panel



[D1100441](#)

Single Blank Panel



[D1101138](#)

Double Blank Panel



[D1101139](#)

Quintuple Blank Panel

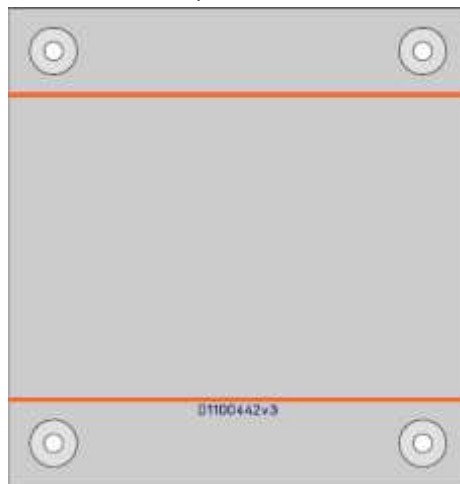

[D1100442](#)

Undecuple Blank Panel



[D1100443](#)

Flipper Mirrors,
Sensor Patch Panel



[D1101919](#)

DC Power Patch Panel



[D1101923](#)

LC Duplex Patch Panel



[D1101924](#)

RTD Sensors Patch Panel

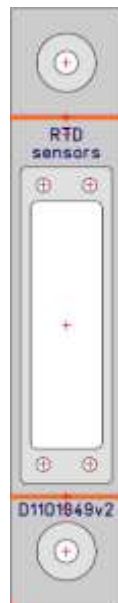

[D1101949](#)

Delrin Insert
for DB25

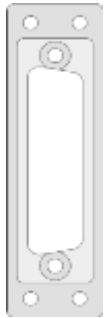

[D1101690](#)

Picomotor
Breakout Front

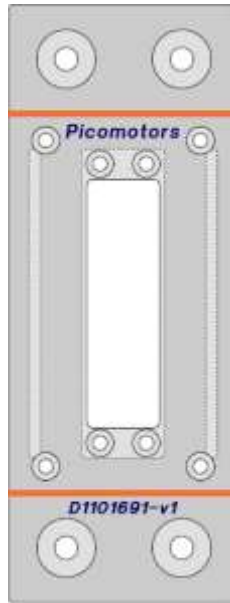

[D1101691](#)

Picomotor
Breakout Rear

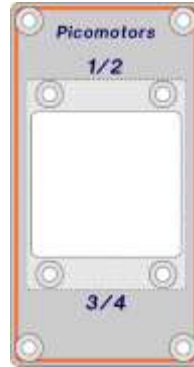

[D1101692](#)

Picomotor
Breakout Side



[D1101693](#)

Delrin Insert
for 2 X DB9



[D1101669](#)

**Delrin Insert
for DB25**

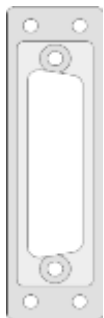

[D1101690](#)

**Delrin Insert
for 2 X DB9(V)**



[D1101669](#)

**Delrin Insert
for 2 X DB9(H)**

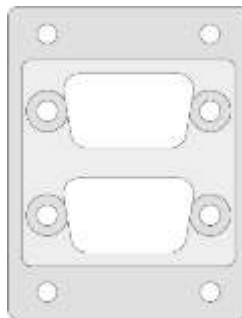

[D1101699](#)

Shutter Logic D1102312 Sxxxxxxx +24VDC



D1102312
Front

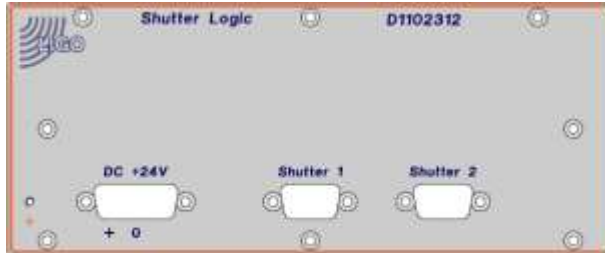

Sxxxxxxx
Rear

D1200136 - Sxxxxxxx



<< LVEA Racks

ALS Fiber Distribution Chassis +-17VDC, +-24VDC

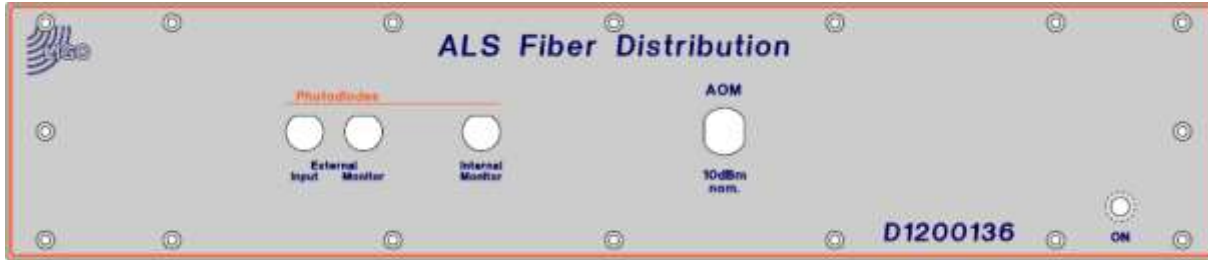

[D1200136](#)
Front



Sxxxxxxx
Rear

RF Distribution Panel 10	Dxxxxxxx	42	Sxxxxxxx	No Power
RF Distribution Panel 11	Dxxxxxxx	41	Sxxxxxxx	No Power
RF Distribution Panel 12	Dxxxxxxx	40	Sxxxxxxx	No Power
24.078 MHz Distribution Amplifier	D1000124	39	S1000673	±17VDC, ±24VDC
79.4 MHz VCO (ALS)	D0900605	38	S1200576	±17VDC, ±24VDC
Dual DSUB Breakout Panel	D1201450	37	Sxxxxxxx	±15VDC
158.8 MHz Frequency Doubler	D1002178	36	S1000740	±17VDC, ±24VDC
158.8 / 79.4 MHz 2-Channel PF Discriminator	D1002476	35	S1000766	±17VDC, ±24VDC
79.4 MHz VCO (ALS)	D0900605	34	S1200575	±17VDC, ±24VDC
79.4 MHz VCO (PSL)	D0900605	33	S1200580	±17VDC, ±24VDC
158.8 MHz Frequency Doubler	D1002178	32	S1000739	±17VDC, ±24VDC
24.078 MHz Dual Delay Line	D0900128	31	S1103423	+15VDC
24.078 MHz 2-Channel Demodulator	D1000181	30	S1000788	±17VDC, ±24VDC
Mode Cleaner Servo	D0901781	29	S1102629	±17VDC, ±24VDC
LSC Demod Concentrator 1	D1100691	28	S1104005	±18VDC
ASC Demod Concentrator 1	D1100696	27	S1103984	No Power
LSC RFPD Interface	D1102079	26	S1200449	±18VDC
WFS RFPD Interface	D1101906	25	S1200429	±15VDC
ISC Whitening Chassis (ASC IMC WFS A 24MHz)	D1002559	24	S1101612	±15VDC
WFS I/Q Demodulator (ASC IMC WFS A 24MHz)	D0902796	23	S1000991	±15VDC
WFS Demodulator Patch Panel	D1100905	22	Sxxxxxxx	No Power
WFS I/Q Demodulator (ASC IMC WFS B 24MHz)	D0902796	21	S1001024	±15VDC
ISC Whitening Chassis (ASC IMC WFS A 24MHz)	D1002559	20	S1101571	±15VDC
Differential to Single-Ended Receiver	D1100482	19	S1202844	±15VDC
		18		
		17		
		16		
		15		
		14		
		13		
		12		
		11		
		10		
		9		
		8		
		7		
		6		
		5		
		4		
		3		
		2		
		1		
	Front		Rear	

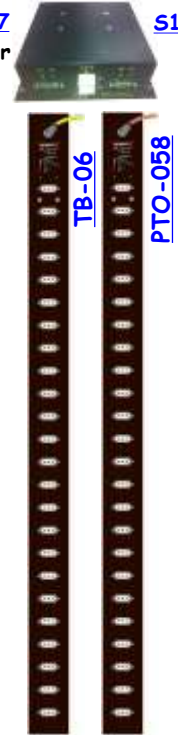

ISC-R1 is part of D1001460.

<< LVEA Racks

ISC IMC/ALS Rack Layout (D1001460) (S1201192)

D1200757
Sequencer

S1202564

ISC R1 LIGO-D1001460-v11

RF Distribution Panel 10

RF Distribution Panel 11

RF Distribution Panel 12

LVEA IMC and ALS Rack R1 Layout September, 2013

42 U

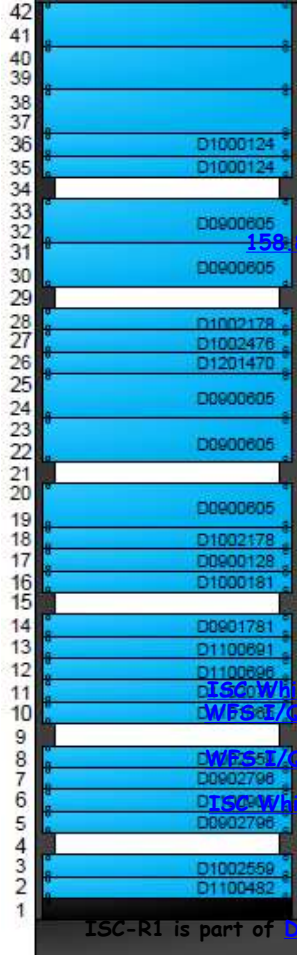

42	RF Patch Panel 10
41	71 MHz Distribution Amplifier
40	24.078 MHz Distribution Amplifier
39	RF Patch Panel 11
38	RF Patch Panel 12
37	79.4 MHz FDD (ALS)
36	71 MHz Distribution Amplifier (Concent)
35	24.078 MHz Distribution Amplifier (Conc)
34	
33	79.4 MHz VCO (ALS)
32	158.8 MHz Frequency Doubler
31	158.8 / 79.4 MHz 2-Channel PF Discriminator
30	79.4 MHz Demodulator RF Distribution Panel
29	
28	79.4 MHz VCO (ALS)
27	158.8 MHz Frequency Doubler
26	79.4 / 158.8 MHz 2-Channel PF Discrimin
25	79.4 MHz FDD (ALS)
24	79.4 MHz VCO (ALS COMM) (to Beckh
23	79.4 MHz VCO (PSL)
22	79.4 MHz EDD (ALS COMM) (to Beckh
21	158.8 MHz Frequency Doubler
20	24.078 MHz Dual Delay Line
19	79.4 MHz 2-Channel Demodulator
18	158.8 MHz Frequency Doubler
17	24.078 MHz Dual Delay Line
16	24.078 MHz 2-Channel Demodulator
15	Mode Cleaner Servo
14	LSC Demod Concentrator 1
13	LSC Demod Concentrator 1
12	ASC Demod Concentrator 1
11	ASC Demod Concentrator 1
10	ASC Demod Concentrator 1
9	ASC Demod Concentrator 1
8	ASC Demod Concentrator 1
7	ASC Demod Concentrator 1
6	ASC Demod Concentrator 1
5	ASC Demod Concentrator 1
4	ASC Demod Concentrator 1
3	ASC Demod Concentrator 1
2	ASC Demod Concentrator 1
1	ASC Demod Concentrator 1

Dxxxxxxx	42	Sxxxxxxx	No Power
Dxxxxxxx	41	Sxxxxxxx	No Power
Dxxxxxxx	40	Sxxxxxxx	No Power
Dxxxxxxx	39	Sxxxxxxx	No Power
Dxxxxxxx	38	Sxxxxxxx	No Power
D1000124	37	S1000673	±17VDC, ±24VDC
D1000124	36	S1000673	±17VDC, ±24VDC
	35		
	34		
D0900605	33	S1200576	±17VDC, ±24VDC
D0900605	32	S1200576	±17VDC, ±24VDC
	31		
D1002178	30	S1000740	±17VDC, ±24VDC
D1002476	29	S1000766	±17VDC, ±24VDC
D1201470	28	Sxxxxxxx	??
D0900605	27	S1200575	±17VDC, ±24VDC
D0900605	26	S1200575	±17VDC, ±24VDC
D0900605	25	S1200575	±17VDC, ±24VDC
D0900605	24	S1200575	±17VDC, ±24VDC
D0900605	23	S1200580	±17VDC, ±24VDC
D0900605	22	S1200580	±17VDC, ±24VDC
D0900605	21	S1200580	±17VDC, ±24VDC
D1002178	20	S1000739	±17VDC, ±24VDC
D0900128	19	S1103423	+15VDC
D1000181	18	S1000788	±17VDC, ±24VDC
D0901781	17	S1102629	±17VDC, ±24VDC
D1100691	16	S1104005	±18VDC
D1100696	15	S1103984	No Power
D1102079	14	S1200449	±18VDC
D1101865	13	Sxxxxxxx	±15VDC
D1002559	12	S1101612	±15VDC
D0902796	11	S1000991	±15VDC
D1100905	10	Sxxxxxxx	No Power
D0902796	9	S1001024	±15VDC
D1002559	8	S1101571	±15VDC
D1100482	7	S1202844	±15VDC
	6		
	5		
	4		
	3		
	2		
	1		



ISC-R1 is part of D1001460.

Front

Rear

L1-ISC-R1 Details

RF Distribution Panel 10

<< [L1-ISC-R1](#)

RF Distribution Panel 10

Dxxxxxxx

Sxxxxxxx

No Power

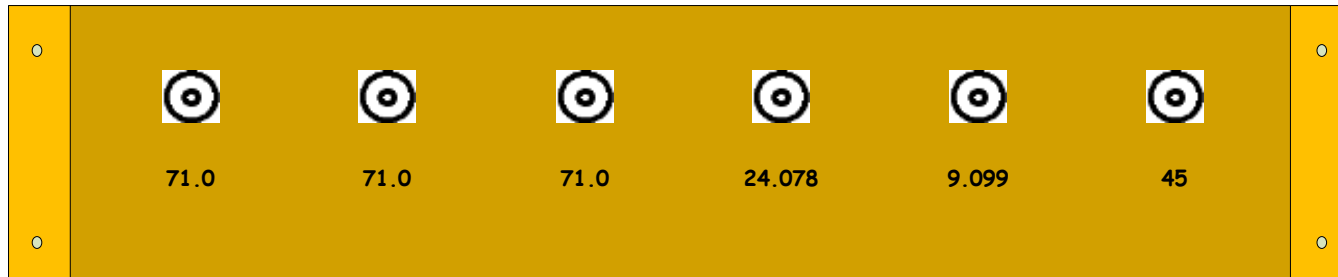

Dxxxxxxx

Front

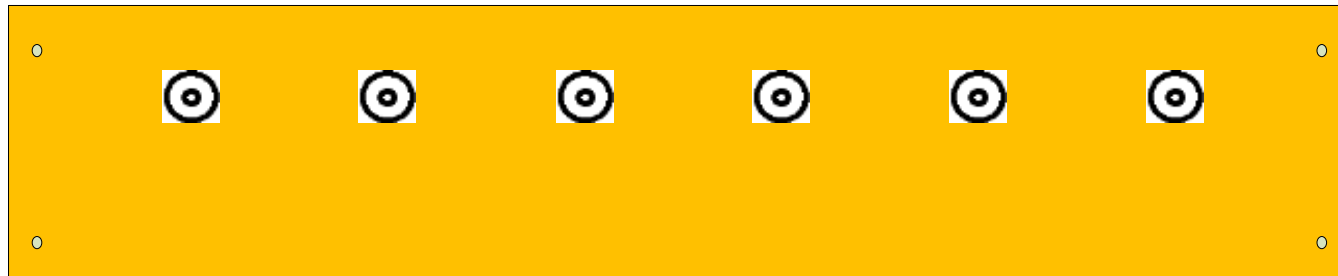

Sxxxxxxx

Rear

RF Distribution Panel 11

<< [L1-ISC-R1](#)

RF Distribution Panel 11

Dxxxxxxx

Sxxxxxxx

No Power

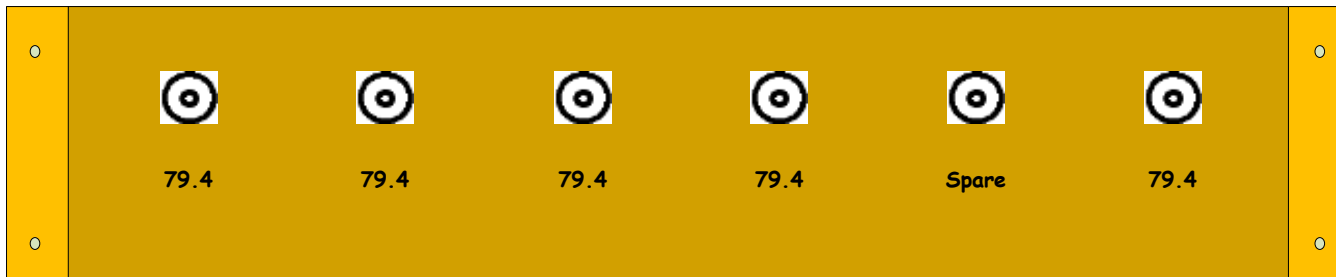

Dxxxxxxx

Front

RF Power Splitter for PSL VCO: [E1200894](#)

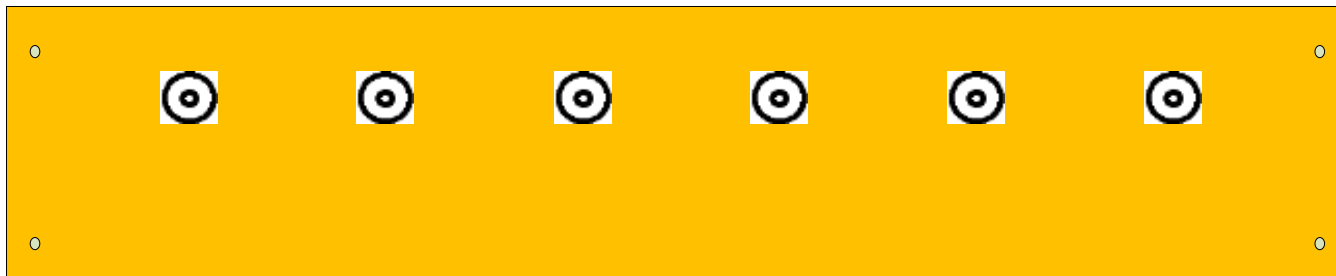

Sxxxxxxx

Rear

24.078 MHz Distribution Amplifier D1000124 S1000673 ±17VDC, ±24VDC

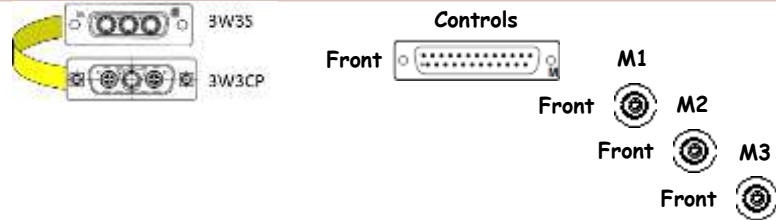
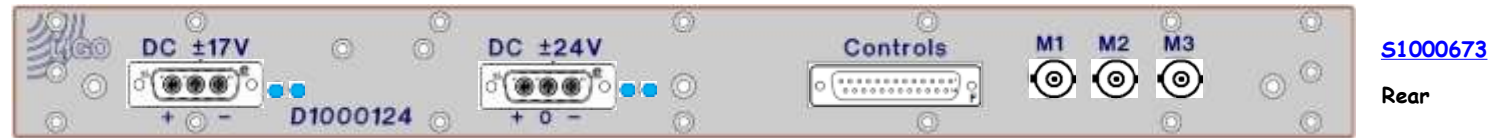
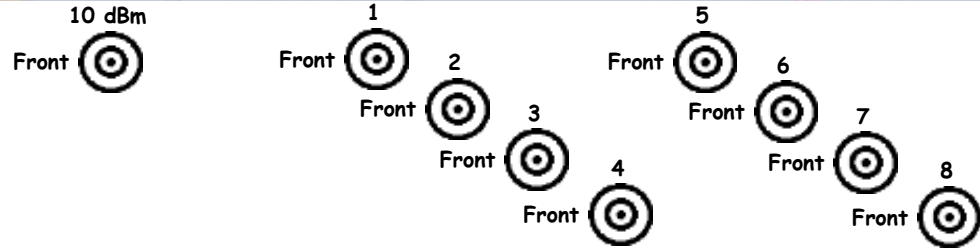
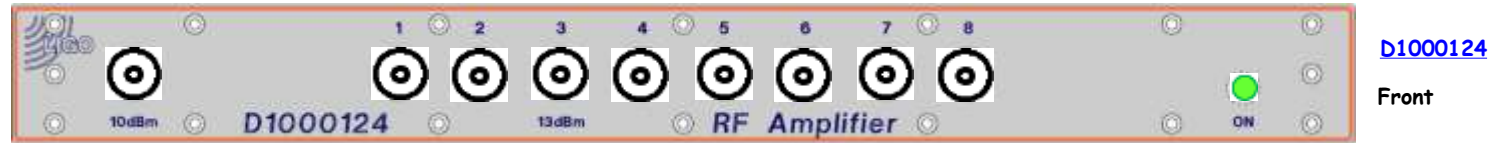

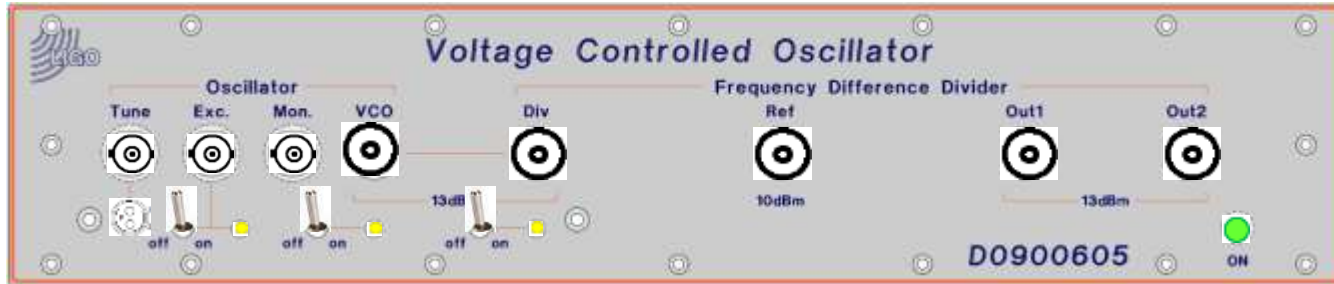

D0900605

Front



S1200576

Rear

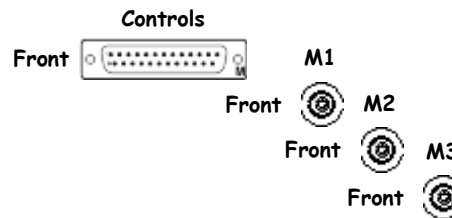

D1201450 - Sxxxxxxx

<< L1-ISC-R1

Dual DSUB Breakout Panel D1201450 Sxxxxxxx ±17VDC, ±24VDC

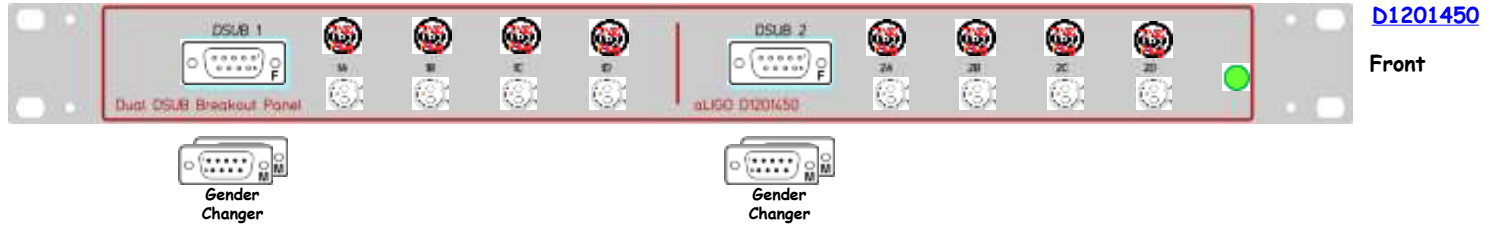



D1002178

Front

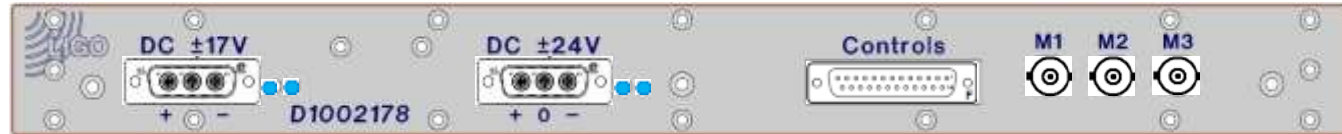
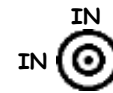

S1000740

Rear

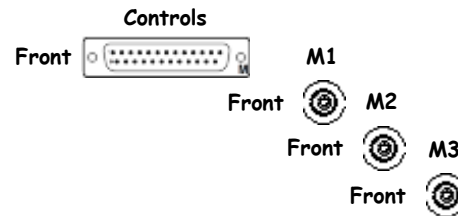
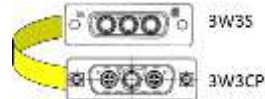

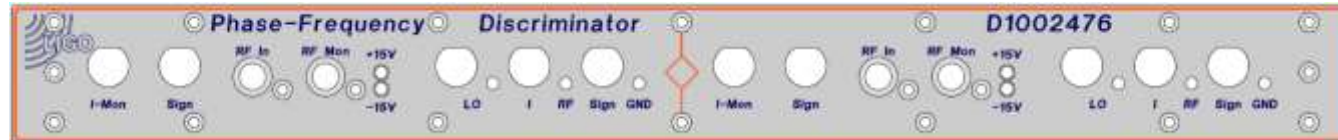

D1002476

Front



S1000766

Rear



<< L1-ISC-R1

79.4 MHz VCO (ALS)

D0900605

S1200575

±17VDC, ±24VDC

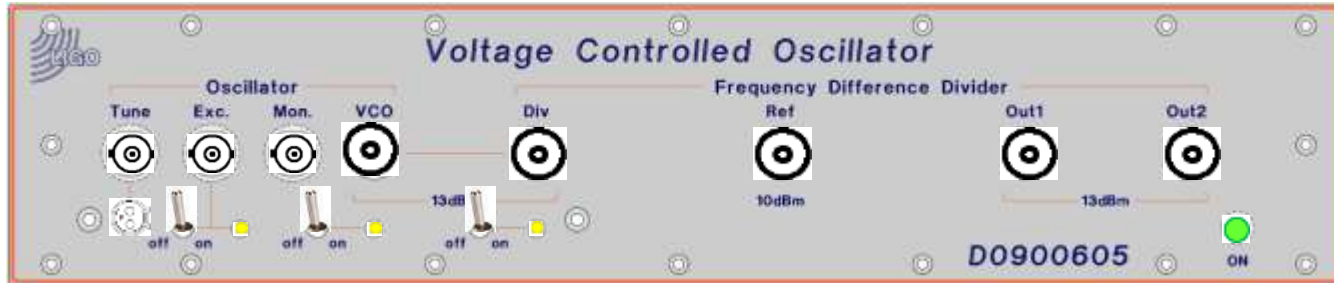

D0900605

Front



S1200575

Rear

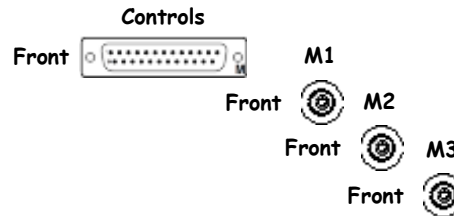
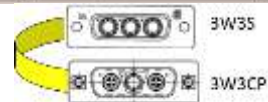

<< L1-ISC-R1

79.4 MHz VCO (ALS)

D0900605

S1200580

±17VDC, ±24VDC

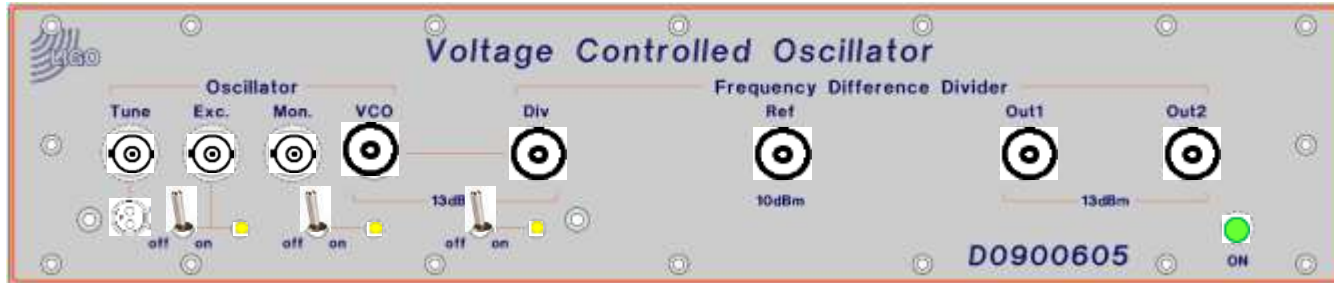

D0900605

Front



S1200580

Rear

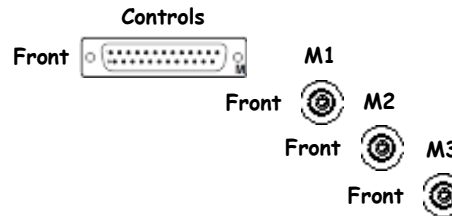
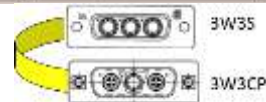

D1002178 - S1000739



<< L1-ISC-R1

24.078 MHz Distribution Amplifier

D1002178

S1000739

±17VDC, ±24VDC



D1002178

Front

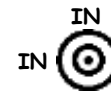

S1000739

Rear

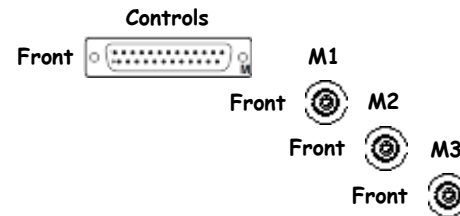
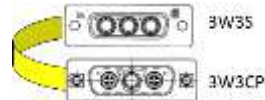

D0900128 - S1103423



<< L1-ISC-R1

24.078 MHz Dual Delay Line +15VDC



D0900128

Front



S1103423

Rear

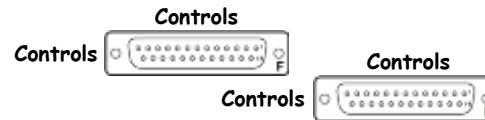



[D1000181](#)

Front

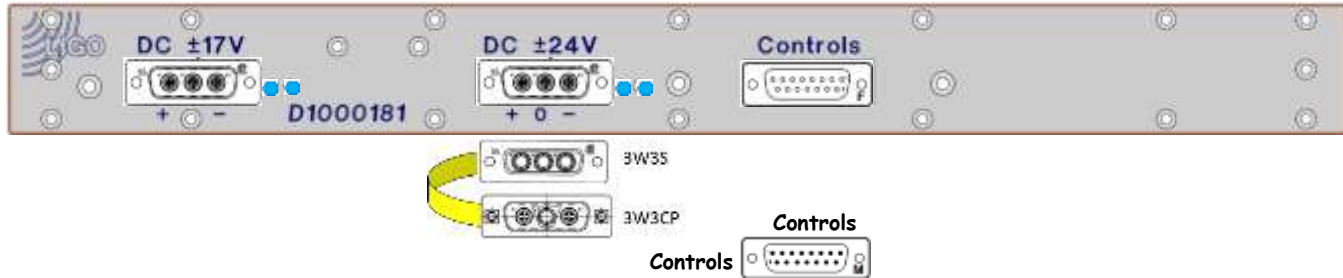

[S1000788](#)

Rear



D0901781

Front



S1102629

Rear

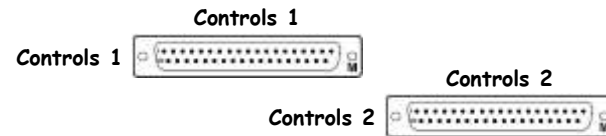
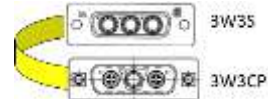



[D1100691](#)

Front



[S1104005](#)

Rear

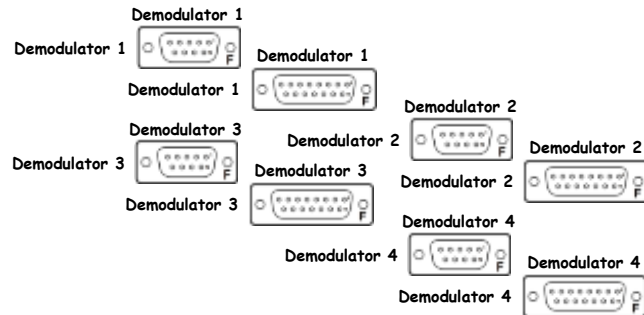
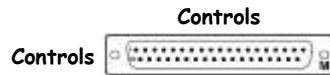



D1100696

Front



S1103984

Rear

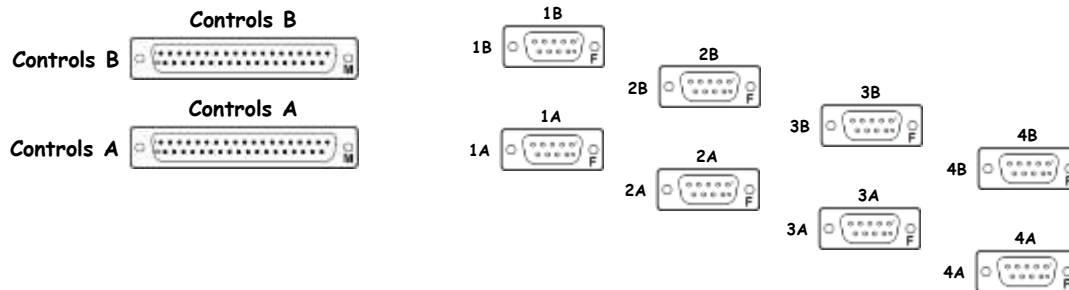

<< L1-ISC-R1

LSC RFPD Interface ±18VDC

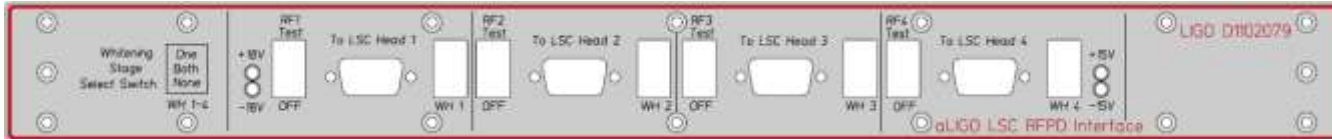

D1102079

Front



Sxxxxxxx

Rear

<< L1-ISC-R1

WFS RFPD Interface ±15VDC

D1101905



D1101906

Front

D1101908



Sxxxxxxx

Rear

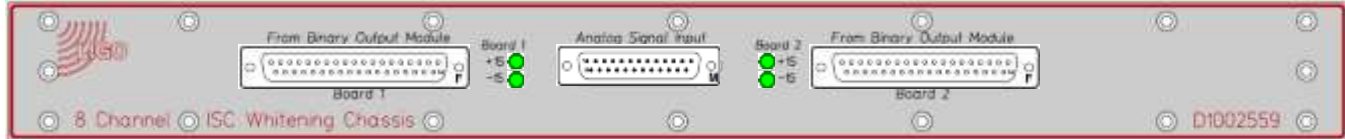

D1002559

Front

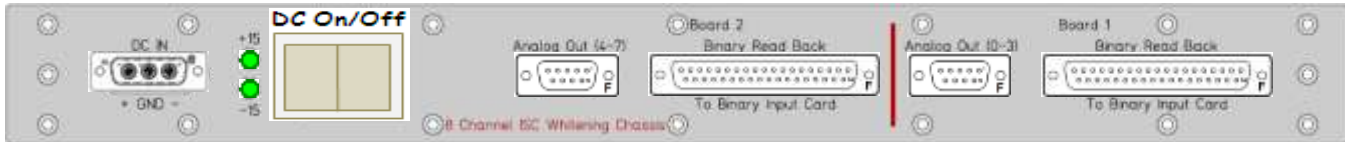
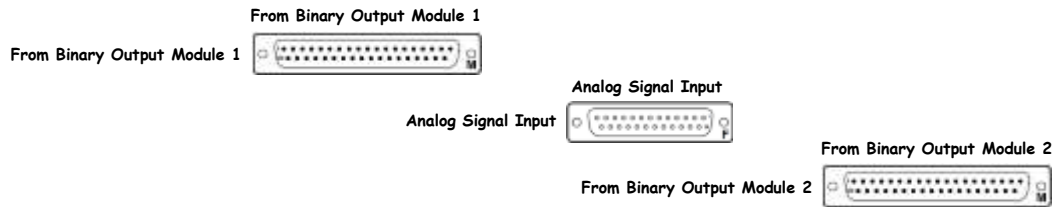

S1101612

Rear

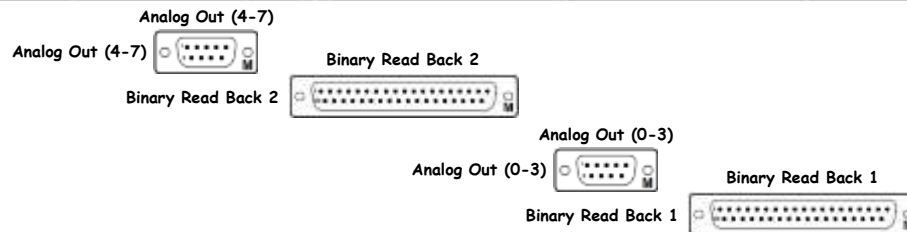

<< L1-ISC-R1 ISC Whitening Chassis (ASC IMC WFS_A 24MHz) D0902796 S1000991 ±15VDC



D0902796

Front

D1002032

LSC



Sxxxxxxx

Rear

RF Mon Out Ch 3&4

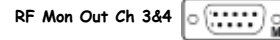

RF Mon Out Ch 3&4

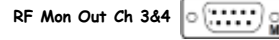

I & Q Outputs

I & Q Outputs



D1002031

WFS



Sxxxxxxx

Rear

RF Mon Out Ch 3&4

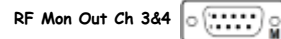

RF Mon Out Ch 3&4

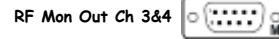

I & Q Outputs

I & Q Outputs



<< L1-ISC-R1

WFS Demodulator Patch Panel

D1100905

Sxxxxxxx

No Power

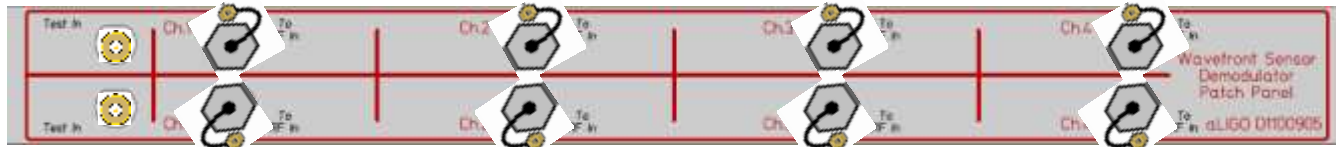

D1100905

Front

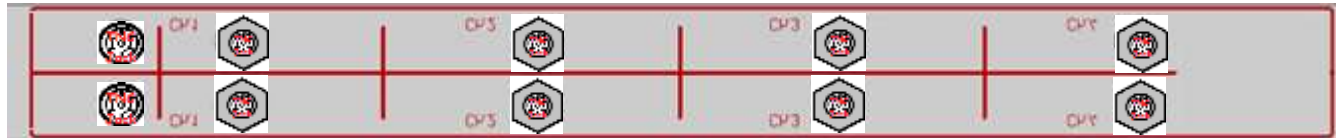

Sxxxxxxx

Rear

<< L1-ISC-R1 ISC Whitening Chassis (ASC IMC WFS_B 24MHz) D0902796 S1001024 ±15VDC



D0902796

Front

D1002032

LSC



Sxxxxxxx

Rear

RF Mon Out Ch 3&4

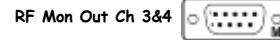

RF Mon Out Ch 3&4

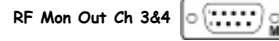

I & Q Outputs

I & Q Outputs



D1002031

WFS



Sxxxxxxx

Rear

RF Mon Out Ch 3&4

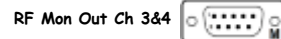

RF Mon Out Ch 3&4

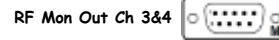

I & Q Outputs

I & Q Outputs



<< [L1-ISC-R1](#) ISC Whitening Chassis (ASC IMC WFS_A 24MHz) D1002559 S1101571 ±15VDC



D1002559

Front

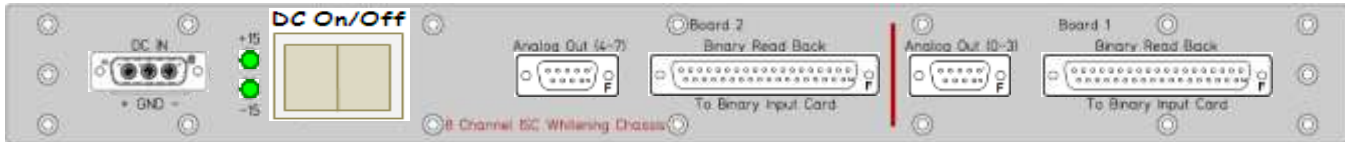
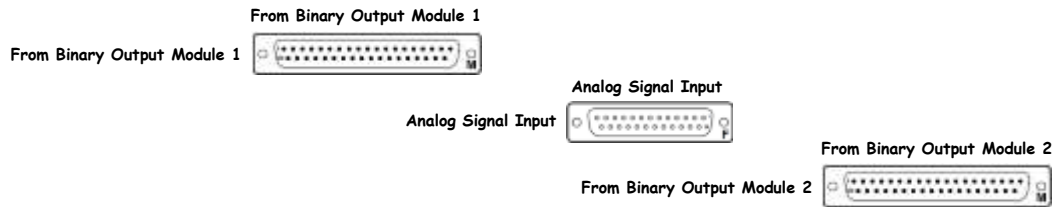

S1101571

Rear

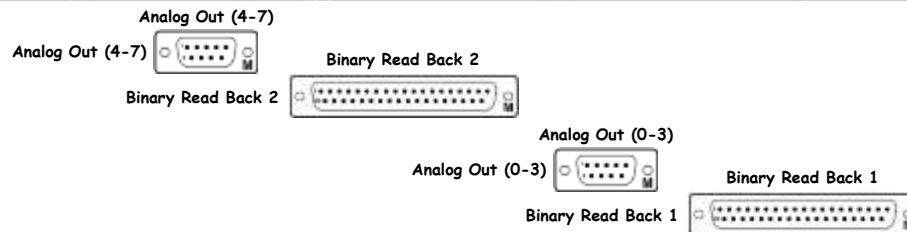

D1100482 - S1202844



<< [L1-ISC-R1](#)

Differential to Single-Ended Receiver

[D1100482](#)

[S1202844](#)

±15VDC



[D1100482](#)

Front



[S1202844](#)

Rear





- RF Distribution Panel 13
- RF Distribution Panel 14
- 45 MHz Distribution Amplifier
- 9.099/8.684 MHz Distribution Amplifier
- 9.099/8.684 MHz Dual Delay Line
- 9.099/8.684 MHz 2-Channel Demodulator
- ISC Whitening (LSC POPAIR A 9&45, LSC REFLAIR A 45)
- LSC I/Q Demodulator (LSC POPAIR A 9&45, LSC REFLAIR A 45)
- LSC Demodulator Patch Panel
- LSC I/Q Demodulator (LSC POPAIR B 18&90, LSC REFLAIR B 27&135)
- ISC Whitening (LSC POPAIR B 18&90, LSC REFLAIR B 27&135)
- LSC I/Q Demodulator (LSC POP, LSC REFL)
- LSC Demodulator Patch Panel
- ISC Whitening (LSC POP, LSC REFL)
- ISC Whitening (ASC REFLAIR A 9MHz)
- WFS I/Q Demodulator (ASC REFLAIR A 9MHz)
- WFS Demodulator Patch Panel
- WFS I/Q Demodulator (ASC REFLAIR A 45MHz)
- ISC Whitening (ASC REFLAIR A 45MHz)
- ISC Whitening (ASC REFLAIR B 9MHz)
- WFS I/Q Demodulator (ASC REFLAIR B 9MHz)
- WFS Demodulator Patch Panel
- WFS I/Q Demodulator (ASC REFLAIR B 45MHz)
- ISC Whitening (ASC REFLAIR B 45MHz)
- WFS I/Q Demodulator (Spare AIR to VAC)
- WFS Demodulator Patch Panel
- ISC Whitening (Spare AIR to VAC)

Dxxxxxxx	42	Sxxxxxxx
Dxxxxxxx	41	Sxxxxxxx
Dxxxxxxx	40	Sxxxxxxx
D1000124	39	Sxxxxxxx
D1000124	38	S1000665
D0900128	37	S1000658
	36	S1103416
D1000181	35	
	34	S1000784
D1002559	33	
	32	S1101620
D0902796	31	
D1100956	30	S1001004
D0902796	29	Sxxxxxxx
	28	S1001007
D1002559	27	
	26	S1101624
D0902796	25	
D1100956	24	S1001012
D1002559	23	Sxxxxxxx
	22	S1101625
D1002559	21	
	20	S1101596
D0902796	19	
D1100905	18	S1001030
D0902796	17	Sxxxxxxx
	16	S1000986
D1002559	15	
	14	S1101167
D1002559	13	
	12	S1101621
D0902796	11	
D1100905	10	S1000987
D0902796	9	Sxxxxxxx
	8	S1000990
D1002559	7	
	6	S1101609
D0902796	5	
D1100905	4	S1000973
D1002559	3	Sxxxxxxx
	2	S1101597
	1	

- No Power
- No Power
- ±17VDC, ±24VDC
- ±17VDC, ±24VDC
- +15VDC
- ±17VDC, ±24VDC
- ±15VDC
- ±15VDC
- No Power
- ±15VDC
- ±15VDC
- ±15VDC
- No Power
- ±15VDC
- ±15VDC
- ±15VDC
- No Power
- ±15VDC
- ±15VDC

Front

Rear

ISC-R2 is part of D1001425.

L1-ISC-R2 Details

[<< L1-ISC-R2](#)

RF Distribution Panel 13

Dxxxxxxx

Sxxxxxxx

No Power

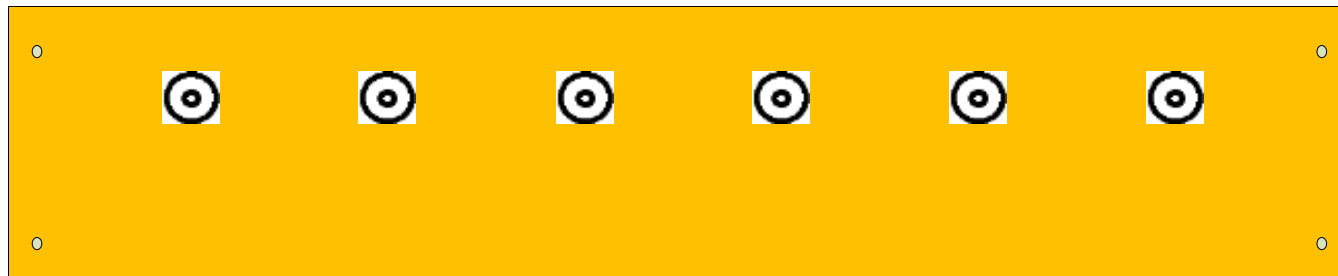
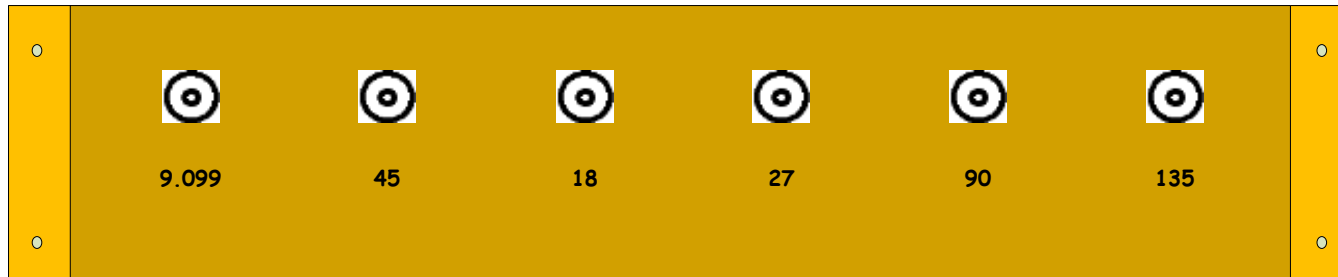

<< [L1-ISC-R2](#)

RF Distribution Panel 14

Dxxxxxxx

Sxxxxxxx

No Power

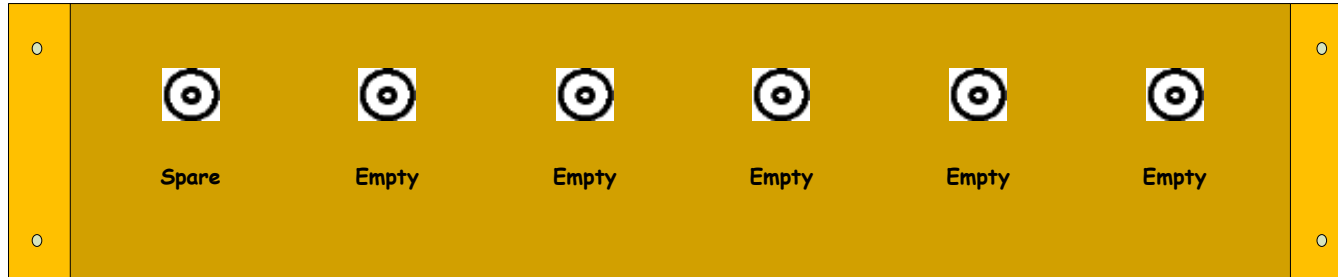

Dxxxxxxx

Front

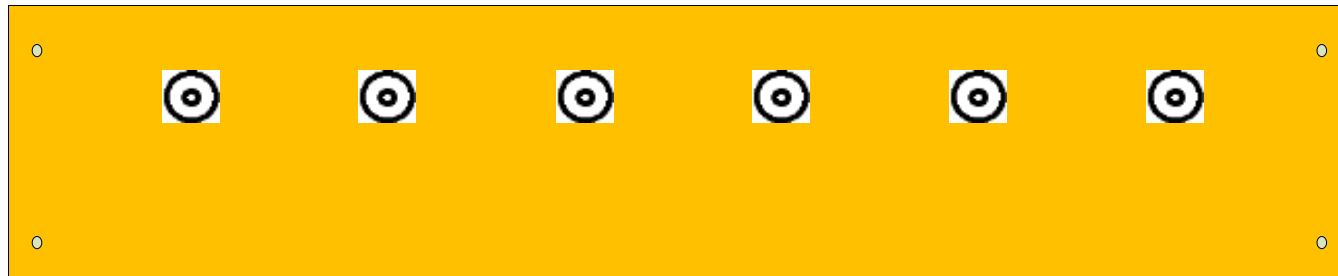

Sxxxxxxx

Rear

45 MHz Distribution Amplifier D1000124 S1000665 ±17VDC, ±24VDC

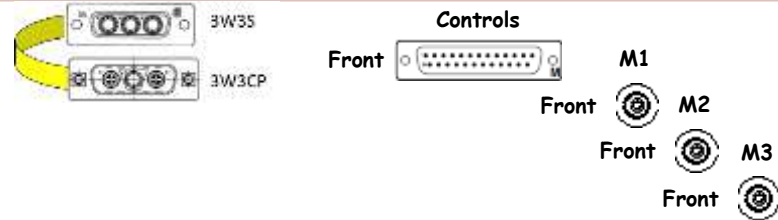
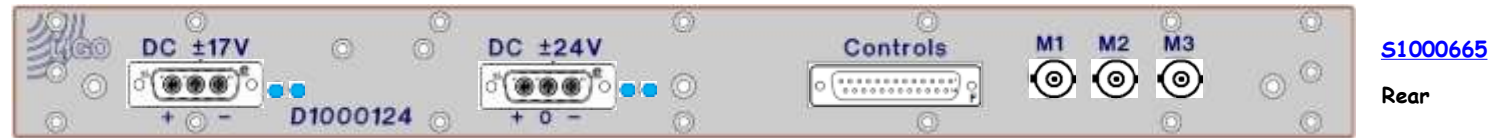
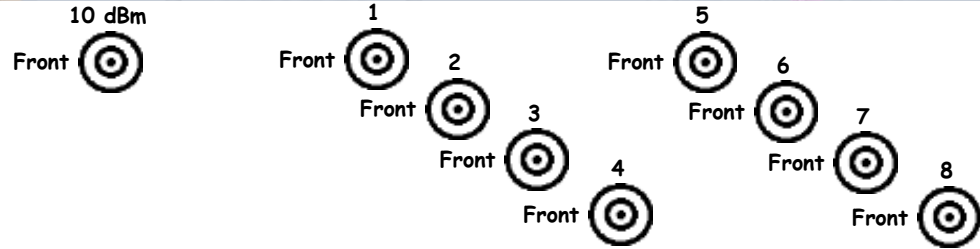
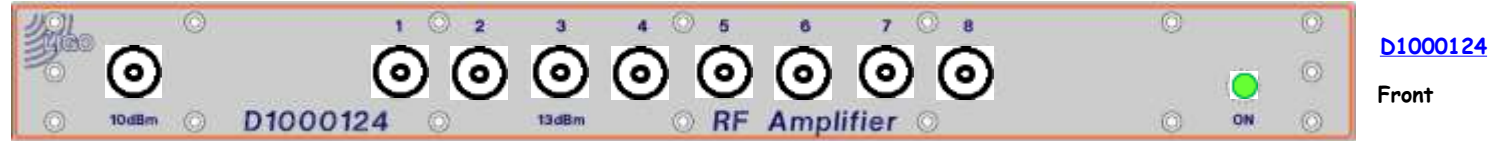

9.099/8.684 MHz Distribution Amplifier D1000124 S1000658 ±17VDC, ±24VDC

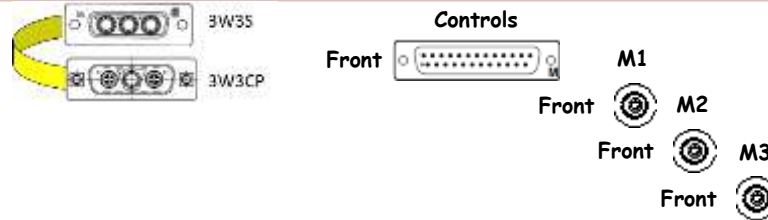
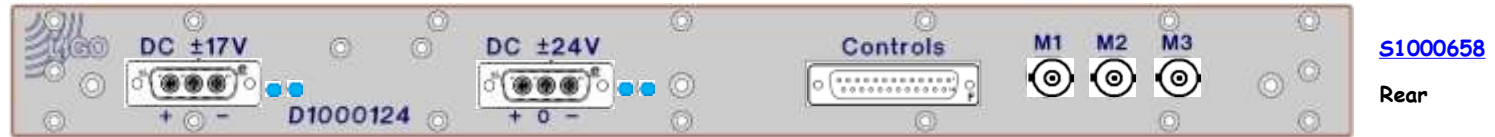
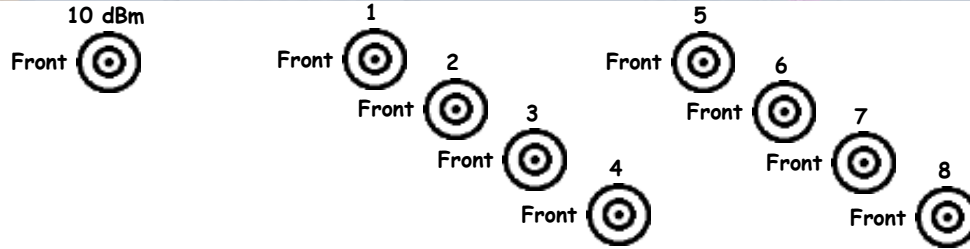
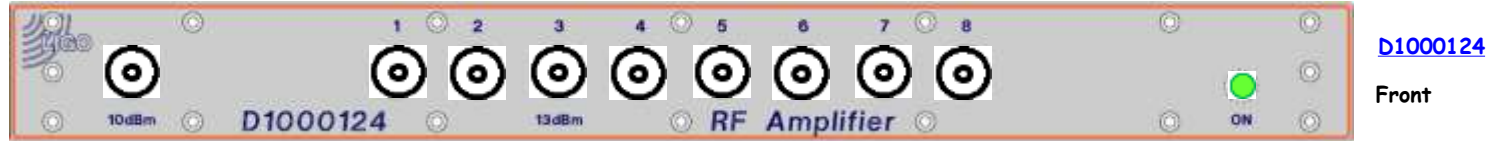



D0900128

Front



S1103416

Rear

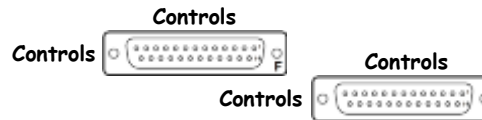



D1000181

Front



S1000784

Rear

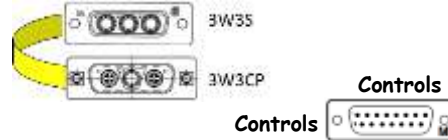

Controls

Controls



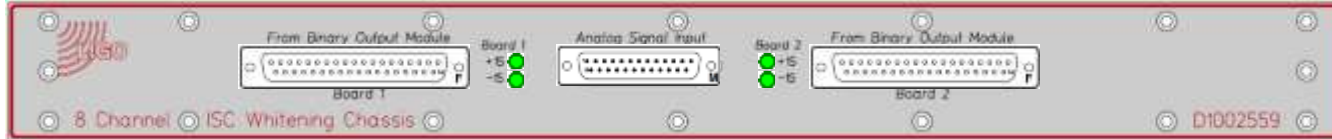

D1002559

Front

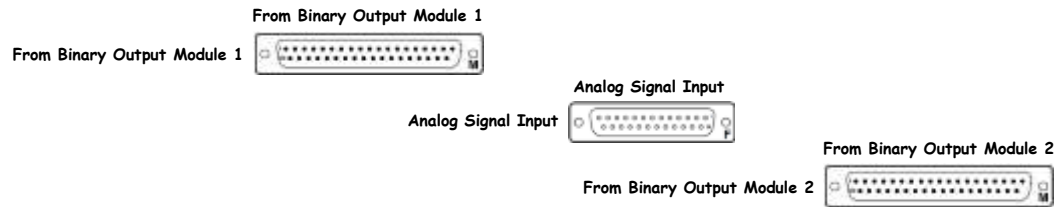

S1101620

Rear

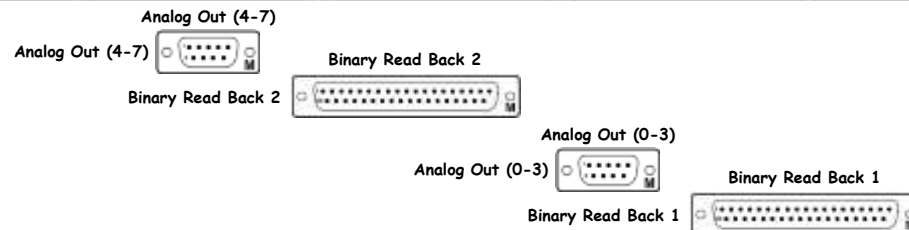



[D0902796](#)

Front

[D1002032](#)

LSC



[S1001004](#)

Rear

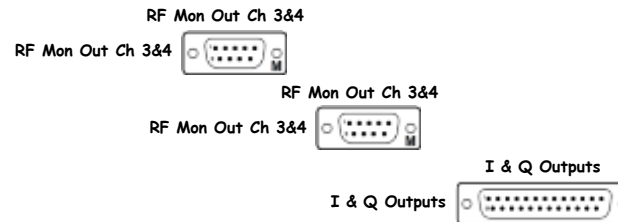

<< L1-ISC-R2

LSC Demodulator Patch Panel No Power



D1100956

Front



Sxxxxxxx

Rear



D0902796

Front

D1002032

LSC



S1001007

Rear

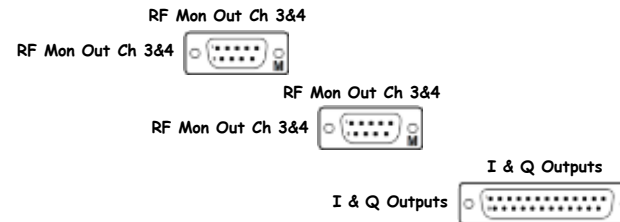

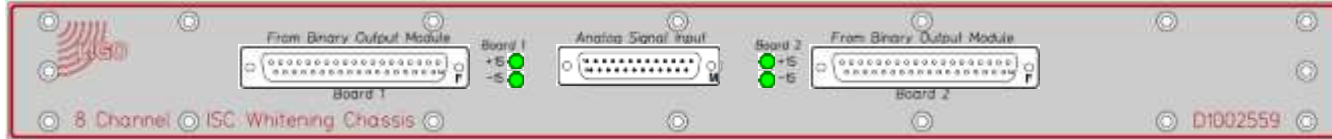

D1002559

Front

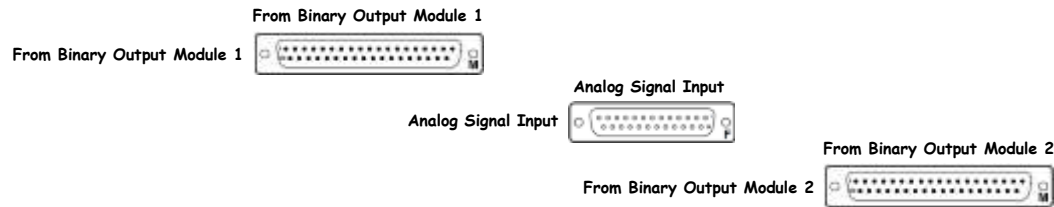

S1101624

Rear

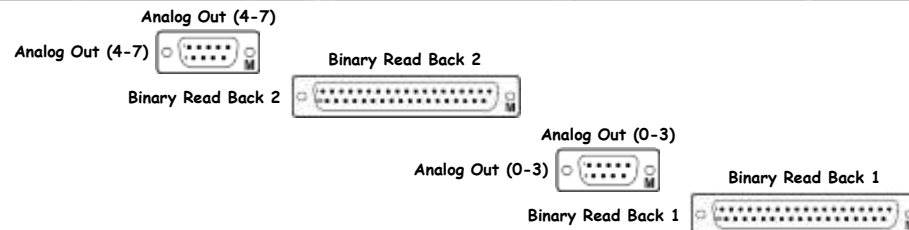

D0902796 - S1001012



<< [L1-ISC-R2](#)

LSC I/Q Demodulator (LSC POP, LSC REFL)

[D0902796](#)

[S1001012](#)

±15VDC



[D0902796](#)

Front

[D1002032](#)

LSC



[S1001012](#)

Rear

RF Mon Out Ch 3&4

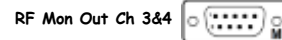

RF Mon Out Ch 3&4

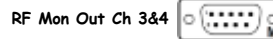

I & Q Outputs



<< L1-ISC-R2

LSC Demodulator Patch Panel No Power



D1100956

Front



Sxxxxxxx

Rear



D1002559

Front

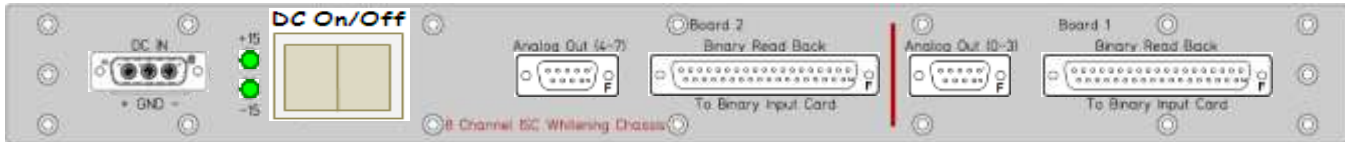
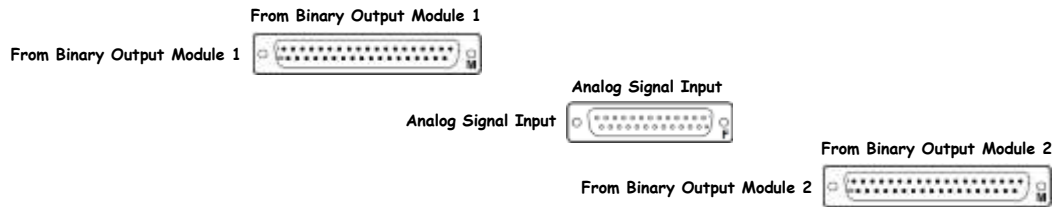

S1101625

Rear

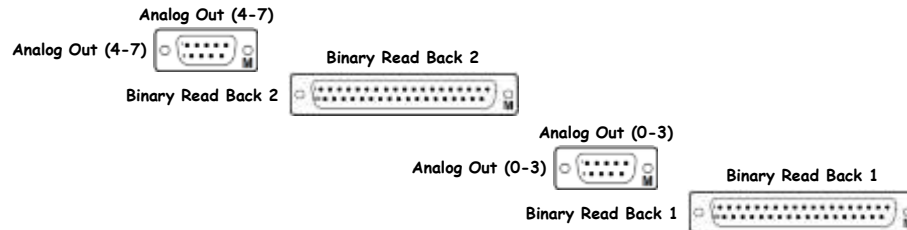



D1002559

Front

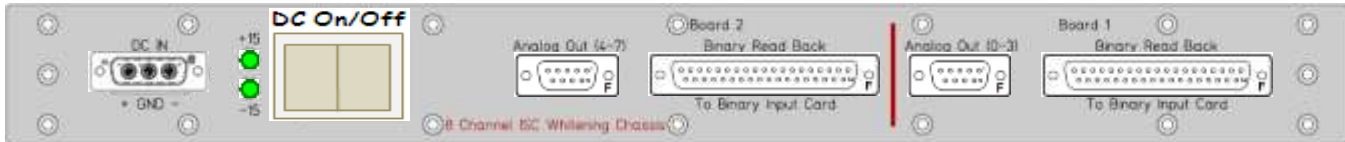
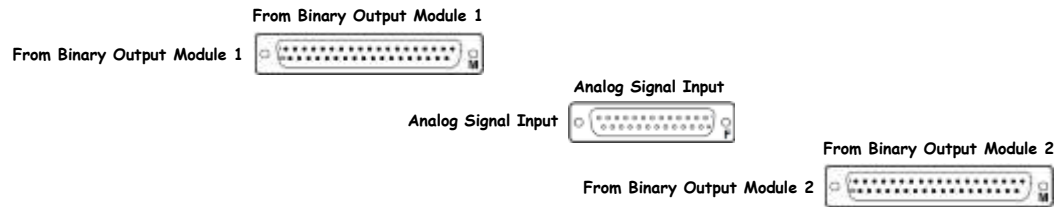

S1101596

Rear

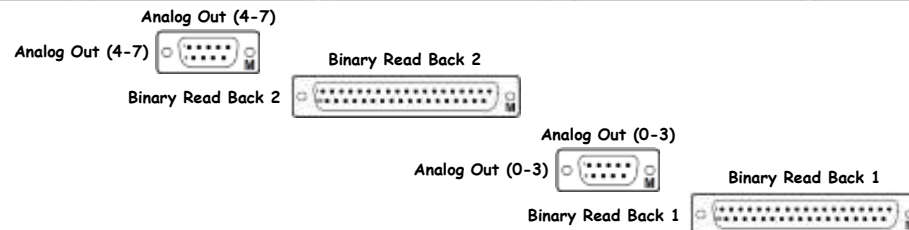

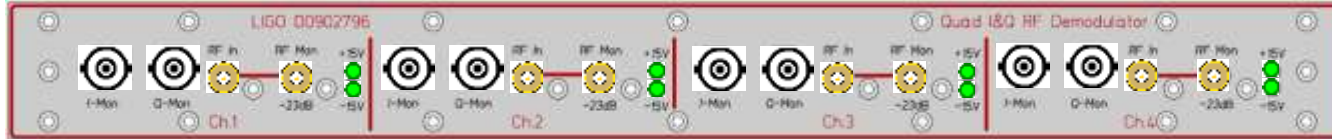

D0902796

Front

D1002031

WFS



S1001030

Rear

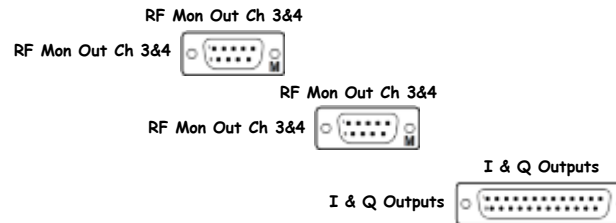

<< L1-ISC-R2

WFS Demodulator Patch Panel No Power

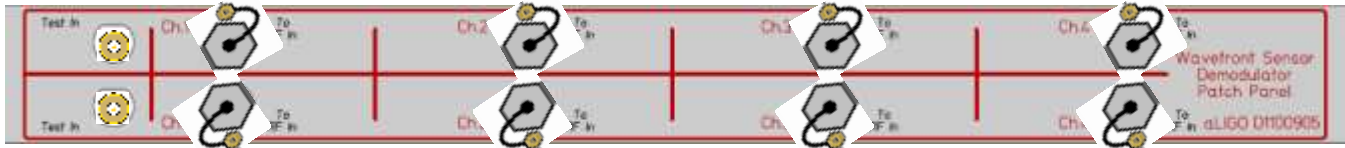

[D1100905](#)

Front

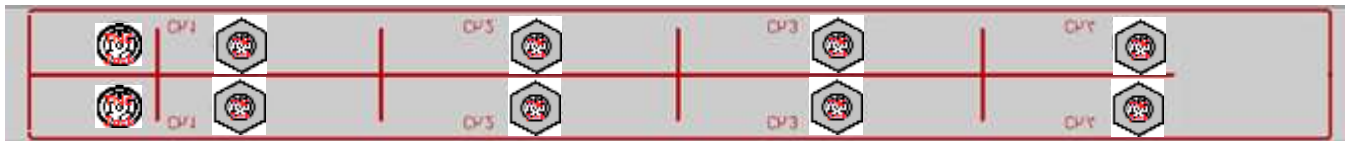

Sxxxxxxx

Rear



D0902796

Front

D1002031

WFS



S1000986

Rear

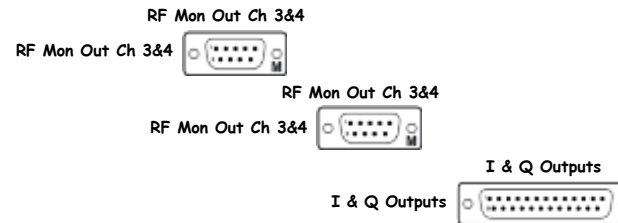

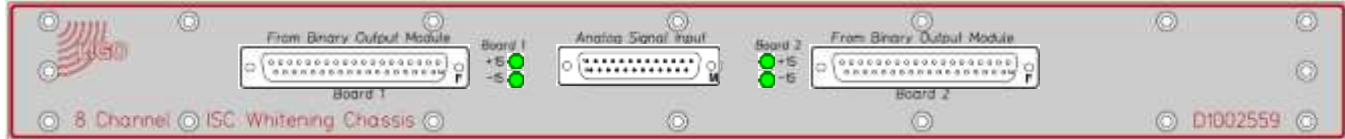

D1002559

Front

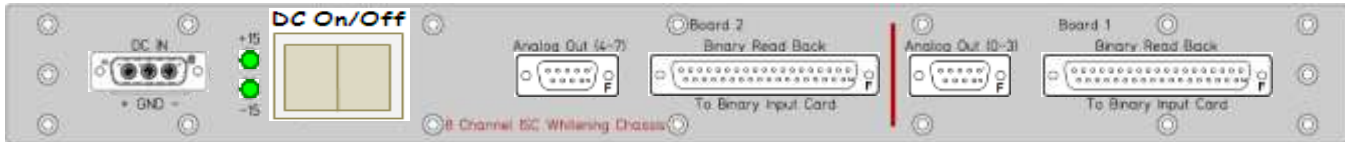
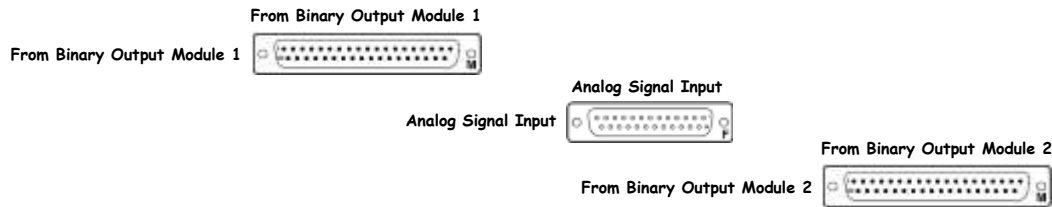

S1101167

Rear

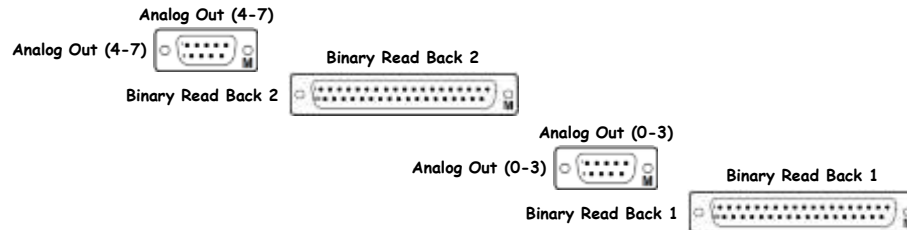

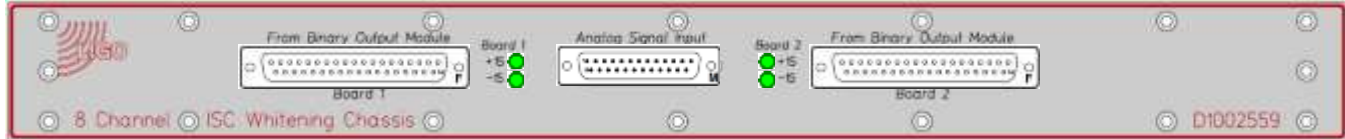

D1002559

Front

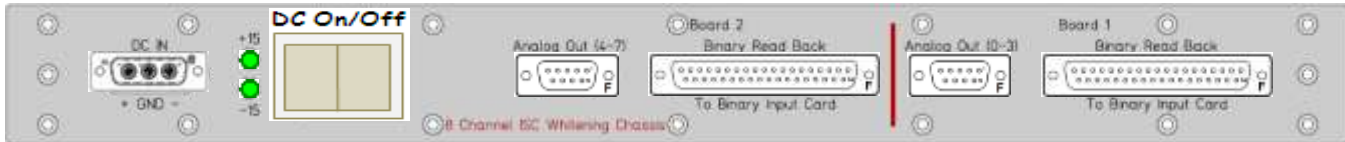
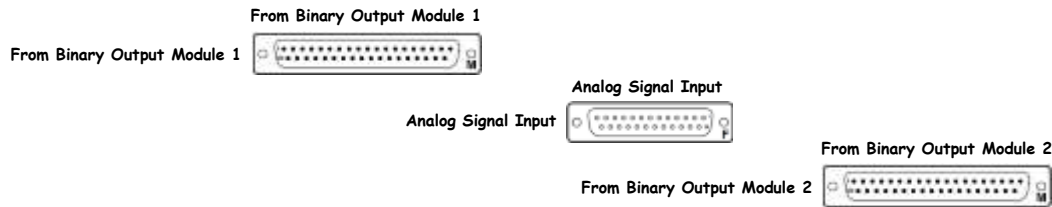

S1101621

Rear

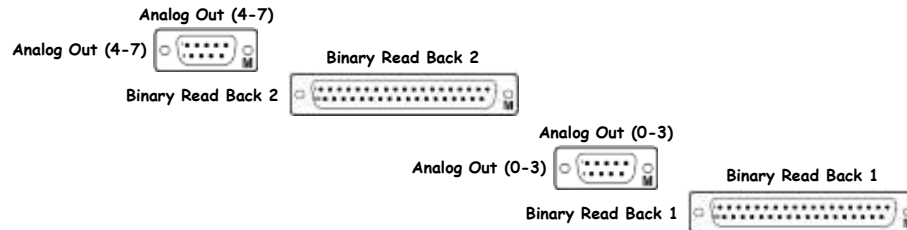



D0902796

Front

D1002031

WFS



S1000987

Rear

RF Mon Out Ch 3&4

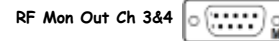

RF Mon Out Ch 3&4

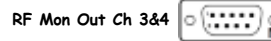

I & Q Outputs



<< L1-ISC-R2

WFS Demodulator Patch Panel No Power

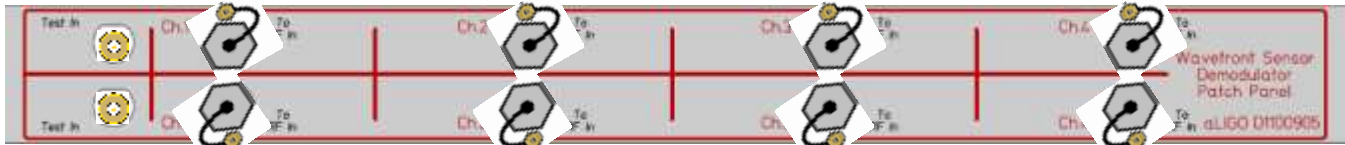

D1100905

Front

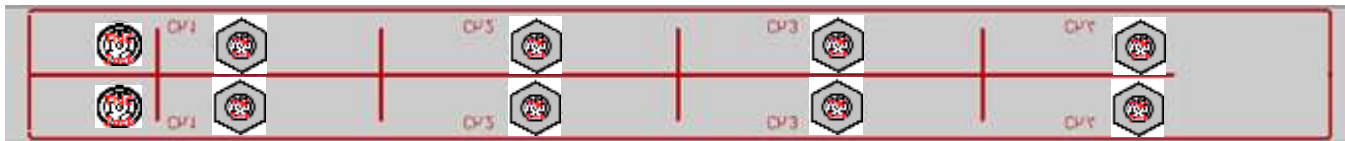

Sxxxxxxx

Rear

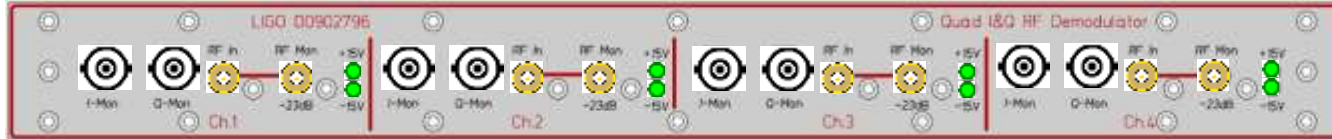

D0902796

Front

D1002031

WFS



S1000990

Rear

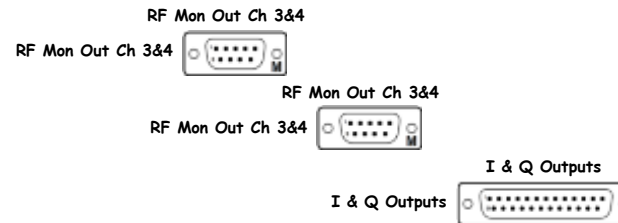

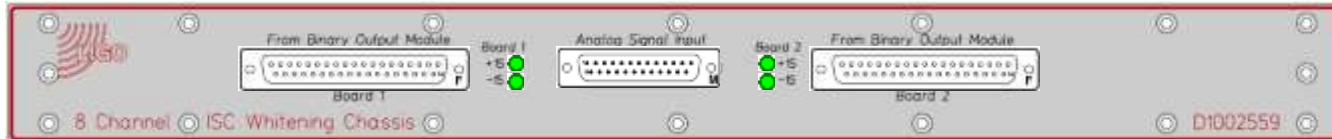

D1002559

Front

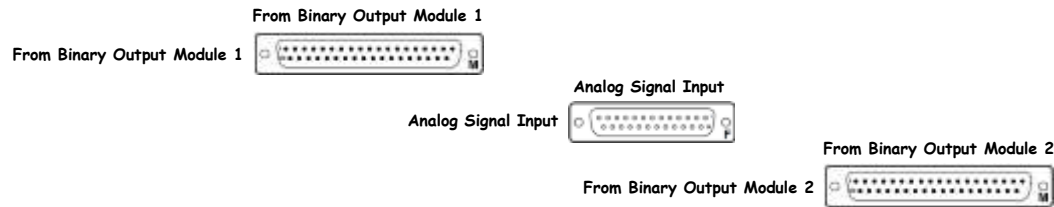

S1101609

Rear

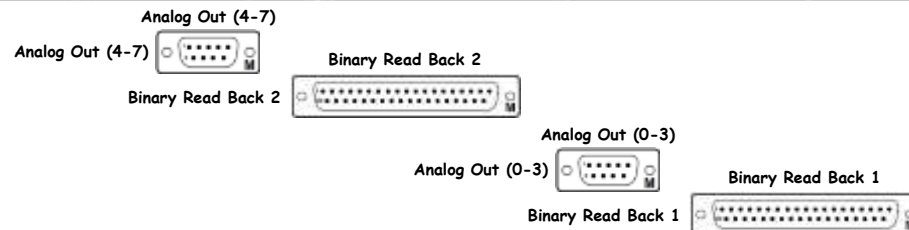



D0902796

Front

D1002031

WFS



S1000973

Rear

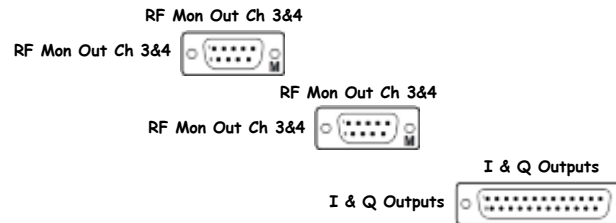

<< L1-ISC-R2

WFS Demodulator Patch Panel No Power

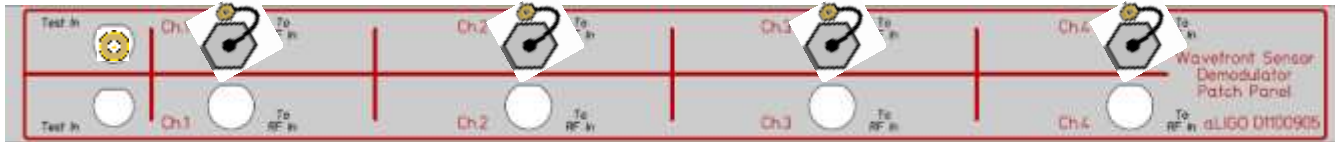

D1100905

Front

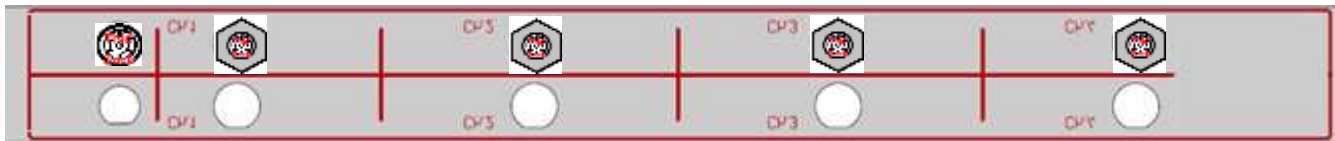

Sxxxxxxx

Rear

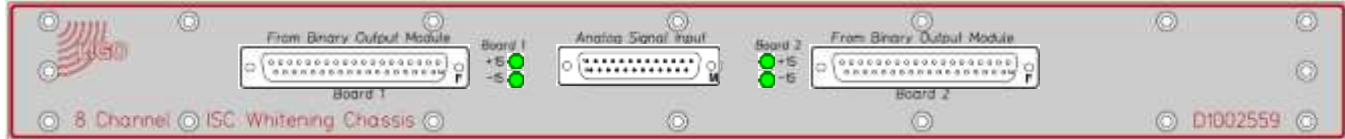

D1002559

Front

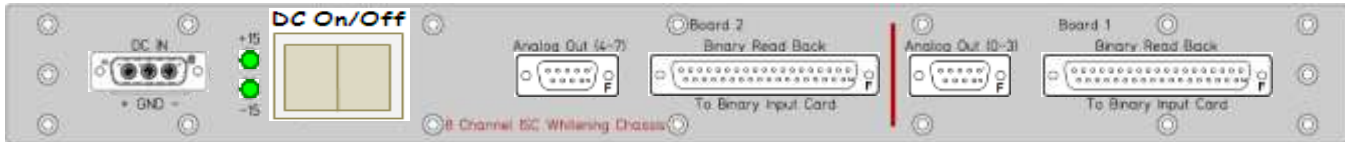
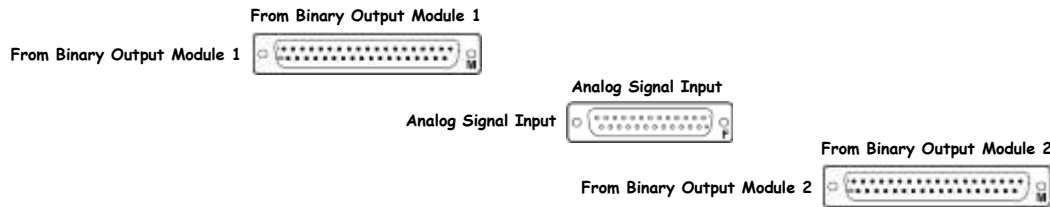

S1101597

Rear

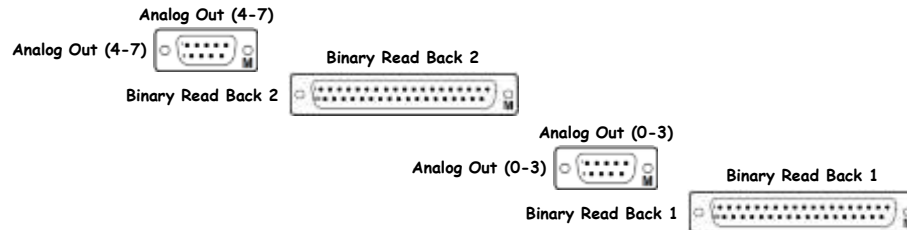

- RF Distribution Panel 15
- RF Distribution Panel 16
- 9.099/8.684 MHz Distribution Amplifier
- 36 MHz Distribution Amplifier
- 45 MHz Distribution Amplifier
- ISC Whitening (ASC ASAIR A 36MHz)
- WFS I/Q Demodulator (ASC ASAIR A 36MHz)
- WFS Demodulator Patch Panel
- WFS I/Q Demodulator (ASC ASAIR A 45MHz)
- ISC Whitening (ASC ASAIR A 45MHz)
- ISC Whitening (Spare AIR to VAC)
- WFS I/Q Demodulator (Spare AIR to VAC)
- WFS Demodulator Patch Panel
- ISC Whitening (ASC ASAIR B 36MHz)
- WFS I/Q Demodulator (ASC ASAIR B 36MHz)
- WFS Demodulator Patch Panel
- WFS I/Q Demodulator (ASC ASAIR B 45MHz)
- ISC Whitening (ASC ASAIR B 45MHz)
- ISC Whitening (LSC ASAIR A 45, B 18, B 90MHz)
- LSC I/Q Demodulator (LSC ASAIR A 45, B 18, B 90MHz)
- WFS Demodulator Patch Panel

Dxxxxxxx	42	Sxxxxxxx	No Power
Dxxxxxxx	41	Sxxxxxxx	No Power
Dxxxxxxx	40	Sxxxxxxx	No Power
D1000124	39	S1000659	±17VDC, ±24VDC
D1000124	38	S1000663	±17VDC, ±24VDC
D1000124	37	S1000666	±17VDC, ±24VDC
D1002559	36	S1101575	±15VDC
D0902796	35	S1001033	±15VDC
D1100905	34	Sxxxxxxx	No Power
D0902796	33	S1001027	±15VDC
D1002559	32	S1101588	±15VDC
D1002559	31	S1101589	±15VDC
D0902796	30	S1000983	±15VDC
D1100905	29	Sxxxxxxx	No Power
D1002559	28	S1101598	±15VDC
D0902796	27	S1000988	±15VDC
D1100905	26	Sxxxxxxx	No Power
D1002559	25	S1001025	±15VDC
D0902796	24	S1101610	±15VDC
D1100905	23	S1101592	±15VDC
D1002559	22	S1001001	±15VDC
D0902796	21	Sxxxxxxx	No Power
D1100905	20		
	19		
	18		
	17		
	16		
	15		
	14		
	13		
	12		
	11		
	10		
	9		
	8		
	7		
	6		
	5		
	4		
	3		
	2		
	1		



ISC-R3 is part of D1001426

Front

Rear

L1-ISC-R3 Details

<< [L1-ISC-R3](#)

RF Distribution Panel 15

Dxxxxxxx

Sxxxxxxx

No Power

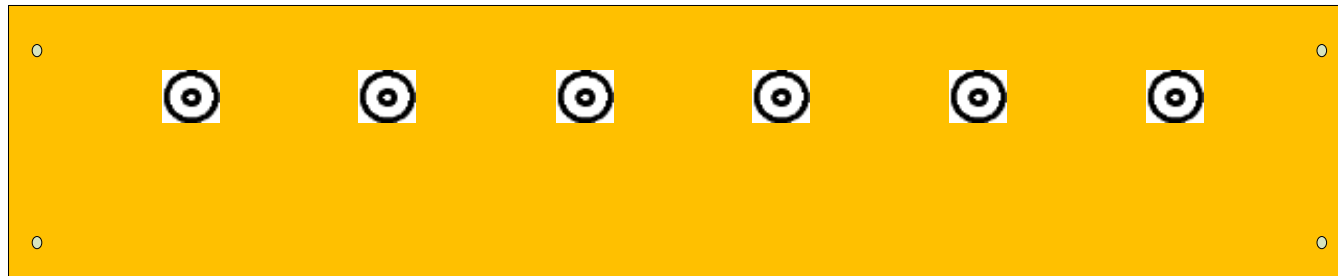
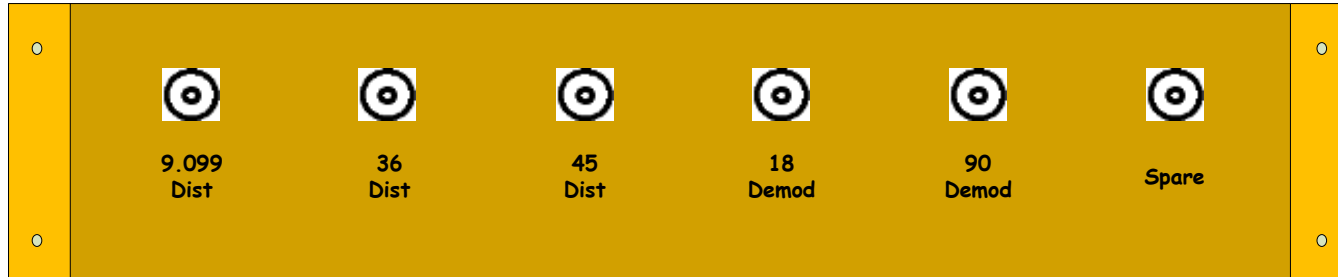

<< [L1-ISC-R3](#)

RF Distribution Panel 16

Dxxxxxxx

Sxxxxxxx

No Power

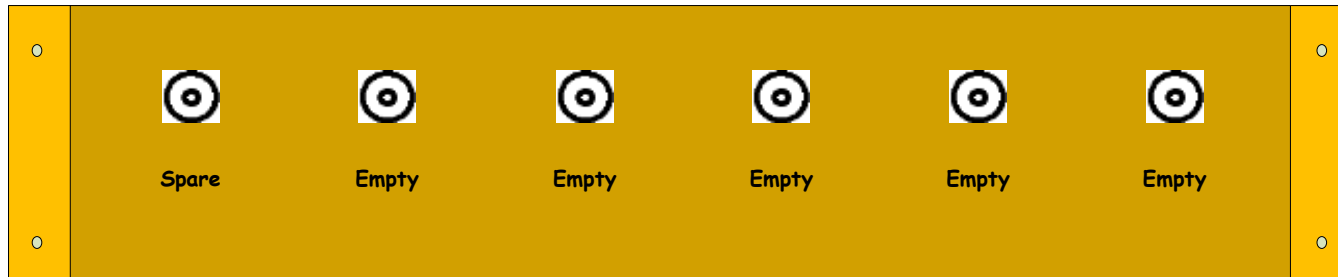

Dxxxxxxx

Front

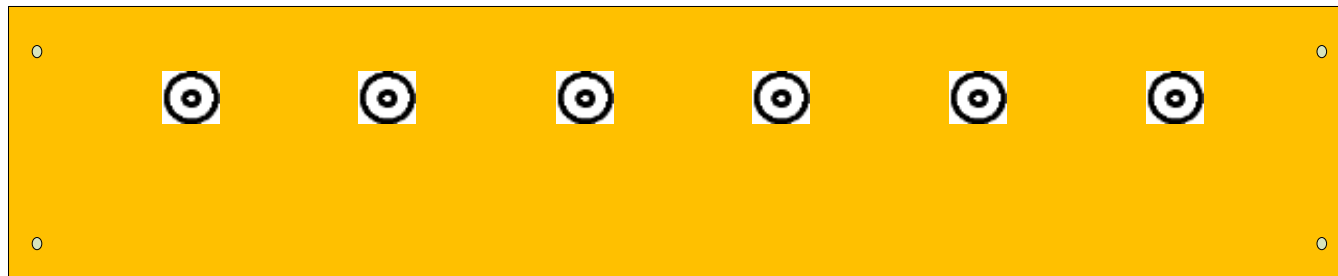

Sxxxxxxx

Rear

9.099/8.684 MHz Distribution Amplifier D1000124 S1000659 ±17VDC, ±24VDC

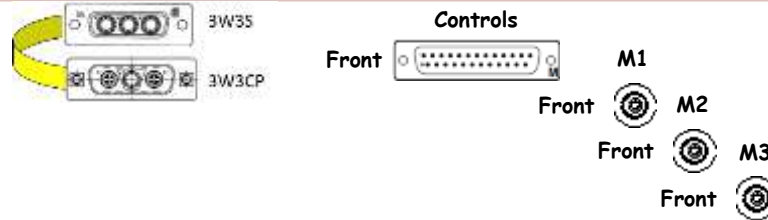
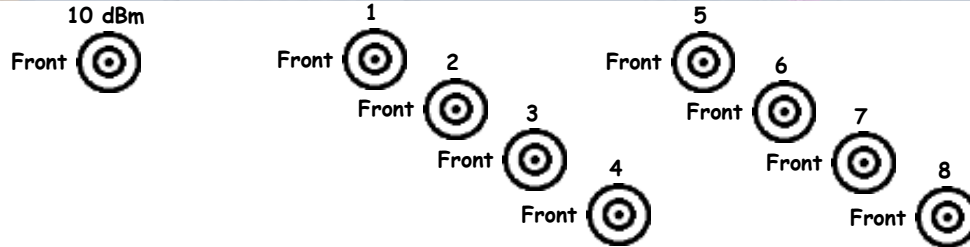
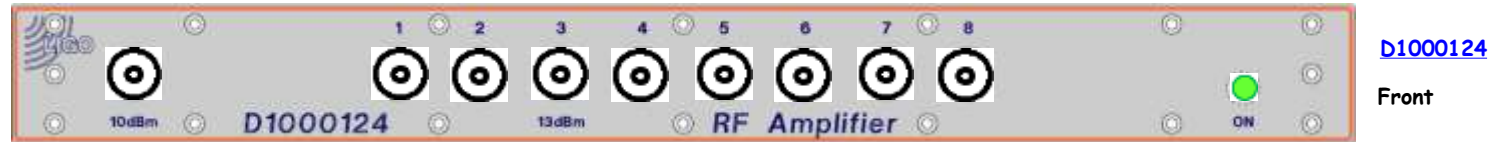

36 MHz Distribution Amplifier D1000124 S1000663 ±17VDC, ±24VDC

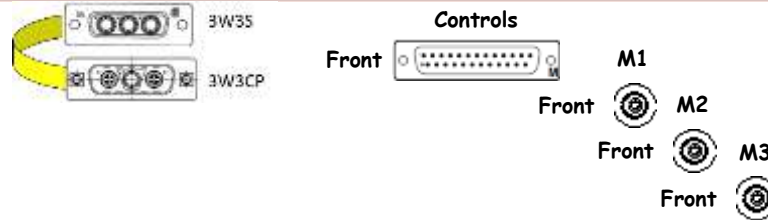
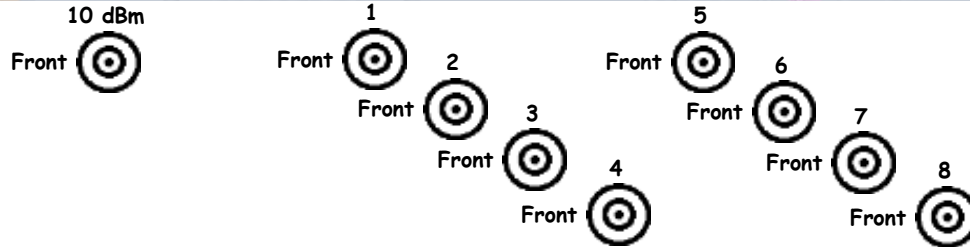
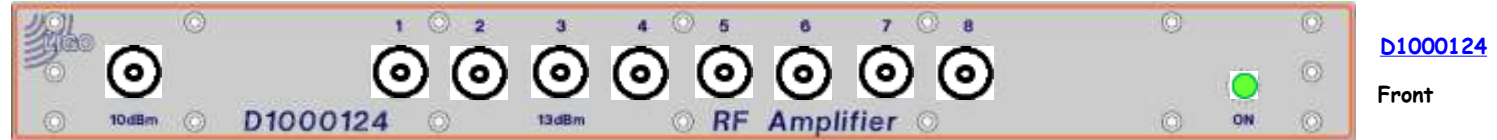

45 MHz Distribution Amplifier D1000124 S1000666 ±17VDC, ±24VDC

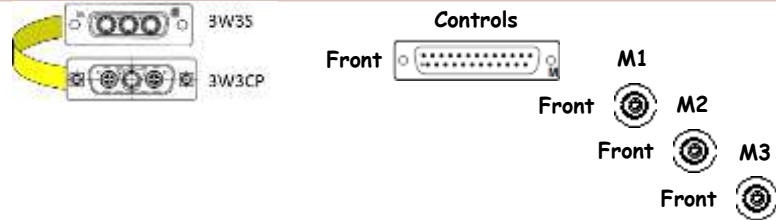
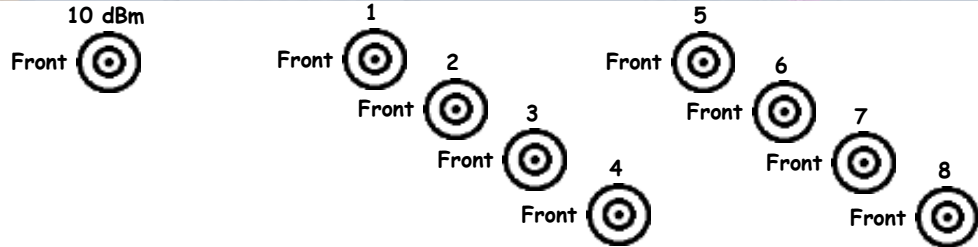
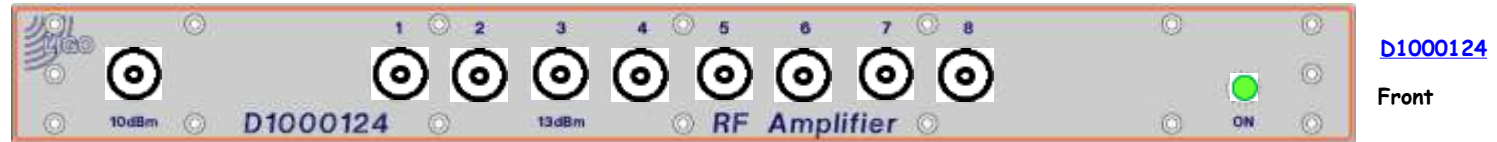

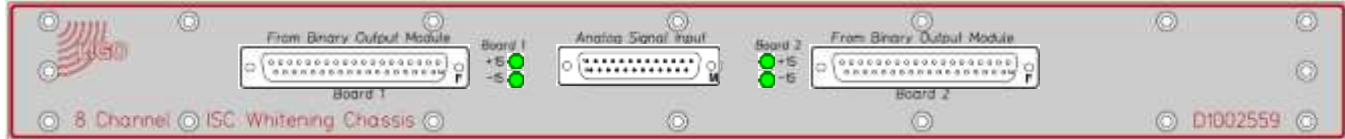

D1002559

Front

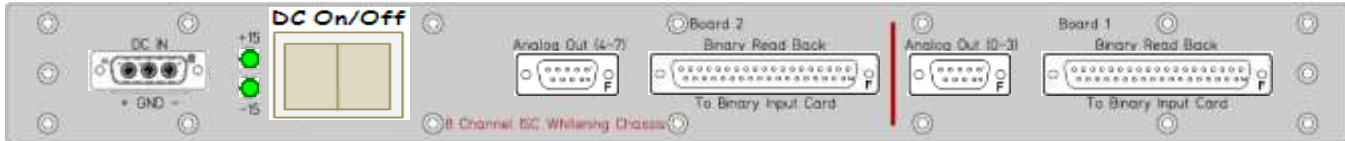
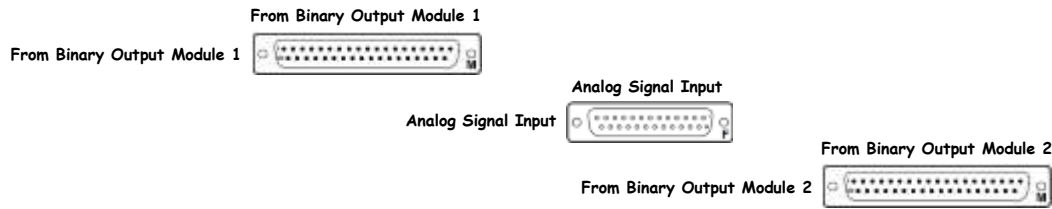

S1101575

Rear

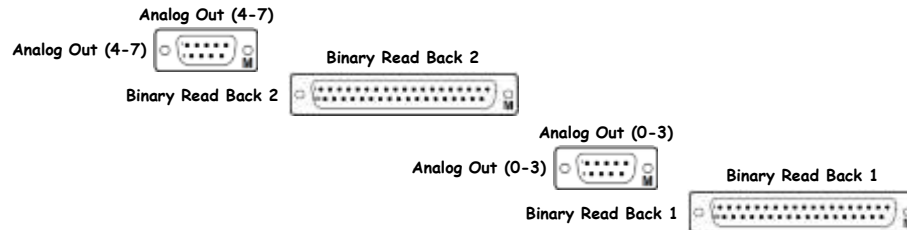



[D0902796](#)

Front

[D1002032](#)

LSC



[S1001033](#)

Rear

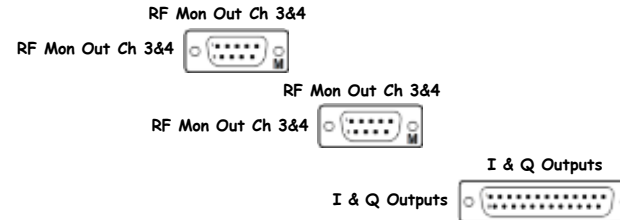

<< L1-ISC-R3

WFS Demodulator Patch Panel No Power

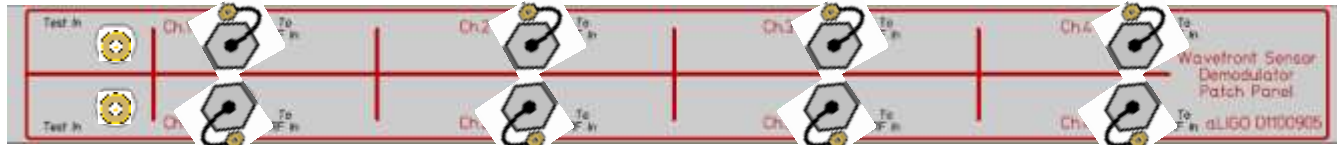

D1100905

Front

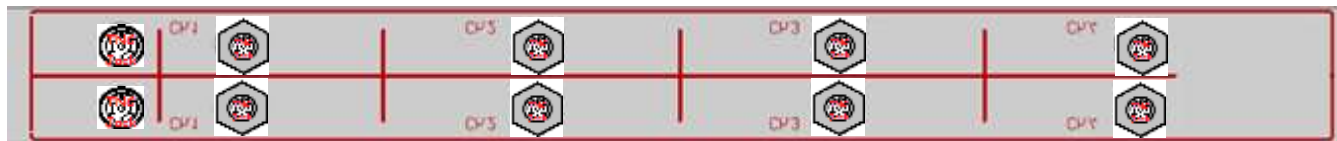

Sxxxxxxx

Rear

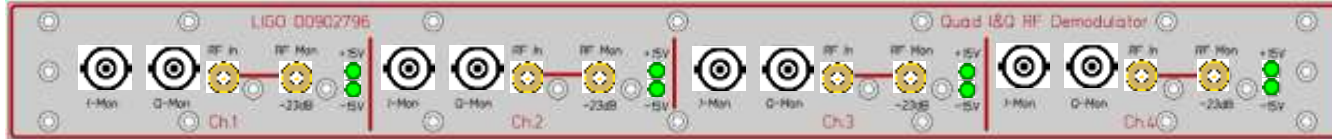

[D0902796](#)

Front

[D1002032](#)

LSC



[S1001027](#)

Rear

RF Mon Out Ch 3&4

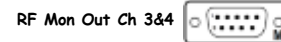

RF Mon Out Ch 3&4

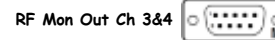

I & Q Outputs





D1002559

Front

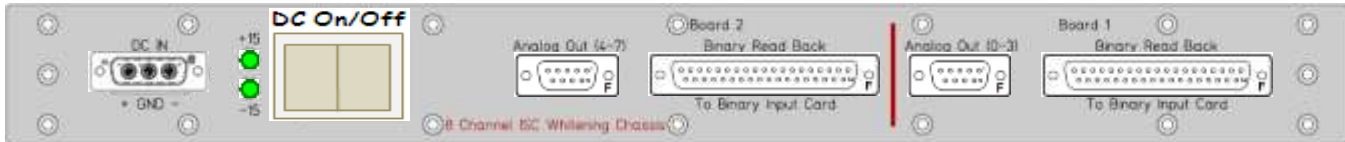
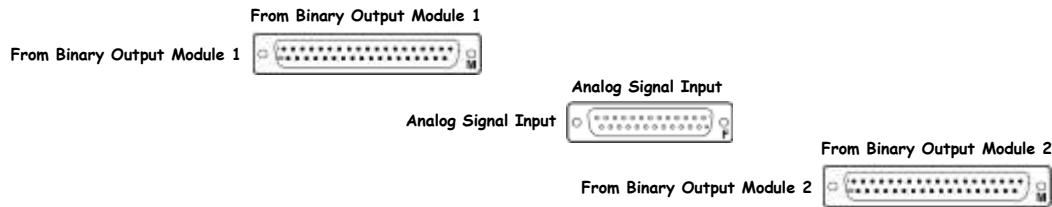

S1101588

Rear

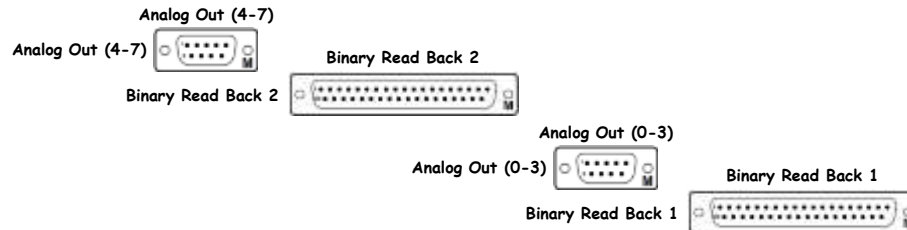

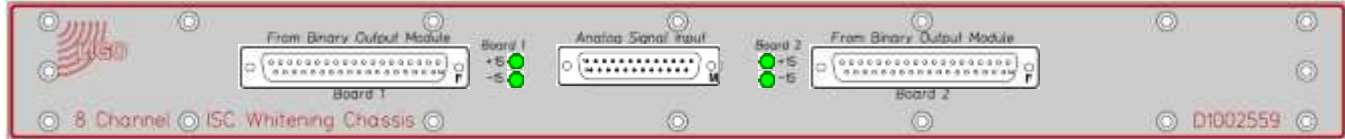

D1002559

Front

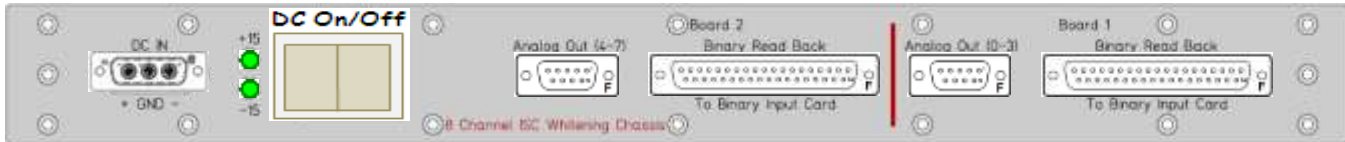
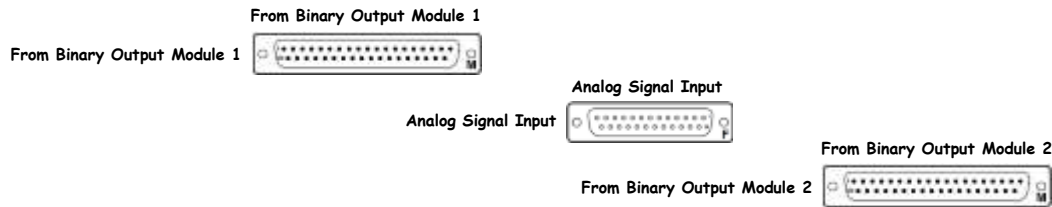

S1101589

Rear

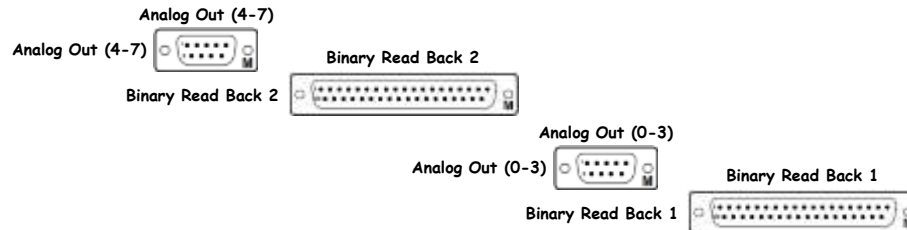



[D0902796](#)

Front

[D1002032](#)

LSC



[S1000983](#)

Rear

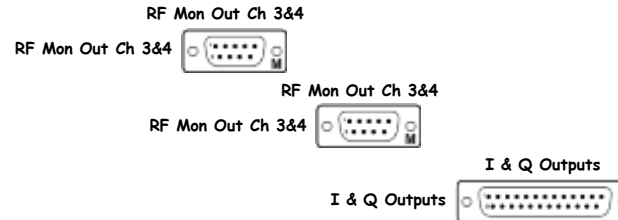

<< L1-ISC-R3

WFS Demodulator Patch Panel No Power

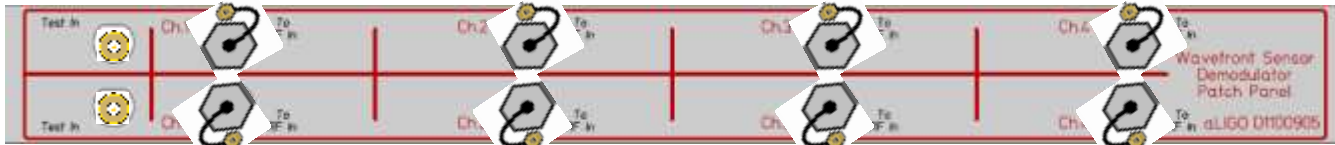

D1100905

Front

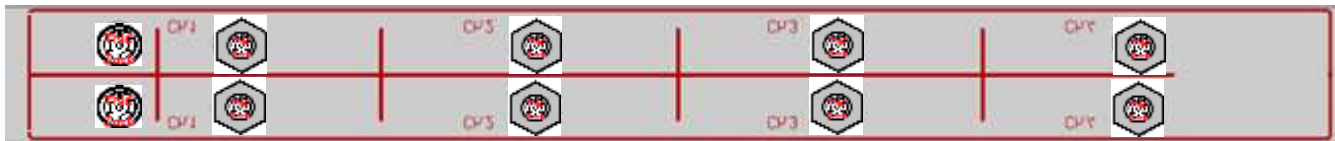

Sxxxxxxx

Rear

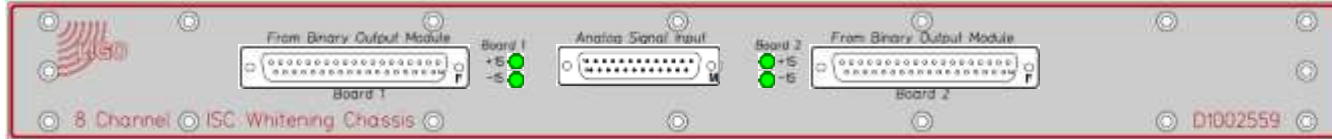

D1002559

Front

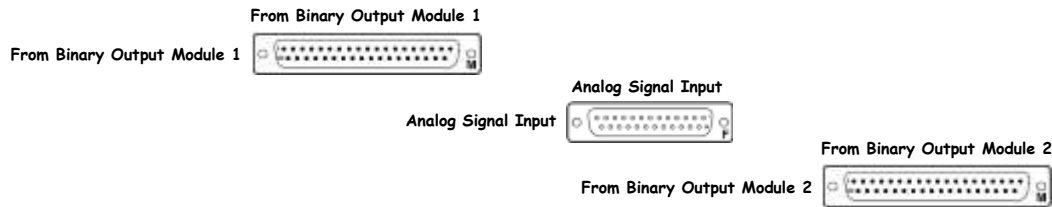

S1101598

Rear

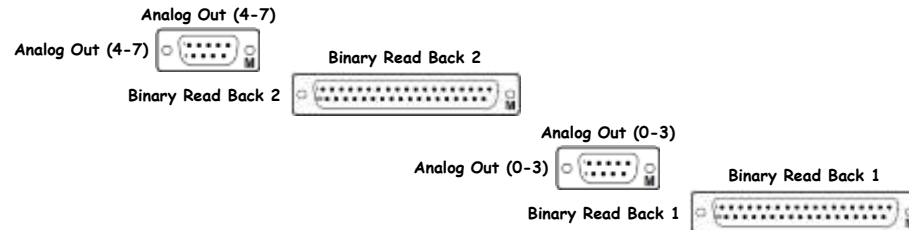



D0902796

Front

D1002032

LSC



S1000988

Rear

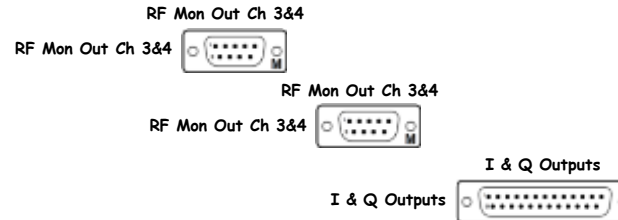

<< L1-ISC-R3

WFS Demodulator Patch Panel No Power

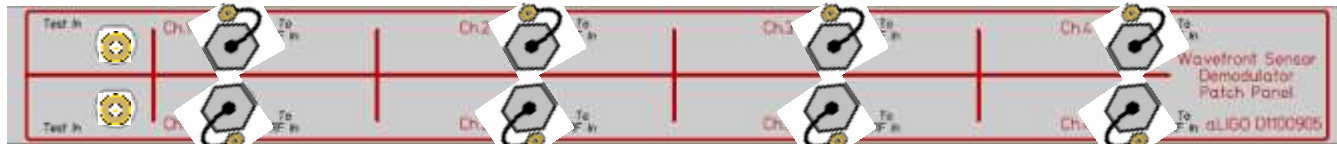

[D1100905](#)

Front

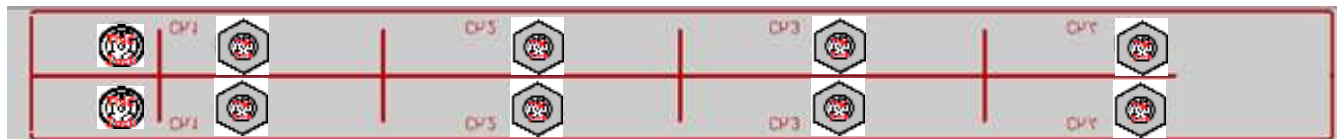

[Sxxxxxxx](#)

Rear



[D0902796](#)

Front

[D1002032](#)

LSC



[S1001025](#)

Rear

RF Mon Out Ch 3&4

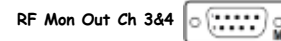

RF Mon Out Ch 3&4

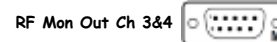

I & Q Outputs



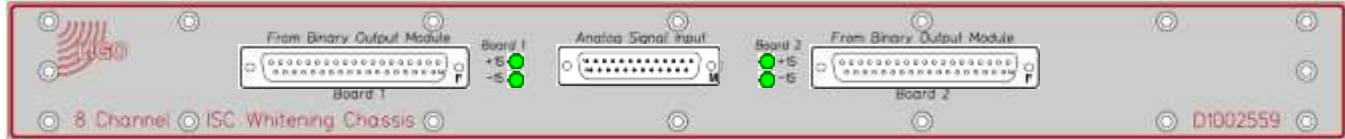

D1002559

Front

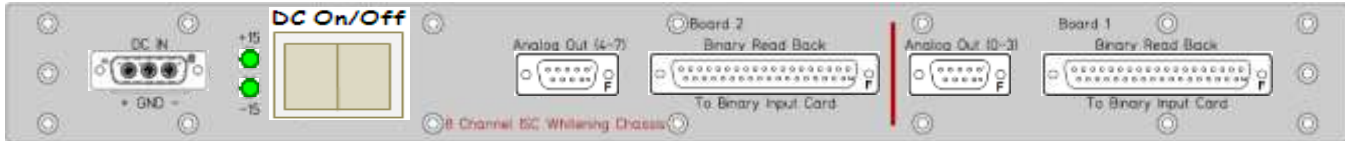
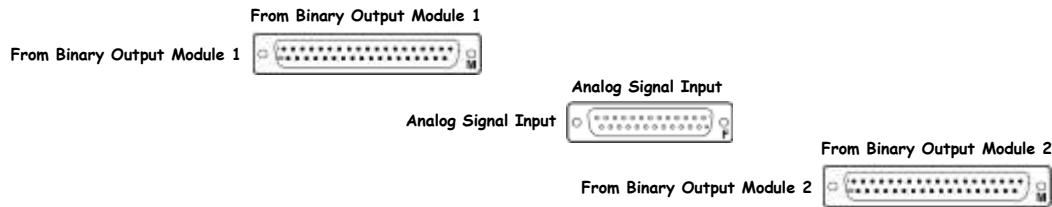

S1101610

Rear

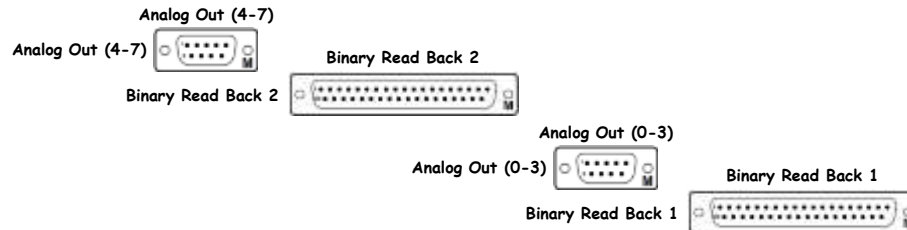

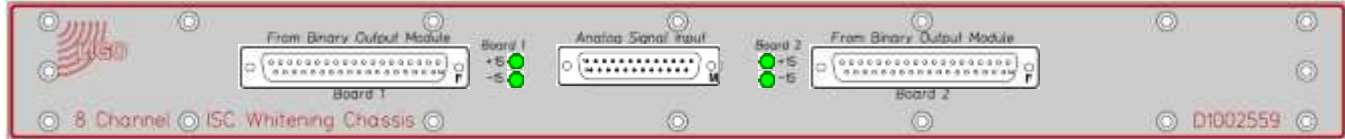

D1002559

Front

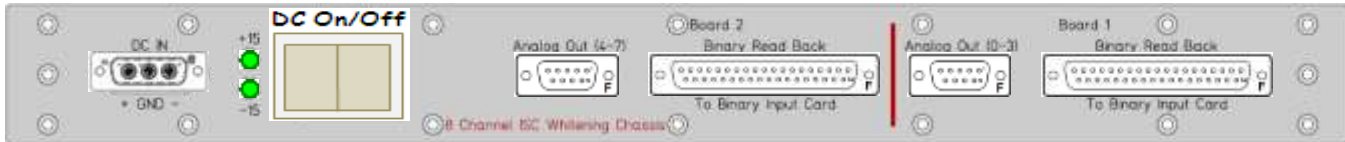
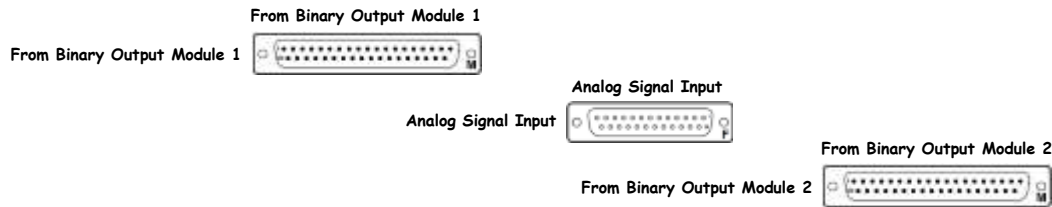

S1101592

Rear

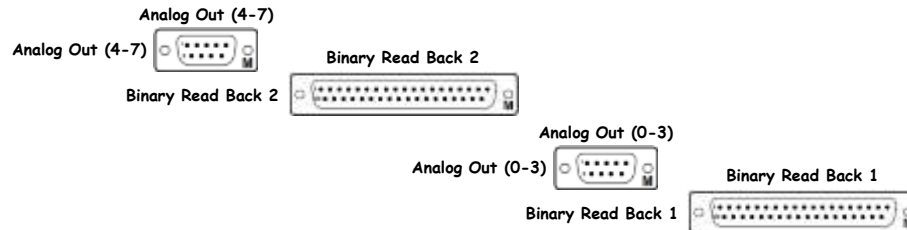

D0902796 - S1001001



<< [L1-ISC-R3](#)

LSC I/Q Demodulator (LSC ASAIR A 45, B 18, B 90MHz) ±15VDC



[D0902796](#)

Front

[D1002032](#)

LSC



[S1001001](#)

Rear

RF Mon Out Ch 3&4

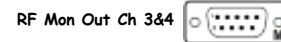

RF Mon Out Ch 3&4

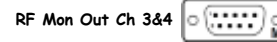

I & Q Outputs



L1-ISC-R4

<< LVEA Racks

ISC HAM1 and HAM3 Rack Layout (D1101904) (S1201195)

D1200757
Sequencer

S1202544

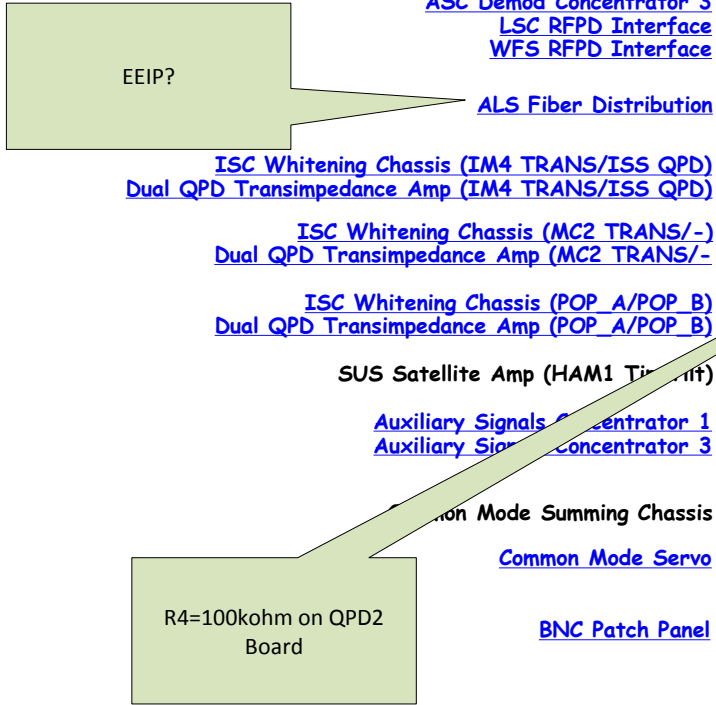

ISC-R4 is part of D1101904

ISC Whitening Filter Controller

Front	Slot	Rear	Power
D1100691	42	S1104007	±18VDC
D1100691	41	S1104006	±18VDC
D1100696	40	S1103987	No Power
D1100696	39	S1103985	No Power
D1102079	38	S1200323	±18VDC
D1101906	37	S1200428	±15VDC
	36		
D1200136	35	S1202531	±17VDC, ±24VDC
	34		
D1002559	32	S1101599	±15VDC
D1002481	31	S1102824	±15VDC
	30		
D1002559	29	S1101611	±15VDC
D1002481	28	S1102812	±15VDC
	27		
D1002559	26	S1101586	±15VDC
D1002481	25	S1102814	±15VDC
	24		
D1002818	23	S1200172	??
	22		
D1102065	21	S1200549	±17VDC
D1201345	20	S1300242	±17VDC
	19		
D1200148	18	Sxxxxxxx	??
	17		
D0901781	16	S1102623	±17VDC, ±24VDC
	15		
PPD32-BNCB50IS	13	Sxxxxxxx	No Power
	12		
	11		
	10		
	9		
	8		
	7		
	6		
	5		
	4		
	3		
D1101741	2	S1201333	??
	1		

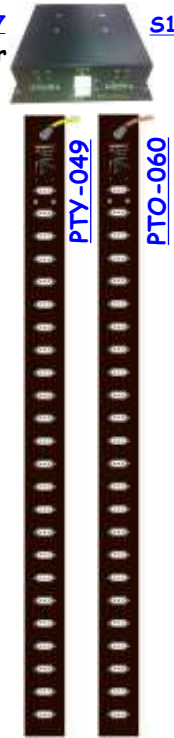

L1-ISC-R4 Details



[D1100691](#)

Front



[S1104007](#)

Rear

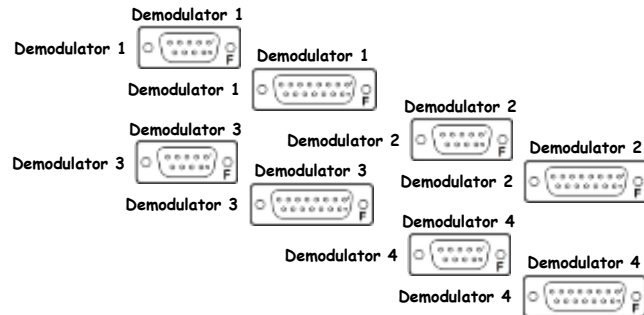
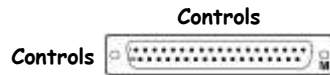



[D1100691](#)

Front



[S1104006](#)

Rear

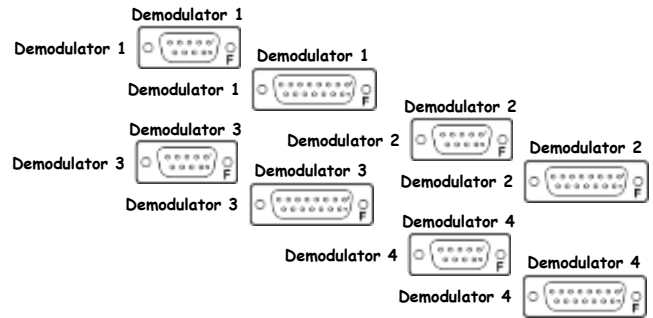
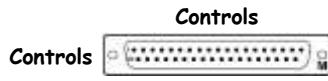



D1100696

Front



S1103987

Rear

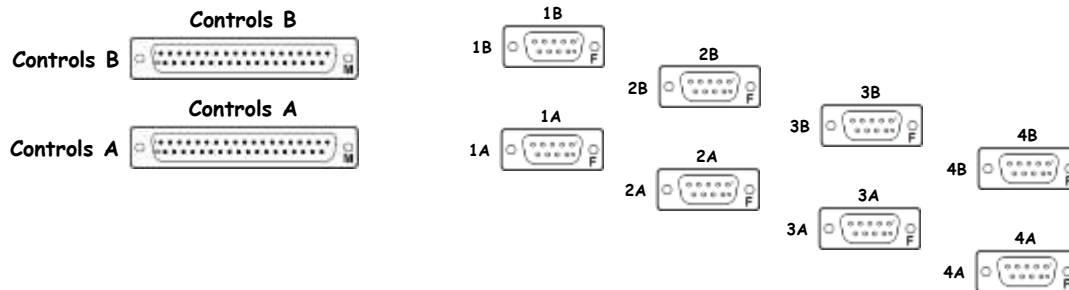



D1100696

Front



S1103985

Rear

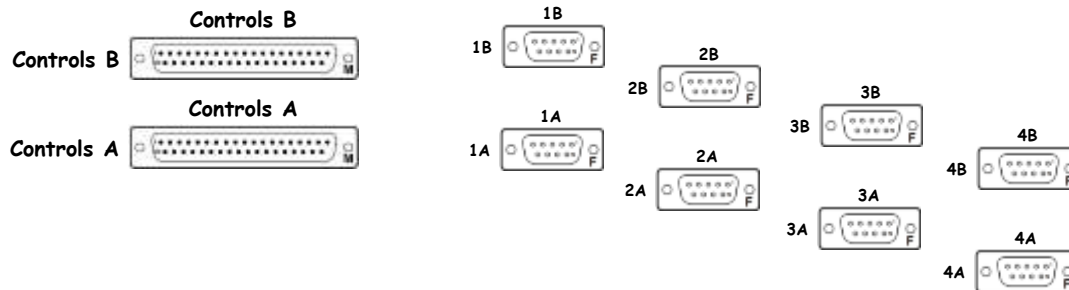

D1102079 - S1200323



<< L1-ISC-R4

LSC RFPD Interface D1102079 S1200323 ±18VDC

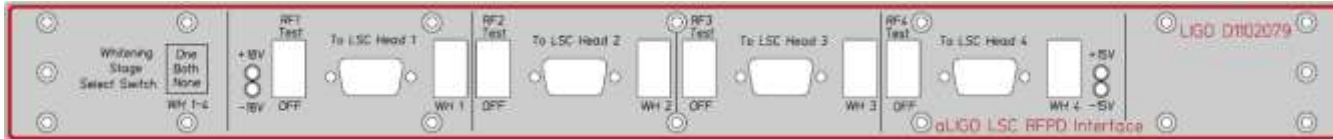

D1102079

Front



S1200323

Rear

D1101905



D1101906

Front

D1101908



S1200428

Rear

ALS Fiber Distribution Chassis D1200136 S1202531 +-17VDC, +-24VDC

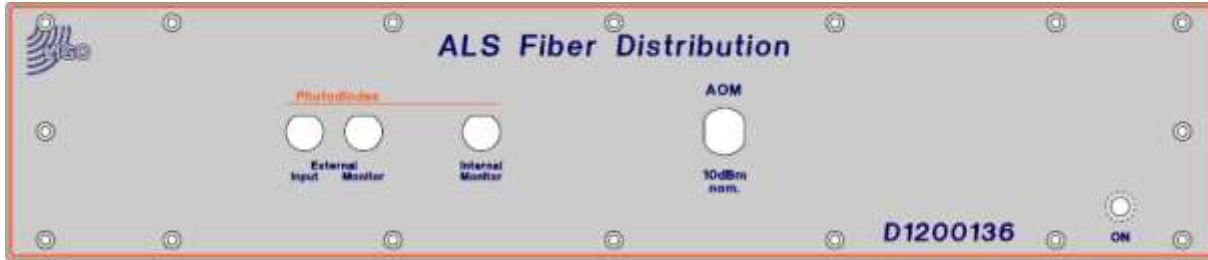

[D1200136](#)
Front



[S1202531](#)
Rear

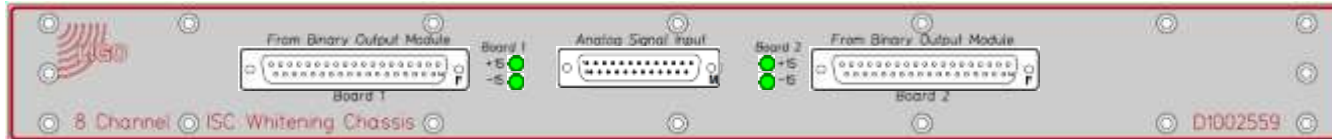

D1002559

Front

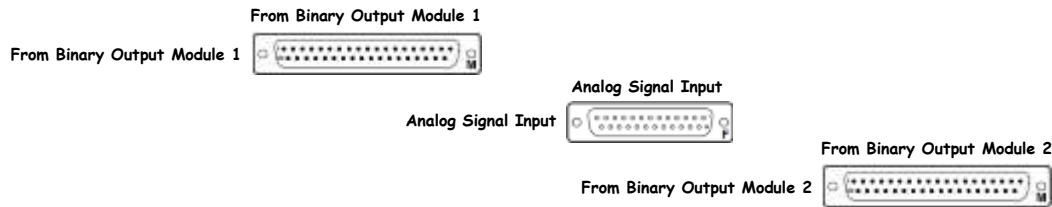

S1101599

Rear

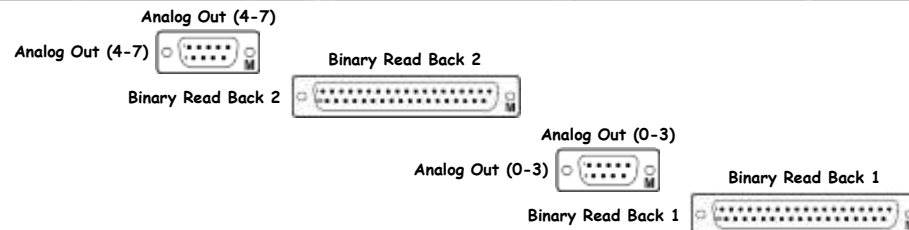

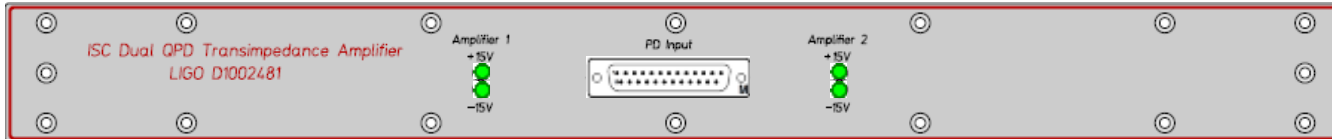

D1002481

Front

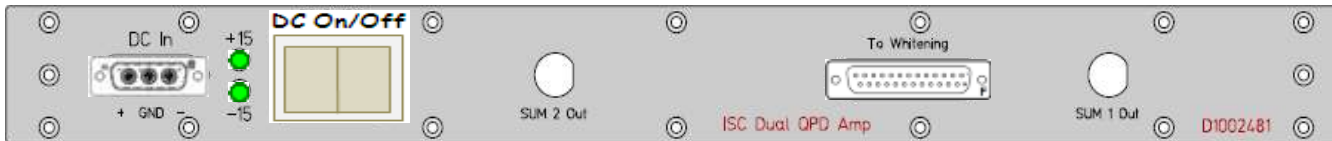

S1102824

Rear



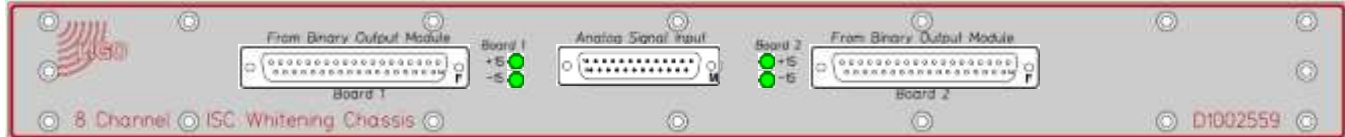

D1002559

Front

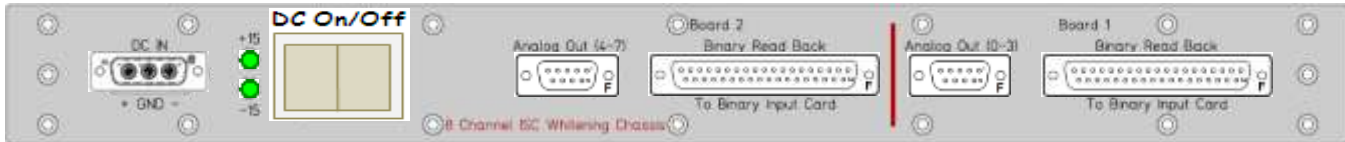
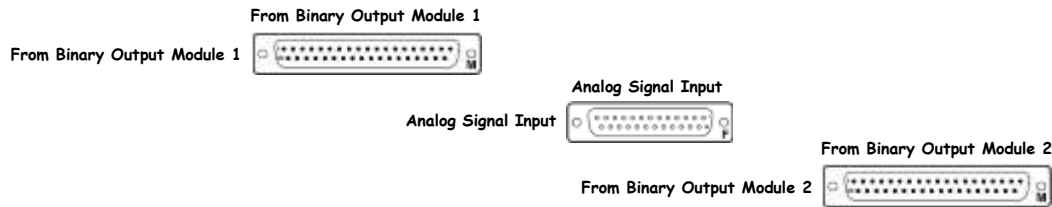

S1101611

Rear

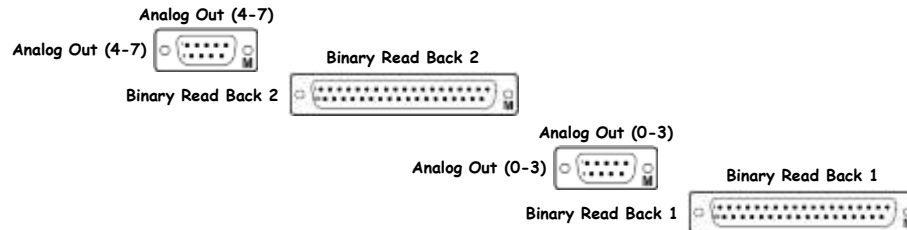

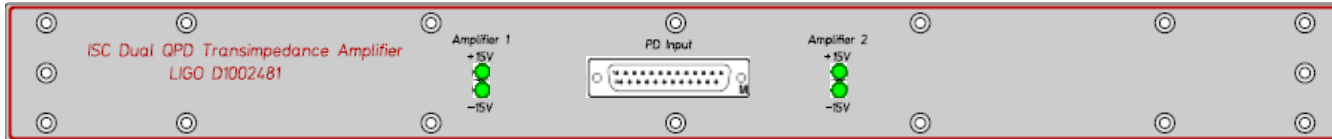

D1002481

Front

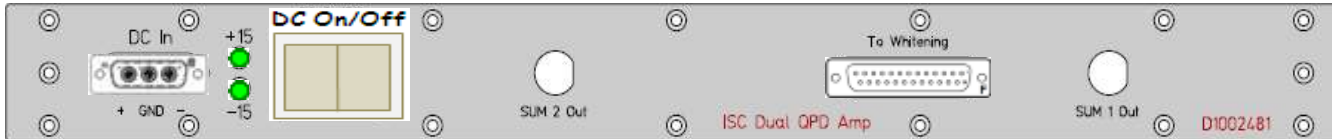

S1102812

Rear





D1002559

Front

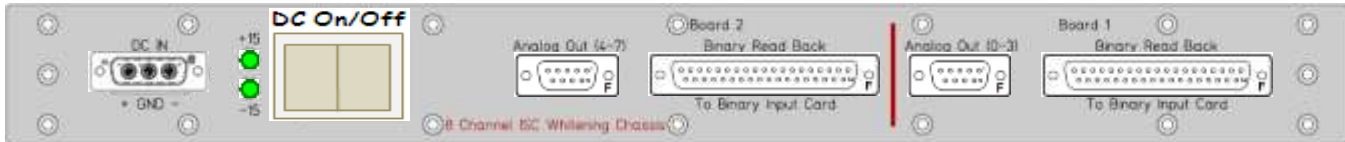
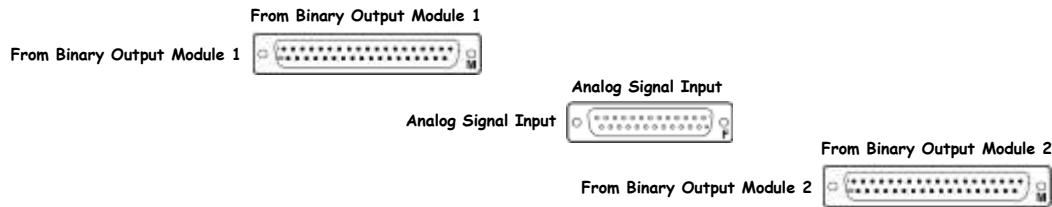

S1101586

Rear

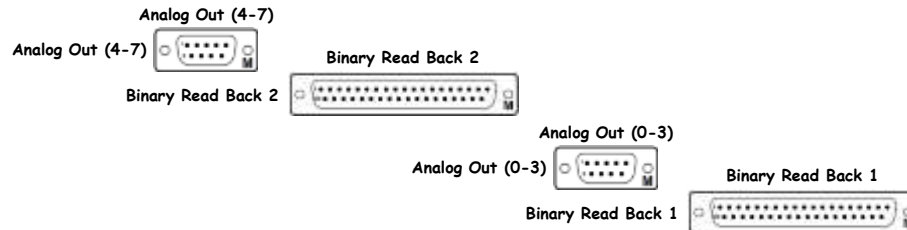

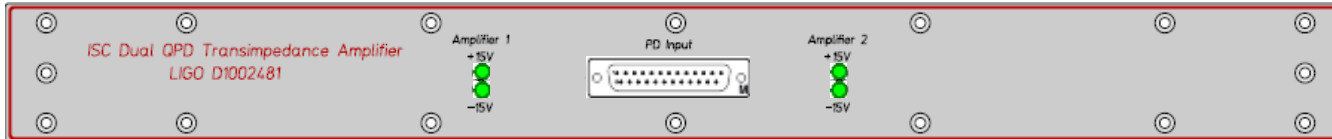

D1002481

Front

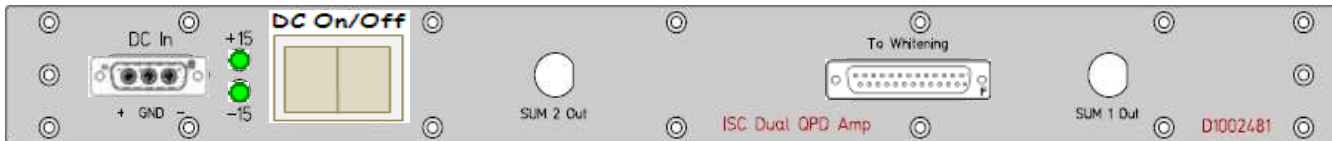

S1102814

Rear



D1102065 - S1200550



<< L1-ISC-R4

Auxiliary Signals Concentrator 1 ±17VDC



[D1102065](#)

Front



[S1200550](#)

Rear

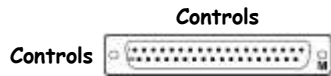

D1201345 - S1300242



<< L1-ISC-R4

Auxiliary Signals Concentrator 3 D1201345 S1300242 ±17VDC



D1201345

Front



S1300242

Rear

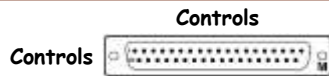

Common Mode Servo ±17VDC, ±24VDC



D0901781

Front



S1102623

Rear

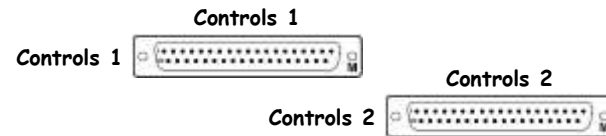
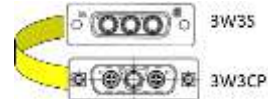

BNC Patch Panel

<< [L1-ISC-R4](#)

BNC Patch Panel

[PPD32-BNCB50IS](#)

Sxxxxxxx

No Power



[PPD16-BNCB50IS](#)

Front

		42				
	BNC Patch Panel	41	PPD32-BNCB50IS	Sxxxxxxx	No Power	
		40				
		39				
		38				
		37				
	LSC Demod Concentrator 4	36	D1100691	S1104008	±18VDC	
	ASC Demod Concentrator 4	35	D1100696	S1103983	No Power	
	ASC Demod Concentrator 5	34	D1100696	S1103986	No Power	
		33				
	LSC RFPD Interface	32	D1102079	S1200463	±18VDC	
		31				
	WFS RFPD Interface	30	D1101906	S1200443	±15VDC	
		29				
	SUS Satellite Amp (HAM1 Tip/Tilt)	28	D1002818	S1105381	±15VDC	
		27				
	SUS Satellite Amp (HAM1 Tip/Tilt)	26	D1002818	S1200168	±15VDC	
		25				
	Dual QPD Transimpedance Amp (ASC OMC R A&B)	24	D1002481	S1102830	±15VDC	
		23				
	ISC Whitening Chassis (ASC OMC R A&B)	22	D1002559	S1101608	±15VDC	
		21				
	Dual QPD Transimpedance Amp (ASC AS C)	20	D1002481	S1102834	±15VDC	
		19				
	ISC Whitening Chassis (ASC AS C, OMC DCPD A&B)	18	D1002559	S1101164	±15VDC	
		17				
	Auxiliary Signals Concentrator 1	16	D1102065	S1200550	±17VDC	
	Auxiliary Signals Concentrator 4	15	D1201349	S1300245	±17VDC	
		14				
	OMC HV/LV Piezo Driver Chassis	13	D1300485	S1301186	±17VDC	
	Dual D-Sub Breakout Panel	12	D1201450	Sxxxxxxx	±17VDC	
		11				
	Dual QPD Transimpedance Amp (ASC OMC A&B)	10	D1002481	Sxxxxxxx	±15VDC	
		9				
	ISC Whitening Chassis (ASC OMC A&B)	8	D1002559	S1101639	±15VDC	
		7				
		6				
		5				
		4				
		3				
		2				
		1				
			Front	Rear		



ISC-R5 is part of [D1200196](#)

Perforated Shelf

L1-ISC-R5 Details

BNC Patch Panel

<< [L1-ISC-R5](#)

BNC Patch Panel

[PPD32-BNCB50IS](#)

Sxxxxxxx

No Power



[PPD16-BNCB50IS](#)

Front



[D1100691](#)

Front



[S1104008](#)

Rear

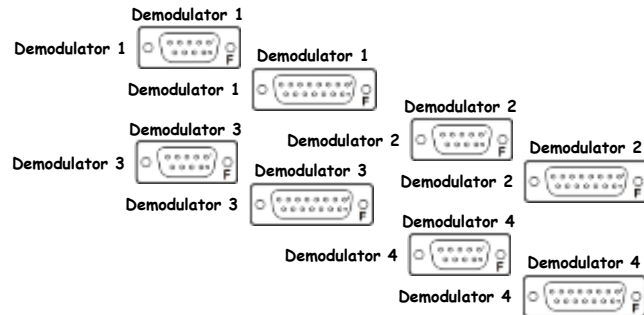
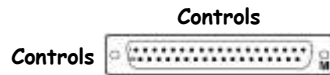



D1100696

Front

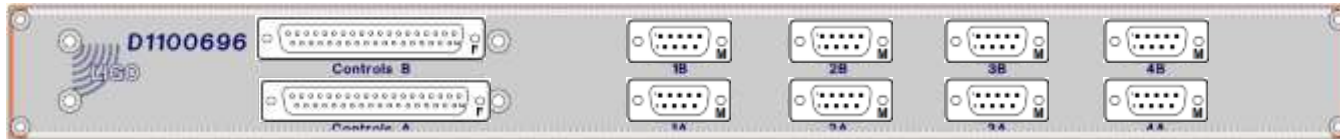

S1103983

Rear

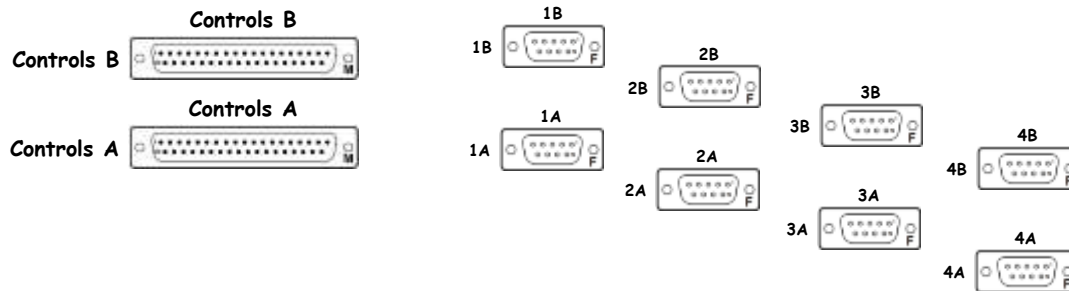



D1100696

Front



S1103986

Rear

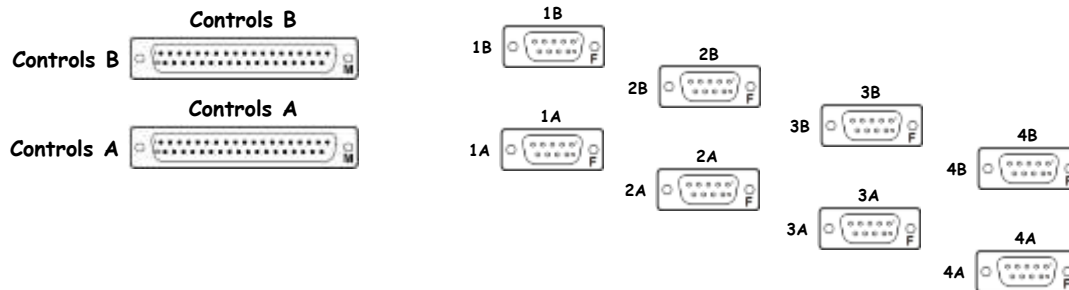

D1102079 - S1200463



<< L1-ISC-R5

LSC RFPD Interface D1102079 S1200463 ±18VDC

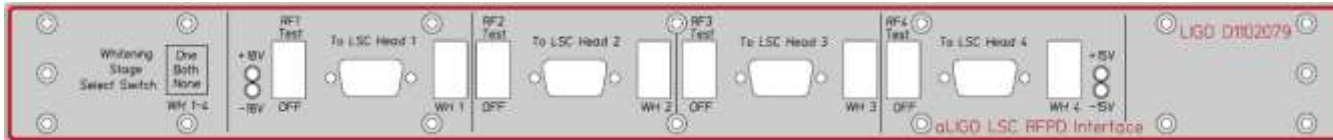

D1102079

Front



S1200463

Rear

D1101905



D1101906

Front

D1101908



S1200443

Rear

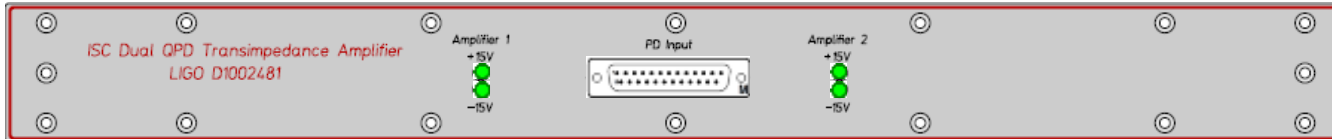

D1002481

Front

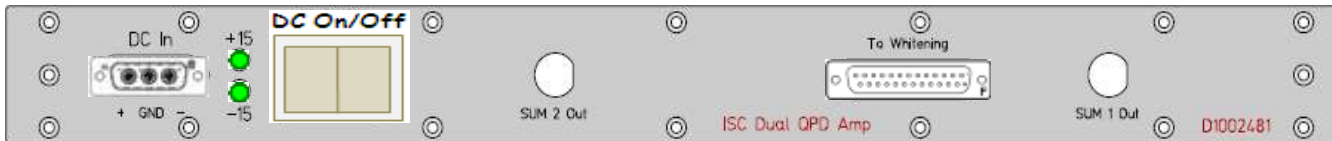

S1102830

Rear

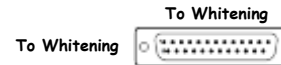



D1002559

Front

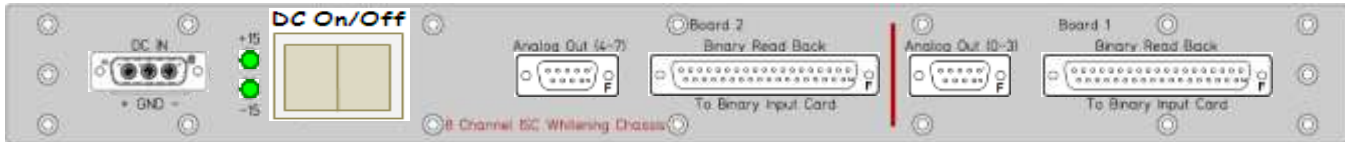
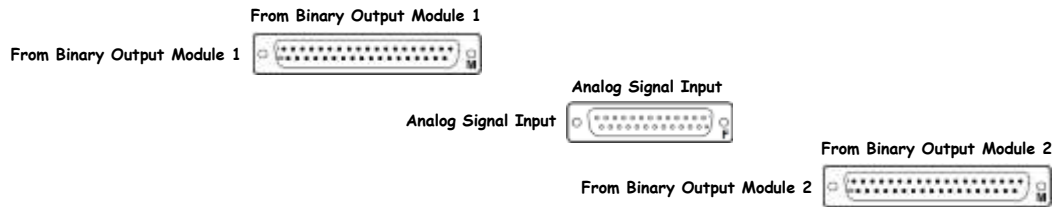

S1101608

Rear

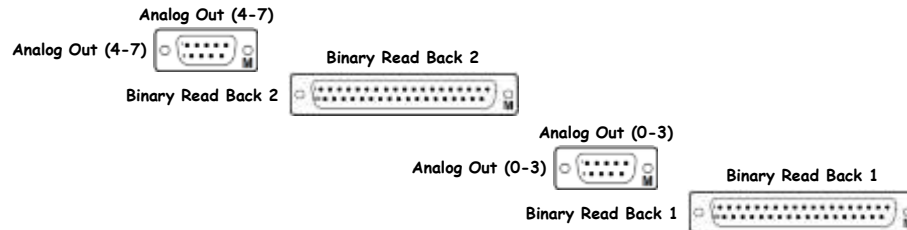

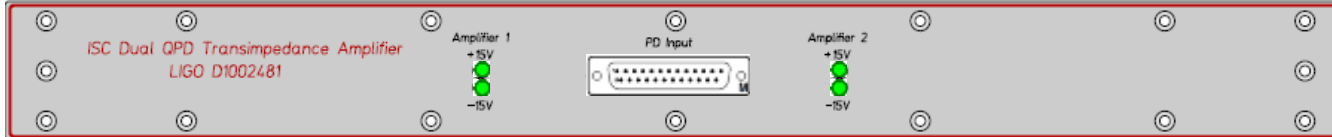

D1002481

Front

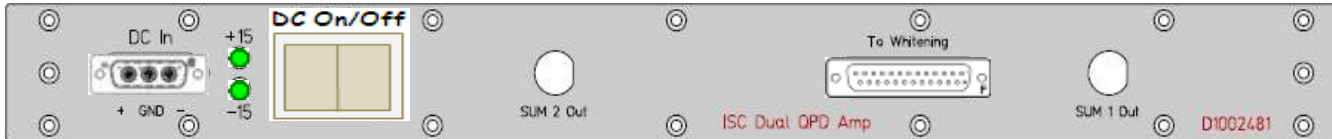

S1102834

Rear

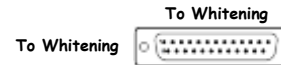

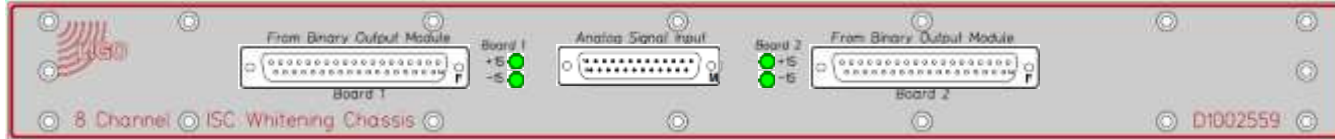

D1002559

Front

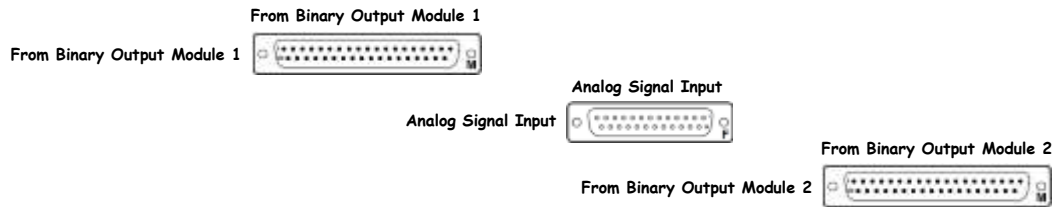

S1101164

Rear

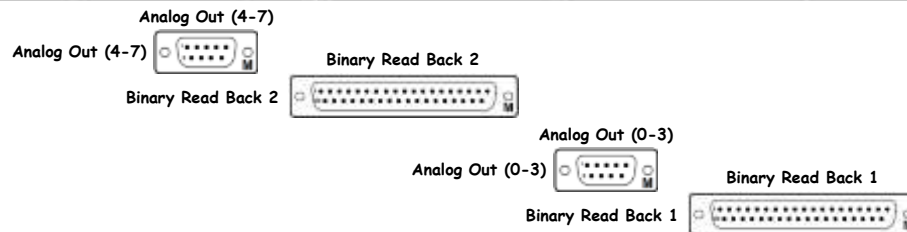

Auxiliary Signals Concentrator 1 D1102065 S1200550 ±17VDC



[D1102065](#)

Front



[S1200550](#)

Rear

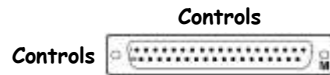

D1201349 - S1300245



<< L1-ISC-R5

Auxiliary Signals Concentrator 4 D1201349 S1300245 ±17VDC



[D1201349](#)

Front



[S1300245](#)

Rear

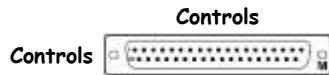

D1201450 - Sxxxxxxx

<< L1-ISC-R5

Dual DSUB Breakout Panel No Power

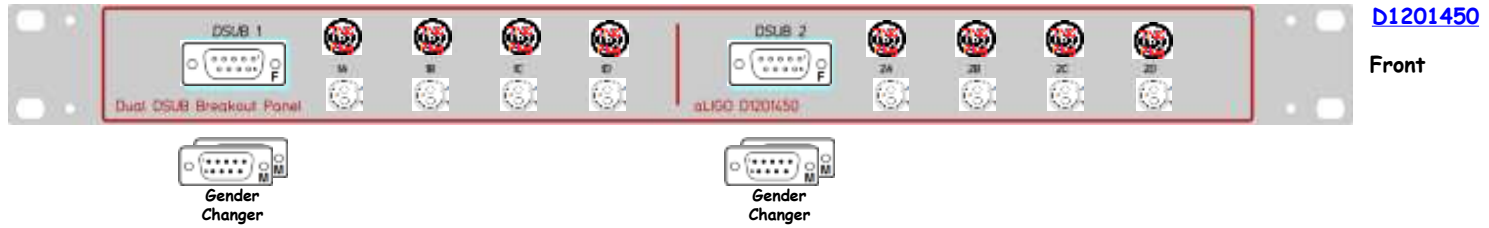

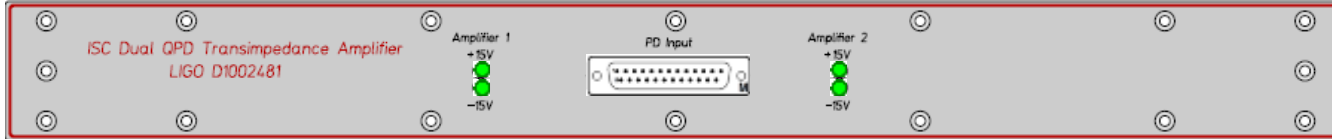

D1002481

Front



Sxxxxxxx

Rear



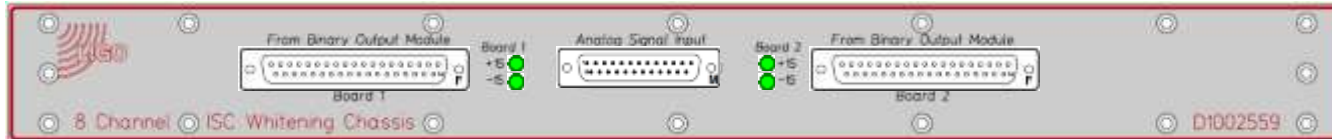

D1002559

Front

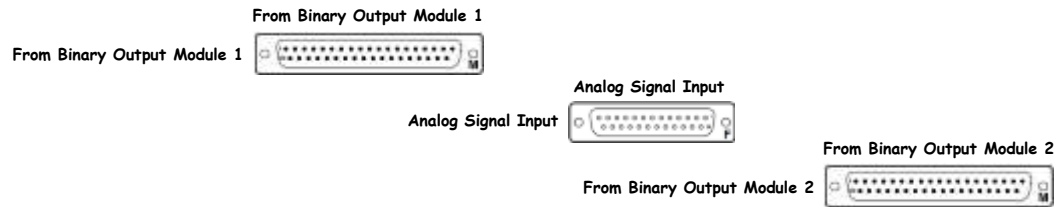

S1101639

Rear

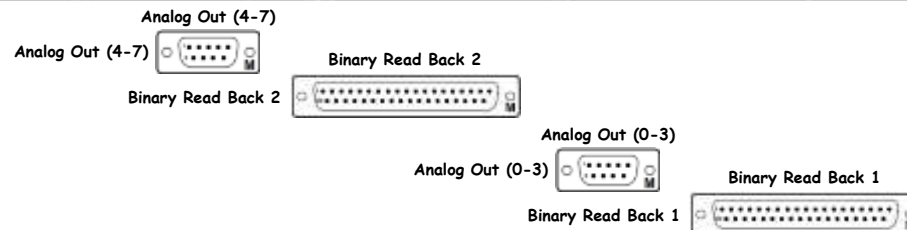

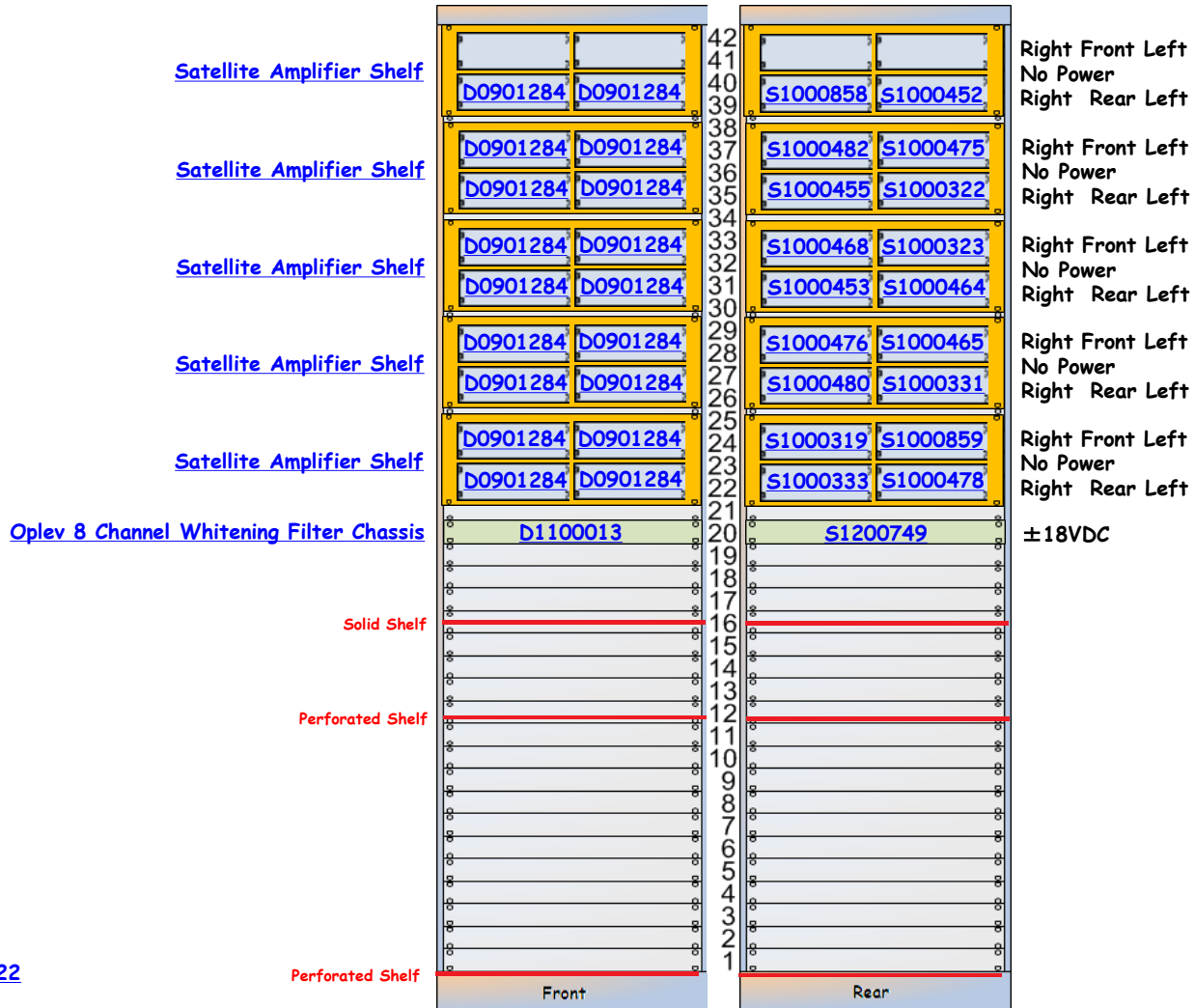

PTO-023

SUS-R1 is part of [D1100022](#)

<< L1-SUS-R1

Satellite Amplifier Shelf

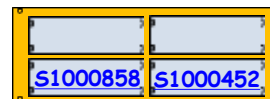
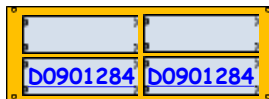

Right Front Left
No Power
Right Rear Left

Left

Front



D0901284

Right

Rear

<< L1-SUS-R1

Satellite Amplifier Shelf



Right Front Left
No Power
Right Rear Left

Left



Right

<< L1-SUS-R1

Satellite Amplifier Shelf

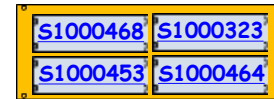
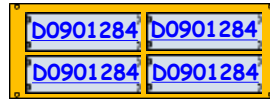

Right Front Left
No Power
Right Rear Left

Left



Right

<< L1-SUS-R1

Satellite Amplifier Shelf



Right Front Left
No Power
Right Rear Left

Left



D0901284

Right

<< L1-SUS-R1

Satellite Amplifier Shelf

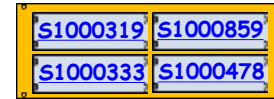
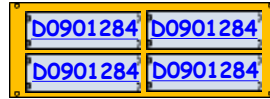

Right Front Left
No Power
Right Rear Left

Left



Right

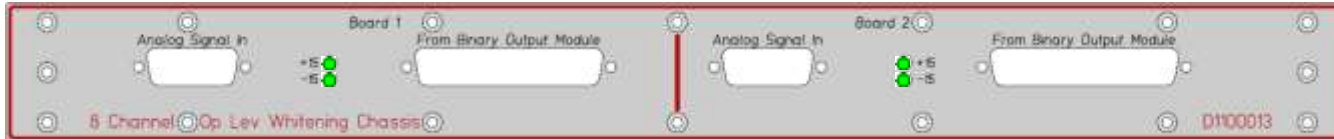

[D1100013](#)

Front



[S1200749](#)

Rear

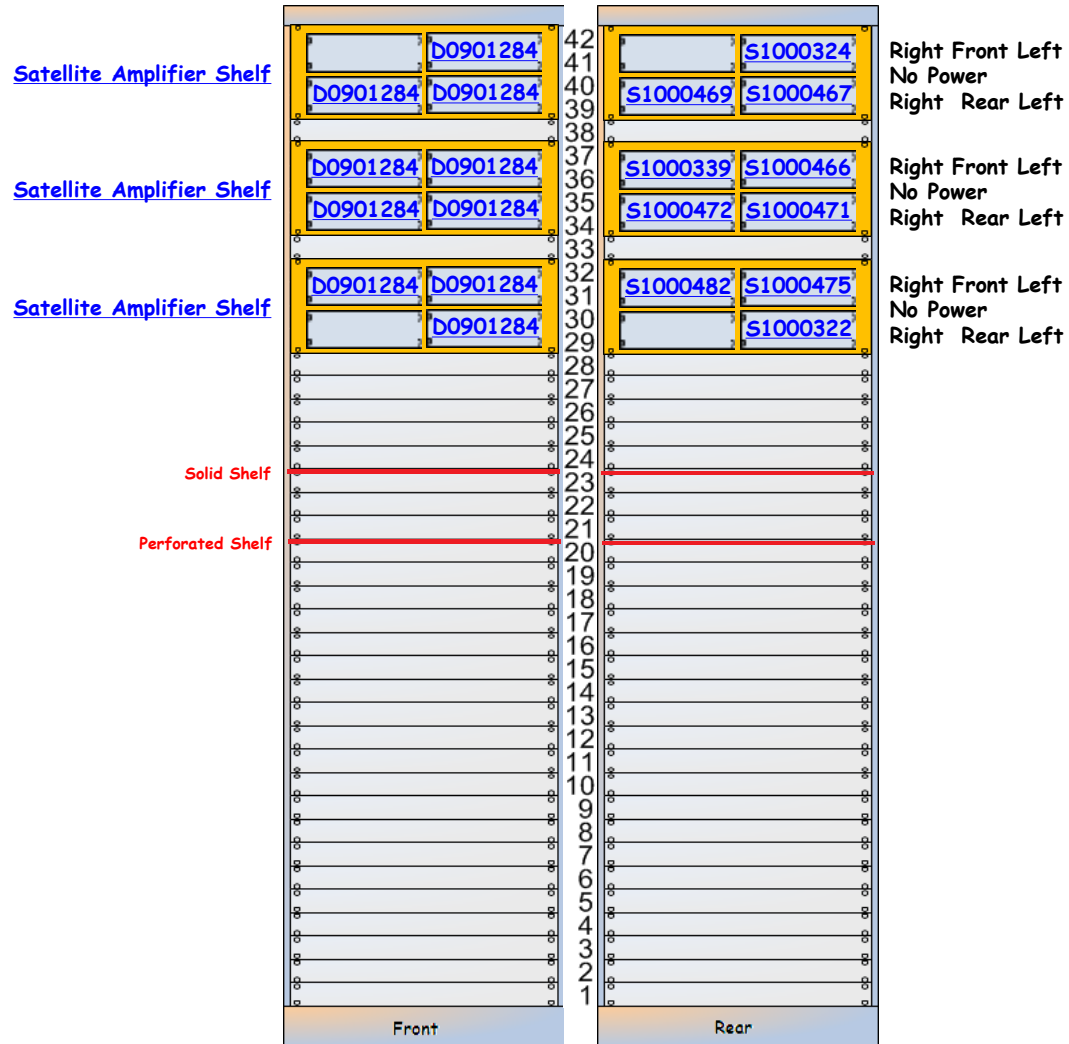

SUS-R2 is part of [D1100022](#)

D0901284 Shelf

<< L1-SUS-R2

Satellite Amplifier Shelf

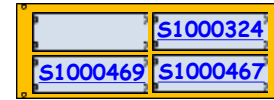
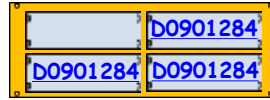

Right Front Left
No Power
Right Rear Left

Left

Front

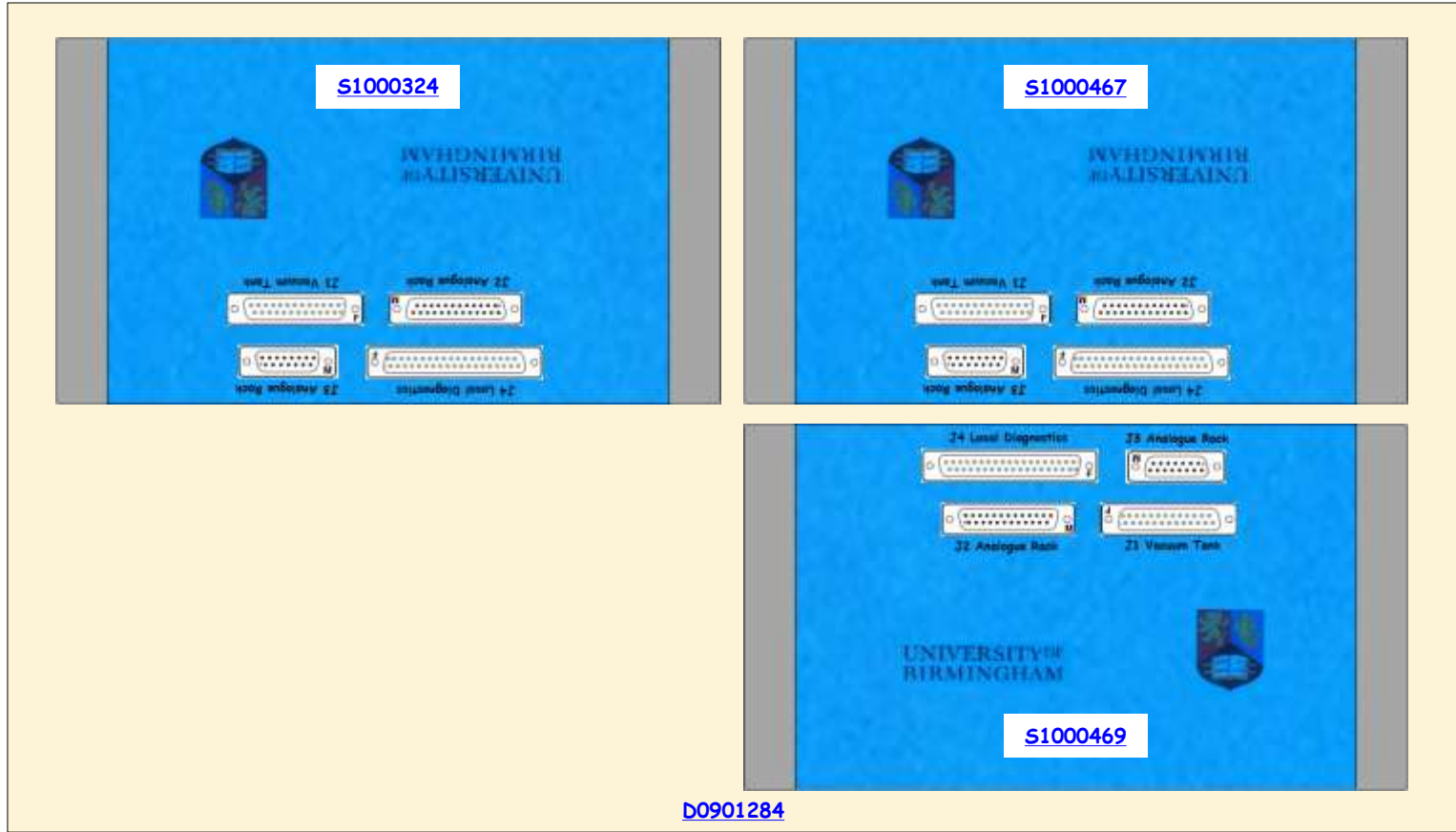

D0901284

Right

Rear

<< L1-SUS-R2

Satellite Amplifier Shelf

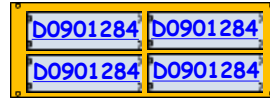

Right Front Left
No Power
Right Rear Left

Left



Right

<< L1-SUS-R2

Satellite Amplifier Shelf

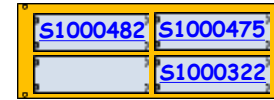
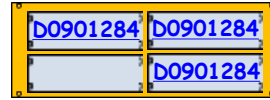

Right Front Left
No Power
Right Rear Left

Left



D0901284

Right

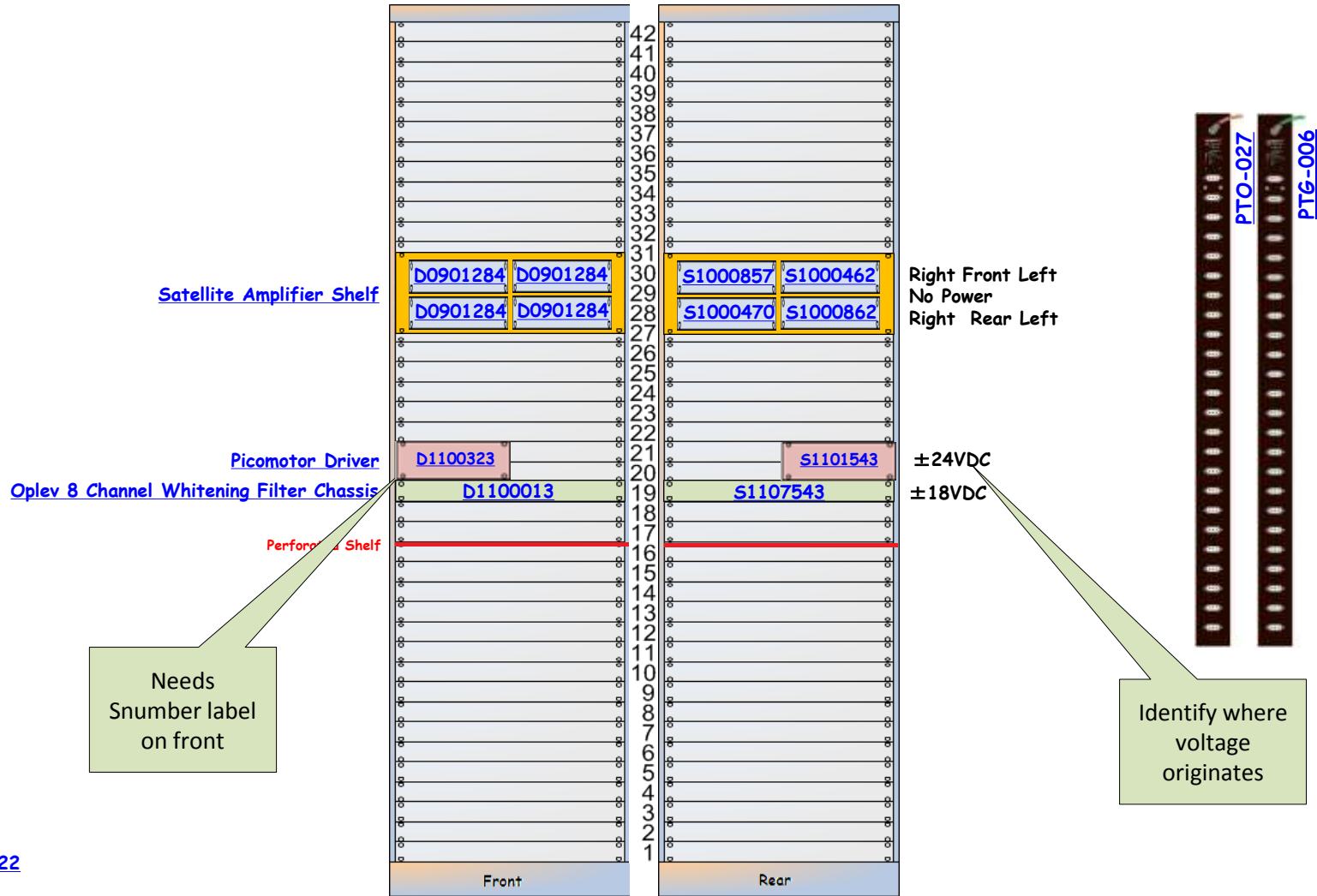

SUS-R3 is part of [D1100022](#)

<< L1-SUS-R3

Satellite Amplifier Shelf

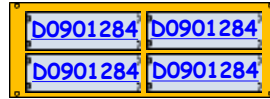

Right Front Left
No Power
Right Rear Left

Left

Front



D0901284

Right

Rear

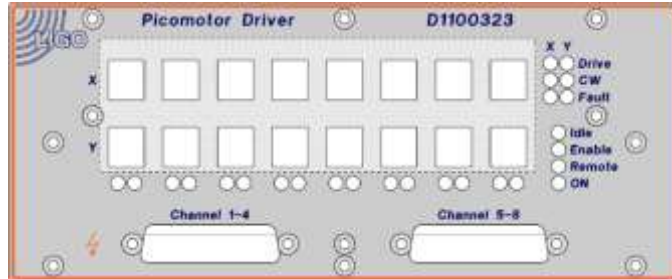

[D1100323](#)

Front

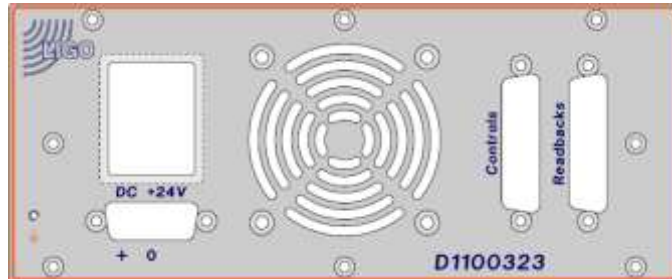

[S1101543](#)

Rear

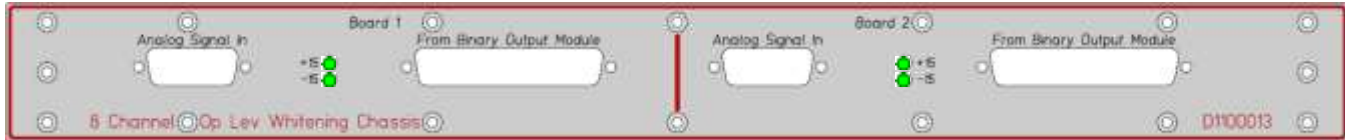

D1100013

Front



S1107543

Rear

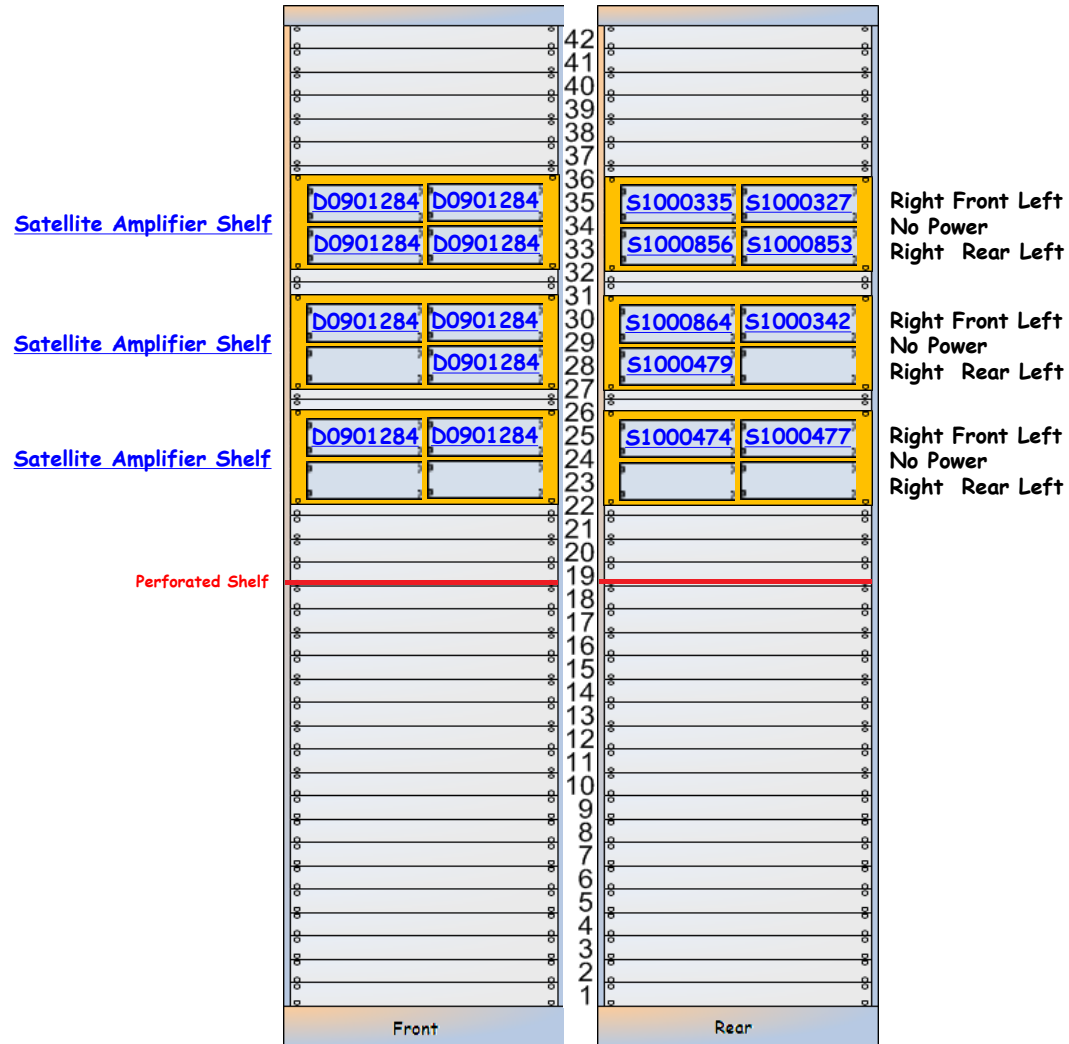

SUS-R4 is part of [D1100022](#)

<< L1-SUS-R4

Satellite Amplifier Shelf

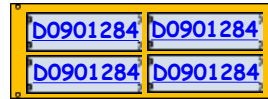

Right Front Left
No Power
Right Rear Left

Left



Right

<< L1-SUS-R4

Satellite Amplifier Shelf

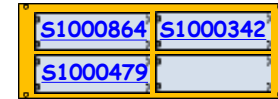

Right Front Left
No Power
Right Rear Left

Left



D0901284

Right

<< L1-SUS-R4

Satellite Amplifier Shelf

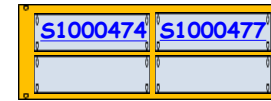
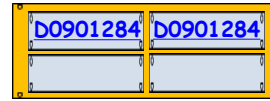

Right Front Left
No Power
Right Rear Left

Left



D0901284

Right

Rear

Front

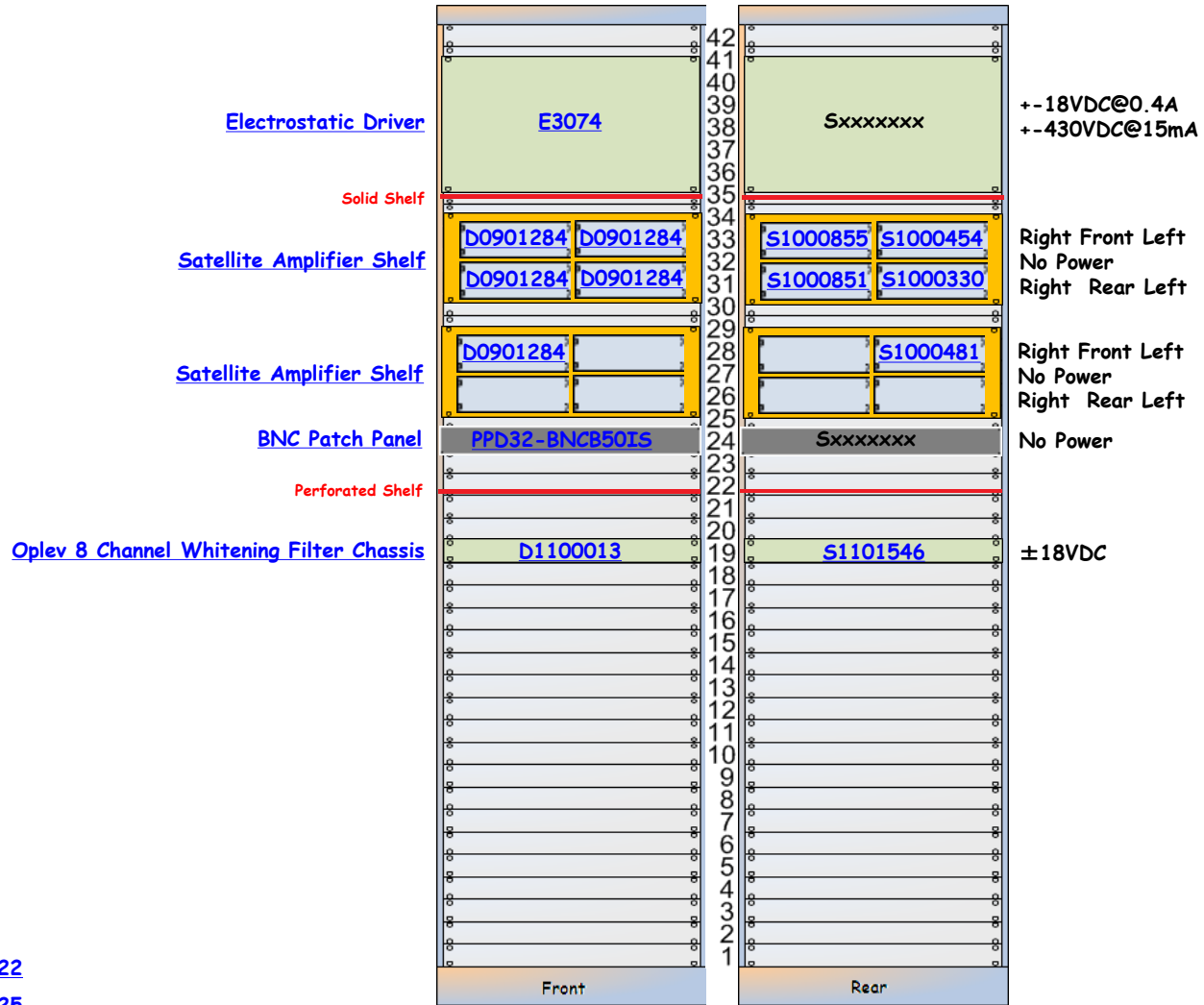

SUS-R5 is part of [D1100022](#)

SUS-R5 is part of [D1001725](#)

E3074 - Sxxxxxxx

Electrostatic Driver

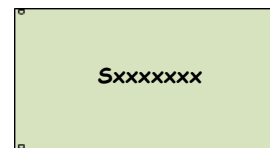
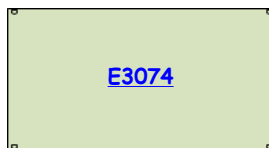

+ -18VDC@0.4A
+ -430VDC@15mA



E3074

Front



Sxxxxxxx

Rear

<< L1-SUS-R5

Satellite Amplifier Shelf



Right Front Left
No Power
Right Rear Left

Left



D0901284

Right

<< L1-SUS-R5

Satellite Amplifier Shelf

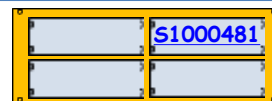
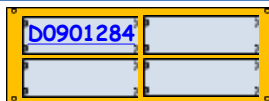

Right Front Left
No Power
Right Rear Left

Left

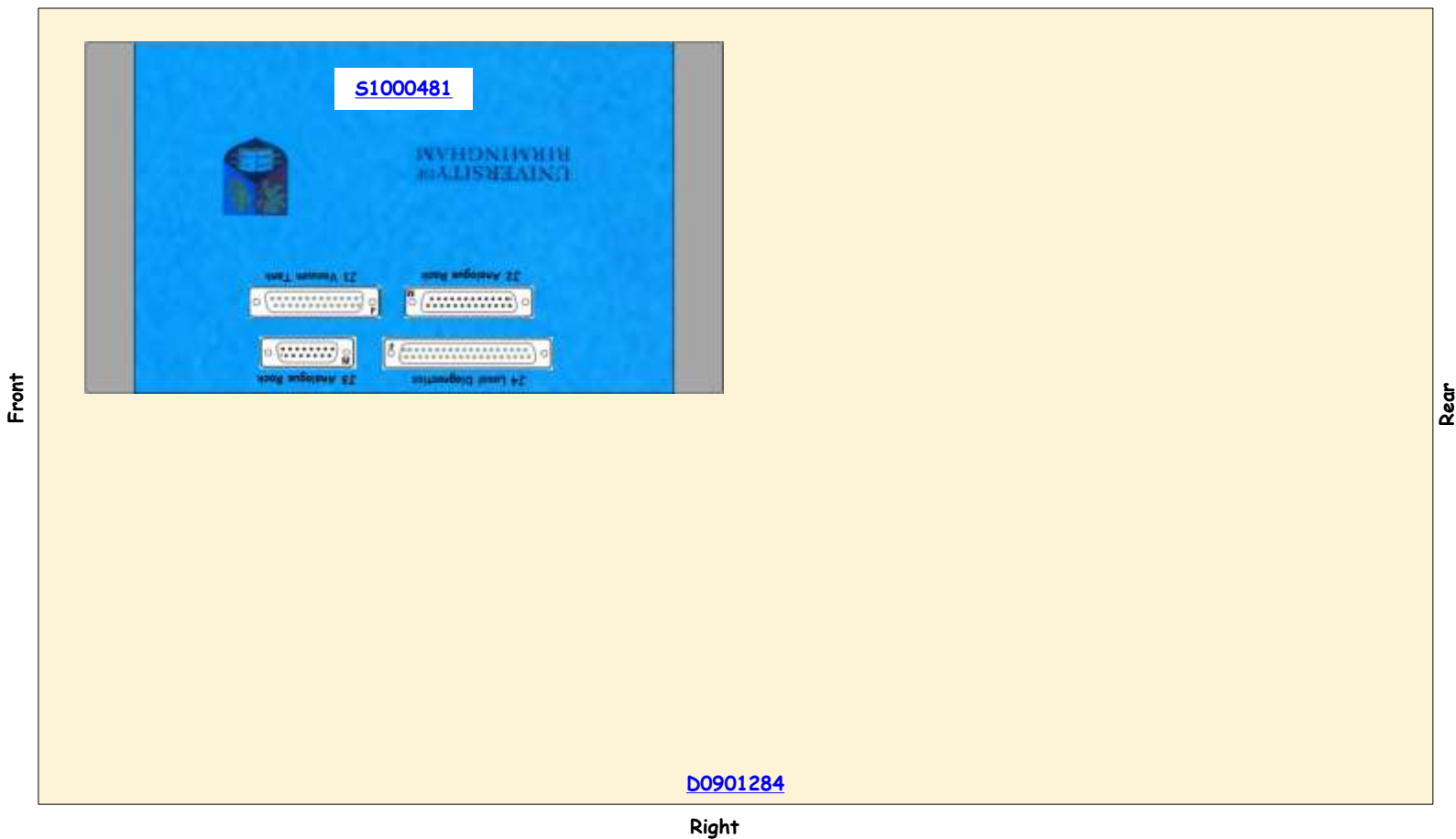

Front

Rear

D0901284

Right

BNC Patch Panel

<< [L1-SUS-R5](#)

BNC Patch Panel

[PPD32-BNCB50IS](#)

Sxxxxxxx

No Power



[PPD16-BNCB50IS](#)

Front

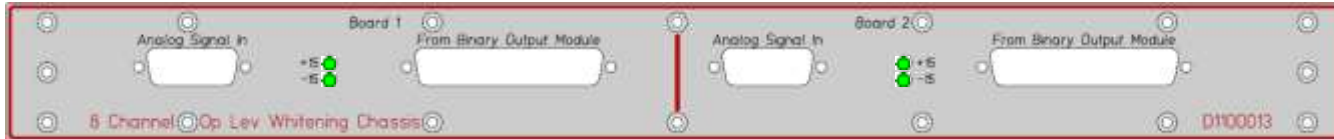

[D1100013](#)

Front



[S1101546](#)

Rear

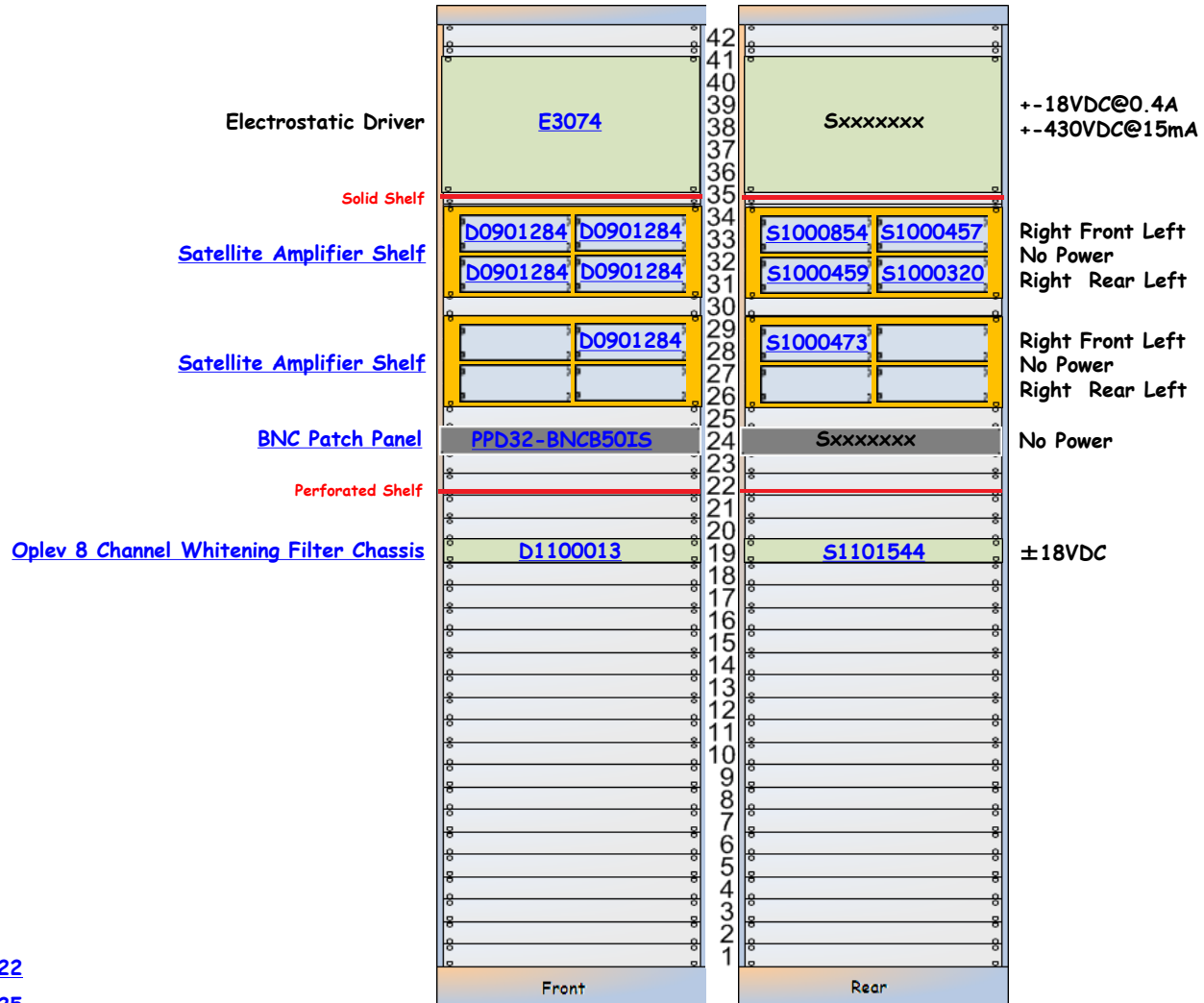

SUS-R6 is part of [D1100022](#)

SUS-R6 is part of [D1001725](#)

<< L1-SUS-R6

Satellite Amplifier Shelf

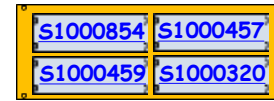
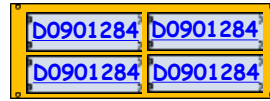

Right Front Left
No Power
Right Rear Left

Left

Front



D0901284

Right

Rear

<< L1-SUS-R6

Satellite Amplifier Shelf

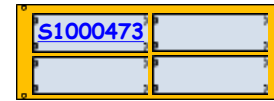

Right Front Left
No Power
Right Rear Left

Left

Front



Rear

Right

BNC Patch Panel

<< L1-SUS-R6

BNC Patch Panel

[PPD32-BNCB50IS](#)

Sxxxxxxx

No Power



[PPD16-BNCB50IS](#)

Front

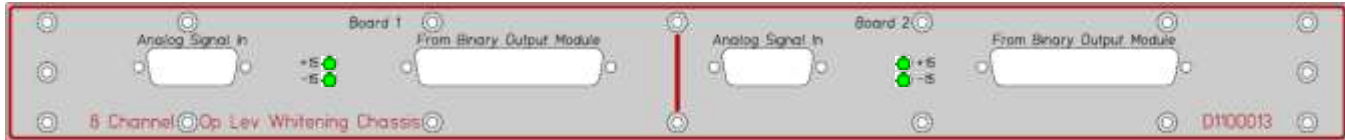

[D1100013](#)

Front



[S1101544](#)

Rear



Hartmann Sensor Power Distribution

TCS HWS Splitter Chassis

SLED Input Power Interlock

TCS Laser Controller

SLED Controller

Perforated Shelf

Picomotor Driver

CO2P EtherCAT Interface Box

RF Distribution Amplifier

AOM Driver

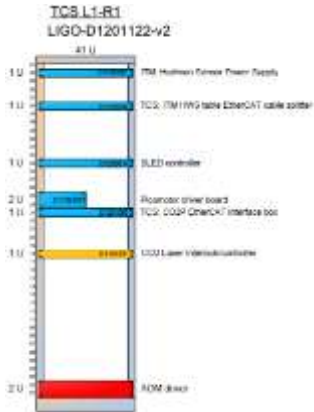
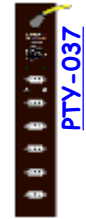
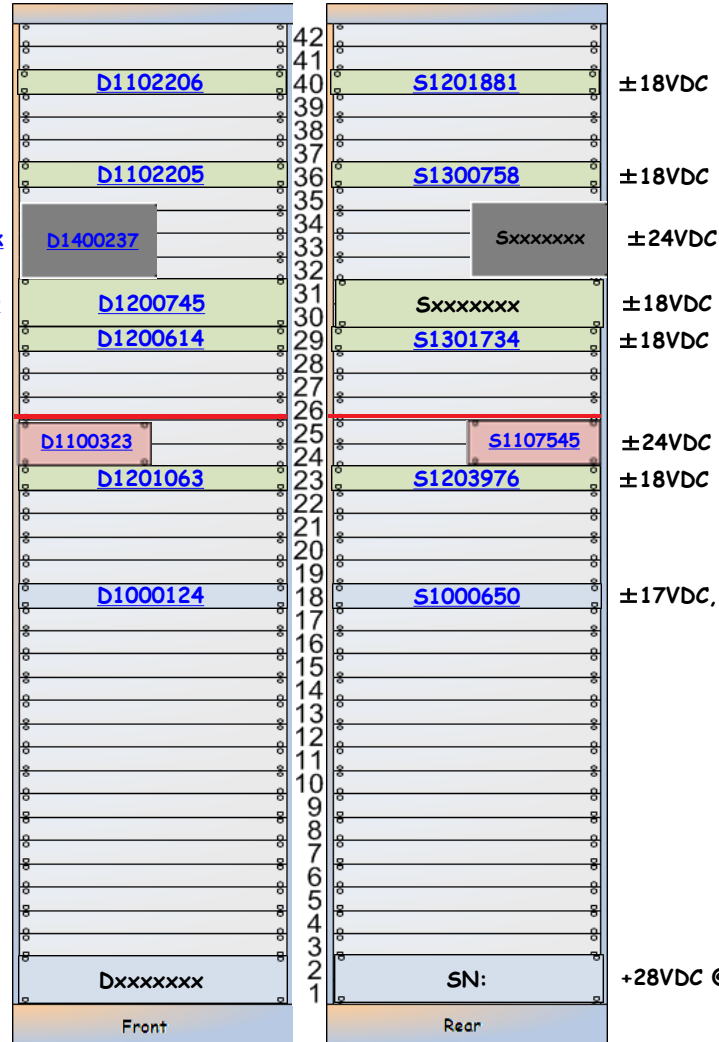

TCS-R1 is part of [D1200258](#)

TCS-R1 is part of [E1100892](#)

Hartmann Sensor Power Distribution D1102206 S1201881 ±18VDC

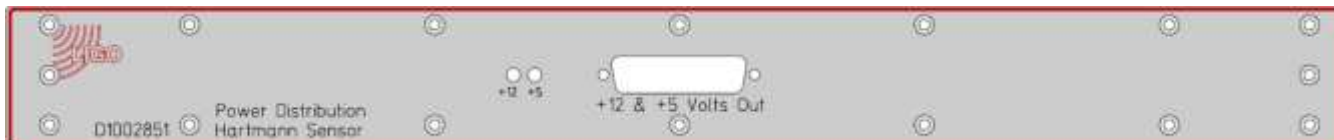

[D1102206](#)

Front



[S1201881](#)

Rear

<< L1-TCS-R1

TCS HWS Splitter Chassis D1102205 S1300758 ±18VDC

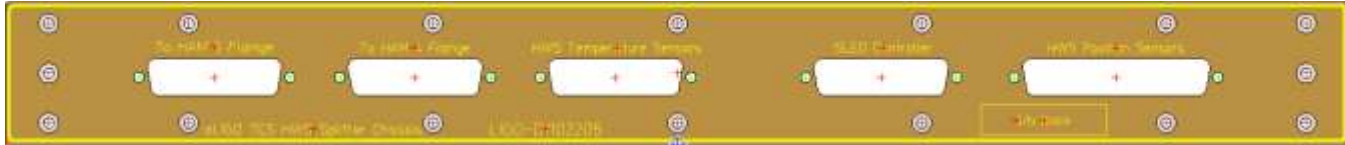

[D1102205](#)

Front

[S1300758](#)

Rear

SLED Input Power Interlock

[D1400237](#)

Sxxxxxxx

±24VDC

[D1400237](#)

Front

Sxxxxxxx

Rear

D1400237 - Hartmann SLED Input Power Interlock Box

Digi-Key HM1193-ND 8.74 x 5.75 x 4.14 Black Box
 Mouser 651—2963802 Phoenix Contact Safety Relay
 Conec 3003W3SXX99A30X (+3 F)
 Conec 3003W3PXX99A30X (+3 M)
 Conec 303W3CPXX99A30X (+1 F and 1 M)
 DB9 F bulkhead mount + 2 pins
 3.75" DIN rail
 2 - 8-32*3/8 Screws
 2 - 8-32 Nylon filled nuts
 2 - #10 Flat washers



TCS Laser Controller

D1200745

Sxxxxxxx

±18VDC

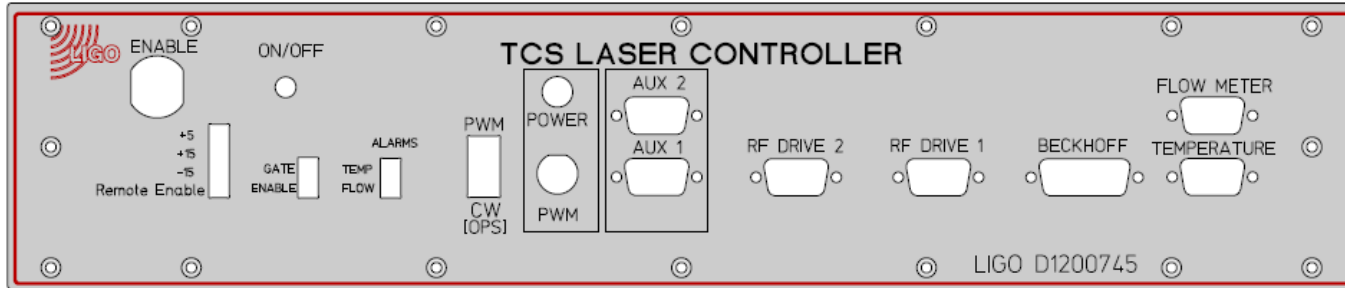

D1200745

Front

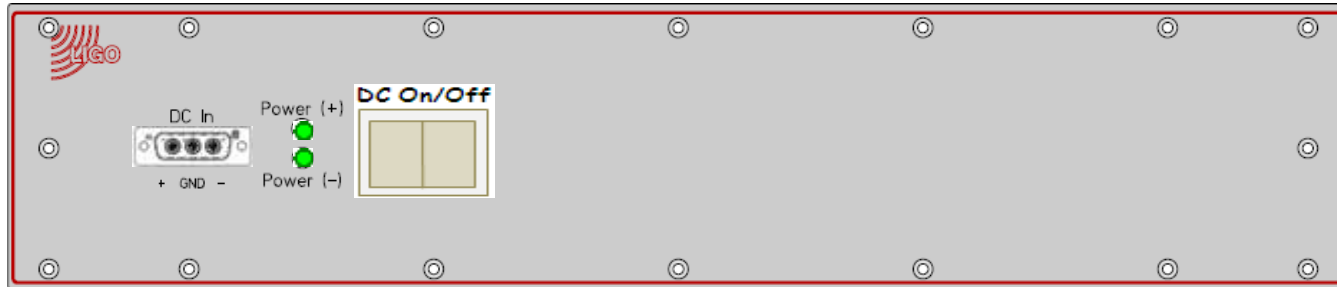

Sxxxxxxx

Rear

SLED Controller ±18VDC

[D1200745](#)

Front

[S1301734](#)

Rear

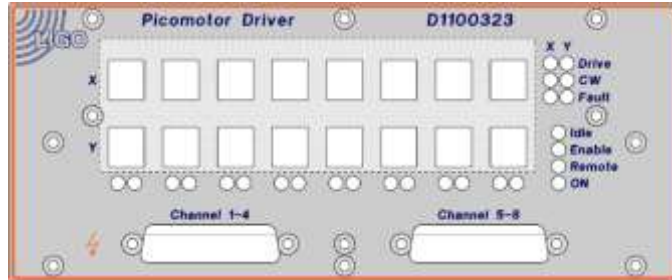

[D1100323](#)

Front

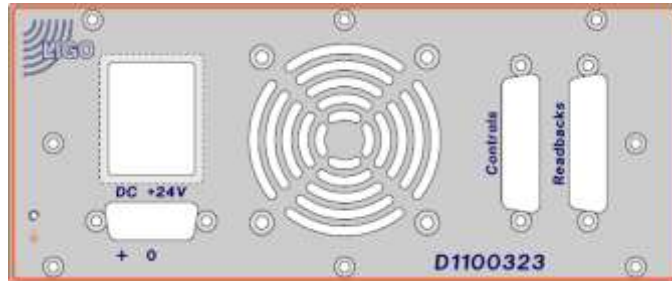

[S1107545](#)

Rear

TCS: CO2P EtherCAT Interface Box ±18VDC

[D1201063](#)

Front

[S1203976](#)

Rear

RF Distribution Amplifier D1000124 S1000650 ±17VDC, ±24VDC

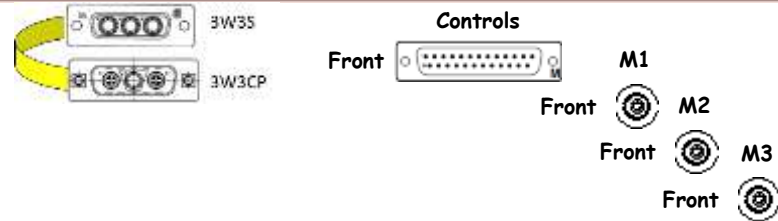
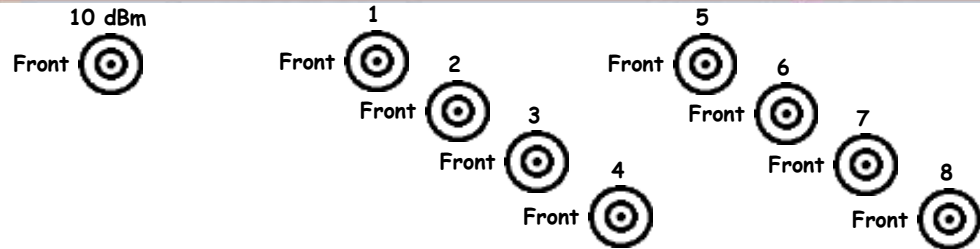
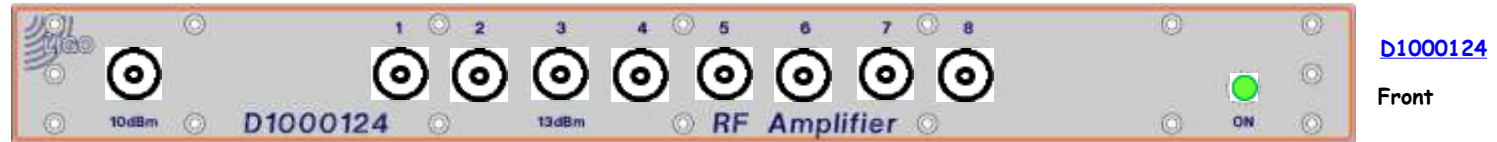

<< LVEA Racks

L1-TCS-R2 (LVEA Y Direction) Field Rack Layout (D1201123) (S1202976)

D1200757
Sequencer



S1202576

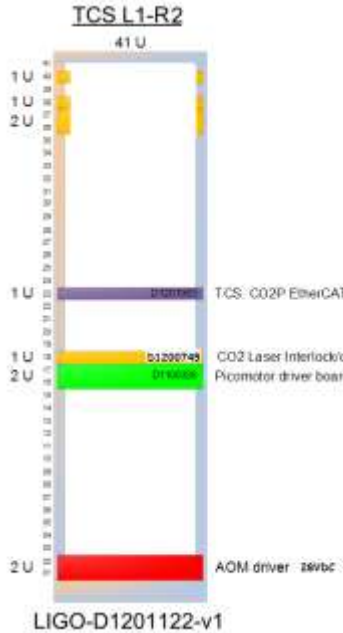

PSoC USB Chassis

TCS Laser Controller

STS-2 Distribution Chassis

CO2P EtherCAT Splitter Chassis

Picomotor Driver

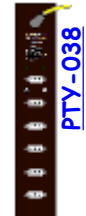
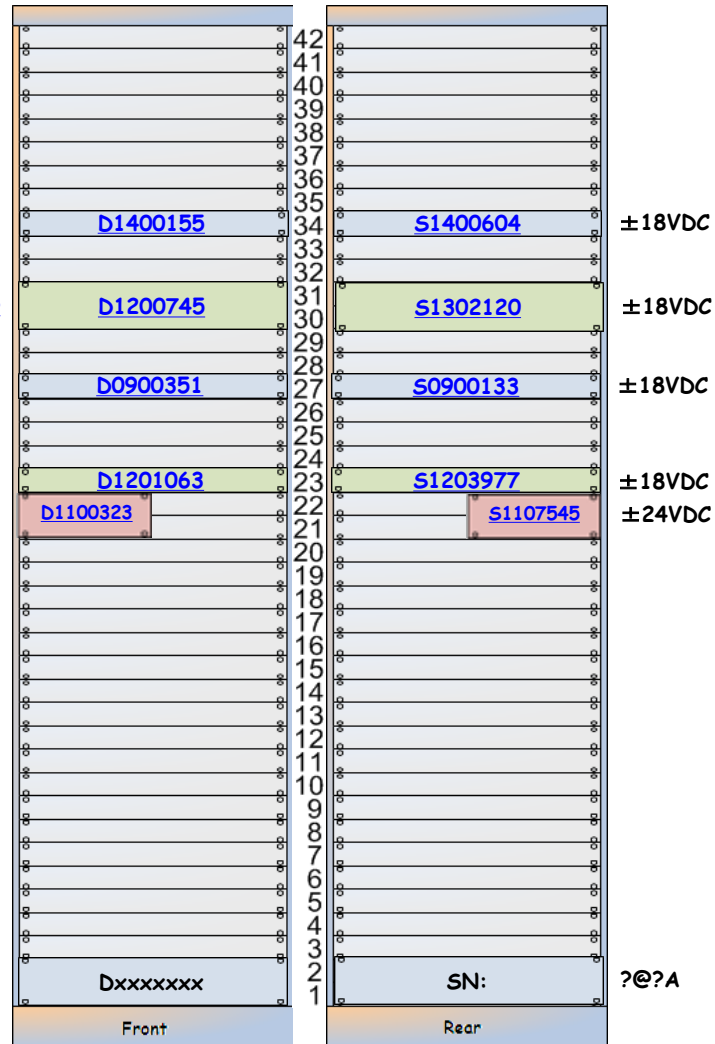

PTY-038



PTO-038

TCS-R2 is part of [D1200258](#)

TCS-R2 is part of [E1100892](#)

PSoC USB Chassis ±18VDC

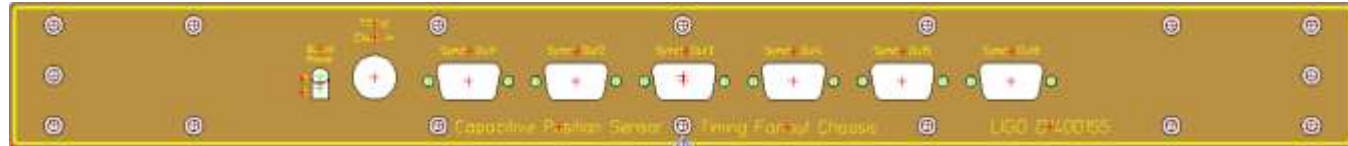

[D1400155](#)

Front



[S1400604](#)

Rear

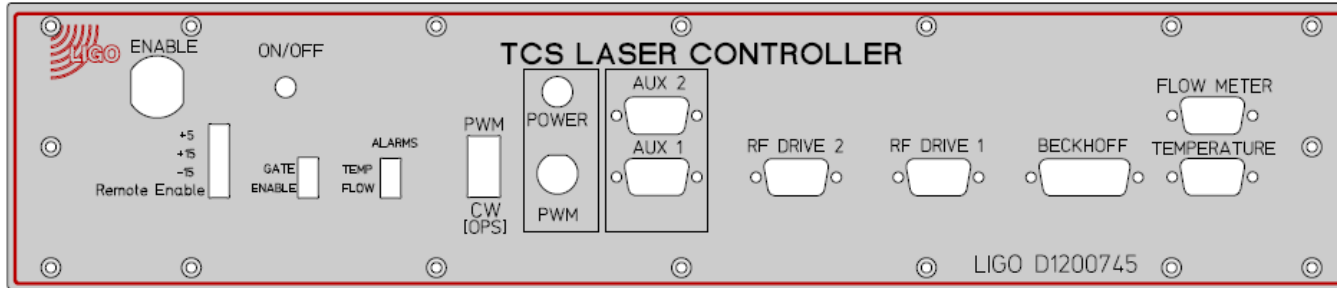

D1200745

Front

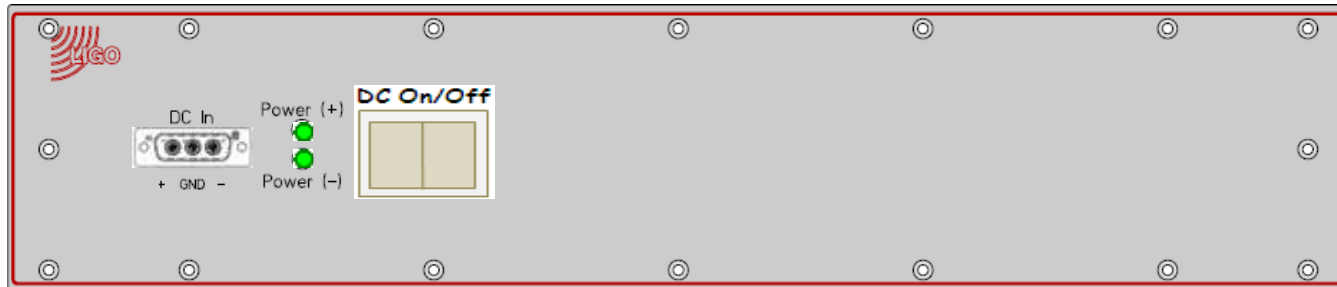

S1302120

Rear

STS-2 Distribution Chassis D0900351 S0900133 ±18VDC

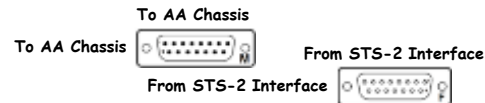
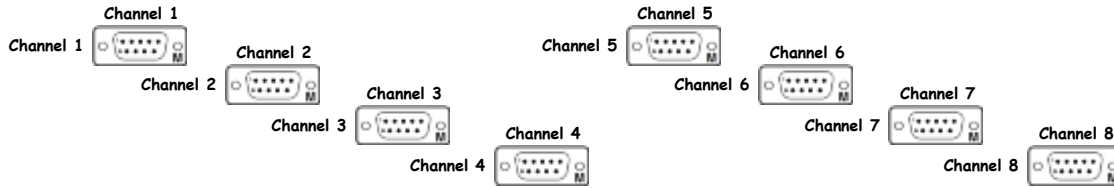

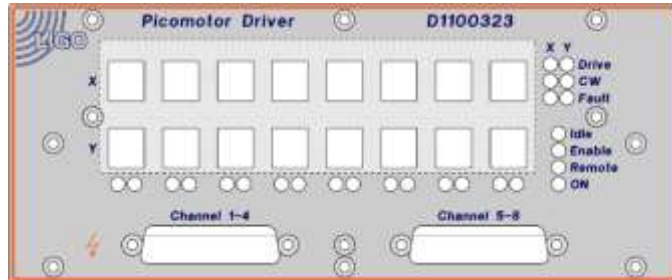

[D1100323](#)

Front

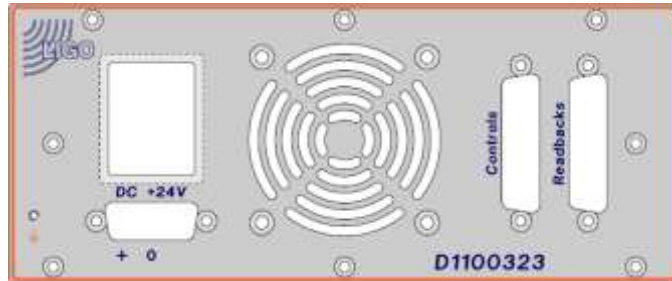

[S1107545](#)

Rear

CO2P EtherCAT Interface Box D1201063 S1203977 ±18VDC

[D1201063](#)

Front

[S1203977](#)

Rear

Marway MPD100 Power Distribution
 Sorensen DCS33-33E Switching DC Power Supply
 Power-Ten 3300D-3020 Switching DC Power Supply

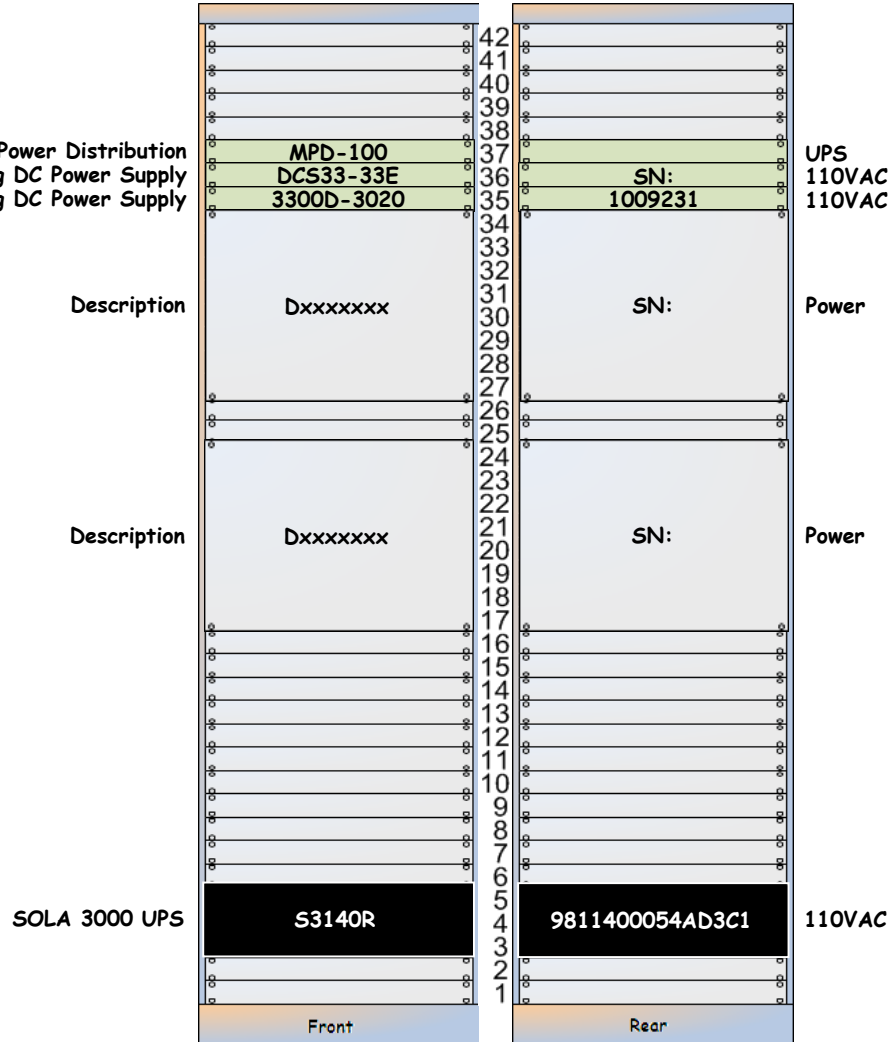

VAC-R1 is part of [T970181](#)

Marway MPD100 Power Distribution
 Sorensen DCS33-33E Switching DC Power Supply
 Power-Ten 3300D-3020 Switching DC Power Supply

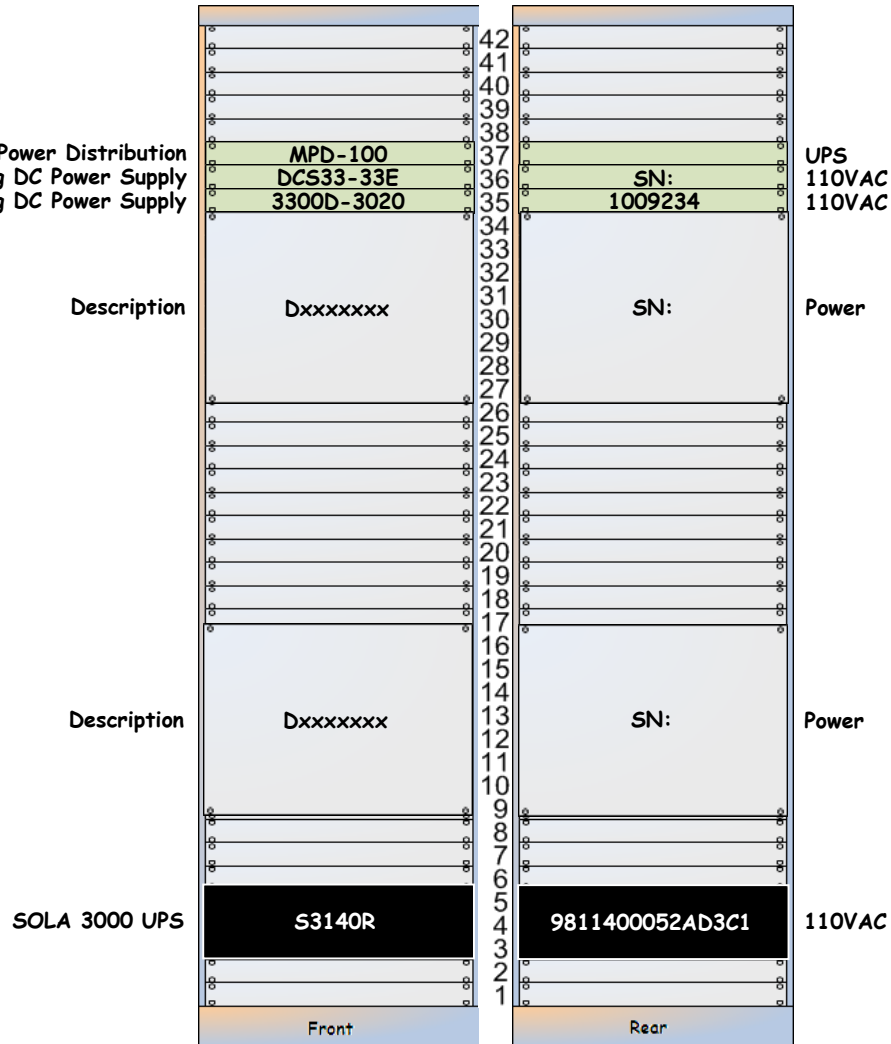

VAC-R2 is part of [T970182](#)

L1-VAC-R3 Mechanical Room Vacuum Rack Layout (Dxxxxxxx)

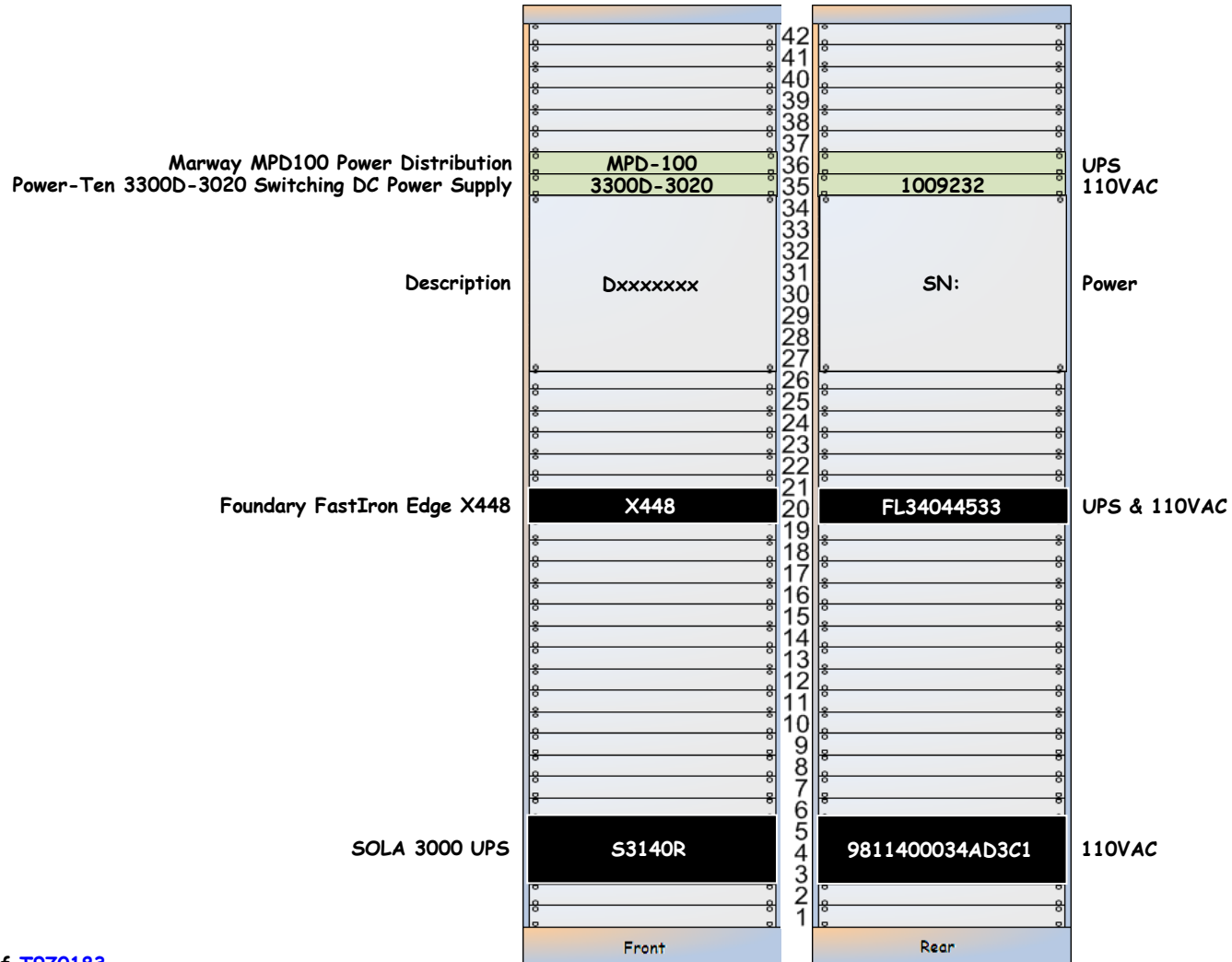

VAC-R3 is part of [T970183](#)

PNL-600 has 4 controllers. Each controller has its own AC circuit.

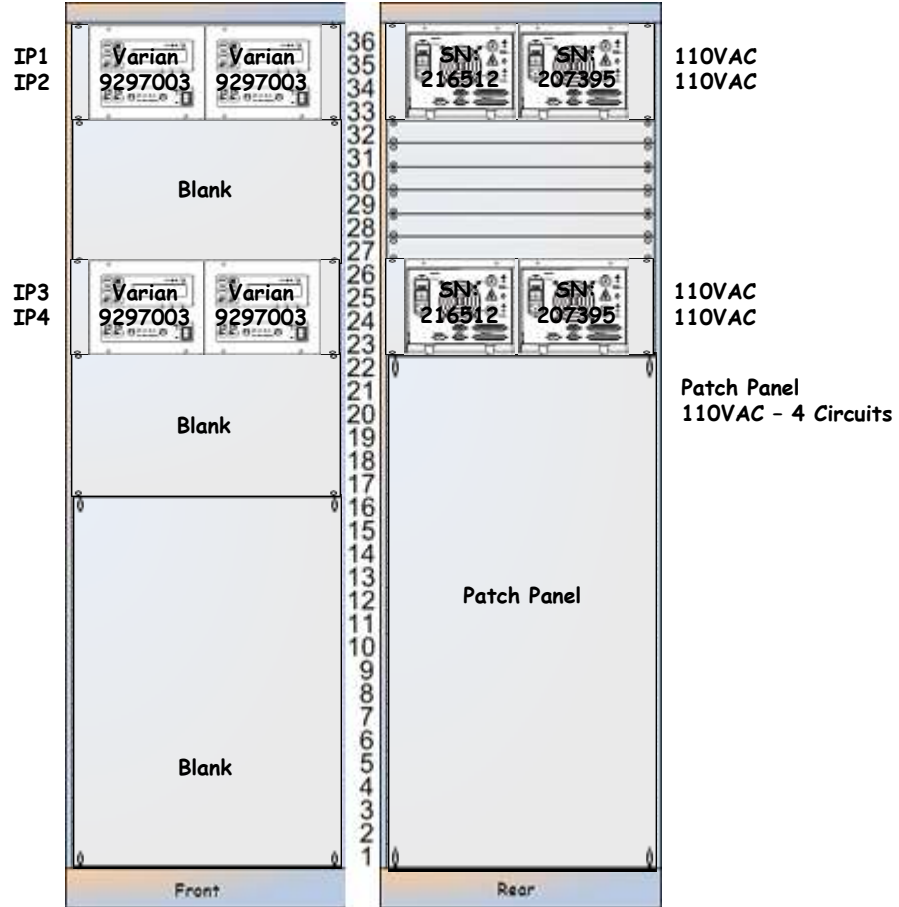

Varian Dual Ion Pump Controller
Both Positive
9297003

PNL-600 is part of Xxxxxxx

XMID

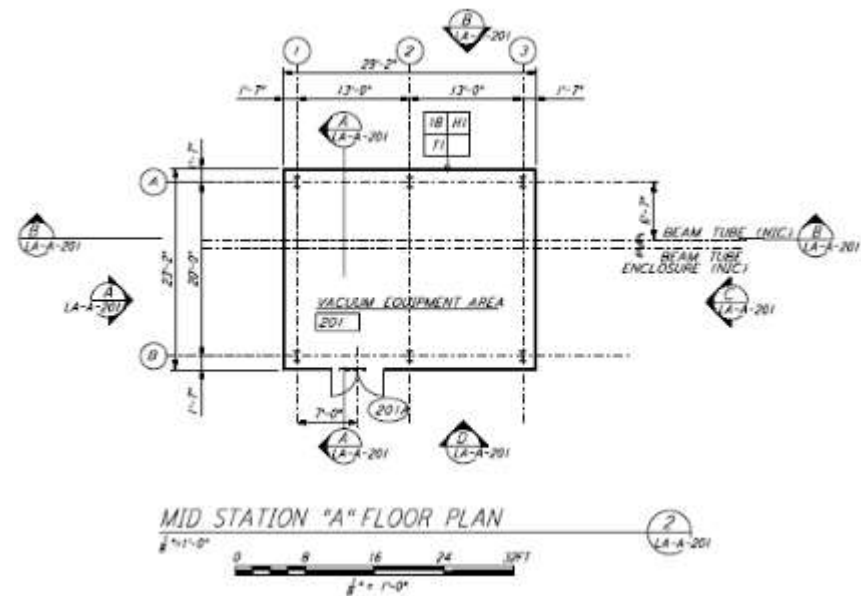
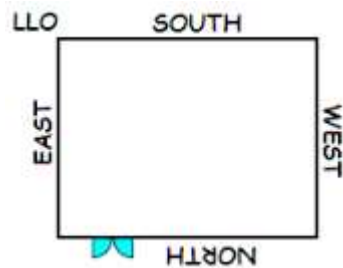

North Side View

East Side View

West Side View

South Side View

[XMID Layout](#)

[XMID Rack](#)

[<< XMID Index](#)

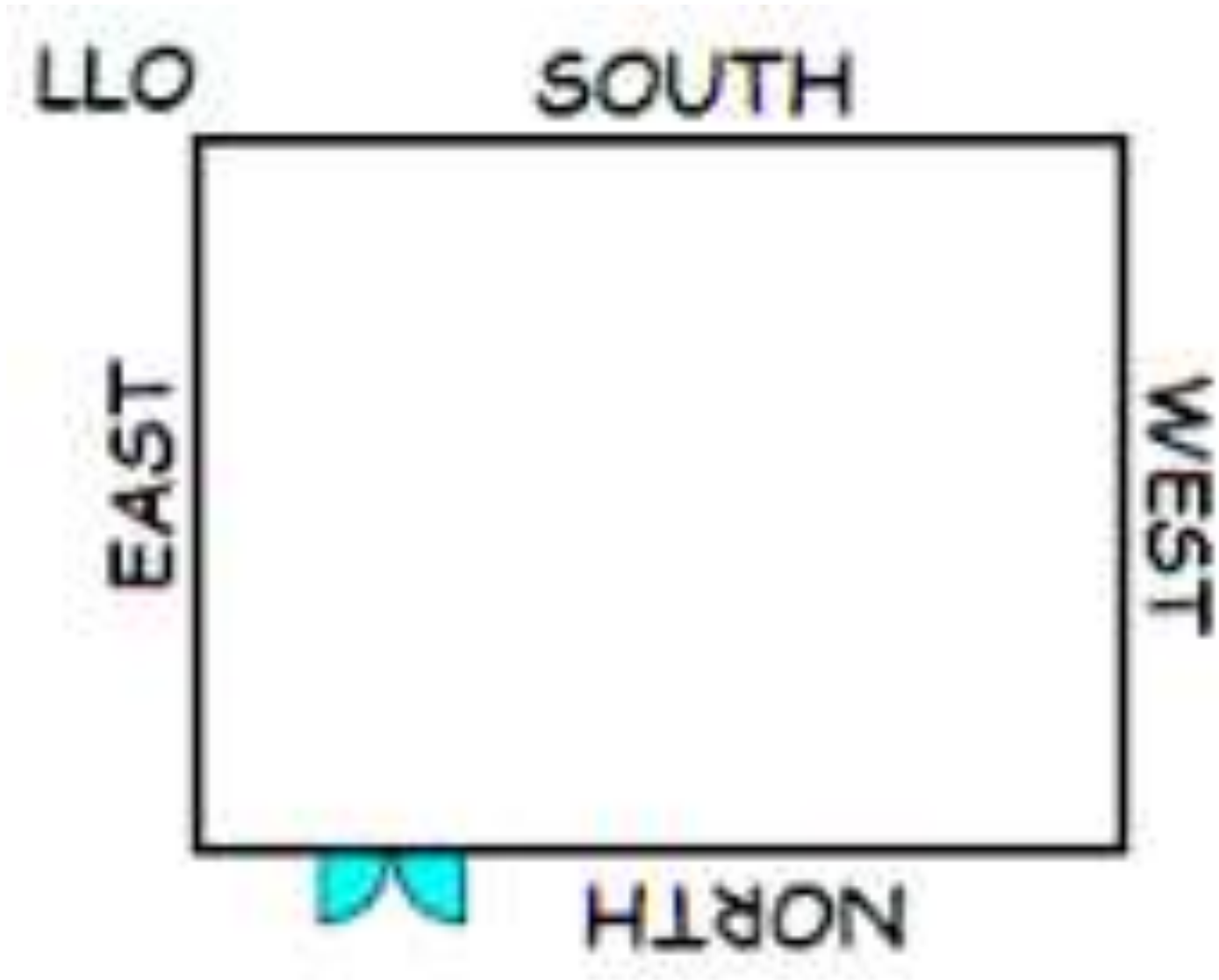

[<< XMID Index](#)



Sorenson DCS33-33E

Transition Networks 100BASE-FX

12-SM Fiber Fiber Patch Panel from Corner Station

All FC

- 12-Fiber Fiber Patch Panel A1 to Transition Networks 100BASE-FX
- 12-Fiber Fiber Patch Panel A2 to Transition Networks 100BASE-FX
- 12-Fiber Fiber Patch Panel A3 to OPEN
- 12-Fiber Fiber Patch Panel A4 to OPEN
- 12-Fiber Fiber Patch Panel A5 to OPEN
- 12-Fiber Fiber Patch Panel A6 to OPEN

12-Fiber Fiber Patch Panel B is Not Present

- 12-Fiber Fiber Patch Panel C1 to OPEN
- 12-Fiber Fiber Patch Panel C2 to OPEN
- 12-Fiber Fiber Patch Panel C3 to OPEN
- 12-Fiber Fiber Patch Panel C4 to OPEN
- 12-Fiber Fiber Patch Panel C5 to OPEN
- 12-Fiber Fiber Patch Panel C6 to OPEN

12-Fiber Fiber Patch Panel D is Not Present

Acromag 968EN-4008

PS5R-SB24 Power Supply

APC Smart UPS 1500

AcroMag connected to Sensor



There is no UPS at XMID

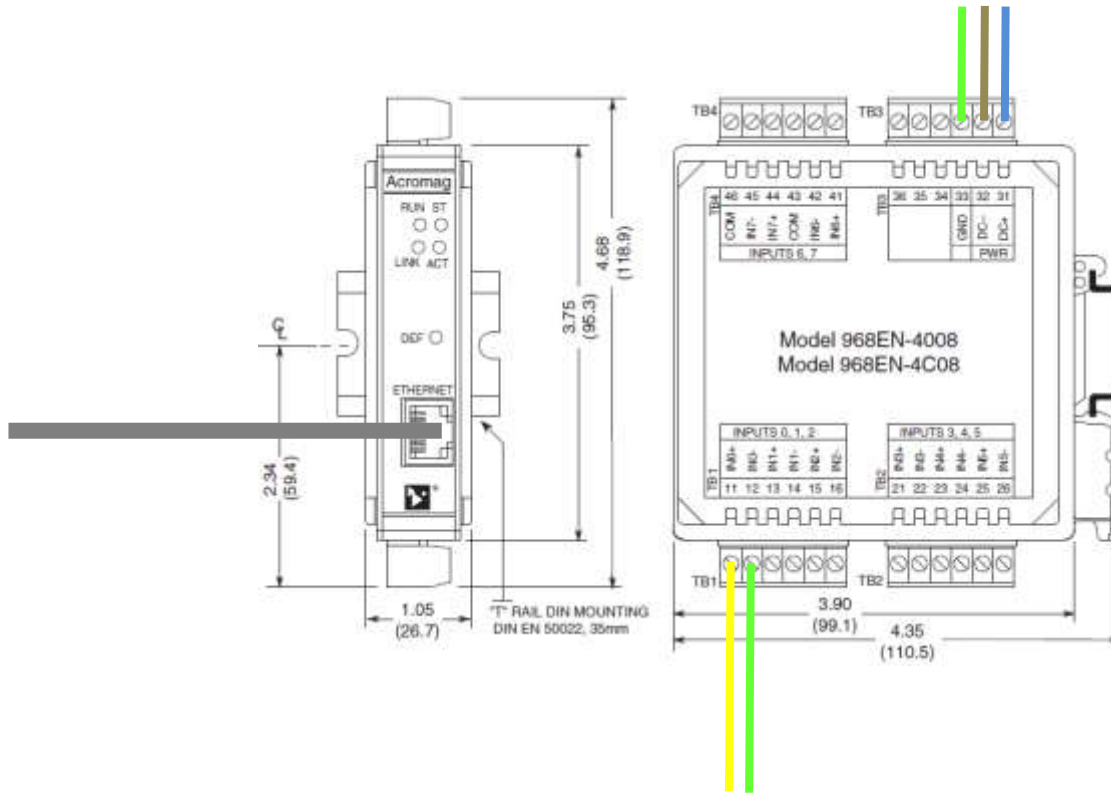

- << [LLO Corner Station](#)
- << [LLO Racks by AREA](#)
- << [LLO CDS Components](#)
- << [XEND Aerial](#)

XEND

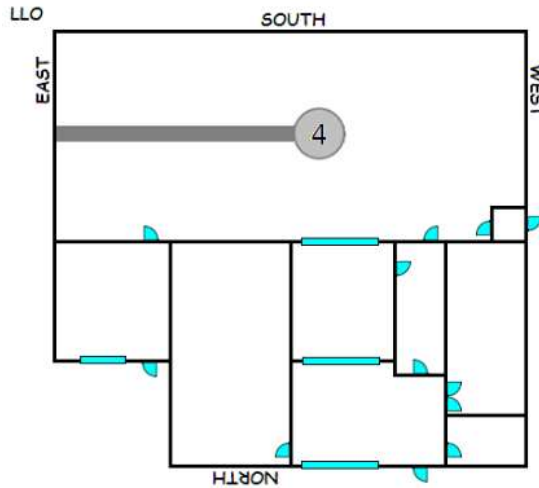

North Side View

East Side View

West Side View

South Side View

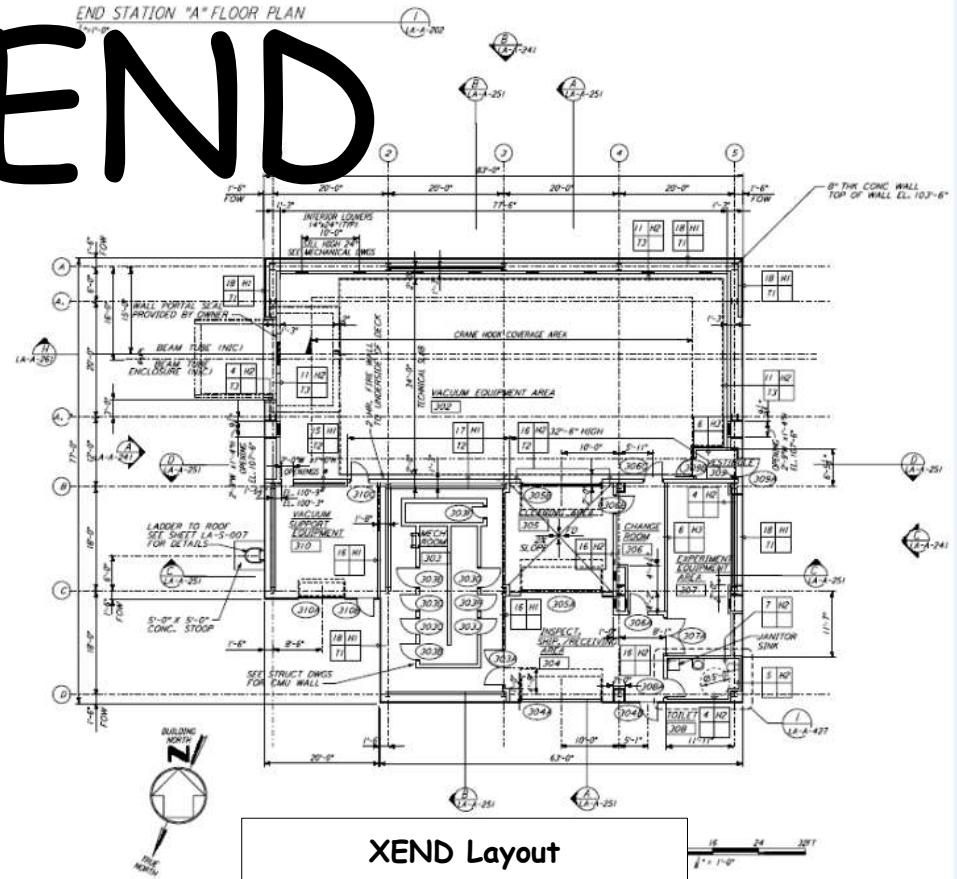

XEND Layout

[XEND Rack Layout](#)

[VEAX Fiber Patch Panel](#)

Mechanical Room

XEND Station Rack Layout

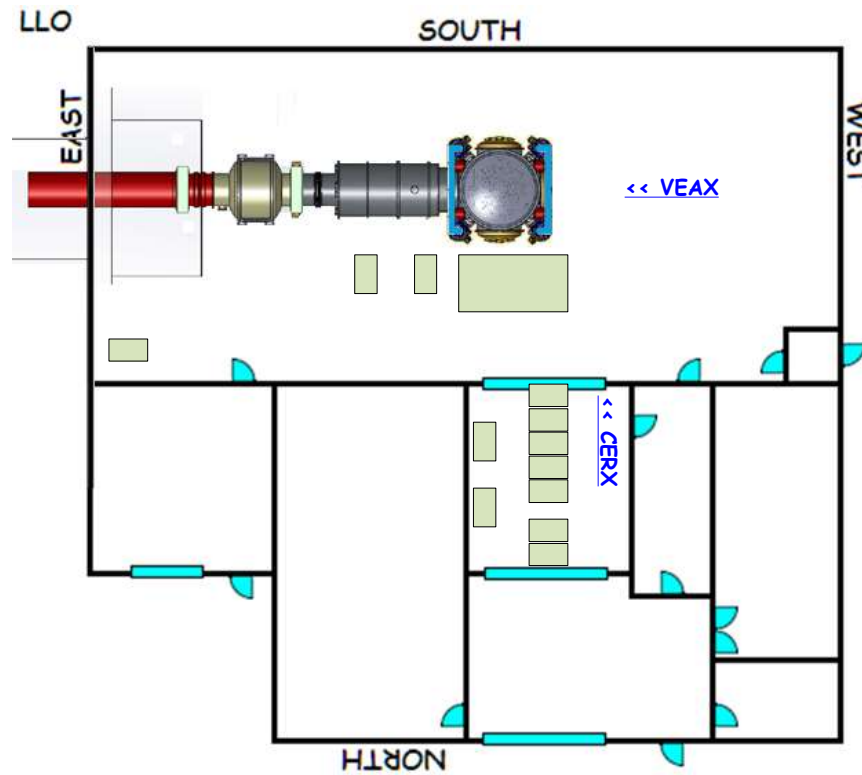



CP16 Connectors

Pin	Pair	Signal
2	4	?
3	1	?
4	1	?
6	3	?
8	3	?
12	4	?
13	2	?
14	2	?

[<< LLO Racks by AREA](#)
[<< LLO Racks by Subsystems](#)

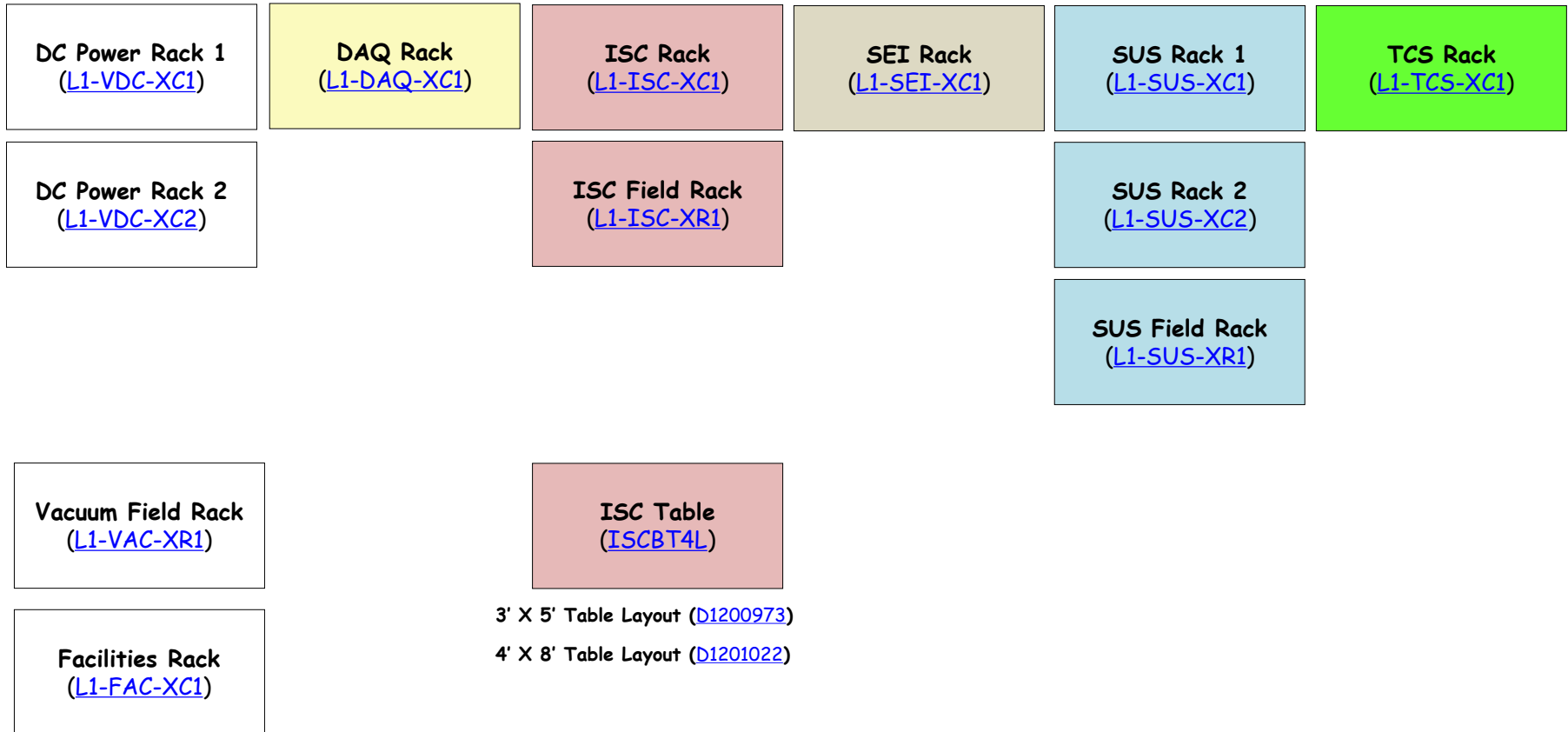

CERX Rack Layout

<< XEND Racks

It is 70' from the L1-FAC-XC1 Rack to the knee of the waterfall in the VEAX.

(D1201292 (XEND Cable Tray))

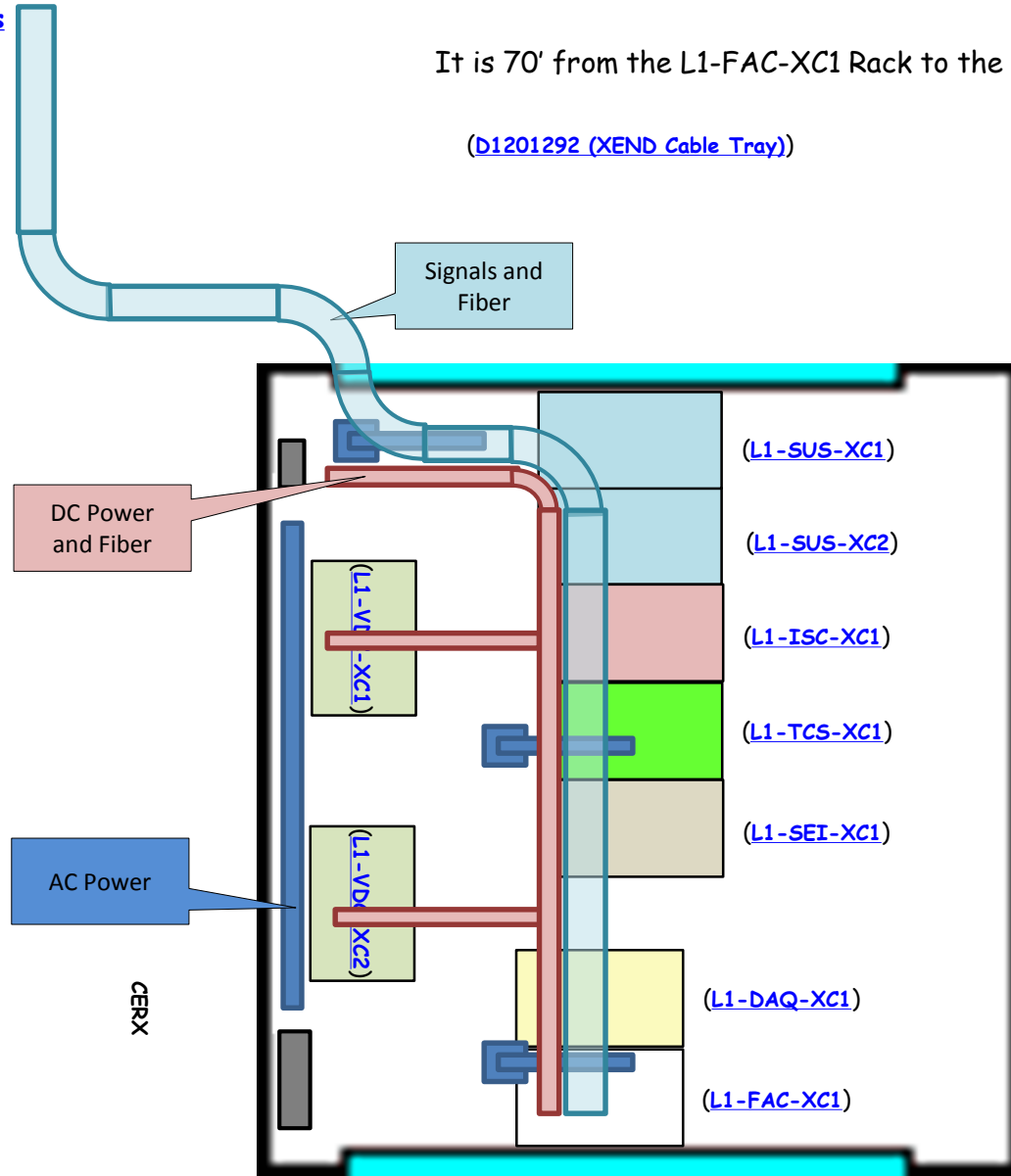

Corning WCH-06P Fiber Panel

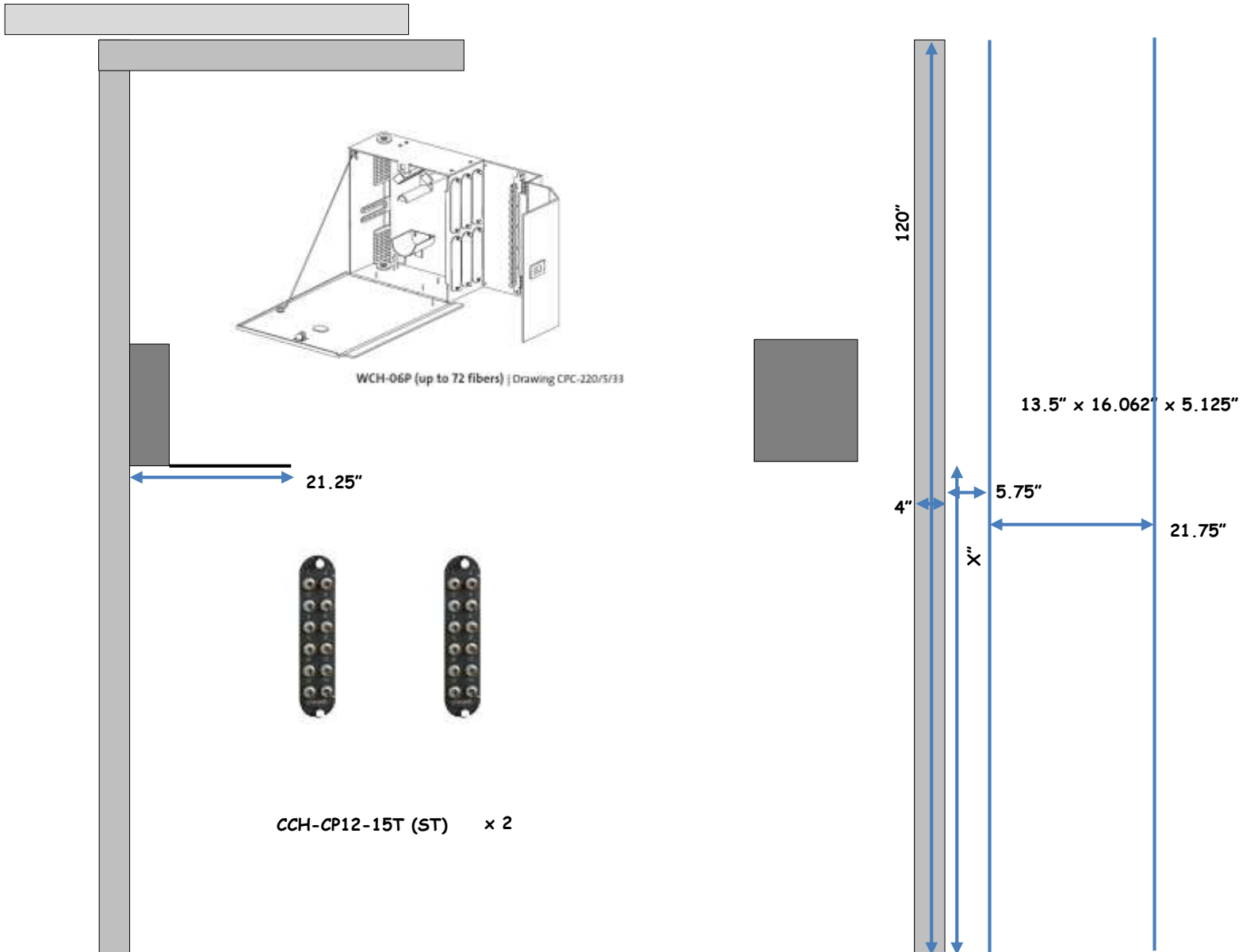

X END Fiber Patch Panel

<< [XEND Index](#)
 << [MSR Patch Panel](#)

VEAX Fiber Patch Panel

Patch Panel

Patch Panel

No Power

A

Port	Subjacket	Fiber	Label	Termination	Fiber Description	Outlying Destination
A01	Blue	Red	X-Fiber-15	LC	l1netfedaqx Port 21F	IP - 10.199.0.87 Netgear G5M7244 Port 21F
A02	Blue	Blue	Empty		Empty	Bad Fiber
A03	Blue	Black	X-Fiber-16	LC	l1netfedaqx Port 21F	IP - 10.199.0.87 Netgear G5M7244 Port 21F
A04	Blue	Orange	X-Fiber-23	ST	ESTOP Comm TX To CER	From CERX to CER (3)
A05	Blue	Yellow	X-Fiber-02	ST	Phone OUT	Extension 401
A06	Blue	Green	X-Fiber-10	LC	l1fedaqx Port 6	ACC 5595 Port 6
A07	Blue	Purple	X-Fiber-01	ST	Phone IN	Extension 401
A08	Blue	Brown	X-Fiber-09	LC	l1fedaqx Port 6	ACC 5595 Port 6
A09	Blue	Tan	X-Fiber-19	ST	Security Cameras	Security Cameras
A10	Blue	Gray	X-Fiber-21	FC	ALS Light	ALS:FDC-XEND (To ISCBT4L)
A11	Blue	Teal	X-Fiber-03	ST	Security Cameras	VT7430 Optical In/Out
A12	Blue	Blue	X-Fiber-24	LC	Timing UTC6-TCT	(Reserved for ALS Light spare - if needed)

B

Port	Subjacket	Fiber	Label	Termination	Fiber Description	Outlying Destination
B01	Orange	Red	X-Fiber-11	LC	GC 2402 Port 25F	IP - 197.168.253.20 GC 2402 Port 25F
B02	Orange	Blue	X-Fiber-17	LC	l1ecatx - SM1	L1-DAQ-XC1 D1100619 VERTEX Port
B03	Orange	Black	X-Fiber-12	LC	GC 2402 Port 25F	IP - 197.168.253.20 GC 2402 Port 25F
B04	Orange	Orange	X-Fiber-18	LC	l1ecatx - SM1	L1-DAQ-XC1 D1100619 VERTEX Port
B05	Orange	Yellow	X-Fiber-07	LC	l1lanfex Port 21F	IP - 10.199.0.13 Netgear G5M7224 Port 21F
B06	Orange	Green	X-Fiber-13	LC	D070011 INPUT Port	L1-TCS-XC1 D070011 INPUT Port
B07	Orange	Purple	X-Fiber-08	LC	l1lanfex Port 21F	IP - 10.199.0.13 Netgear G5M7224 Port 21F
B08	Orange	Brown	X-Fiber-14	LC	D070011 INPUT Port	L1-TCS-XC1 D070011 INPUT Port
B09	Orange	Black	X-Fiber-25	LC	Timing UTC6-TCT	
B10	Orange	Gray	X-Fiber-06	LC	CDS G5624P Port 1F	IP - 10.199.0.20 G5624P Port 1F
B11	Orange	Teal	X-Fiber-05	LC	CDS G5624P Port 1F	IP - 10.199.0.20 G5624P Port 1F
B12	Orange	White	X-Fiber-22	ST	ESTOP Comm TX To CER	From CERX to CER (1)

- A - ST Connectors
- B - ST Connectors
- C - NO Connectors
- D - NO Connectors
- E - NO Connectors
- F - NO Connectors

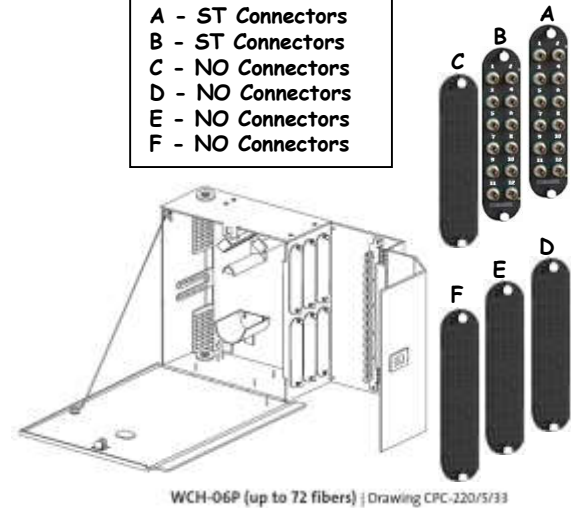

[See LIGO-E1500002](#)

[Y END Fiber Patch Panel >>](#)

L1-VDC-XC1 Power Racks - VEAX Field Supplies

<< [CERX Racks](#)
 << [XEND Racks and Tables](#)

L1-VDC-XC1 XEND Station DC Power Rack Layout ([D1200897](#)) ([S1202311](#))

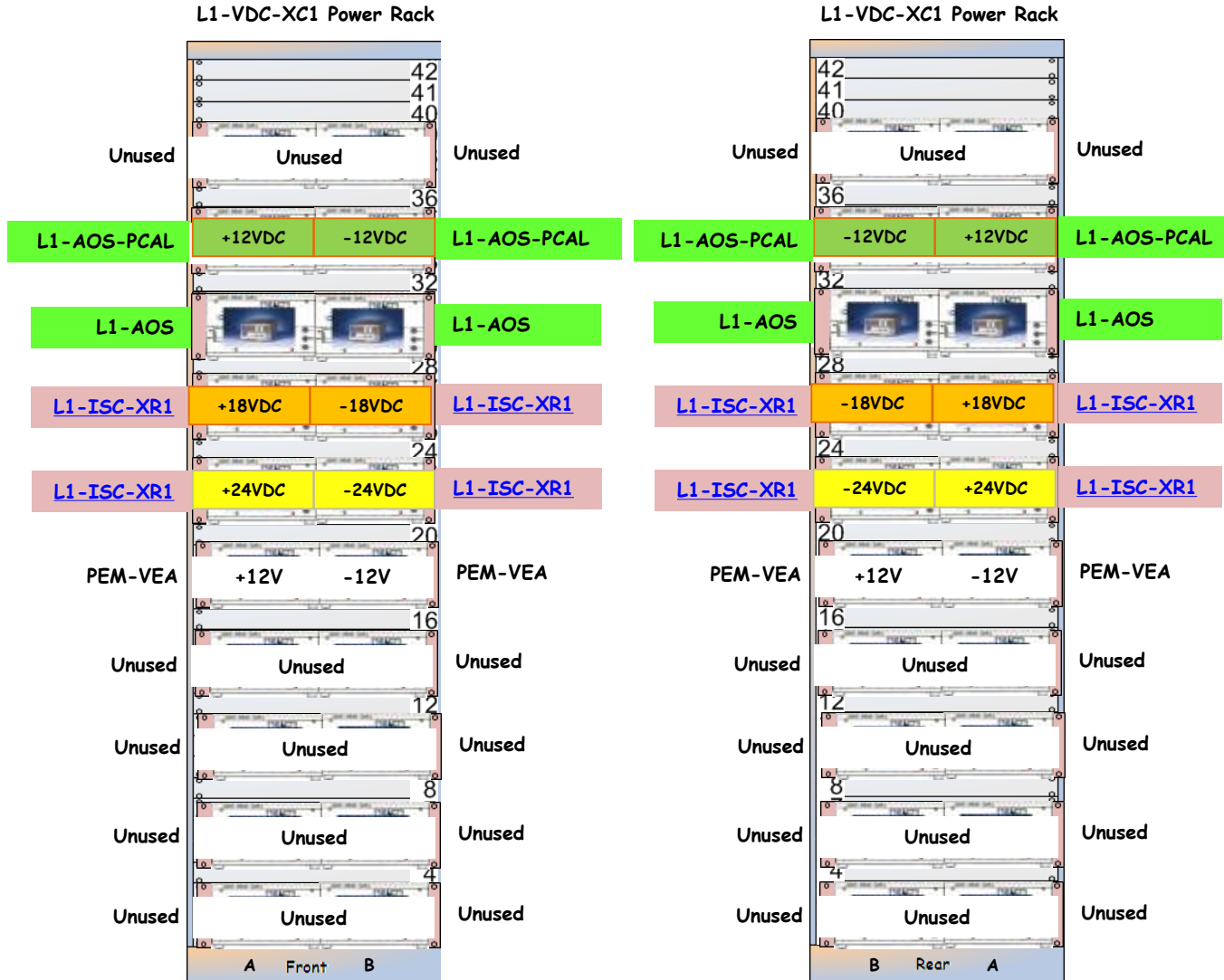

[Cable Runs >>](#)

L1-VDC-XC1 Cable Runs

<< [L1-VDC-XC1](#)

L1-VDC-XC1 XEND Station DC Cable Runs ([D1200897](#)) ([S1202311](#))

L1-VDC-XC1 S1202311	Power Panel	Circuit	DC Power Rack	Outlet	Plug Position	Rack U	Power Supply Model	Power Supply Serial	Polarity	DC Extension Cable	Electronics Rack	Cable Length	DC Power Strip
1	CDS-X		L1-VDC-XC1	8	Top	U37-A (Left)							
2	CDS-X		L1-VDC-XC1	8	Bottom	U37-B (Right)							
3	CDS-X		L1-VDC-XC1	2	Top	U33-A (Left)	JQE 15V 12A	H114617	Plus	PTG	L1-AOS-PCAL	76	None
4	CDS-X		L1-VDC-XC1	2	Bottom	U33-B (Right)	JQE 15V 12A	H114627	Minus	PTG	L1-AOS-PCAL	76	None
5	CDS-X		L1-VDC-XC1	9	Top	U29-A (Left)	BHK 500V 80mA	A107266	Plus	PBX-003	L1-AOS		
6	CDS-X		L1-VDC-XC1	9	Bottom	U29-B (Right)	BHK 500V 80mA	A107260	Minus	PBX-003	L1-AOS		
7	CDS-X		L1-VDC-XC1	3	Top	U25-A (Left)	JQE 25V 20A	H236461	Plus	PTO-064	L1-ISC-XR1	60	PSO-xxx
8	CDS-X		L1-VDC-XC1	3	Bottom	U25-B (Right)	JQE 25V 20A	H236389	Minus	PTO-064	L1-ISC-XR1	60	PSO-xxx
9	CDS-X		L1-VDC-XC1	10	Top	U21-A (Left)	JQE 25V 10A	H222052	Plus	PTY-057	L1-ISC-XR1	60	PSY-xxx
10	CDS-X		L1-VDC-XC1	10	Bottom	U21-B (Right)	JQE 25V 10A	H192369	Minus	PTY-057	L1-ISC-XR1	60	PSY-xxx
11	CDS-X		L1-VDC-XC1	4	Top	U17-A (Left)	JQE 15-12A		Plus		PEM VEA	76	PSG-xxx
12	CDS-X		L1-VDC-XC1	4	Bottom	U17-B (Right)	JQE 15-12A		Minus		PEM VEA	76	PSG-xxx
13	CDS-X		L1-VDC-XC1	11	Top	U13-A (Left)							
14	CDS-X		L1-VDC-XC1	11	Bottom	U13-B (Right)							
15	CDS-X		L1-VDC-XC1	5	Top	U09-A (Left)							
16	CDS-X		L1-VDC-XC1	5	Bottom	U09-B (Right)							
17	CDS-X		L1-VDC-XC1	12	Top	U05-A (Left)							
18	CDS-X		L1-VDC-XC1	12	Bottom	U05-B (Right)							
19	CDS-X		L1-VDC-XC1	6	Top	U01-A (Left)							
20	CDS-X		L1-VDC-XC1	6	Bottom	U01-B (Right)							
D1200897													

L1-VDC-XC2 Power Racks - VEAX Supplies

<< [CERX Racks](#)
 << [XEND Racks and Tables](#)

L1-VDC-XC2 XEND Station DC Power Rack Layout ([D1200898](#)) ([S1202312](#))



[Cable Runs >>](#)

L1-VDC-XC2 Cable Runs

<< [L1-VDC-XC2](#)

L1-VDC-XC2 XEND Station DC Cable Runs ([D1200898](#)) ([S1202312](#))

L1-VDC-XC2 S1202312	Power Panel	Circuit	DC Power Rack	Outlet	Plug Position	Rack U	Power Supply Model	Power Supply Serial	Polarity	DC Extension Cable	Electronics Rack	Cable Length	DC Power Strip
1	CDS-X		L1-VDC-XC2	8	Top	U37-A (Left)							
2	CDS-X		L1-VDC-XC2	8	Bottom	U37-B (Right)							
3	CDS-X		L1-VDC-XC2	2	Top	U33-A (Left)	JQE 25V 10A	H222053	Plus	PTY-053	L1-ISC-XC1	30	PSY-xxx
4	CDS-X		L1-VDC-XC2	2	Bottom	U33-B (Right)	JQE 15V 6A JQE 15V 6A	H214514 H214461	Plus Minus	PTG-005	L1-ISC-XC1	30	PSG-006
5	CDS-X		L1-VDC-XC2	9	Top	U29-A (Left)	JQE 25V 20A	H236497	Plus	PTO-042	L1-SUS-XC2	30	PSO-042
6	CDS-X		L1-VDC-XC2	9	Bottom	U29-B (Right)	JQE 25V 20A	H236515	Minus	PTO-042	L1-SUS-XC2	30	PSO-042
7	CDS-X		L1-VDC-XC2	3	Top	U25-A (Left)	JQE 25V 20A	H236501	Plus	PTO-043	L1-SUS-XC1	32	PSO-043
8	CDS-X		L1-VDC-XC2	3	Bottom	U25-B (Right)	JQE 25V 20A	H236473	Minus	PTO-043	L1-SUS-XC1	32	PSO-043
9	CDS-X		L1-VDC-XC2	10	Top	U21-A (Left)	JQE 25V 20A	H236510	Plus	PTO-044	L1-ISC-XC1 L1-TCS-XC1	28	PSO-044
10	CDS-X		L1-VDC-XC2	10	Bottom	U21-B (Right)	JQE 25V 20A	H236511	Minus	PTO-044	L1-ISC-XC1 L1-TCS-XC1	28	PSO-044
11	CDS-X		L1-VDC-XC2	4	Top	U17-A (Left)	JQE 25V 20A	H236493	Plus	PTY-031	L1-ISC-XC1 L1-TCS-XC1	28	PSY-031
12	CDS-X		L1-VDC-XC2	4	Bottom	U17-B (Right)	JQE 25V 20A	H236517	Minus	PTY-031	L1-ISC-XC1 L1-TCS-XC1	28	PSY-031
13	CDS-X		L1-VDC-XC2	11	Top	U13-A (Left)	JQE 25V 20A	H236505	Plus	PTO-045	L1-SEI-XC1	22	PSO-045
14	CDS-X		L1-VDC-XC2	11	Bottom	U13-B (Right)	JQE 25V 20A	H236494	Minus	PTO-045	L1-SEI-XC1	22	PSO-045
15	CDS-X		L1-VDC-XC2	5	Top	U09-A (Left)	JQE 25V 20A	H236509	Plus	PTY-032	L1-SEI-XC1	22	PSY-032
16	CDS-X		L1-VDC-XC2	5	Bottom	U09-B (Right)	JQE 25V 20A	H236492	Minus	PTY-032	L1-SEI-XC1	22	PSY-032
17	CDS-X		L1-VDC-XC2	12	Top	U05-A (Left)	JQE 25V 20A	H236482	Plus	PTY-033	L1-ISC-XC1	30	PSY-033
18	CDS-X		L1-VDC-XC2	12	Bottom	U05-B (Right)	JQE 25V 20A	H236481	Plus	PTY-034	L1-SEI-XC1	22	PSY-034
19	CDS-X		L1-VDC-XC2	6	Top	U01-A (Left)	JQE 25V 20A	H236498	Plus	PTY-035	L1-SUS-XC2	32	PSY-035
20	CDS-X		L1-VDC-XC2	6	Bottom	U01-B (Right)	JQE 25V 20A	H236514	Plus	PTY-036	L1-SUS-XC1	32	PSY-036
D1200898													

<< [CERX Racks](#)
 << [XEND Racks and Tables](#)

L1-DAQ-XC1 XEND Station Remote Rack Layout ([D1201085](#)) ([S1202949](#))

Serial to Internet Converter
 Lantronix
 SDS2101, UDS2100
 SN: 00204AD7A3CC
 +12V Wall Wart

[Dolphin RFM Switch](#)
[ACC 5595 Reflective Memory Hub](#)
[l1netfedaqx 10.199.0.87](#)
[l1lanfex 10.199.0.13](#)
 Solid Shelf
[Timing IRIG-B Interface Chassis](#)

[ATEN KVM Switch](#)
[l1susauxex Front End Computer 10.110.140.53](#)
[l1susex Front End Computer 10.110.140.52](#)
[l1seiex Front End Computer 10.110.140.51](#)
[l1iscex Front End Computer 10.110.140.50](#)
[l1ecatx1 Beckhoff Host Computer ???.???.???.??](#)
[l1hwsx1 Hartmann Sensor Computer 10.110.130.22](#)

[UPS Group 1 and Group 2](#)

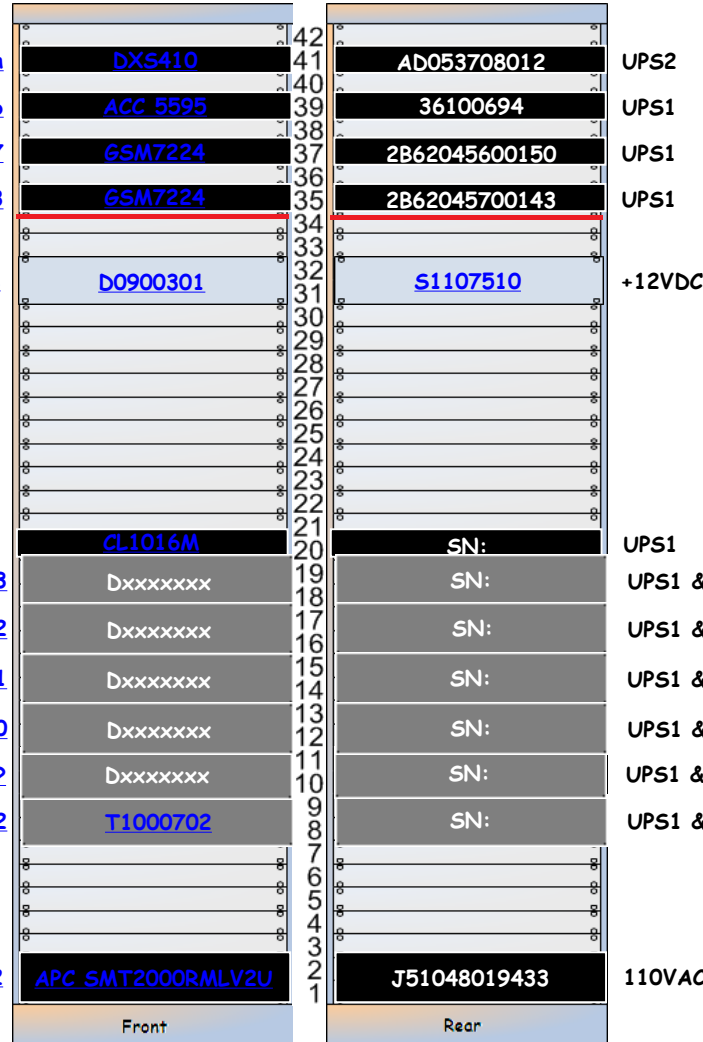

Front

Rear

L1-DAQ-XC1 Details

Dolphin RFM Switch DS5410 - AD053708012

<< L1-DAQ-XC1

Dolphin RFM Switch

DXS410

AD053708012

UPS2



ACC 5595

Front

To I1lanfey port 5

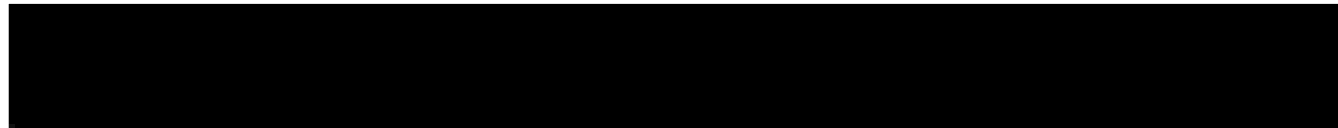

AD053708012

Rear

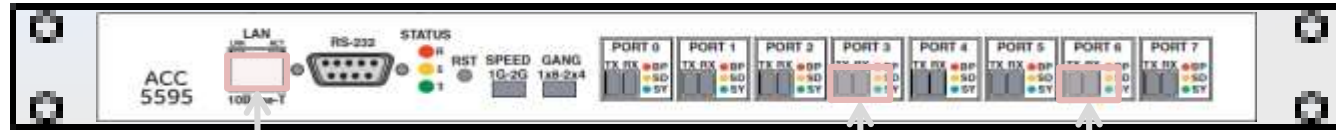

ACC 5595

Front

To 11lanfey port 5

To 1X23 A3, A4

To 11 pemex PCIE 5565RC

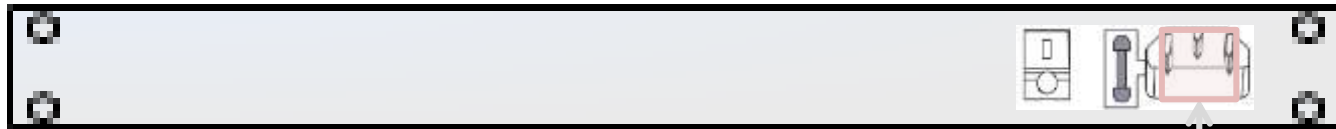

36100694

Rear

To UPS Power Strip

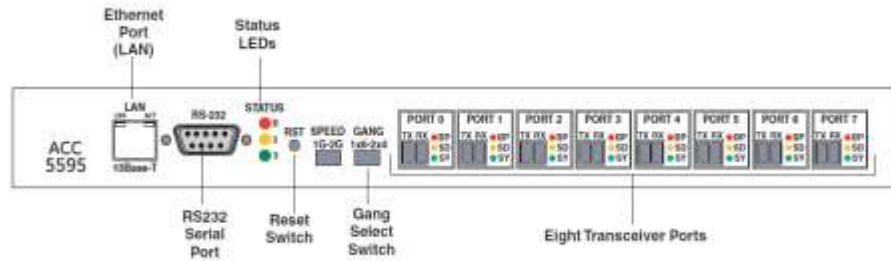



GSM7224

Front

CO:3F:0E:86:88:E0

3 - To FE NET Port

21F - To 1X23 PP B1, B2



2B62045600150

Rear

To UPS Power Strip



GSM7224

Front

CO:3F:0E:86:88:AC

3 - To FE LAN Port

5 - To 5595 LAN 10BaseT

21F - To 1X23 PP E3,E4



2B62045700143

Rear

To UPS Power Strip

Timing IRIG-B Interface Chassis

D0900301

S1107510

+12VDC

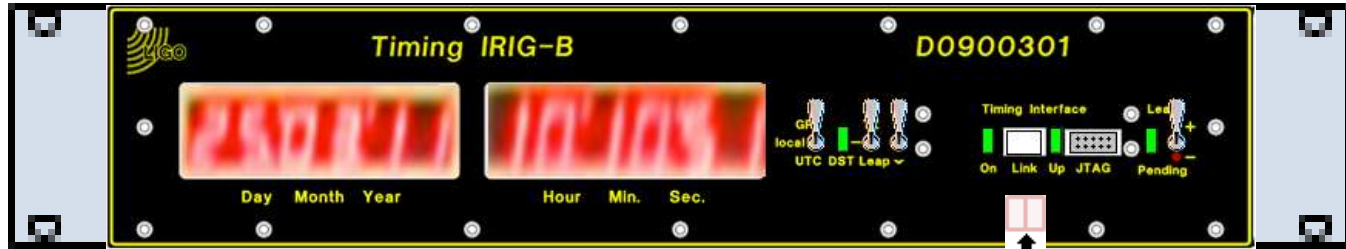

D0900301

Front

Timing Fanout (No Label)

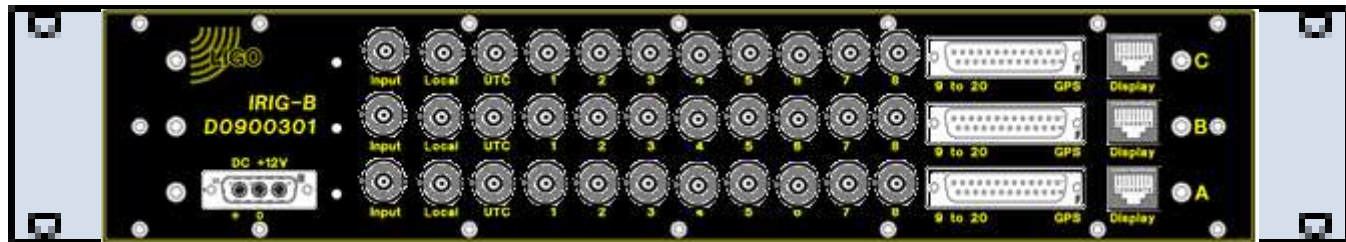

S1107510

Rear

ATEN KVM Switch CL1016M

<< L1-DAQ-XC1

ATEN KVM Switch

CL1016M

Z8A6Y132ANQ0010

110VAC



[<< L1-DAQ-XC1](#)

l1ecatx1 Beckhoff Host Computer ???.???.???.??

Dxxxxxxxx

SN:

UPS1 & 110VAC

APC SMX2000RMLV2U

UPS

APC SMX2000RMLV2U

JS1048019433

110VAC



APC SMX2000RMLV2U

Front



JS1048019433

Rear

To UPS Power Strip

<< [CERX Racks](#)
 << [XEND Racks and Tables](#)

L1-FAC-XC1 Facilities XEND Station Remote Rack Layout ([D1201086](#)) ([S1202950](#))

[Brocade FastIron Edge GS624P](#)
 Solid Shelf

[2402 Network Switch](#)
 Solid Shelf

[XEND Phone](#)
 Kantech
 Perforated Shelf

[Control](#)

[Security Cameras](#)
 IFO Cameras

[ESTOP-X Fiber Contacts](#)

[KEPCO Power Supplies](#)

[UPS1](#)

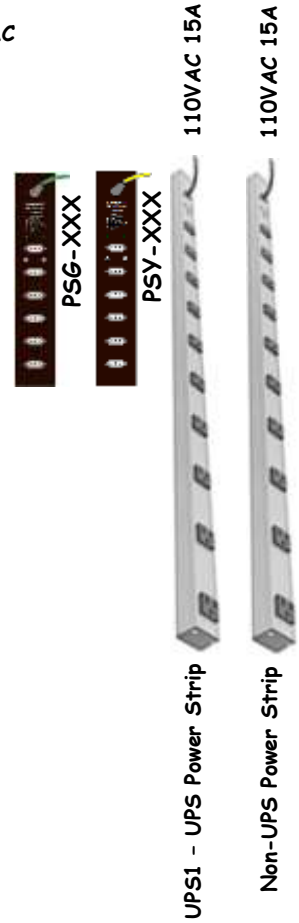
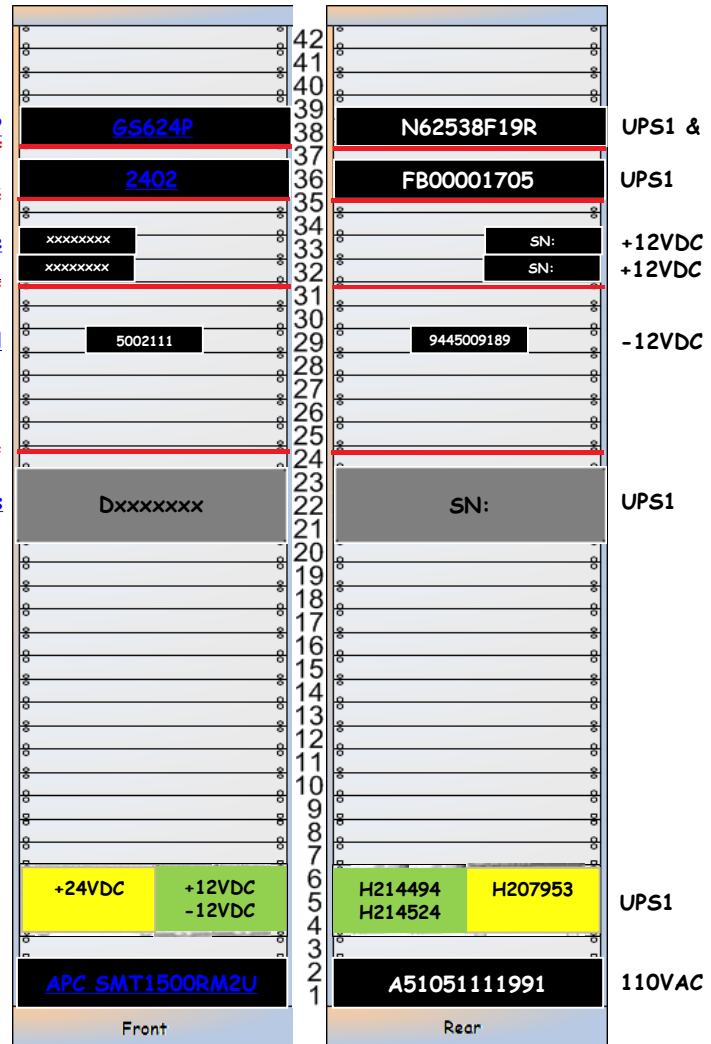

L1-FAC-XC1 Details

<< L1-FAC-XC1

Brocade FastIron Edge GS624P

GS624P

N62538F19R

UPS & 110VAC



GSM7224

Front

CO:3F:0E:86:88:E0

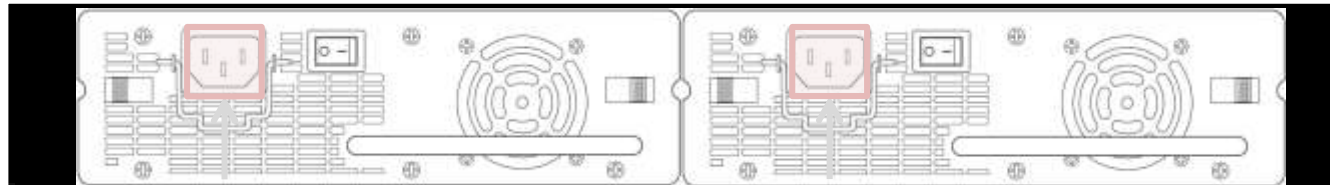

N62538F19R

Rear

To 110 Power Strip

To UPS Power Strip

<< L1-FAC-XC1

2402 Network Switch

2402

FB00001705

110VAC

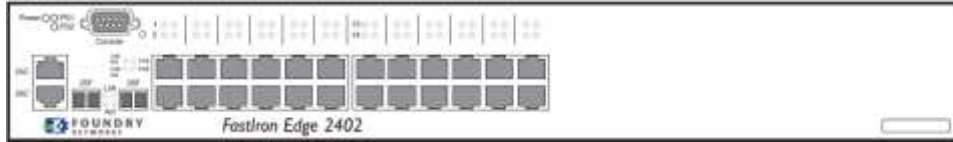

- Empty ↔ 01
- Kantech??? ↔ 02
- Empty ↔ 03
- Empty ↔ 04
- Empty ↔ 05
- Empty ↔ 06
- Empty ↔ 07
- Empty ↔ 08
- Empty ↔ 09
- Empty ↔ 10
- Empty ↔ 11
- Empty ↔ 12
- Empty ↔ 13
- To Seimens ↔ 14
- Empty ↔ 15
- Empty ↔ 16
- Empty ↔ 17
- Empty ↔ 18
- Empty ↔ 19
- Empty ↔ 20
- Empty ↔ 21
- Empty ↔ 22
- Empty ↔ 23
- Empty ↔ 24

- Empty ↔ 25C
- Empty ↔ 26C
- To Special Cable CSR1 ↔ 25F
- To 1X23 PP E1,E2 ↔ 26F

Government Property Tag: G12036
192.168.253.20

To UPS Power Strip

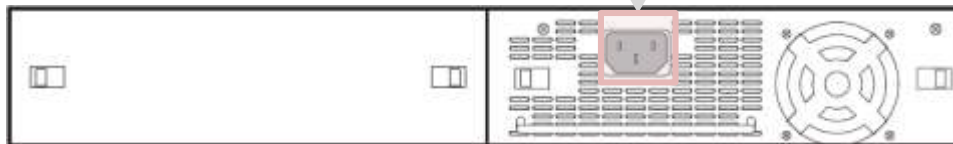

PS1

<< L1-FAC-XC1

Phone

TR3030WDM
GE Security
Optical In/Out:
[To 1X23 PP](#)
[B3,B4](#)
Phone: Copper to
VEA
Power: 12VDC

Powered from Wall Wart from
Tripp-Lite UPS
Model BC320
9834DY0BC614000661 To 6-
Outlet Power Strip in Non-
isolated wall socket



System Design

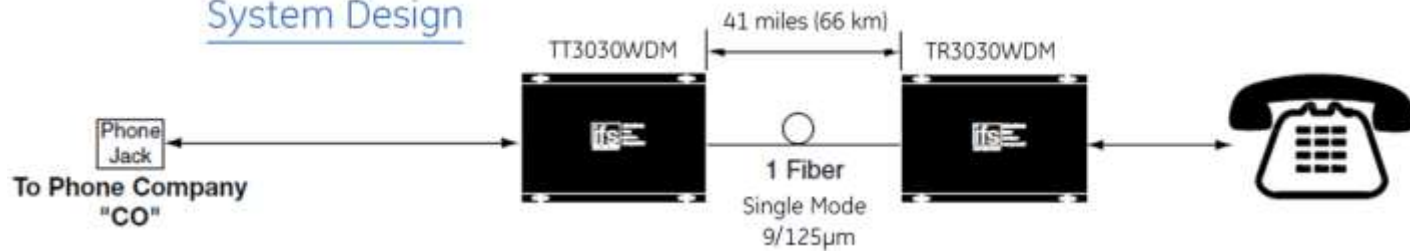

<< L1-FAC-XC1

Kantech

Fiber Options
[7711-R \(501R\)](#)
Optical In/Out:
[To 1Y23 PP D2](#)
Power: 13.5VDC
from Wall Wart

Blue CAT5:
1=O/W and
B/W, 4=O, 7=B

Powered from
Wall Wart from
Isolated Power

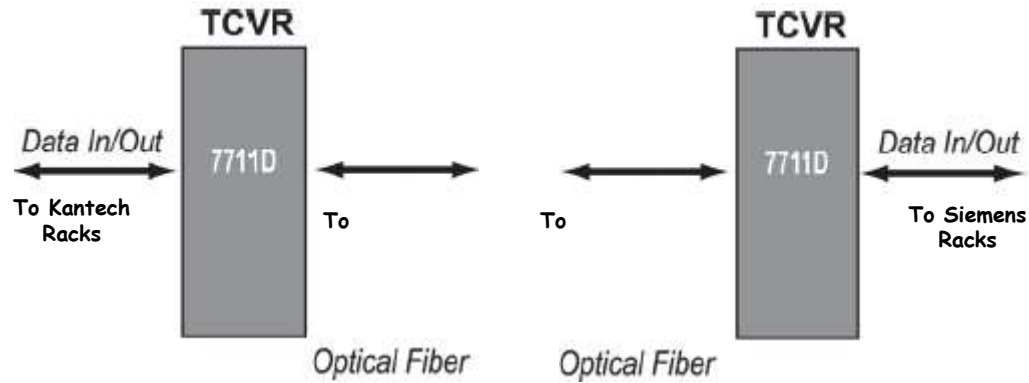

XEND - Control Interface

Control

5002111

9445009189

-12VDC

[Control DeviceMaster 4 with DB9 Ports](#)

MAC Address:
00-C0-4E-07-3F-5D

IP Address:
10/110.60.??

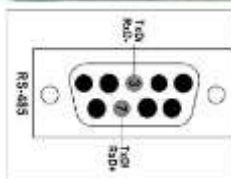

4-Port Power Supply

This table provides the specifications for the power supply shipped with the DeviceMaster 4-port.

Control Power Supply: 4-Port	
Input line frequency	47 - 63 Hz
Input line voltage	90 - 260 VAC
Output voltage	24VDC
Output current	500 mA @ 24VDC

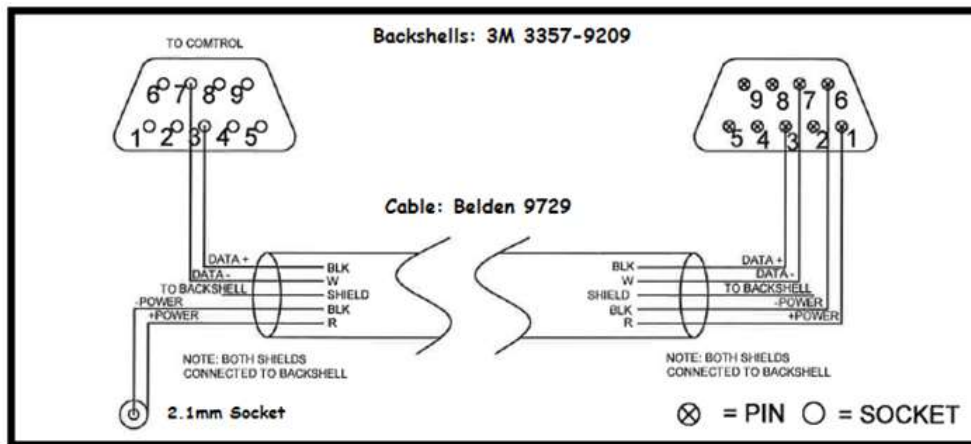
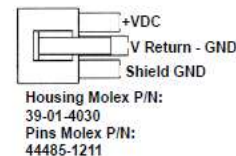

3M Shell 3357-9209

3M Shell 3357-9209

2.1mm Socket
(Note polarity)

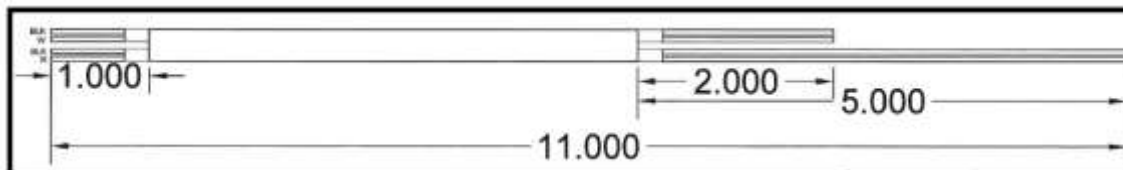

2.1mm Plug
(Note polarity)

ESTOP-X Fiber Contacts

The LIGO logo consists of the word "LIGO" in a bold, black, sans-serif font. To the left of the text is a stylized graphic of concentric, overlapping circles, resembling a ripple or a fiber optic lens.

[<< L1-FAC-XC1](#)

ESTOP-X Fiber Contacts

Dxxxxxxx

SN:

UPS1

<< L1-FAC-XC1

KEPCO Power Supplies

+24VDC	+12VDC -12VDC
--------	------------------

H214494 H214524	H207953
--------------------	---------

UPS1

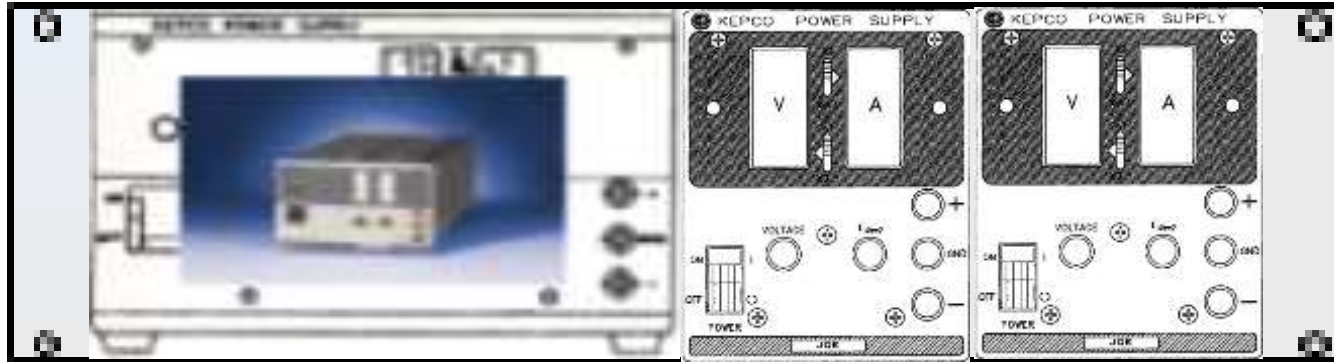

JQE

Front

KEPCO JQE 25-10
+24VDC

KEPCO JQE 15-6
+12VDC

KEPCO JQE 15-6
-12VDC

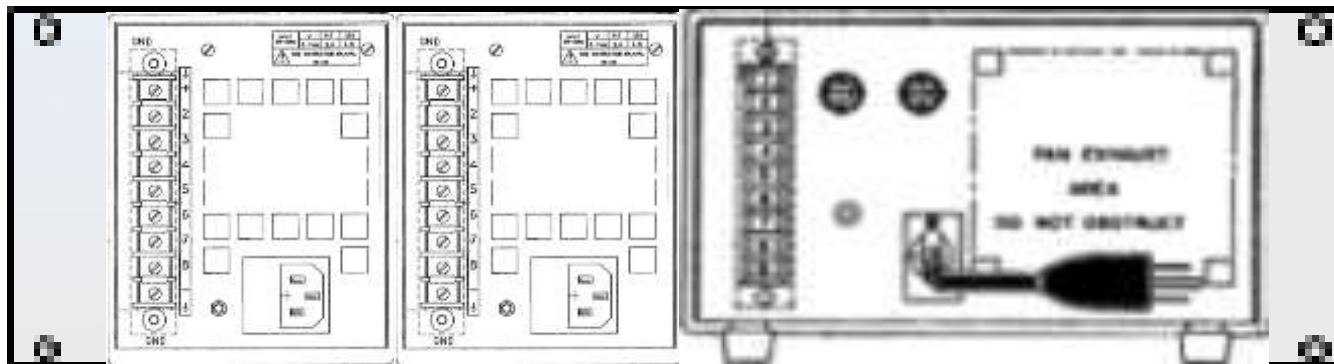

Rear

KEPCO JQE 15-6
H214524

KEPCO JQE 15-6
H214494

KEPCO JQE 25-10
H207953

APC SMT1500RM2U

UPS

APC SMT1500RM2U

A51051111991

110VAC

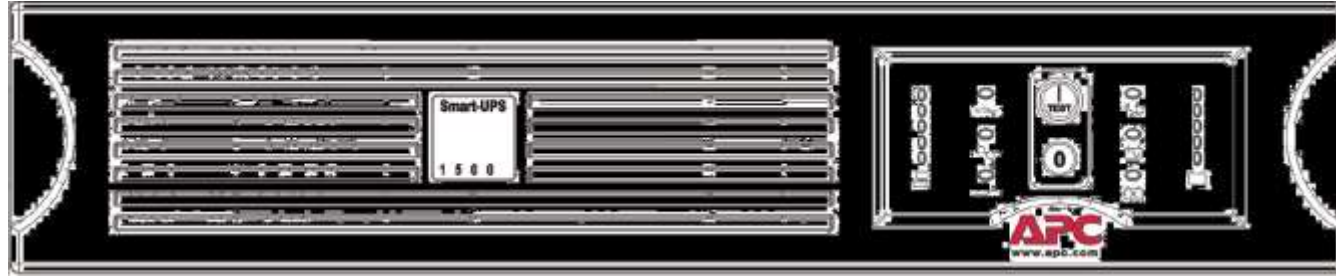

APC SMT1500RM2U

Front

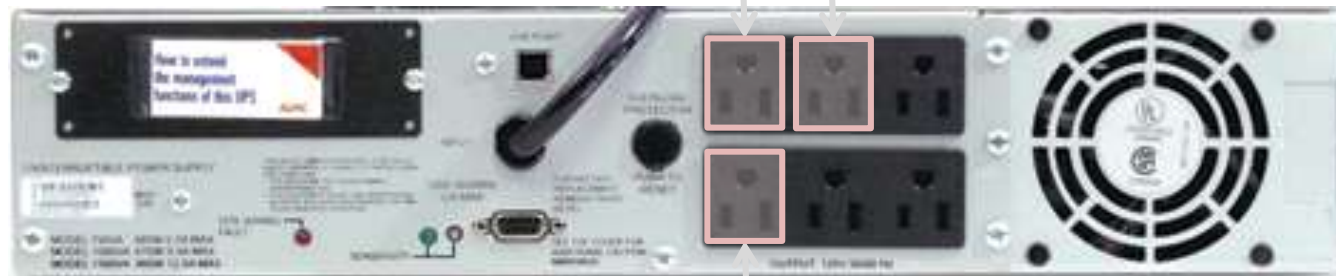

A51051111991

Rear

To 2402 PS1
To UPS Power Strip
To X44X 01

<< L1-FAC-XC1

Magnetometer: [Bartington Instruments](#)
MAG-03MC

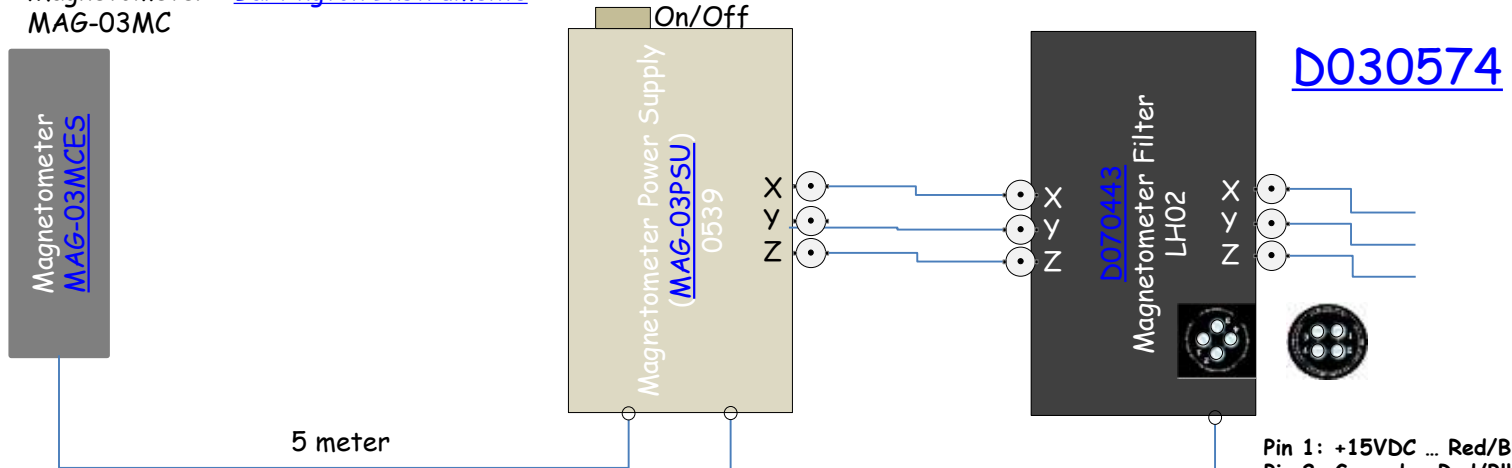

Black - G/W ... Ground
Stria - Y/W ... +12VDC

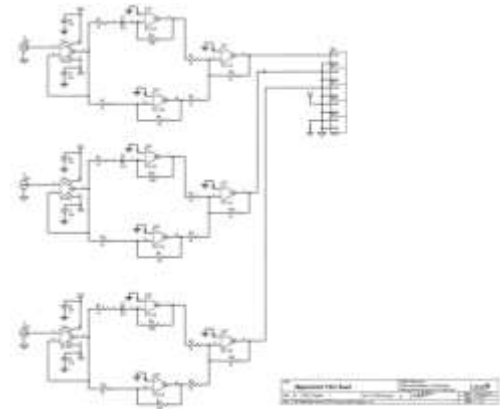
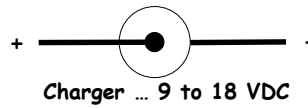

[<< L1-FAC-XC1](#)

Security Cameras

VT7430-2DRDT
Optical In/Out:
[To 1X23 PP B6](#)
Power: 12VDC
Output: Ch1,
Ch2, Ch3 BNCs
to Cameras

Powered from
Wall Wart from
Isolated Power

Video Master
Power Supply
Model
RT24/16500
Outputs to
Cameras 1,2,3

Note: 6 LEDs
are on.

AC Powered
from Isolated
Power

<< [CERX Racks](#)
 << [XEND Racks and Tables](#)

L1-ISC-XC1 XEND Remote Rack Layout ([D1201084](#)) ([S1202948](#))

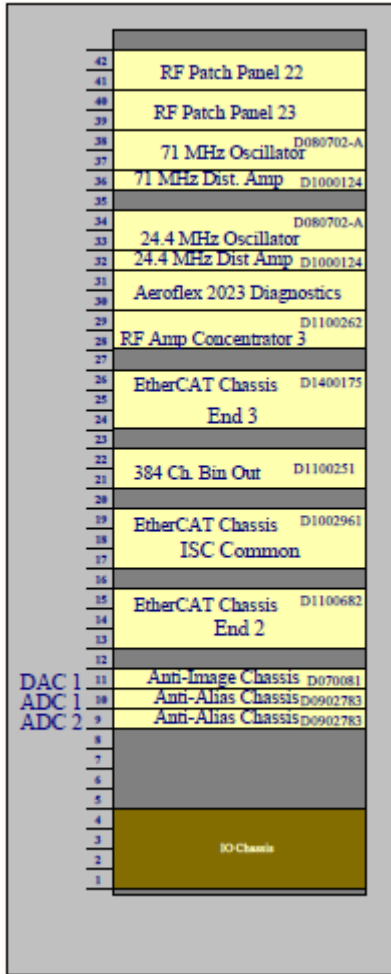

[RF Distribution Panel 22](#)
[RF Distribution Panel 23](#)
[71 MHz Oscillator](#)
[71 MHz Distribution Amplifier](#)
[24.4 MHz Oscillator](#)
[24.4 MHz Distribution Amplifier](#)
[RF Amplifier Concentrator 3](#)
[384 Channel Binary Output](#)
[Beckhoff Slow Controls](#)
[ISC Common](#)
Perforated Shelf
[Beckhoff Slow Controls](#)
[End Station 2](#)
Perforated Shelf
[Anti-Alias Chassis \(8*DB9\)](#)
[Anti-Alias Chassis \(8*DB9\)](#)
[Anti-Image Chassis \(4*DB9\)](#)
[liscex I/O Extension Chassis](#)

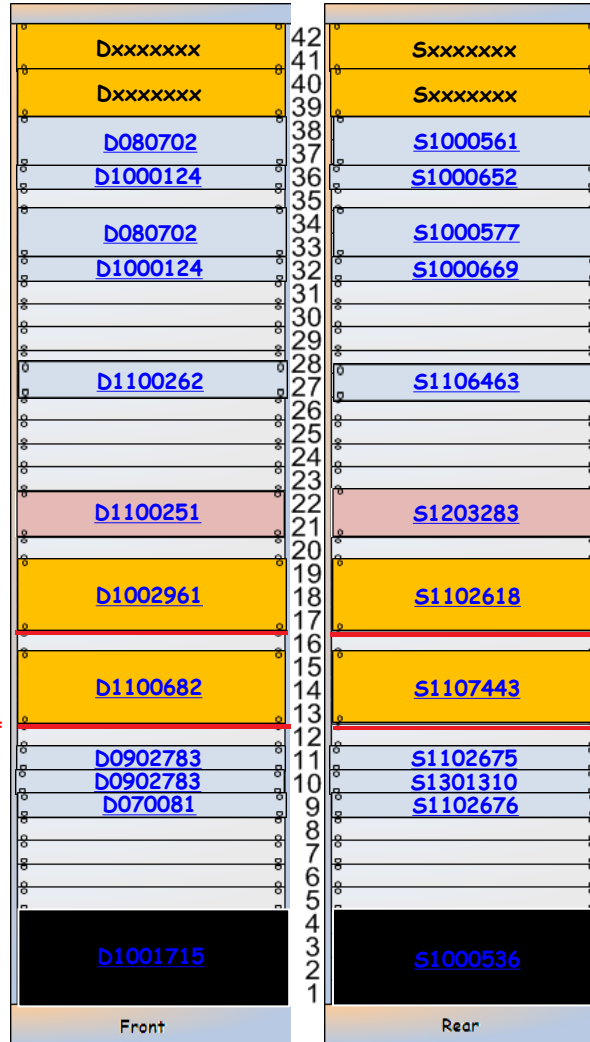

No Power
 No Power
 +12VDC, ±24VDC
 ±17VDC, ±24VDC
 +12VDC, ±24VDC
 ±17VDC, ±24VDC
 ±18VDC
 +24VDC
 +24VDC
 +24VDC
 ±18VDC
 ±18VDC
 ±18VDC

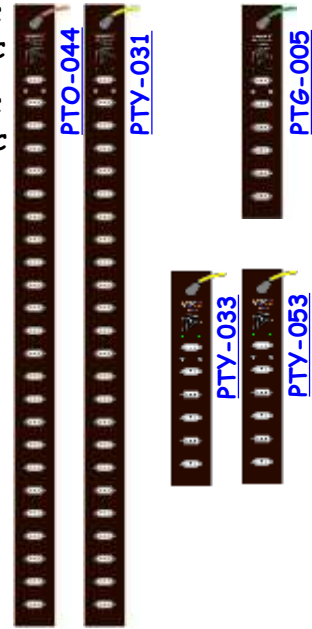

ISC-XC1 is part of [D1001459](#)

L1-ISC-XC1 Details

ISC-XC1 is part of [D1001459](#)

RF Distribution Panel 22

<< L1-ISC-XC1

RF Distribution Panel 22

Dxxxxxxx

Sxxxxxxx

No Power

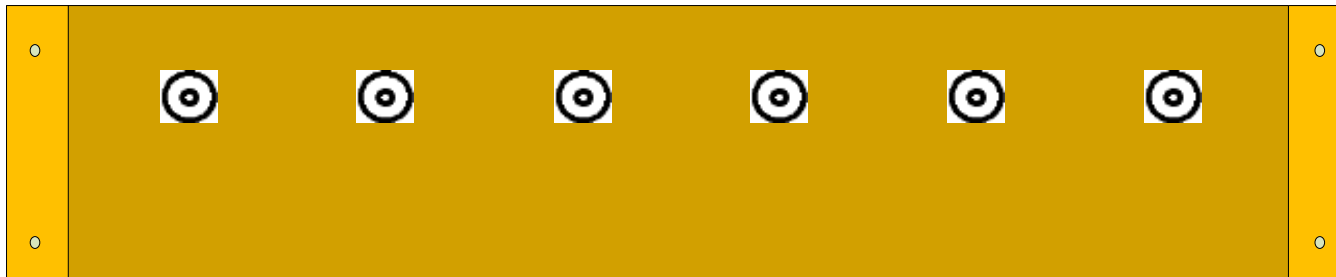

Dxxxxxxx

Front

ALS Laser VCO

ALS Modulation

Return PCL
Beat Note

SPARE

ALS Demod

Return ALS
Laser VCO

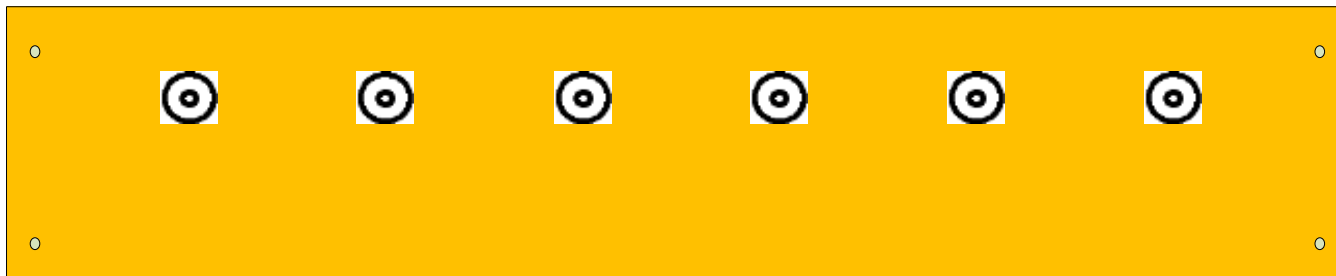

Sxxxxxxx

Rear

<< L1-ISC-XC1

RF Distribution Panel 23

Dxxxxxxx

Sxxxxxxx

No Power

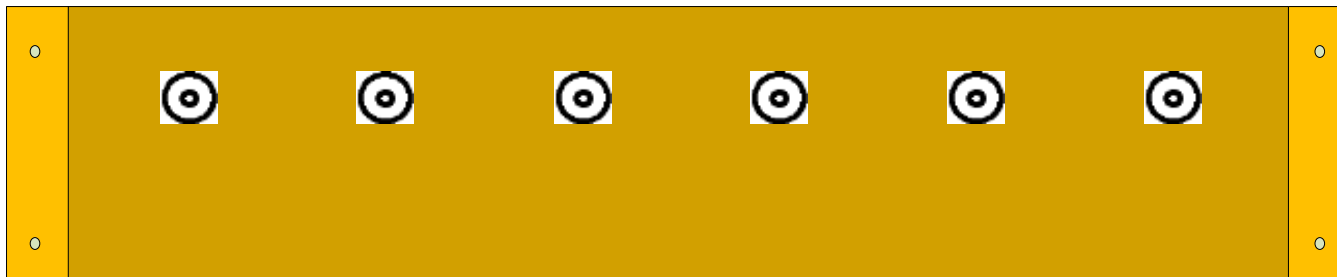

Dxxxxxxx

Front



SPARE

SPARE

OPEN

OPEN

OPEN

OPEN

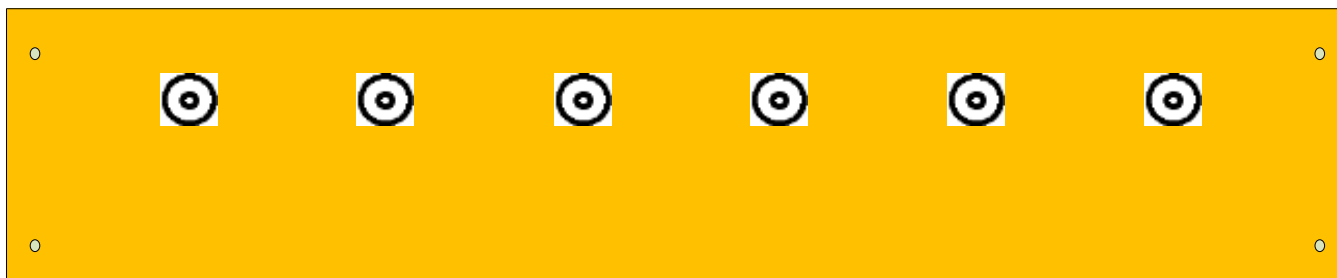

Sxxxxxxx

Rear

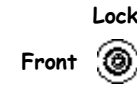
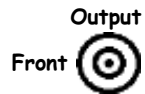
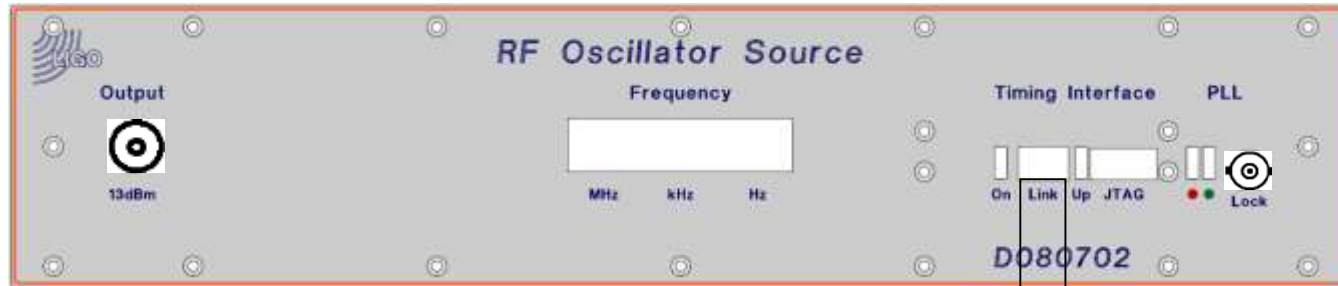

To ...

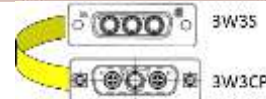

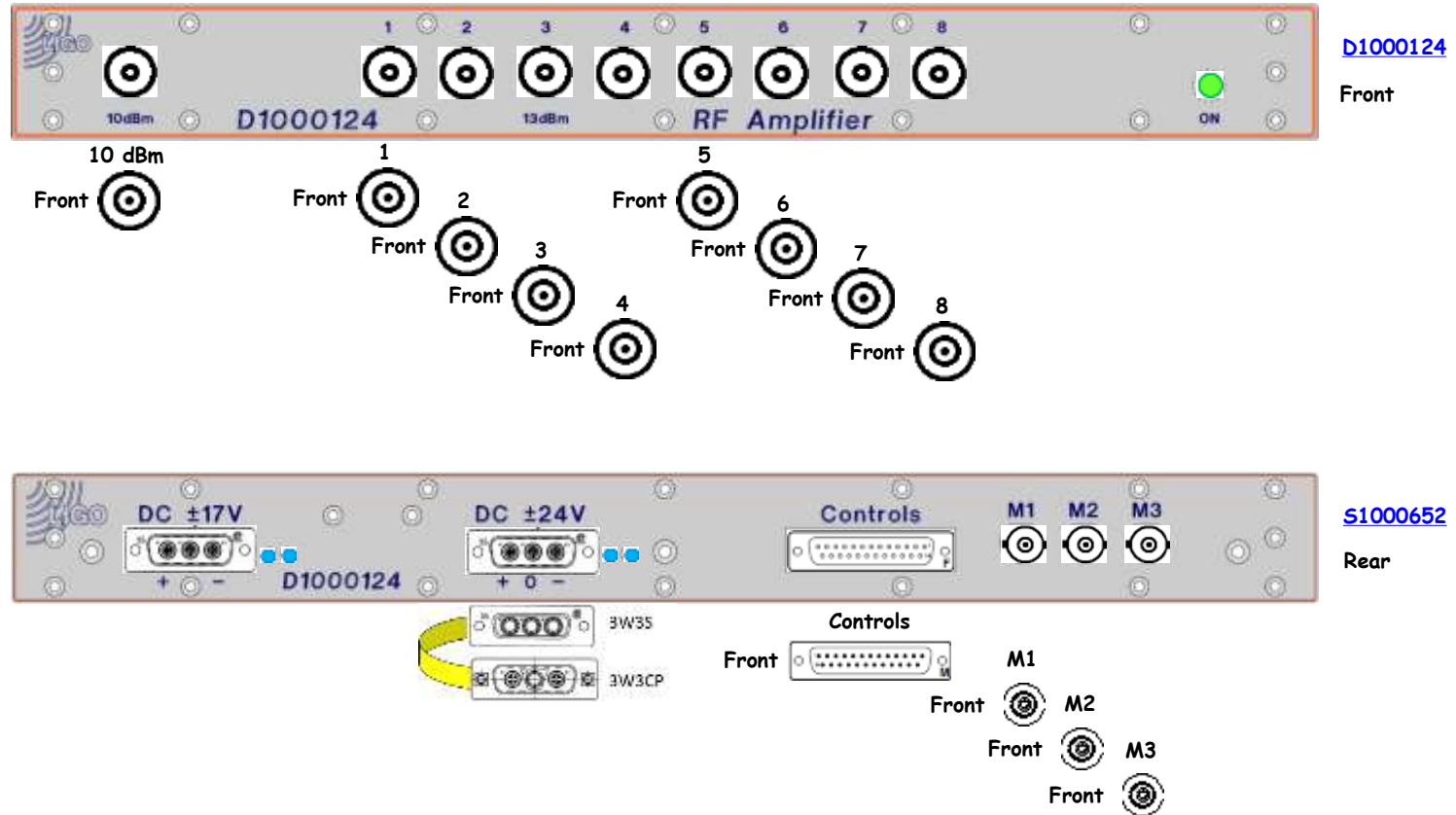

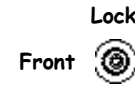
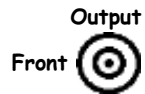
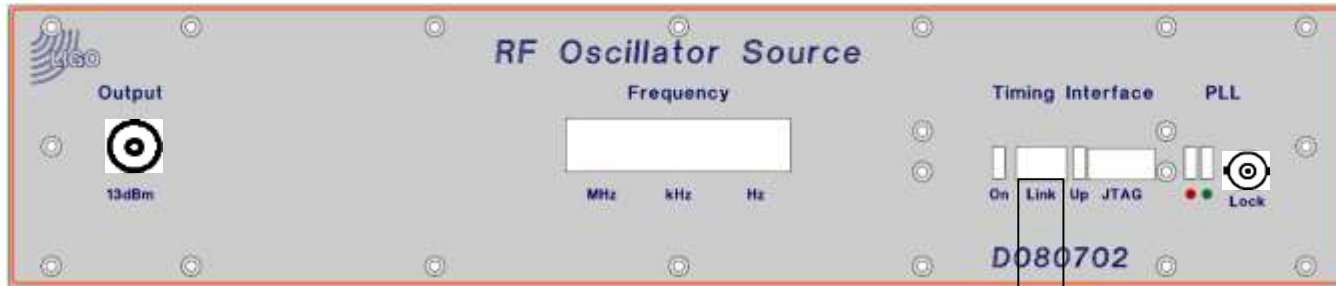

To ...

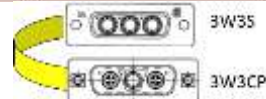

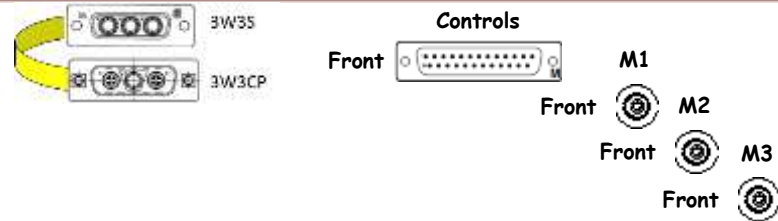
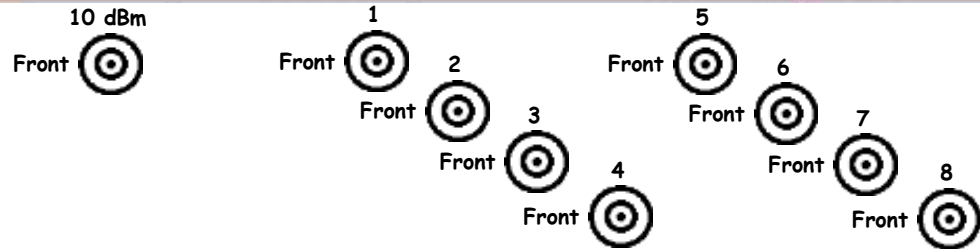
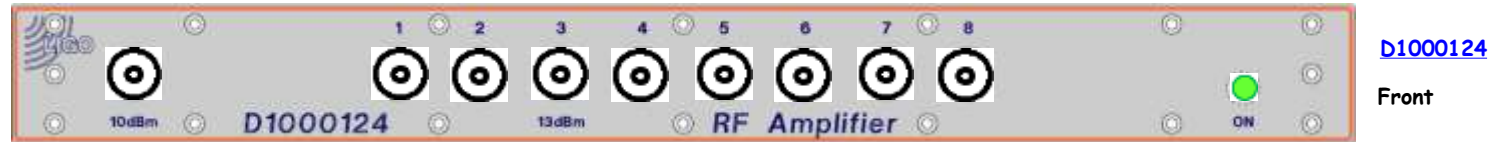



D1100262

Front

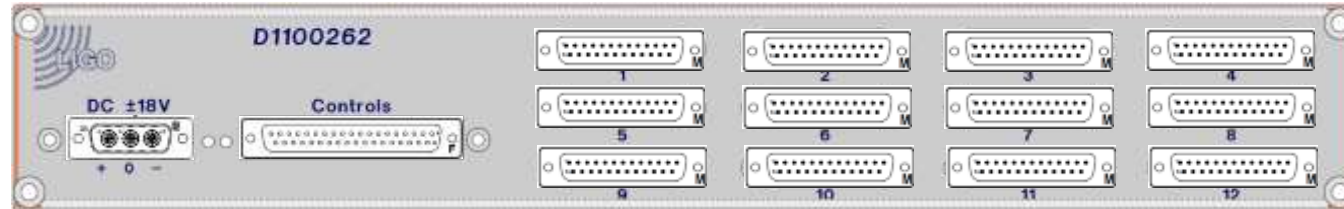

S1106463

Rear

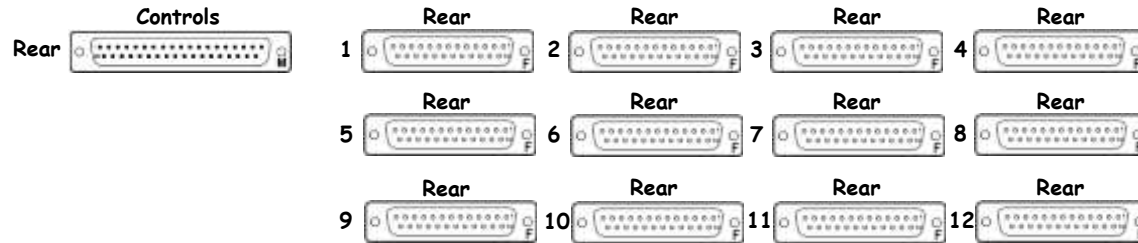

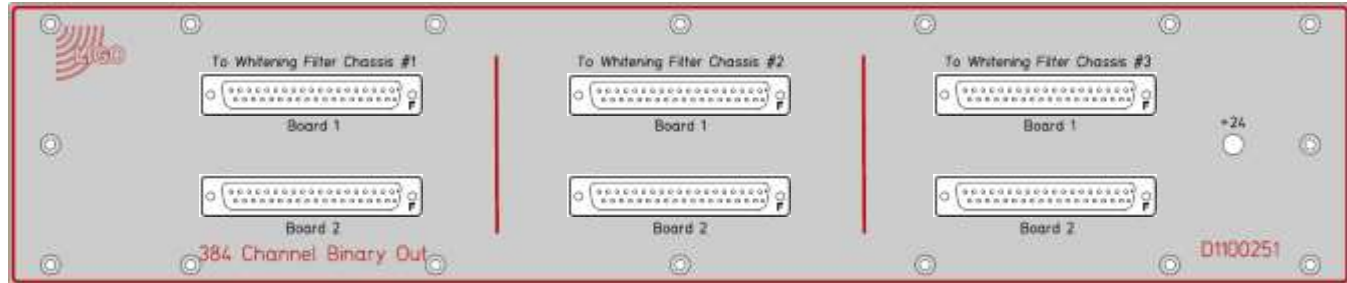

D1100251

Front

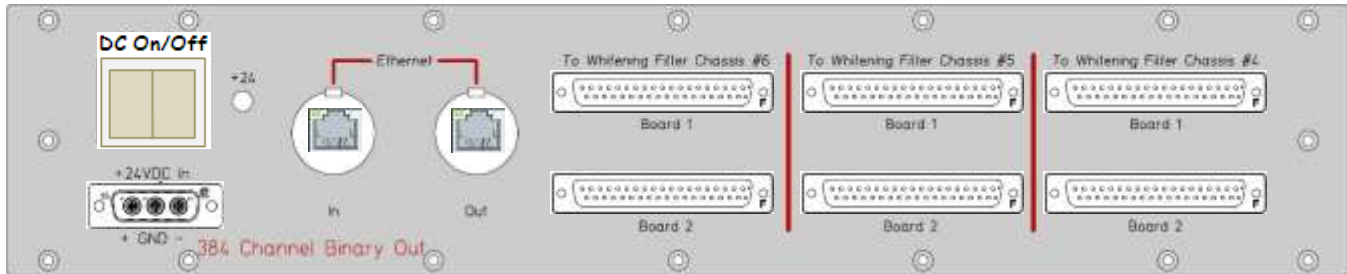
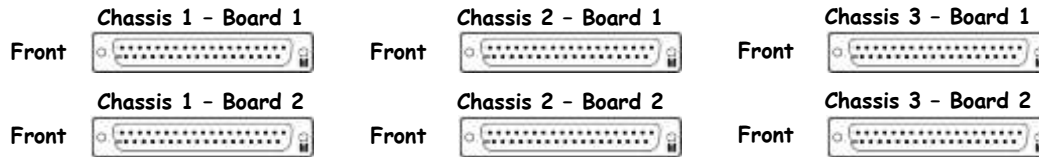

S1203283

Rear

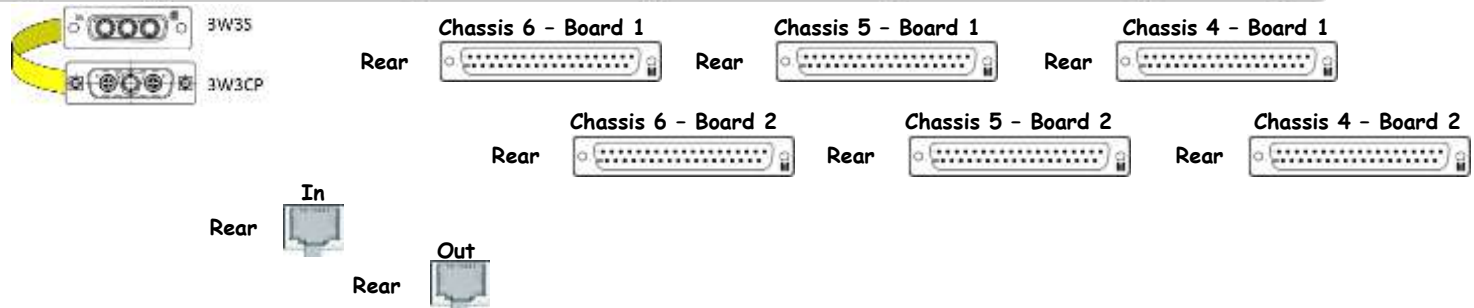

<< L1-ISC-XC1

Beckhoff Slow Controls
ISC Common

D1002961

S1102618

+24VDC

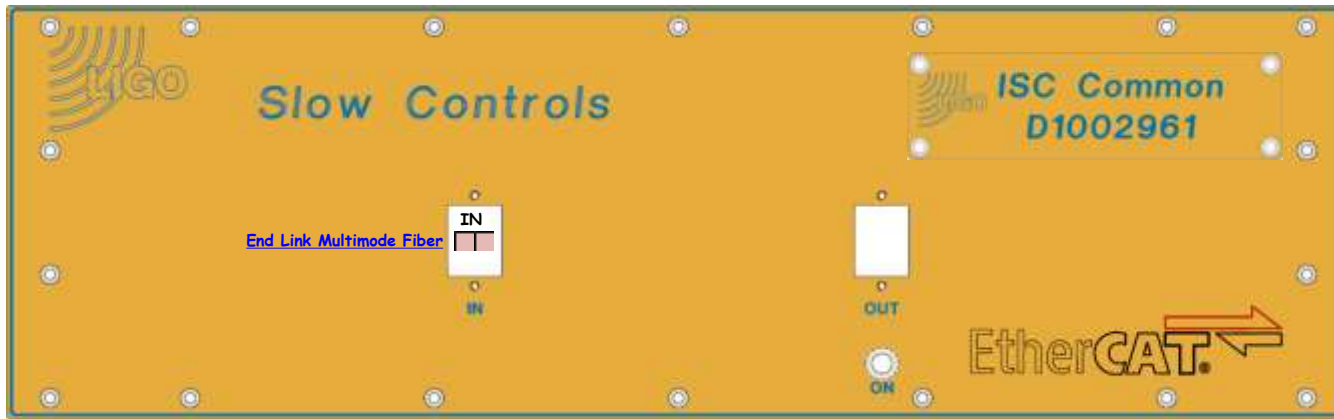

D1002961

Front: D0902553

Name: D1002962

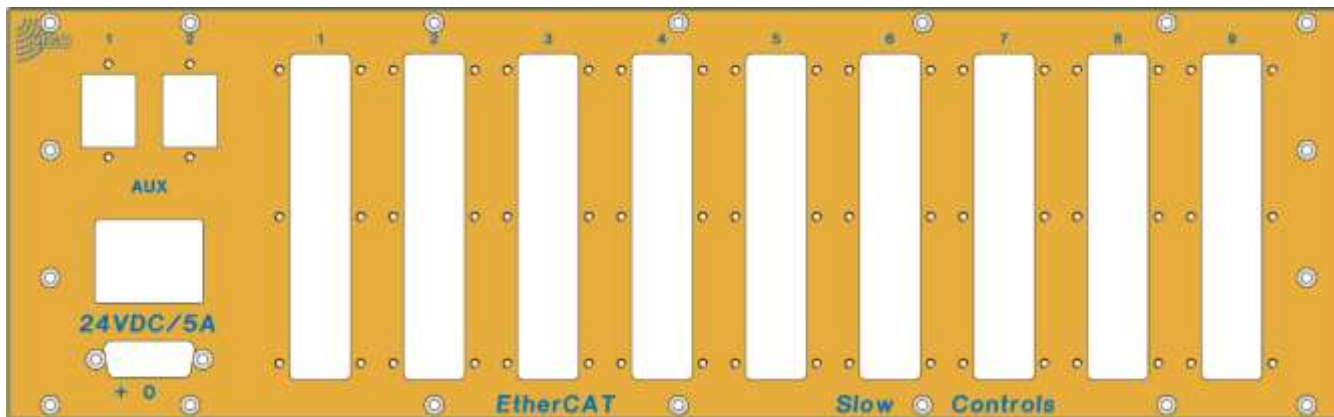

S1102618

Rear: D0902554

<< L1-ISC-XC1

Beckhoff Slow Controls
End Station 2

D1100682

S1107443

+24VDC

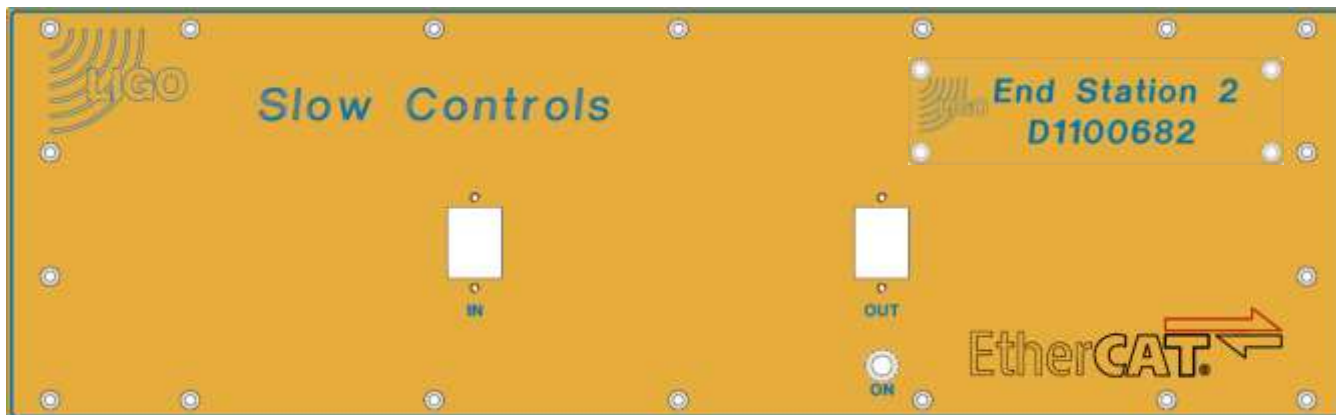

D1100682

Front: D0902553

Name: D1101978

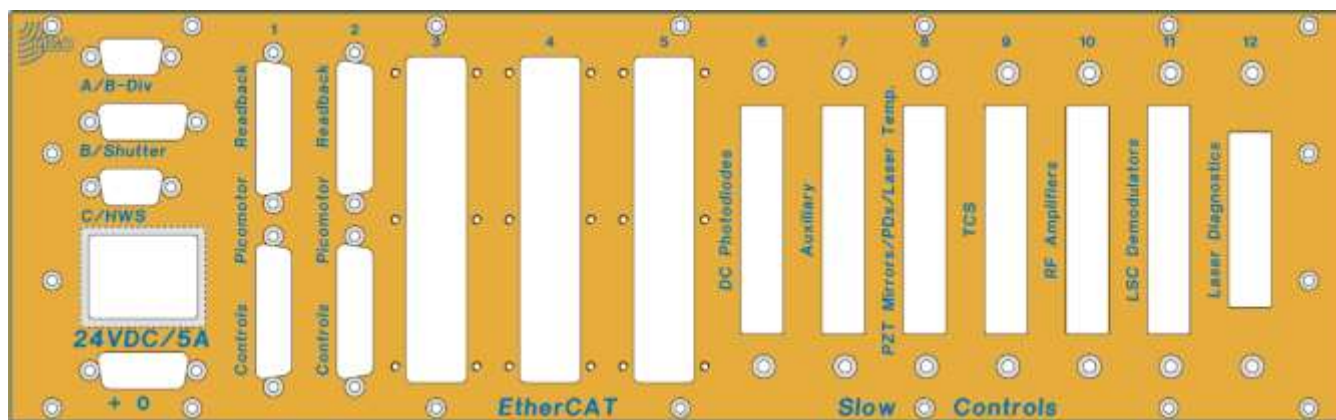

S1107443

Rear: D1101977

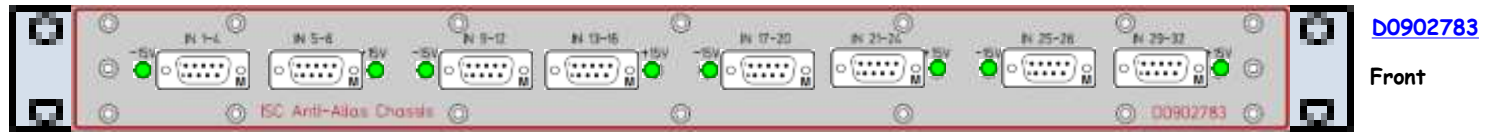

D0902783

Front

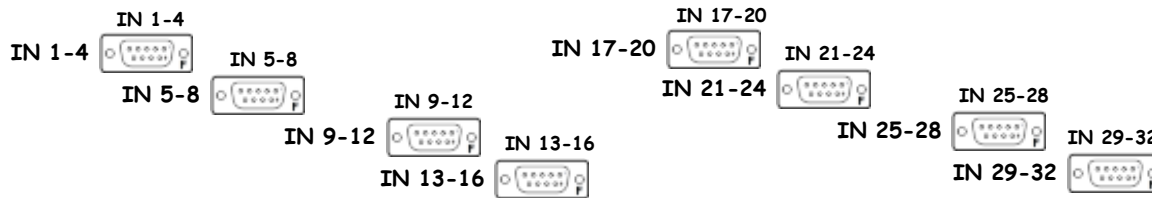

S1102675

Rear



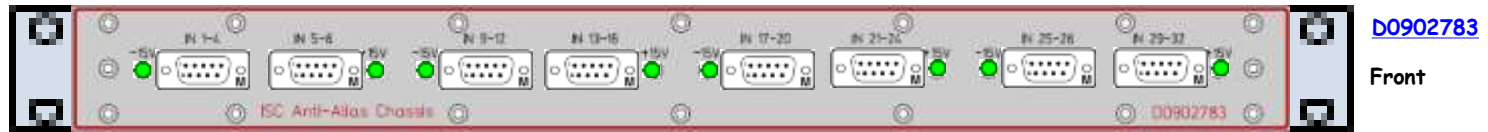

D0902783

Front

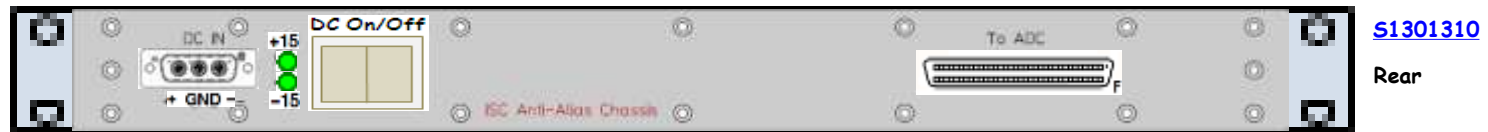
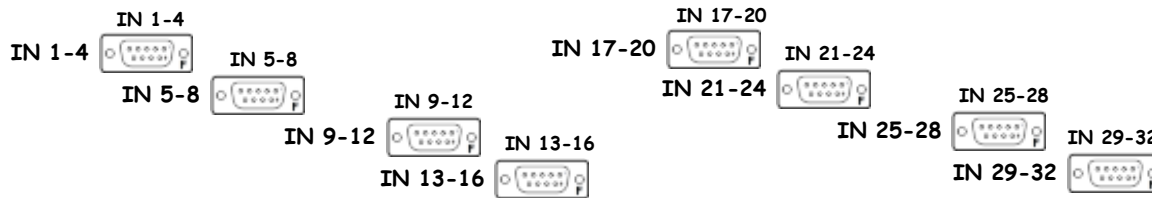

S1301310

Rear



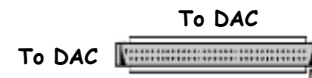
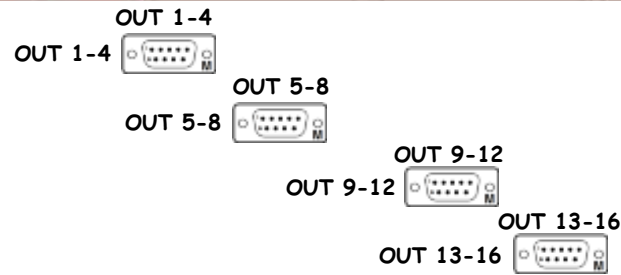
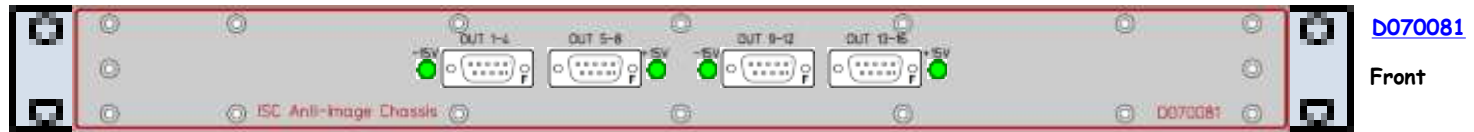



D1001715

Front

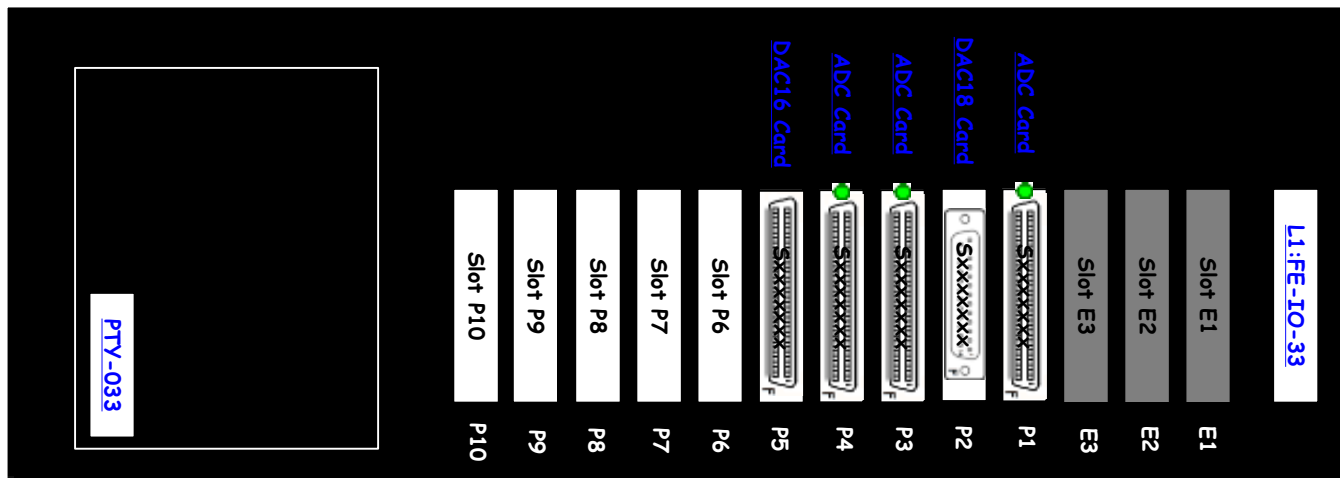

S1000536

Rear

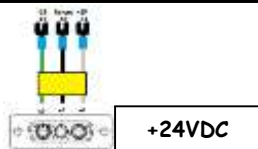
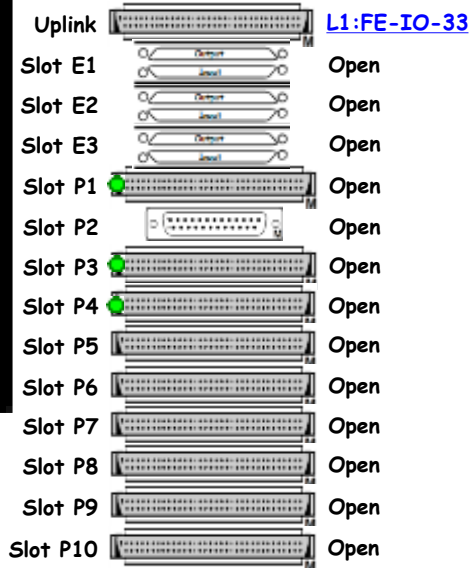

<< [CERX Racks](#)
 << [XEND Racks and Tables](#)

L1-SEI-XC1 (BSC4) XEND Remote Rack 1 Layout ([D1201081](#)) ([S1202945](#))

	42					
	41					
BSC4 ISI Interface Chassis Pod 1	D1002432	40	S1203884	S1203884	±18VDC	
BSC4 ISI Interface Chassis Pod 2	D1002432	39	S1203885	S1203885	±18VDC	
BSC4 ISI Interface Chassis Pod 3	D1002432	38	S1203886	S1203886	±18VDC	
	37					
	36					
BSC4 ISI AA Chassis	D1002693	35	S1203106	S1203106	Power	
BSC4 ISI AA Chassis	D1002693	34	S1203107	S1203107	Power	
	33					
BSC4 ISI AA Chassis	D1002693	32	S1203109	S1203109	Power	
	31					
BSC4 HEPI AA Chassis	D1000272	30	S1203333	S1203333	Power	
BSC4 HEPI AI Chassis	D1100202	29	S1200592	S1200592	Power	
	28					
BSC4 8 Channel Valve Driver	D0900117	27	S0900289	S0900289	Power	
	26					
64 Channel Binary Input Chassis (8*DB9)	D1001726	25	S1101306	S1101306	±18VDC	
64 Channel Binary Input Chassis (8*DB9)	D1001726	24	S1101307	S1101307	±18VDC	
64 Channel Binary Output Chassis (8*DB9)	D1001728	23	S1101333	S1101333	±18VDC	
	22					
Trillium 240 Interface Chassis Pod 1	D1002964	21	S1201405	S1201405	±18VDC	
Trillium 240 Interface Chassis Pod 2	D1002964	20	S1201406	S1201406	±18VDC	
Trillium 240 Interface Chassis Pod 3	D1002964	19	S1201407	S1201407	±18VDC	
	18					
	17					
STS-2 Interface Chassis	D080535	16	S0900105	S0900105	±18VDC	
	15					
	14					
l1seiex I/O Extension Chassis	D1001715	13	S1201774	S1201774	+24VDC	
	12					
	11					
	10					
Anti-Image Chassis (4*DB9)	D070081	9	S0900067	S0900067	±18VDC	
	8					
BSC4 ISI Coil Driver Pod 1	D0902744	7	S1103314	S1103314	±24VDC	
BSC4 ISI Coil Driver Pod 2	D0902744	6	S1103336	S1103336	±24VDC	
BSC4 ISI Coil Driver Pod 3	D0902744	5	S1103360	S1103360	±24VDC	
	4					
	3					
	2					
	1					
		Front		Rear		

SEI-XC1 is part of [D0901301](#)

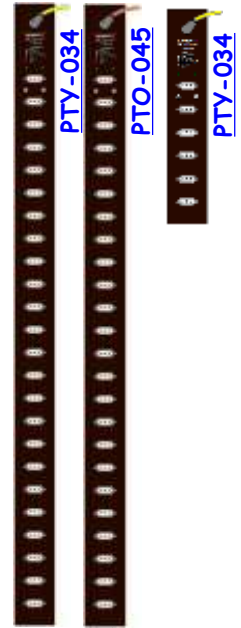

NOTE: One ±18VDC connector powers 4 HEPI Pods.

L1-SEI-XC1 Details

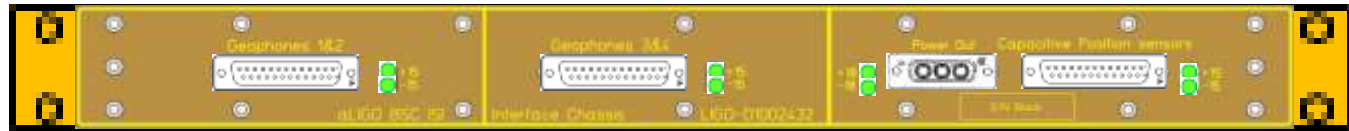

[D1002432](#)

Front

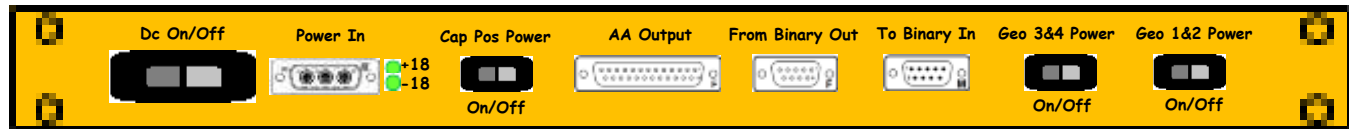

[S1203884](#)

Rear

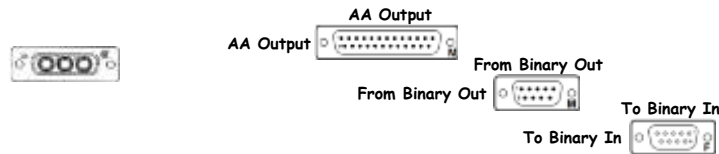

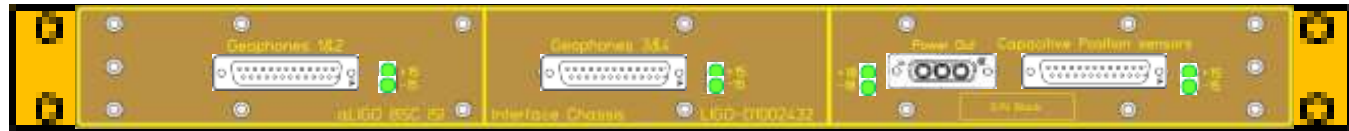

[D1002432](#)

Front

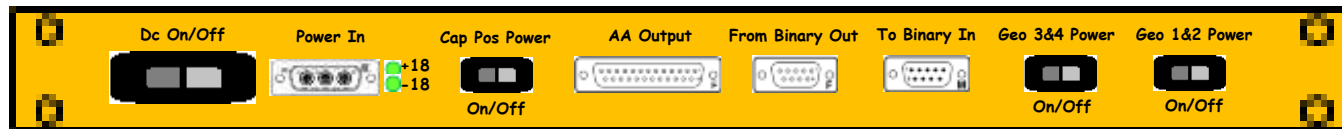

[S1203885](#)

Rear

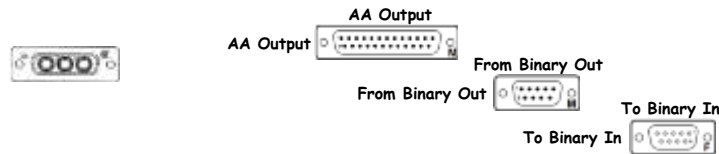

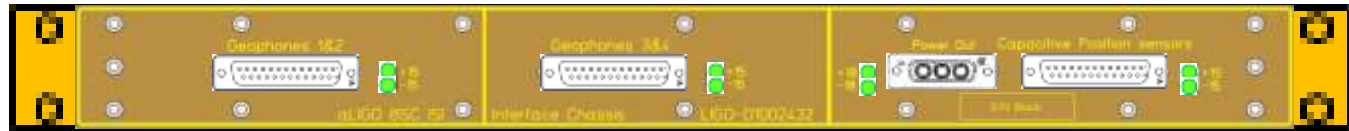

[D1002432](#)

Front

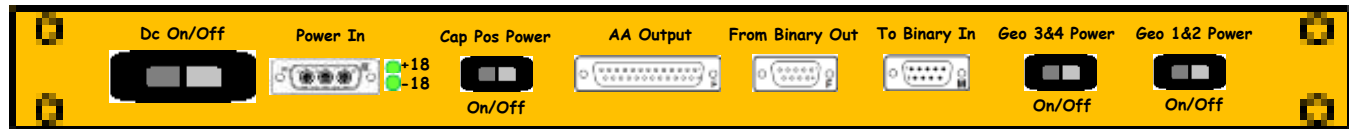

[S1203886](#)

Rear

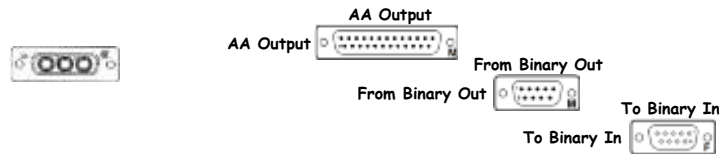

D1002693 - S1203106

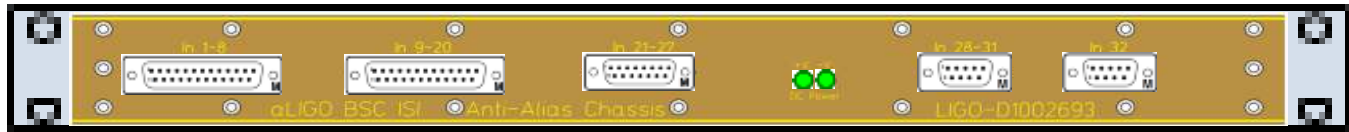

D1002693

Front

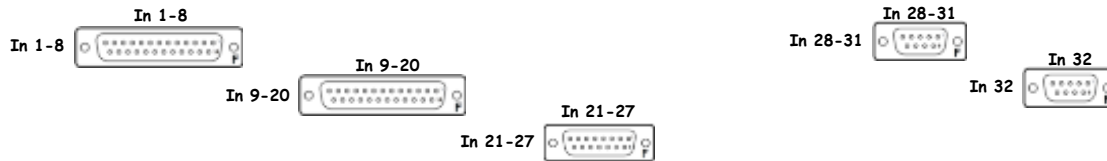

S1203106

Rear

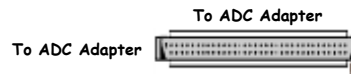

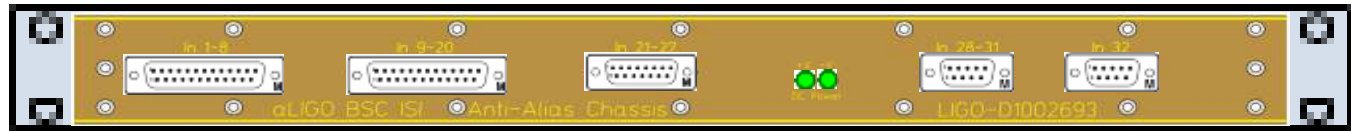

D1002693

Front

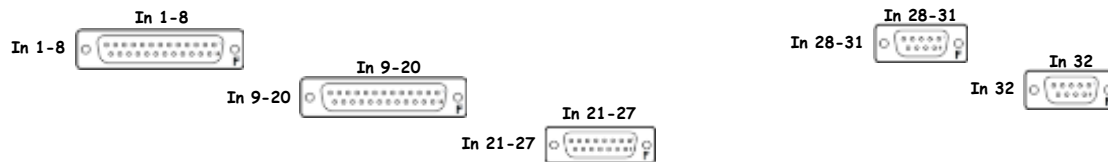

S1203107

Rear



D1002693 - S1203109



<< L1-SEI-XC1

BSC4 ISI AA Chassis Pod 3 D1002693 S1203109 Power

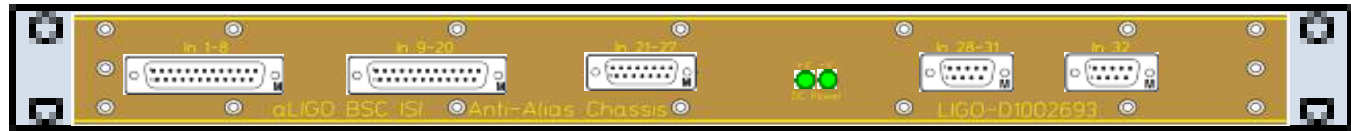

D1002693

Front

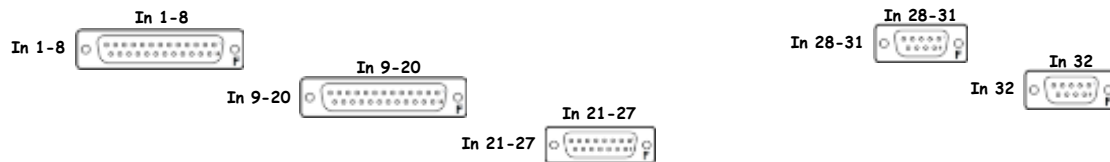

S1203109

Rear





D1000272

Front

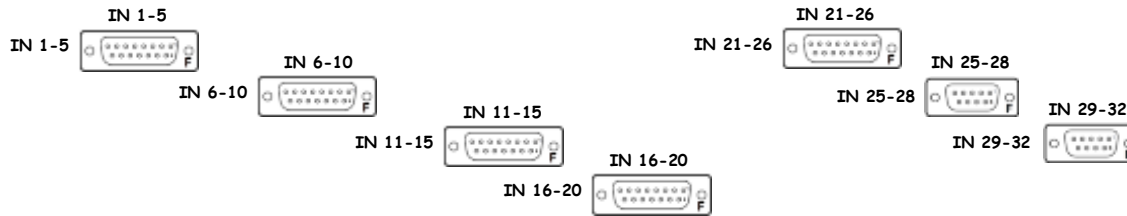

S1203333

Rear

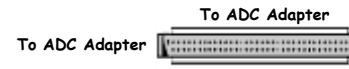

D1100202 - S1200592



<< L1-SEI-XC1

BSC4 HEPI AI Chassis D1100202 S1200592 Power

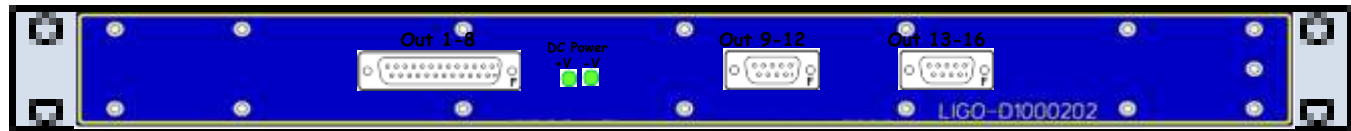

D1100202

Front



S1200592

Rear

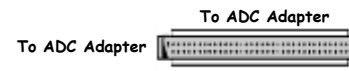



D0900117

Front

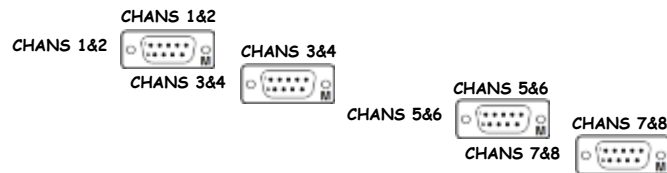

S0900289

Rear



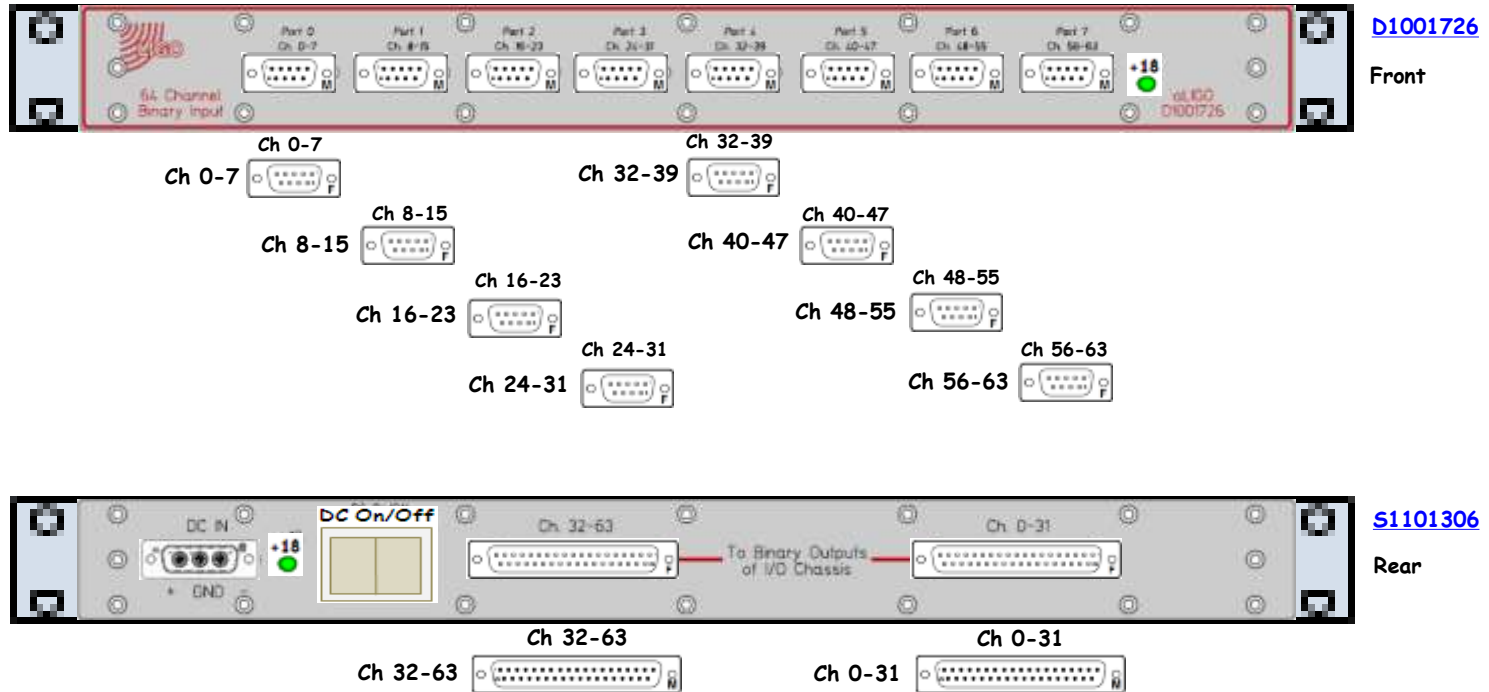

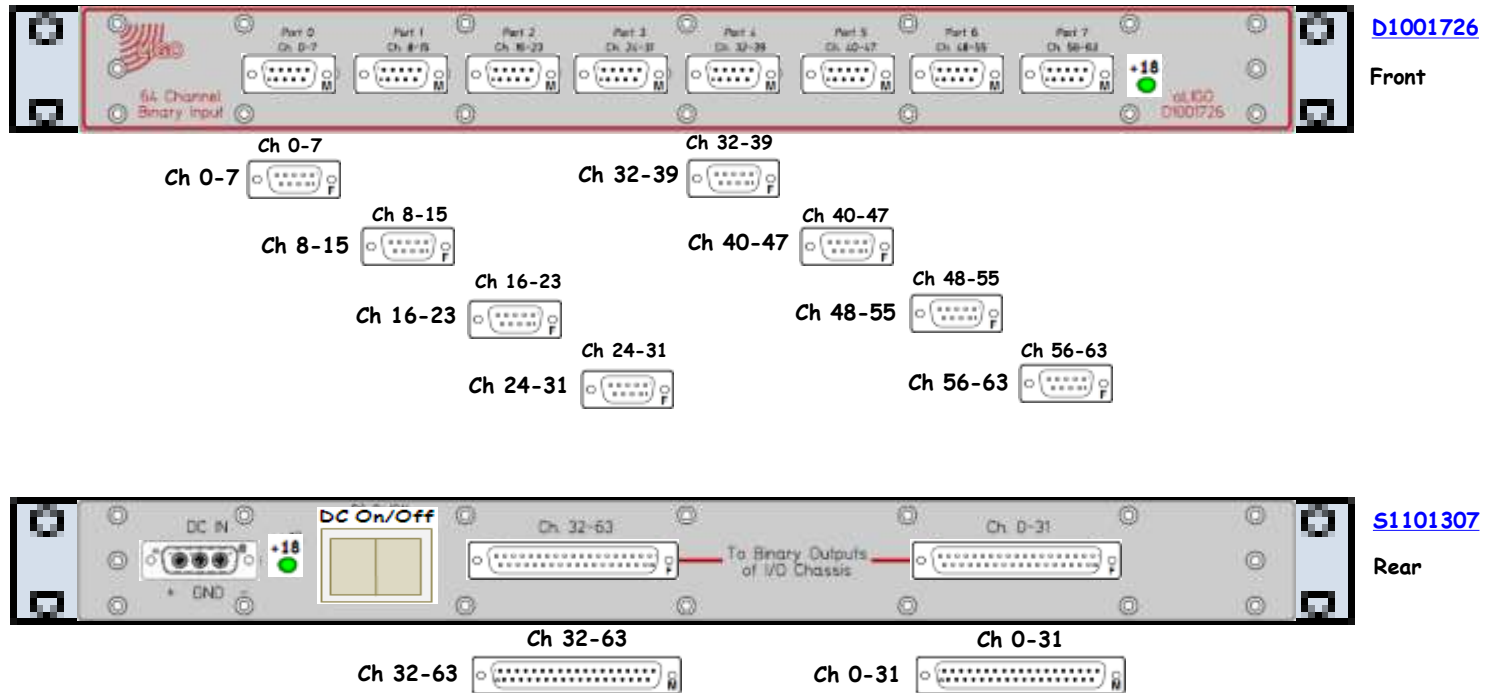

D1001726

Front

S1101307

Rear

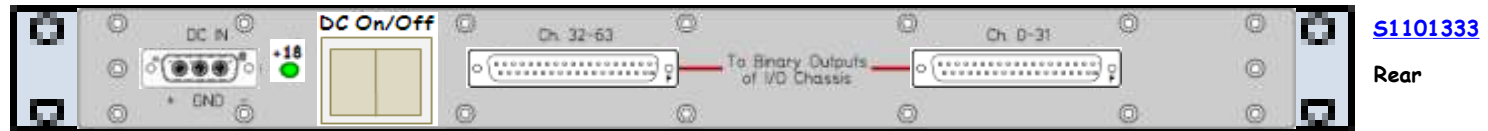
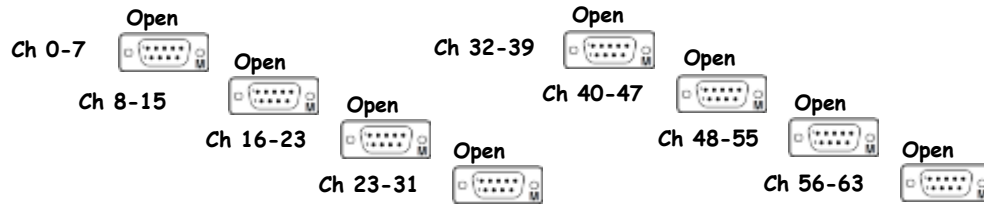
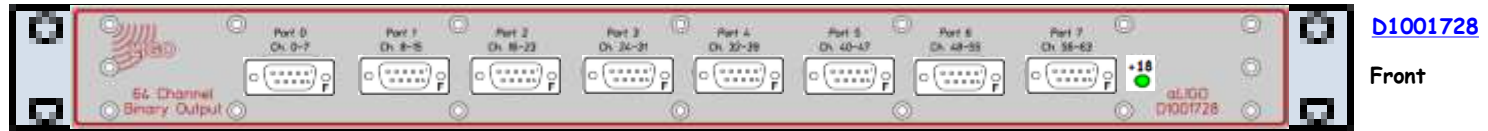

Trillium 240 Interface Chassis Pod 1 D1002964 S1201405 ±18VDC



D1002964

Front

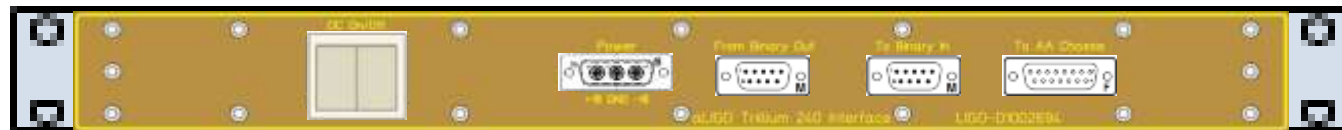
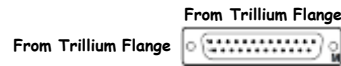

S1201405

Rear

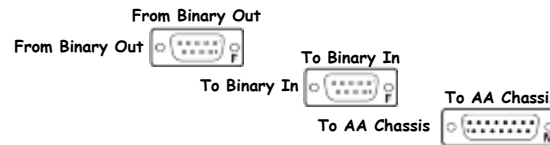

Trillium 240 Interface Chassis Pod 2 D1002964 S1201406 ±18VDC



D1002694

Front

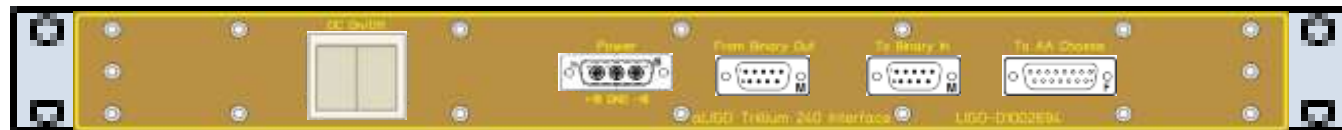
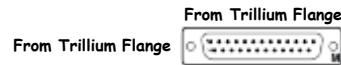

S1201406

Rear

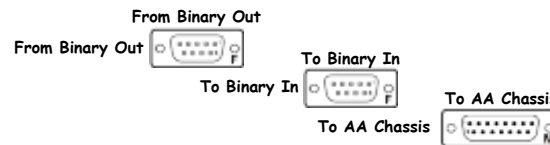

Trillium 240 Interface Chassis Pod 3 D1002964 S1201407 ±18VDC



[D1002694](#)

Front

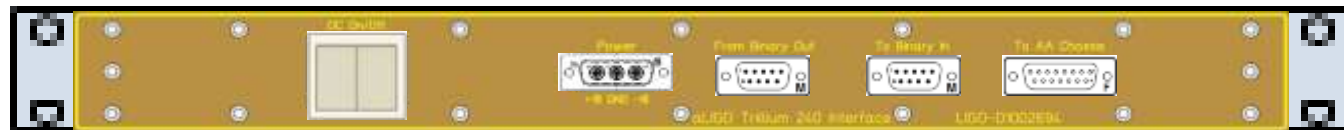
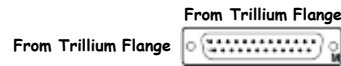

[S1201407](#)

Rear

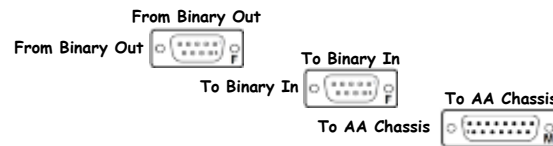

<< L1-SEI-XC1

STS-2 Interface Chassis

D080535

S0900105

±18VDC

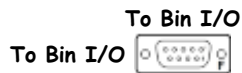
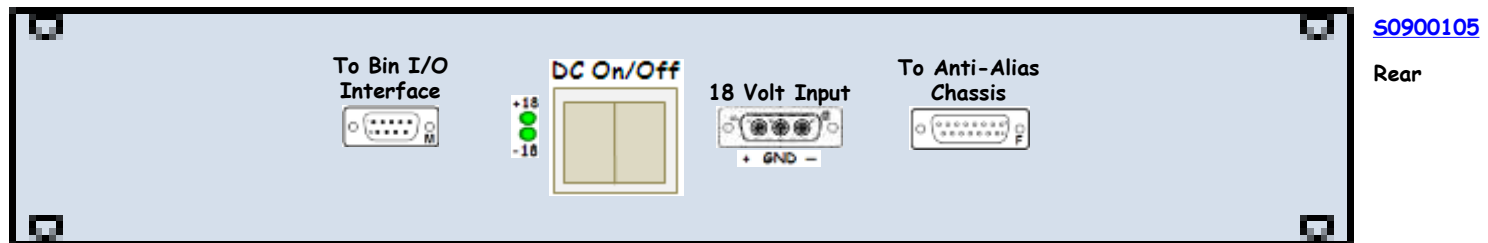
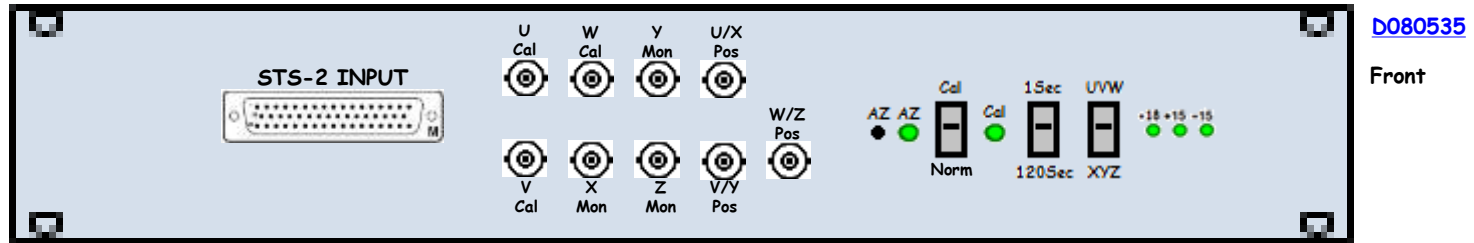

<< L1-SEI-XC1

I1seiex I/O Extension Chassis

D1001715

S1201774

+24VDC

D1001715

Front











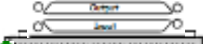

L1SEIEX

I1seiex – I/O Extender

S1201774

Rear

Uplink  L1:FE-IO-30

- Slot E1  Open
- Slot E2  Open
- Slot E3  Open
- Slot P1  Open
- Slot P2  Open
- Slot P3  Open
- Slot P4  Open
- Slot P5  Open
- Slot P6  Open
- Slot P7  Open
- Slot P8  Open
- Slot P9  Open
- Slot P10  Open

L1:FE-IO-30

Binary IO Card

Binary IO Card

ADC Card

ADC Card

ADC Card

ADC Card

ADC Card

DA16 Card

DA16 Card

Slot P10

Slot P9

Slot P10

PTY-034

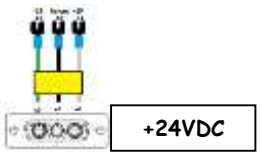

+24VDC

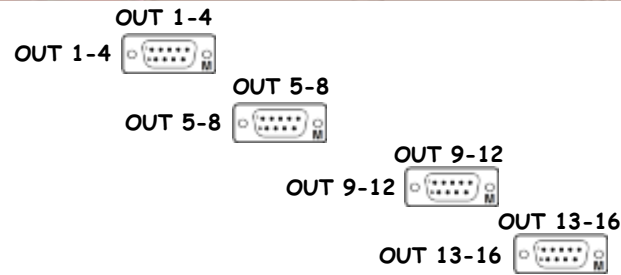
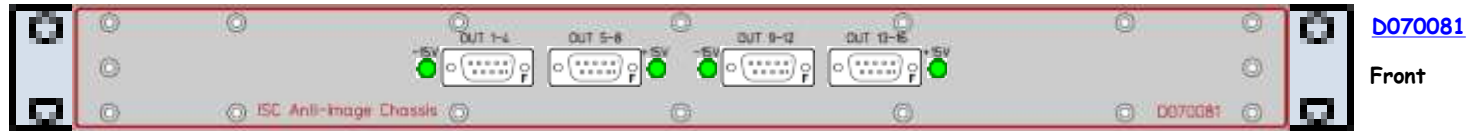



D0902744

Front

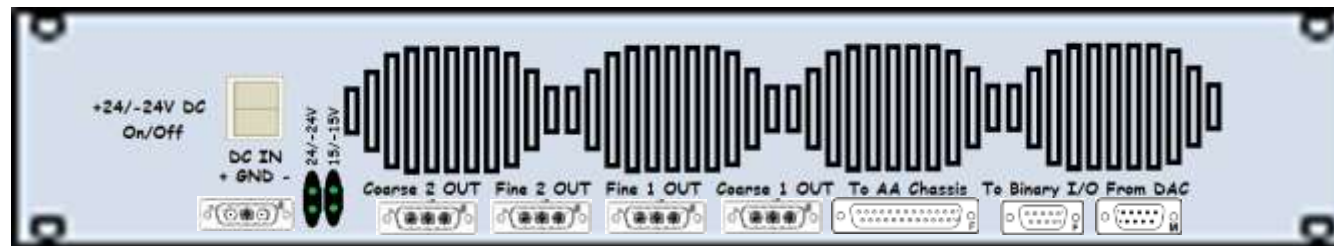

S1103314

Rear

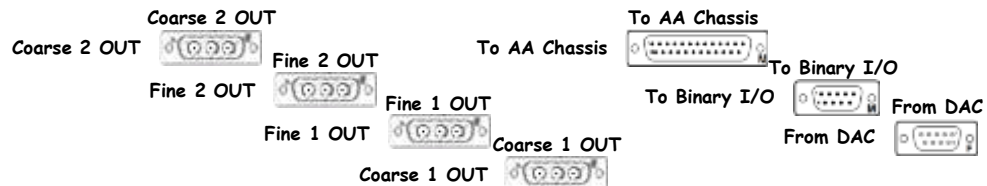



D0902744

Front

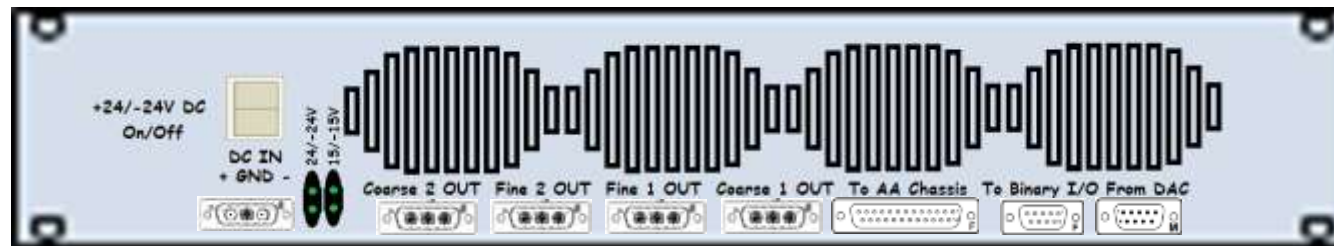

S1103336

Rear

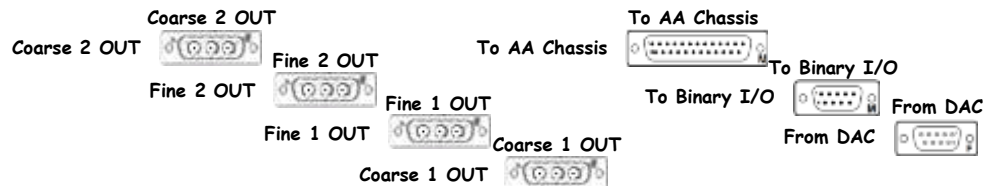



D0902744

Front

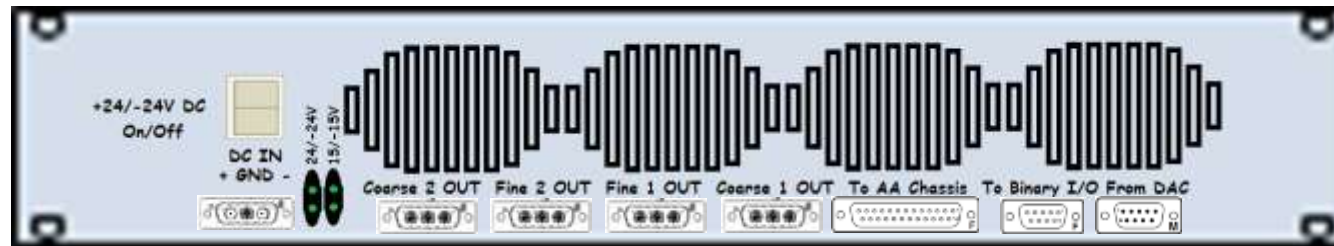

S1103360

Rear

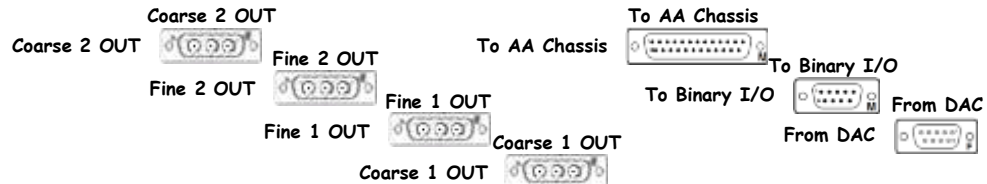

<< [CERX Racks](#)
 << [XEND Racks and Tables](#)

L1-SUS-XC1 (ETM) XEND Remote Rack 1 (of 2) Layout ([D1201082](#)) ([S1202946](#))

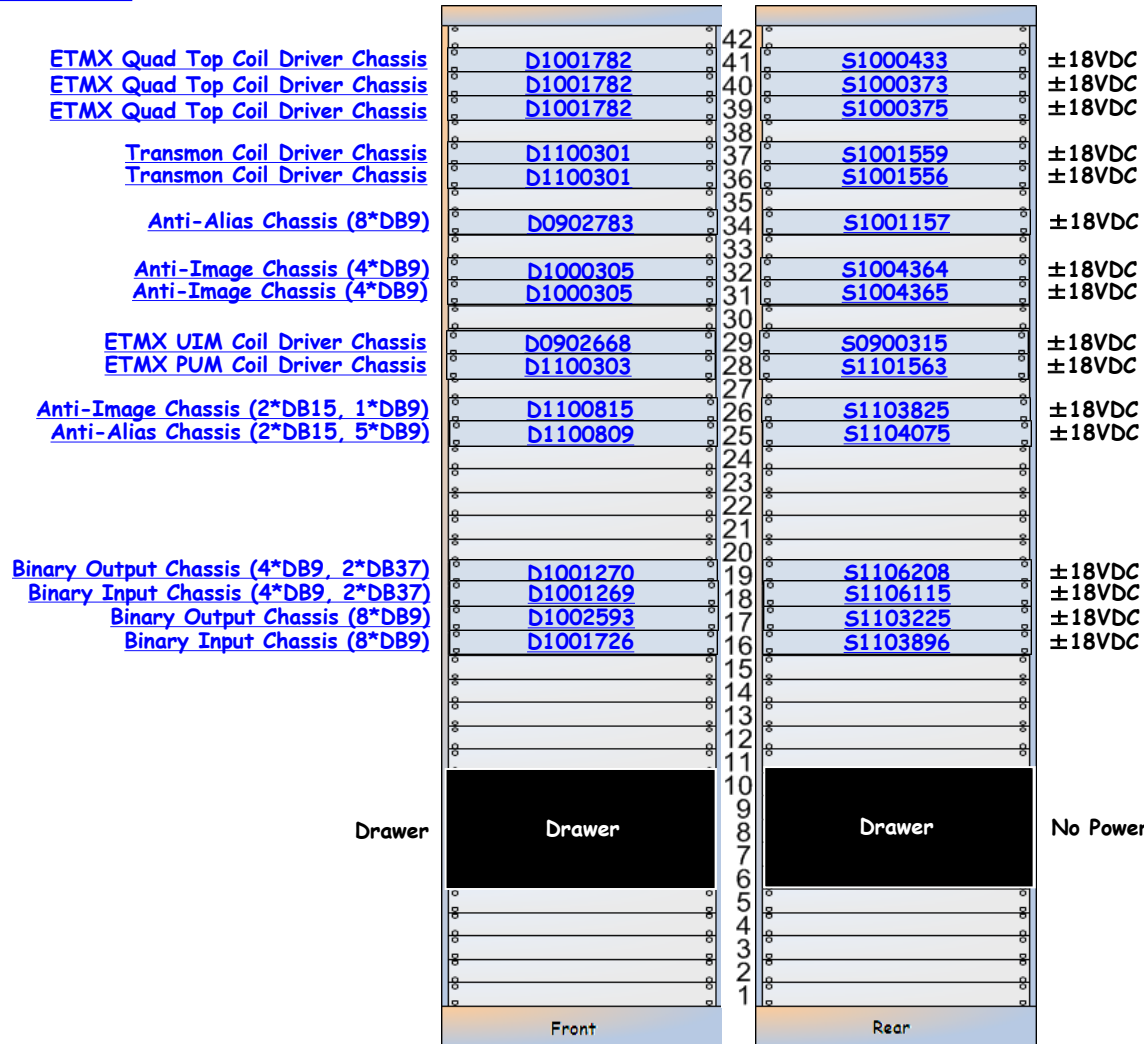

SUS-XC1 is part of [D1002741](#).

L1-SUS-XC1 Details

SUS-XC1 is part of [D1002741](#).

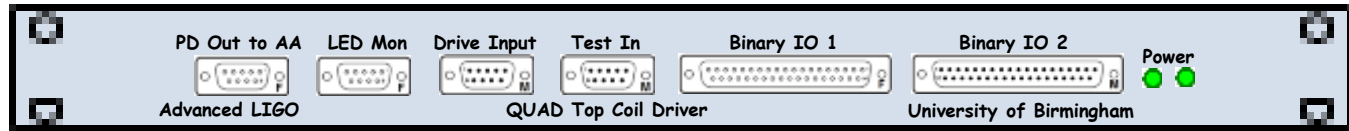

D1001782

Front

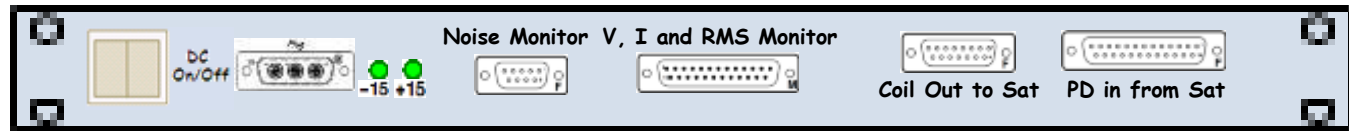
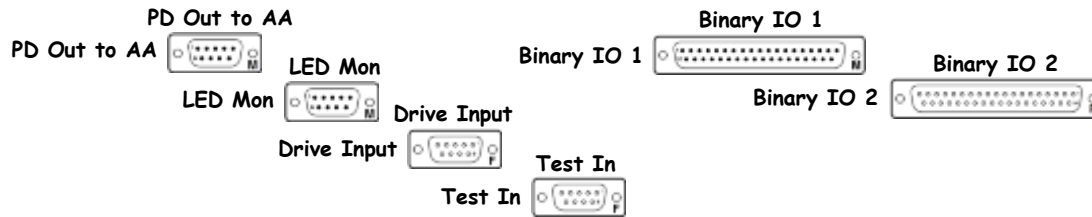

S1000433

Rear

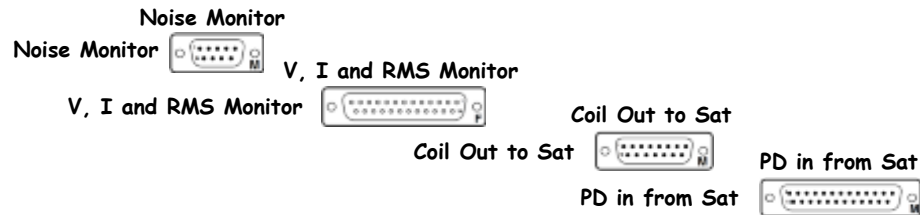

[Driver Board: D0902747](#)

[Monitor Board: D070480](#)

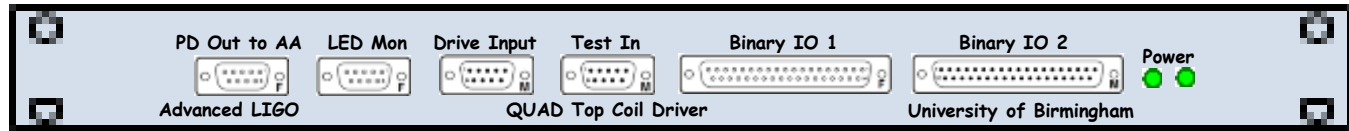

[D1001782](#)

Front

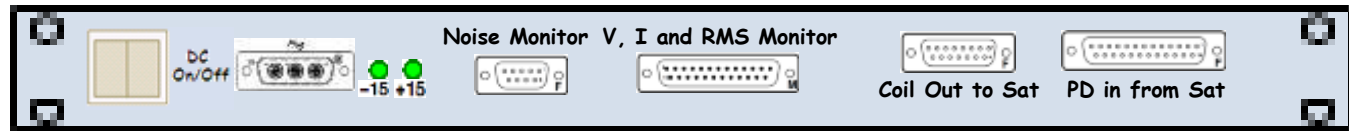
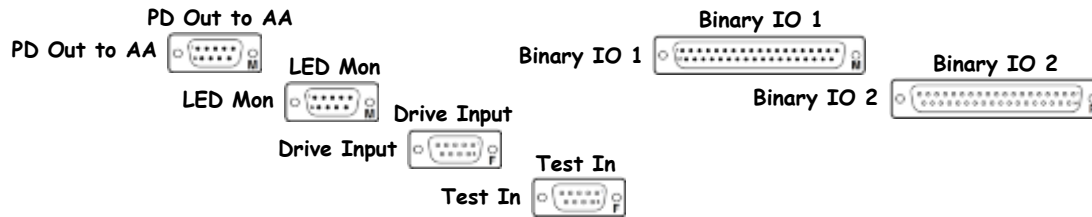

[S1000373](#)

Rear

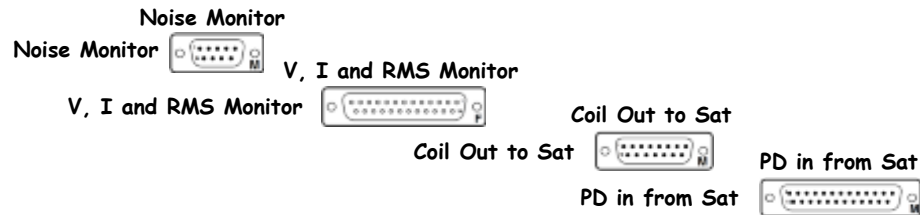

[Driver Board: D0902747](#)

[Monitor Board: D070480](#)

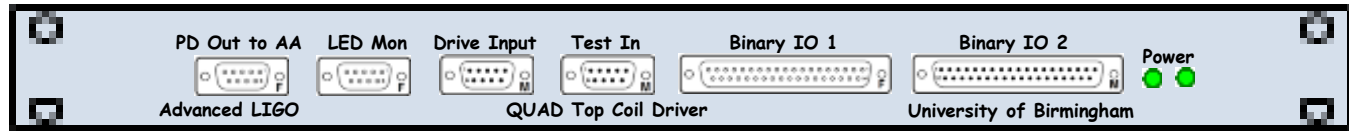

D1001782

Front

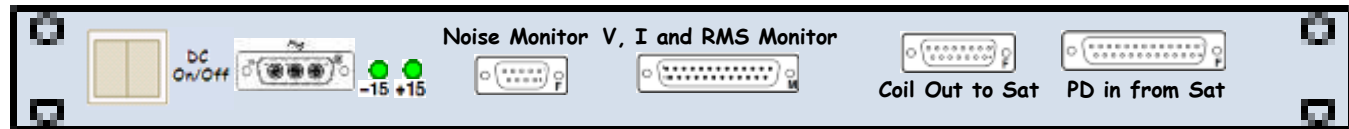
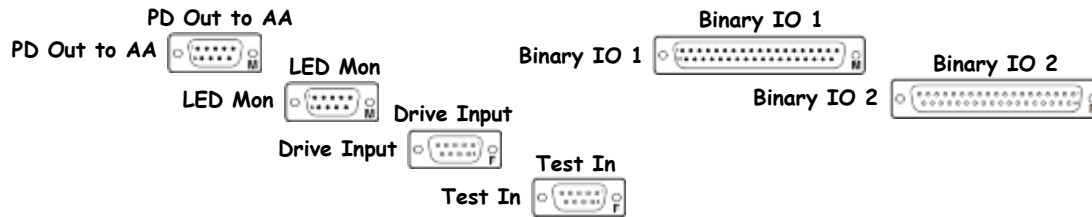

S1000375

Rear

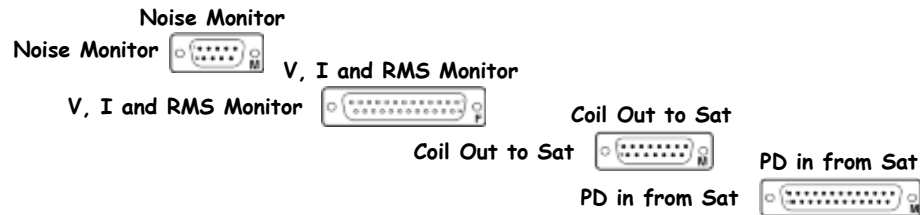

[Driver Board: D0902747](#)

[Monitor Board: D070480](#)



[D070481](#)
[D070480](#)
Front

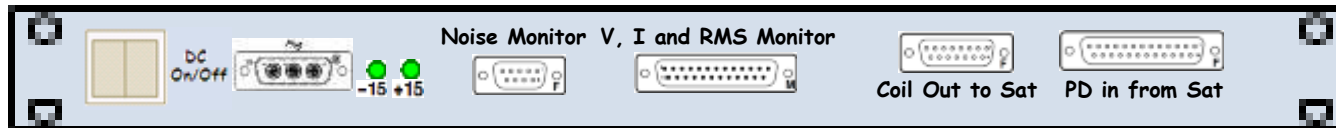
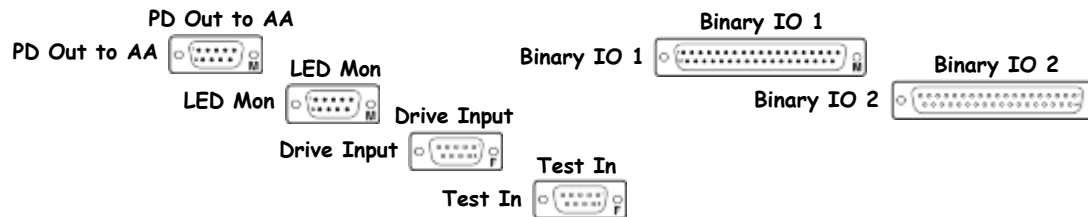

[S1001559](#)
Rear

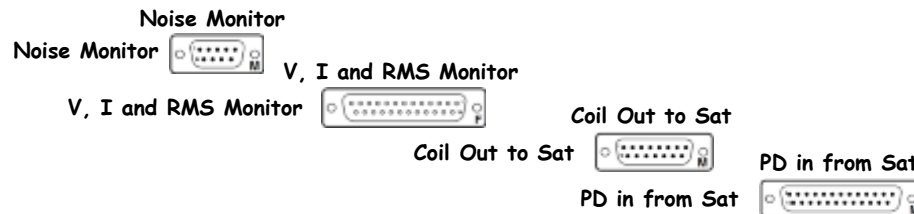

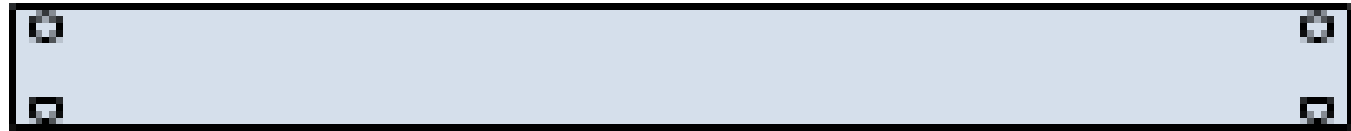

[D1100301](#)

Front

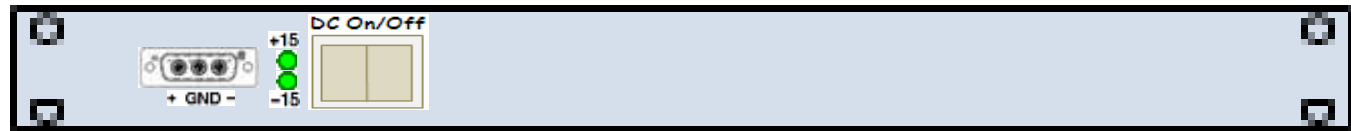

[S1001556](#)

Rear

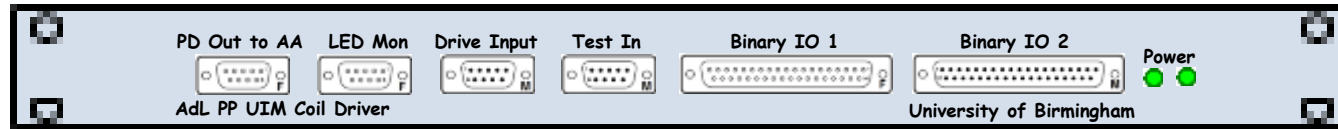

[D070481](#)
[D070480](#)
Front

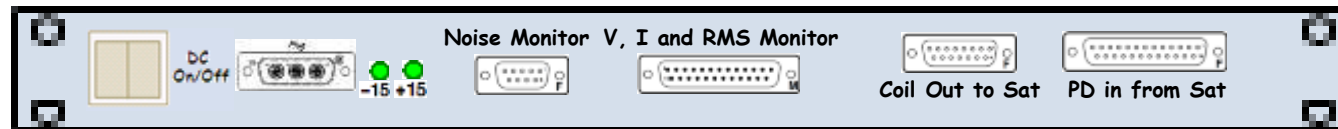
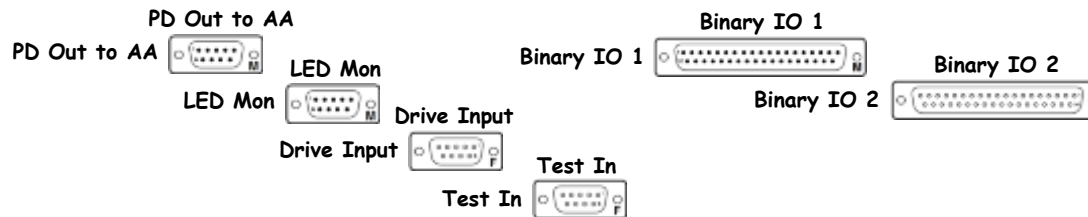

[S0900315](#)
Rear

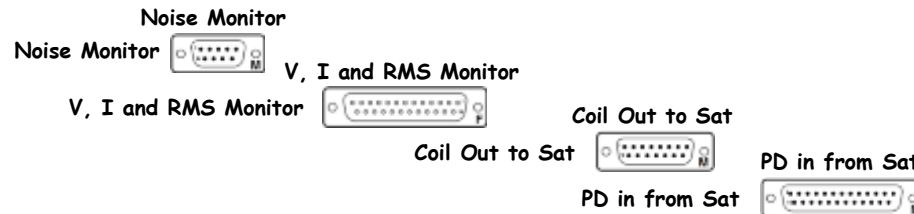

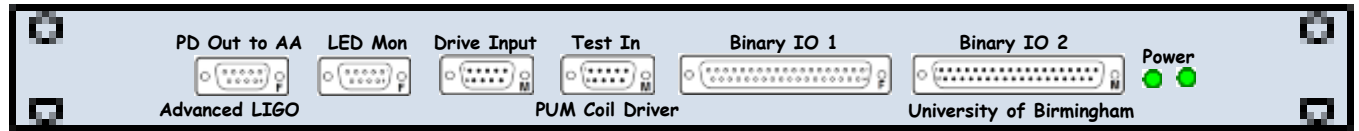

[D070483](#)
[D070480](#)
 Front

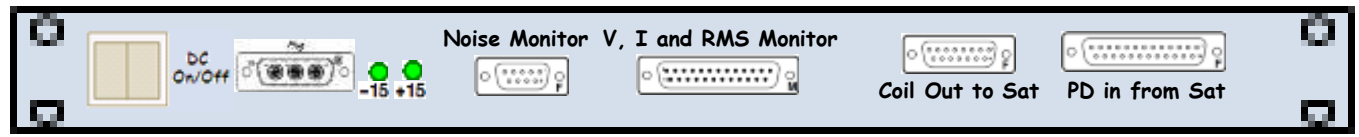
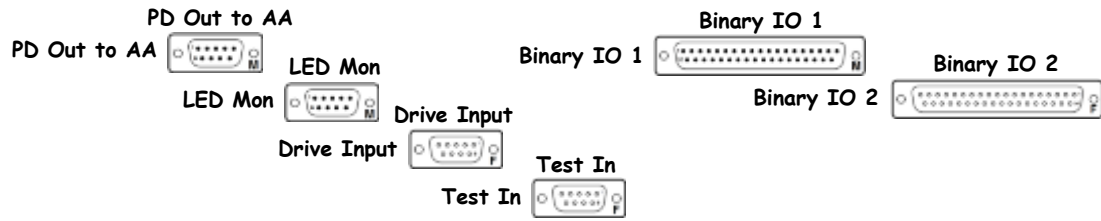

[S1101563](#)
 Rear

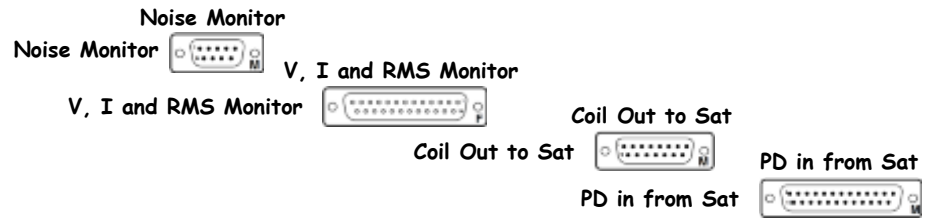

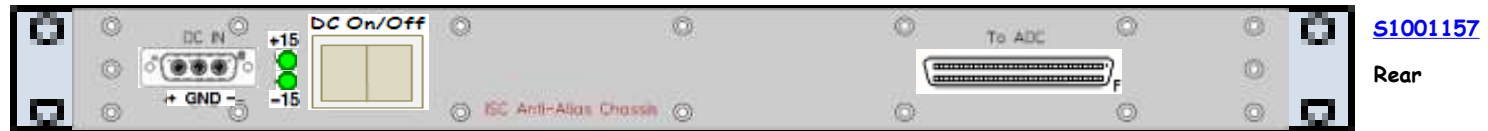
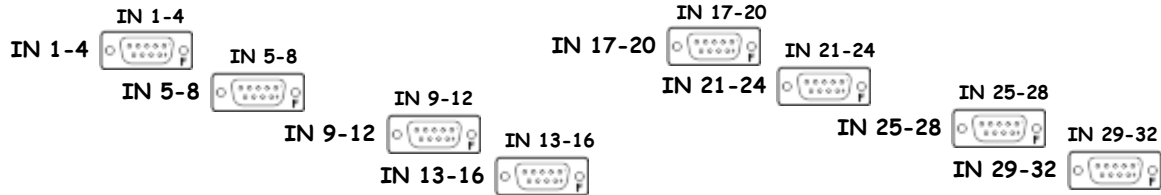

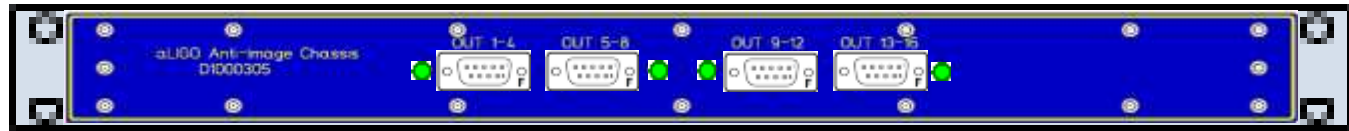

D1000305

Front

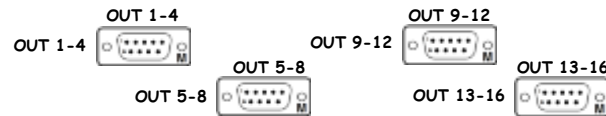

S1004364

Rear

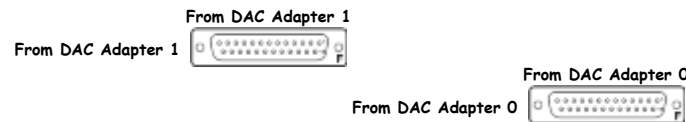

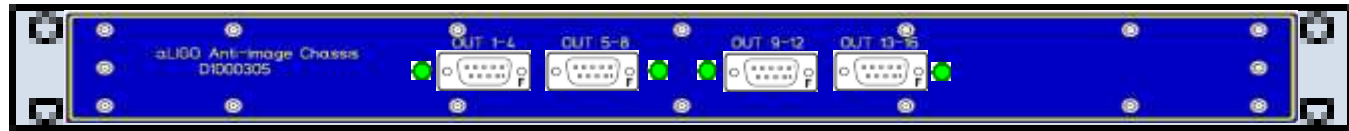

D1000305

Front

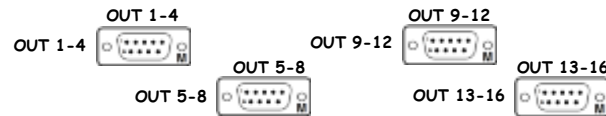

S1004365

Rear

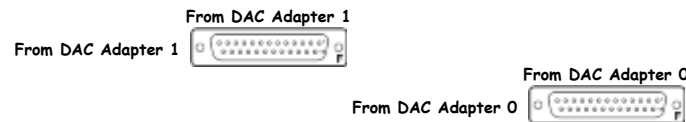

D1100815 is an AI, which means it has OUTPUTS, not INPUTS. The labels are incorrect.

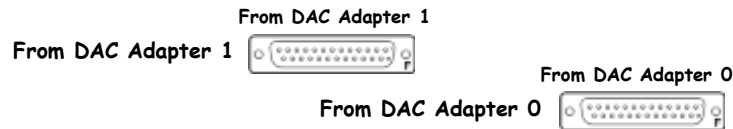
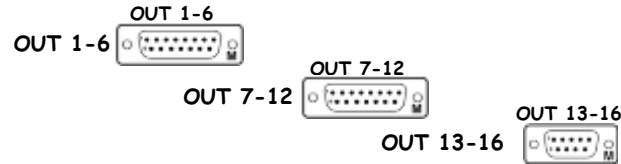

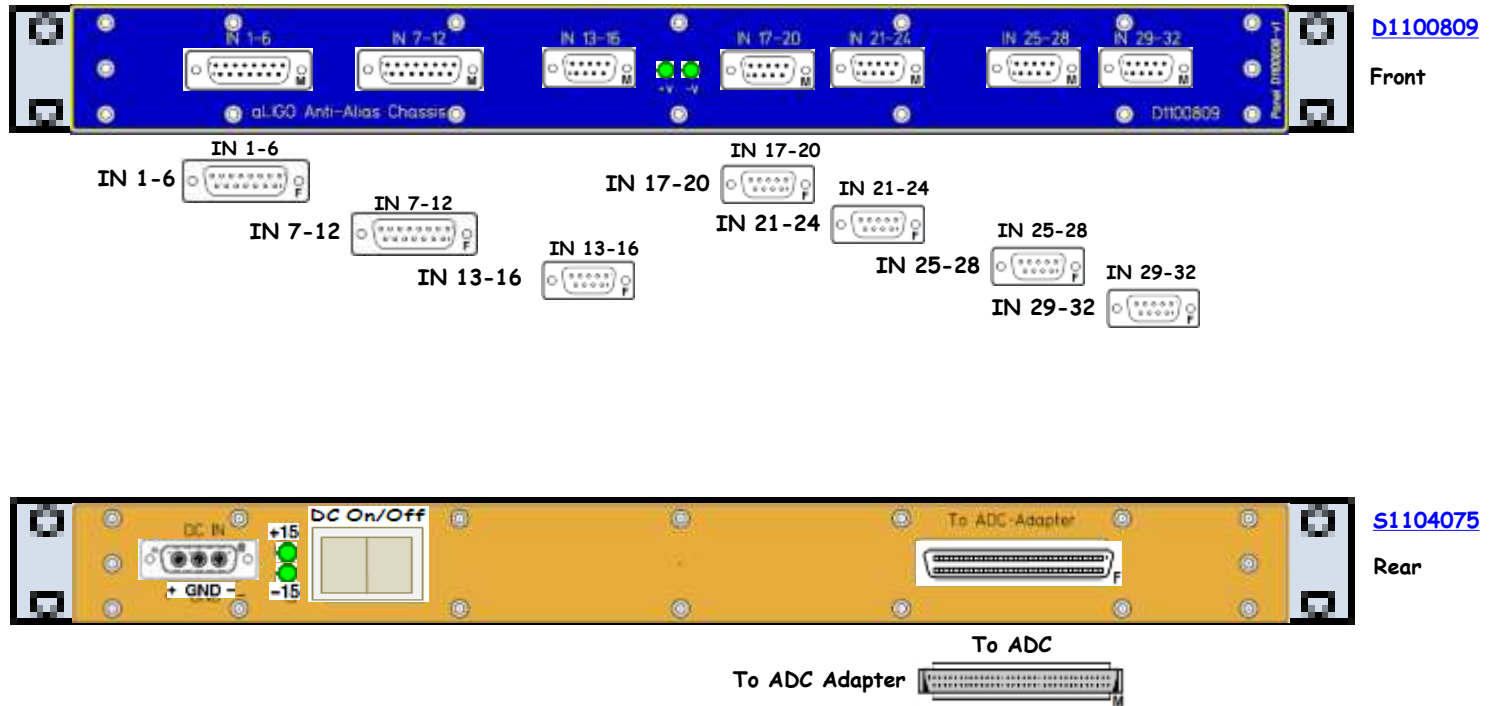

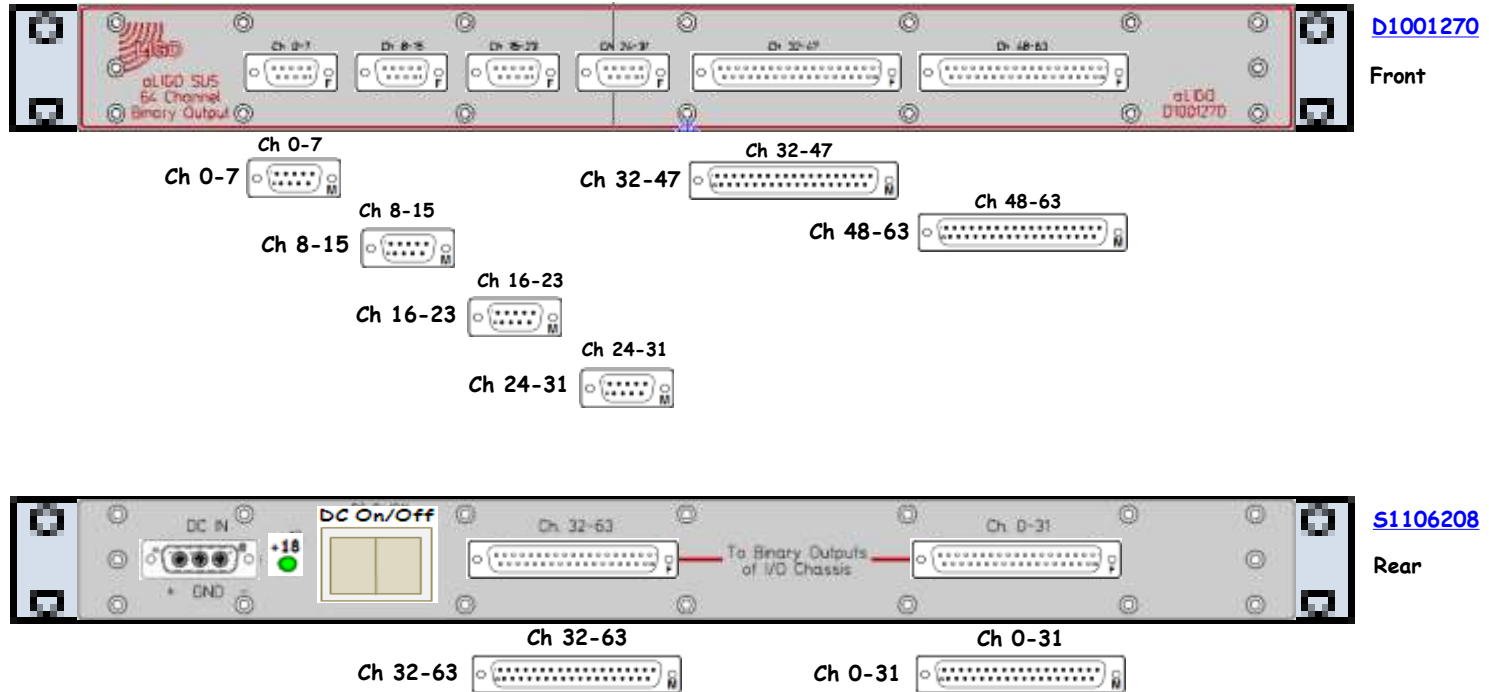

D1001270

Front

S1106208

Rear

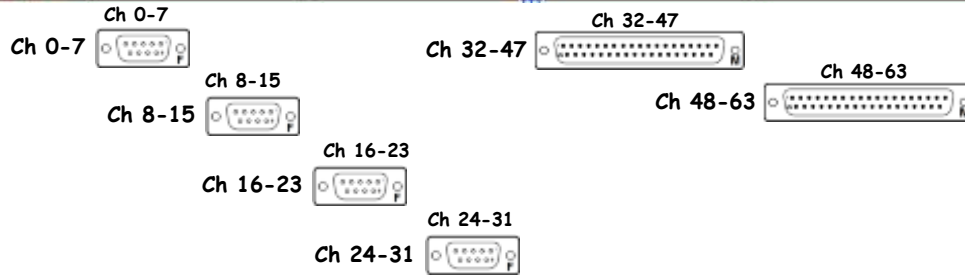
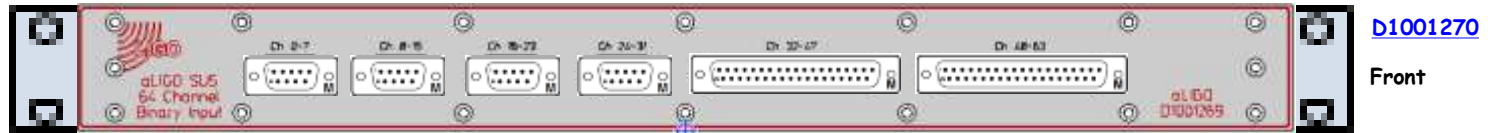

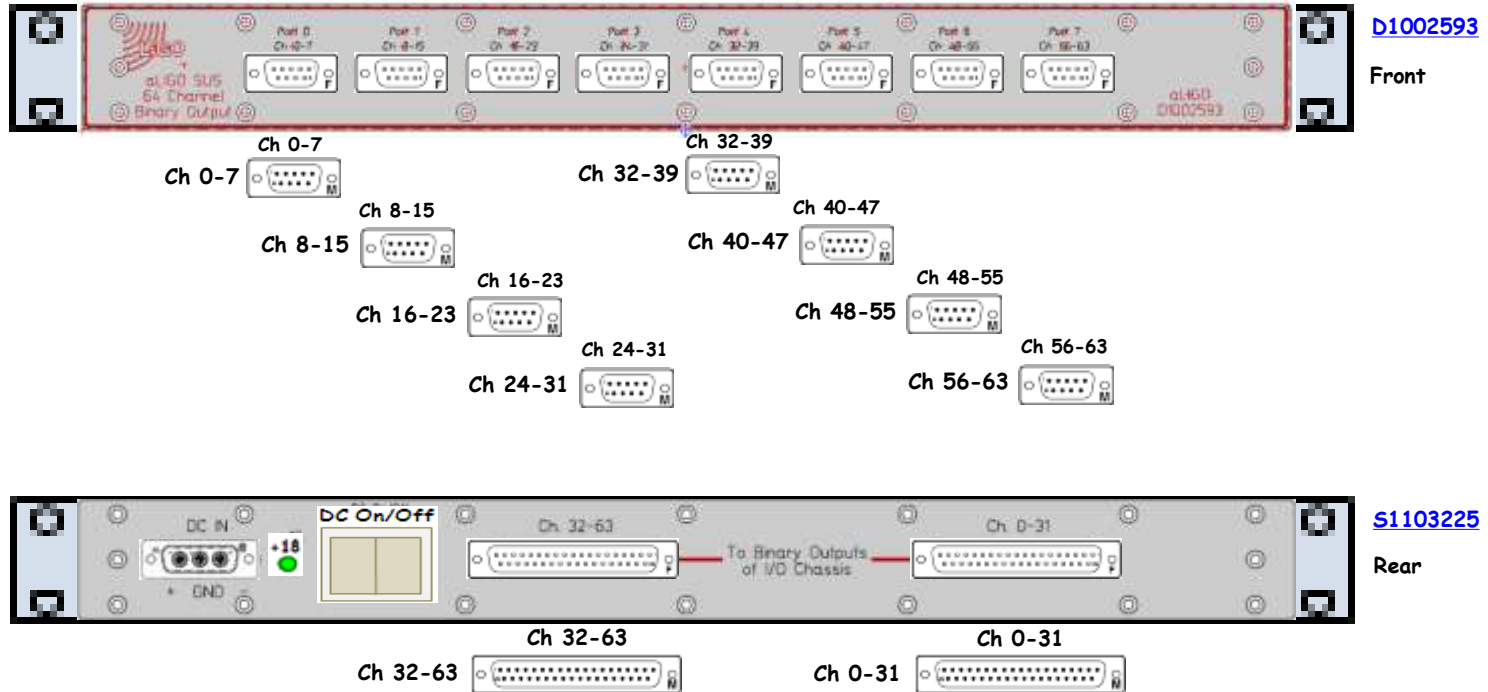

D1002593

Front

S1103225

Rear

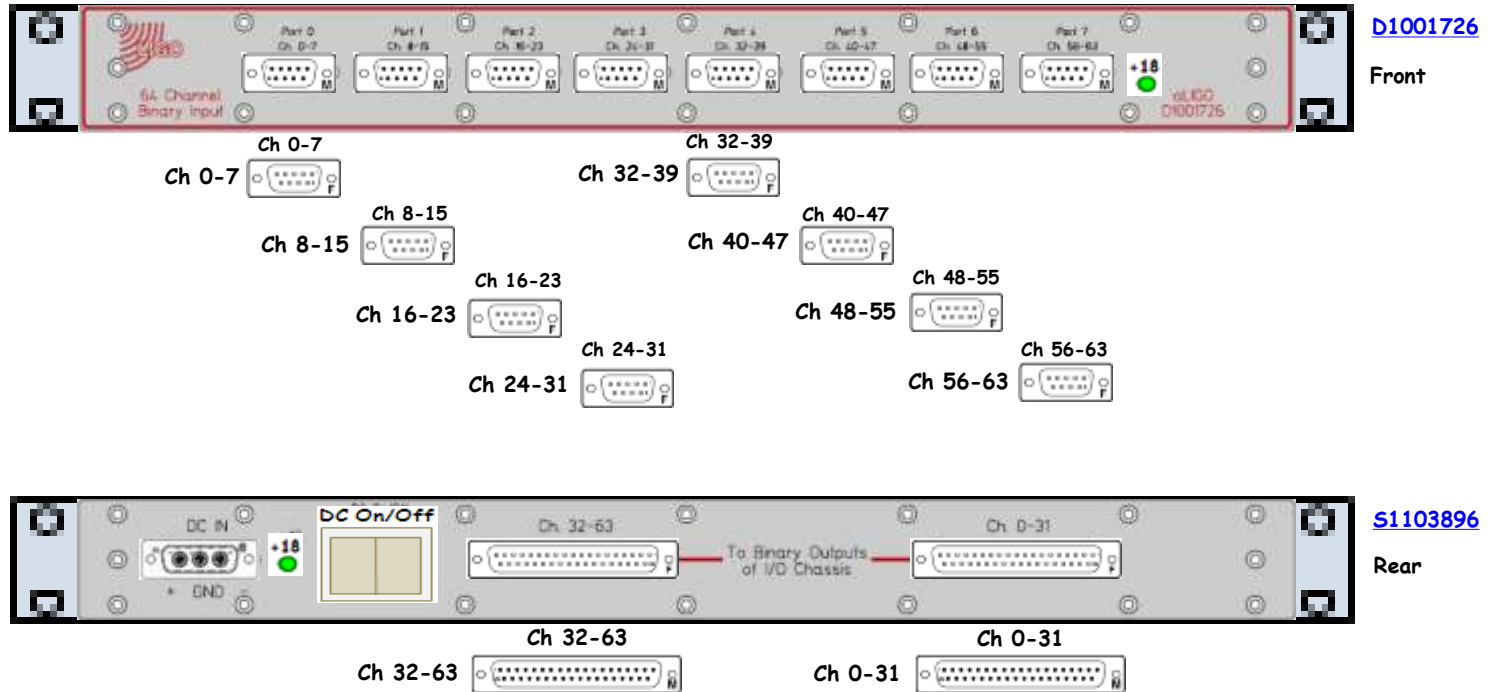

D1001726

Front

S1103896

Rear

<< [CERX Racks](#)
 << [XEND Racks and Tables](#)

L1-SUS-XC1 (ETM) XEND Remote Rack 1 (of 2) Layout ([D1201083](#)) ([S1202947](#))

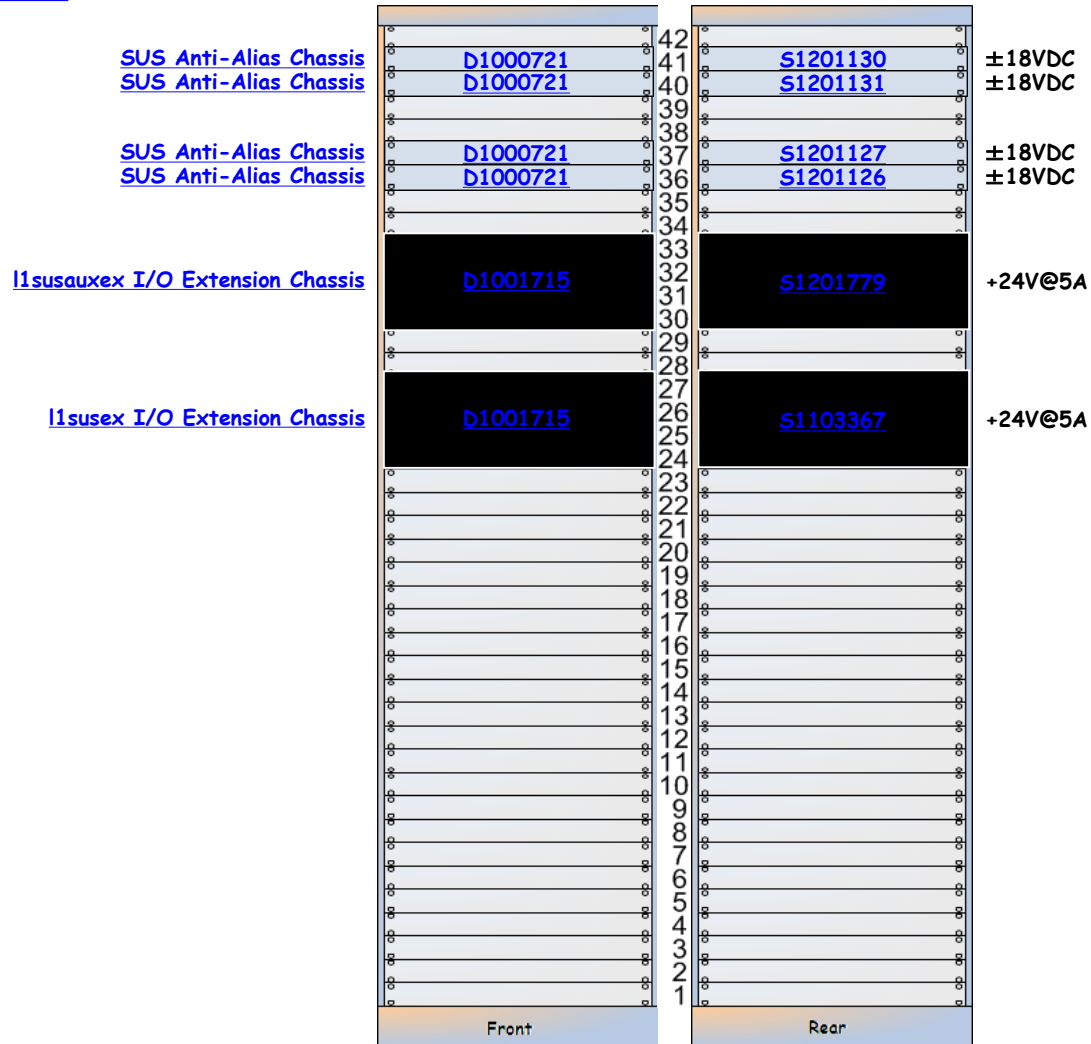

SUS-XC2 is part of [D1002741](#).



L1-SUS-XC2 Details

SUS-XC2 is part of [D1002741](#).

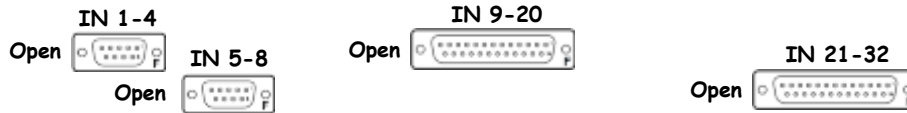

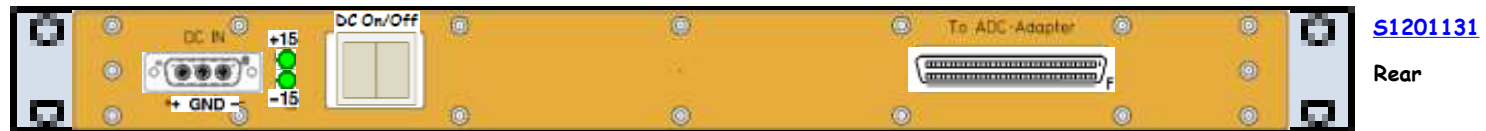
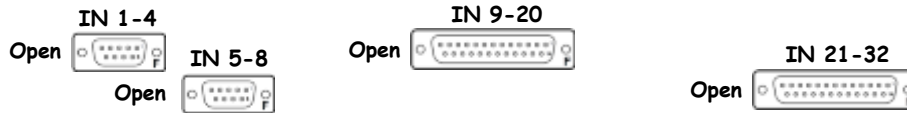

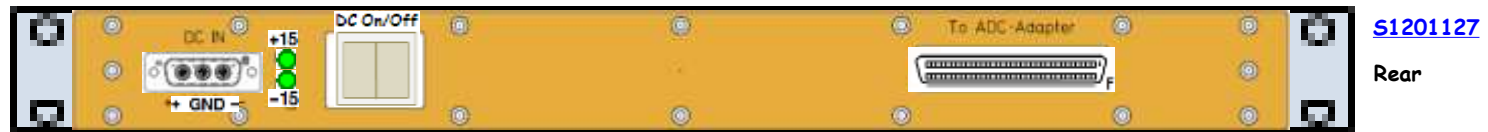
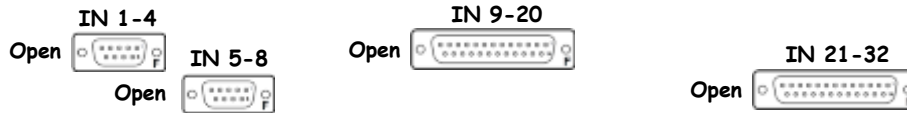

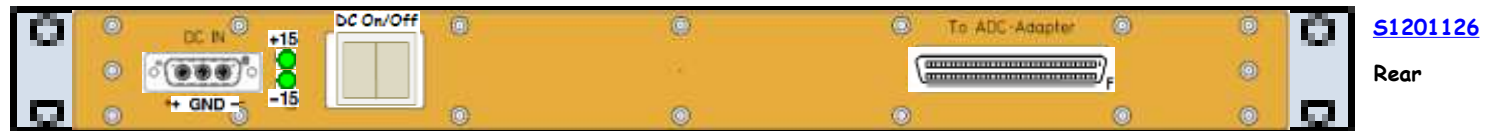
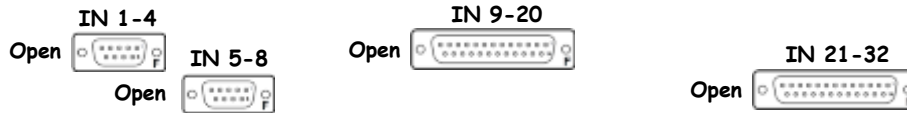

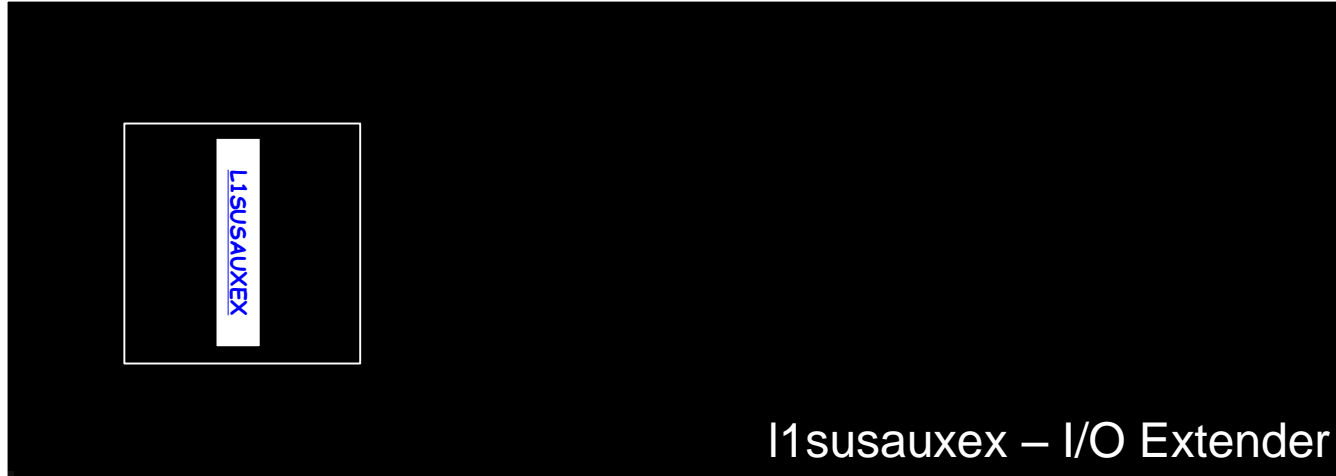

D1001715

Front

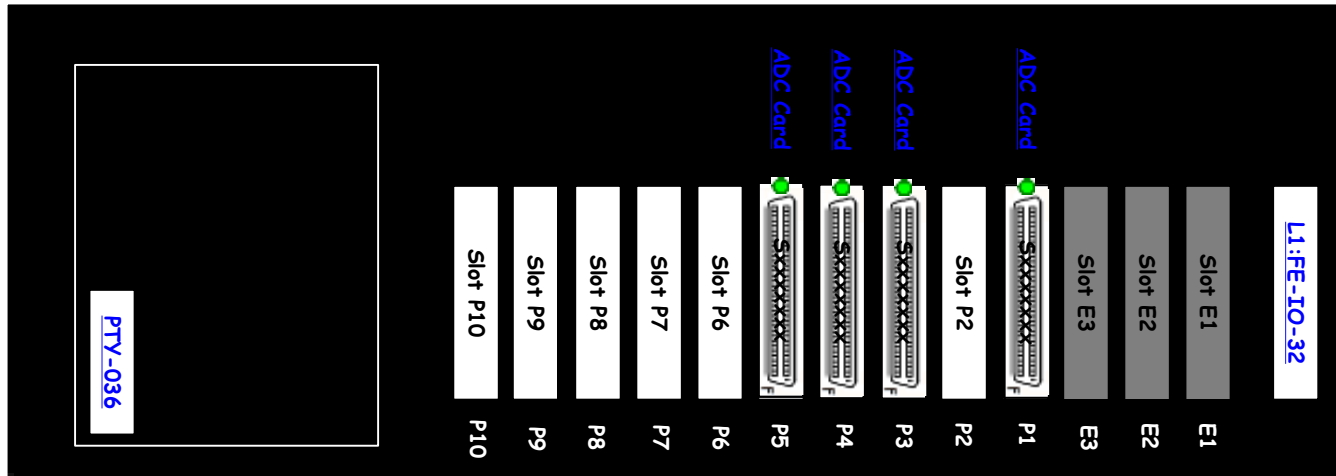

S1201779

Rear

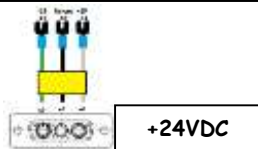
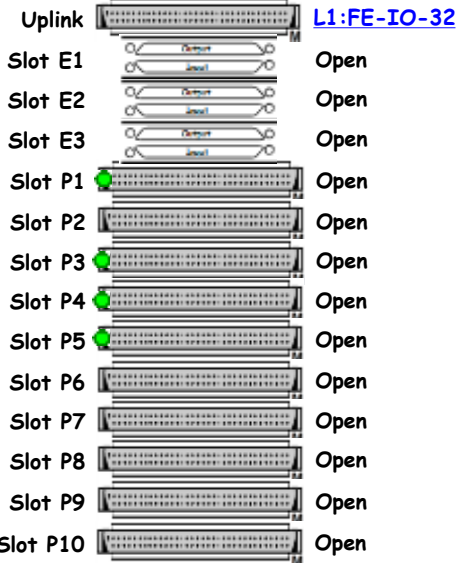



D1001715

Front

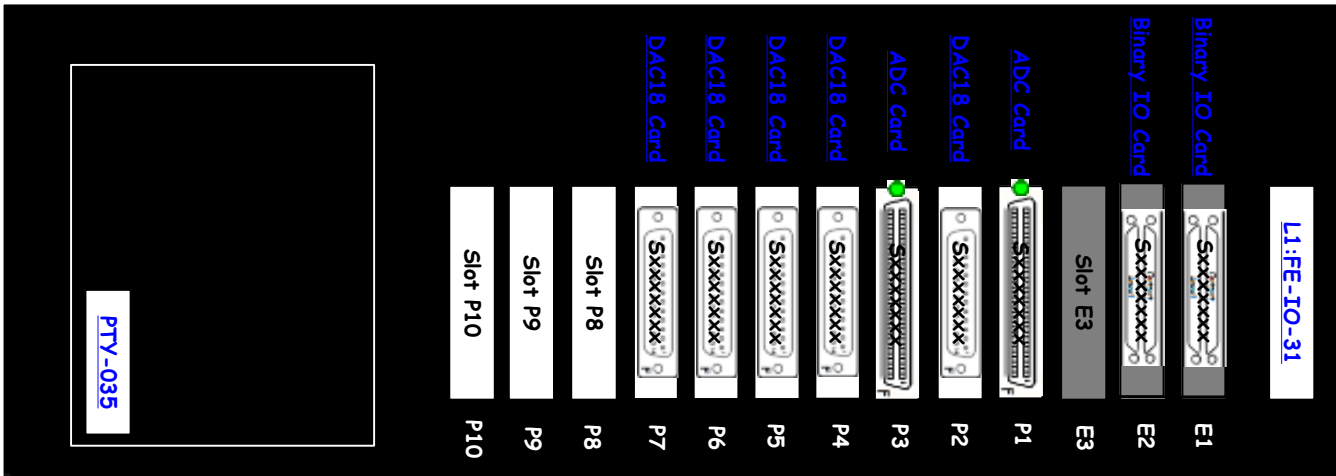

S1103367

Rear

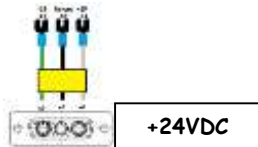
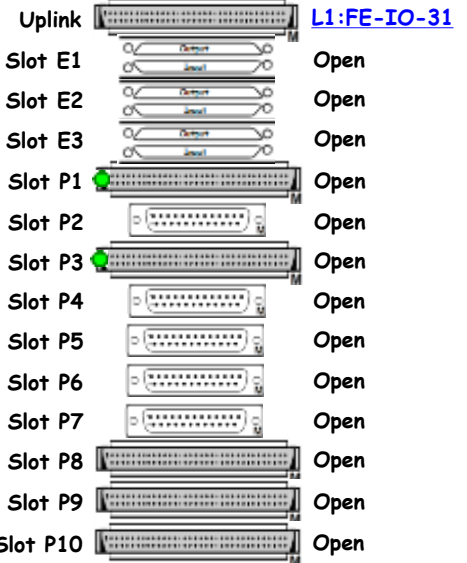

<< [CERX Racks](#)
 << [XEND Racks and Tables](#)

L1-TCS-XC1 XEND Remote Rack Layout ([D1201129](#)) ([S1202980](#))

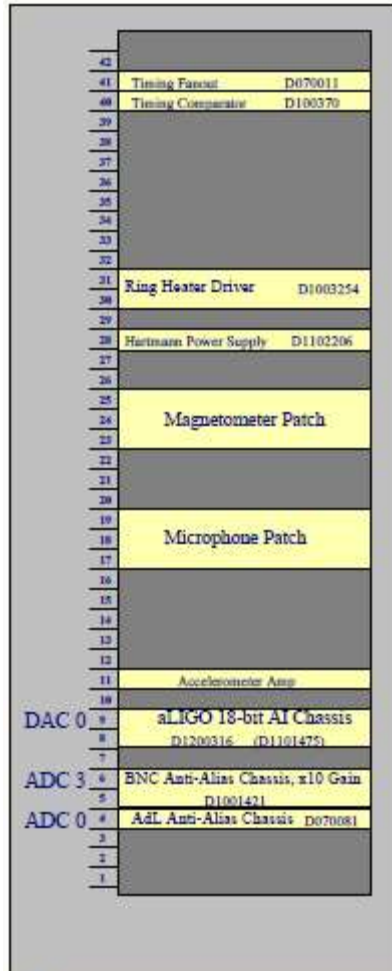

[Timing Fanout Module](#)

[Timing Comparator](#)
[Timing Concentrator Chassis](#)

[Beckhoff End Link](#)

Perforated Shelf

[Ring Heater Driver](#)

Perforated Shelf

OOV Distribution Chassis
 Perforated Shelf

[Accelerometer Power Supply](#)

[Bit AI Interface Chassis](#)

[Interface Chassis \(PEM\)](#)

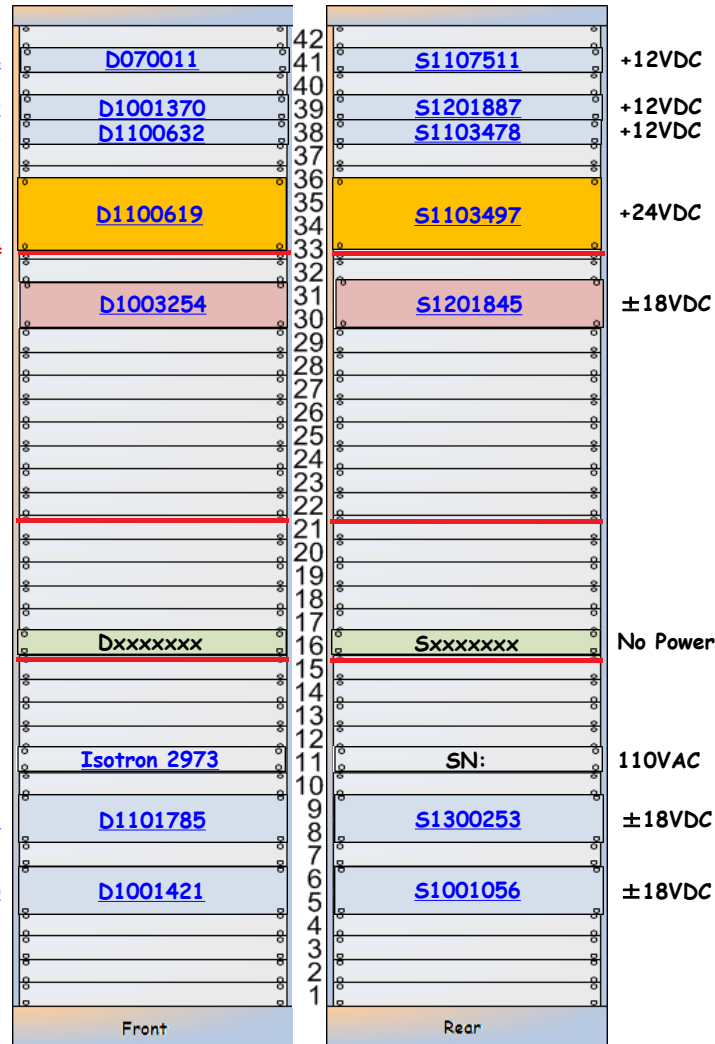

TCS-XC1 is part of [D1200258](#)

TCS-XC1 is part of [E1100894](#)

[Hartmann Sensor Power Supply](#) [D1102206](#) [S1201882](#) ±18VDC

L1-TCS-XC1 Details

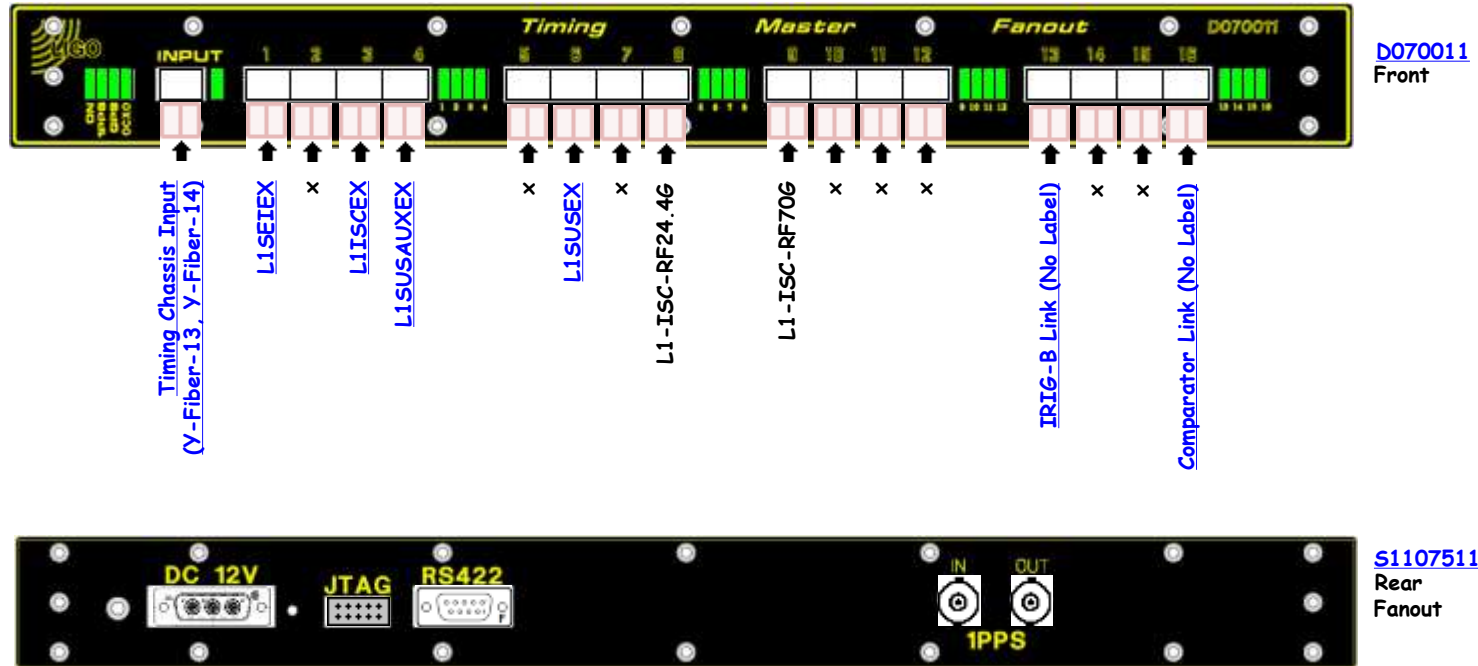



[D1001370](#)

Front

[Timing Fanout \(No Label\)](#)



[S1201891](#)

Rear



D1100632

Front

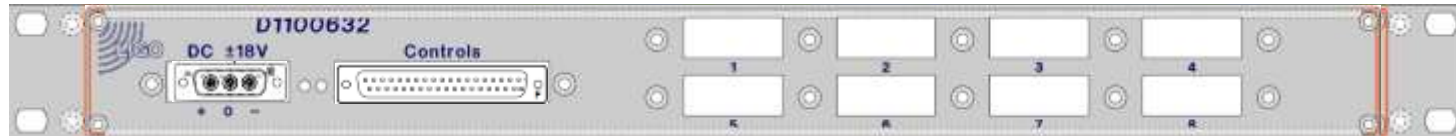

S1103478

Rear



<< L1-TCS-XC1

Beckhoff End Link

D1100619

S1103497

+24VDC

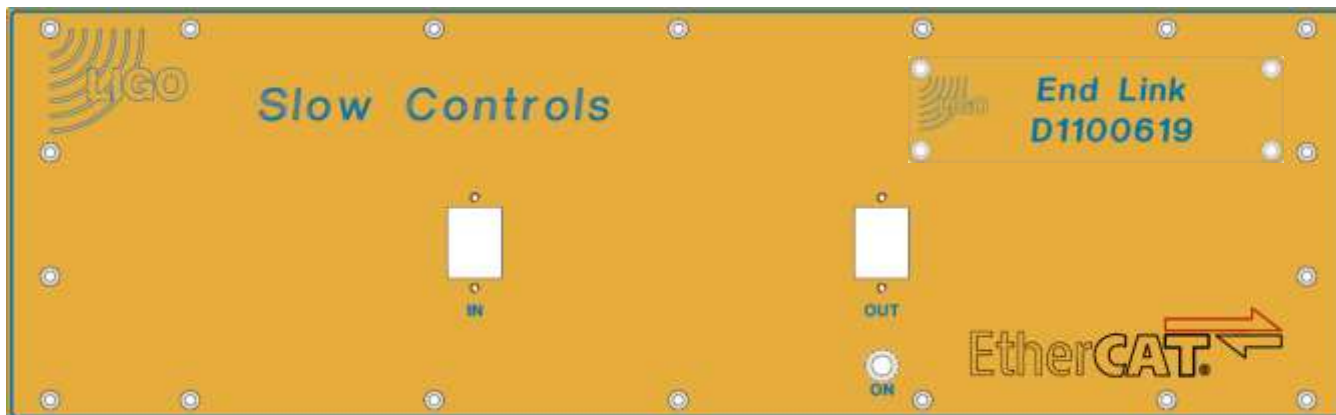

D1100619

Front: D0902553

Name: D1100667

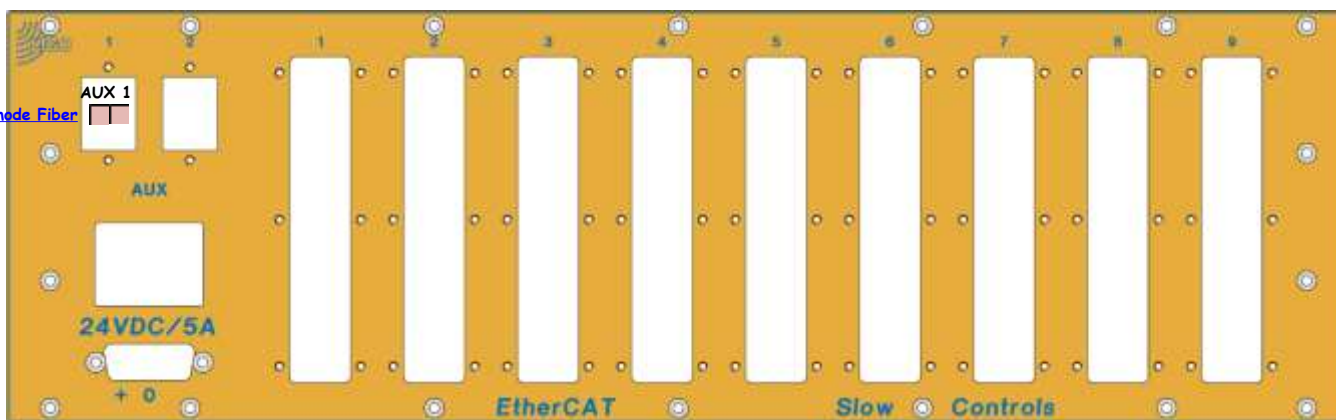

End Link Multimode Fiber

S1103497

Rear: D0902554

End Link Single Mode Fiber VERTEX

Ring Heater Driver

D1003254

S1201845

±18VDC

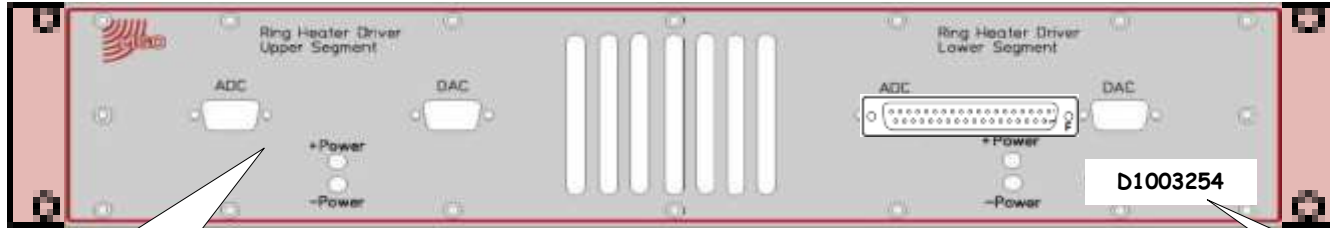

D1003254

Front

This is an early revision of the front panel. It now has one DB37M connector. 20121205 dlk



White label 20121205 dlk

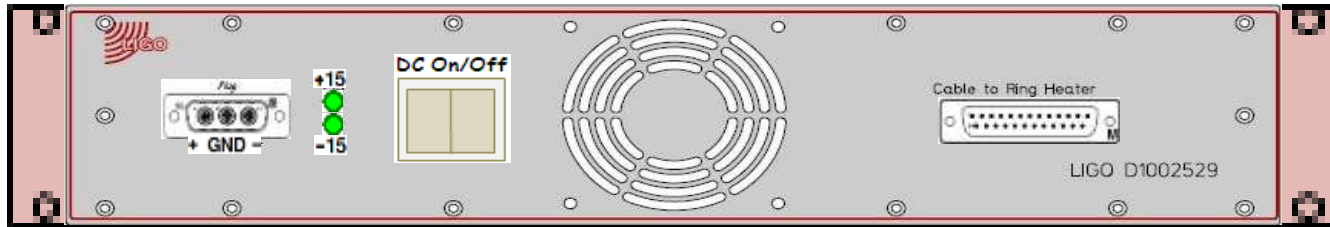

S1201845

Rear



<< L1-TCS-XC1

Hartmann Sensor Power Supply +12VDC

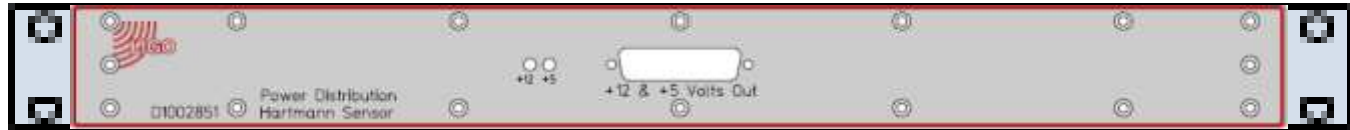

D1102206
Front



Sxxxxxxx
Rear

Accelerometer Power Supply



[Isotron 2973](#)

Front

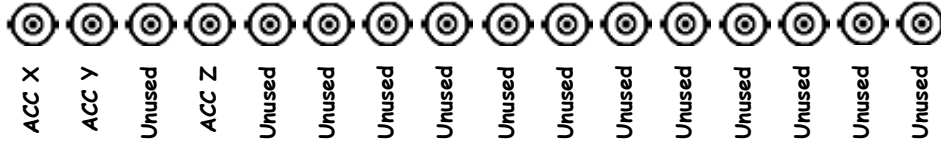

Sxxxxxxx

Rear

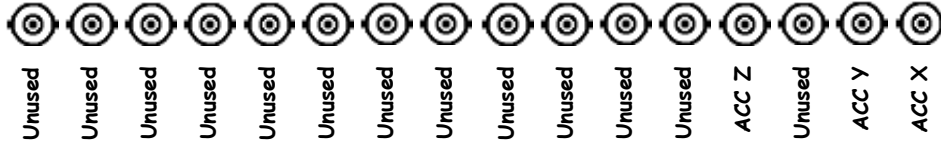

aLIGO 18 Bit AI Interface Chassis

D1101785

S1300253

Power

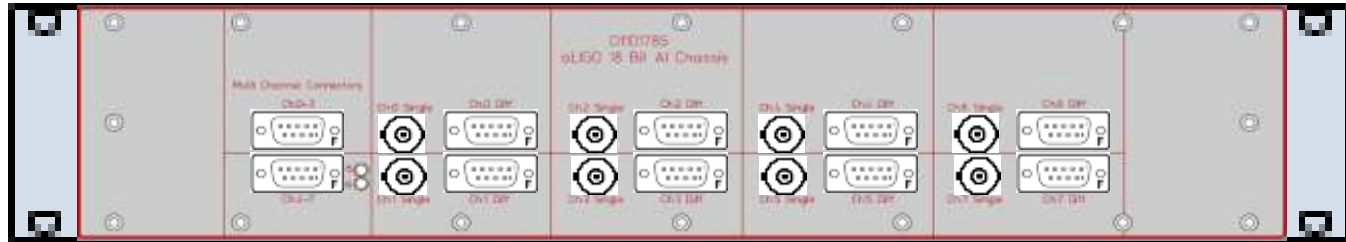

D1101785

Front

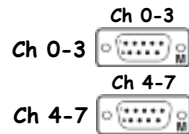

S1300253

Rear



<< L1-TCS-XC1

aLIGO AA Interface Chassis
(32 BNC, x10 Gain Version)

D1001421

SN:

Power

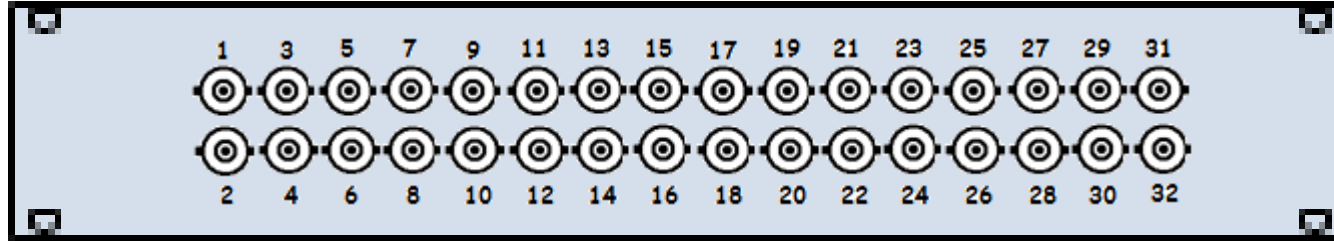

D1001421

Front

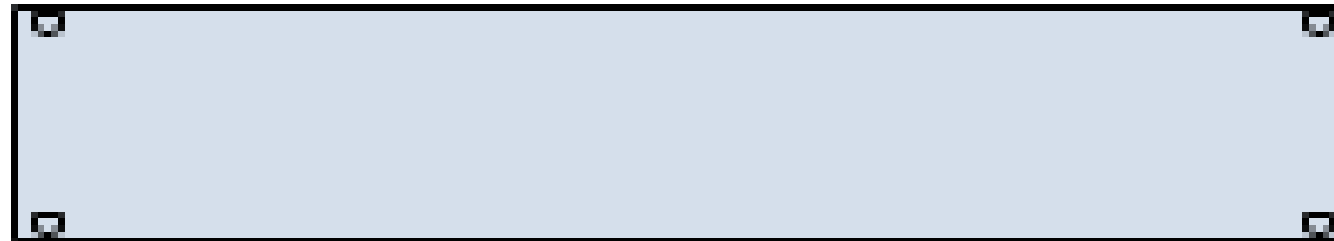
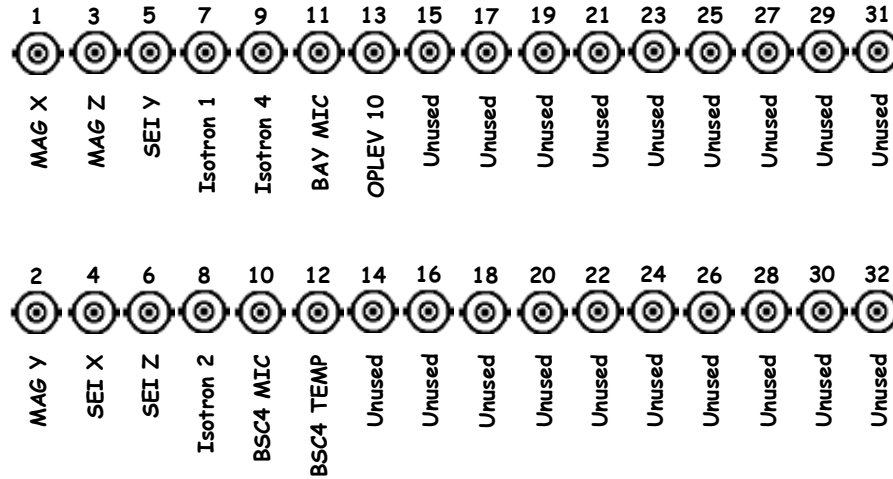

SN:

Rear

aLIGO Accelerometer Interface Chassis

D1101363

SN:

Power

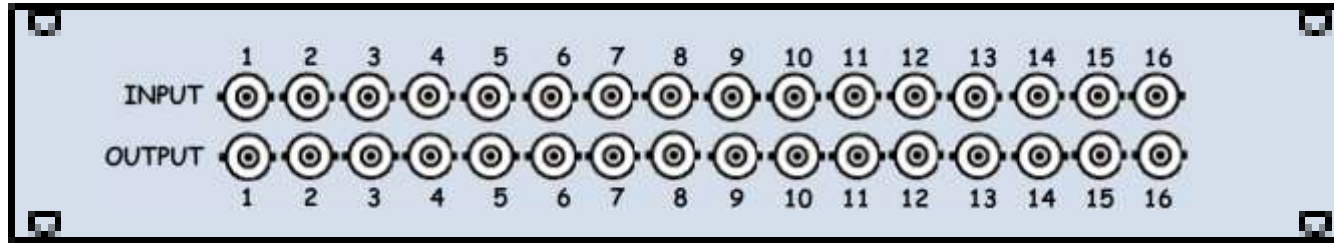

D1101363

Front

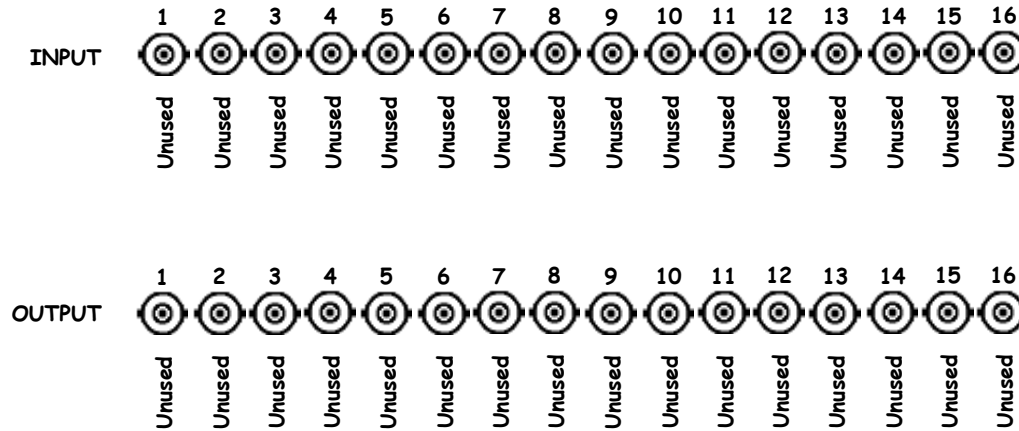

SN:

Rear



RF Distribution Panel 24	Dxxxxxxx	42	Sxxxxxxx	No Power
RF Distribution Panel 25	Dxxxxxxx	41	Sxxxxxxx	No Power
24.5 MHz Delay Line Phase Shifter	D0900128	40	S1103433	+15VDC
2 Channel RFPD I/Q Demod (RC & ALS)	D1000181	39	S1000787	±17VDC, ±24VDC
WFS Demodulator Patch Panel	D1201470	38	Sxxxxxxx	No Power
79.4 MHz VCO (ALS)	D0900605	37	S1200577	±17VDC, ±24VDC
39.7 MHz Frequency Divider	D1002182	36	S1000752	±17VDC, ±24VDC
RF Preamplifier	D1201294	35	S1203937	??
39.7 MHz 2 Channel Phase/Freq Discriminator	D1002476	34	S1000767	±17VDC, ±24VDC
Common Mode Servo (ALS Laser Locking)	D0901781	33	S1102644	±17VDC, ±24VDC
Common Mode Servo (ALS Cavity Locking)	D0901781	32	S1102634	±17VDC, ±24VDC
Oplev 8 Channel Whitening Filter Chassis	D1100013	31	S1101545	±18VDC
LSC Demod Concentrator 5	D1100691	30	S1104009	±18VDC
ASC Demod Concentrator 6	D1100696	29	S1103990	No Power
Auxiliary Signals Concentrator 2	D1102045	28	S1200534	±17VDC
Auxiliary Signals Concentrator 1	D1102065	27	S1200551	±17VDC
Auxiliary Signals Concentrator 5	D1201352	26	S1300250	±17VDC
Picomotor Driver and Photodiode Amplifier	D1100323 D1301017	25	S1400008 S1107547	±24VDC, ±24VDC
ISC Whitening Chassis	D1002559	24	S1101168	±15VDC
QUAD I&Q Demodulator Module	D0902796	23	S1001023	±15VDC
LSC RFPD Demodulator Patch Panel	D1100956	22	Sxxxxxxx	No Power
QUAD I&Q Demodulator Module	D0902796	21	S1000973	±15VDC
ISC Whitening Chassis	D1002559	20	S1101623	±15VDC
Legacy WFS Interface Module	D1100749	19	S1400283	±15VDC
Differential to Single-Ended Converter	D1100482	18	S1203309	±15VDC
ISC Whitening Chassis	D1002559	17	S1101164	±15VDC
Dual QPD Transimpedance Amplifier	D1002481	16	S1102831	±15VDC
Dual QPD Transimpedance Amplifier	D1002481	15	S1102825	±15VDC
ISC Whitening Chassis	D1002559	14	S1101165	±15VDC
		13		
		12		
		11		
		10		
		9		
		8		
		7		
		6		
		5		
		4		
		3		
		2		
		1		
	Front		Rear	

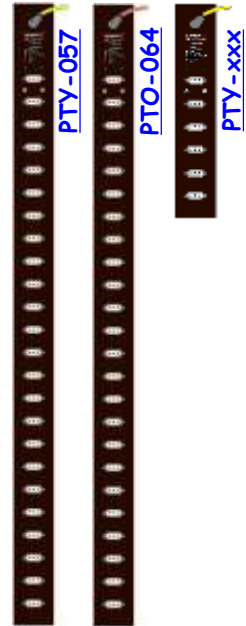

ISC-XR1 is part of [D1001423](#)

L1-ISC-XR1 Details

End Station ISC Field Rack Layout

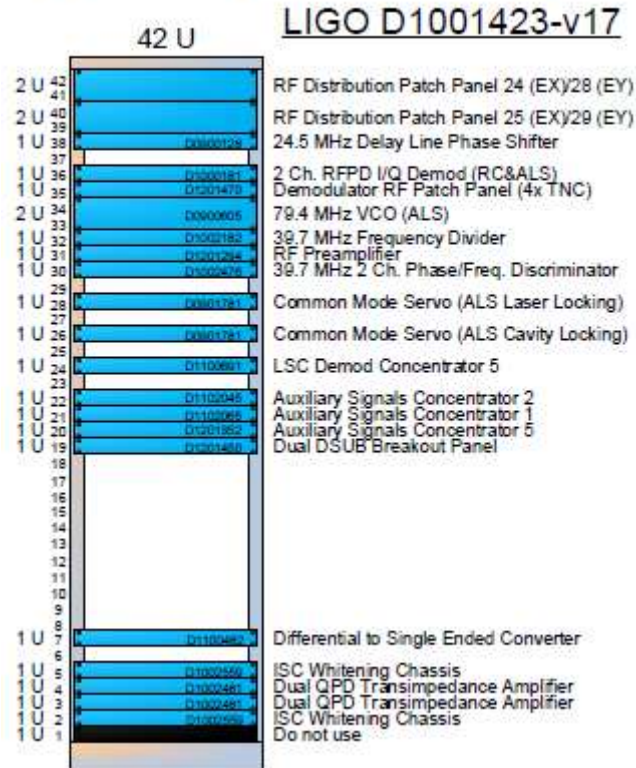

L1-ISC-XR1 Details

RF Distribution Panel 24

<< [L1-ISC-XR1](#)

RF Distribution Panel 24

Dxxxxxxx

Sxxxxxxx

No Power

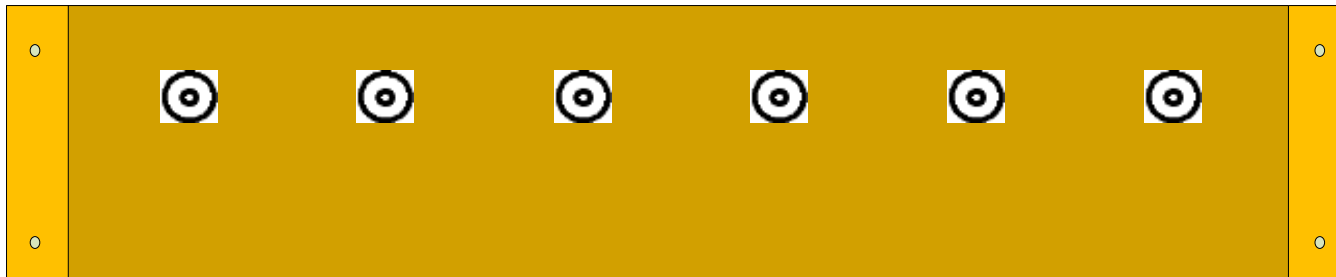

Dxxxxxxx

Front

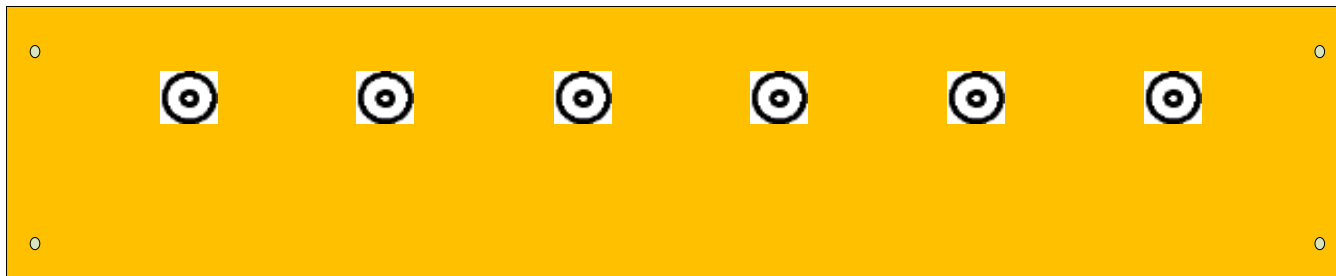

Sxxxxxxx

Rear

RF Distribution Panel 25

<< [L1-ISC-XR1](#)

RF Distribution Panel 25

Dxxxxxxx

Sxxxxxxx

No Power

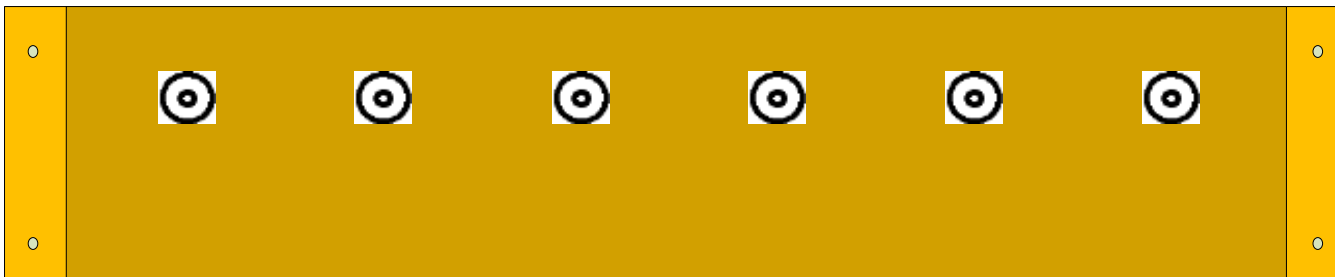

Dxxxxxxx

Front

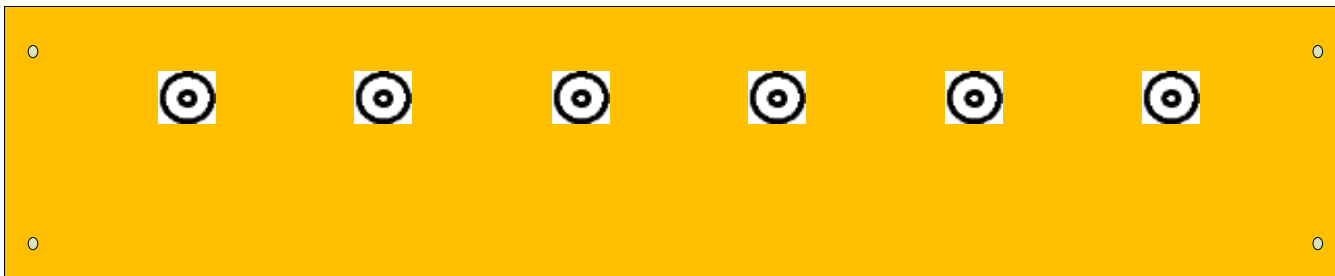

Sxxxxxxx

Rear

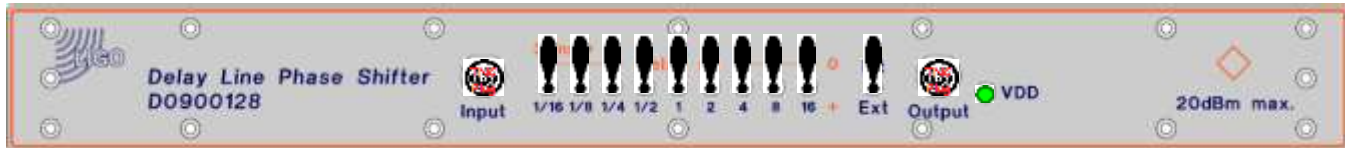

D0900128

Front

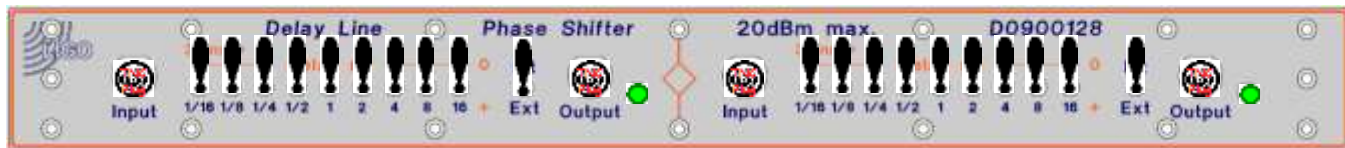

S1103433

Rear

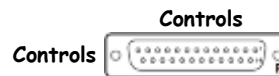



[D1000181](#)

Front



[S1000787](#)

Rear



Controls

D1201470 - Sxxxxxxx

<< [L1-ISC-XR1](#)

WFS Demodulator Patch Panel No Power



[D1201470](#)

Front



Sxxxxxxx

Rear



D0900605

Front



S1200577

Rear

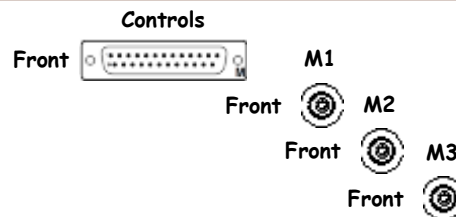
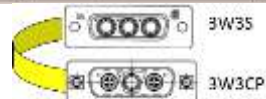



D1002182

Front

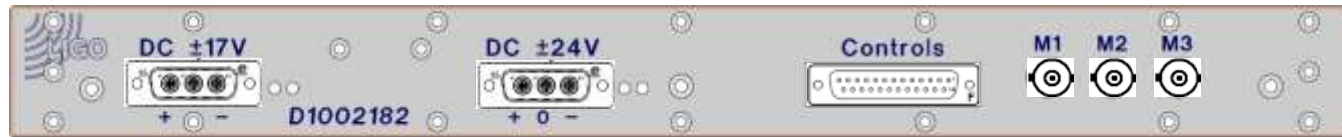

S1000752

Rear

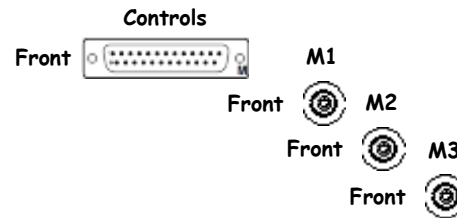
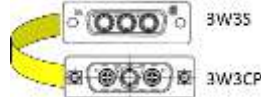

RF Preamplifier D1201294 S1203937 ±18V



[D1201294](#)

Front



[S1203937](#)

Rear

39.7 MHz 2 Channel Phase/Freq Discriminator D1002476 S1000767 ±17VDC, ±24VDC

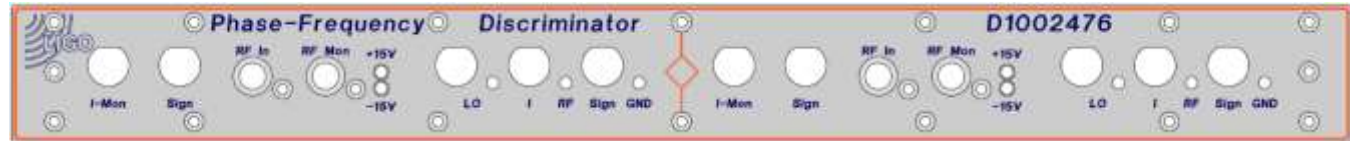

D1002476

Front



S1000767

Rear





D0901781

Front



S1102644

Rear

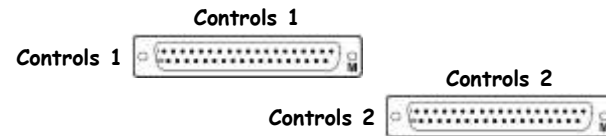
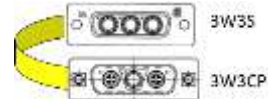



D0901781

Front



S1102634

Rear

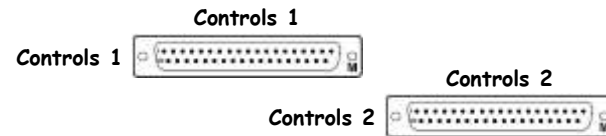
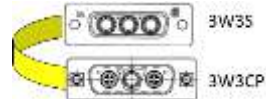

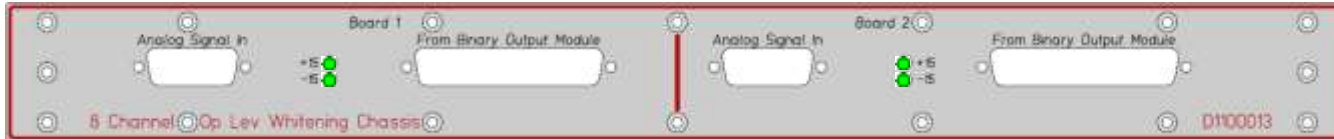

[D1100013](#)

Front



[S1101545](#)

Rear



[D1100691](#)

Front



[S1104009](#)

Rear

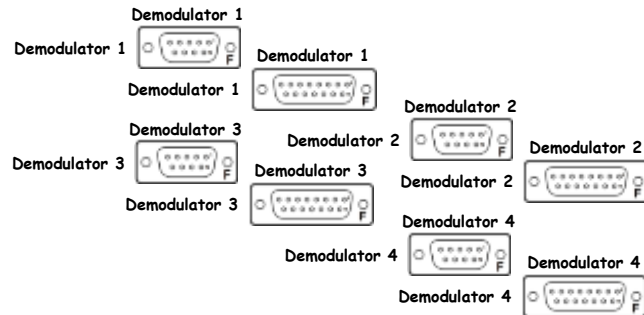
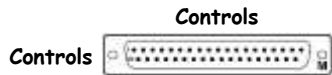



[D1100696](#)

Front



[S1103990](#)

Rear

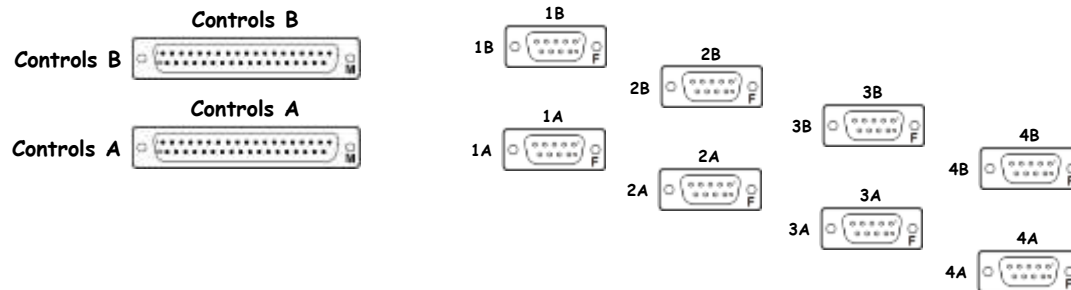

Auxiliary Signals Concentrator 2 D1102045 S1200534 ±17VDC



D1102045

Front



S1200534

Rear

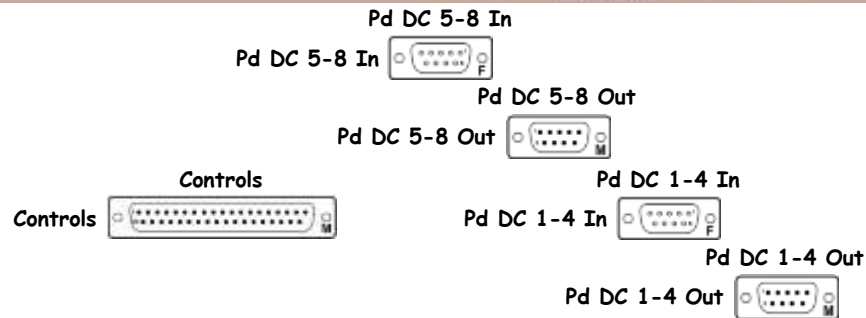

Auxiliary Signals Concentrator 5 ±17VDC



[D1102065](#)

Front



[S1200551](#)

Rear

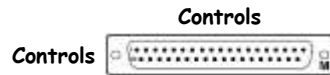

D1201352 - S1300250



<< L1-ISC-XR1

Auxiliary Signals Concentrator 5 D1201352 S1300250 $\pm 17\text{VDC}$

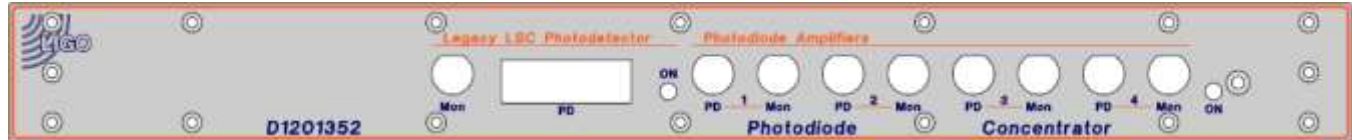

D1201352

Front

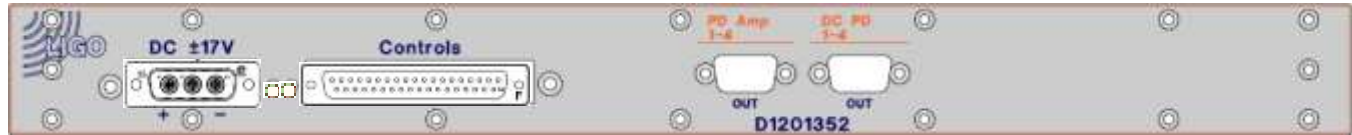

S1300250

Rear

Controls



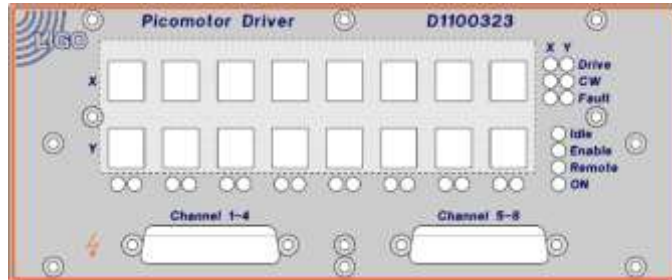

[D1100323](#)

Front

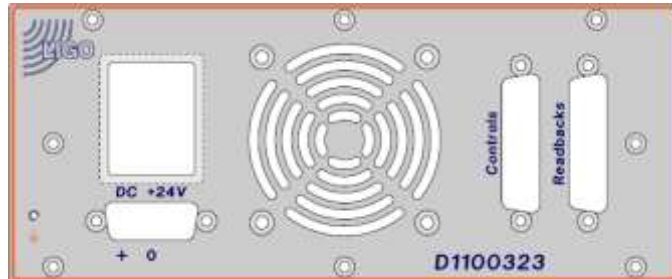

[S1107547](#)

Rear

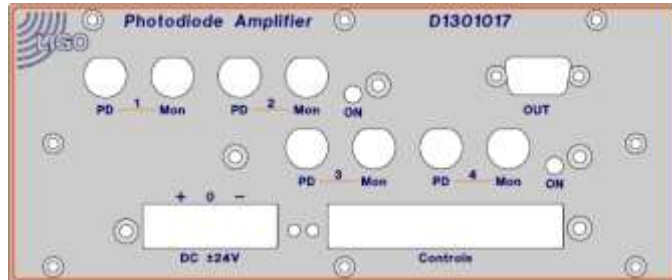

[D1301017](#)

Front

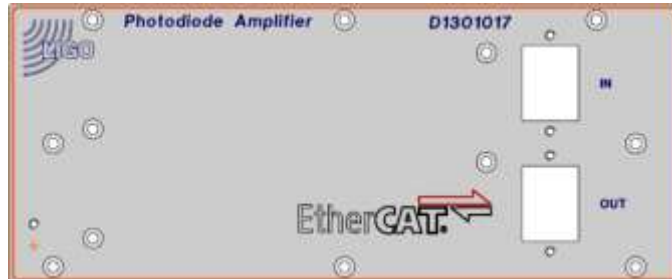

[S1400008](#)

Rear

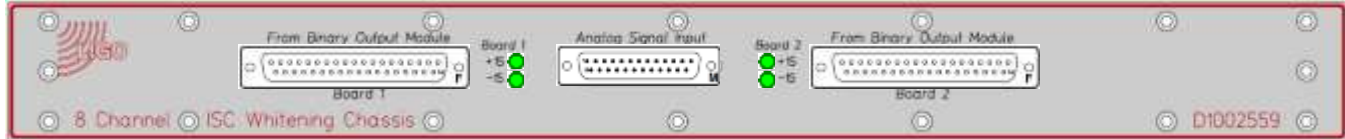

D1002559

Front

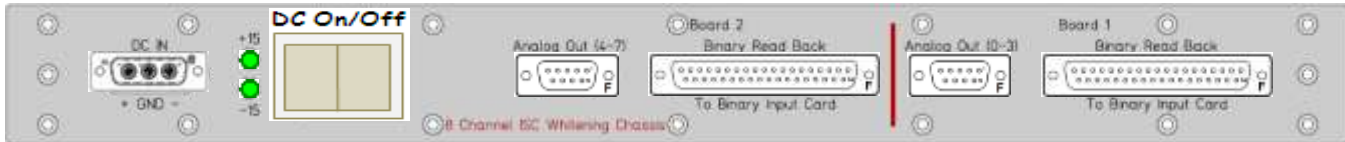
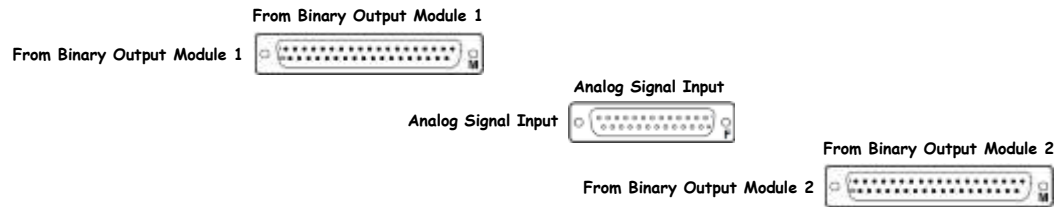

S1101168

Rear

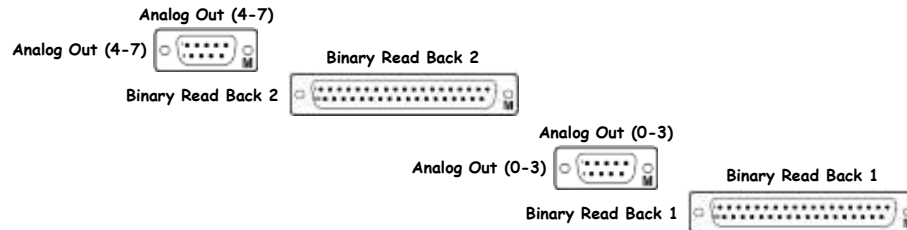

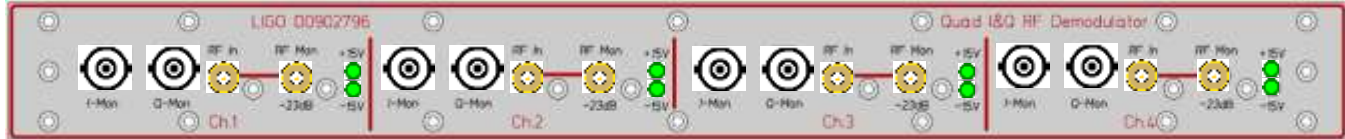

D0902796

Front

D1002032

LSC



S1001023

Rear

RF Mon Out Ch 3&4

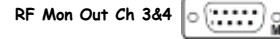

RF Mon Out Ch 3&4

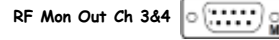

I & Q Outputs



D1002031

WFS



S1001023

Rear

RF Mon Out Ch 3&4

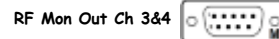

RF Mon Out Ch 3&4

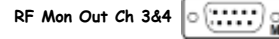

I & Q Outputs



<< [L1-ISC-XR1](#)

LSC RFPD Demodulator Patch Panel No Power



[D1100956](#)

Front

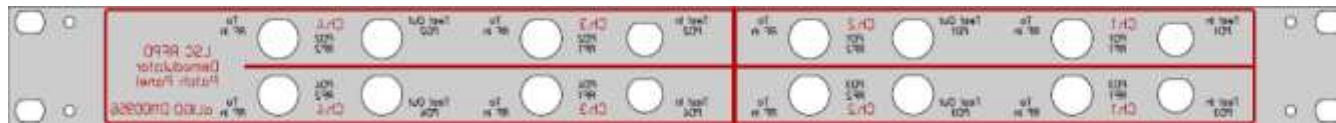

Sxxxxxxx

Rear

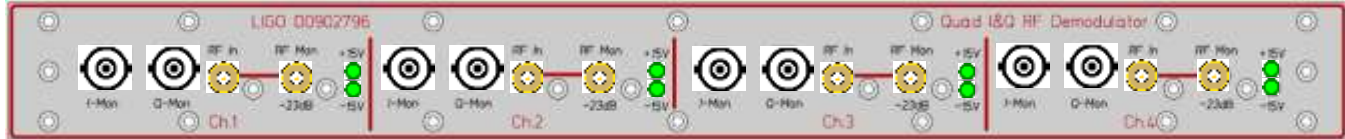

D0902796

Front

D1002032

LSC



S1000973

Rear

RF Mon Out Ch 3&4

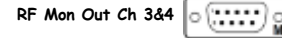

RF Mon Out Ch 3&4

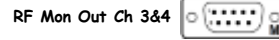

I & Q Outputs

I & Q Outputs



D1002031

WFS



S1000973

Rear

RF Mon Out Ch 3&4

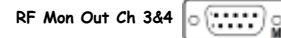

RF Mon Out Ch 3&4

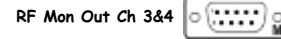

I & Q Outputs

I & Q Outputs



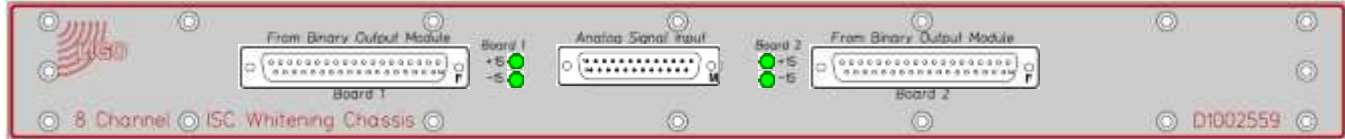

D1002559

Front

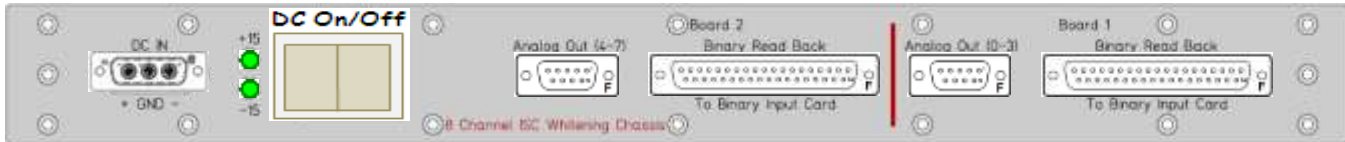
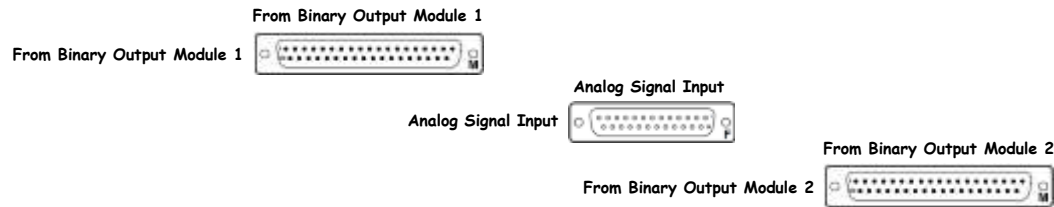

S1101623

Rear

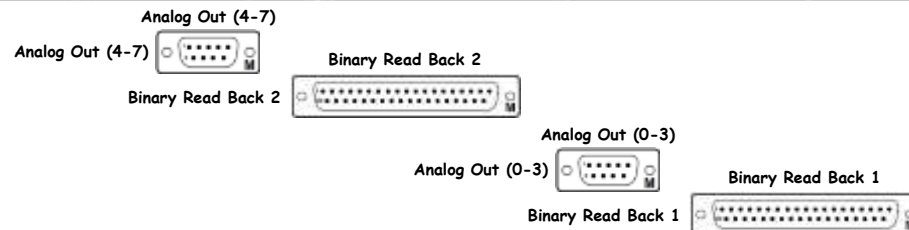



[D1100749](#)

Front



[S1400283](#)

Rear

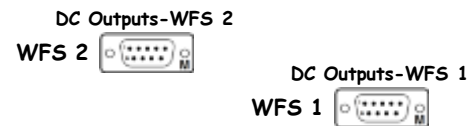

D1100482 - S1203309



<< [L1-ISC-XR1](#)

Differential to Single-Ended Receiver

[D1100482](#)

[S1203309](#)

±15VDC



[D1100482](#)

Front



[S1203309](#)

Rear



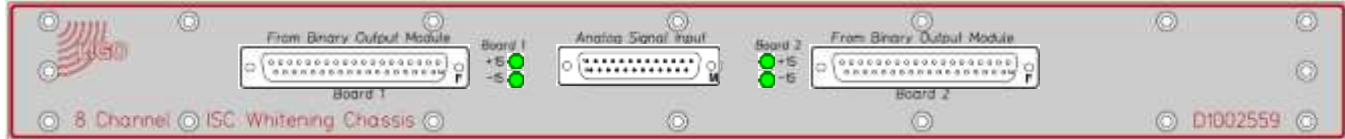

D1002559

Front

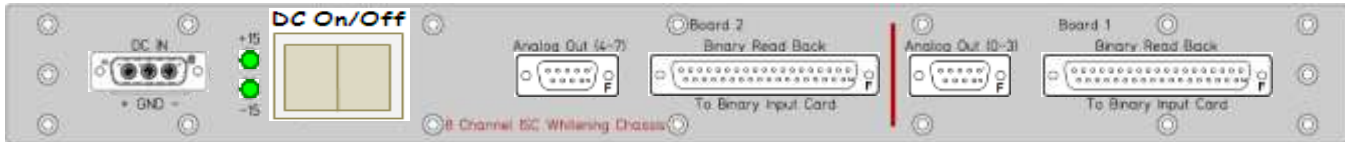
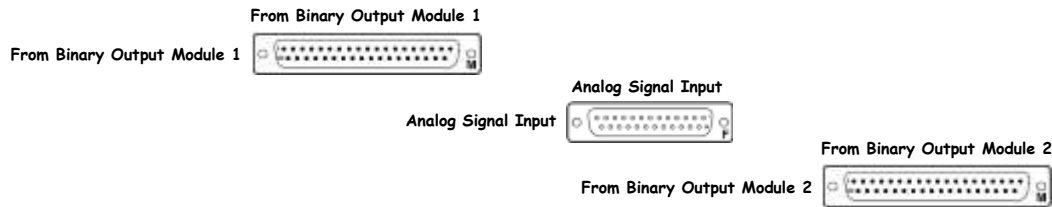

S1101164

Rear

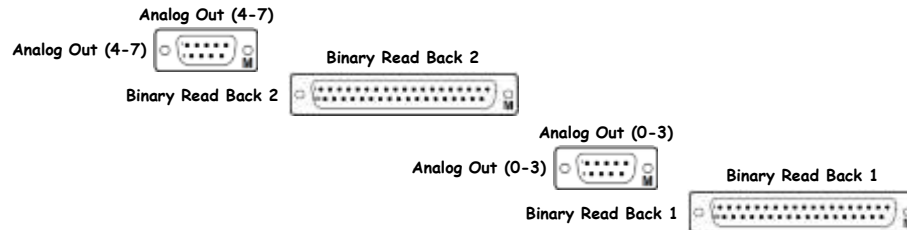

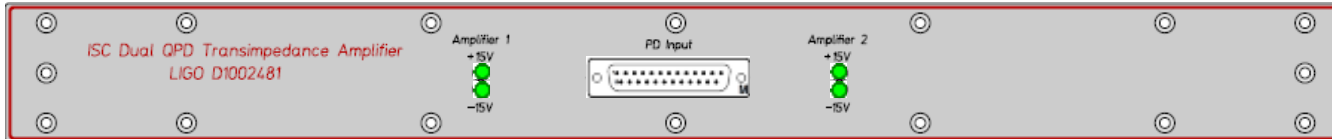

[D1002481](#)

Front

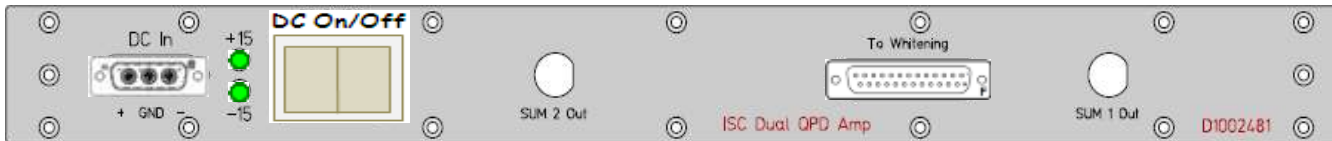

[S1102831](#)

Rear

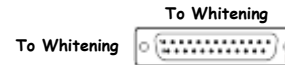

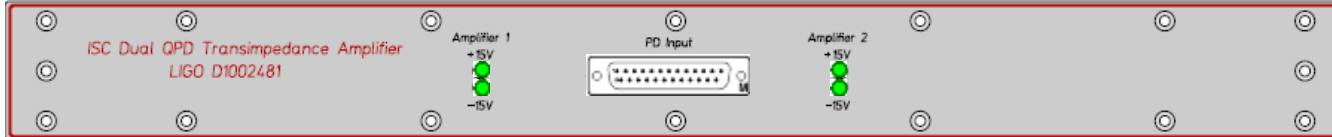

[D1002481](#)

Front

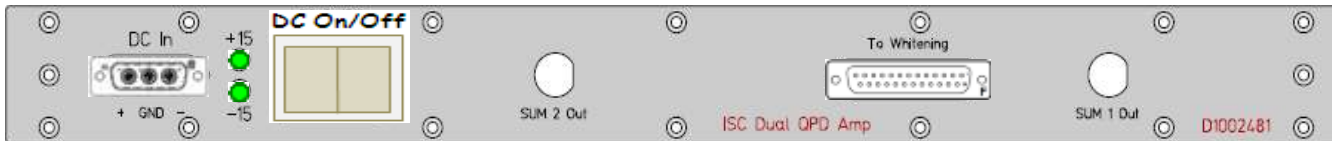

[S1102825](#)

Rear

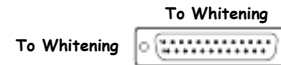



D1002559

Front

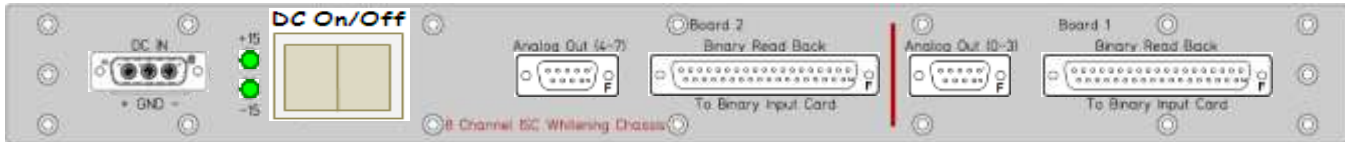
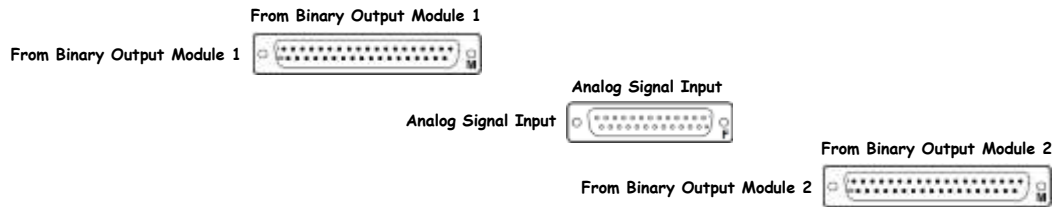

S1101165

Rear

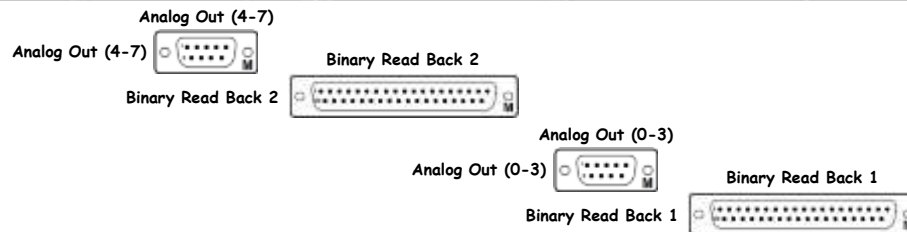

L1-PCAL-XR1 Details

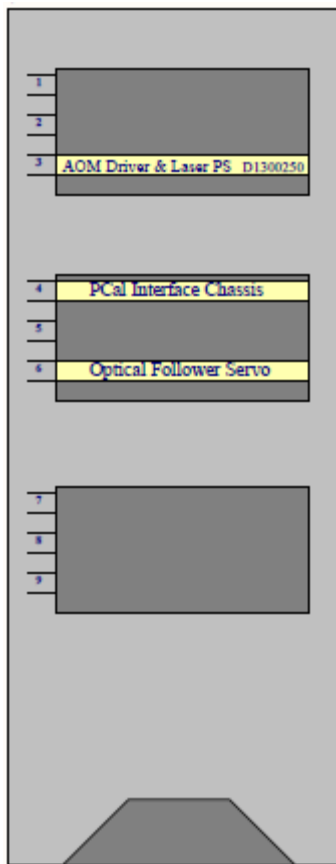

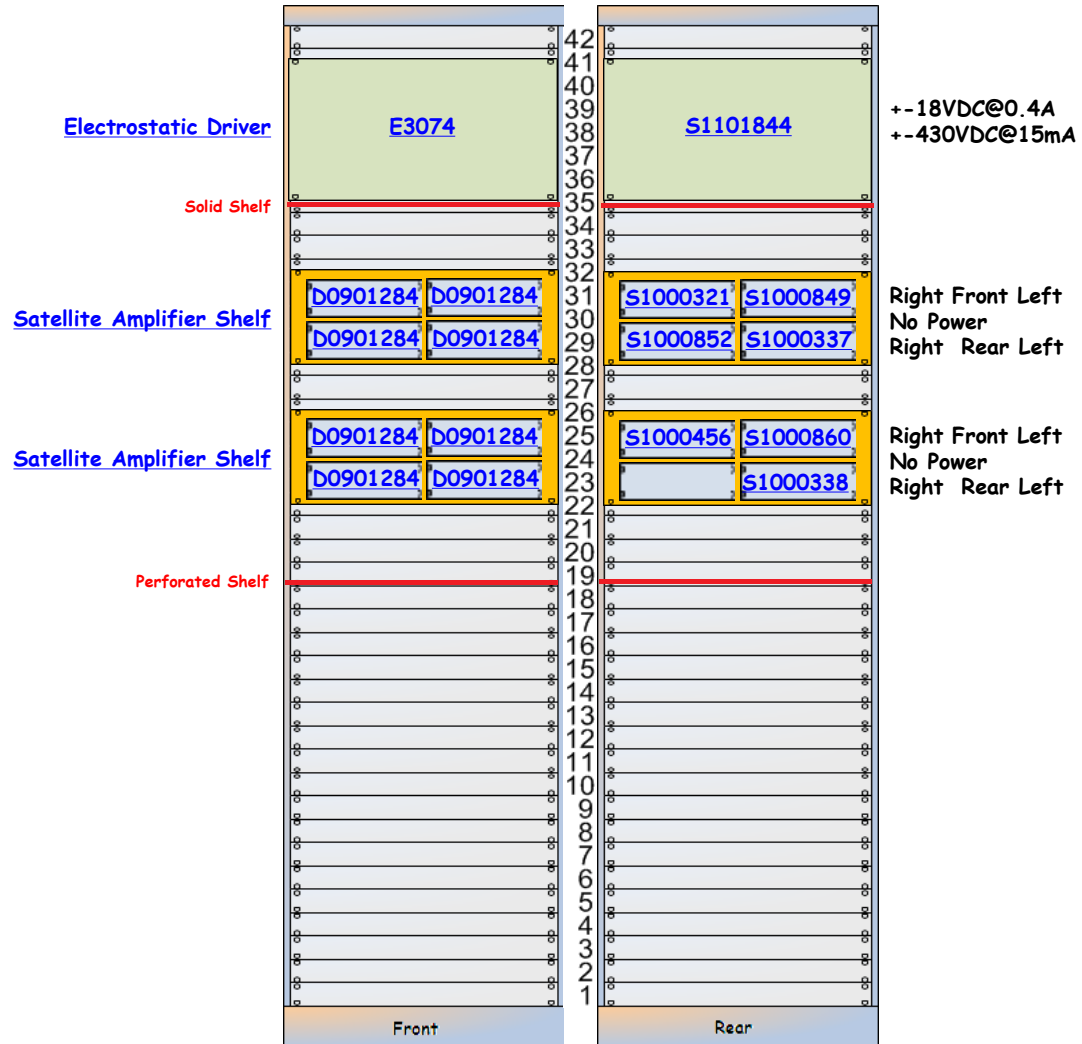

SUS-XR1 is part of [D1002741](#).

L1-SUS-XR1 Details

SUS-XR1 is part of [D1002741](#).

E3074 - S1101844

Electrostatic Driver

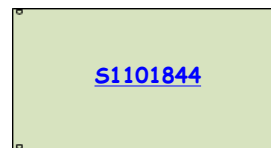
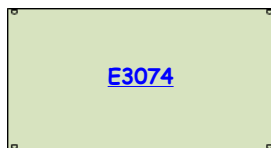

+ -18VDC@0.4A
+ -430VDC@15mA



E3074

Front



S1101844

Rear

<< L1-SUS-XR1

Satellite Amplifier Shelf

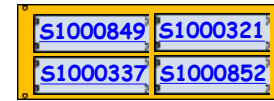
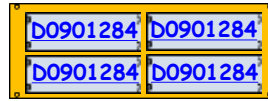

Right Front Left
No Power
Right Rear Left

Left



Right

<< L1-SUS-XR1

Satellite Amplifier Shelf

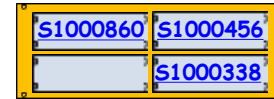
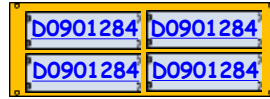

Right Front Left
No Power
Right Rear Left

Left



Right

L1-VAC-XR1 XEND Vacuum Rack Layout (Dxxxxxxx)

Marway MPD100 Power Distribution
 Power-Ten 3300D-3020 Switching DC Power Supply
 Power-Ten 3300D-3020 Switching DC Power Supply

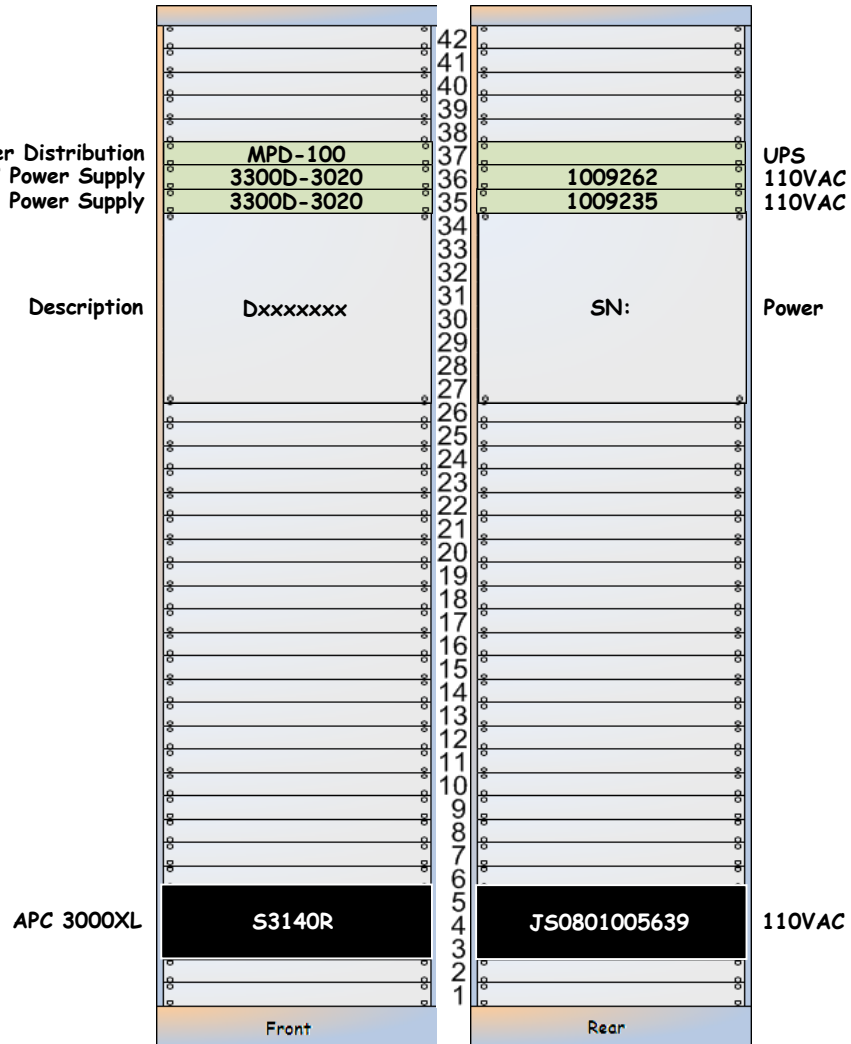

L1-VAC-XR1 Details

Marway MPD100 Power Distribution UPS

[<< L1-VAC-XR1](#)

Power-Ten 3300D-3020 Switching DC Power Supply 110VAC

<< [L1-VAC-XR1](#)

Description

Dxxxxxxx

SN:

Power

CentreCom 210TS



Grey CAT5 Cable
to CDS Network
Switch Port 17

APC 3000XL

S3140R

JS0801005639

110VAC

Particle Counter

- Located in Mechanical Room
- +24VDC comes from Power-Ten 1009235
- 485-25E - Telebyte - Cat5 - 162-262 Port 3

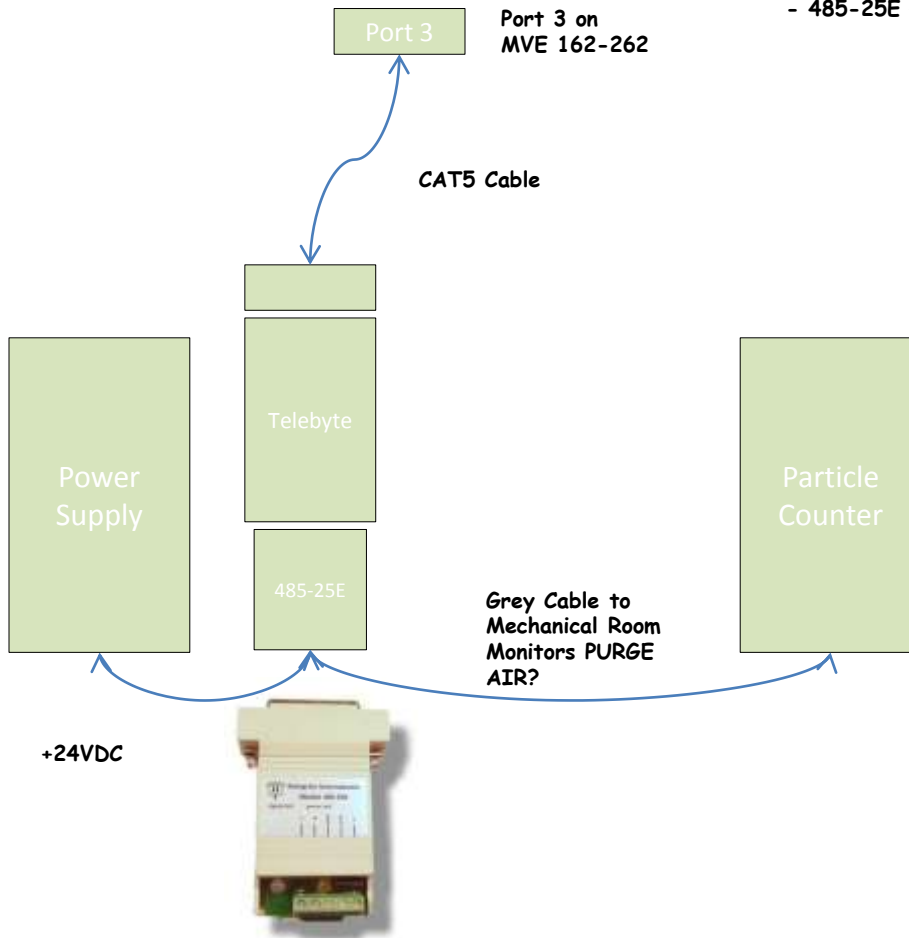

ISCBT4R is part of Exxxxxxx.

L1-ISCBT4R Panel Layout

[<< XEND Tables](#)

ISCBT4R Panel Layout ([D1201495](#))

End piece (Left)	D1100441-v3		D1100442-v3	MCL PZTs	Blank (double)	Blank (double)	Hartmann Wavefront Sensor	Blank (single)	ALS DC PD	Blank (single)	DC PD Power	Blank (single)	ALS Laser PZT	Blank (single)	ALS Modulation	Blank (single)	ALS Fiber	Blank (double)	ALS Cavity PD	Blank (quintuple)	ALS PLL	Blank (single)	End piece (Right)																					
Analog Video	D1100441-v3	D1100441-v3	D1100442-v3	D1201492-v1	D1101139-v2	D1101139-v2	D1200101-v5	D1101138-v2	D1000804-v2	D1101138-v2	D1101072-v2	D1101138-v2	D1100431-v4	D1101138-v2	D1200907-v1	D1101138-v2	D1100438-v2	D1101139-v2	D1100433-v5	D1100442-v3	D1200889-v1	D1101138-v2	D1100441-v3																					
	0	1	2	3	4	5	6	7	8	9	10	11	12	13	14	15	16	17	18	19	20	21	22	23	24	25	26	27	28	29	30	31	32	33	34	35	36	37	38	39	40	41	42	43

Left Side

End piece (Left)	D1100441-v3		D1201540-v1	Blank (quintuple)	Blank (quintuple)		Blank (undecuple)		Blank (single)	Pico Motors	ALS Shutters		Blank (undecuple)		End piece (Right)																													
Interlocks/Lighting	D1100441-v3	D1201540-v1	D1100442-v3	D1100442-v3	D1100443-v3		D1100443-v3		D1101138-v2	D1101691-v1	D1102369-v3		D1100443-v3		D1100441-v3																													
	0	1	2	3	4	5	6	7	8	9	10	11	12	13	14	15	16	17	18	19	20	21	22	23	24	25	26	27	28	29	30	31	32	33	34	35	36	37	38	39	40	41	42	43

Right Side

YMID

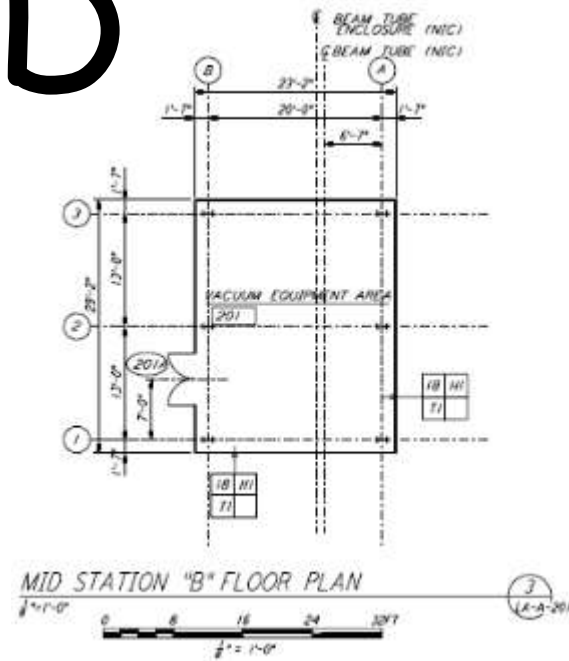
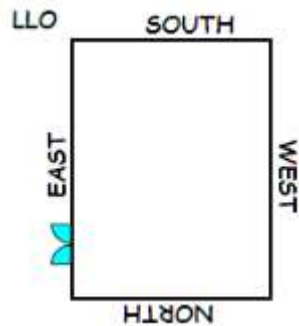

North Side View

East Side View

West Side View

South Side View

[YMID Layout](#)

[YMID Rack](#)

YMID Station Layout

[<< YMID Index](#)

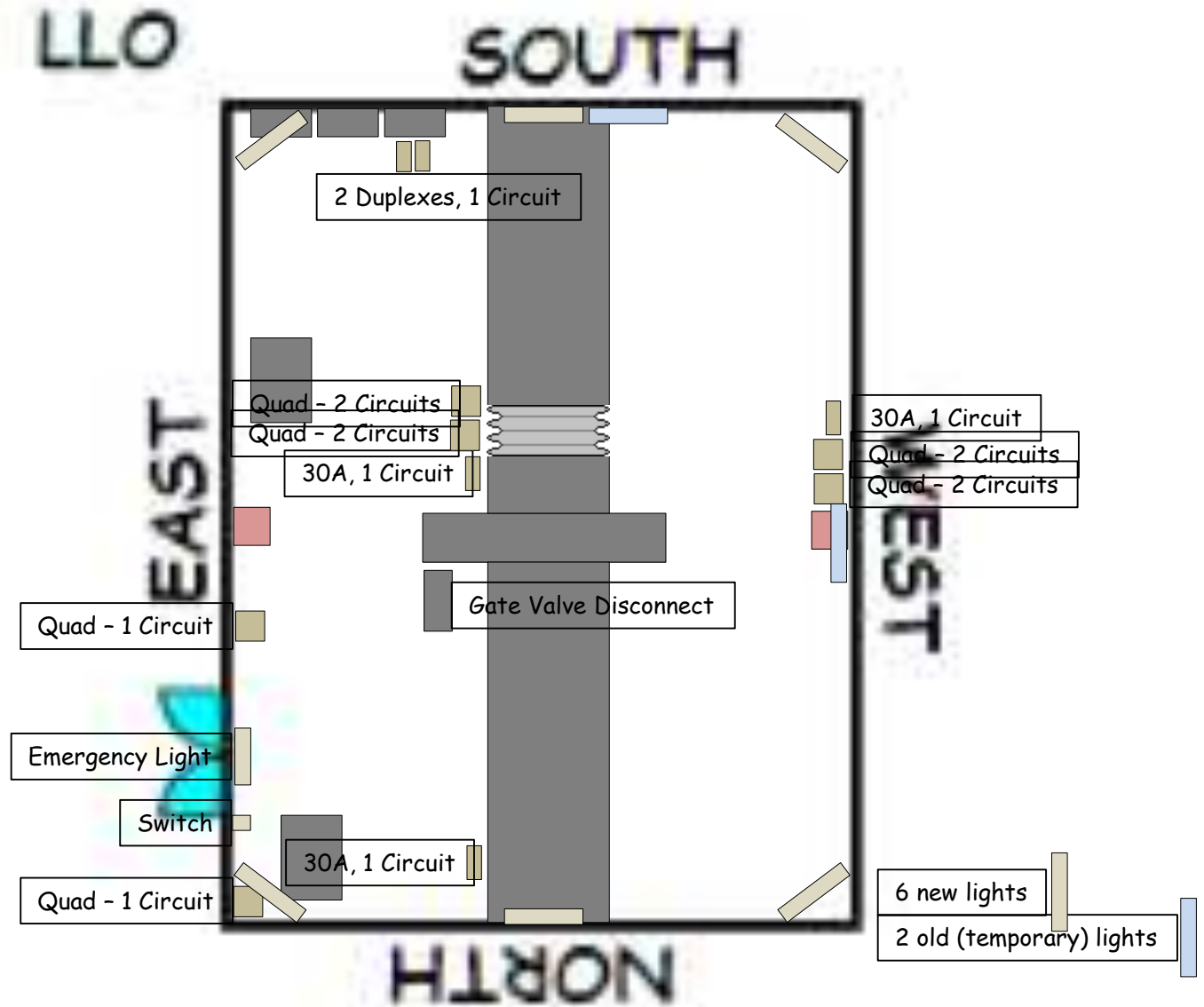



All SC
 6-Fiber Fiber Patch Blue Fiber (Marked 1610) to Cisco Port 4
 6-Fiber Fiber Patch Orange Fiber (Marked 1510) to Cisco Port 4
 6-Fiber Fiber Patch Green Fiber (Marked Extra) to Nothing
 6-Fiber Fiber Patch Brown Fiber (Marked Extra) to Nothing
 6-Fiber Fiber Patch Grey Fiber (Marked Extra) to Nothing
 6-Fiber Fiber Patch White Fiber (Marked Extra) to Nothing

TPE-111GI-A - Orange cable to Brocade AP650
 TPE-111GI-A - Blue CAT6 cable to Level One Media Converter

NetGear Port 1 - AcroMag
 NetGear Port 2 - Level One Media Converter
 NetGear Port 3 - Open
 NetGear Port 4 - Laptop Computer

All FC
 12-Fiber Fiber Patch Panel A1 to OPEN
 12-Fiber Fiber Patch Panel A2 to OPEN
 12-Fiber Fiber Patch Panel A3 to OPEN
 12-Fiber Fiber Patch Panel A4 to OPEN
 12-Fiber Fiber Patch Panel A5 to OPEN
 12-Fiber Fiber Patch Panel A6 to OPEN

 12-Fiber Fiber Patch Panel B is Not Present

 12-Fiber Fiber Patch Panel C1 to Level One Media Converter
 12-Fiber Fiber Patch Panel C2 to Level One Media Converter
 12-Fiber Fiber Patch Panel C3 to OPEN
 12-Fiber Fiber Patch Panel C4 to OPEN
 12-Fiber Fiber Patch Panel C5 to OPEN
 12-Fiber Fiber Patch Panel C6 to OPEN

 12-Fiber Fiber Patch Panel D is Not Present

AcroMag connected to Sensor



Brocade AP650	SN:	
Sorenson DCS33-33E	DCS33-33E	
6-Fiber Fiber Patch Panel	Xxxxxxxx	
TrendNet TPE-111GI-A	SN:	
Level One Media Converter	E100BTXFX05	
NetGear GS108	SN:	
Cisco ME3400	SN:	
12 SM Fiber Fiber Patch Panel from Corner Station	Xxxxxxxx	
AcroMag	SN:	
Sensor	SN:	
APC Smart UPS 1500	Xxxxxxx	



Gigabit Power over Ethernet (PoE) Injector TPE-111GI [V1.0R]

The Gigabit Power over Ethernet Injector (TPE-111GI) combines electrical power with a Gigabit network data signal to product a Gigabit Power over Ethernet (PoE) signal. Connect this device to a non-PoE switch and then run a Gigabit PoE cable for up to 100 meters (328 Ft.) to network most PoE devices.

No need to buy a PoE switch—use existing open ports from a non-PoE switch to network PoE devices. Save installation and equipment cost when installing TRENDnet PoE access points and IP cameras in remote locations. No need to install PoE devices near a power outlet. This compact device safeguards valuable network equipment with short circuit protection. Quickly create an integrated PoE and non-PoE network at Gigabit speeds.

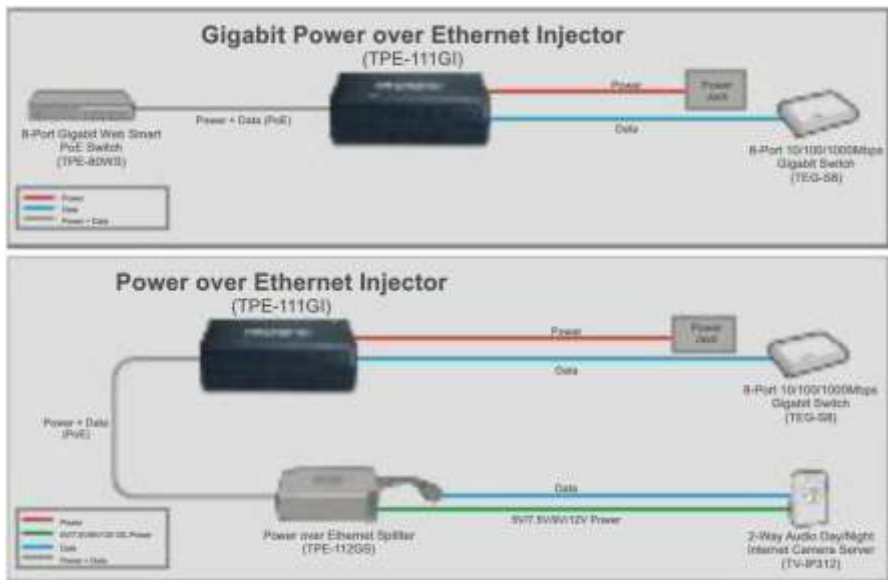

- << [LLO Corner Station](#)
- << [LLO Racks by AREA](#)
- << [LLO CDS Components](#)
- << [YEND Aerial](#)

YEND

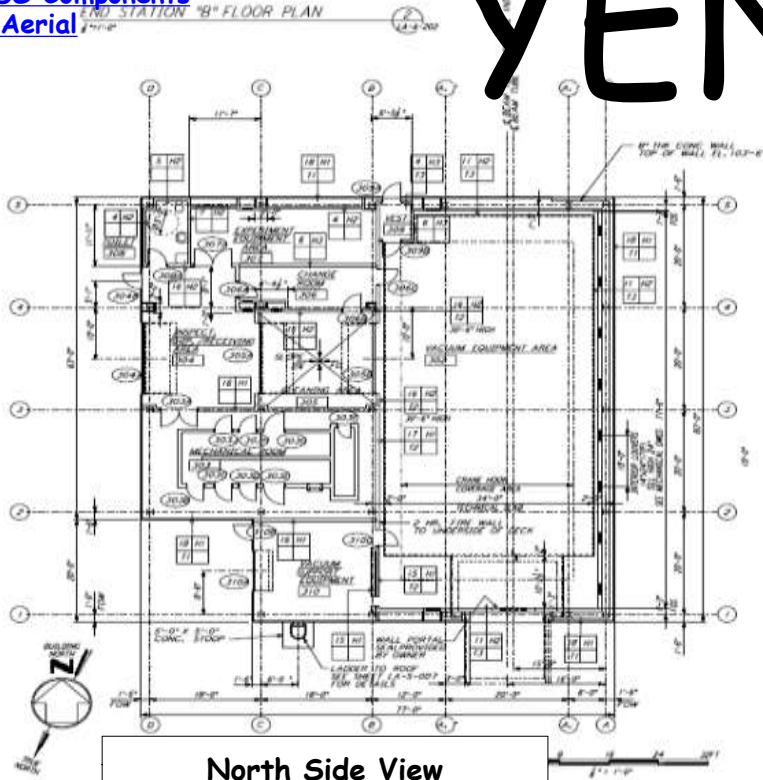

- North Side View
- East Side View
- West Side View
- [South Side View](#)

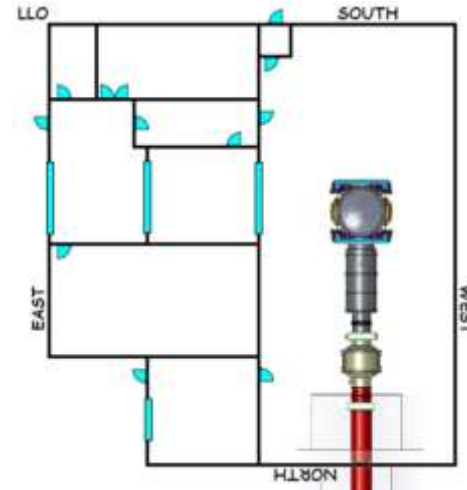

- YEND Layout
- [YEND Rack Layout](#)
- [VEAY Fiber Patch Panel](#)
- [YEND Roof Junction Box](#)

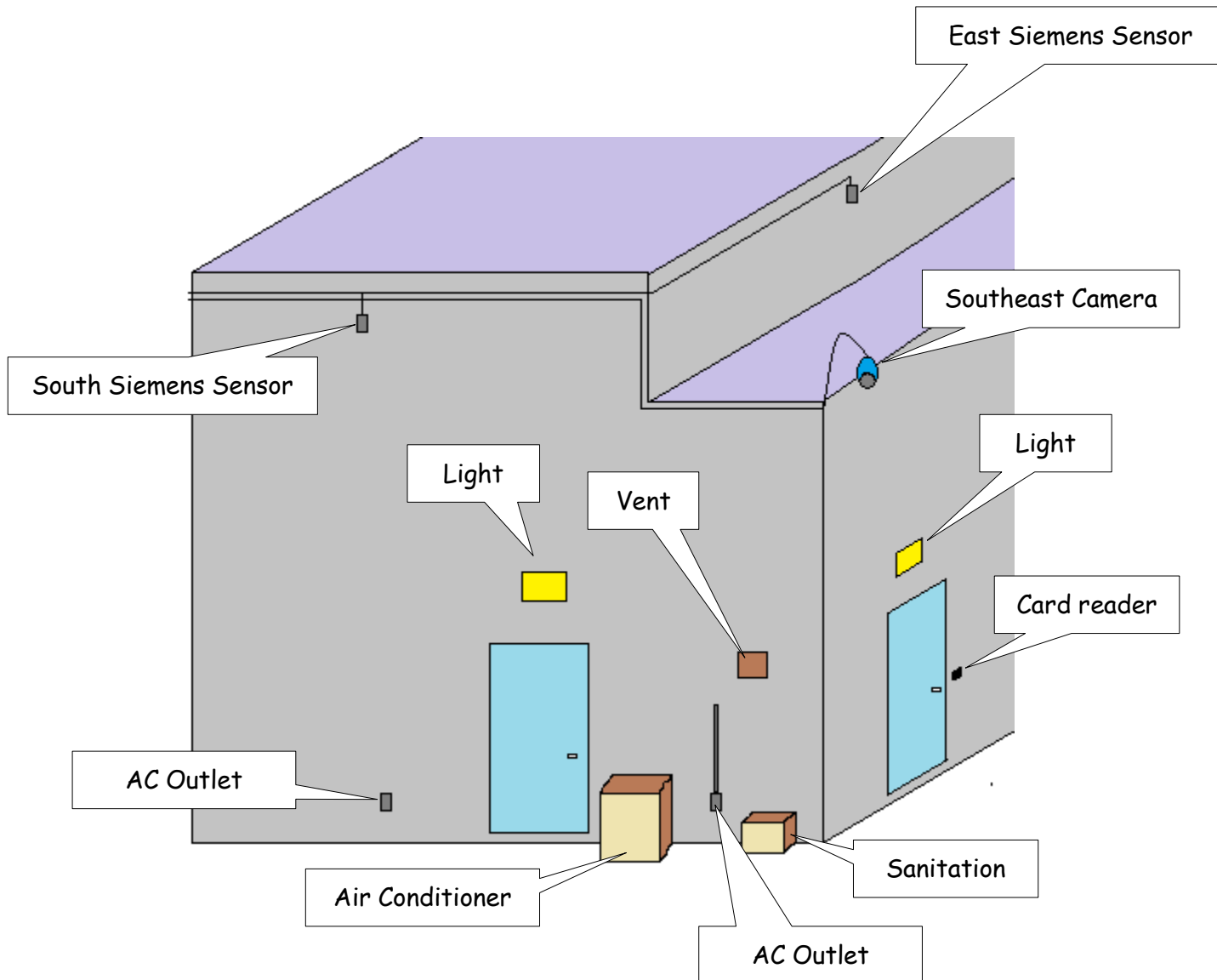

YEND Station Rack Layout

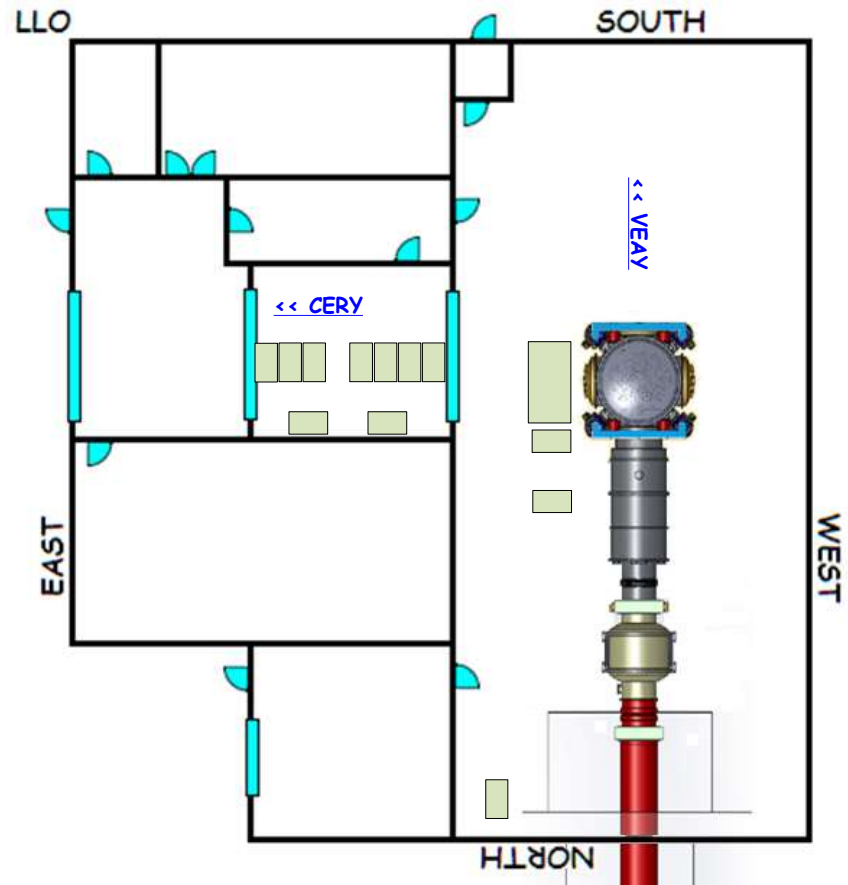

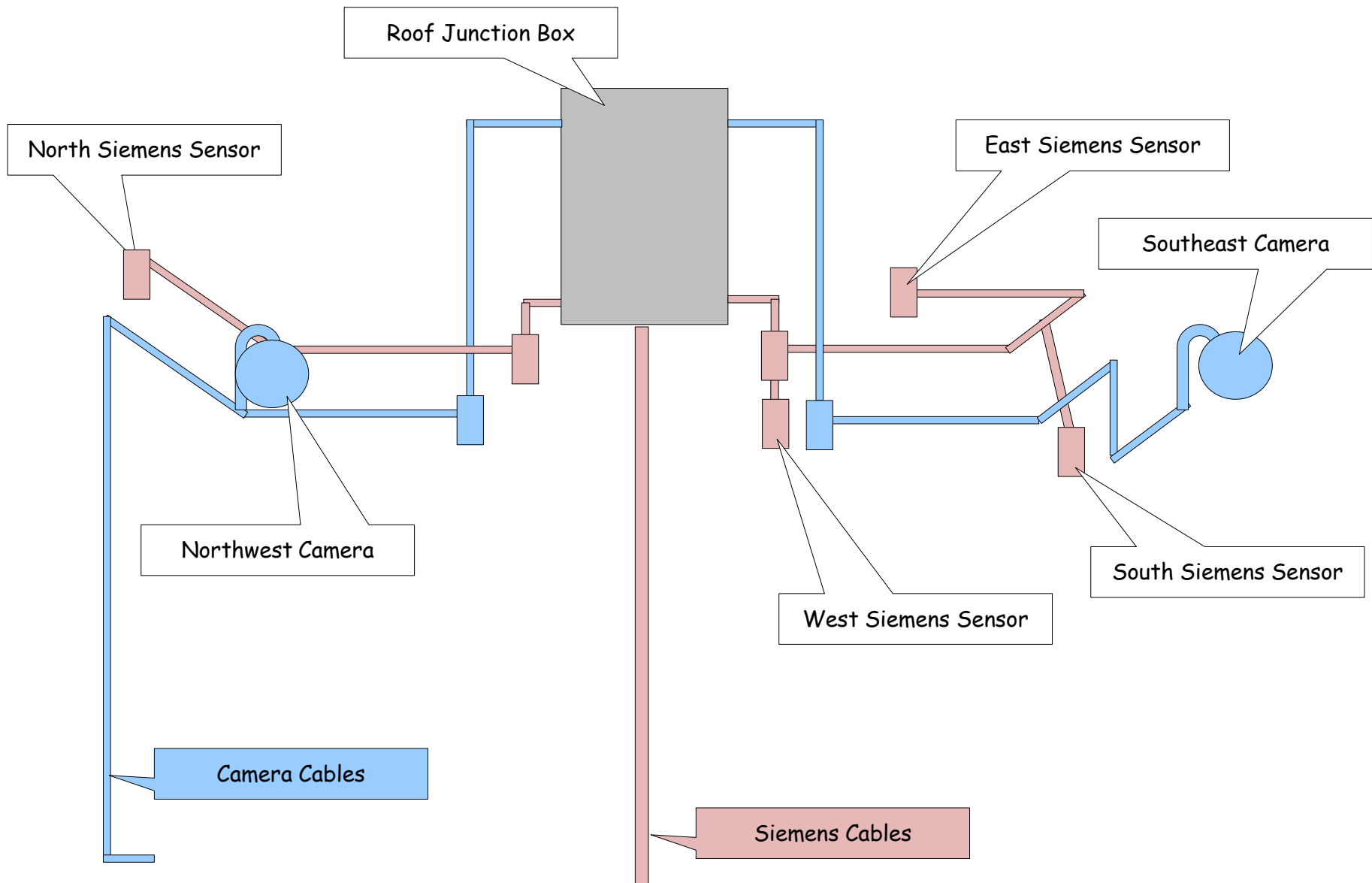

[<< LLO Racks by AREA](#)
[<< LLO Racks by Subsystems](#)

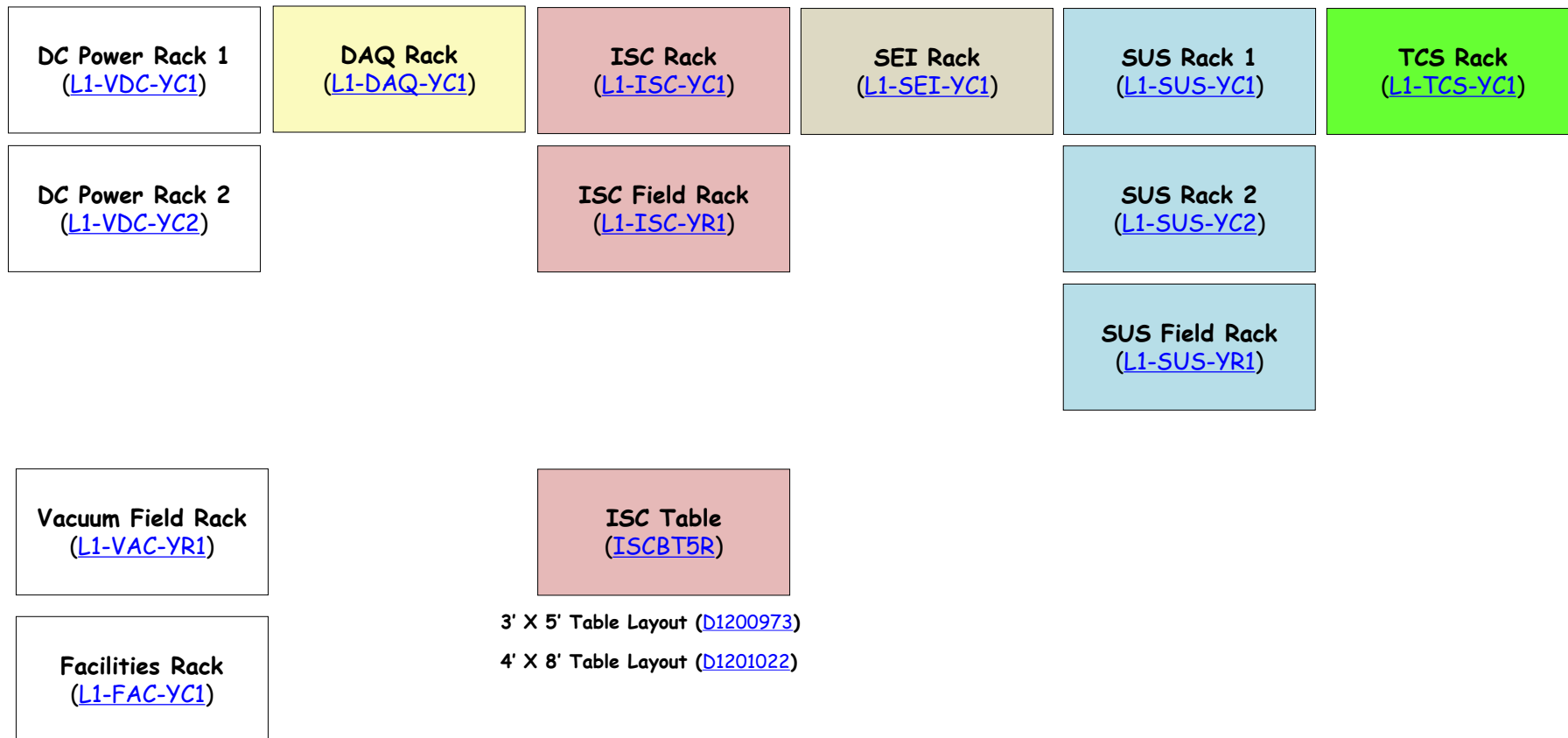

3' X 5' Table Layout ([D1200973](#))

4' X 8' Table Layout ([D1201022](#))

Corning WCH-06P Fiber Panel

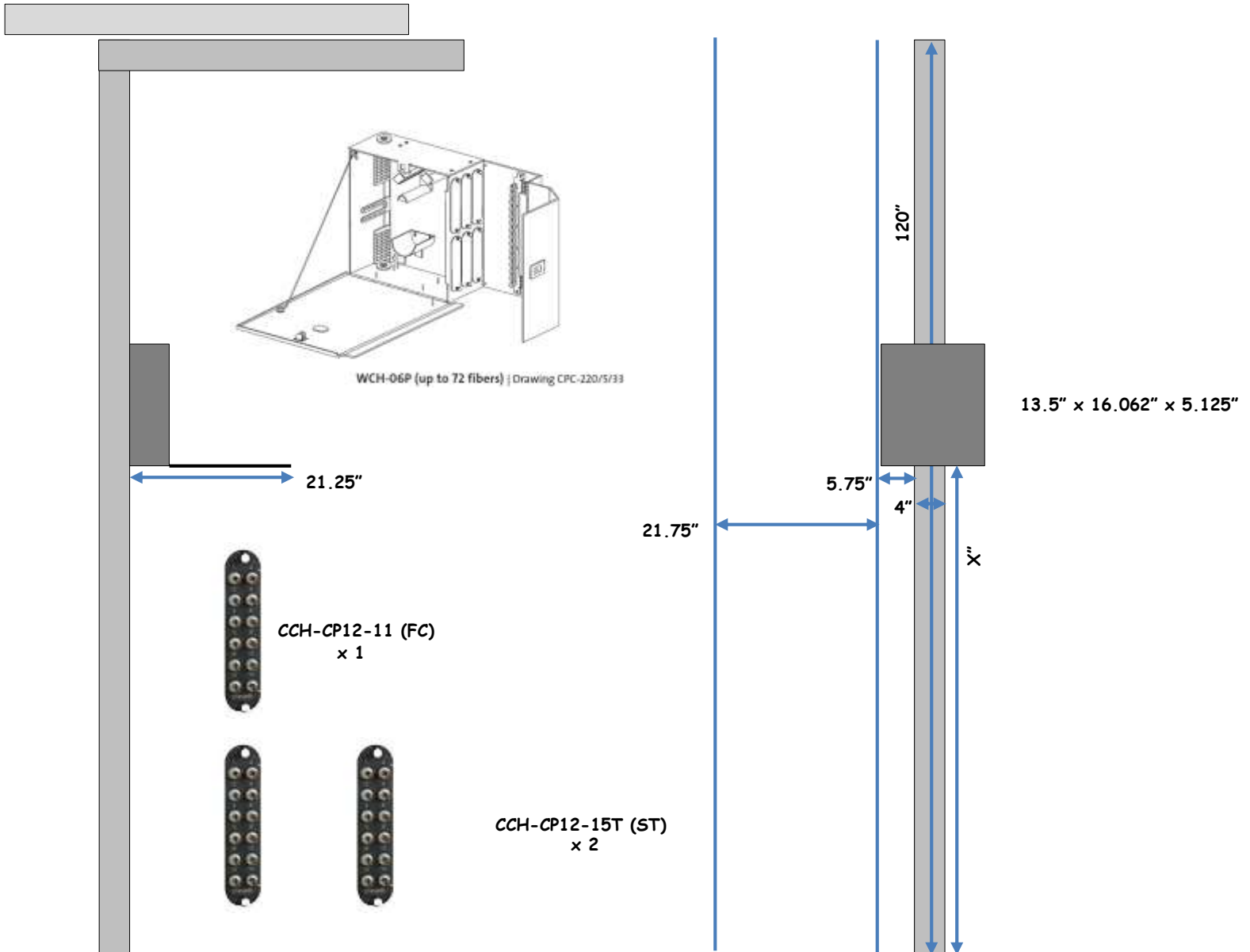

[<< YEND Index](#)
[<< MSR Patch Panel](#)

VEAY Fiber Patch Panel

Patch Panel

Patch Panel

No Power

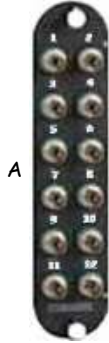

Port	Subjacket	Fiber	Label	Termination	Fiber Description	Outlying Destination
A01	Blue	B-Blue	Y-Fiber-21	LC	Itecaty SM1	L1-DAQ-YC1 D1100619 VERTEX Port
A02	Blue	A-Blue	Y-Fiber-05	LC	Ilanfey Port 21F	IP - 10.199.0.88 Netgear G5M7224 Port 21F
A03	Blue	B-Orange	Y-Fiber-01	ST	Phone In/Out	TR3030WDM - Extension 151
A04	Blue	A-Orange	Y-Fiber-06	LC	Ilanfey Port 21F	IP - 10.199.0.88 Netgear G5M7224 Port 21F
A05	Blue	Blue	Y-Fiber-24	LC	Timing UTC6-TCT	
A06	Blue	A-Green	Y-Fiber-10	LC	CDS G5624P Port 1F	IP - 10.199.0.21 G5624P Port 1F
A07	Blue	B-Brown	Empty		Empty	Bad Fiber
A08	Blue	A-Brown	Y-Fiber-09	LC	CDS G5624P Port 1F	IP - 10.199.0.21 G5624P Port 1F
A09	Blue	B-Grey	Y-Fiber-33	ST	ESTOP Comm TX to CER	From CERY to CER (1)
A10	Blue	A-Grey	Y-Fiber-15	LC	Ilfedagy Port 6	ACC 5595 Port 6
A11	Blue	B-White	Y-Fiber-29	ST	Video Cameras	VT5030
A12	Blue	A-White	Y-Fiber-16	LC	Ilfedagy Port 6	ACC 5595 Port 6

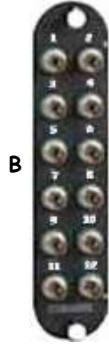

Port	Subjacket	Fiber	Label	Termination	Fiber Description	Outlying Destination
B01	Orange	E-Blue	Y-Fiber-08	LC	Ilnetfedagy Port 21F	IP - 10.199.0.14 Netgear G5M7224 Port 21F
B02	Orange	D-Blue	Y-Fiber-02	ST	Security Cameras	VT7430 - 2DRDT
B03	Orange	E-Orange	Y-Fiber-07	LC	Ilnetfedagy Port 21F	IP - 10.199.0.14 Netgear G5M7224 Port 21F
B04	Orange	D-Orange	Y-Fiber-32	ST	ESTOP Comm RX From CERY	From CER to CERY (3)
B05	Orange	E-Green	Y-Fiber-17	LC	GC 2402 Port 26F	IP - 197.168.253.30 GC 2402 Port 26F
B06	Orange	D-Green	Y-Fiber-18	LC	GC 2402 Port 26F	IP - 197.168.253.30 GC 2402 Port 26F
B07	Orange	E-Brown	Empty		Empty	Bad Fiber
B08	Orange	D-Brown	Y-Fiber-22	LC	Itecaty SM1	L1-DAQ-YC1 D1100619 VERTEX Port
B09	Orange	E-Grey	Y-Fiber-31	FC	ALS Light	ALS:FDC-YEND (To ISCBT5R)
B10	Orange	D-Grey	Y-Fiber-13	LC	D070011 INPUT Port	L1-TCS-YC1 D070011 INPUT Port
B11	Orange	Black	Y-Fiber-25	FC	Timing UTC6-TCT	(Reserved for ALS Light spare - if needed)
B12	Orange	D-White	Y-Fiber-14	LC	D070011 INPUT Port	L1-TCS-YC1 D070011 INPUT Port



4/11/2013		ENDY Fiber Patch			To Y-2-E (TriNet)	
Port	Type	Fiber	Type	Designation	Description	
D1	ST	Y-Fiber-27	ST	Trinet Converter	GC 2402 P9	
D2	ST	Y-Fiber-28	ST	Trinet Converter	GC 2402 P9	
D3	ST	Empty				
D4	ST	Y-Fiber-23	ST	Fibox	FIBOX	
D5	ST	Empty				
D6	ST	Empty				
D7	ST	Y-Fiber-25	ST	Trinet Converter	GC 2402 P11	
D8	ST	Y-Fiber-26	ST	Trinet Converter	GC 2402 P11	
D9	ST	Empty				
D10	ST	Empty				
D11	ST	Empty				
D12	ST	Empty				

A - FC Connectors
 B - FC Connectors
 C - NO Connectors
 D - ST Connectors
 E - NO Connectors
 F - LC Connectors

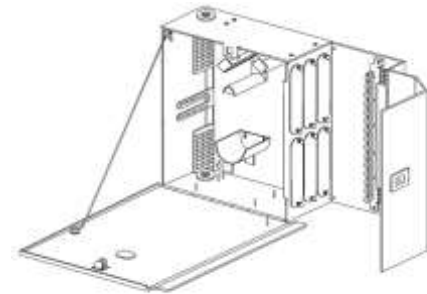

WCH-06P (up to 72 fibers) | Drawing CPC-220/57/33

[Y-2-E \(TriNet\)](#)



4/11/2013		ENDY Fiber (SM) Patch			To S.R. House	
Port	Type	Fiber	Type	Designation	Description	
F1	LC	Y-Fiber-19, 20	LC	Off-site Internet	GC 2402 Port 25F	
F2	LC	Empty				
F3	LC	Empty				
F4	None	Empty				
F5	None	Empty				
F6	None	Empty				

[See LIGO-E1500002](#)

[X END Fiber Patch Panel >>](#)

It is 65' from the L1-FAC-YC1 Rack to the knee of the waterfall in the VEAY.

([D1201231 \(YEND Cable Tray\)](#))

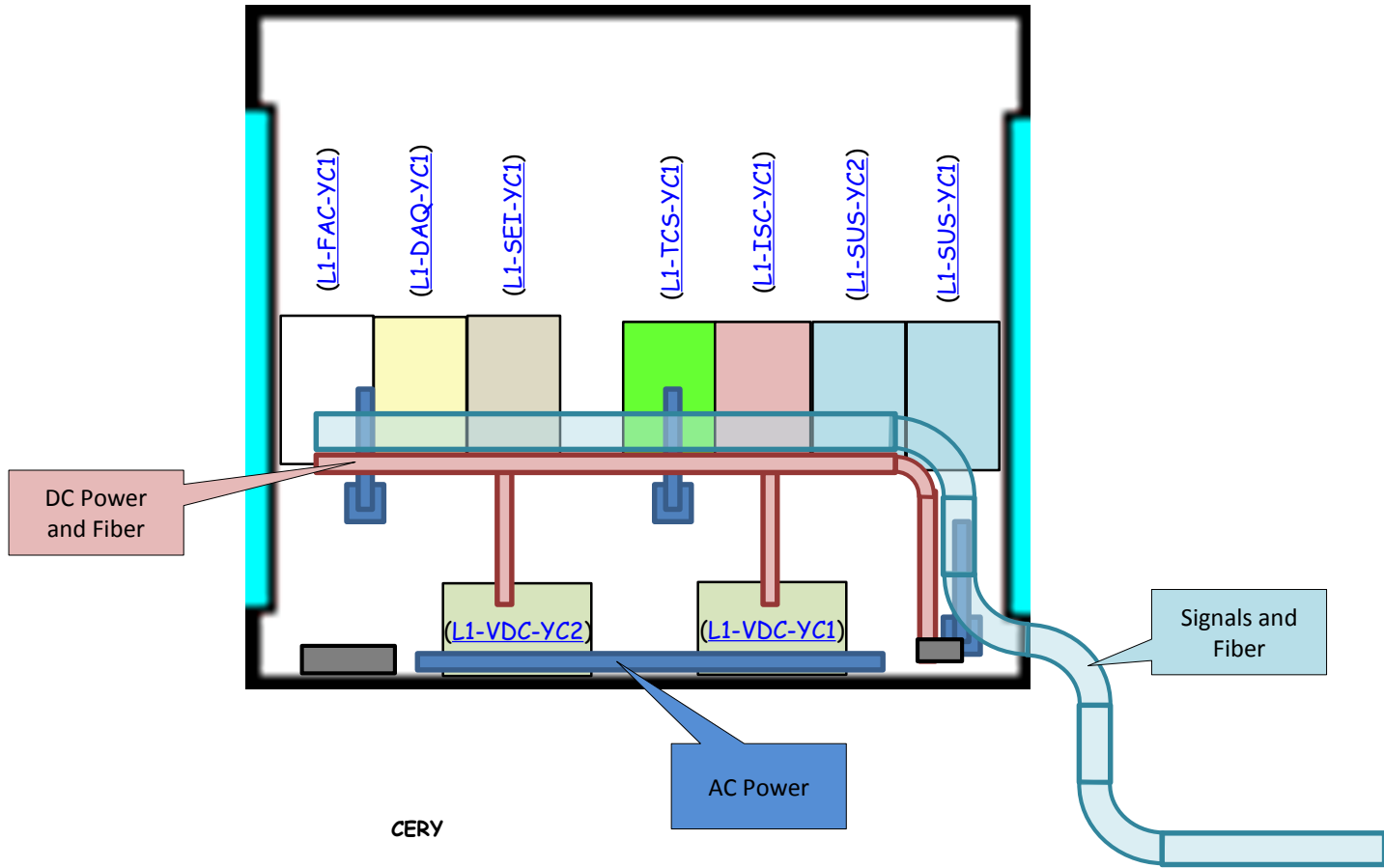

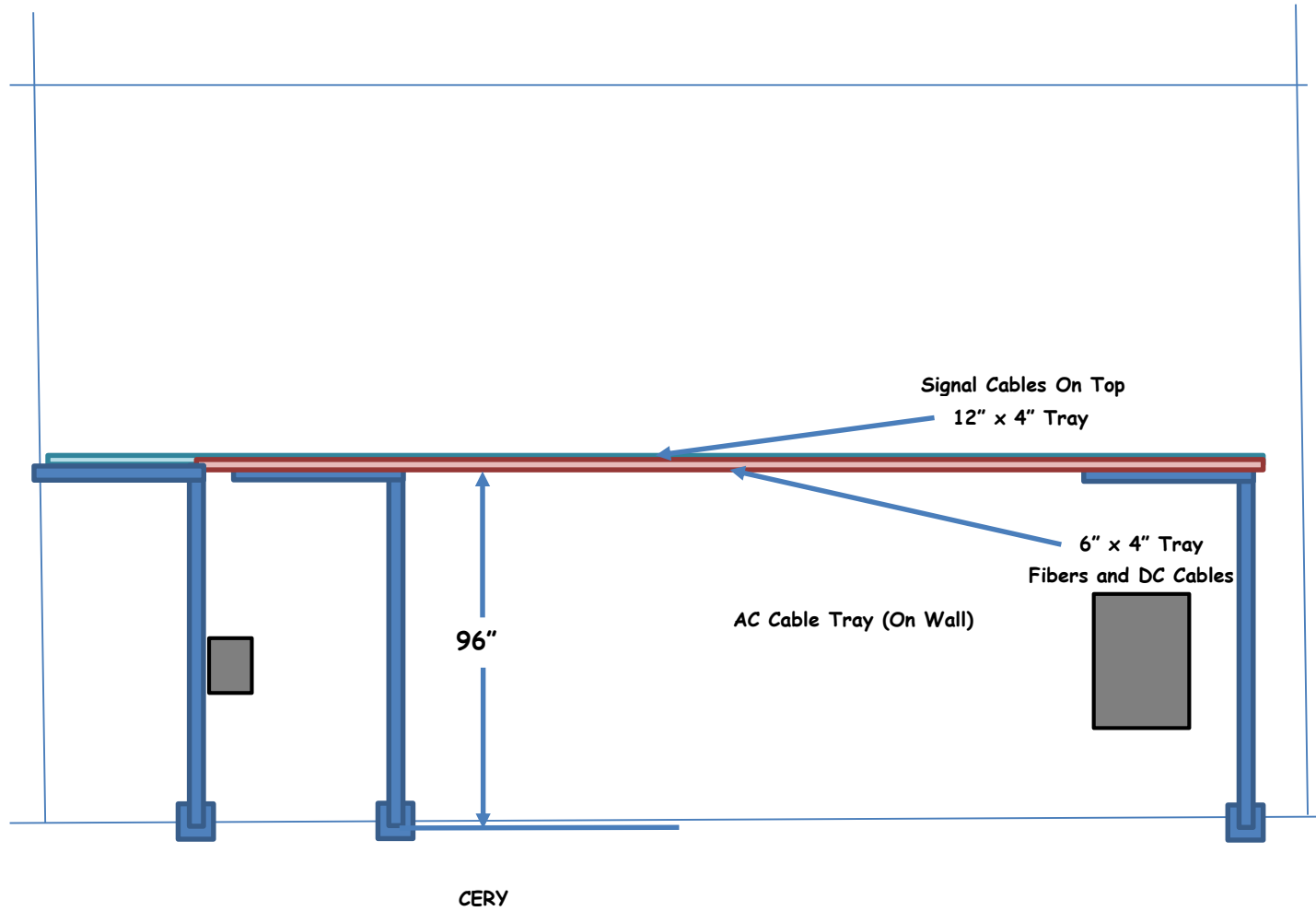

L1-VDC-YC1 Power Racks - VEAY Field Supplies

<< [CERY Racks](#)
 << [YEND Racks and Tables](#)

L1-VDC-YC1 YEND Station DC Power Rack Layout ([D1200899](#)) ([S1202313](#))



[Cable Runs >>](#)

L1-VDC-YC1 Cable Runs

<< [L1-VDC-YC1](#)

L1-VDC-YC1 YEND Station DC Cable Runs ([D1200899](#)) ([S1202313](#))

L1-VDC-YC1 S1202313	Power Panel	Circuit	DC Power Rack	Outlet	Plug Position	Rack U	Power Supply Model	Power Supply Serial	Polarity	DC Extension Cable	Electronics Rack	Cable Length	DC Power Strip
1	CDS-Y		L1-VDC-YC1	8	Top	U37-A (Left)							
2	CDS-Y		L1-VDC-YC1	8	Bottom	U37-B (Right)							
3	CDS-Y		L1-VDC-YC1	2	Top	U33-A (Left)	JQE 15V 12A	H114646	Plus	PTG	L1-AOS-PCAL	76	None
4	CDS-Y		L1-VDC-YC1	2	Bottom	U33-B (Right)	JQE 15V 12A	H114641	Minus	PTG	L1-AOS-PCAL	76	None
5	CDS-Y		L1-VDC-YC1	9	Top	U29-A (Left)	BHK 500V 80mA	A107268	Plus	PBX-004	L1-AOS		
6	CDS-Y		L1-VDC-YC1	9	Bottom	U29-B (Right)	BHK 500V 80mA	A107263	Minus	PBX-004	L1-AOS		
7	CDS-Y		L1-VDC-YC1	3	Top	U25-A (Left)	JQE 25V 20A	H236441	Plus	PTO-063	L1-ISC-YR1	50	PSO-xxx
8	CDS-Y		L1-VDC-YC1	3	Bottom	U25-B (Right)	JQE 25V 20A	H236428	Minus	PTO-063	L1-ISC-YR1	50	PSO-xxx
9	CDS-Y		L1-VDC-YC1	10	Top	U21-A (Left)	JQE 25V 10A	H207939	Plus	PTY-056	L1-ISC-YR1	50	PSY-xxx
10	CDS-Y		L1-VDC-YC1	10	Bottom	U21-B (Right)	JQE 25V 10A	H207941	Minus	PTY-056	L1-ISC-YR1	50	PSY-xxx
11	CDS-Y		L1-VDC-YC1	4	Top	U17-A (Left)	JQE 15-12A		Plus		PEM-VEA	76	PSG-xxx
12	CDS-Y		L1-VDC-YC1	4	Bottom	U17-B (Right)	JQE 15-12A		Minus		PEM-VEA	76	PSG-xxx
13	CDS-Y		L1-VDC-YC1	11	Top	U13-A (Left)							
14	CDS-Y		L1-VDC-YC1	11	Bottom	U13-B (Right)							
15	CDS-Y		L1-VDC-YC1	5	Top	U09-A (Left)							
16	CDS-Y		L1-VDC-YC1	5	Bottom	U09-B (Right)							
17	CDS-Y		L1-VDC-YC1	12	Top	U05-A (Left)							
18	CDS-Y		L1-VDC-YC1	12	Bottom	U05-B (Right)							
19	CDS-Y		L1-VDC-YC1	6	Top	U01-A (Left)							
20	CDS-Y		L1-VDC-YC1	6	Bottom	U01-B (Right)							
D1200899													

L1-VDC-YC2 Power Racks - VEAY Supplies

<< [CERY Racks](#)
 << [YEND Racks and Tables](#)

L1-VDC-YC2 YEND Station DC Power Rack Layout ([D1200900](#)) ([S1202314](#))



[Cable Runs >>](#)

L1-VDC-YC2 Cable Runs

<< [L1-VDC-YC2](#)

L1-VDC-YC2 YEND Station DC Cable Runs ([D1200900](#)) ([S1202314](#))

L1-VDC-YC2 S1202314	Power Panel	Circuit	DC Power Rack	Outlet	Plug Position	Rack U	Power Supply Model	Power Supply Serial	Polarity	DC Extension Cable	Electronics Rack	Cable Length	DC Power Strip
1	CDS-Y		L1-VDC-YC2	8	Top	U37-A (Left)							
2	CDS-Y		L1-VDC-YC2	8	Bottom	U37-B (Right)							
3	CDS-Y		L1-VDC-YC2	2	Top	U33-A (Left)	JQE 25V 10A	H222056	Minus	PTY-052	L1-ISC-YC1	30	PSY-xxx
4	CDS-Y		L1-VDC-YC2	2	Bottom	U33-B (Right)	JQE 15V 6A JQE 15V 6A	H214466 H214326	Plus Minus	PTG-004	L1-ISC-YC1	30	PSG-005
5	CDS-Y		L1-VDC-YC2	9	Top	U29-A (Left)	JQE 25V 20A	H236414	Plus	PTO-050	L1-SUS-YC2	30	PSO-050
6	CDS-Y		L1-VDC-YC2	9	Bottom	U29-B (Right)	JQE 25V 20A	H236422	Minus	PTO-050	L1-SUS-YC2	30	PSO-050
7	CDS-Y		L1-VDC-YC2	3	Top	U25-A (Left)	JQE 25V 20A	H236504	Plus	PTO-051	L1-SUS-YC1	32	PSO-051
8	CDS-Y		L1-VDC-YC2	3	Bottom	U25-B (Right)	JQE 25V 20A	H236513	Minus	PTO-051	L1-SUS-YC1	32	PSO-051
9	CDS-Y		L1-VDC-YC2	10	Top	U21-A (Left)	JQE 25V 20A	H236508	Plus	PTO-052	L1-ISC-YC1 L1-TCS-YC1	28	PSO-052
10	CDS-Y		L1-VDC-YC2	10	Bottom	U21-B (Right)	JQE 25V 20A	H236516	Minus	PTO-052	L1-ISC-YC1 L1-TCS-YC1	28	PSO-052
11	CDS-Y		L1-VDC-YC2	4	Top	U17-A (Left)	JQE 25V 20A	H236503	Plus	PTY-040	L1-ISC-YC1 L1-TCS-YC1	28	PSY-040
12	CDS-Y		L1-VDC-YC2	4	Bottom	U17-B (Right)	JQE 25V 20A	H236488	Minus	PTY-040	L1-ISC-YC1 L1-TCS-YC1	28	PSY-040
13	CDS-Y		L1-VDC-YC2	11	Top	U13-A (Left)	JQE 25V 20A	H236500	Plus	PTO-053	L1-SEI-YC1	22	PSO-053
14	CDS-Y		L1-VDC-YC2	11	Bottom	U13-B (Right)	JQE 25V 20A	H236520	Minus	PTO-053	L1-SEI-YC1	22	PSO-053
15	CDS-Y		L1-VDC-YC2	5	Top	U09-A (Left)	JQE 25V 20A	H236519	Plus	PTY-041	L1-SEI-YC1	22	PSY-041
16	CDS-Y		L1-VDC-YC2	5	Bottom	U09-B (Right)	JQE 25V 20A	H236487	Minus	PTY-041	L1-SEI-YC1	22	PSY-041
17	CDS-Y		L1-VDC-YC2	12	Top	U05-A (Left)	JQE 25V 20A	H236502	Plus	PTY-042	L1-ISC-YC1	30	PSY-042
18	CDS-Y		L1-VDC-YC2	12	Bottom	U05-B (Right)	JQE 25V 20A	H236518	Plus	PTY-043	L1-SEI-YC1	22	PSY-043
19	CDS-Y		L1-VDC-YC2	6	Top	U01-A (Left)	JQE 25V 20A	H236521	Plus	PTY-044	L1-SUS-YC2	32	PSY-044
20	CDS-Y		L1-VDC-YC2	6	Bottom	U01-B (Right)	JQE 25V 20A	H236507	Plus	PTY-045	L1-SUS-YC1	32	PSY-045
D1200900													

<< [CERY Racks](#)
 << [YEND Racks and Tables](#)

L1-DAQ-YC1 YEND Station Remote Rack Layout ([D1201092](#)) ([S1202956](#))

Serial to Internet Converter

[Dolphin RFM Switch](#)
[ACC 5595 Reflective Memory Hub](#)
[l1netfedaqy 10.199.0.88](#)
[l1lanfey 10.199.0.14](#)
 Solid Shelf
[Timing IRIG-B Interface Chassis](#)
[Serial Concentrator Chassis](#)
[Beckhoff End Link](#)
 Perforated Shelf
[ATEN KVM Switch](#)
[l1susauxey Front End Computer 10.110.140.58](#)
[l1susey Front End Computer 10.110.140.57](#)
[l1seiey Front End Computer 10.110.140.56](#)
[l1isecy Front End Computer 10.110.140.55](#)
[l1ecatyl1 Beckhoff Host Computer ???.???.???.??](#)
[l1hwsyl1 Hartmann Sensor Computer 10.110.130.23](#)
[UPS Group 1 and Group 2](#)

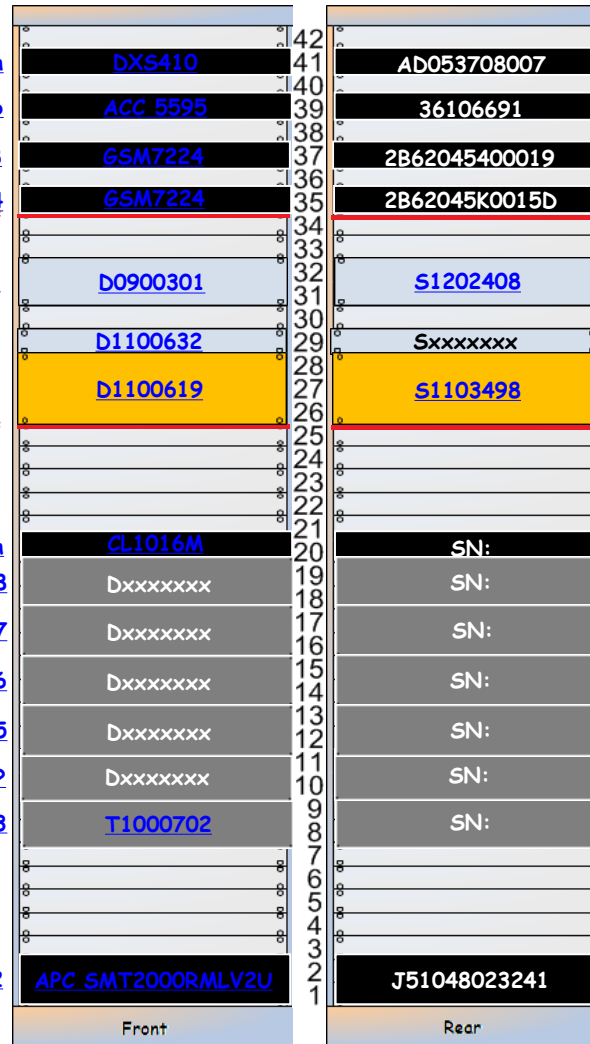

UPS2
 UPS2
 UPS2
 UPS2
 +12VDC (from FAC)
 ±18VDC
 +24VDC
 UPS2
 UPS1 & 110VAC
 UPS1 & 110VAC
 UPS1 & 110VAC
 UPS1 & 110VAC
 UPS1 & 110VAC
 UPS1 & 110VAC
 UPS1 & 110VAC
 110VAC



L1-DAQ-YC1 Details

<< L1-DAQ-YC1

Dolphin RFM Switch

DXS410

AD053708007

UPS2



ACC 5595

Front

To l1lanfey port 5

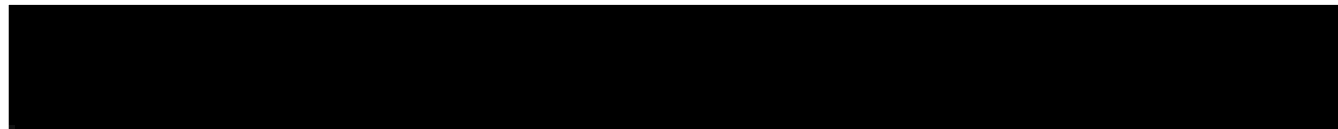

AD053708007

Rear

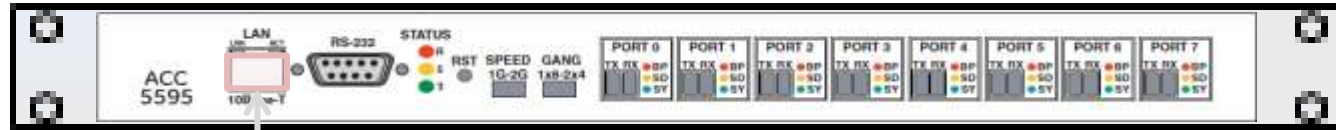

ACC 5595

Front

To L1lanfey port 5



36106691

Rear

To UPS Power Strip

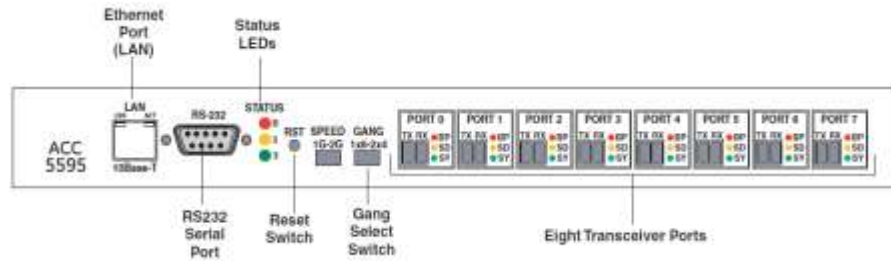



GSM7224

Front
C0:3F:0E:86:84:04

2 - To FE NET Port

21F - To 1Y23 PP E1, E2



2B62045400019

Rear

To UPS Power Strip

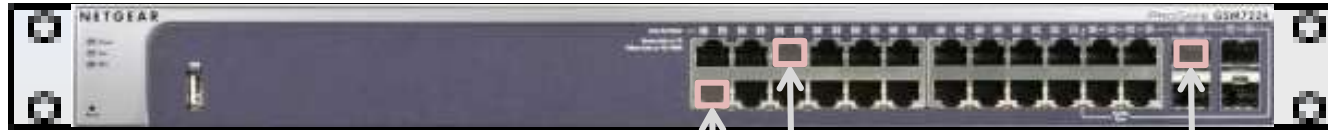

GSM7224

Front

CO:3F:0E:86:89:14

2 - To FE LAN Port

5 - To 5595 LAN 10BaseT

21F - To 1Y23 PP A1, A2



2B62045K0015D

Rear

To UPS Power Strip

<< L1-DAQ-YC1

Timing IRIG-B Interface Chassis

D0900301

S1202408

Power

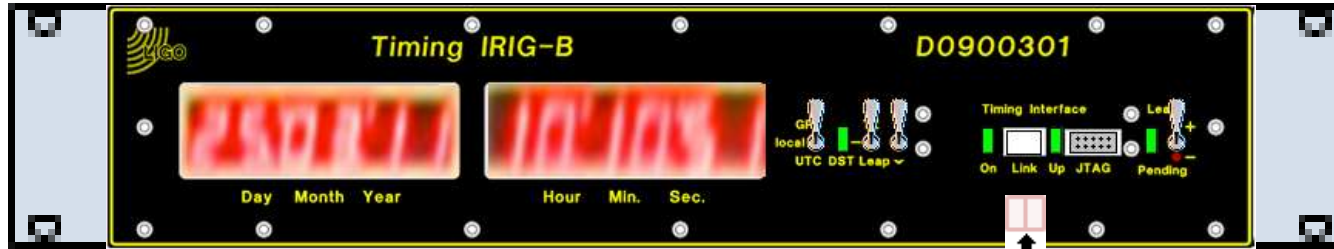

D0900301

Front

Timing Fanout (No Label)

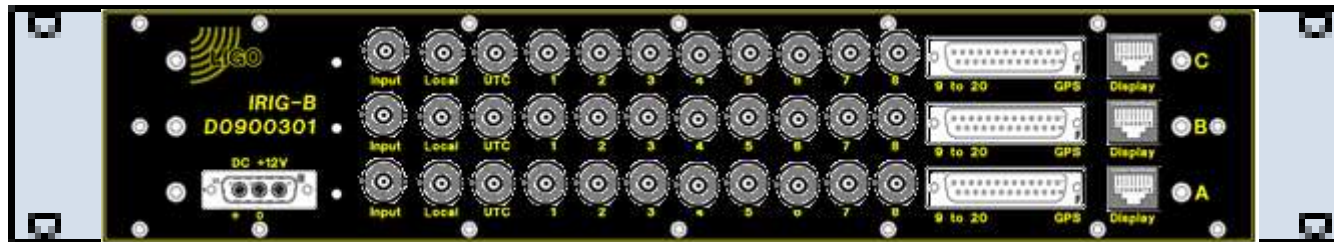

S1202408

Rear



D1100632

Front

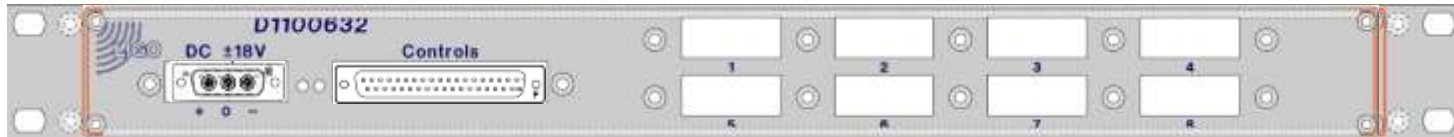

Sxxxxxxx

Rear



<< L1-DAQ-YC1

Beckhoff End Link

D1100619

S1103498

+24VDC

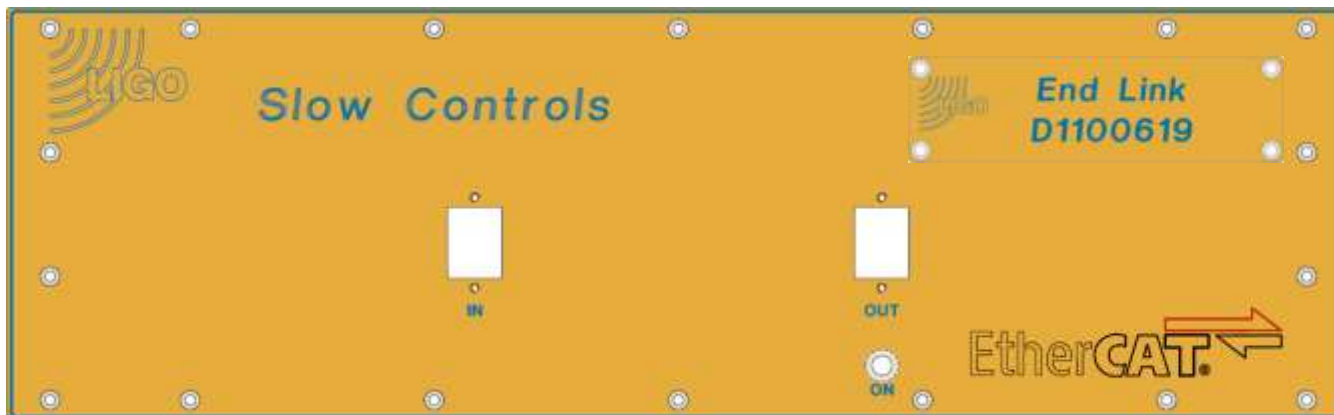

D1002961

Front: D0902553

Name: D1100667

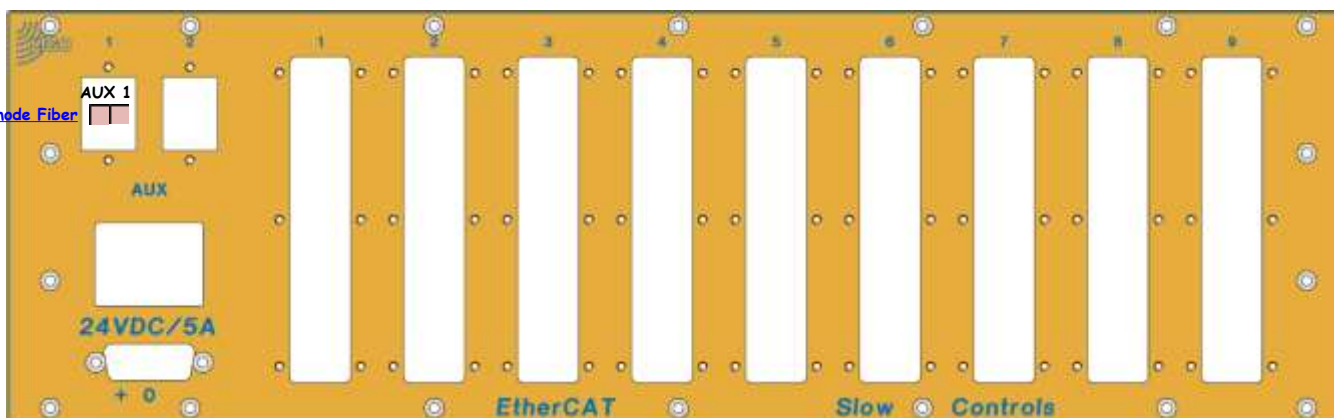

End Link Multimode Fiber

S1103498

Rear: D0902554

End Link Single Mode Fiber VERTEX

<< L1-DAQ-YC1

ATEN KVM Switch

CL1016M

SN:

110VAC



l1susauxey Front End

l1susauxey Front End Computer 10.110.140.58

Dxxxxxxx

SN:

UPS1 & 110VAC

[<< L1-DAQ-YC1](#)

l1ecaty1 Beckhoff Host Computer ???.???.???.??

Dxxxxxxx

SN:

UPS1 & 110VAC

APC SMX2000RMLV2U

UPS

APC SMX2000RMLV2U

J51048023241

110VAC



[APC SMX2000RMLV2U](#)

Front



J51048023241

Rear

[To UPS Power Strip](#)

L1-FAC-YC1

<< [CERY Racks](#)
 << [YEND Racks and Tables](#)

L1-FAC-YC1 Facilities YEND Station Remote Rack Layout ([D1201093](#)) ([S1202957](#))

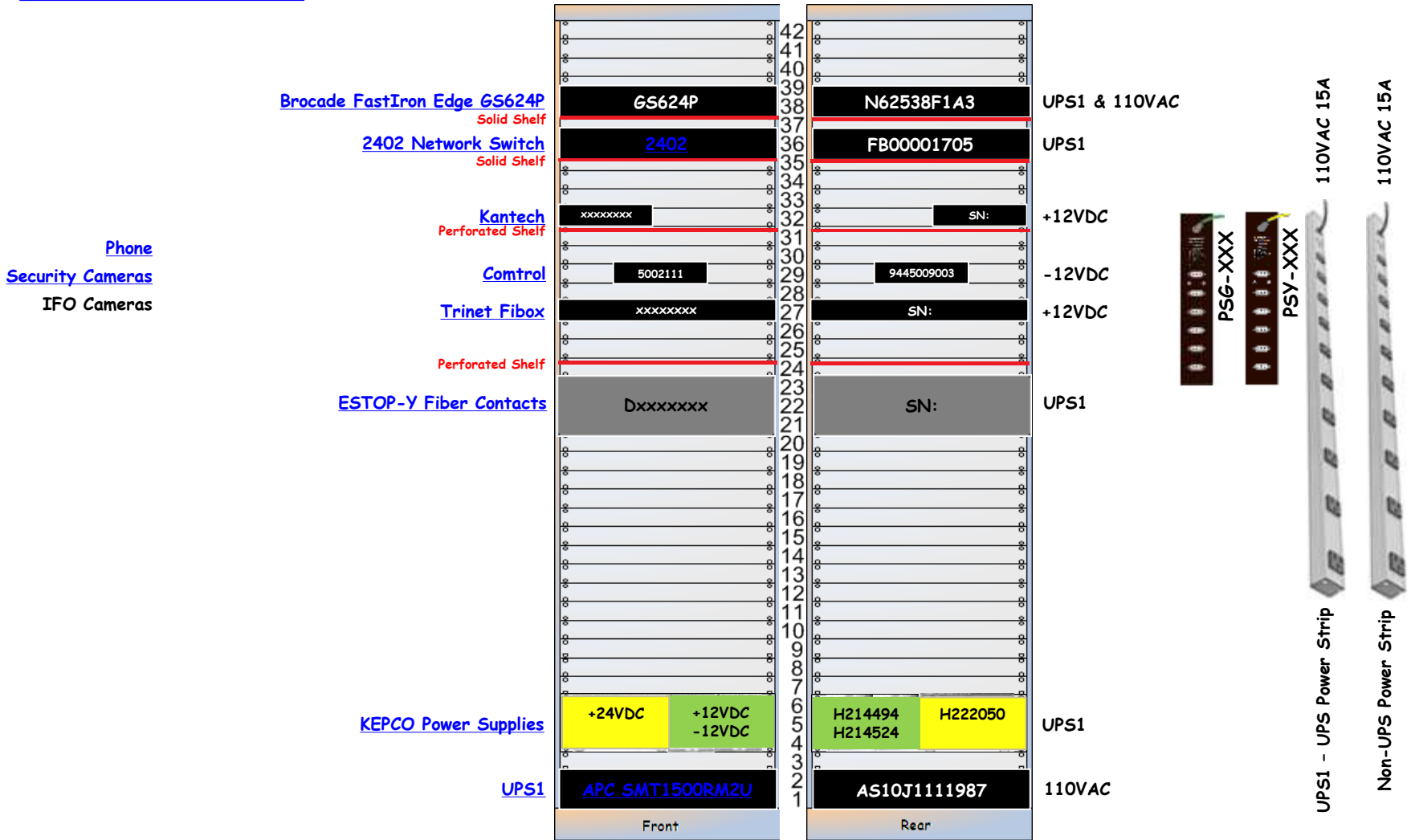

L1-FAC-YC1 Details

Brocade FastIron Edge GS624P

<< L1-FAC-YC1

Brocade FastIron Edge GS624P

GS624P

N62538F1A3

UPS & 110VAC

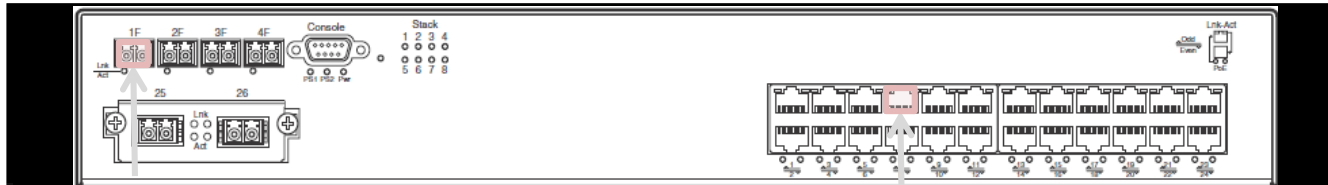

GSM7224

Front

CO:3F:0E:86:88:E0

21F - To 1Y23 PP B1.B2

3 - To FE NET Port

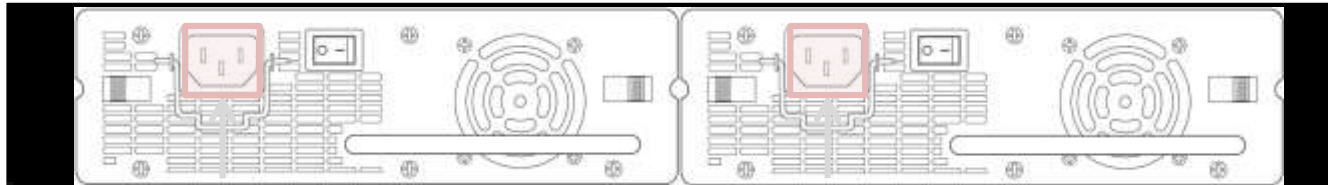

N62538F1A3

Rear

To 110 Power Strip

To UPS Power Strip

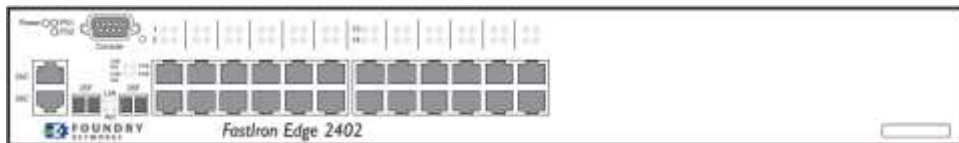

- Empty ↔ 01
- Empty ↔ 02
- Empty ↔ 03
- Empty ↔ 04
- Empty ↔ 05
- Empty ↔ 06
- To Camera on Reel ↔ 07
- Empty ↔ 08
- To Trinet/Trinet ↔ 09
- Empty ↔ 10
- To Trinet/Trinet ↔ 11
- Empty ↔ 12
- Empty ↔ 13
- To Seimens ↔ 14
- Empty ↔ 15
- Empty ↔ 16
- Empty ↔ 17
- Empty ↔ 18
- Empty ↔ 19
- Empty ↔ 20
- To Weather Station ??? ↔ 21
- Empty ↔ 22
- Empty ↔ 23
- Empty ↔ 24

- Empty ↔ 25C
- Empty ↔ 26C
- To Special Cable CSR1 ↔ 25F
- To 1Y23 PP D3, E3 ↔ 26F

Government Property Tag: G12039
192.168.253.30

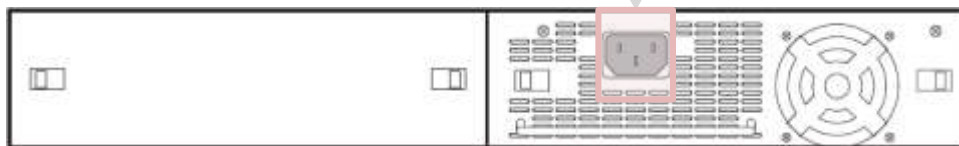

PS1

<< L1-FAC-YC1

Kantech

Fiber Options
[7711-R \(501R\)](#)
Optical In/Out:
[To 1Y23 PP D2](#)
Power: 13.5VDC
from Wall Wart

Blue CAT5:
1=O/W and
B/W, 4=O, 7=B

Powered from
Wall Wart from
Isolated Power

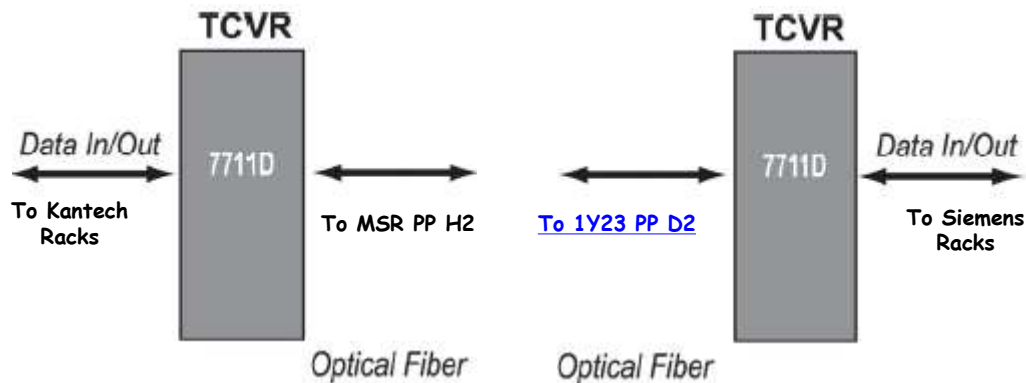

YEND - Control Interface

Control

5002111

9445009003

-12VDC

[Control DeviceMaster 4 with DB9 Ports](#)

MAC Address:
00-C0-4E-07-6E-3A

IP Address:
10.110.60.54

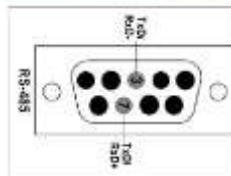

4-Port Power Supply

This table provides the specifications for the power supply shipped with the DeviceMaster 4-port.

Control Power Supply: 4-Port	
Input line frequency	47 - 63 Hz
Input line voltage	90 - 260 VAC
Output voltage	24VDC
Output current	500 mA @ 24VDC

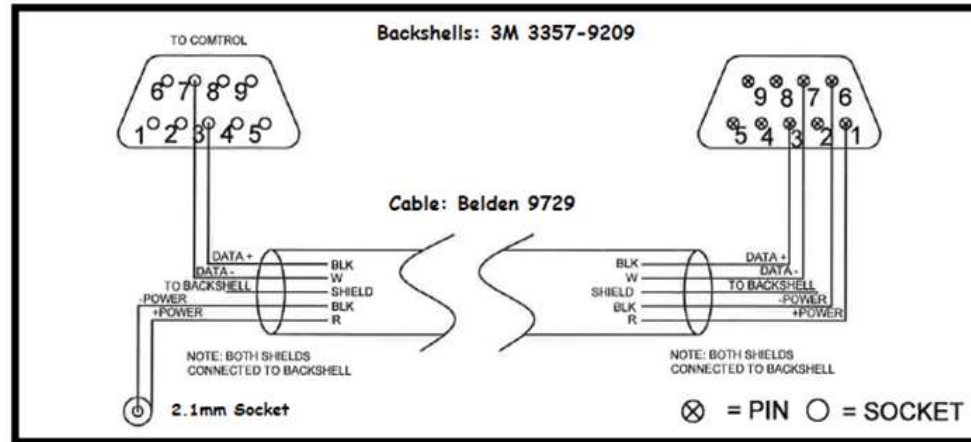
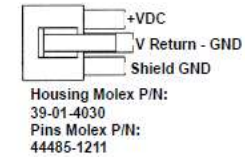

3M Shell 3357-9209

3M Shell 3357-9209

2.1mm Socket
(Note polarity)

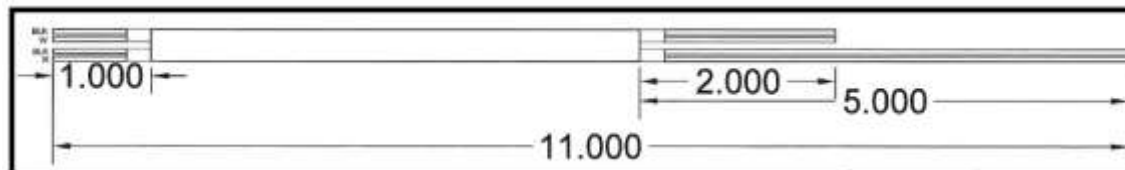

2.1mm Plug
(Note polarity)



- Empty ↔ 1
- Trinet Z ↔ 2
- Trinet Y ↔ 3
- Trinet X ↔ 4

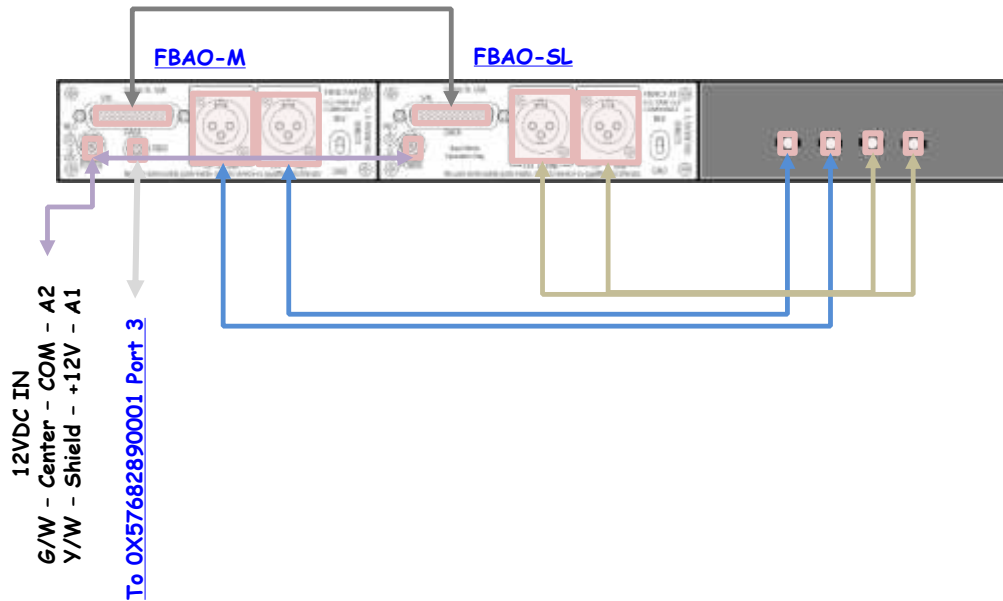

ESTOP-Y Fiber Contacts

ESTOP-Y Fiber Contacts

Dxxxxxxx

SN:

UPS1

Y-2-E Door

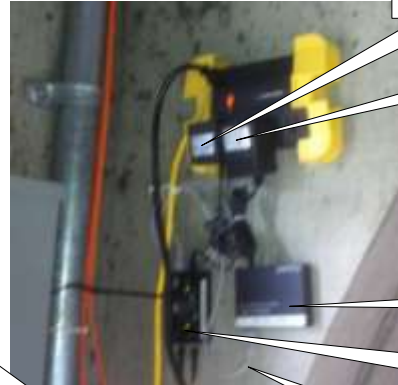

12VDC

5VDC

FIRE NDLYNET
5-Port Ethernet
Hub labeled
"Beam Tube Hub"

TRANSITION
"Just Convert It"
JE-CF-01 labeled
"Beam Tube
Converter"

MM ST Fibers
go over tube

CAT Connection

2-Fiber Orange
Cable comes
from Conduit,
goes over tube

Orange Cable
goes into Conduit

AC Circuit - one
plug to power
strip, one plug
goes over tube



Not
Connected

Feeding
something ...

<< L1-FAC-YC1

Magnetometer: [Bartington Instruments](#)
MAG-03MC

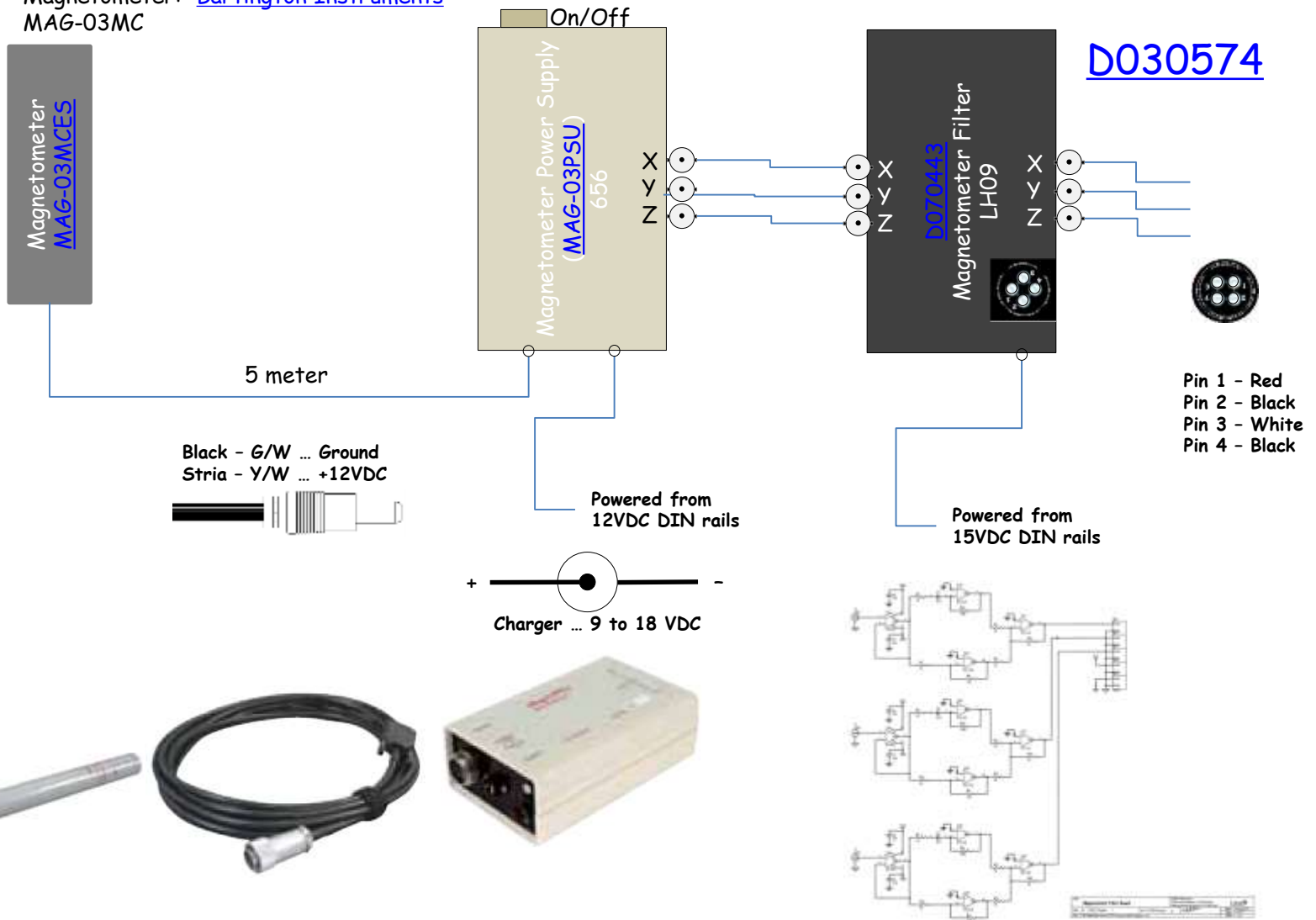

<< [L1-FAC-YC1](#)

IFO Cameras

[VT5030 IFS](#)
International
Fiber Systems,
Inc.
IFS.com
Optical Out:
[To 1Y23 PP B6](#)
Power: 12VDC
Video Input:
Camera 1
Camera 2

Powered from
DIN rails

Security Cameras

[VT7430-2DRDT](#)
Optical In/Out:
[To 1Y23 PP D1](#)
Power: 12VDC
Output: Ch1,
Ch2, Ch3 BNCs
to Cameras

Powered from
Wall Wart from
Isolated Power

Revere Video
Master Power
Supply Model
[RT24/16500](#)
Outputs to
Cameras 1,2,3

*LEDs on with
bad fuse
Note: 8 LEDs
are on.

AC Powered
from Isolated
Power

Kantech

Fiber Options
[7711-R \(501R\)](#)
Optical In/Out:
[To 1Y23 PP D2](#)
Power: 13.5VDC
from Wall Wart

Blue CAT5:
1=O/W and
B/W, 4=O, 7=B

Powered from
Wall Wart from
Isolated Power

Seismic Vault

J/E-CF-01
TriNet
Converter
CAT5:
[To 2402 P9](#)
TX:
[To 0X57... P1](#)
RX:
[To 0X57... P2](#)
Power: 12VDC

Powered from
DIN rails

J/E-CF-01
TriNet
Converter
CAT5:
[To 2402 P11](#)
TX:
[To 0X57... P8](#)
RX:
[To 0X57... P7](#)
Power: 12VDC

Powered from
DIN rails

Phone

[TR3030WDM](#)
GE Security
Optical In/Out:
[To 1Y23 PP B2](#)
Phone: Copper to
VEA
Power: 12VDC

Powered from Wall Wart from
Tripp-Lite UPS
Model BC320
9834DY0BC614000661 To 6-
Outlet Power Strip in Non-
isolated wall socket

Security Cameras

Revere Video
Master Power
Supply Model
[RT24/16500](#)
Outputs to
Cameras 1,2,3

*LEDs on with
bad fuse
Note: 8 LEDs
are on.

AC Powered
from Isolated
Power



RT24/16500

AC Power120 VAC LED supervised
Non-grounded power cord
furnished
Output24 VAC, 8 amps total
Outputs16 @ 500mA individually
fused at 1/2 amp and
individually supervised
Dimensions7.5" W x 8.25" H x 3.5" D
CabinetHeavy gauge steel



VAC

YEND - Security Cameras

Security Cameras

VT7430-2DRDT

Optical In/Out:

To 1Y23 PP D1

Power: 12VDC

Output: Ch1,

Ch2, Ch3 BNCs

to Cameras

Powered from
Wall Wart from
Isolated Power

cameras
75-ohm coaxial cables

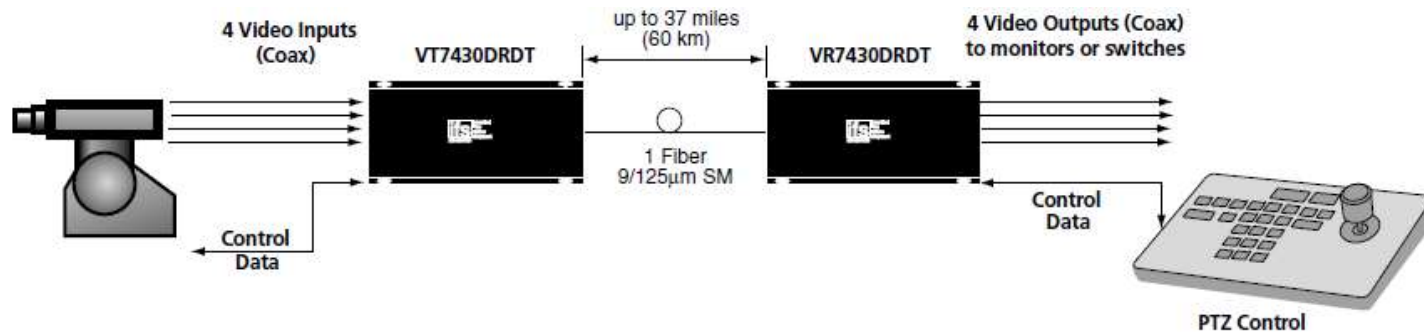

1Y23 - Stuff

Cameras

[VT5030 IFS](#)
International
Fiber Systems,
Inc.
IFS.com
Optical Out:
[To 1Y23 PP B6](#)
Power: 12VDC
Video Input:
Camera 1
Camera 2

Powered from
DIN rails

cameras
75-ohm coaxial cables

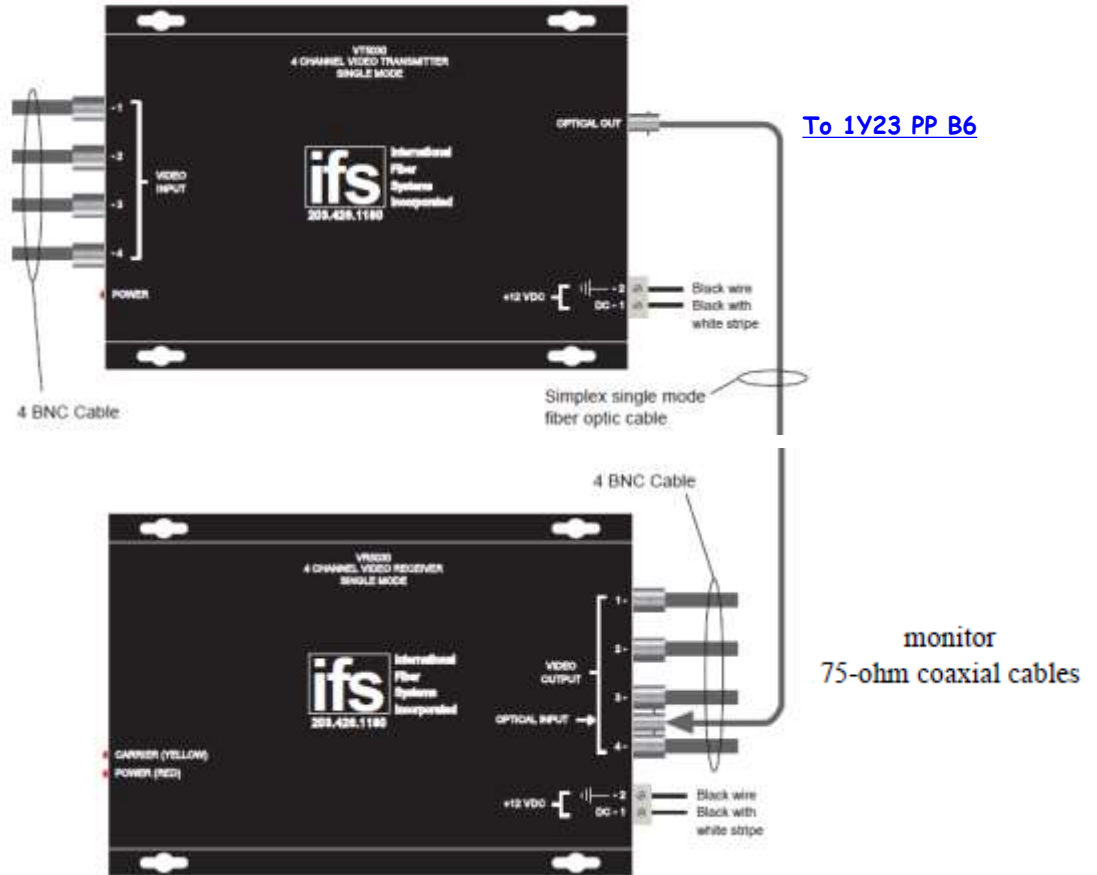

YEND - Trinet

Seismic Vault

<p>J/E-CF-01 TriNet Converter CAT5: To 2402 P9 TX: To 0X57... P1 RX: To 0X57... P2 Power: 12VDC</p>	<p>J/E-CF-01 TriNet Converter CAT5: To 2402 P11 TX: To 0X57... P8 RX: To 0X57... P7 Power: 12VDC</p>
<p>Powered from DIN rails</p>	<p>Powered from DIN rails</p>

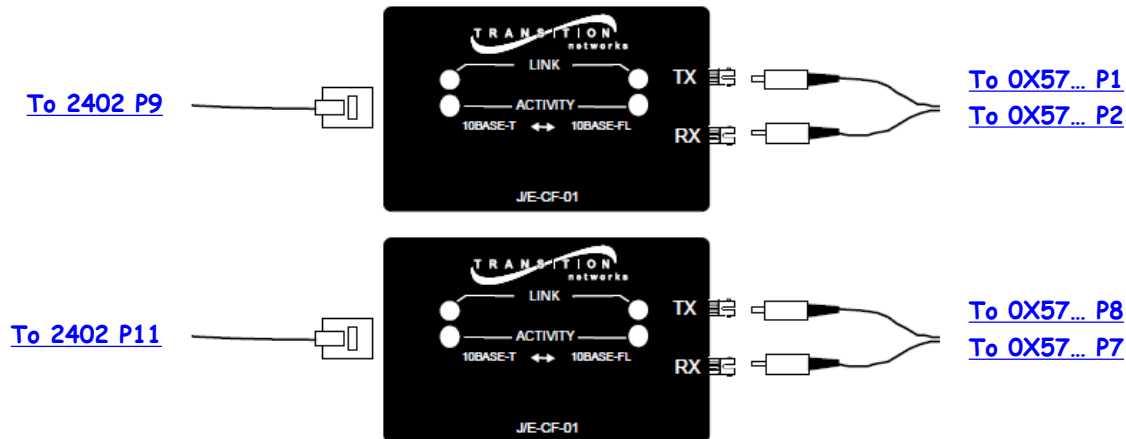

For network installation, the J/E-CF-01 media converter provides an RJ-45 twisted pair connector and a set of RX (receive) and TX (transmit) ST connectors to 850 nm multimode fiber-optic cable.

YEND - Phone

Phone

[TR3030WDM](#)
 GE Security
 Optical In/Out:
[To 1Y23 PP B2](#)
 Phone: Copper to
 VEA
 Power: 12VDC

Powered from Wall Wart from
 Tripp-Lite UPS
 Model BC320
 9834DY0BC614000661 To 6-
 Outlet Power Strip in Non-
 isolated wall socket



System Design

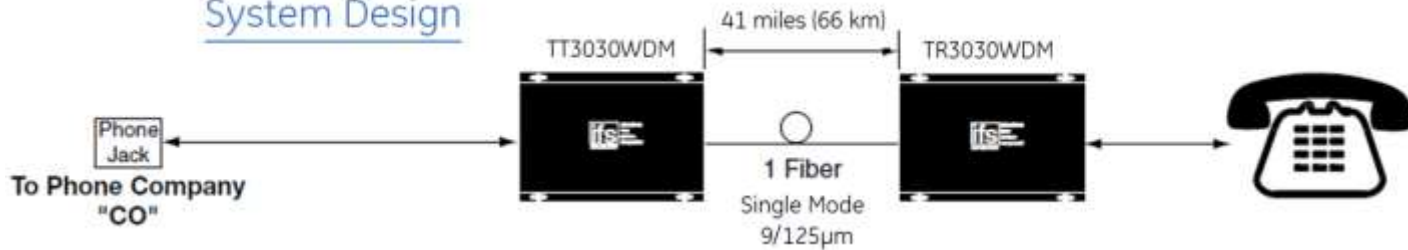

KEPCO Power Supplies

KEPCO Power Supplies

+24VDC

+12VDC
-12VDC

H214494
H214524

H222050

UPS1

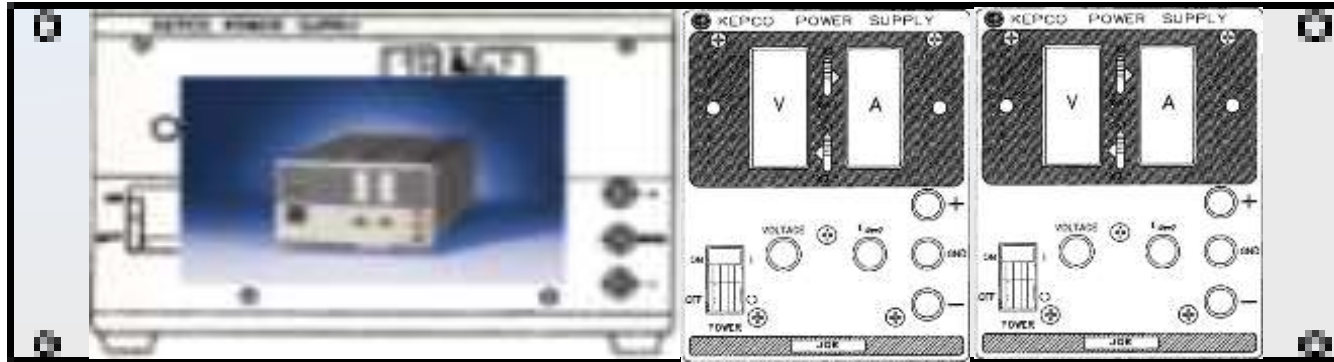

Front

KEPCO JQE 25-10
+24VDC

KEPCO JQE 15-6
+12VDC

KEPCO JQE 15-6
-12VDC

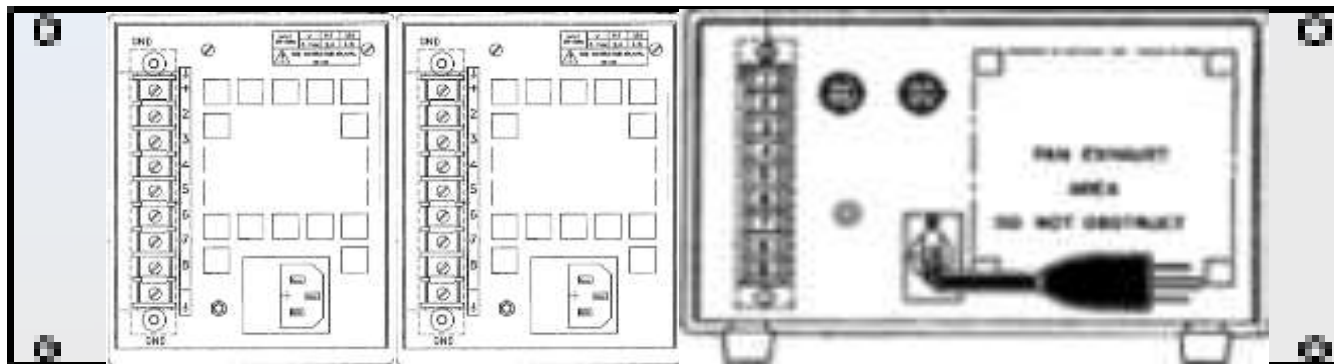

Rear

KEPCO JQE 15-6
H214524

KEPCO JQE 15-6
H214494

KEPCO JQE 25-10
H222050

APC SMT1500RM2U

UPS

APC SMT1500RM2U

A51051111987

110VAC

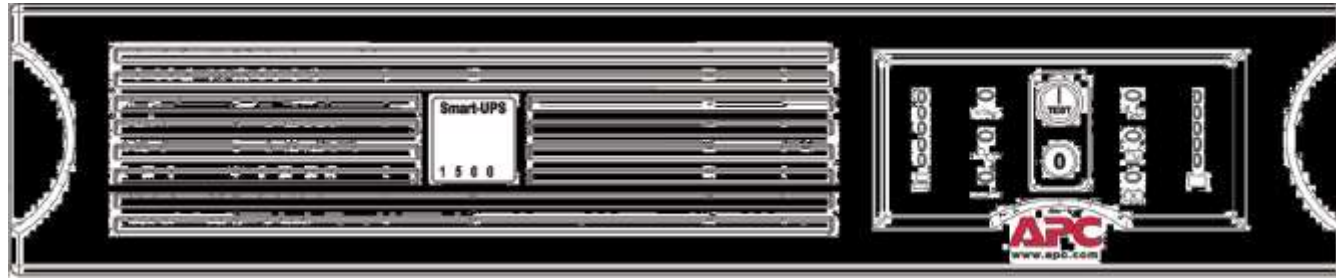

APC SMT1500RM2U

Front

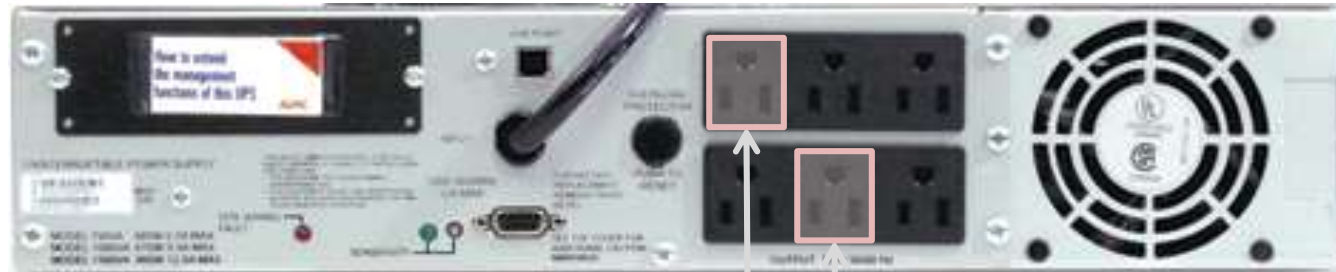

A51051111987

Rear

To 2402 PS1

To X448 PS1

<< [CERY Racks](#)
 << [YEND Racks and Tables](#)

ISC-YC1 YEND Station Remote Rack Layout ([D1201091](#)) ([S1202955](#))

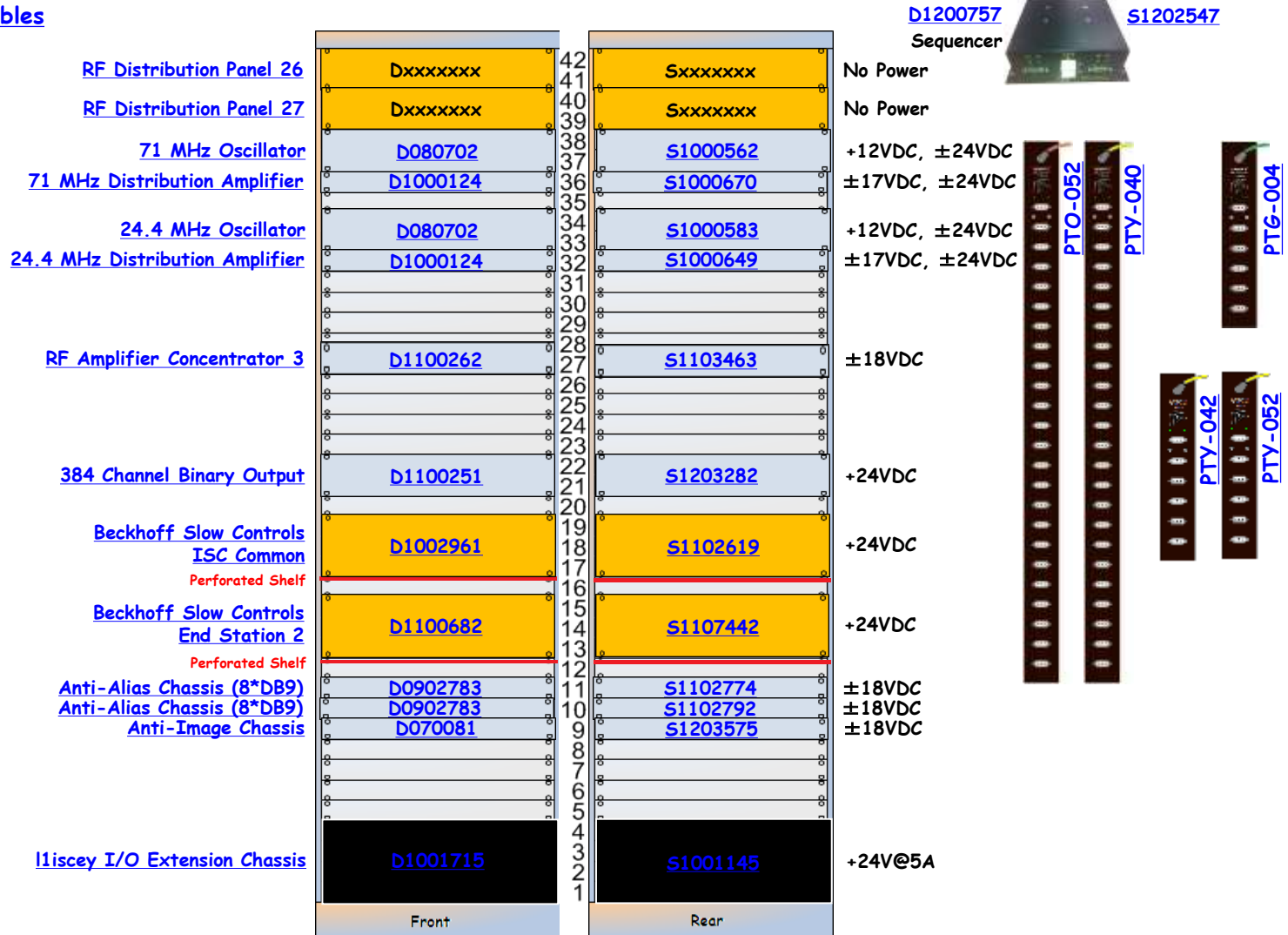

ISC-YC1 is part of [D1001459](#)

L1-ISC-YC1 Details

ISC-YC1 is part of [D1001459](#)

RF Distribution Panel 26

<< L1-ISC-YC1

RF Distribution Panel 26

Dxxxxxxx

Sxxxxxxx

No Power

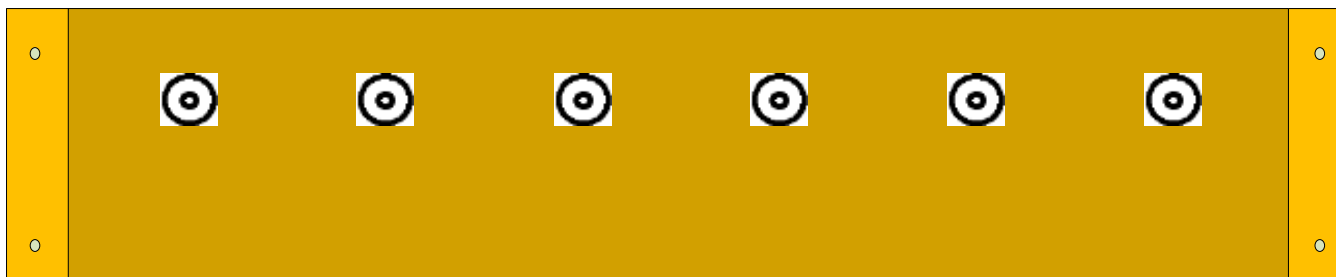

Dxxxxxxx

Front

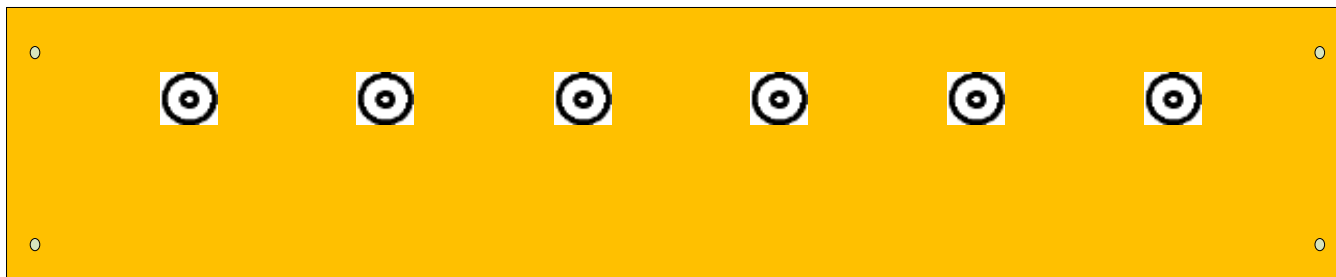

Sxxxxxxx

Rear

RF Distribution Panel 27

<< L1-ISC-YC1

RF Distribution Panel 27

Dxxxxxxx

Sxxxxxxx

No Power

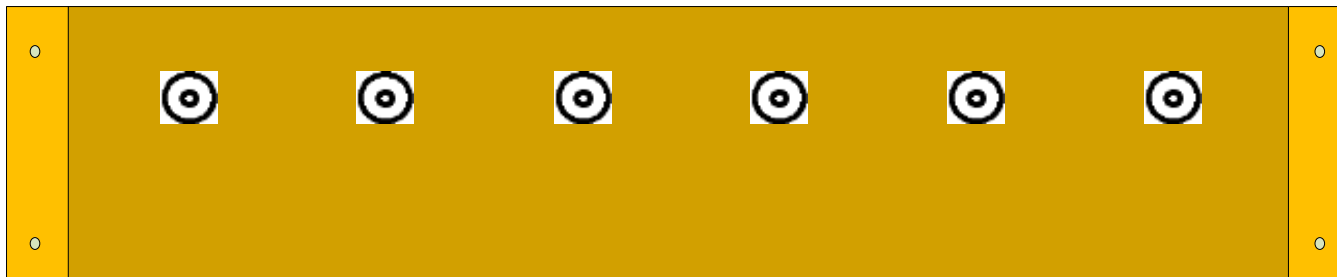

Dxxxxxxx

Front

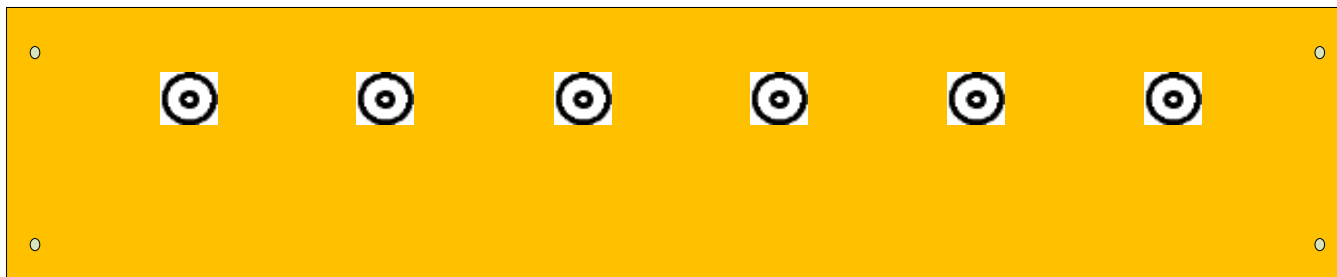

Sxxxxxxx

Rear

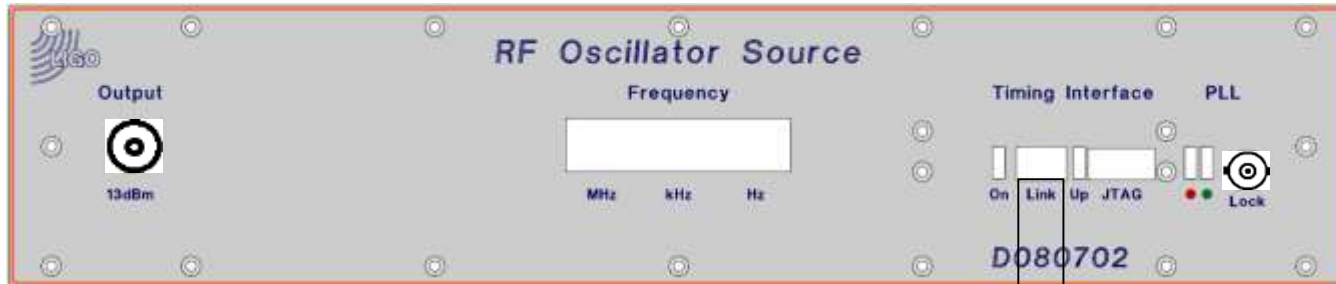

D080702

Front

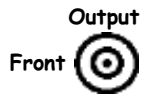

To ...



S1000562

Rear

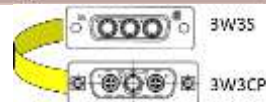

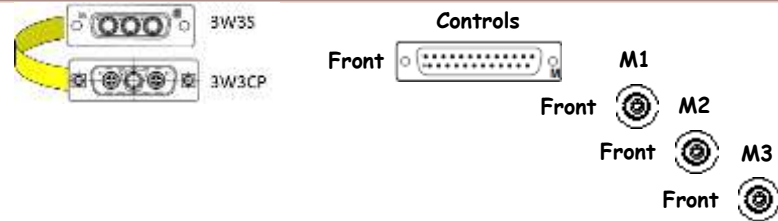
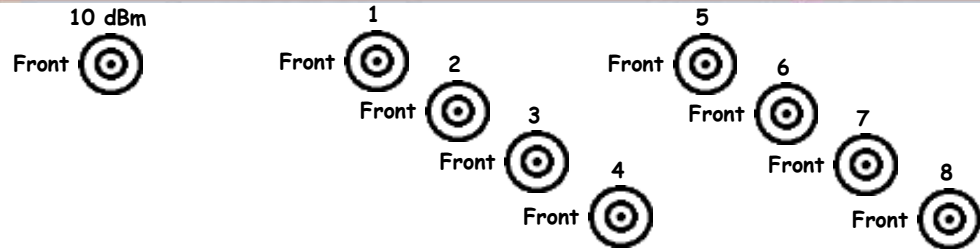
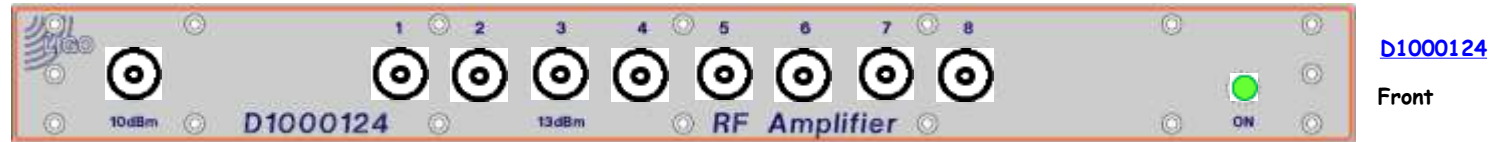

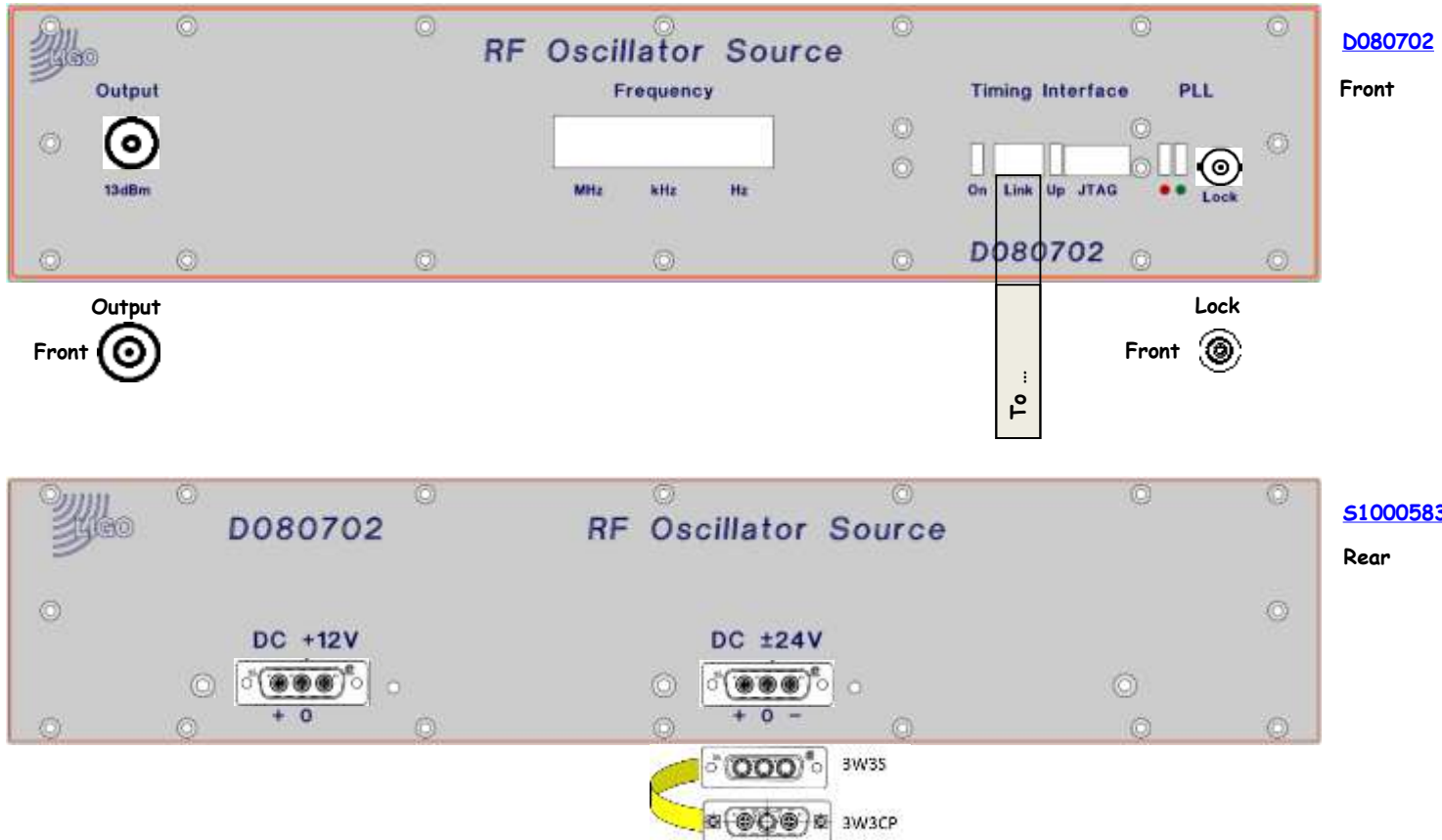

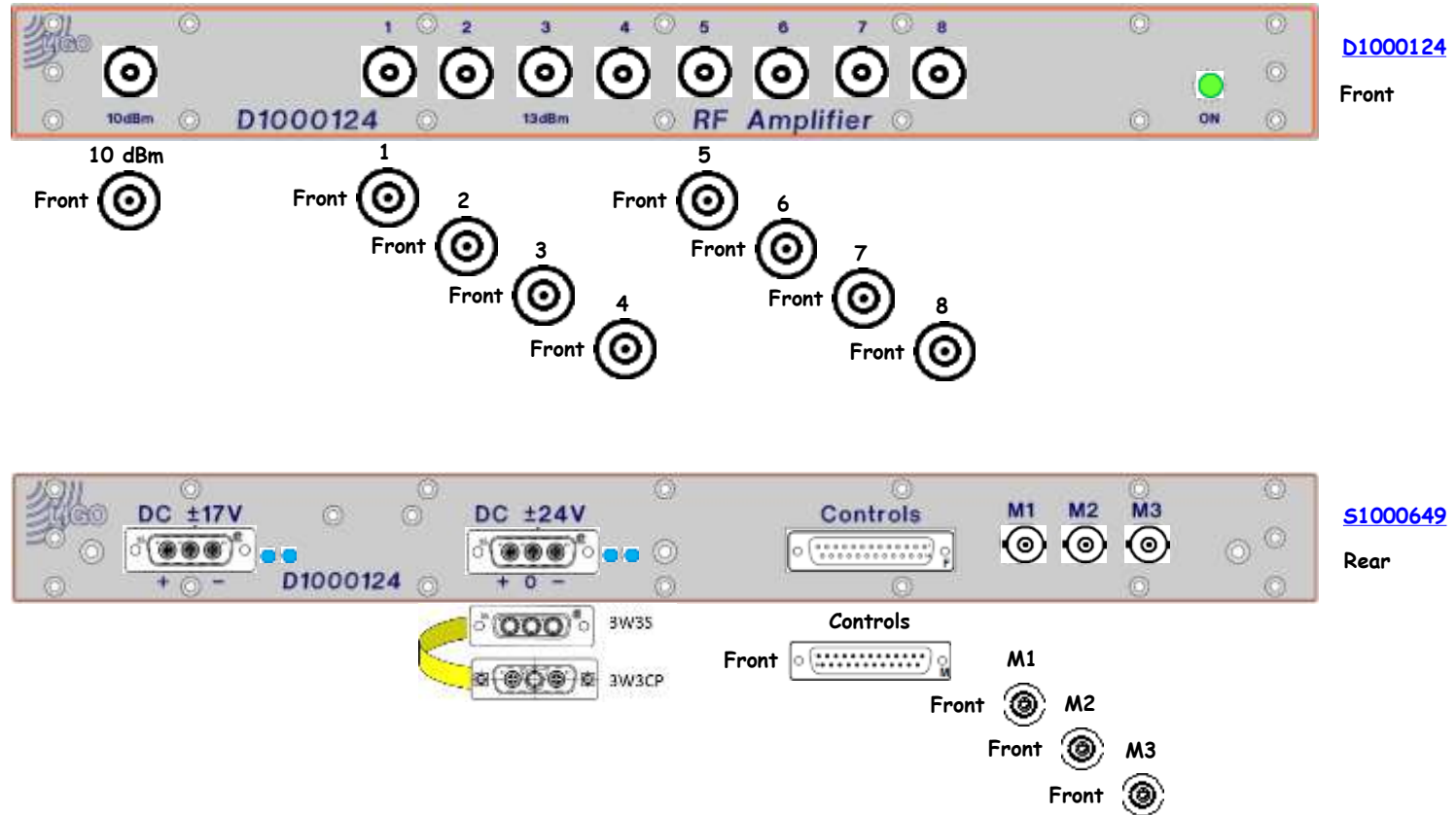



D1100262

Front

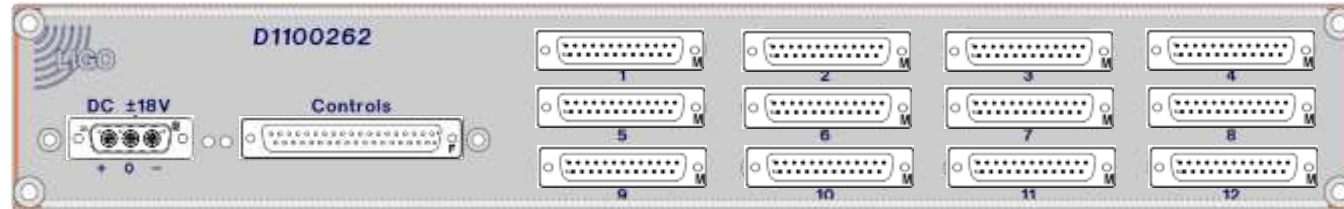

S1103463

Rear

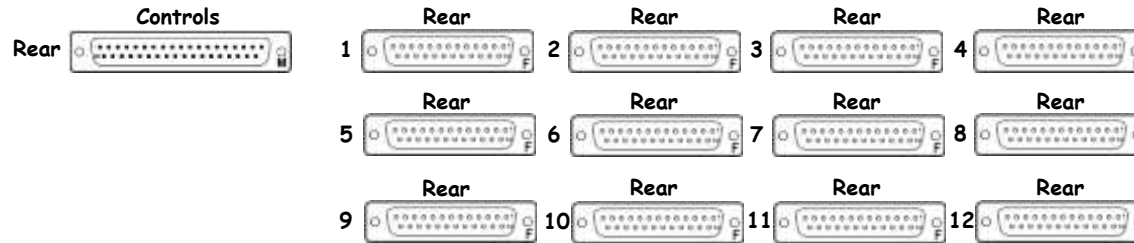

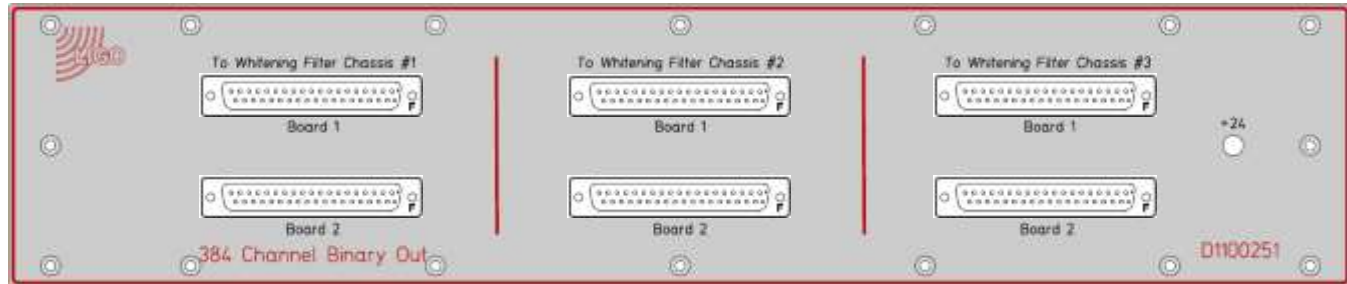

D1100251

Front

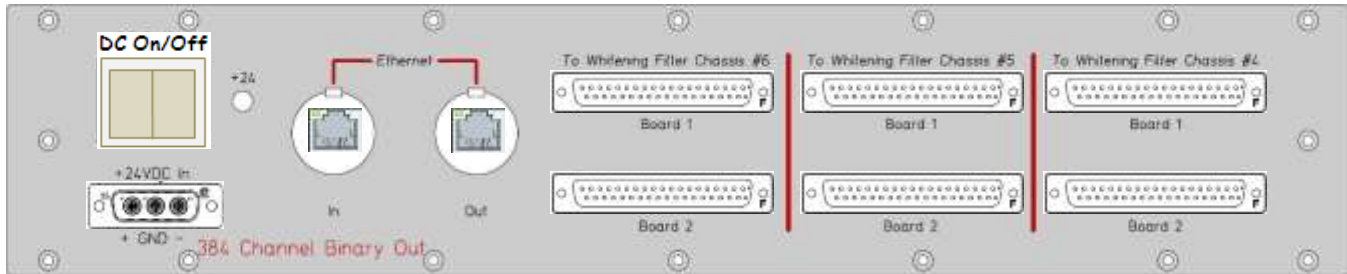
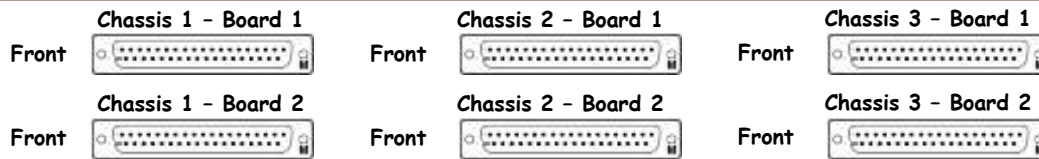

S1203282

Rear

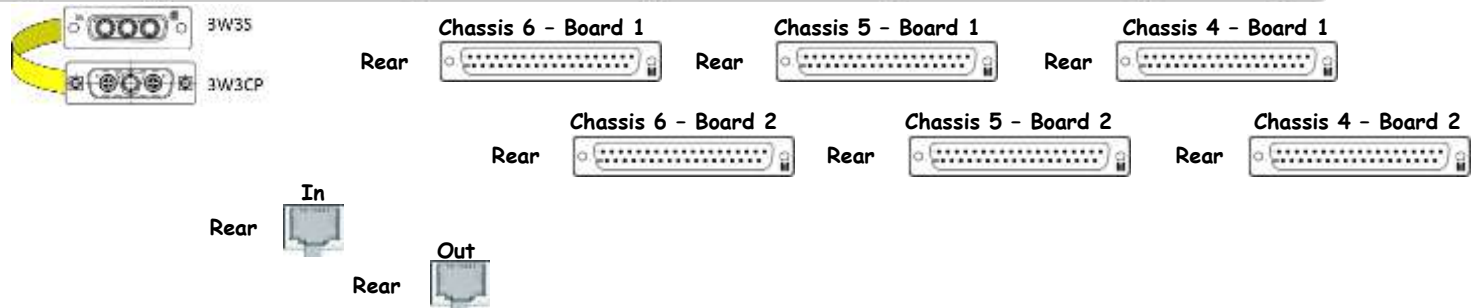

<< L1-ISC-YC1

Beckhoff Slow Controls
ISC Common

D1002961

S1102619

+24VDC

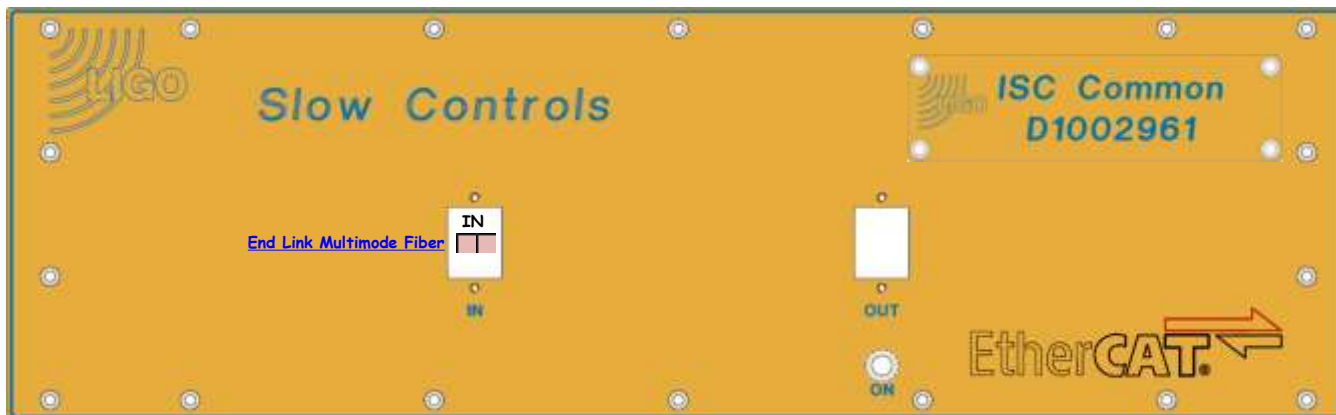

D1002961

Front: D0902553

Name: D1002962

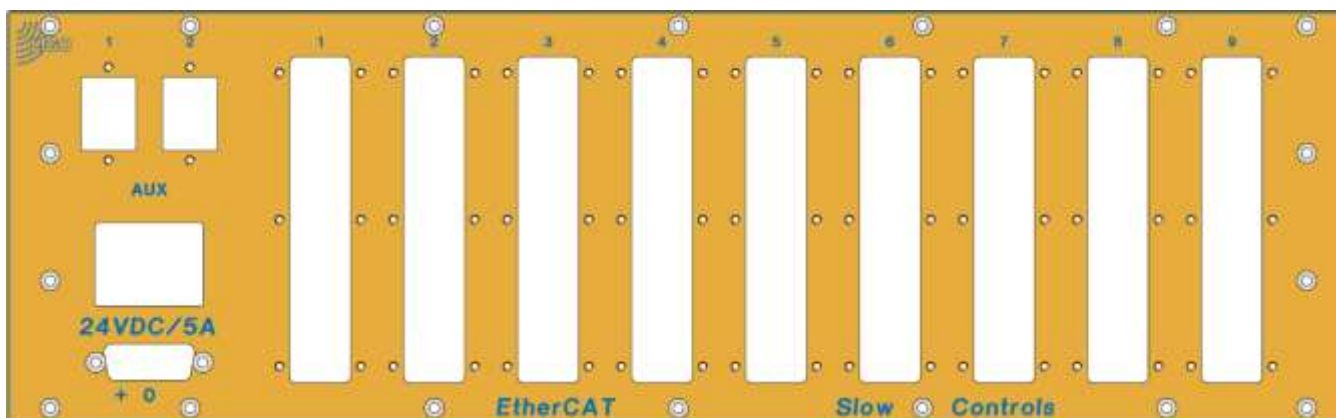

S1102619

Rear: D0902554

<< [L1-ISC-YC1](#)

Beckhoff Slow Controls
End Station 2

[D1100682](#)

[S1107442](#)

+24VDC

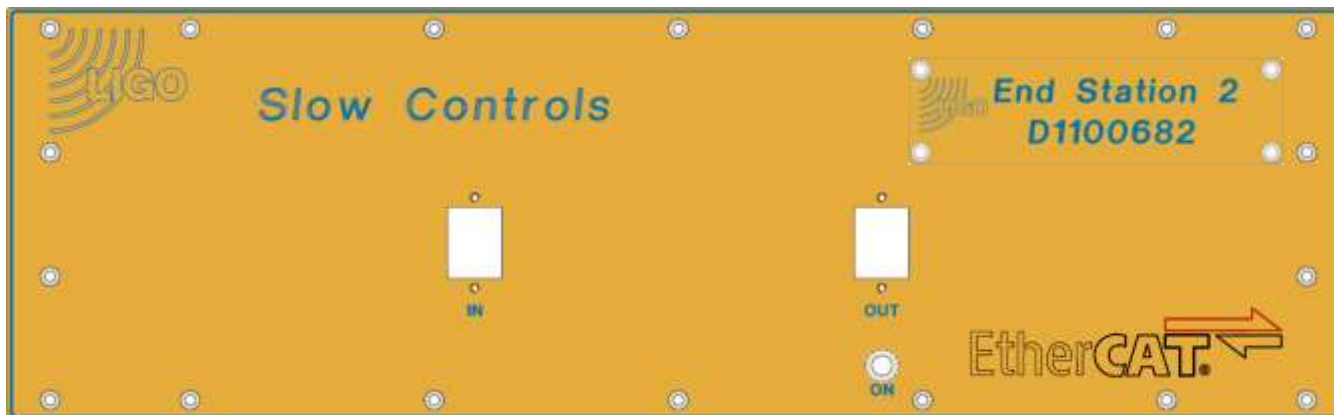

[D1100682](#)

[Front: D0902553](#)

[Name: D1101978](#)

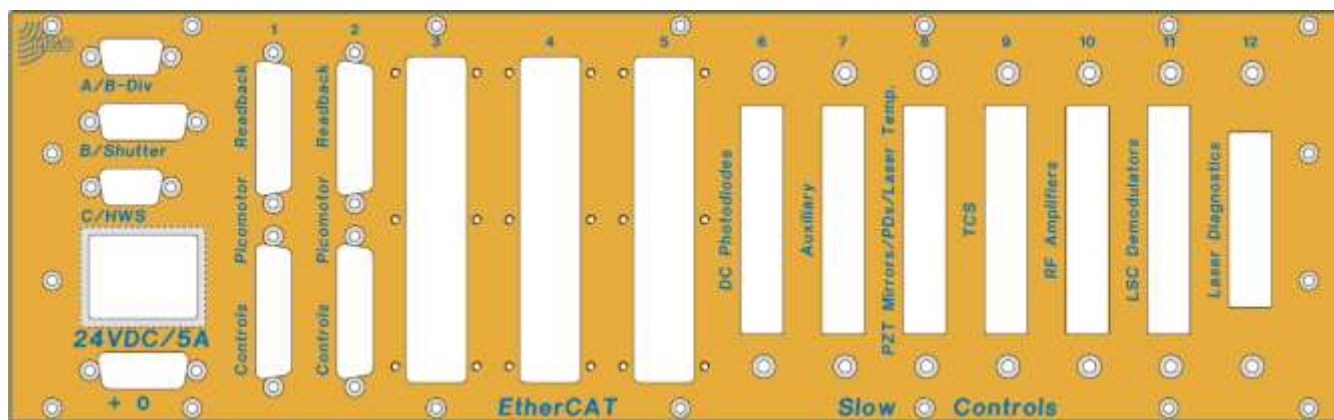

[S1107442](#)

[Rear: D1101977](#)

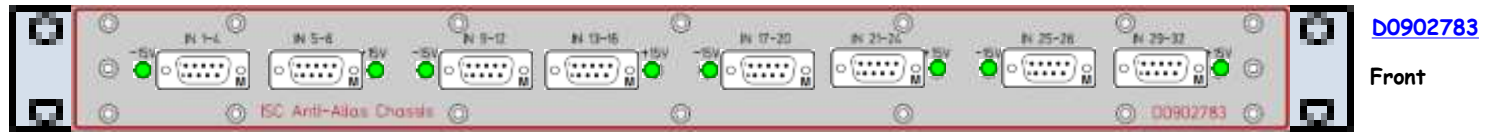

D0902783

Front

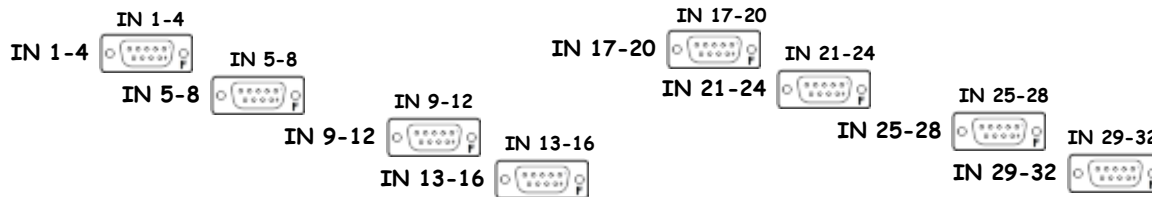

S1102774

Rear



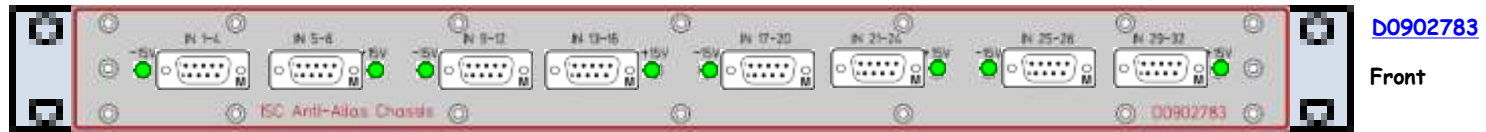

D0902783

Front

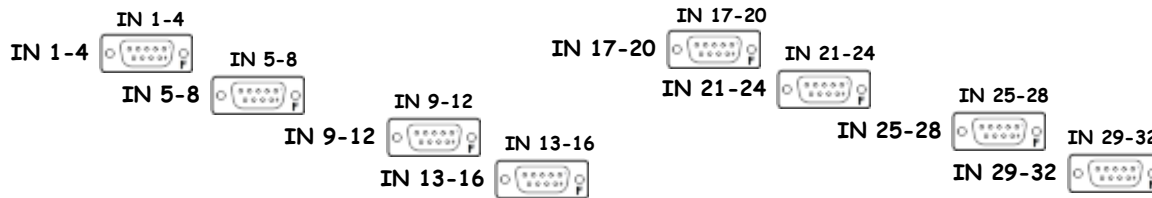

S1102792

Rear



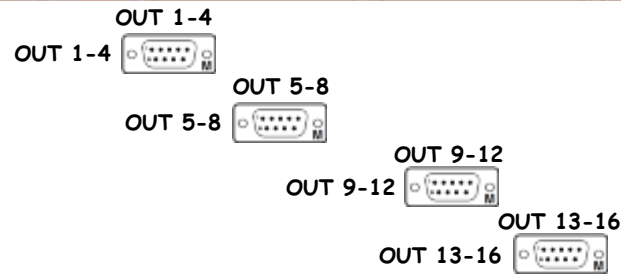
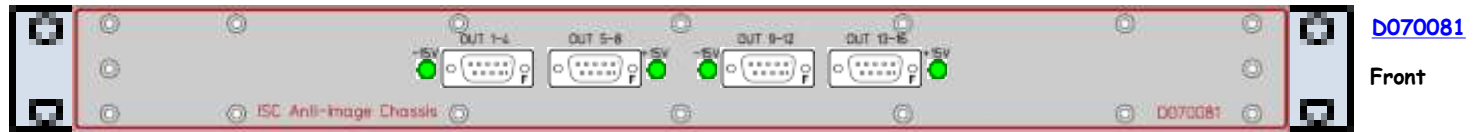



D1001715

Front

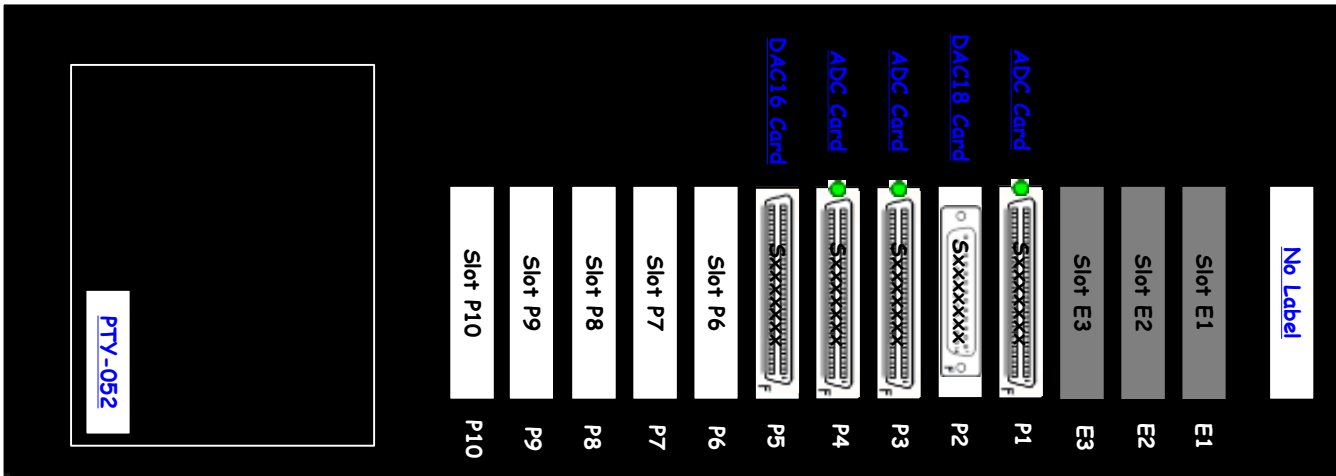

S1001145

Rear

Uplink		No Label
Slot E1		Open
Slot E2		Open
Slot E3		Open
Slot P1		Open
Slot P2		Open
Slot P3		Open
Slot P4		Open
Slot P5		Open
Slot P6		Open
Slot P7		Open
Slot P8		Open
Slot P9		Open
Slot P10		Open

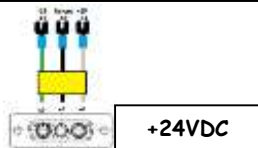

<< [CERY Racks](#)
 << [YEND Racks and Tables](#)

L1-SEI-YC1 (BSC5) YEND Remote Rack 1 Layout ([D1201088](#)) ([S1202952](#))

	42					
	41					
BSC5 ISI Interface Chassis Pod 1	D1002432	40	S1300127		$\pm 18\text{VDC}$	
BSC5 ISI Interface Chassis Pod 2	D1002432	39	S1300126		$\pm 18\text{VDC}$	
BSC5 ISI Interface Chassis Pod 3	D1002432	38	S1300125		$\pm 18\text{VDC}$	
	37					
	36					
BSC5 ISI AA Chassis	D1002693	35	S1300138		$\pm 18\text{VDC}$	
BSC5 ISI AA Chassis	D1002693	34	S1300139		$\pm 18\text{VDC}$	
	33					
BSC5 ISI AA Chassis	D1002693	32	S1300686		$\pm 18\text{VDC}$	
	31					
BSC5 HEPI AA Chassis	D1000272	30	S1300142		$\pm 18\text{VDC}$	
BSC5 HEPI AI Chassis	D1100202	29	S1300687		$\pm 18\text{VDC}$	
	28					
BSC5 8 Channel Valve Driver	D0900117	27	S0900283		$\pm 18\text{VDC}$	
	26					
64 Channel Binary Input Chassis (8*DB9)	D1001726	25	S1203072		$\pm 18\text{VDC}$	
64 Channel Binary Input Chassis (8*DB9)	D1001726	24	S1203073		$\pm 18\text{VDC}$	
64 Channel Binary Output Chassis (8*DB9)	D1001728	23	S1101339		$\pm 18\text{VDC}$	
	22					
Trillium 240 Interface Chassis Pod 1	D1002964	21	S1201403		$\pm 18\text{VDC}$	
Trillium 240 Interface Chassis Pod 2	D1002964	20	S1201404		$\pm 18\text{VDC}$	
Trillium 240 Interface Chassis Pod 3	D1002964	19	S1201410		$\pm 18\text{VDC}$	
	18					
	17					
STS-2 Interface Chassis	D080535	16	S0900618		$\pm 18\text{VDC}$	
	15					
	14					
1lseiy I/O Extension Chassis	D1001715	13	S1200166		+24VDC	
	12					
	11					
Anti-Image Chassis (4*DB9)	D1000305	9	S1300612		$\pm 18\text{VDC}$	
	8					
BSC5 ISI Coil Driver Pod 1	D0902744	6	S1103362		$\pm 24\text{VDC}$	
BSC5 ISI Coil Driver Pod 2	D0902744	4	S1103311		$\pm 24\text{VDC}$	
BSC5 ISI Coil Driver Pod 3	D0902744	2	S1103328		$\pm 24\text{VDC}$	
	1					
		Front	Rear			

SEI-YC1 is part of [D0901301](#)

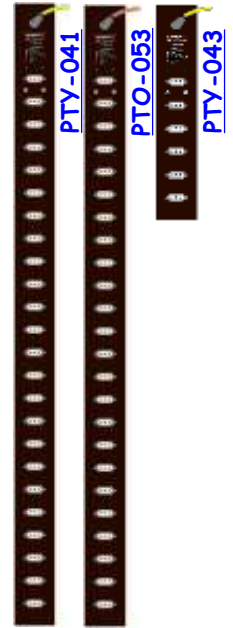

NOTE: One $\pm 18\text{VDC}$ connector powers 4 HEPI Pods.

L1-SEI-YC1 Details

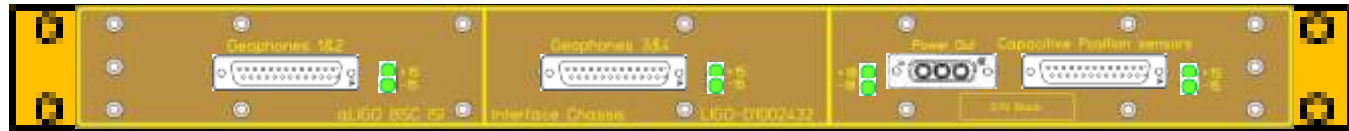

[D1002432](#)

Front

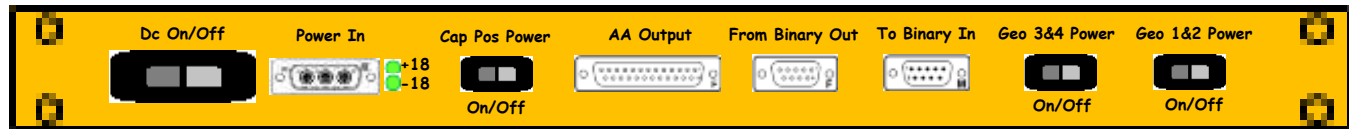

[S1300125](#)

Rear

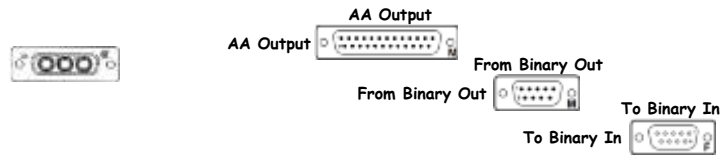

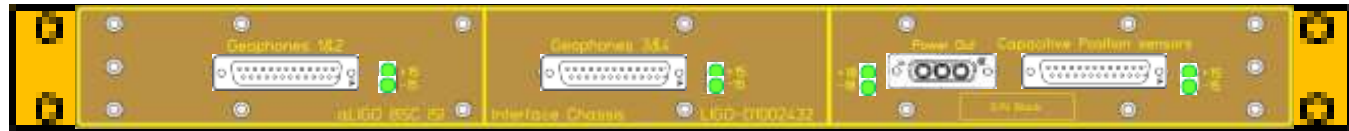

[D1002432](#)

Front

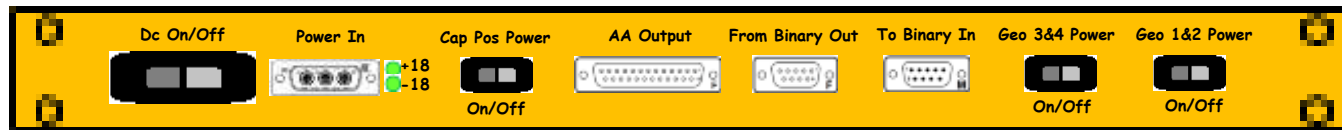

[S1300126](#)

Rear

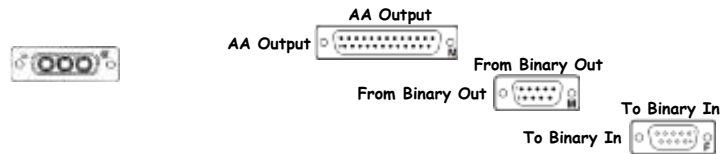

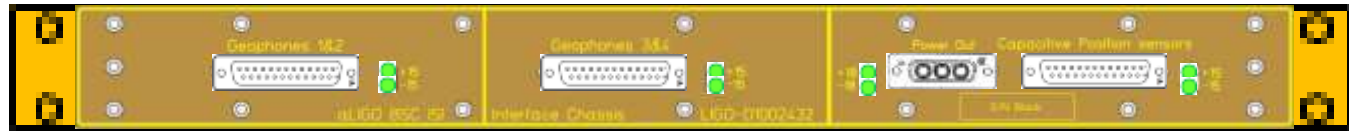

[D1002432](#)

Front

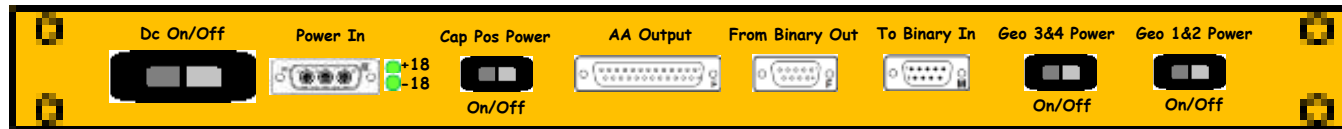

[S1300127](#)

Rear

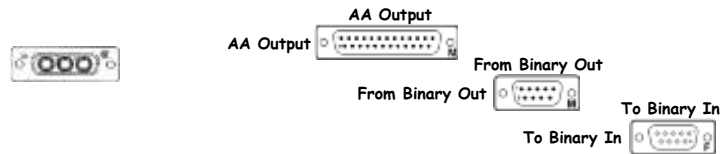

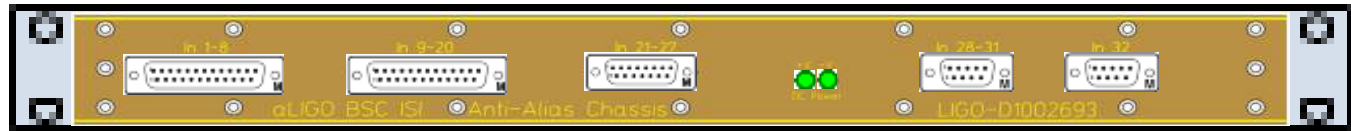

D1002693

Front

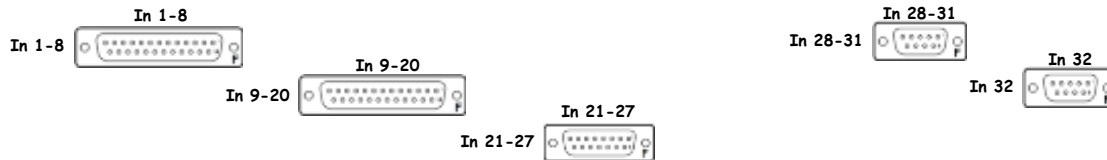

S1300138

Rear



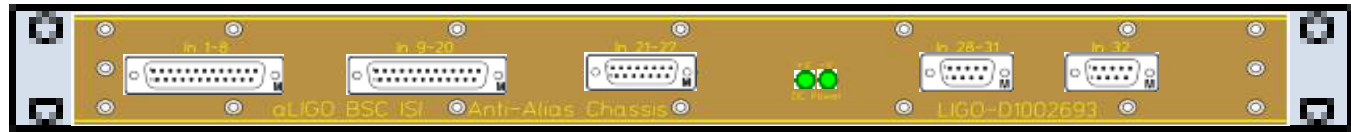

D1002693

Front

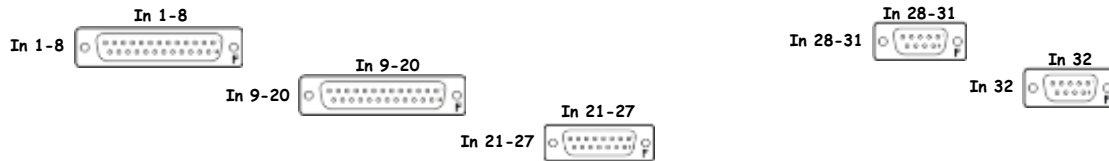

S1300139

Rear

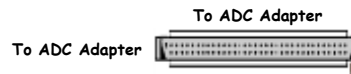

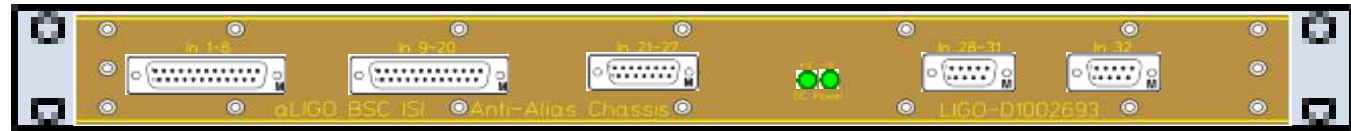

D1002693

Front

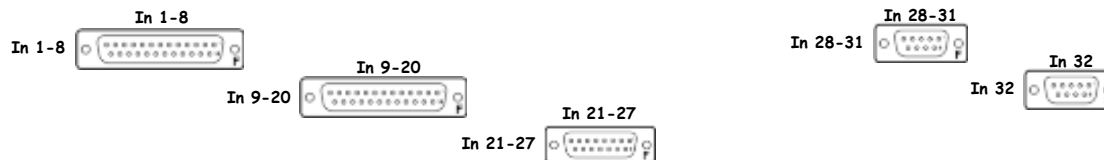

S1300686

Rear

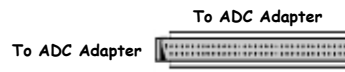

D1000272 - S1300142

BSC5 HEPI AA Chassis Pod 3 D1000272 S1300142 Power



D1000272

Front

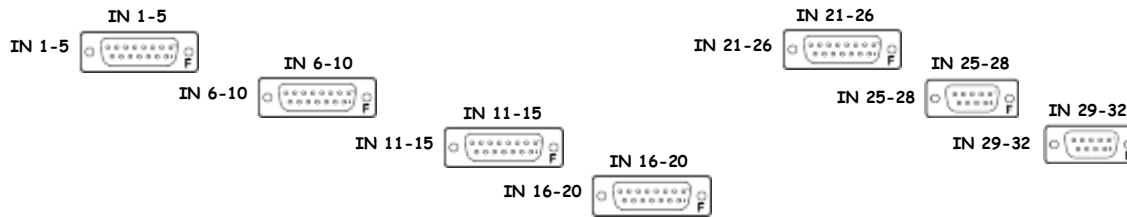

S1300142

Rear

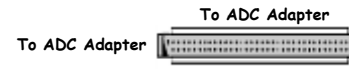

D1100202 - S1300687



<< L1-SEI-YC1

BSC5 HEPI AI Chassis D1100202 S1300687 Power

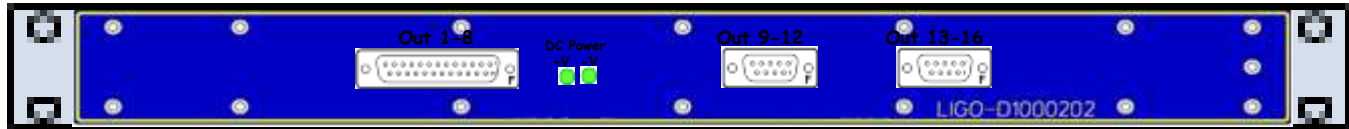

D1100202

Front



S1300687

Rear

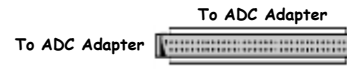



D0900117

Front

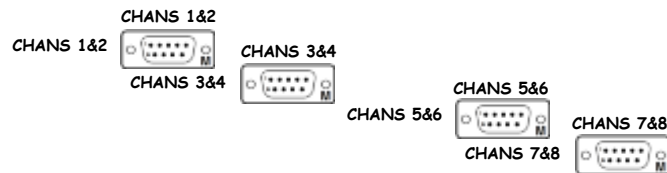

S0900283

Rear

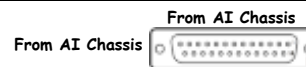

D1001726 - S1203072



<< L1-SEI-YC1

64 Channel Binary Input Chassis (8*DB9) D1001726 S1203072 ±18VDC



D1001726

Front

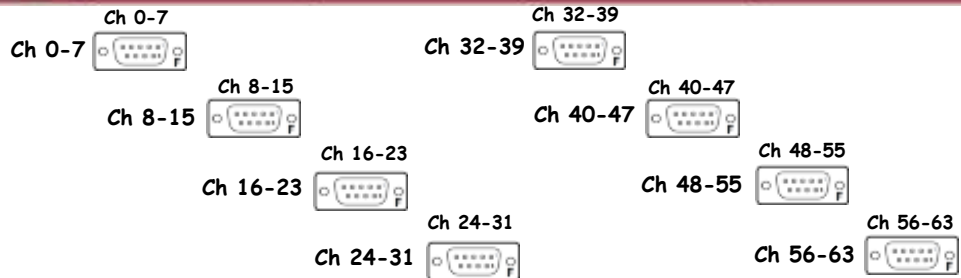

S1203072

Rear



D1001726 - S1203073



<< L1-SEI-YC1

64 Channel Binary Input Chassis (8*DB9) D1001726 S1203073 ±18VDC

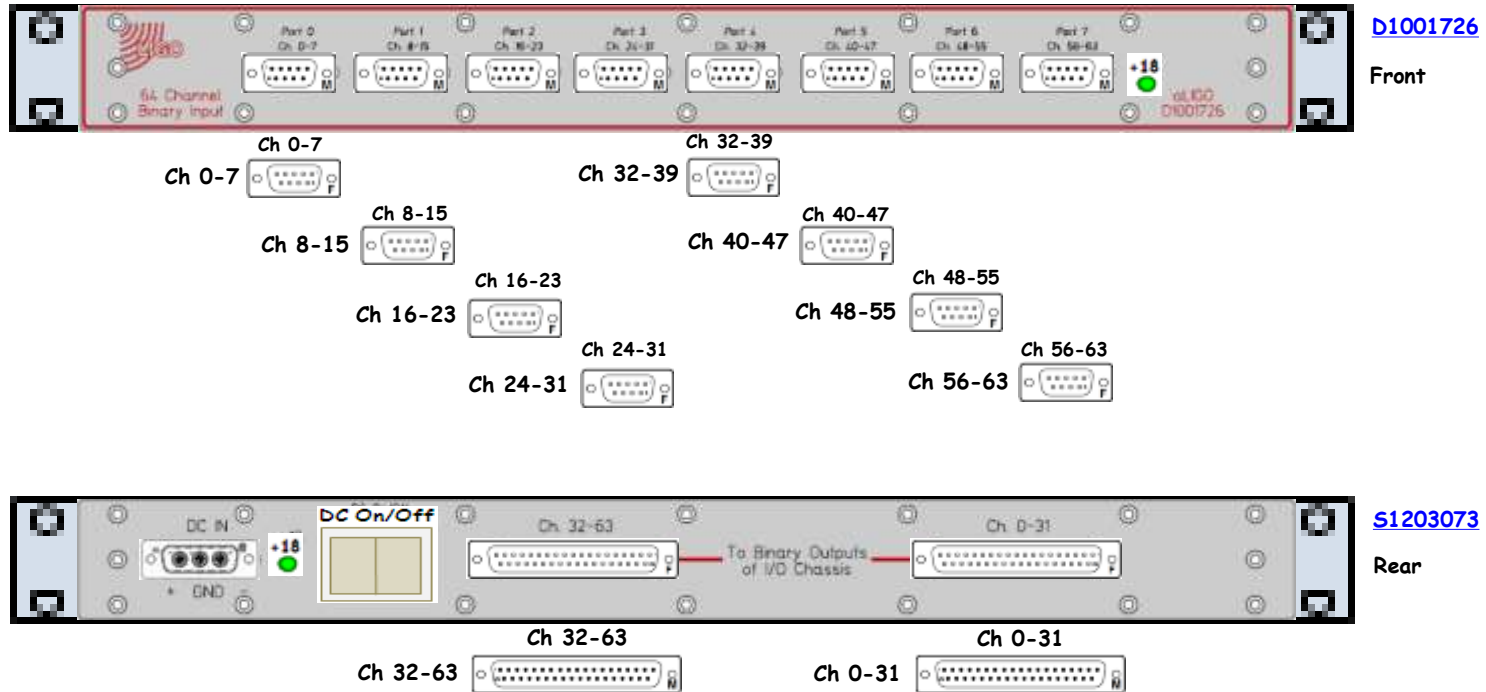

D1001726

Front

S1203073

Rear

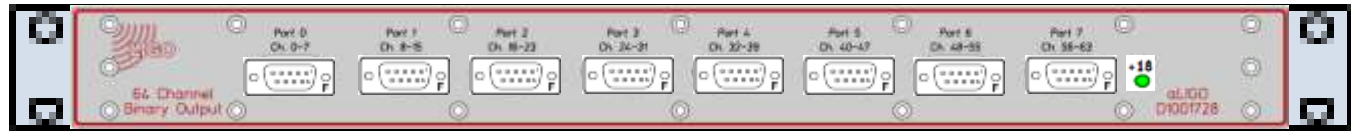

D1001728

Front

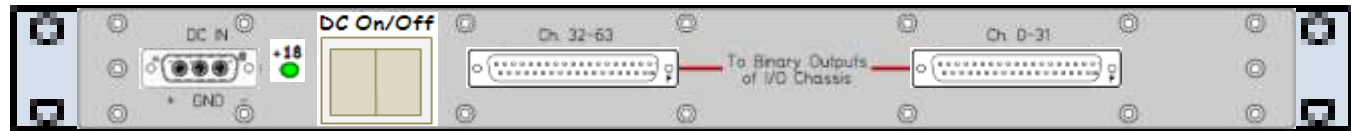
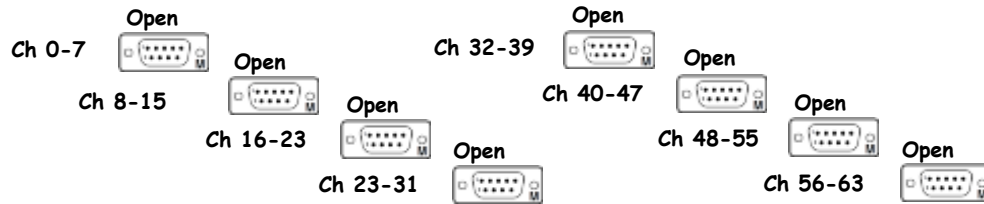

S1101339

Rear



Trillium 240 Interface Chassis Pod 1 D1002964 S1201405 ±18VDC



D1002964

Front

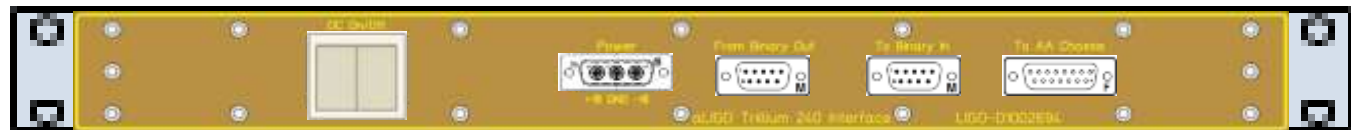
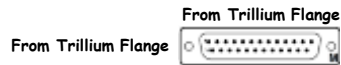

S1201405

Rear

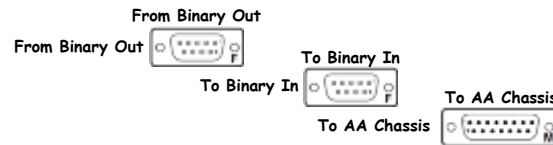

Trillium 240 Interface Chassis Pod 2 D1002964 S1201406 ±18VDC



D1002964

Front

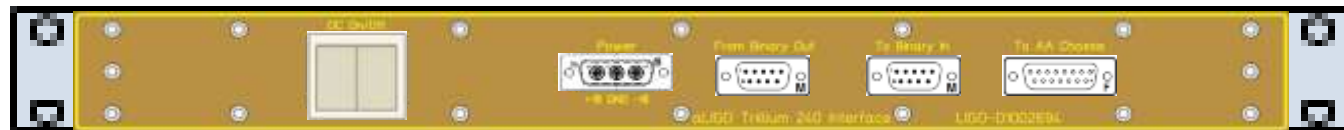
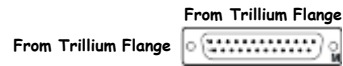

S1201406

Rear

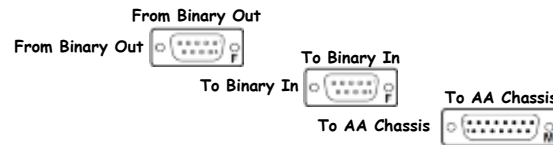



[D1002694](#)

Front

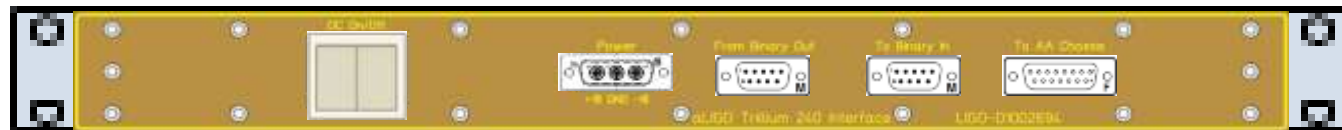
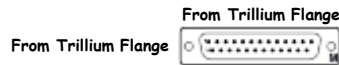

[S1201407](#)

Rear

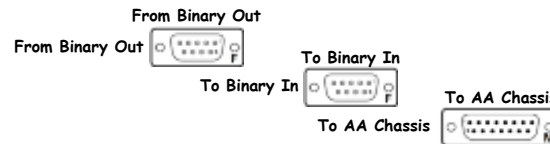

<< L1-SEI-YC1

STS-2 Interface Chassis

D080535

S0900105

±18VDC

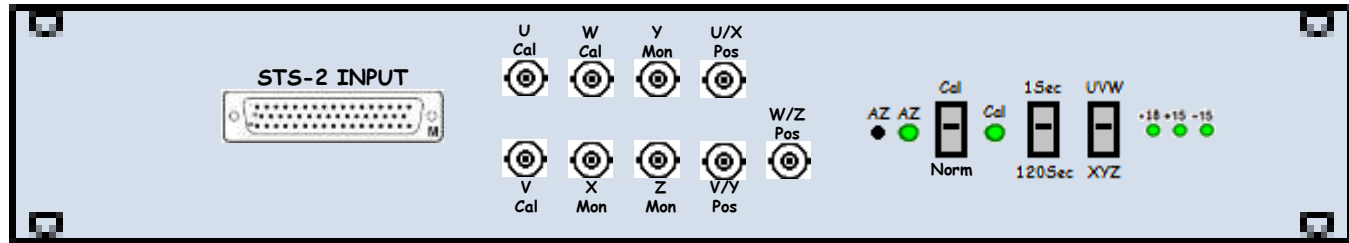

D080535

Front

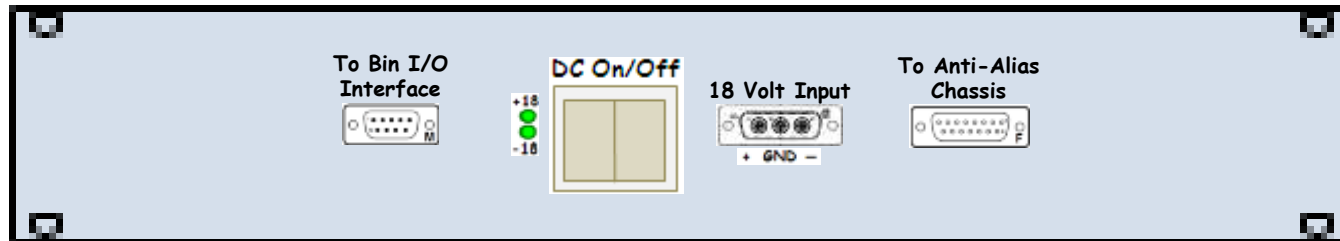

S0900105

Rear

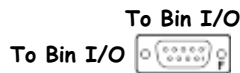

<< L1-SEI-YC1

I1seiey I/O Extension Chassis

D1001715

S1200166

+24VDC

D1001715

Front

No Label

I1seiey – I/O Extender

S1200166

Rear

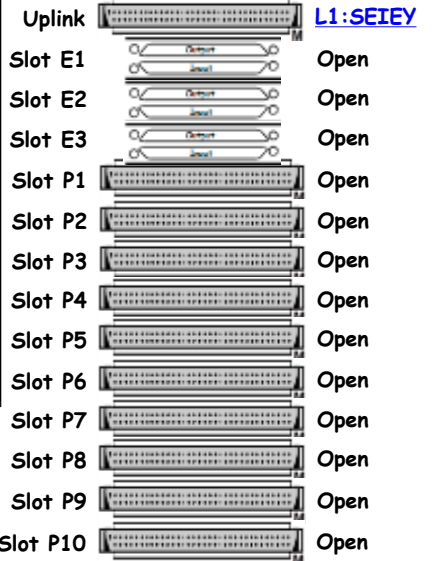

L1:SEIEY

Binary IO Card

Binary IO Card

ADC Card

ADC Card

ADC Card

ADC Card

ADC Card

ADC Card

ADC Card

ADC Card

ADC Card

ADC Card

Slot P10

Slot P9

Slot P8

Slot P7

Slot P6

Slot P5

Slot P4

Slot P3

Slot P2

Slot P1

Slot E3

E3

E2

E1

P10

P9

P8

P7

P6

P5

P4

P3

P2

P1

PTY-043



D1000305 - S1300612



<< L1-SEI-YC1

Anti-Image Chassis (4*DB9) D1000305 S1300612 ±18VDC

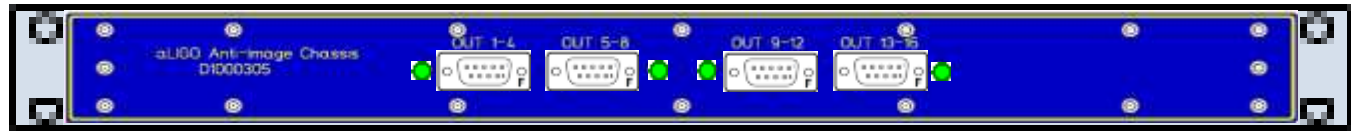

D1000305

Front

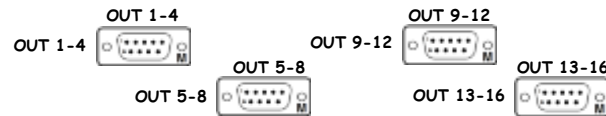

S1300612

Rear

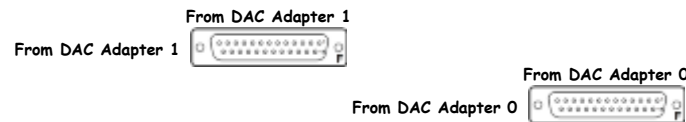



D0902744

Front



S1103362

Rear

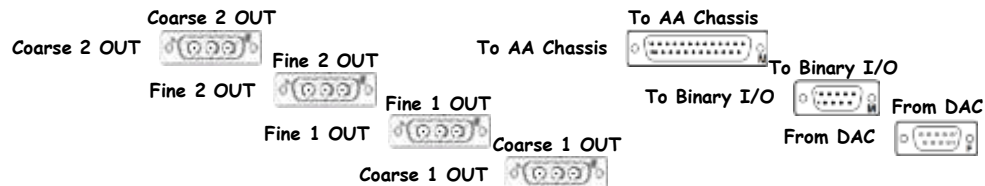



D0902744

Front



S1103311

Rear

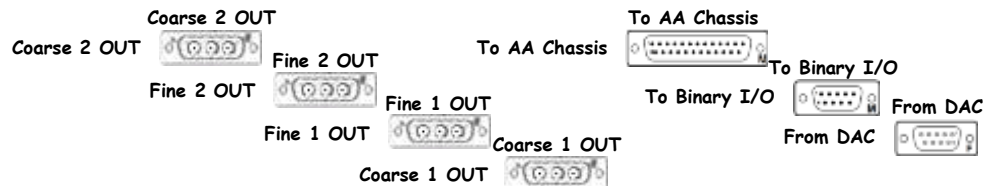



D0902744

Front



S1103328

Rear

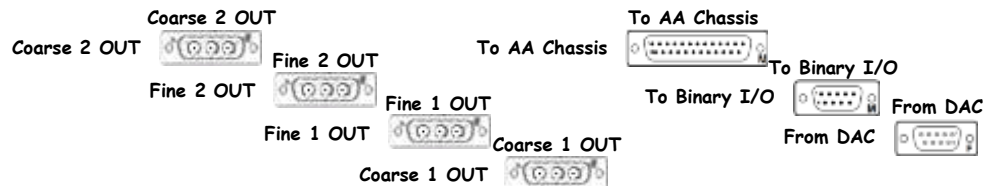

<< [CERY Racks](#)
 << [YEND Racks and Tables](#)

L1-SUS-YC1 (ETM) YEND Remote Rack 1 (of 2) Layout ([D1201089](#)) ([S1202953](#))

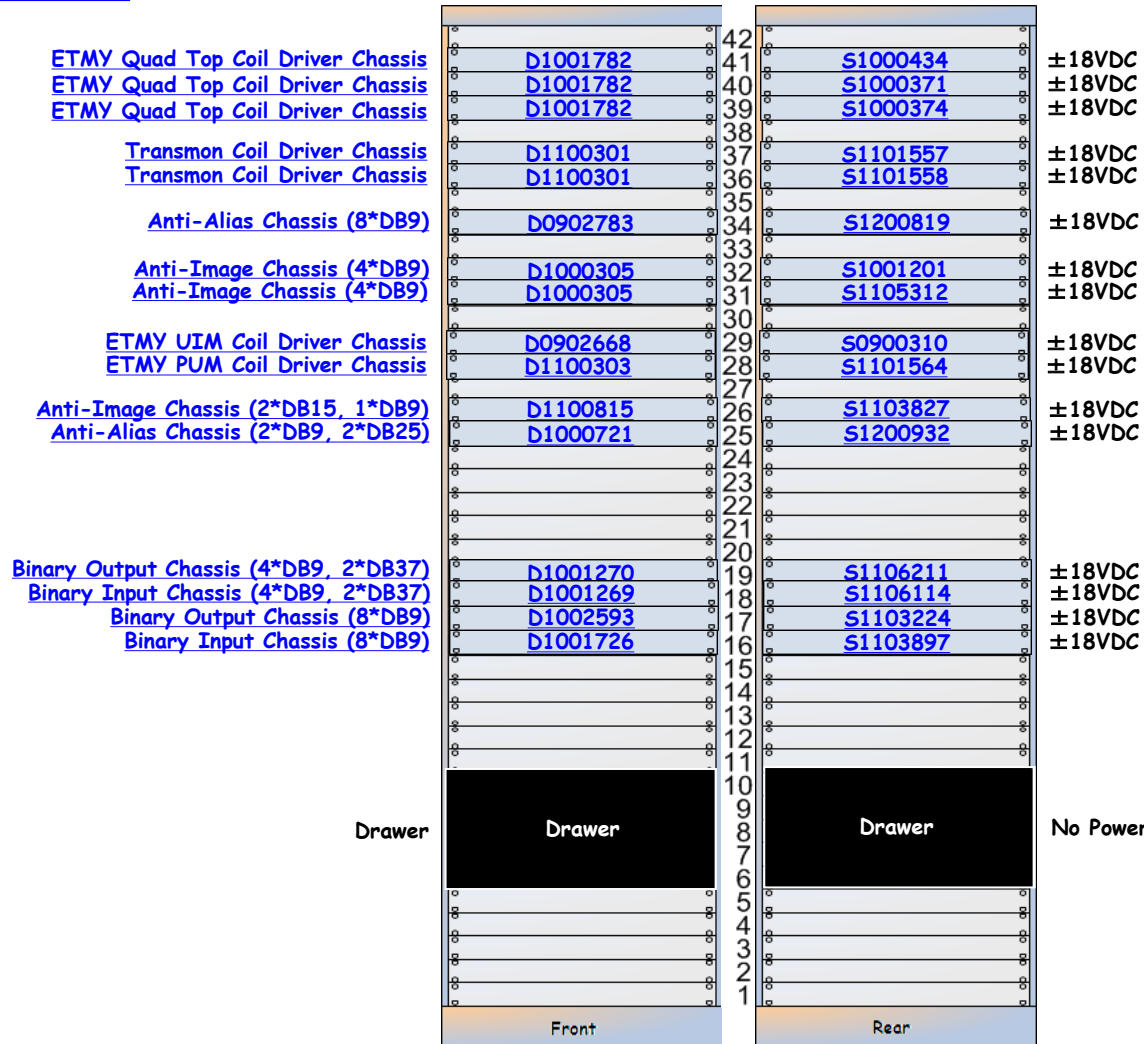

SUS-YC1 is part of [D1002741](#).

[SUS Anti-Alias Chassis](#) [D1000721](#) [S1201127](#) ±18VDC

L1-SUS-YC1 Details

SUS-YC1 is part of [D1002741](#).

D1001782 - S1000434



<< L1-SUS-YC1

ETMX Quad Top Coil Driver Chassis D1001782 S1000434 ±18VDC

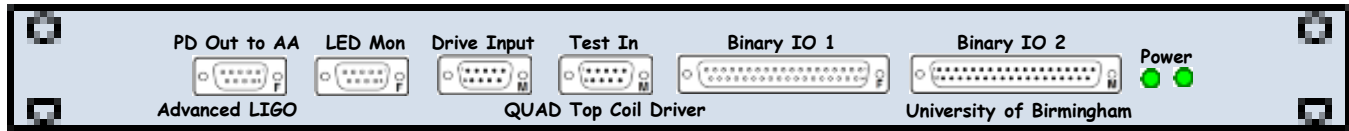

D1001782

Front

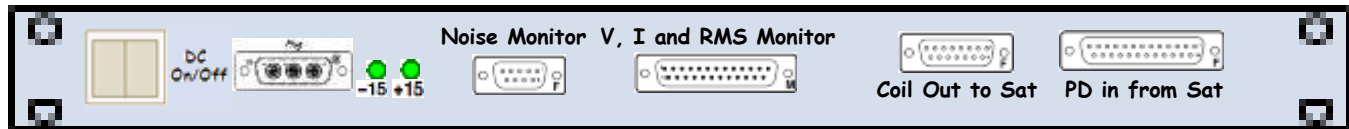
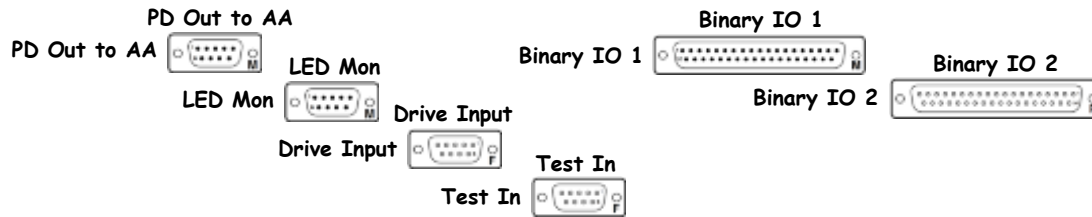

S1000434

Rear

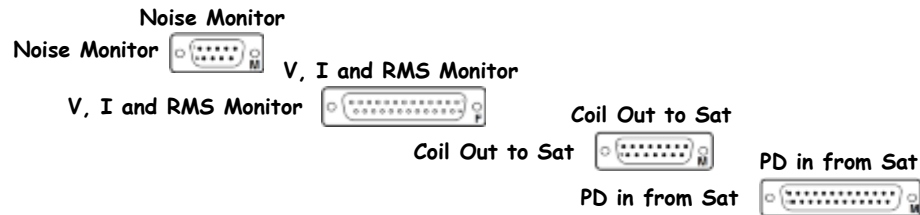

[Driver Board: D0902747](#)

[Monitor Board: D070480](#)

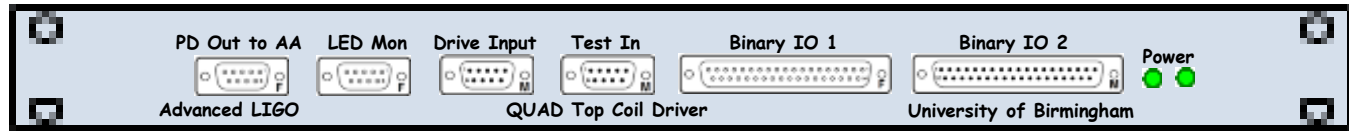

D1001782

Front

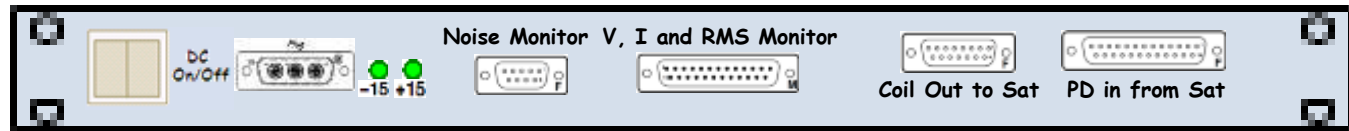
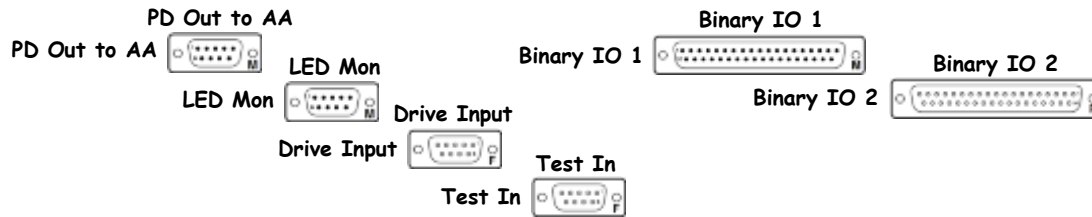

S1000371

Rear

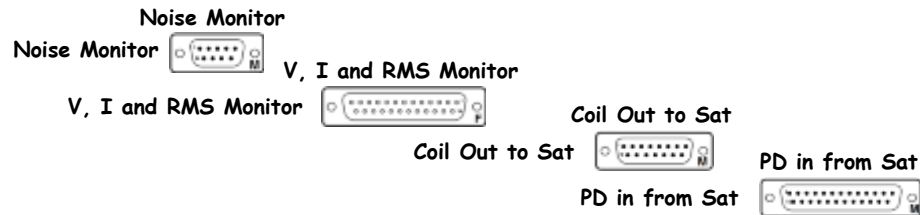

[Driver Board: D0902747](#)

[Monitor Board: D070480](#)

D1001782 - S1000374



<< L1-SUS-YC1

ETMX Quad Top Coil Driver Chassis D1001782 S1000374 ±18VDC

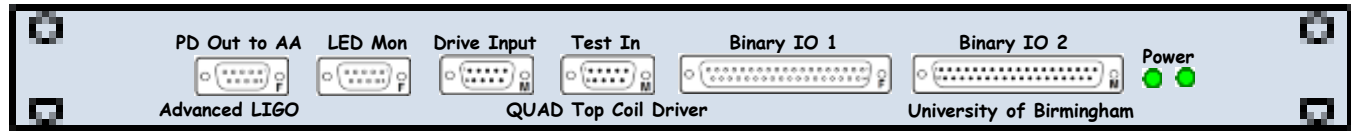

D1001782

Front

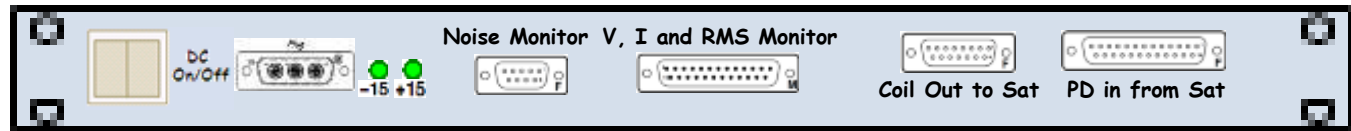
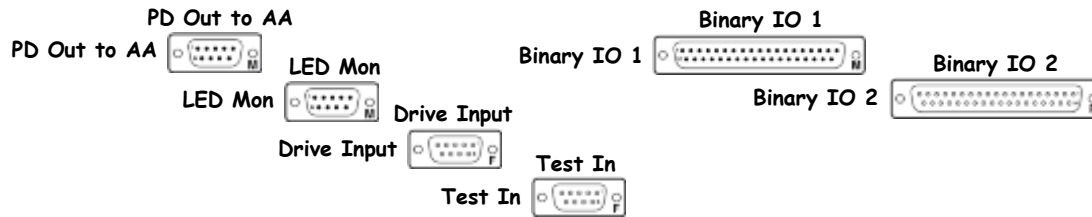

S1000374

Rear

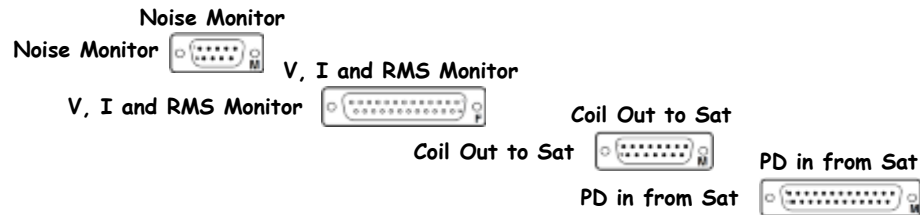

[Driver Board: D0902747](#)

[Monitor Board: D070480](#)

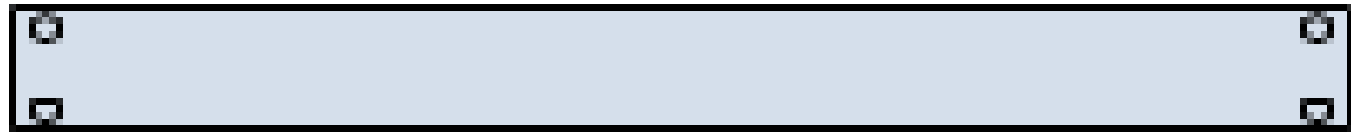

[D1100301](#)

Front

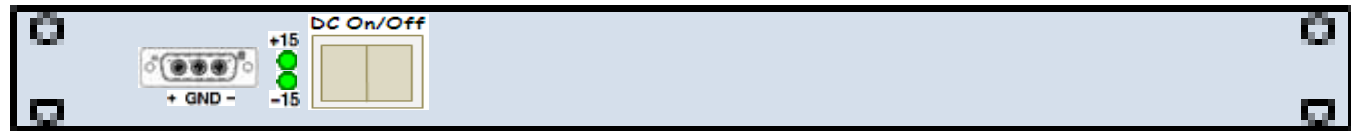

[S1101557](#)

Rear

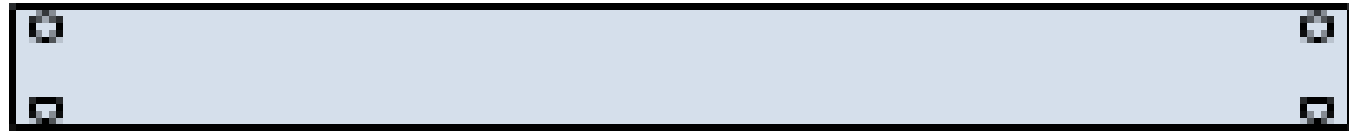

[D1100301](#)

Front

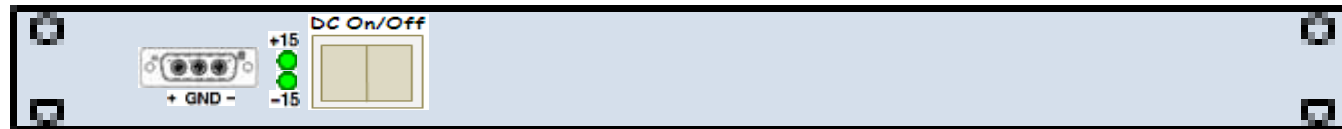

[S1101558](#)

Rear

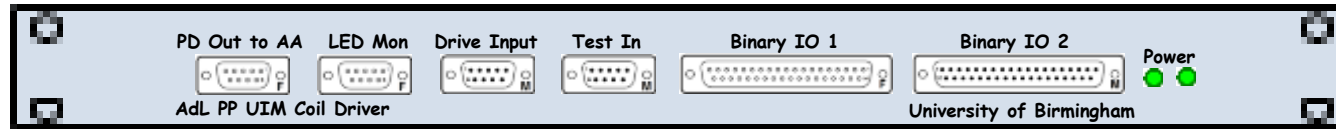

[D070481](#)
[D070480](#)
Front

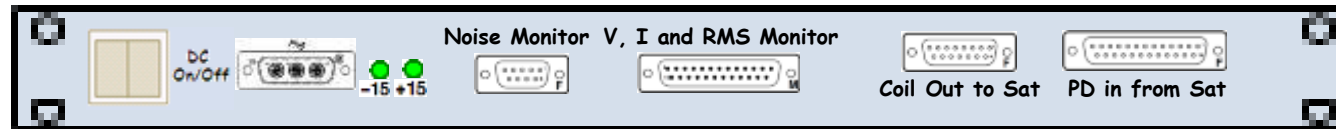
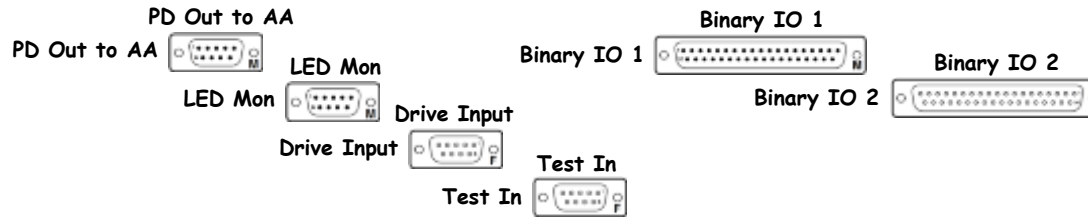

[S0900310](#)
Rear

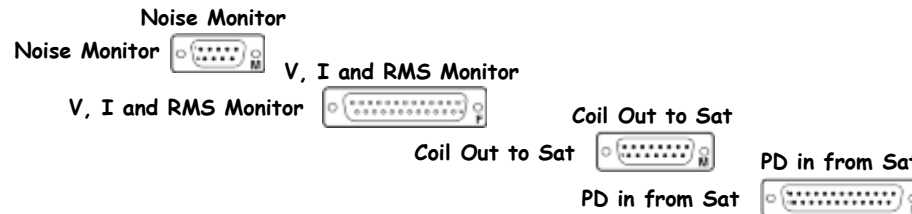

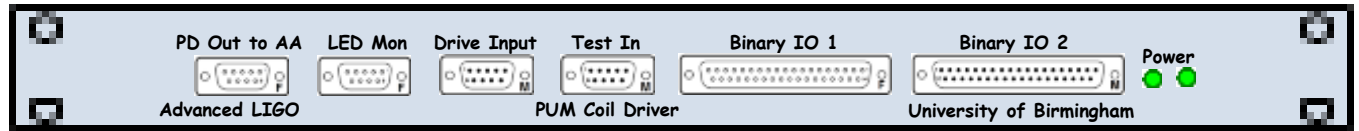

[D070483](#)
[D070480](#)
Front

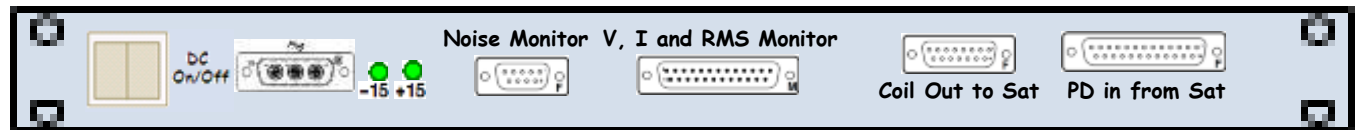
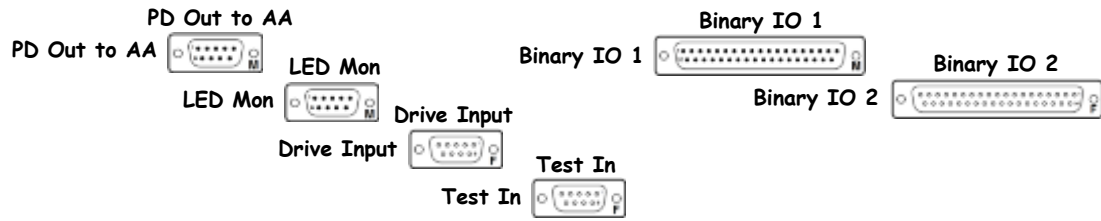

[S1101564](#)
Rear

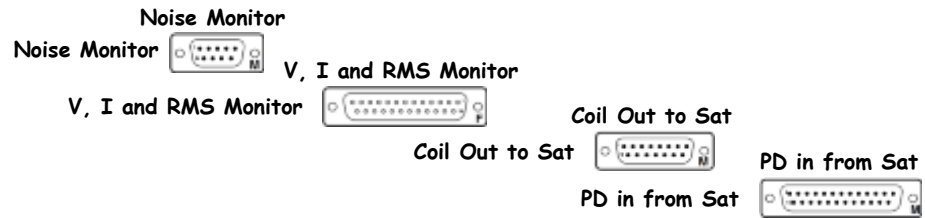

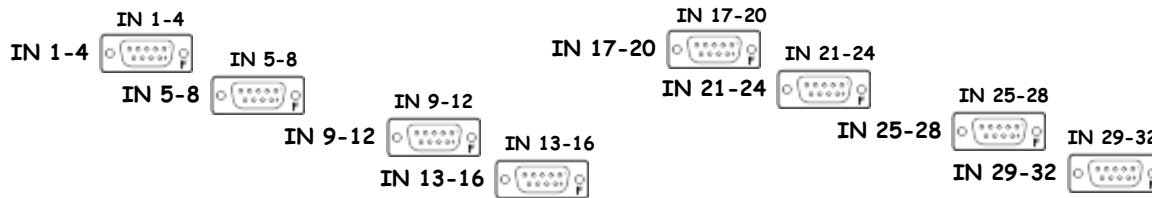
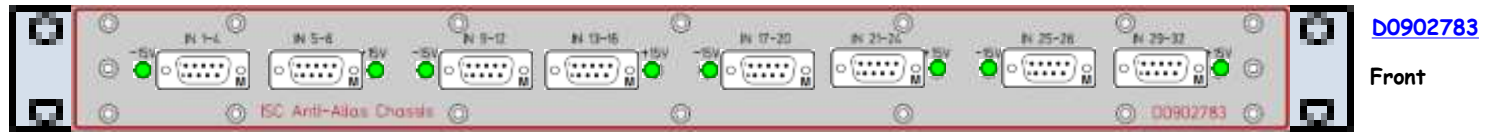

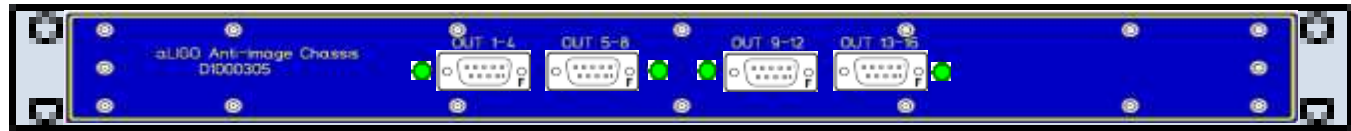

D1000305

Front

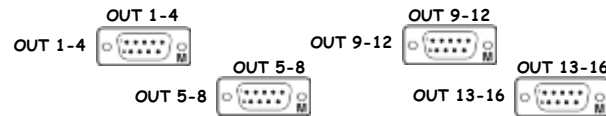

S1001201

Rear

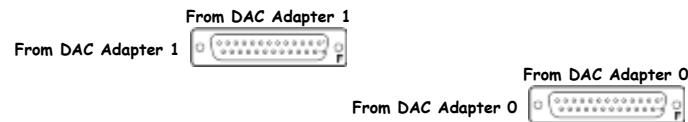

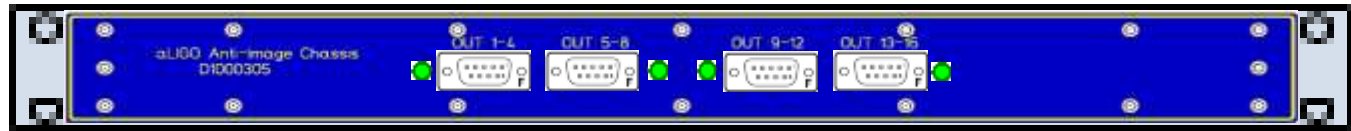

D1000305

Front

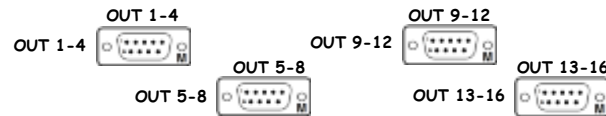

S1105312

Rear

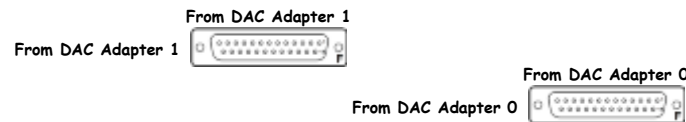

D1100815 is an AI, which means it has OUTPUTS, not INPUTS. The labels are incorrect.

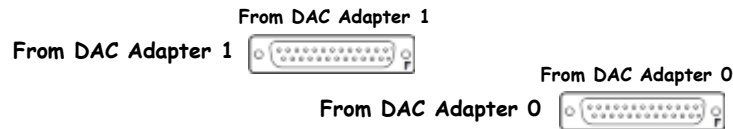
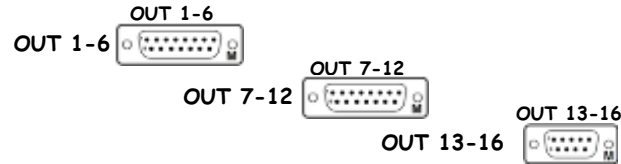

D1100815

Front

S1103827

Rear

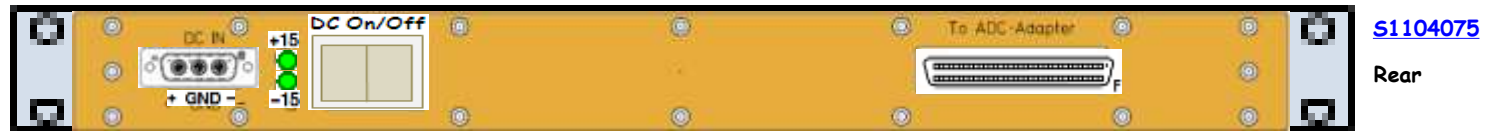
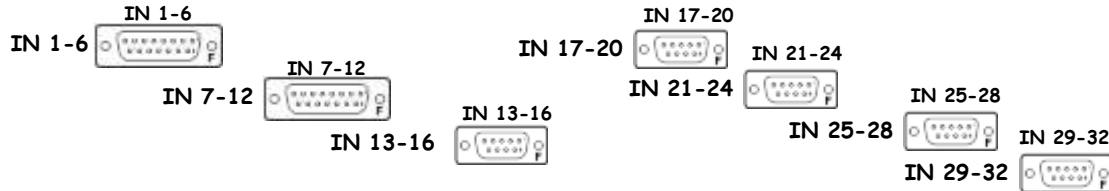
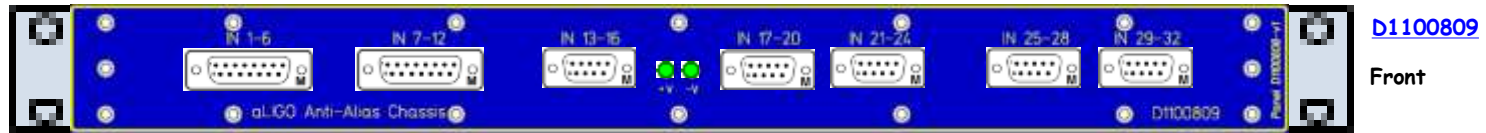

D1100809

Front

S1104075

Rear

D1000721 - S1200932



<< L1-SUS-YC1

Anti-Alias Chassis (2*DB9, 2*DB25) D1000721 S1200932 ±18VDC

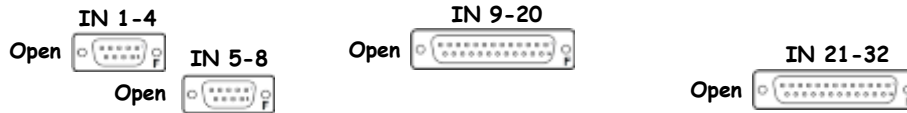

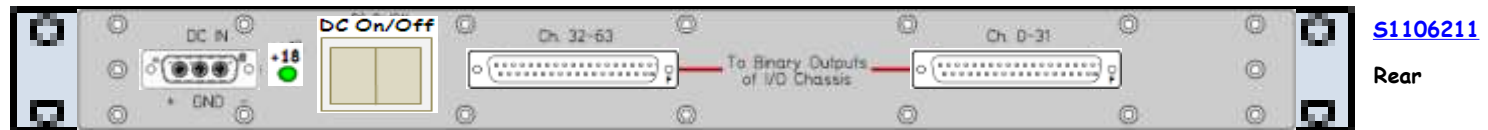
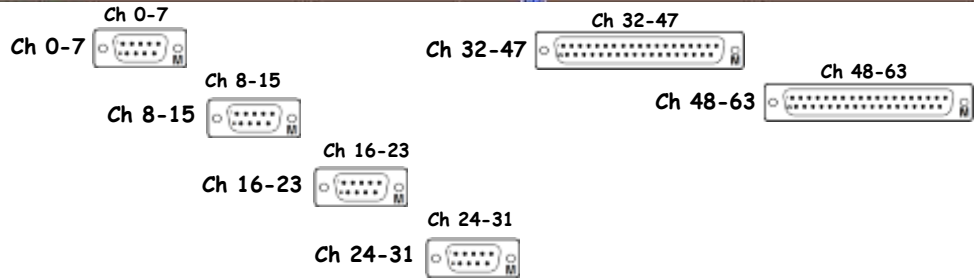

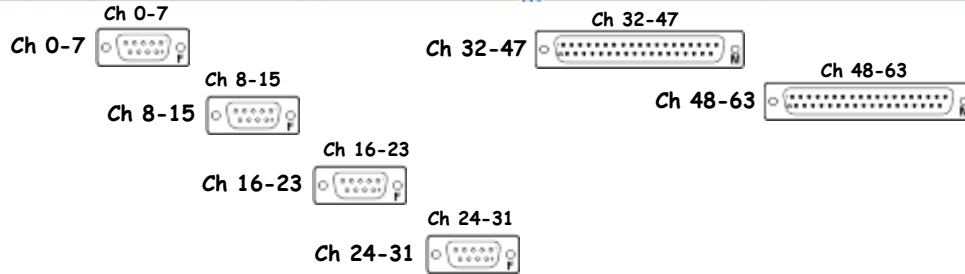
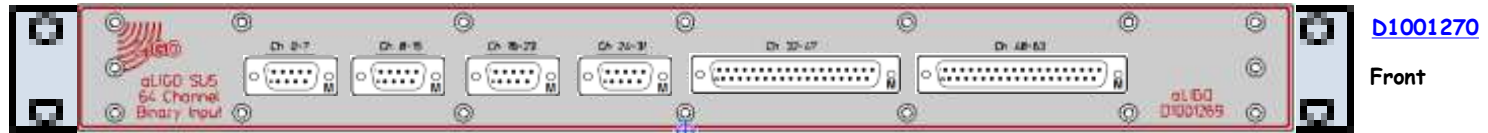

D1001270

Front

S1106114

Rear

D1002593 - S1103224



<< L1-SUS-YC1

Binary Output Chassis (8*DB9) D1002593 S1103224 ±18VDC

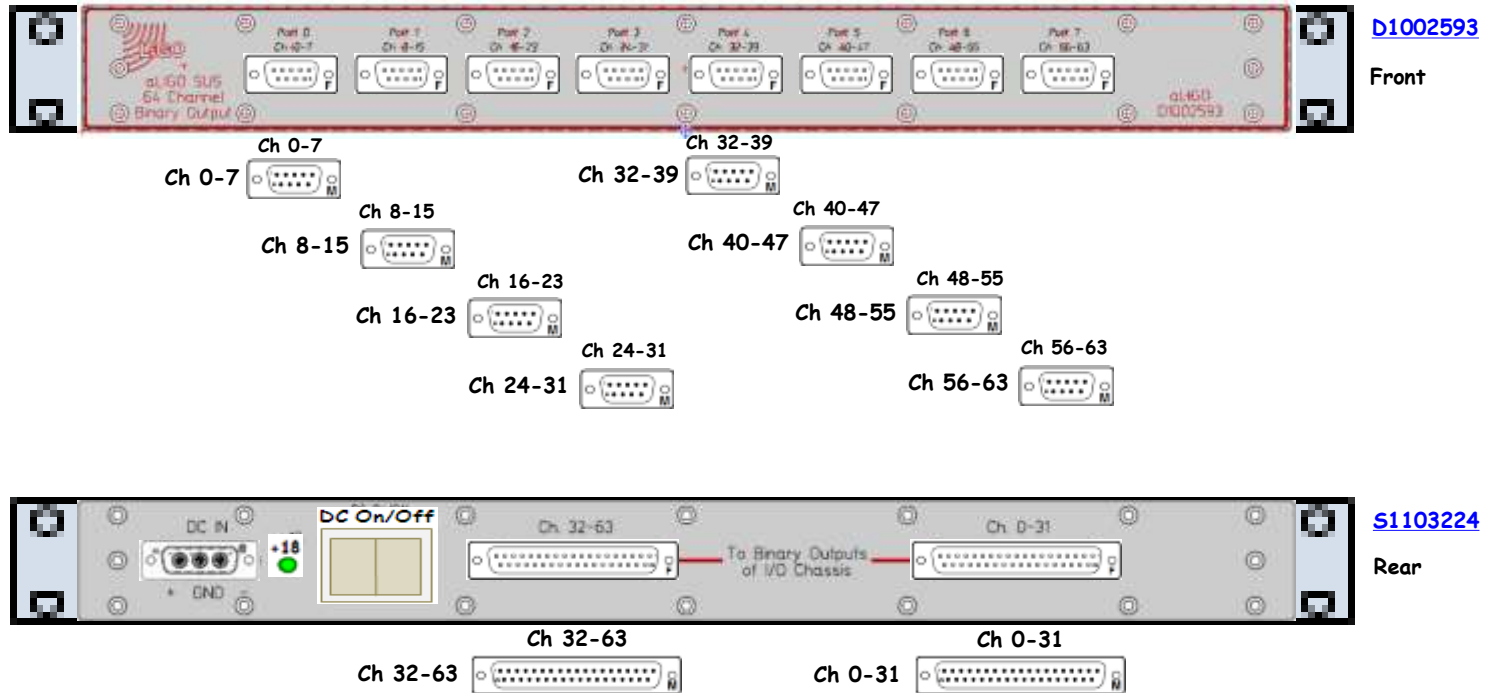

D1002593

Front

S1103224

Rear

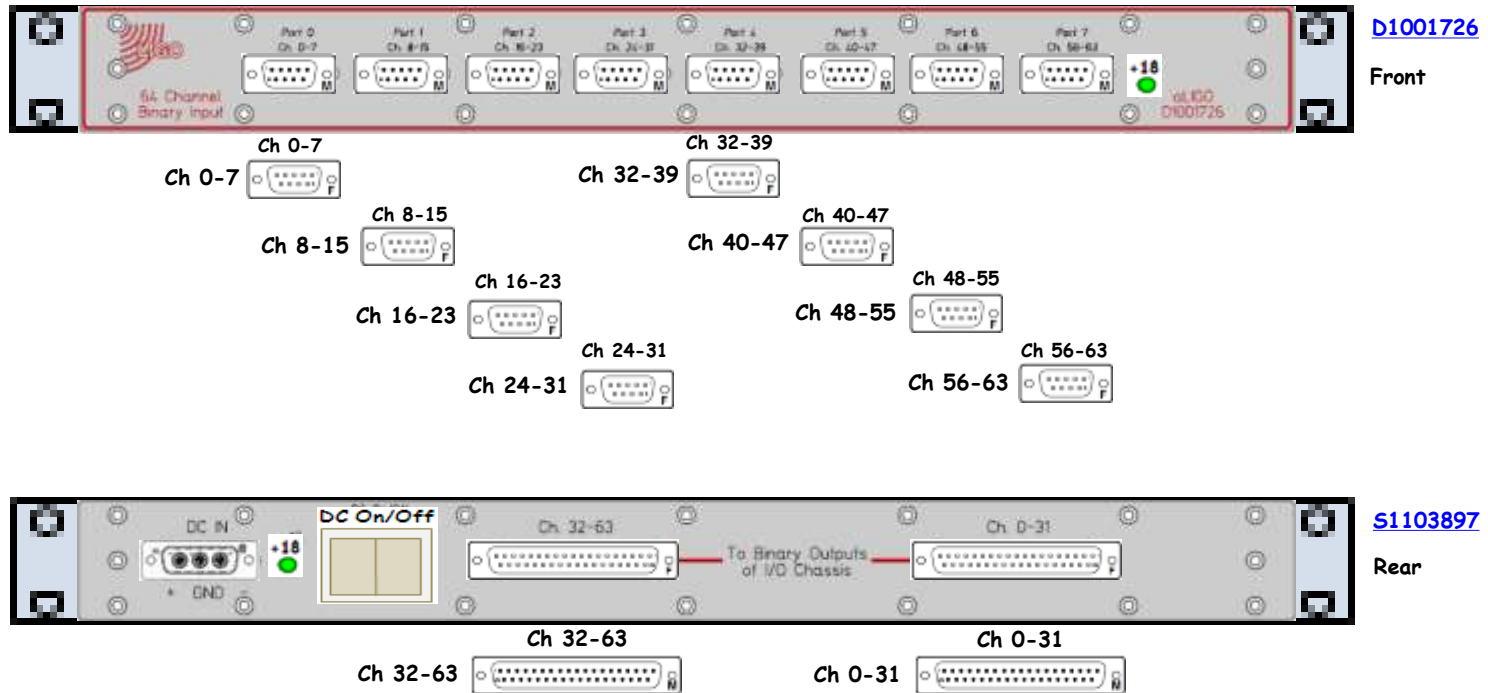

D1001726

Front

S1103897

Rear

<< [CERY Racks](#)
 << [YEND Racks and Tables](#)

L1-SUS-YC1 (ETM) YEND Remote Rack 1 (of 2) Layout ([D1201090](#)) ([S1202954](#))

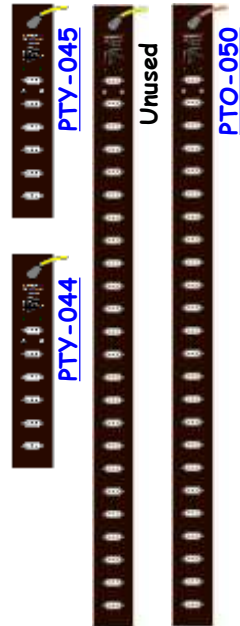
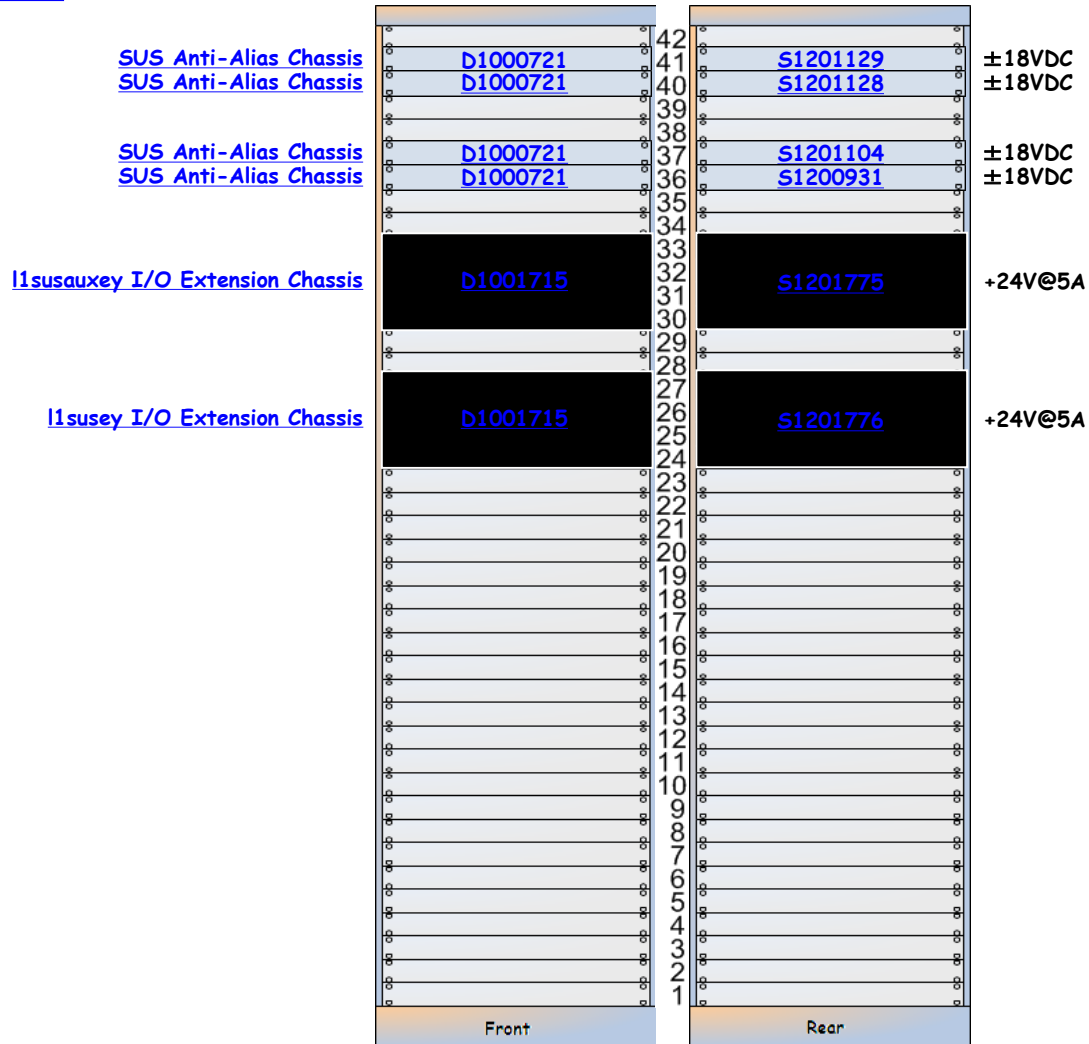

SUS-YC2 is part of [D1002741](#).

L1-SUS-YC2 Details

SUS-YC2 is part of [D1002241](#).

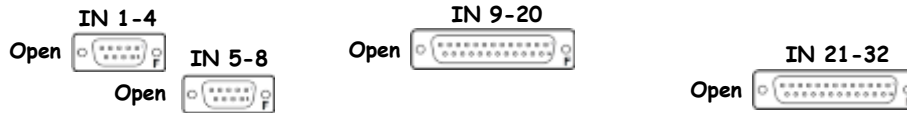

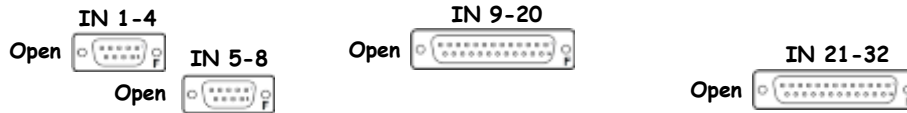

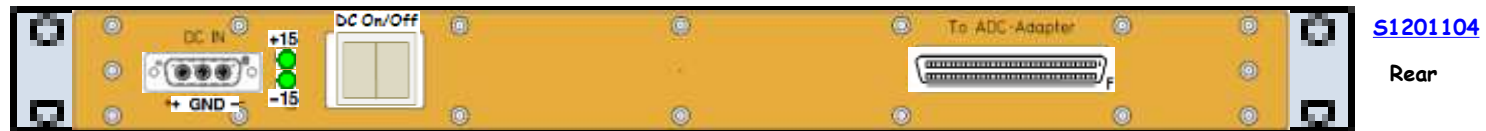
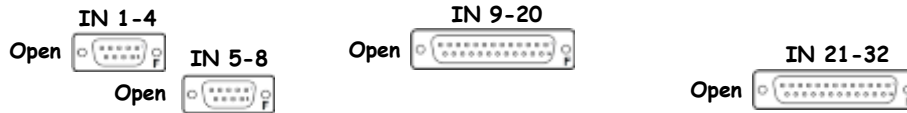

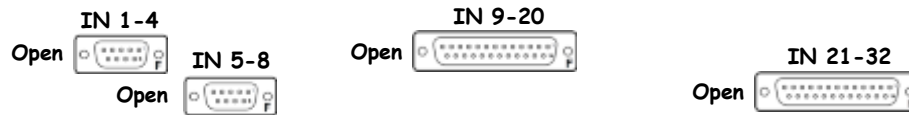



D1001715

Front

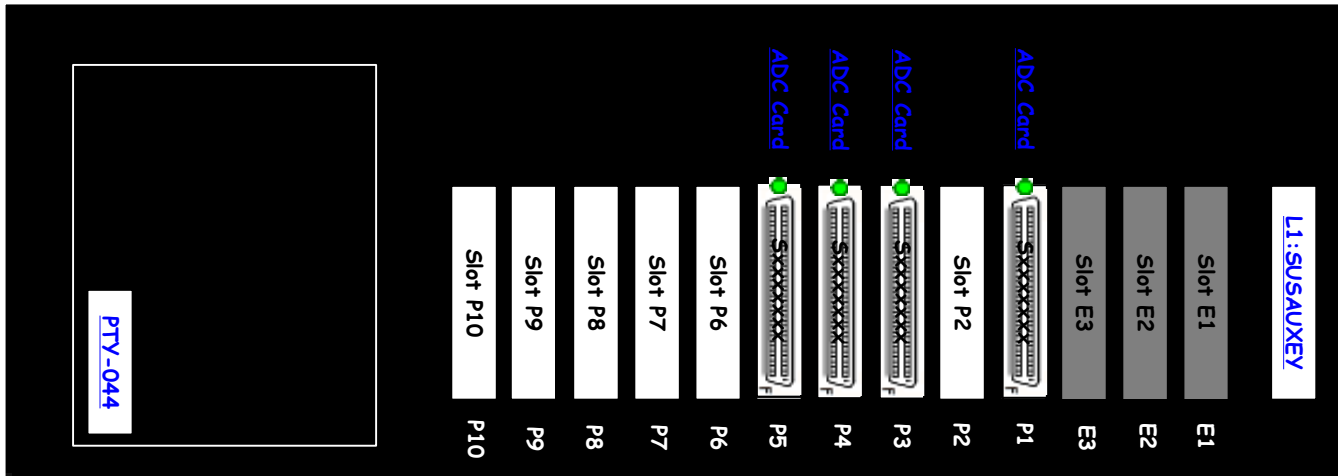

S1201775

Rear

Slot	Component	Status
Uplink	L1:SUSAUXEY	Open
Slot E1	Open	Open
Slot E2	Open	Open
Slot E3	Open	Open
Slot P1	ADC Card	Open
Slot P2	ADC Card	Open
Slot P3	ADC Card	Open
Slot P4	ADC Card	Open
Slot P5	ADC Card	Open
Slot P6	ADC Card	Open
Slot P7	ADC Card	Open
Slot P8	ADC Card	Open
Slot P9	ADC Card	Open
Slot P10	ADC Card	Open

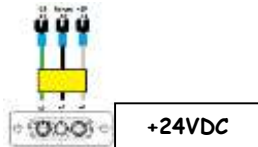



D1001715

Front

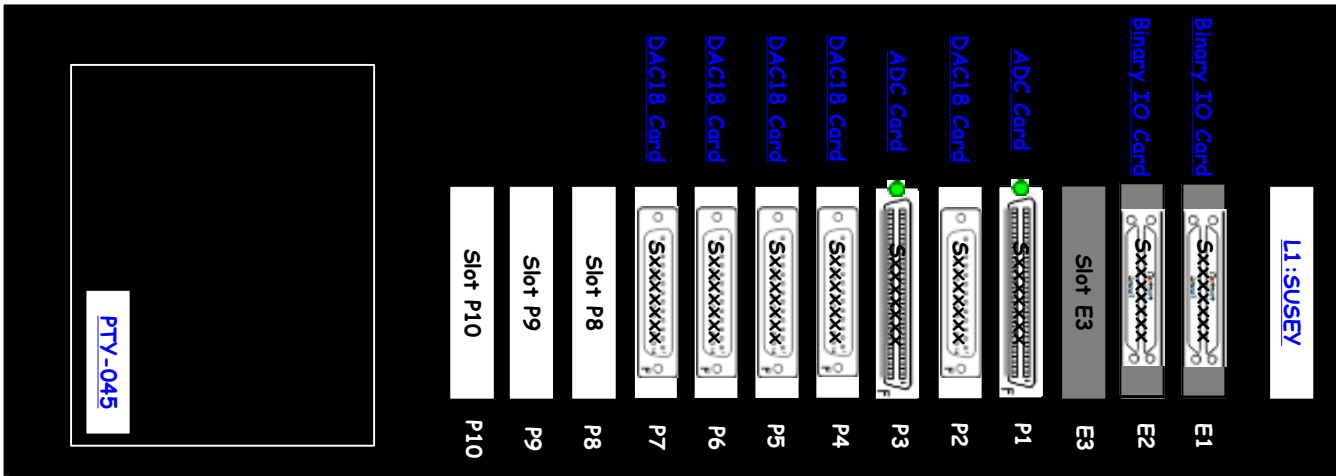

S1201776

Rear

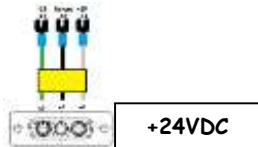
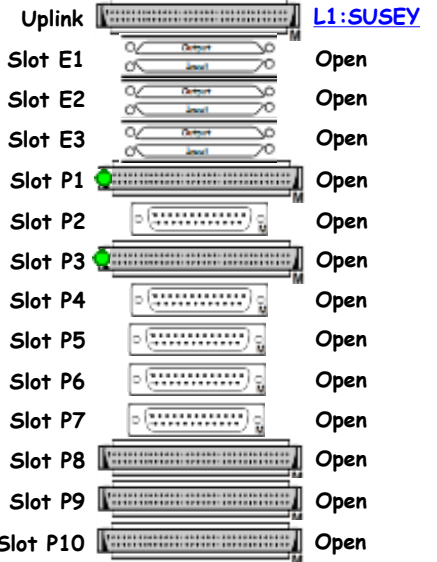

<< [CERY Racks](#)
 << [YEND Racks and Tables](#)

L1-TCS-YC1 YEND Remote Rack Layout ([D1201130](#)) ([S1202981](#))

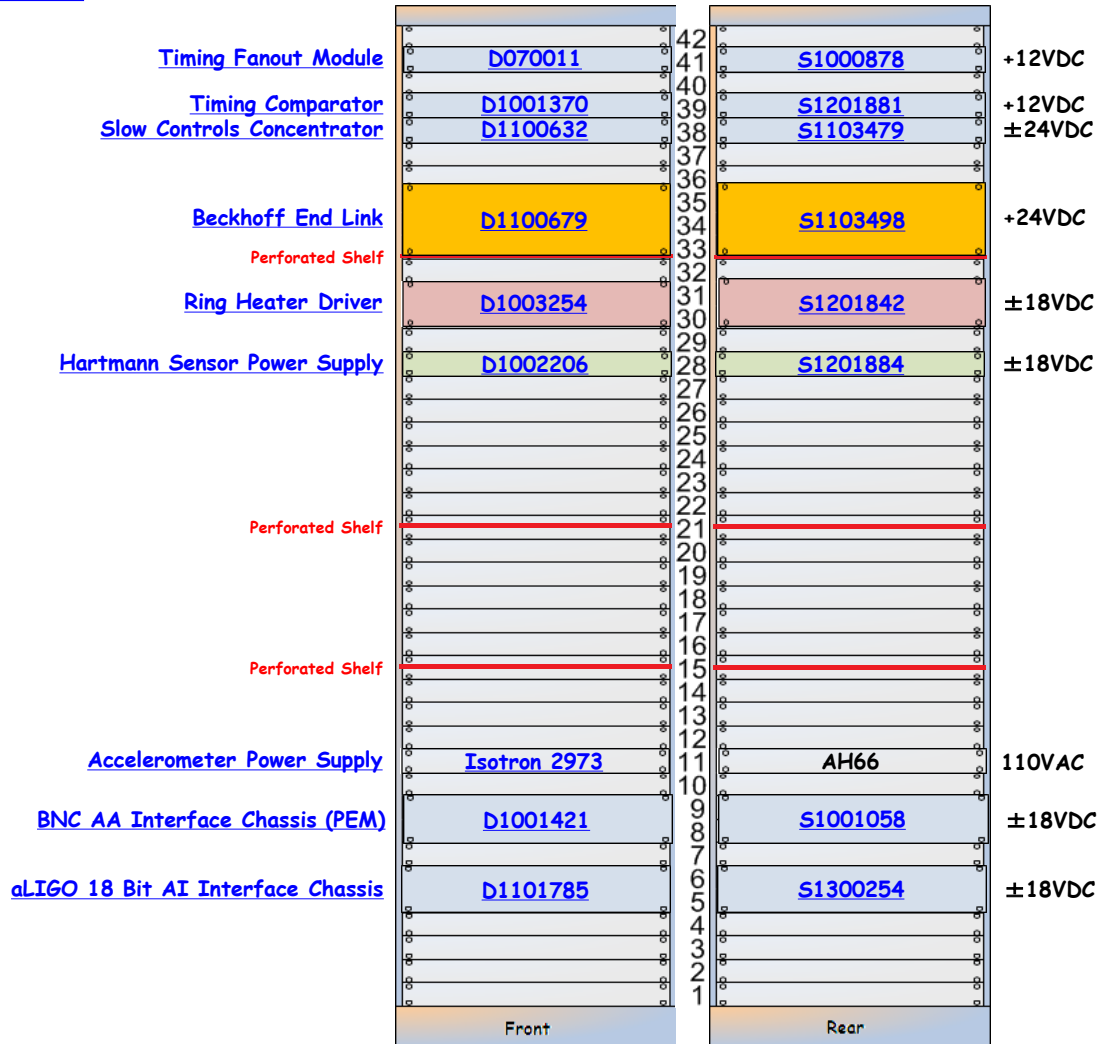

TCS-YC1 is part of [D1200258](#)
 TCS-YC1 is part of [E1100894](#)

L1-TCS-YC1 Details

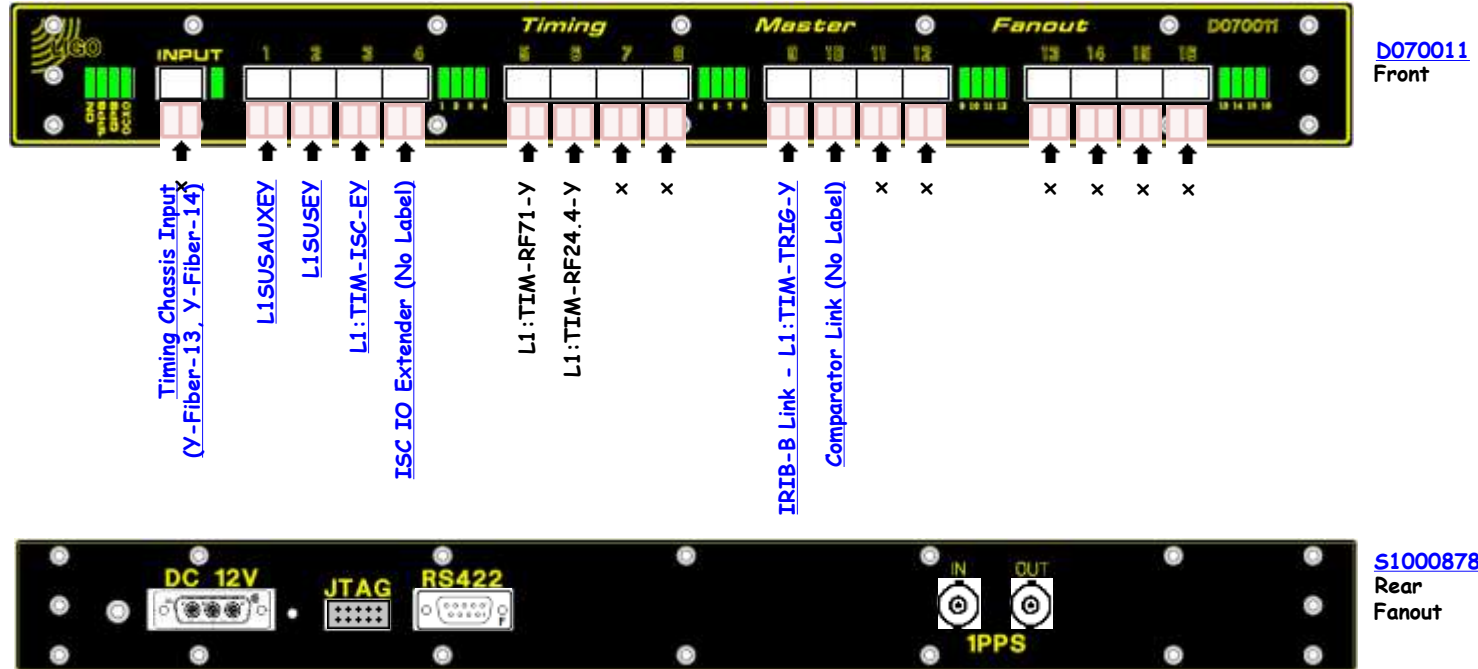

D070011
Front

S1000878
Rear
Fanout



[D1001370](#)

Front

[Comparator Link \(No Label\)](#)



[S1201881](#)

Rear



[D1100632](#)

Front

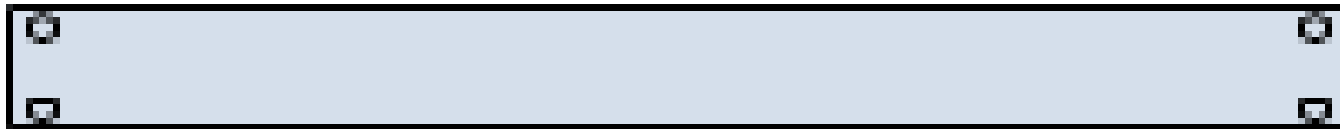

[S1103479](#)

Rear

Beckhoff End Link

D1100679

S1103498

+24VDC

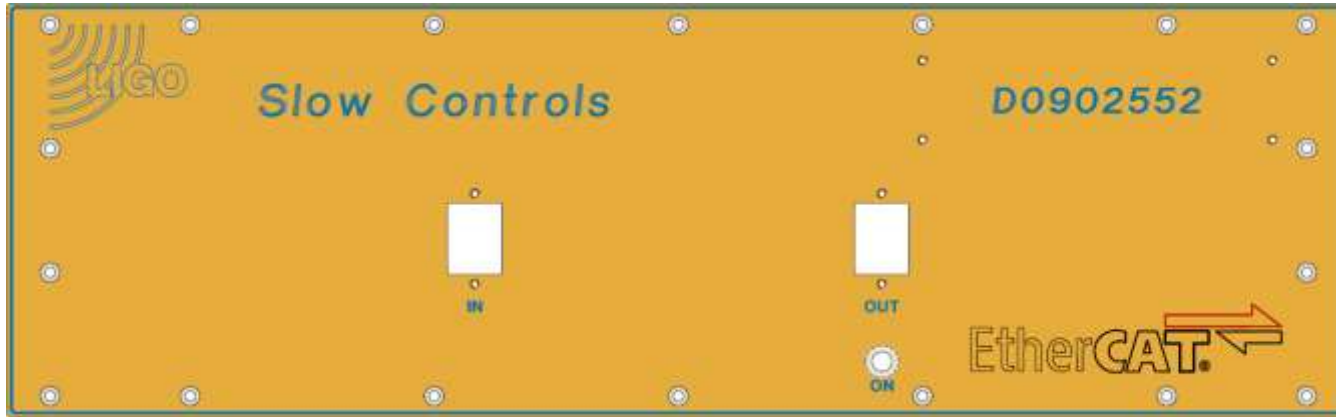

D1100679

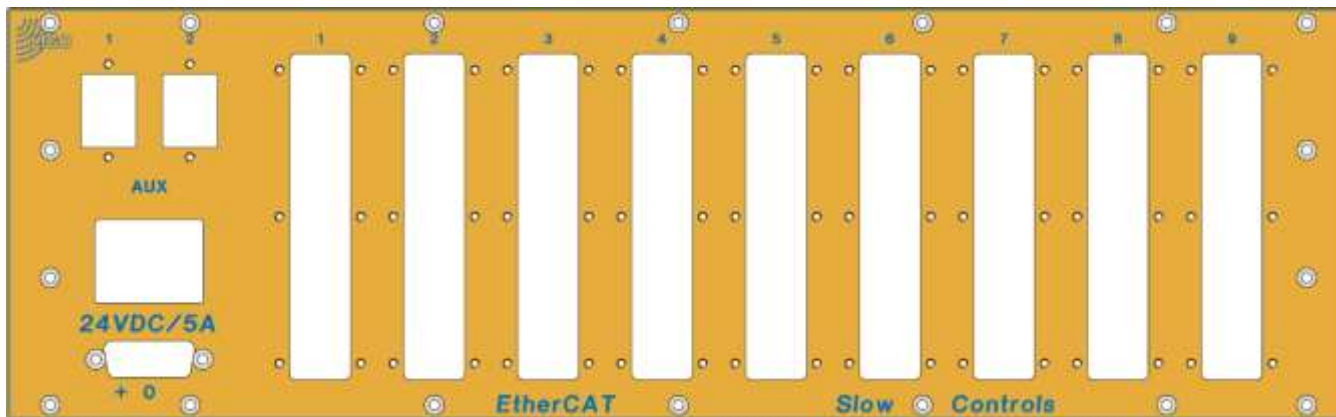

S1103498

Ring Heater Driver

D1003254

S1201842

±18VDC

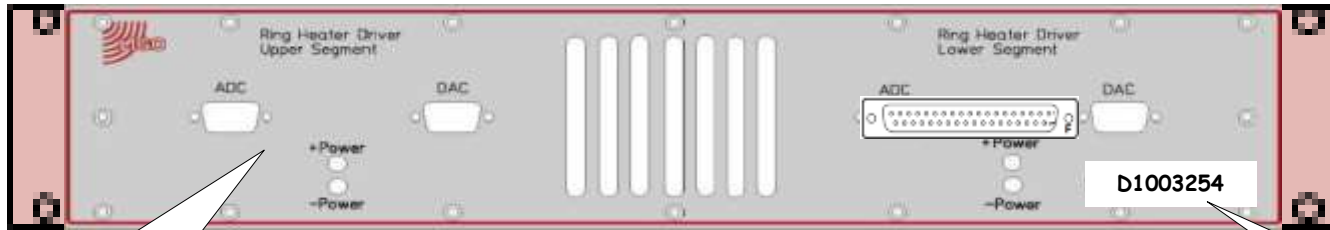

D1003254

Front

This is an early revision of the front panel. It now has one DB37M connector. 20121205 dlk

Label	Description
D1003254	

White label 20121205 dlk

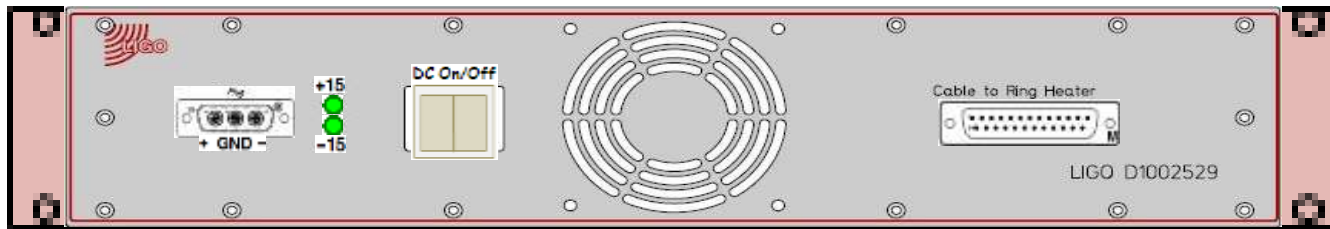

S1201842

Rear

Label	Description
Cable to Ring Heater	

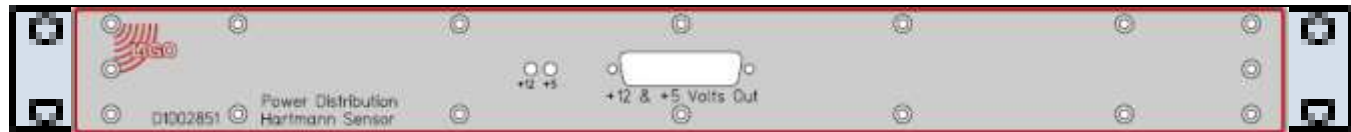

[D1102206](#)

Front



[S1201884](#)

Rear



[Isotron 2973](#)

Front

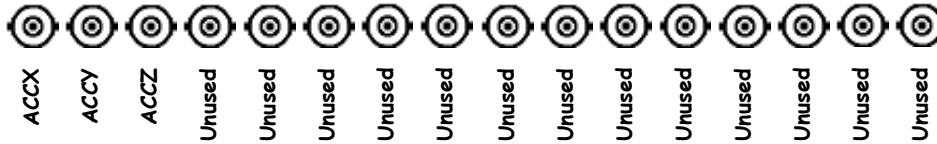

AH66

Rear

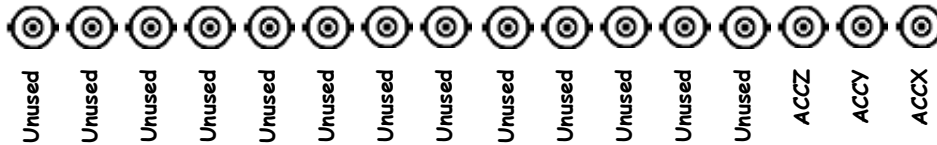

aLIGO 18 Bit AI Interface Chassis

D1101785

S1300254

±18VDC

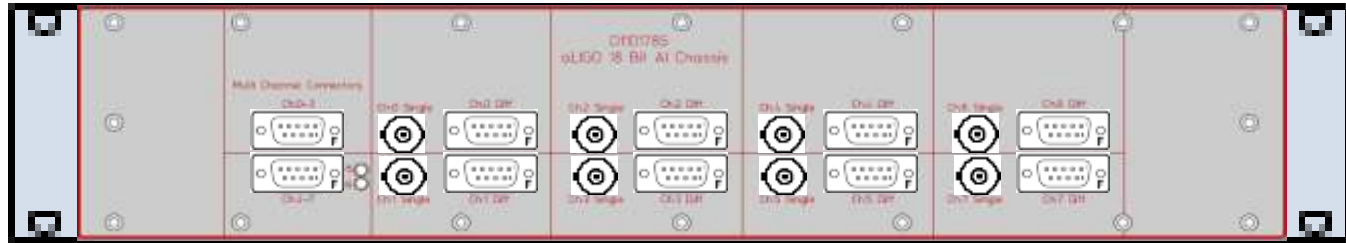

D1101785

Front

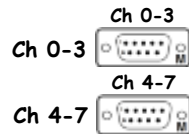

S1300254

Rear



BNC AA Interface Chassis (PEM)

[D1001421](#)

[S1001058](#)

±18VDC

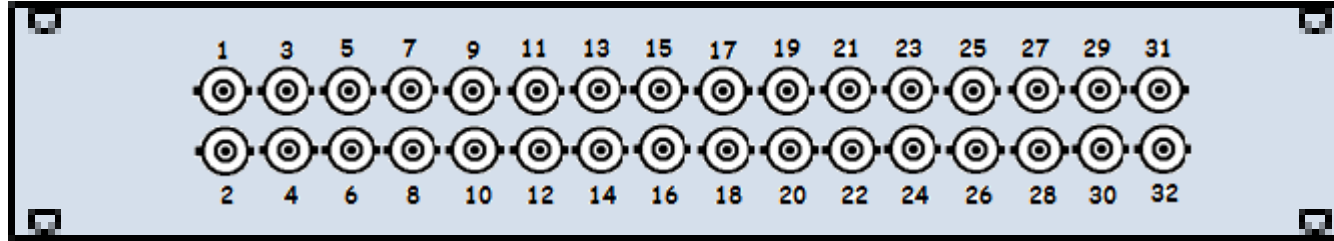

[D1001421](#)

Front

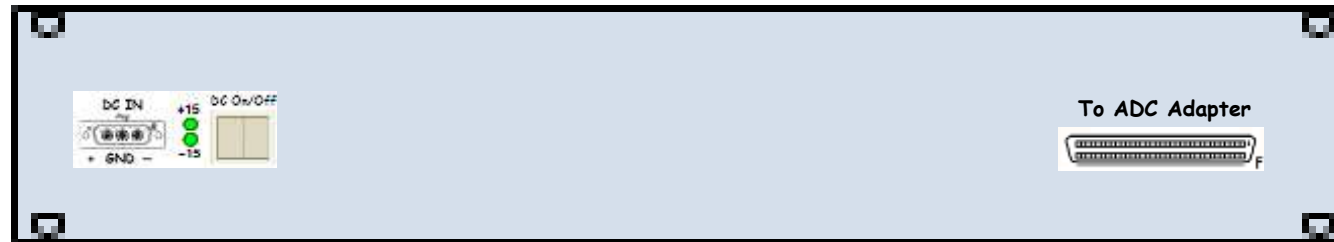
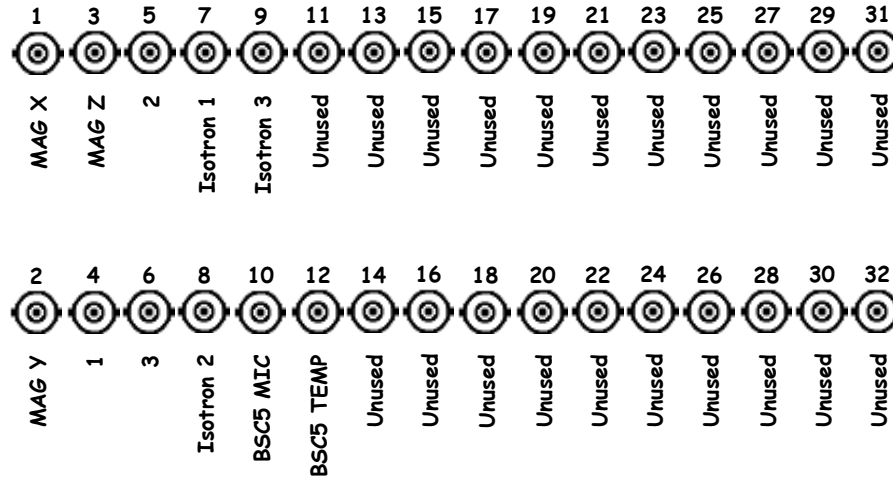

[S1001058](#)

Rear

[To l1pemey Slot P1](#)



To ADC Adapter

aLIGO Accelerometer Interface Chassis

D1101363

SN:

Power

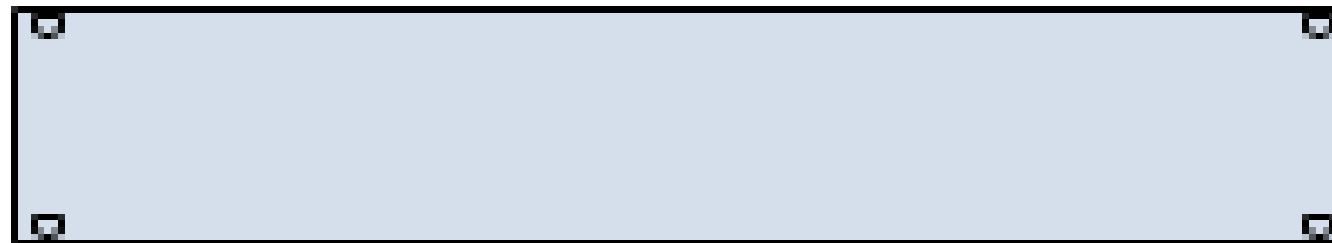
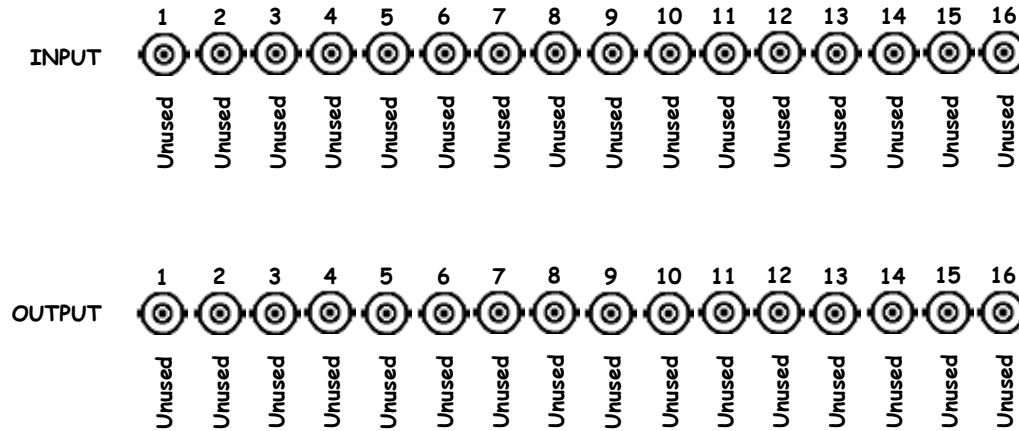
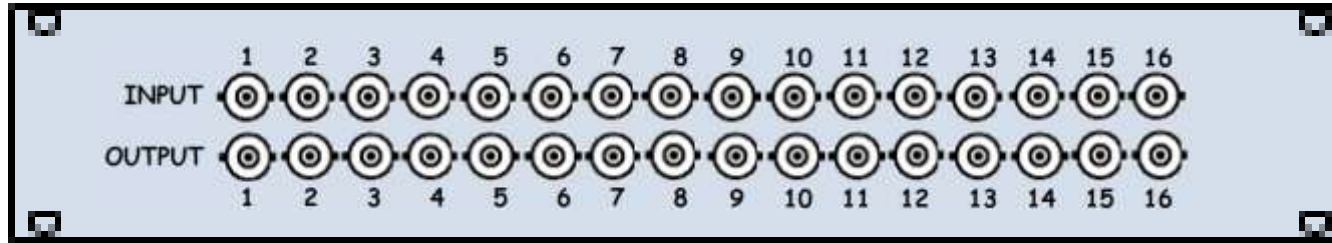



RF Distribution Panel 28
RF Distribution Panel 29
24.5 MHz Delay Line Phase Shifter
2 Channel RFPD I/Q Demod (RC & ALS)
WFS Demodulator Patch Panel
79.4 MHz VCO (ALS)
39.7 MHz Frequency Divider
RF Preamplifier
39.7 MHz 2 Channel Phase/Freq Discriminator
Common Mode Servo (ALS Laser Locking)
Common Mode Servo (ALS Cavity Locking)
Oplev 8 Channel Whitening Filter Chassis
LSC Demod Concentrator 5
ASC Demod Concentrator 6
Auxiliary Signals Concentrator 2
Auxiliary Signals Concentrator 1
Auxiliary Signals Concentrator 5
Dual DSUB Breakout Panel
Picomotor Driver and Photodiode Amplifier
ISC Whitening Chassis
QUAD I&Q Demodulator Module
LSC RFPD Demodulator Patch Panel
QUAD I&Q Demodulator Module
ISC Whitening Chassis
Legacy WFS Interface Module
Differential to Single-Ended Converter
ISC Whitening Chassis
Dual QPD Transimpedance Amplifier
Dual QPD Transimpedance Amplifier
ISC Whitening Chassis

Dxxxxxxx	42	Sxxxxxxx	No Power
Dxxxxxxx	41	Sxxxxxxx	No Power
Dxxxxxxx	40	Sxxxxxxx	No Power
D0900128	39	S1103430	±15VDC
D1000181	38	S1000786	±17VDC, ±24VDC
D1201470	37	Sxxxxxxx	No Power
D0900605	36	S1200581	±17VDC, ±24VDC
D1002182	35	S1000753	±17VDC, ±24VDC
D1201294	34	S1203938	??
D1002476	33	S1000768	±17VDC, ±24VDC
D0901781	32	S1102647	±17VDC, ±24VDC
D0901781	31	S1102646	±17VDC, ±24VDC
D1100013	30	S1101543	±18VDC
D1100691	29	S1104010	±18VDC
D1100696	28	S1103988	No Power
D1102045	27	S1200535	±17VDC
D1102065	26	S1200552	±17VDC
D1201352	25	S1300251	±17VDC
D1201450	24	Sxxxxxxx	±17VDC, ±24VDC
D1100323	23	S1400007	±24VDC, ±24VDC
D1301017	22	S1107548	±24VDC, ±24VDC
D1002559	21	S1101581	±15VDC
D0902796	20	S1001020	±15VDC
D1100956	19	Sxxxxxxx	No Power
D0902796	18	S1001016	±15VDC
D1002559	17	S1101573	±15VDC
D1100749	16	S1400282	±15VDC
D1100482	15	S1203308	±15VDC
D1002559	14	S1101629	±15VDC
D1002481	13	S1301504	±15VDC
D1002481	12	S1102816	±15VDC
D1002559	11	S1101169	±15VDC
	10		
	9		
	8		
	7		
	6		
	5		
	4		
	3		
	2		
	1		



ISC-YR1 is part of [D1001423](#)

Front

Rear

42
41
40
39
38
37
36
35
34
33
32
31
30
29
28
27
26
25
24
23
22
21
20
19
18
17
16
15
14
13
12
11
10
9
8
7
6
5
4
3
2
1



L1-ISC-XR1 Details

End Station ISC Field Rack Layout

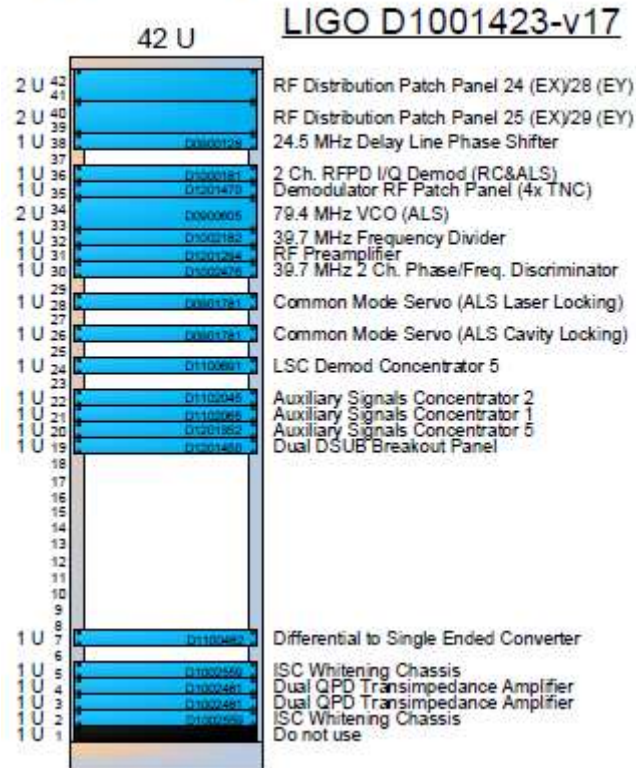

L1-ISC-YR1 Details

RF Distribution Panel 28

<< [L1-ISC-YR1](#)

RF Distribution Panel 28

Dxxxxxxx

Sxxxxxxx

No Power

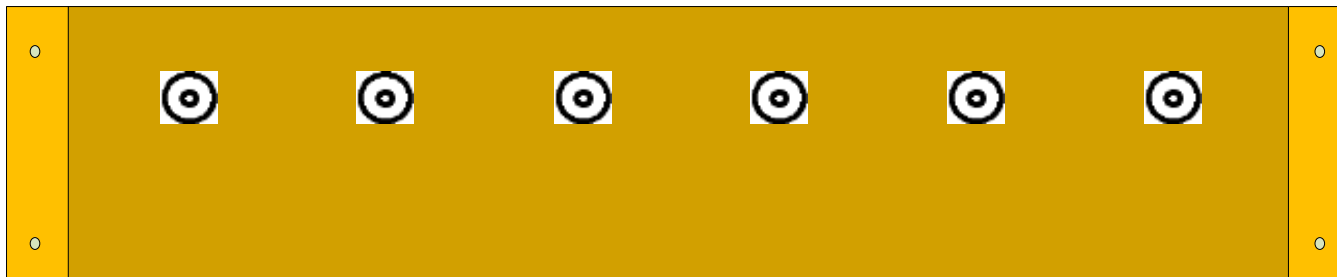

Dxxxxxxx

Front

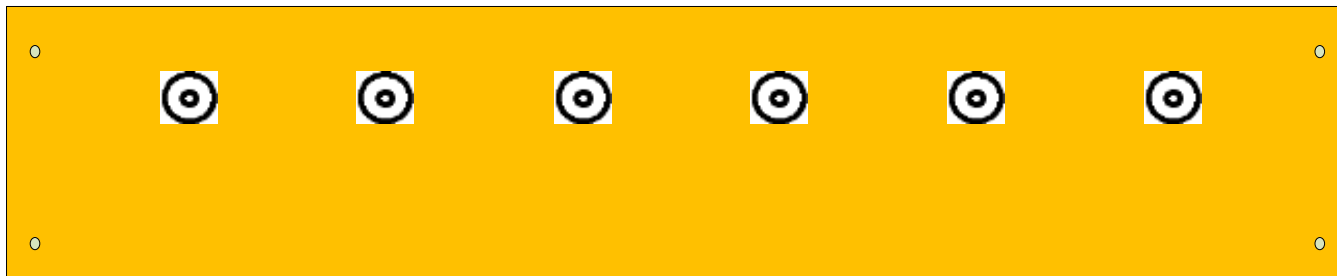

Sxxxxxxx

Rear

RF Distribution Panel 29

<< [L1-ISC-YR1](#)

RF Distribution Panel 29

Dxxxxxxx

Sxxxxxxx

No Power

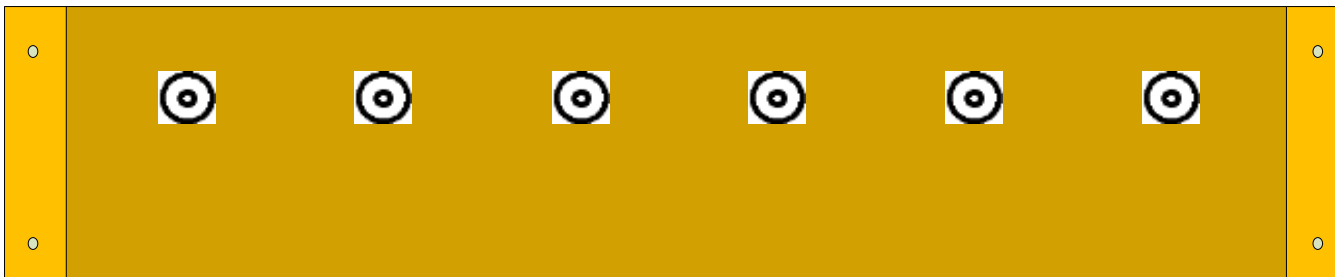

Dxxxxxxx

Front

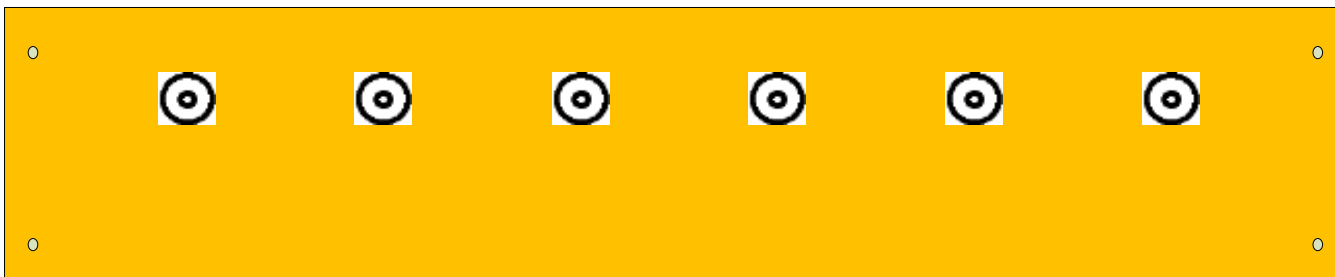

Sxxxxxxx

Rear

D0900128 - S1103430



<< L1-ISC-YR1

Delay Line Phase Shifter +15VDC



[D0900128](#)

Front



[S1103430](#)

Rear





D1000181

Front



S1000786

Rear



<< [L1-ISC-YR1](#)

WFS Demodulator Patch Panel No Power



[D1201470](#)

Front



Sxxxxxxx

Rear

<< L1-ISC-YR1

79.4 MHz VCO (ALS)

D0900605

S1200581

±17VDC, ±24VDC

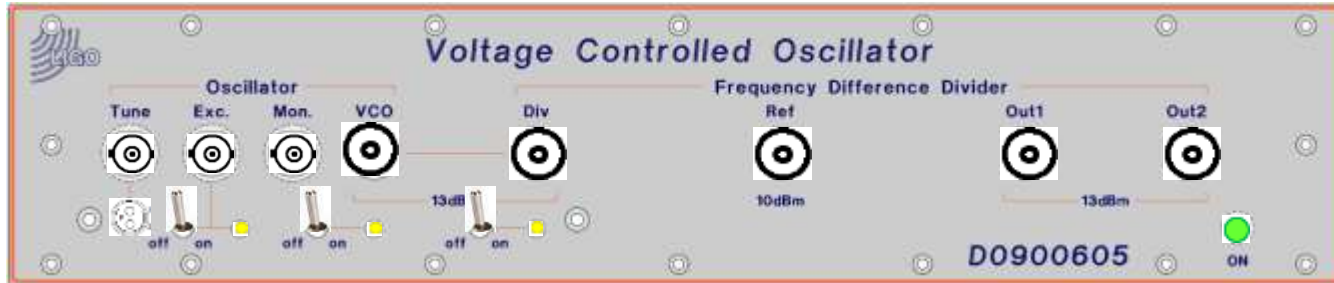

D0900605

Front



S1200581

Rear

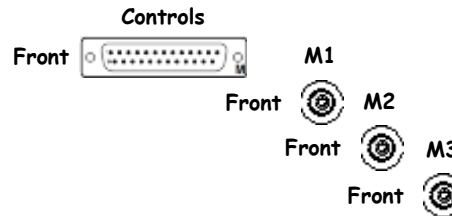
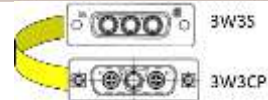

D1002182 - S1000753



<< L1-ISC-YR1

39.7 MHz Frequency Divider

D1002182

S1000753

±17VDC, ±24VDC



D1002182

Front



S1000753

Rear

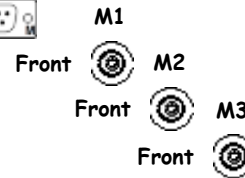
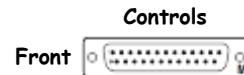
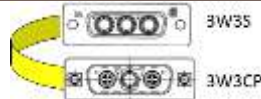

D1201294 - S1203938



<< L1-ISC-YR1

RF Preamplifier D1201294 S1203938 ±18V



[D1201294](#)

Front



[S1203938](#)

Rear

D1002476 - S1000768



<< L1-ISC-YR1

39.7 MHz 2 Channel Phase/Freq Discriminator

D1002476

S1000768

±17VDC, ±24VDC

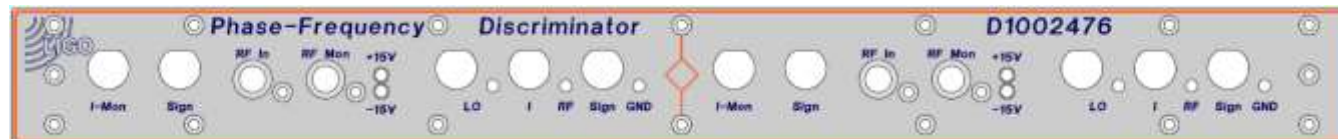

D1002476

Front



S1000768

Rear



Controls



D0901781

Front



S1102647

Rear

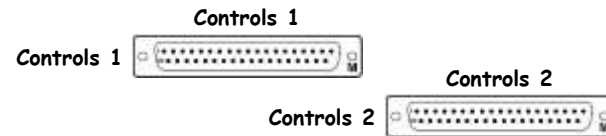
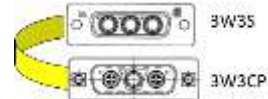



D0901781

Front



S1102646

Rear

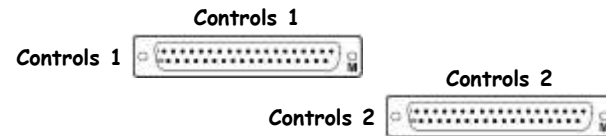

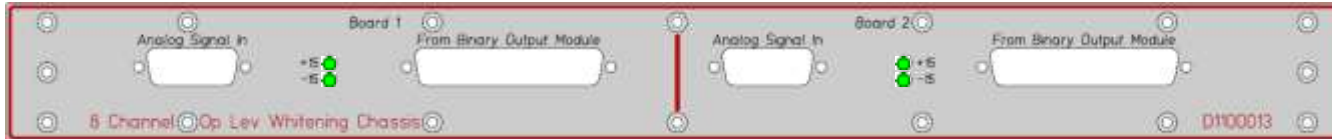

[D1100013](#)

Front



[S1101543](#)

Rear



[D1100691](#)

Front



[S1104010](#)

Rear

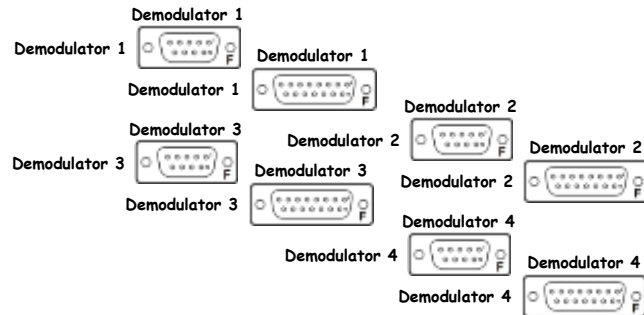
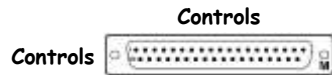



D1100696

Front



S1103988

Rear

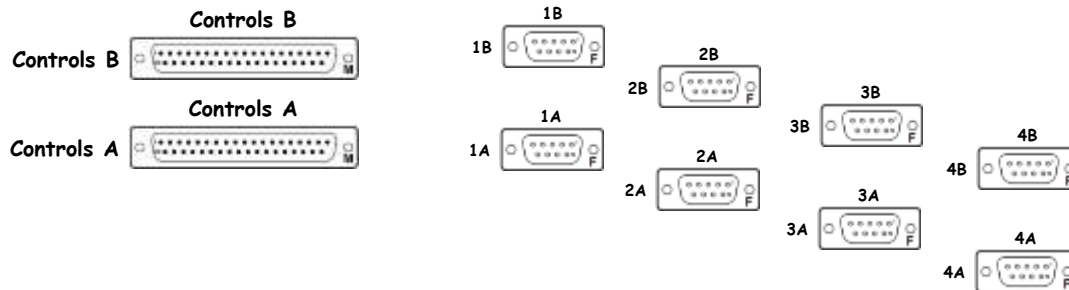

Auxiliary Signals Concentrator 2 D1102045 S1200535 ±18V



D1102045

Front



S1200535

Rear

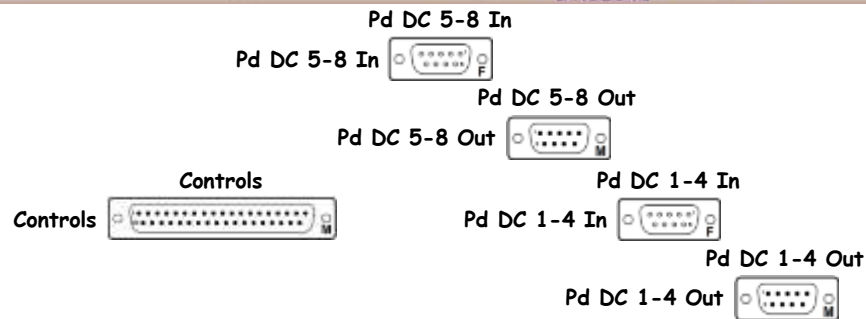

D1102065 - S1200552



<< L1-ISC-YR1

Auxiliary Signals Concentrator 1 D1102065 S1200552 ±18V



[D1102045](#)

Front



[S1200552](#)

Rear

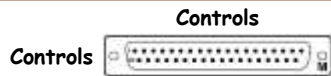

Auxiliary Signals Concentrator 5 ±18V



[D1201352](#)

Front



[S1300251](#)

Rear

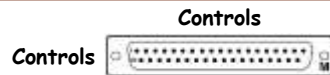

<< L1-ISC-YR1

Dual DSUB Breakout Panel No Power

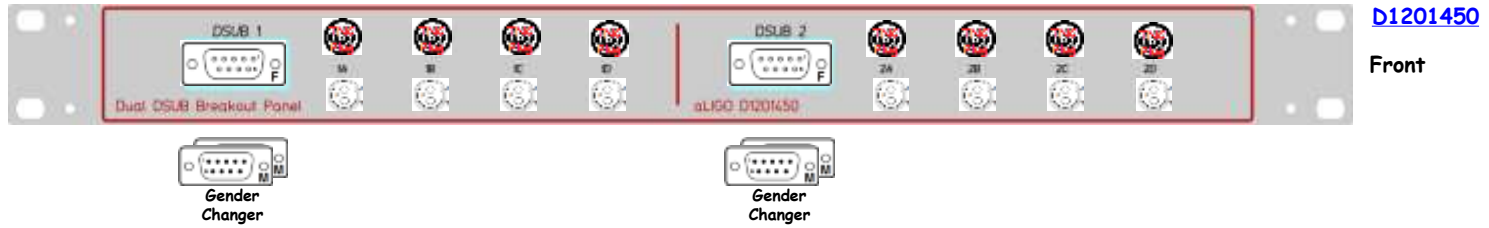

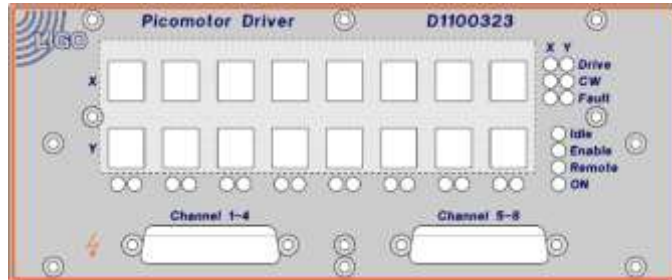

[D1100323](#)

Front

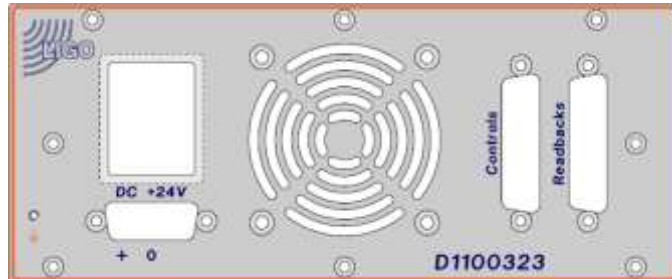

[S1107548](#)

Rear

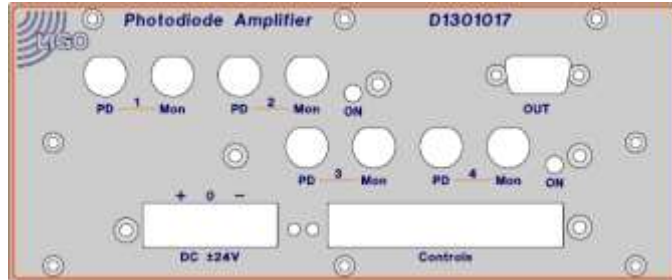

[D1301017](#)

Front

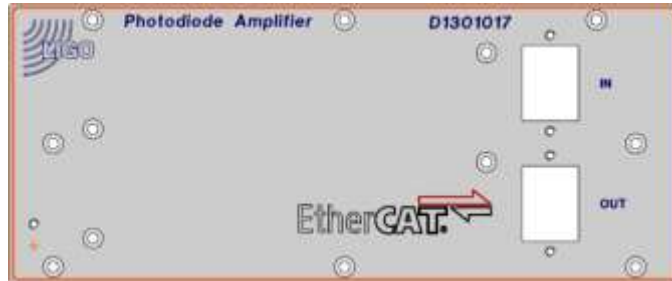

[S1400007](#)

Rear

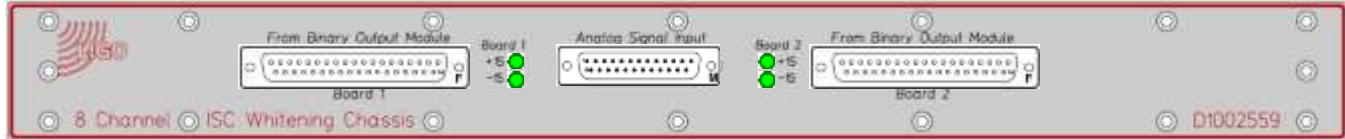

D1002559

Front

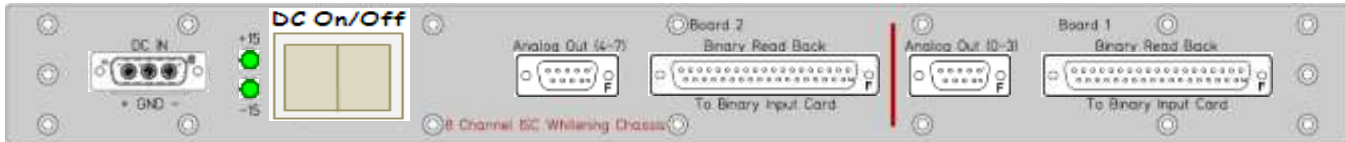
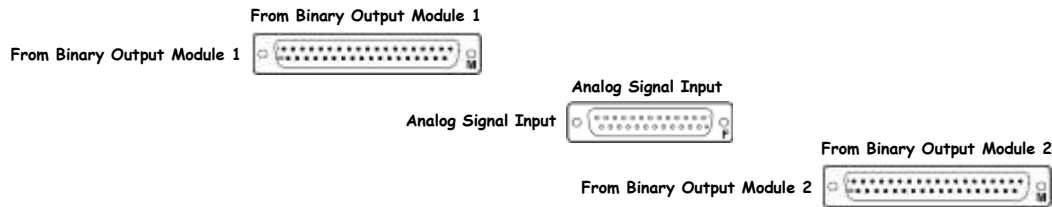

S1101581

Rear

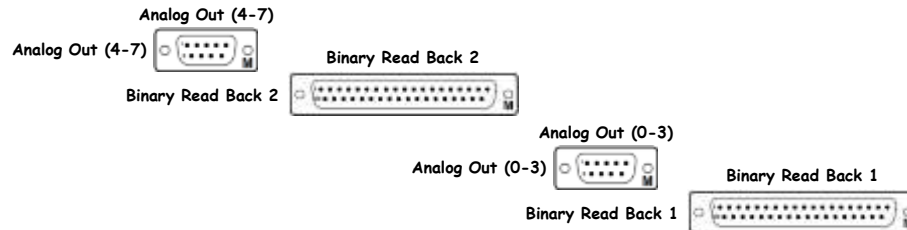

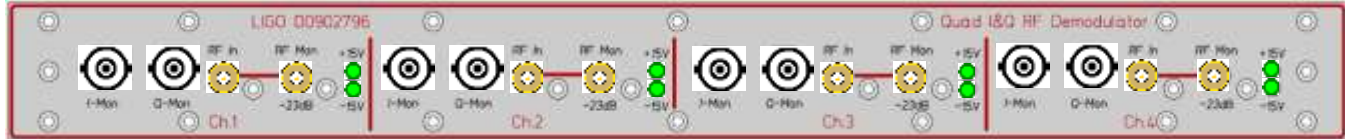

[D0902796](#)

Front

[D1002032](#)

LSC



[S1001020](#)

Rear

RF Mon Out Ch 3&4

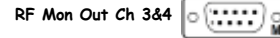

RF Mon Out Ch 3&4

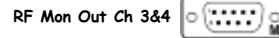

I & Q Outputs

I & Q Outputs



[D1002031](#)

WFS



[S1001020](#)

Rear

RF Mon Out Ch 3&4

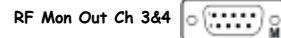

RF Mon Out Ch 3&4

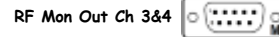

I & Q Outputs

I & Q Outputs



<< [L1-ISC-YR1](#)

LSC RFPD Demodulator Patch Panel No Power

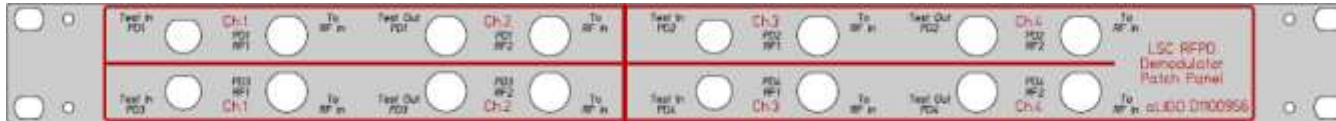

[D1100956](#)

Front

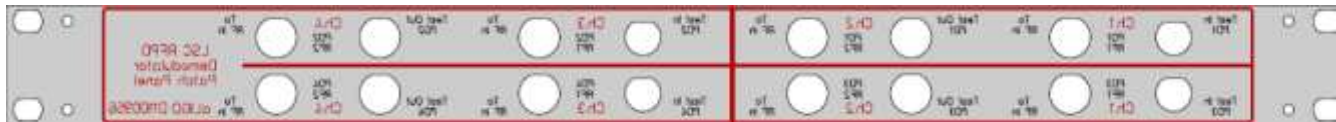

Sxxxxxxx

Rear

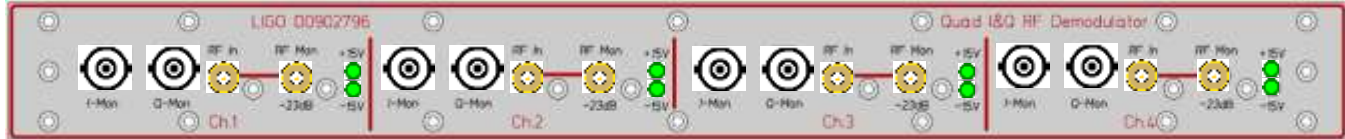

D0902796

Front

D1002032

LSC



S1001016

Rear

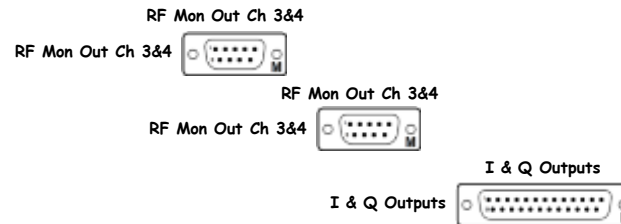

D1002031

WFS



S1001016

Rear

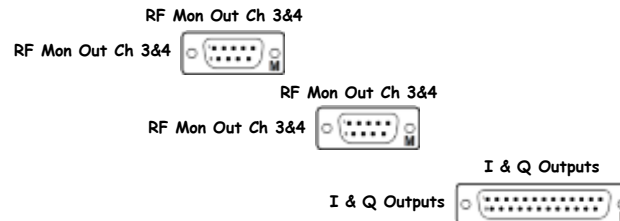



D1002559

Front

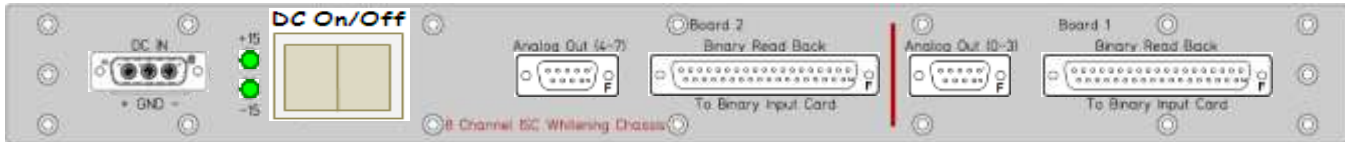
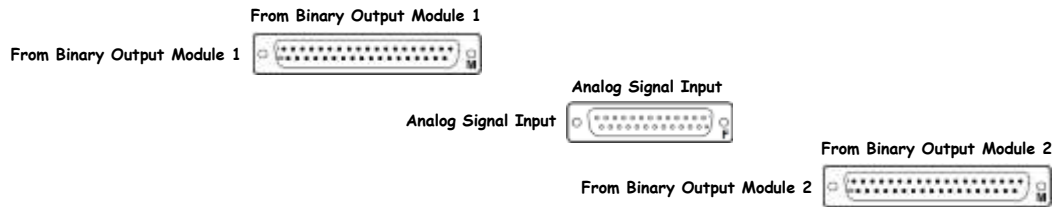

S1101573

Rear

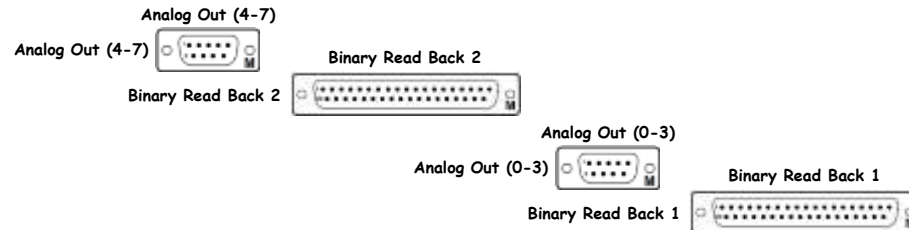



D1100749

Front



S1400282

Rear

DC Outputs-WFS 2

WFS 2 

DC Outputs-WFS 1

WFS 1 

D1100482 - S1203308



<< [L1-ISC-YR1](#)

Differential to Single-Ended Receiver ±15VDC



[D1100482](#)

Front



[S1203308](#)

Rear

Diff Inputs 



D1002559

Front

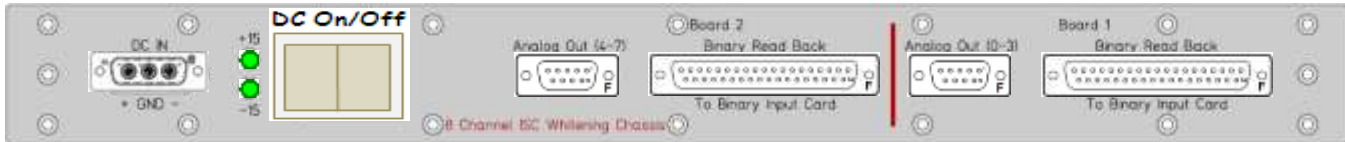
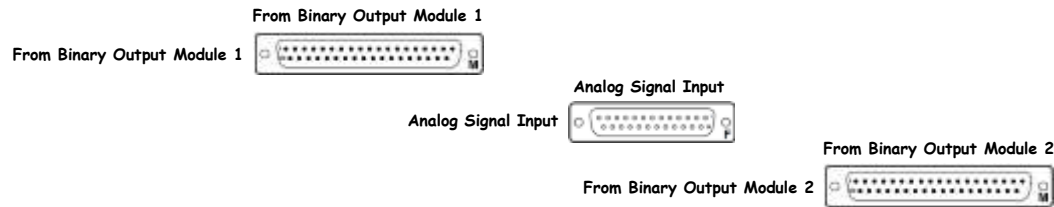

S1101629

Rear

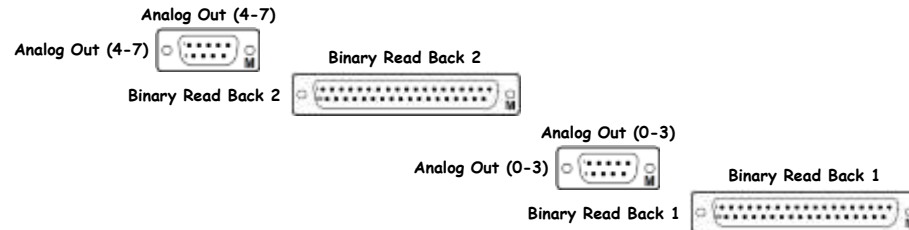

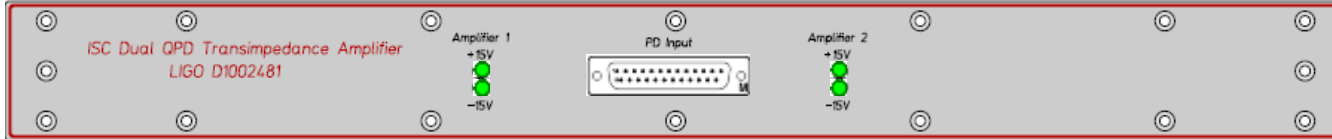

D1002481

Front



S1301504

Rear

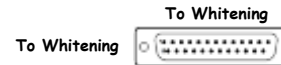

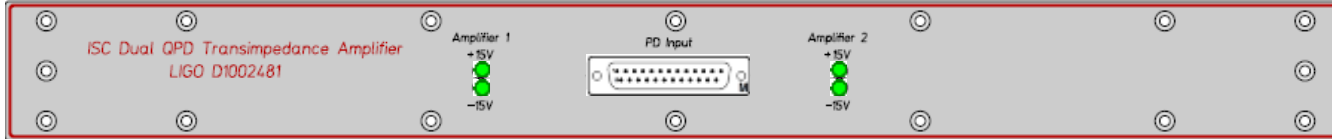

D1002481

Front



S1102816

Rear



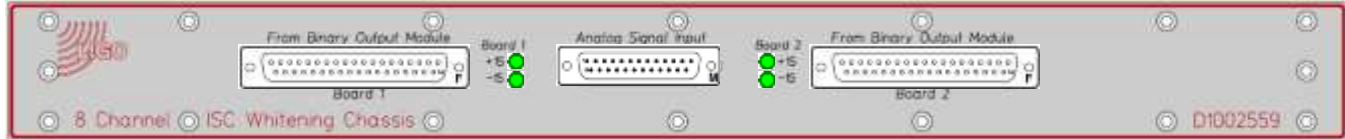

D1002559

Front

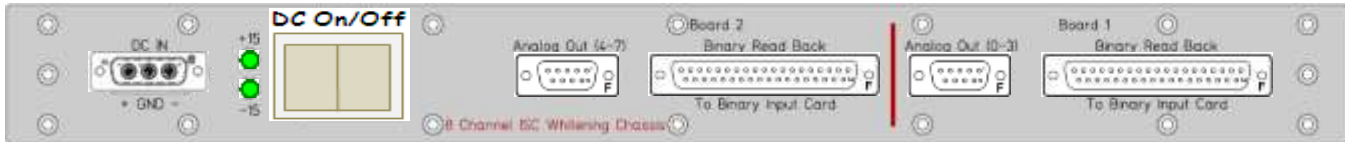
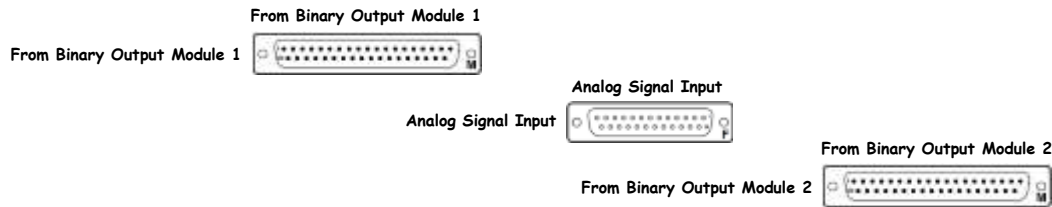

S1101169

Rear

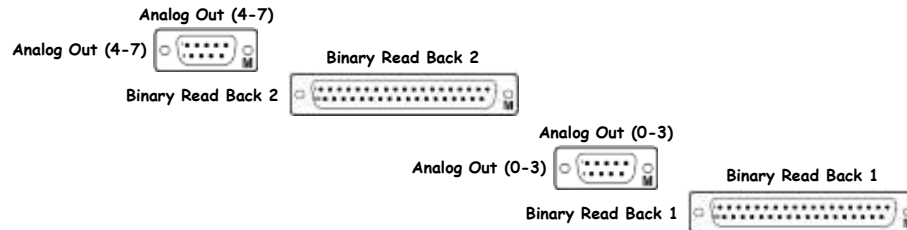

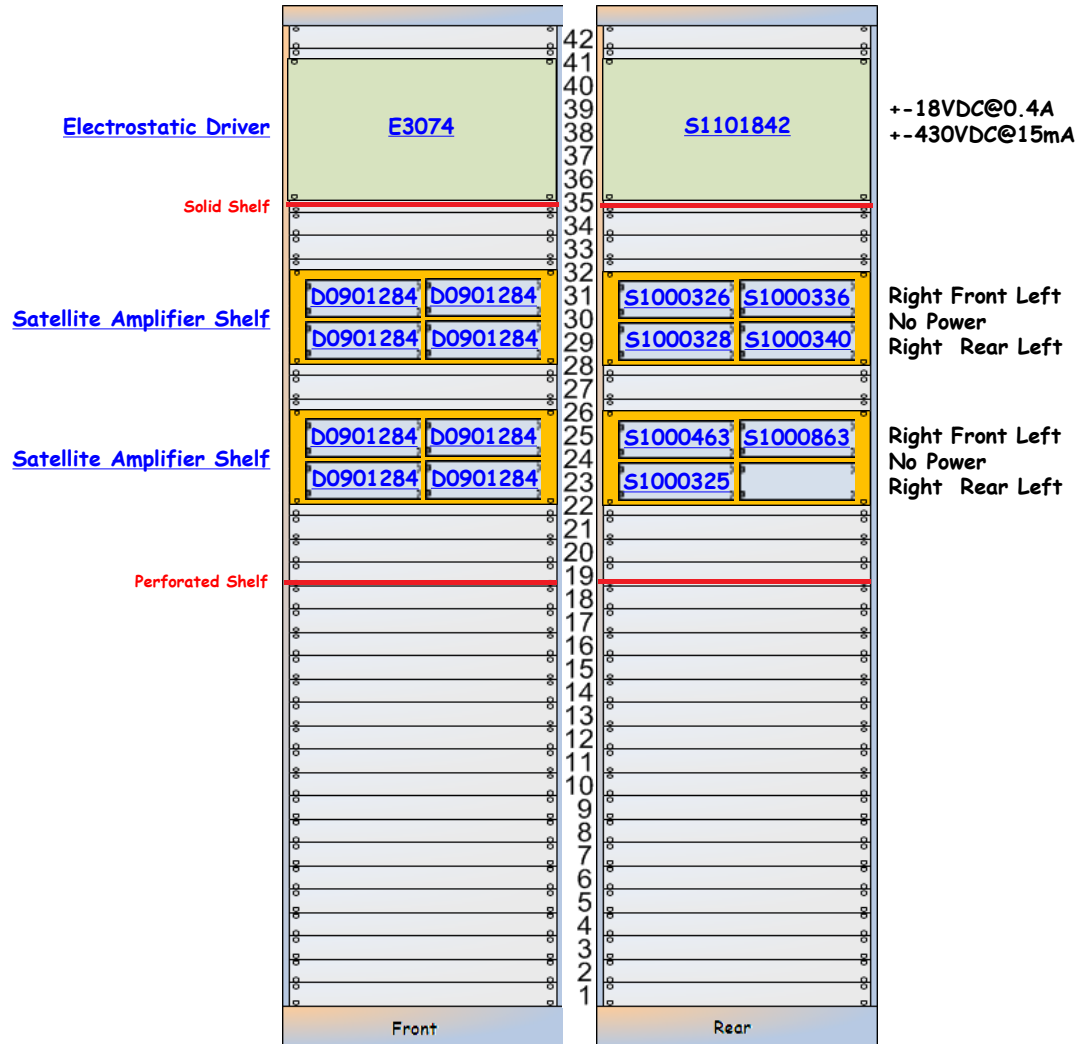

SUS-YR1 is part of [D1002741](#).

L1-SUS-YR1 Details

SUS-YR1 is part of [D1002741](#).

E3074 - S1101842

Electrostatic Driver

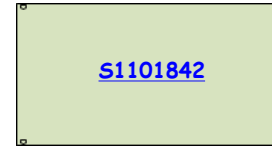
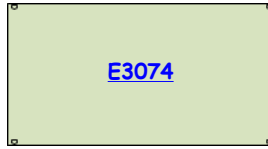

+ -18VDC@0.4A
+ -430VDC@15mA



E3074

Front



S1101842

Rear

<< L1-SUS-YR1

Satellite Amplifier Shelf

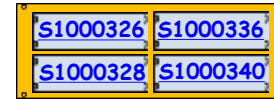

Right Front Left
No Power
Right Rear Left

Left



Right

<< L1-SUS-YR1

Satellite Amplifier Shelf

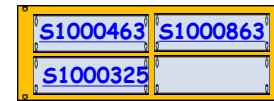
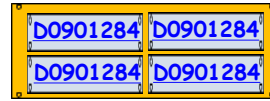

Right Front Left
No Power
Right Rear Left

Left

Front



D0901284

Right

Rear

L1-VAC-YR1 YEND Vacuum Rack Layout (Dxxxxxxx)

Marway MPD100 Power Distribution
 Power-Ten 3300D-3020 Switching DC Power Supply
 Power-Ten 3300D-3020 Switching DC Power Supply

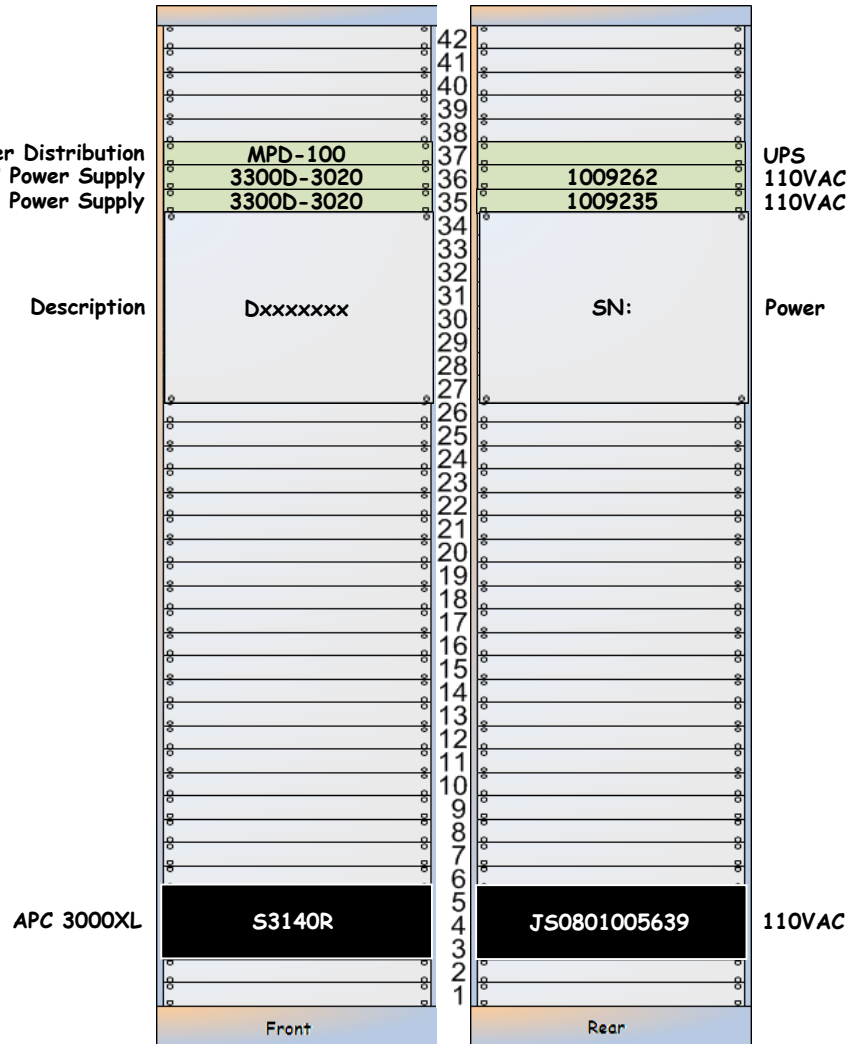

L1-VAC-YR1 Details

[<< L1-VAC-YR1](#)

Power-Ten 3300D-3020 Switching DC Power Supply 110VAC

[<< L1-VAC-YR1](#)

Power-Ten 3300D-3020 Switching DC Power Supply 110VAC

<< [L1-VAC-YR1](#)

Description

Dxxxxxxxx

SN:

Power

CentreCom 210TS



Grey CAT5 Cable
to CDS Network
Switch Port 17

APC 3000XL

S3140R

JS0801005639

110VAC

Particle Counter

- Located in Mechanical Room
- +24VDC comes from Power-Ten 1009235
- 485-25E - Telebyte - Cat5 - 162-262 Port 3

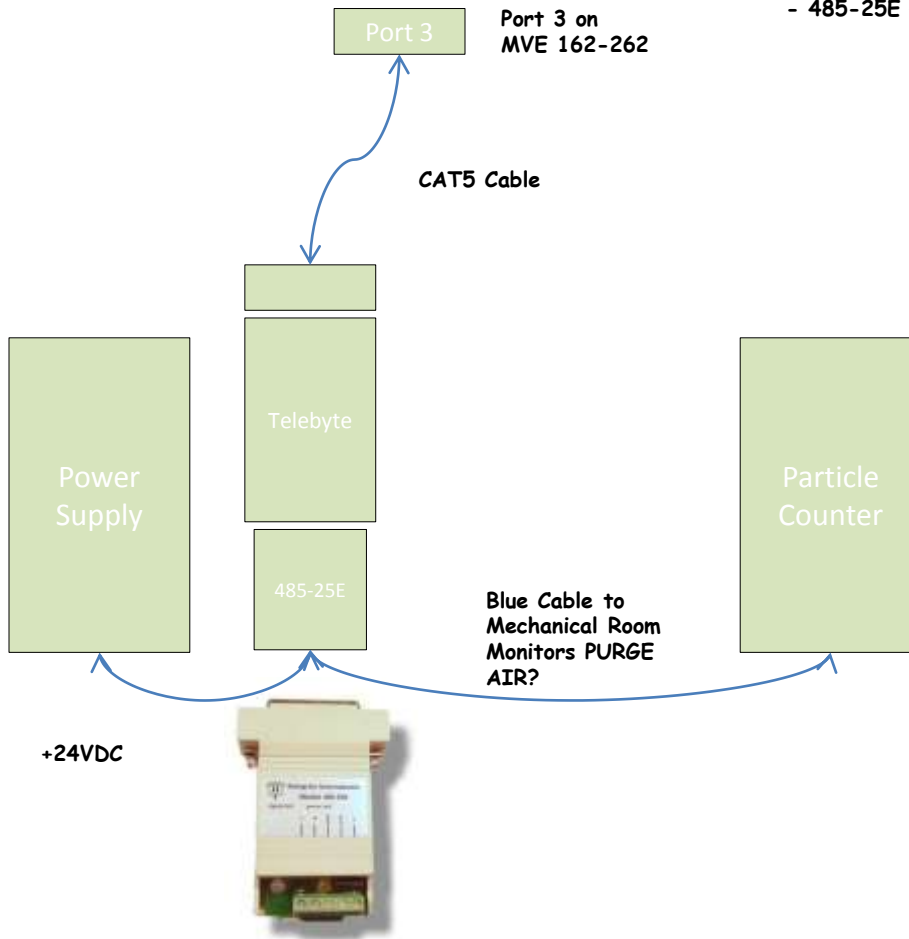

ISCBT5L is part of Exxxxxxx.

L1-ISCBT5L Panel Layout

[<< YEND Tables](#)

ISCBT5L Panel Layout ([D1101126](#))

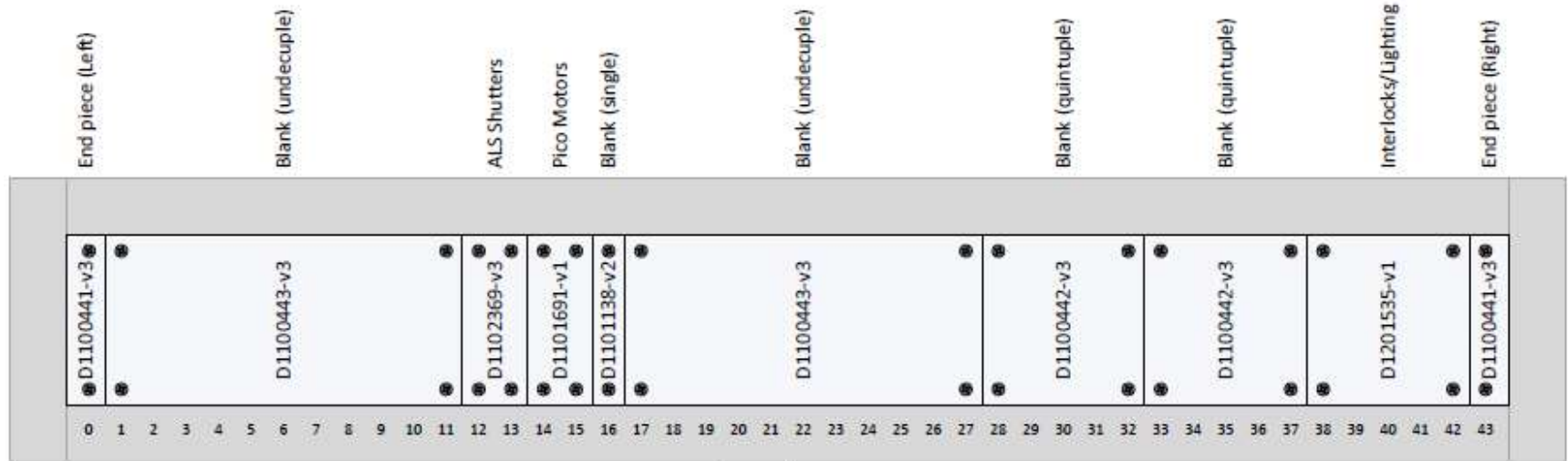

Left Side

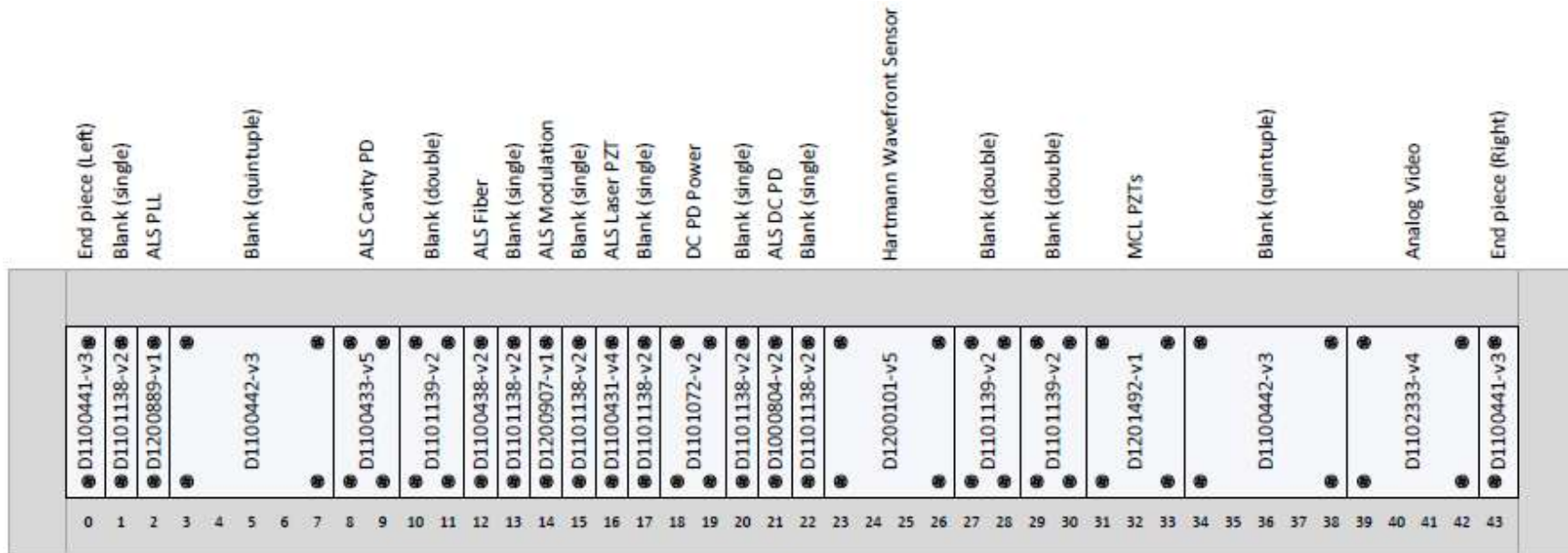

Right Side

[<< LLO Corner Station](#)

[<< LLO Racks by AREA](#)

[<< LLO CDS Components](#)

DAQ (aka CDS) Test Rack (L1-ETR-01)	RMS (aka Triple) Test Rack (L1-ETR-04)	Triple SUS Test Rack (L1-ETR-07)
BSC (aka QUAD) Test Rack (L1-ETR-02)	HAM ISI Test Rack (L1-ETR-05)	Future Test Rack (L1-ETR-08)
Optics Test Rack (L1-ETR-03)	STS Huddle Test Rack (L1-ETR-06)	Future Test Rack (L1-ETR-09)

L1 DTS – IO

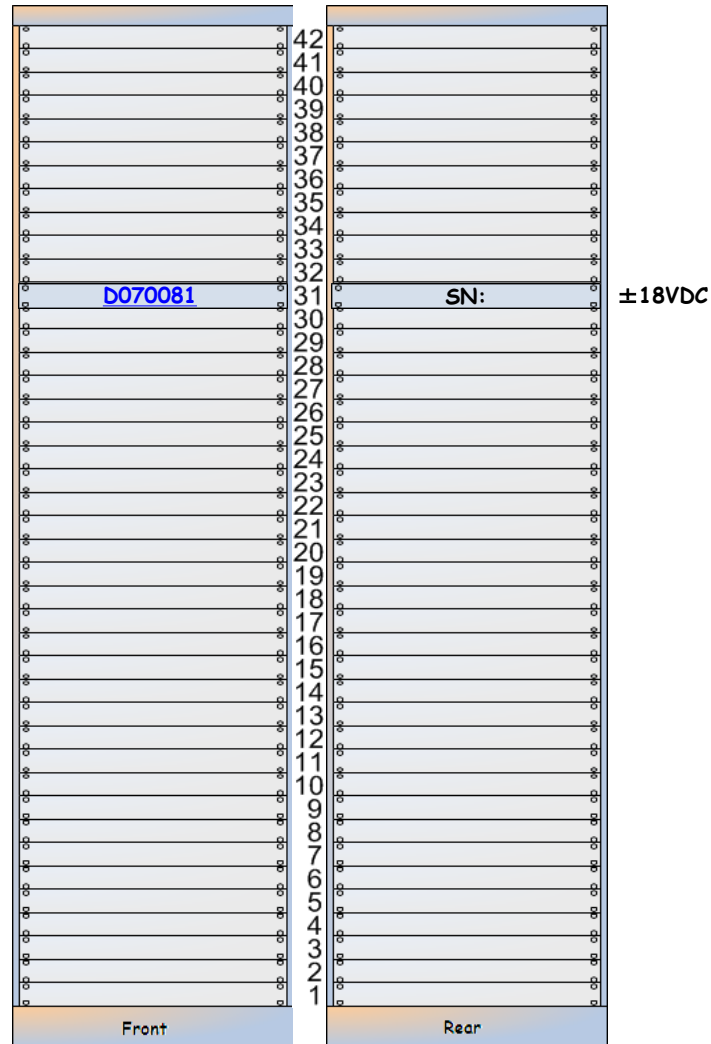
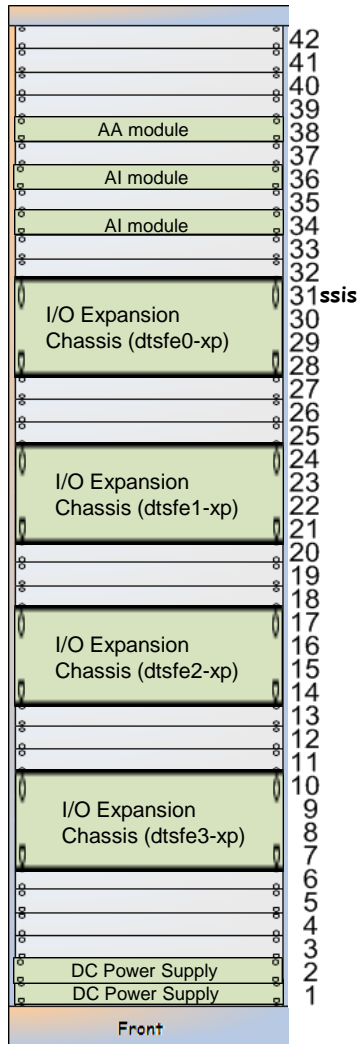

D070124 Rack Input
Power Box (RU 34-36)

+18VDC	?A
-18VDC	?A
+24VDC	?A
-24VDC	?A

L1-ETRO1 DAQ (aka CDS)

L1-ETRO1
Front

Linksys BEFSX41
Firewall Router
D070011 Fanout Timing
Netgear GS724T Switch
Netgear GSM7352S Switch
SUN Microsystems X2200
SuperMicro

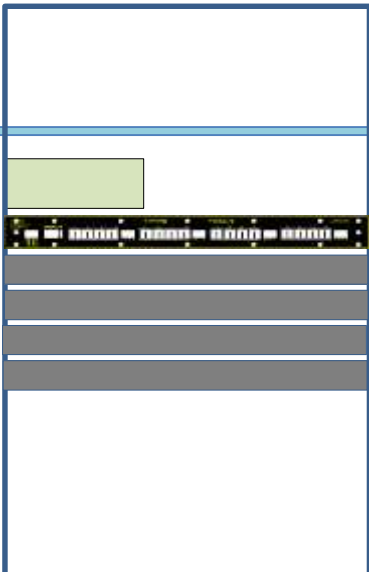

I/O Extension
2 ADC
1 DAC
1 Timing Slave
Shelf
KVM



D070081 AI Chassis
D070081 AA Chassis



SuperMicro
SuperMicro
SuperMicro

JQE25-10M +15V
JQE25-10M -15V

JQE25-10M +24V
JQE25-10M -24V

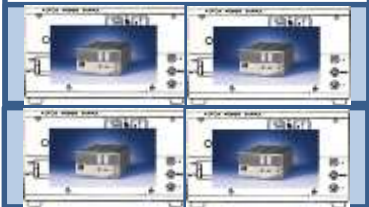

L1-ETRO1
Rear

D070011 Fanout Timing
SN:
SN:
0923QAT00D dtserver 192.168.100.10
... dtsfe1 192.168.100.15

DC Bus Distribution Box

Shelf
SN:
D070081 SYYYYYYYY
D070081 SYYYYYYYY
... dtstdco 192.168.100.30
... dtswfo 192.168.100.31
... dtsndso 192.168.100.32

SN:
SN:

SN:
SN:

Linier Rack – has front and rear doors and wheels.

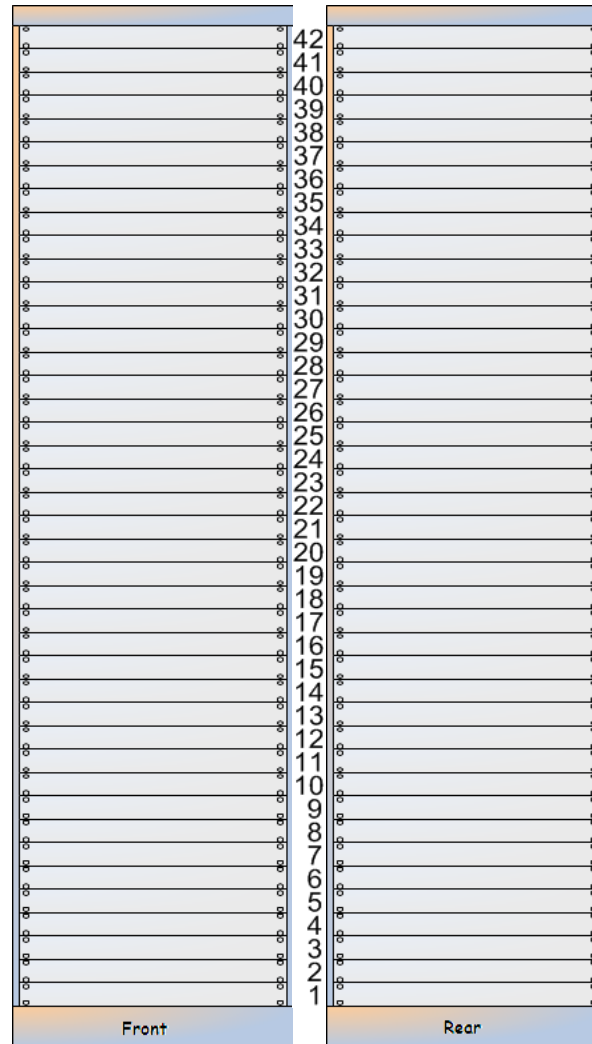

D070124 Rack Input Power Box (RU 34-36)

+18VDC	?A
-18VDC	?A
+24VDC	?A
-24VDC	?A

L1-ETRO2 BSC (aka Quad)

L1-ETRO2
Front

L1-ETRO2
Rear

Computer

I/O Extension
2 ADC
1 DAC
1 Timing Slave

JQE25-10M +15V
JQE25-10M -15V

SN:

SN:
SN:

Satellite Amplifier

Satellite Amplifier

Satellite Amplifier

Satellite Amplifier

Satellite Amplifier

Linksys BEFSX41
Firewall Router

Netgear GS108
Gigabit Switch

iMAC Computer

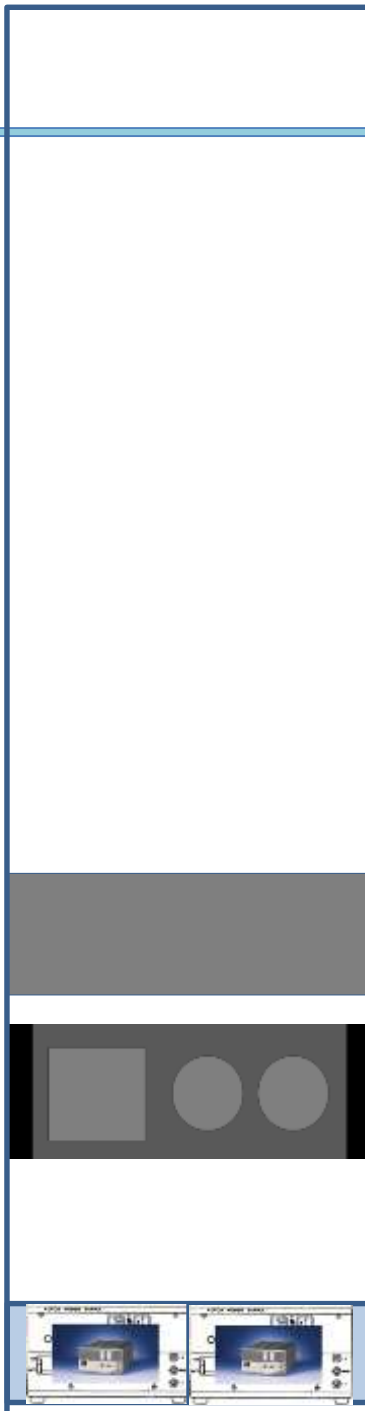
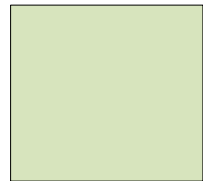
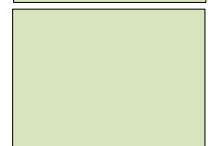
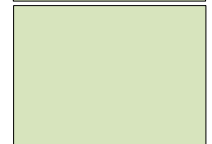
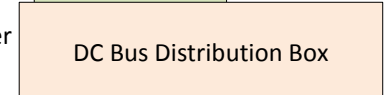
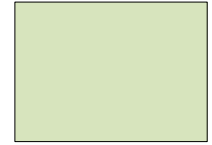

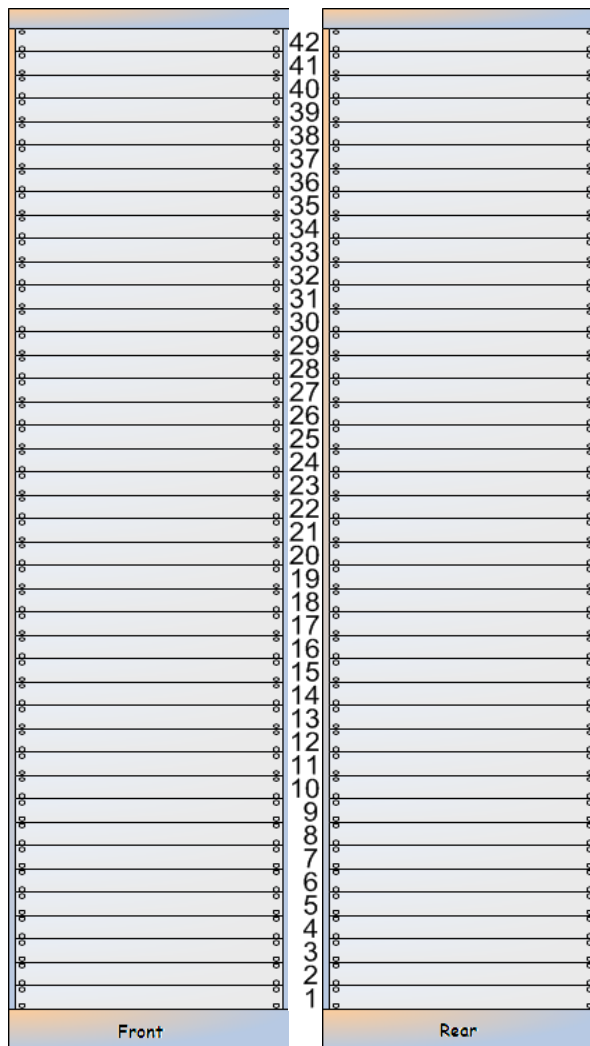

D070124 Rack Input
Power Box (RU 34-36)

+18VDC	?A
-18VDC	?A
+24VDC	?A
-24VDC	?A



Dxxxxxx-V1

L1-ETRO3 OPTICS

L1-ETRO3
Front

L1-ETRO3
Rear

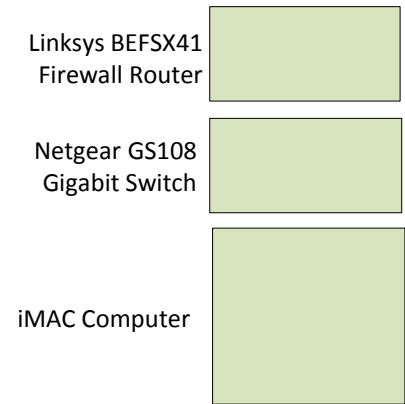
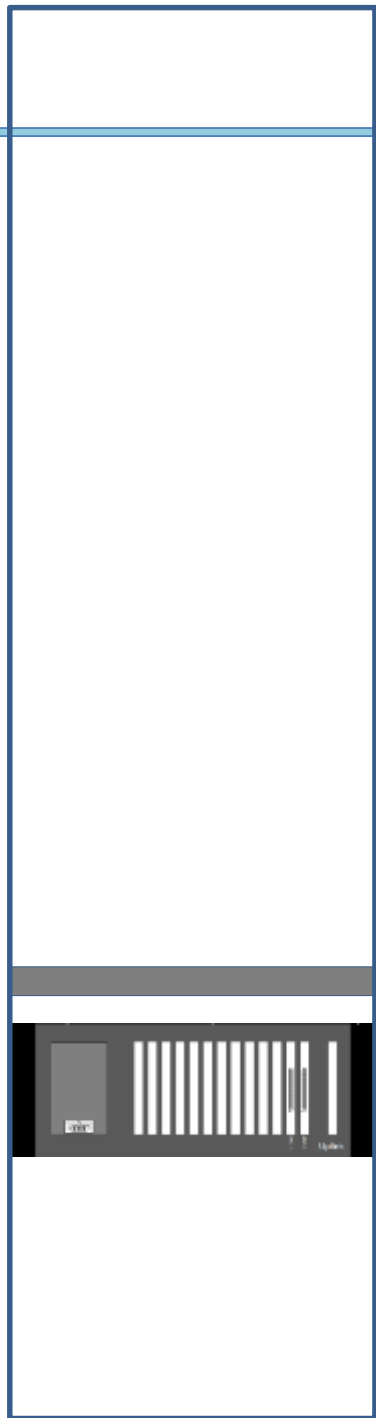
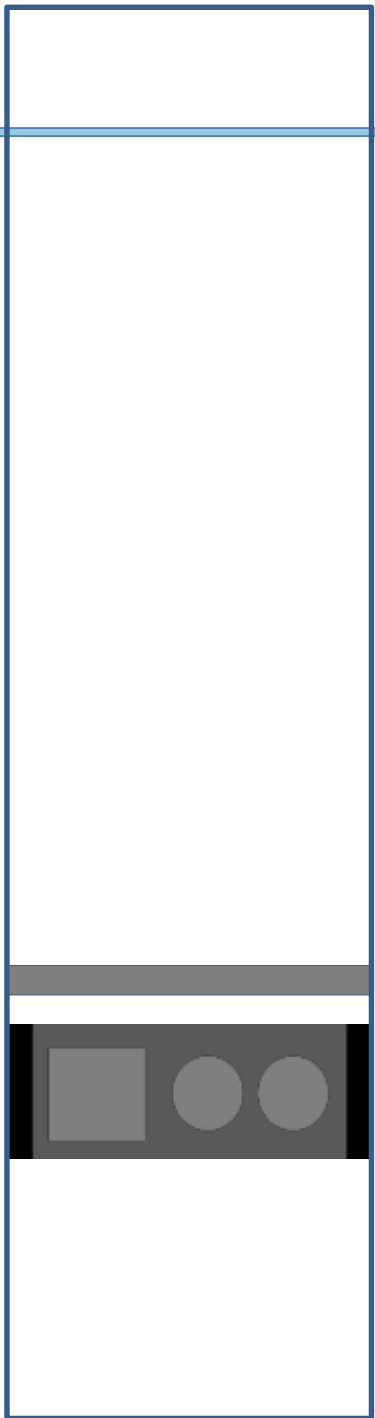

RMS (aka Triple) Test Rack Layout (Dxxxxxxx)

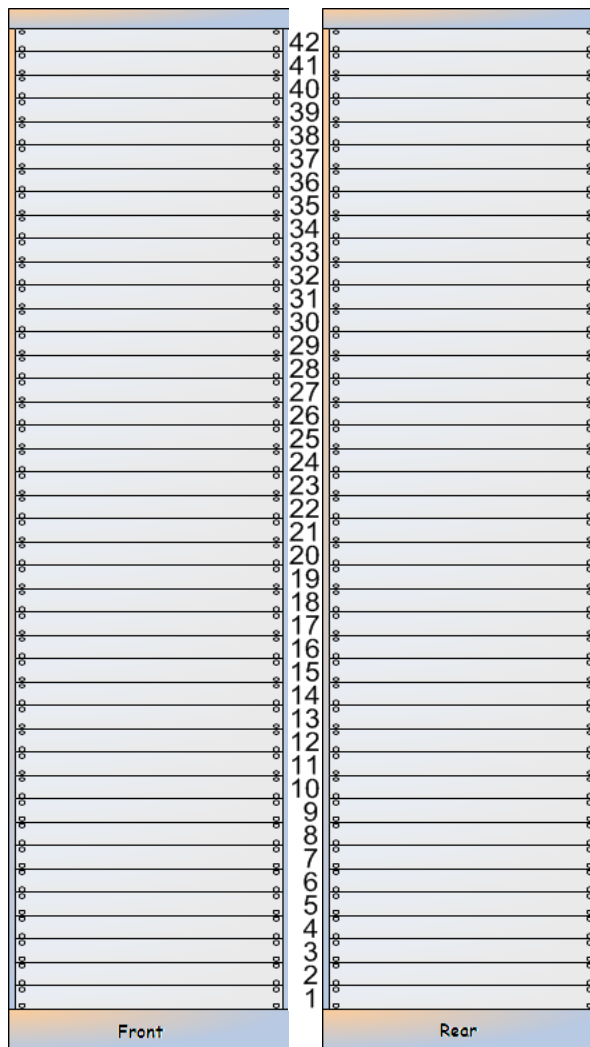

D070124 Rack Input
Power Box (RU 34-36)

+18VDC	?A
-18VDC	?A
+24VDC	?A
-24VDC	?A

L1-ETRO4 RMT (aka Triple)

L1-ETRO4
Front

L1-ETRO4
Rear



D1000305 AI Chassis

D0902783 AA Chassis

D0902783 AA Chassis

Computer

I/O Extension

2 ADC

1 DAC

1 Timing Slave

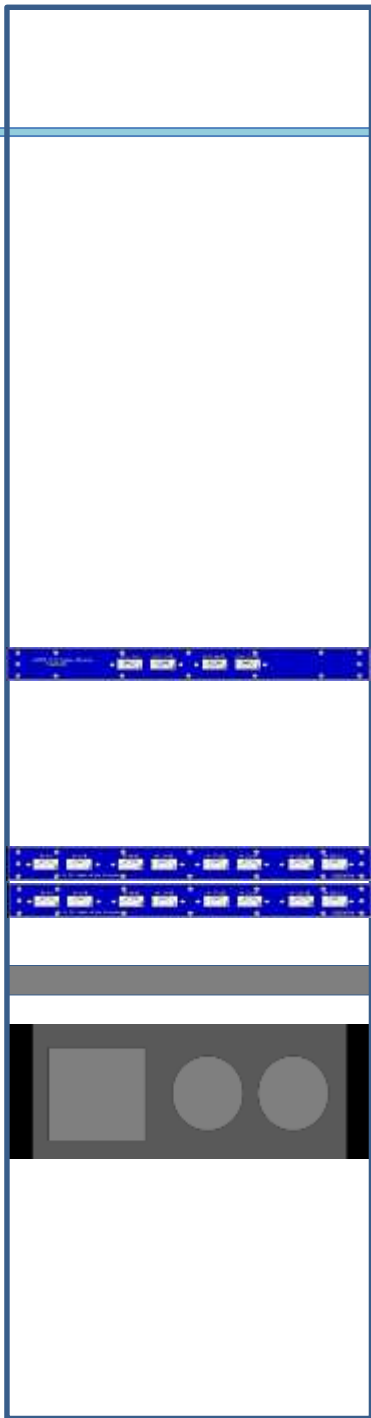

D1000305 SYYYYYYYY

D0902783 SYYYYYYYY

D0902783 SYYYYYYYY

SN:

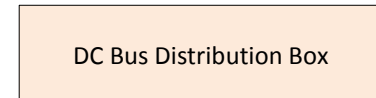

Linksys BEFSX41
Firewall Router



Netgear GS108
Gigabit Switch

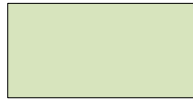

iMAC Computer

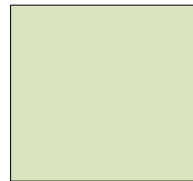

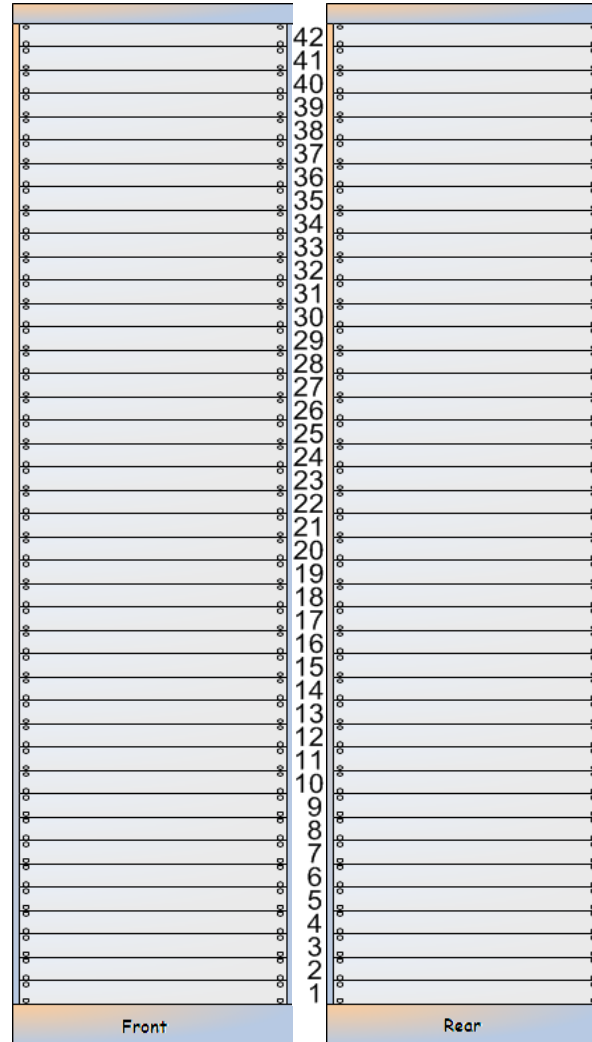

**D070124 Rack Input
Power Box (RU 34-36)**

+18VDC	?A
-18VDC	?A
+24VDC	?A
-24VDC	?A

L1-ETRO5
Front

L1-ETRO5
Rear

ISI Interface Pod 1 & L4C
 ISI Interface Pod 2 & L4C
 ISI Interface Pod 3 & L4C

D1000067 S1000311
 D1000067 S1000312
 D1000067 S1000314

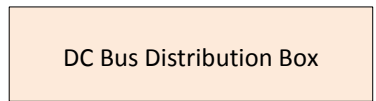

Anti-Alias (AA) Chassis
 Anti-Alias (AA) Chassis



D1000269 S1000244
 D1000269 S1000298

Anti-Image (AI) Chassis



D070081 SS1000251

ISI Coil Driver (Pod 1 and 2)

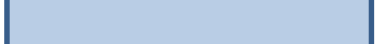

D0902744 S1000317

ISI Coil Driver (Pod 3)

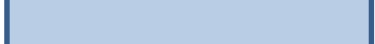

D0902744 S1000316

I/O Extension
 2 ADC
 1 DAC
 1 Timing Slave
 Computer



SN:

SN:

JQE25-10M +24V
 JQE25-10M -24V

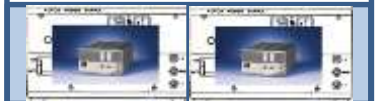

SN:
 SN:

iMAC Computer

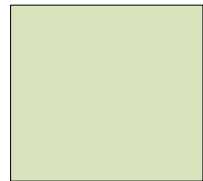

JQE25-10M +15V
 JQE25-10M -15V



SN:
 SN:



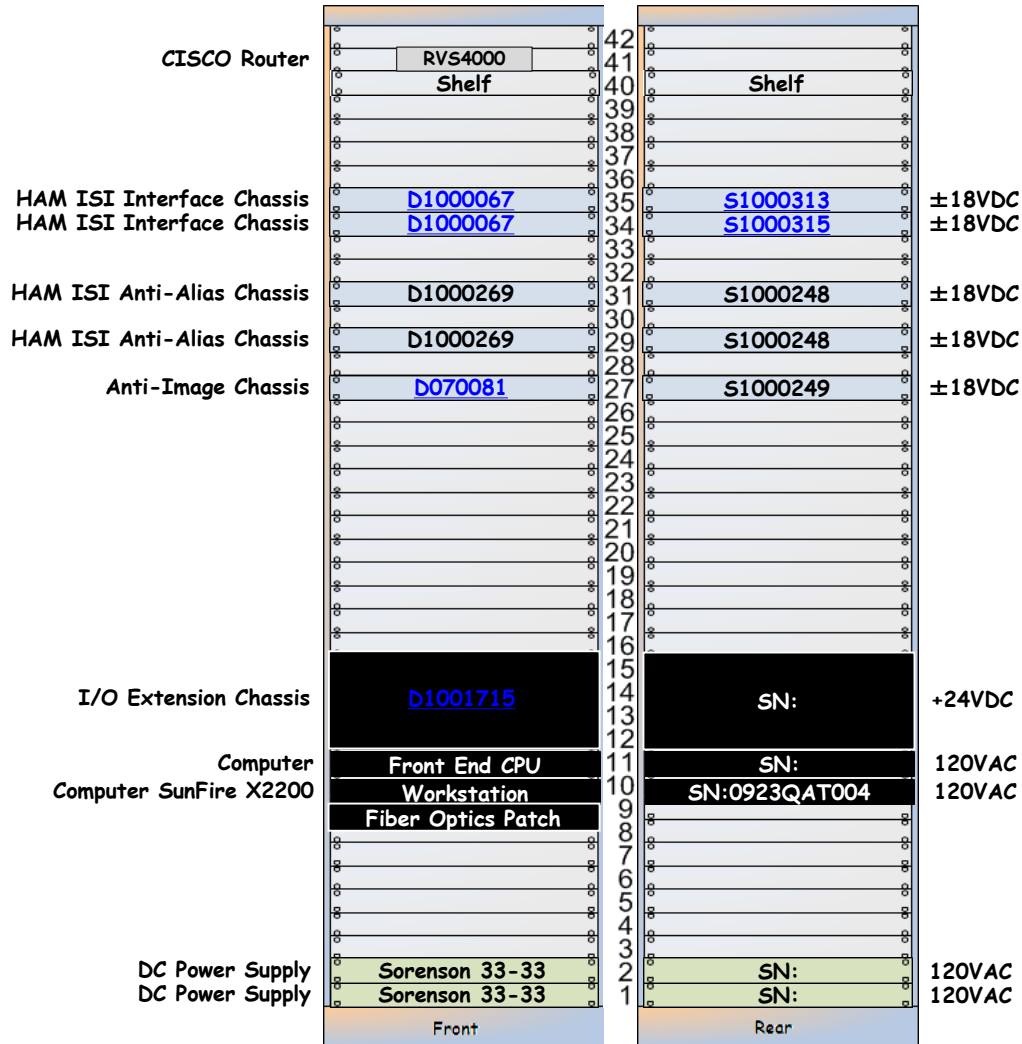

D070124 Rack Input Power Box (RU 34-36)

0 - ADC0
1 - DAC0
2 - ADC1

+18VDC	?A
-18VDC	?A
+24VDC	?A
-24VDC	?A

L1-ETRO6
Front

L1-ETRO6
Rear

ISI Interface Pod 1 & L4C
Pod 2 & L4C
Pod 3 & L4C

DXXXXXXXX SYYYYYYYY
DXXXXXXXX SYYYYYYYY
DXXXXXXXX SYYYYYYYY

DC Bus Distribution Box

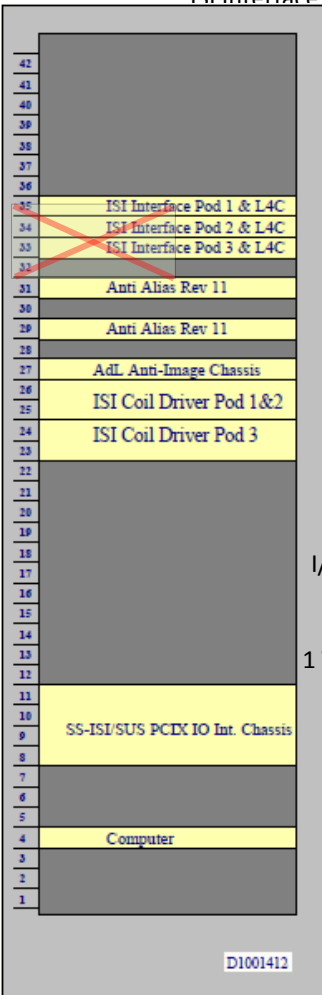

3 AA Chassis
3 AA Chassis
I/O Extension
2 ADC
1 DAC
1 Timing Slave
Computer

5-10M +15V
5-10M -15V

D1001412

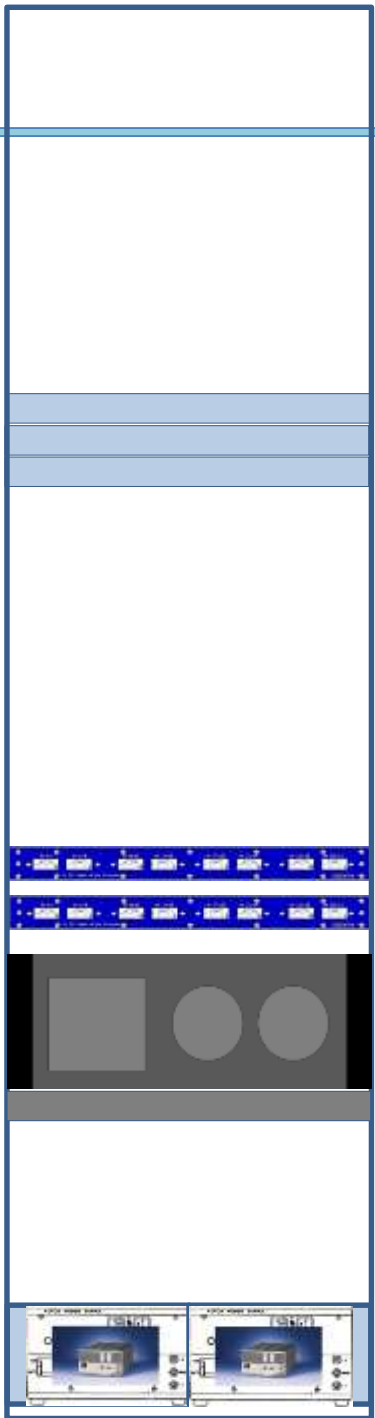

D0902783 SYYYYYYYY
D0902783 SYYYYYYYY

SN:

SN:
SN:

Linksys BEFSX41
Firewall Router

Netgear GS108
Gigabit Switch

iMAC Computer

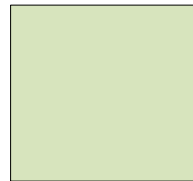

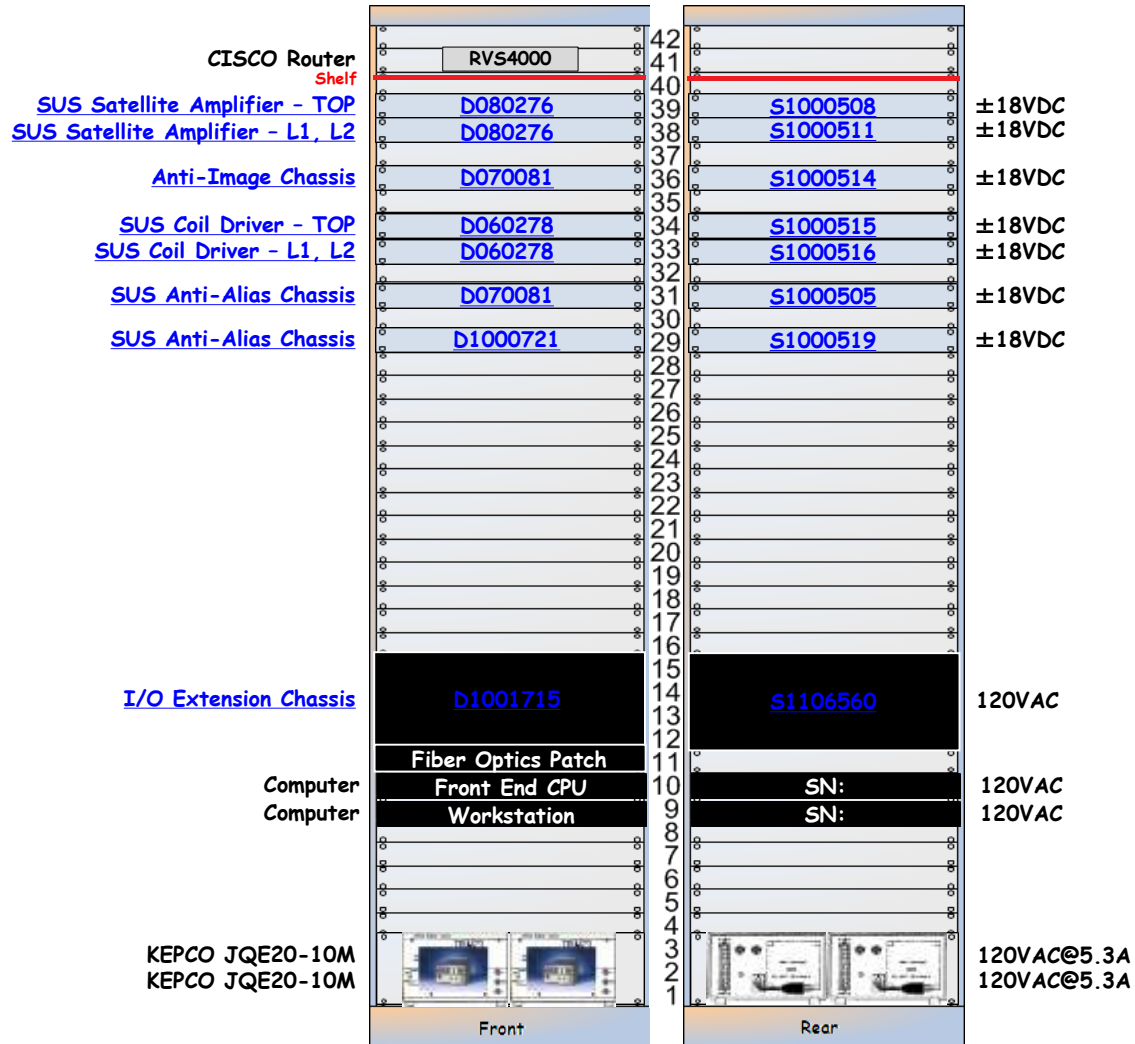

D070124 Rack Input Power Box (RU 34-36)

0 - ADC0
1 - DAC0
2 - ADC1

UM (Top)

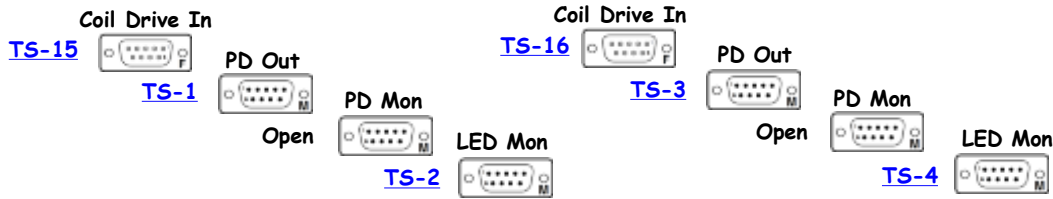

IM (L1), BM (L2)

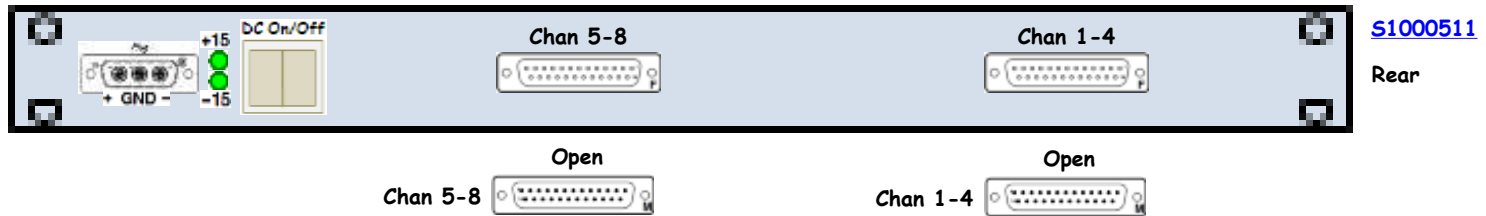
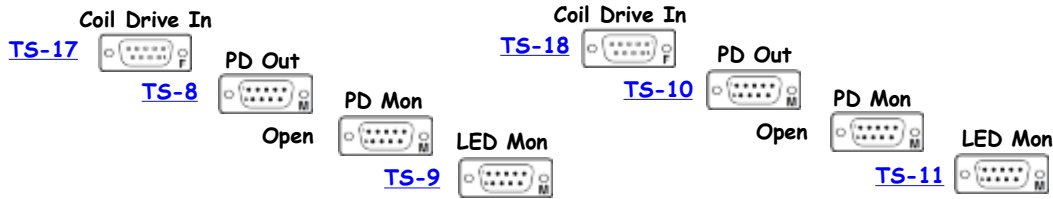

Anti-Image Chassis ±18VDC

UNBUFFERED

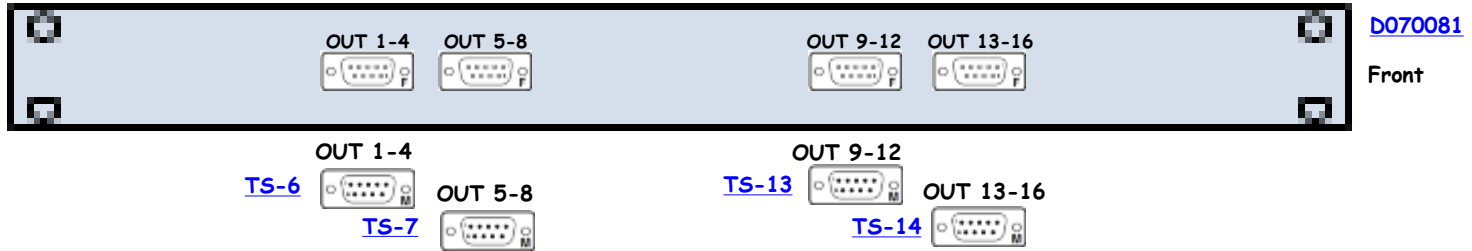

UM (Top)

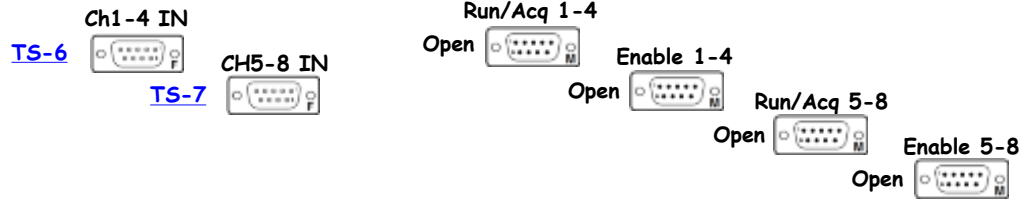
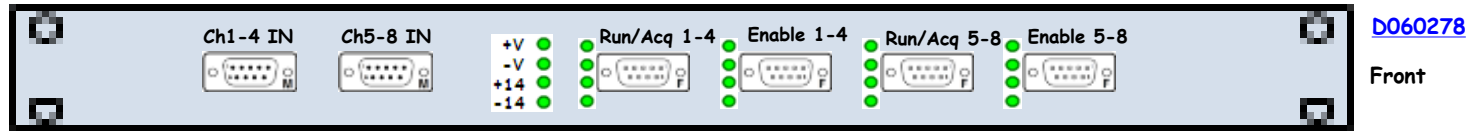

IM (L1), BM (L2)

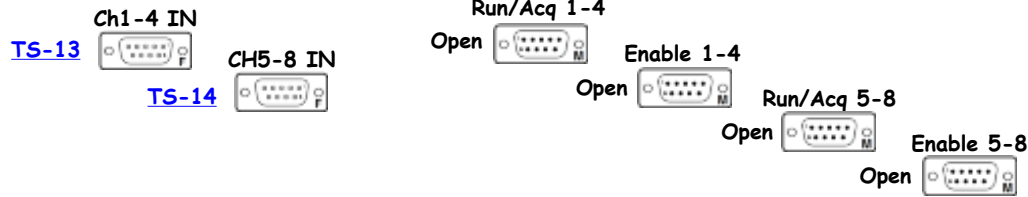
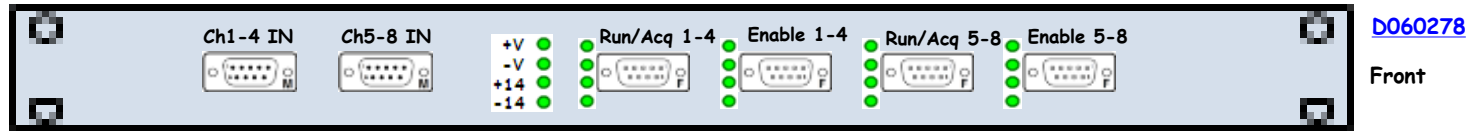

<< L1-ETR-07

SUS Anti-Alias Chassis D070081 S1000505 ±18VDC

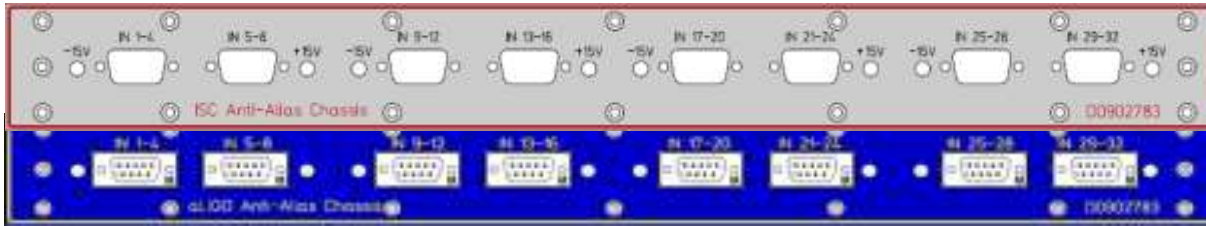

[D0902783](#)

Front

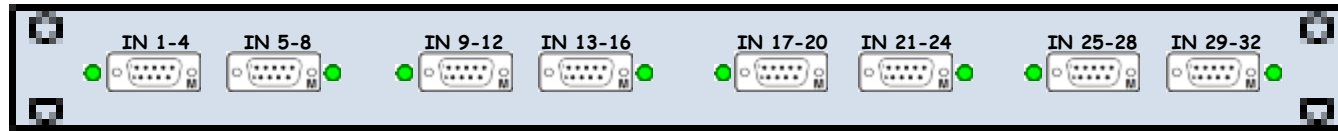

[D070081](#)

Front

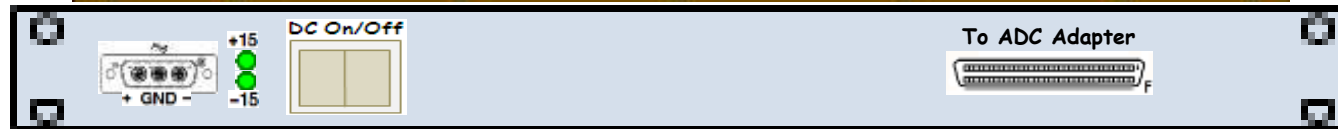
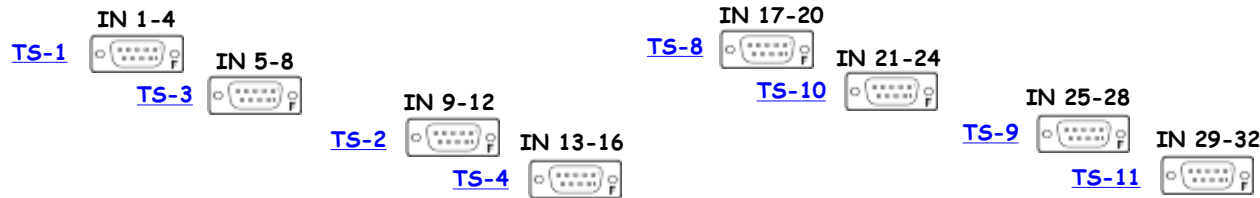

[S1000505](#)

Rear



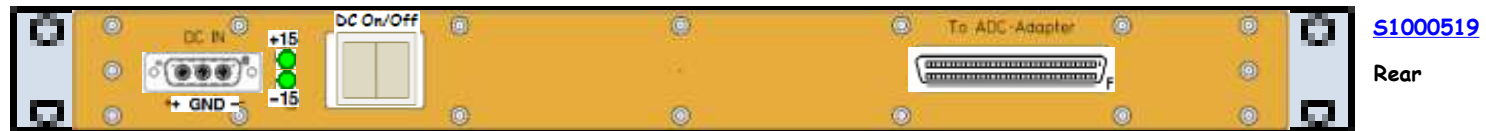
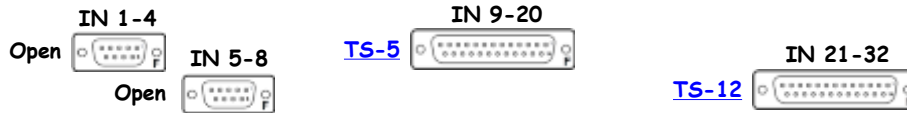

Ixxxxxx I/O Extension Chassis

D1001715

S1106560

+24VDC

D1001715

Front

Timing Slot

Ixxxxxx – I/O Extender

S1106560

Rear

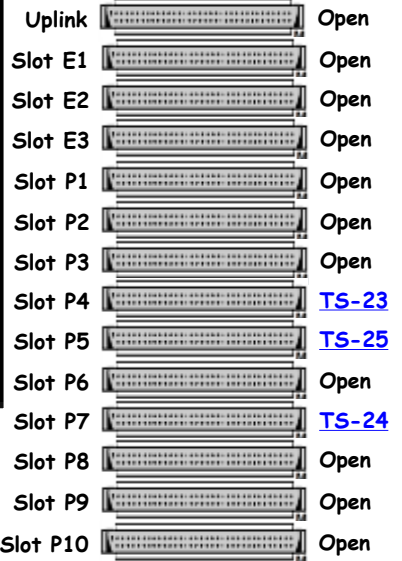

+24VDC

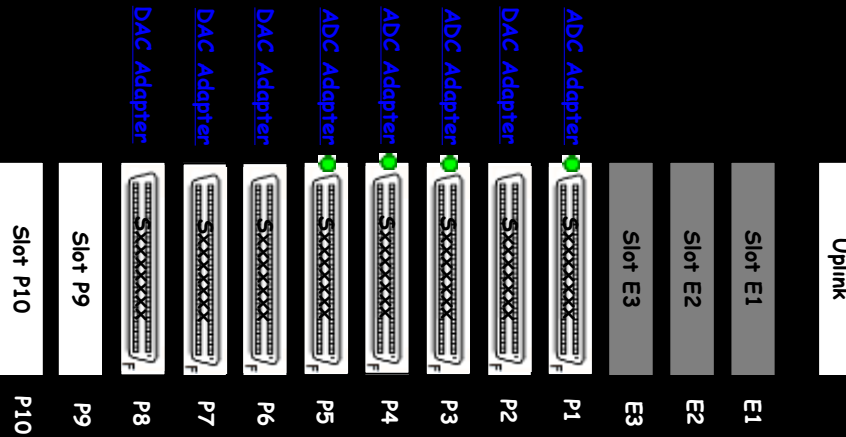

Templates



**D070124 Rack Input
Power Box (RU 34-36)**

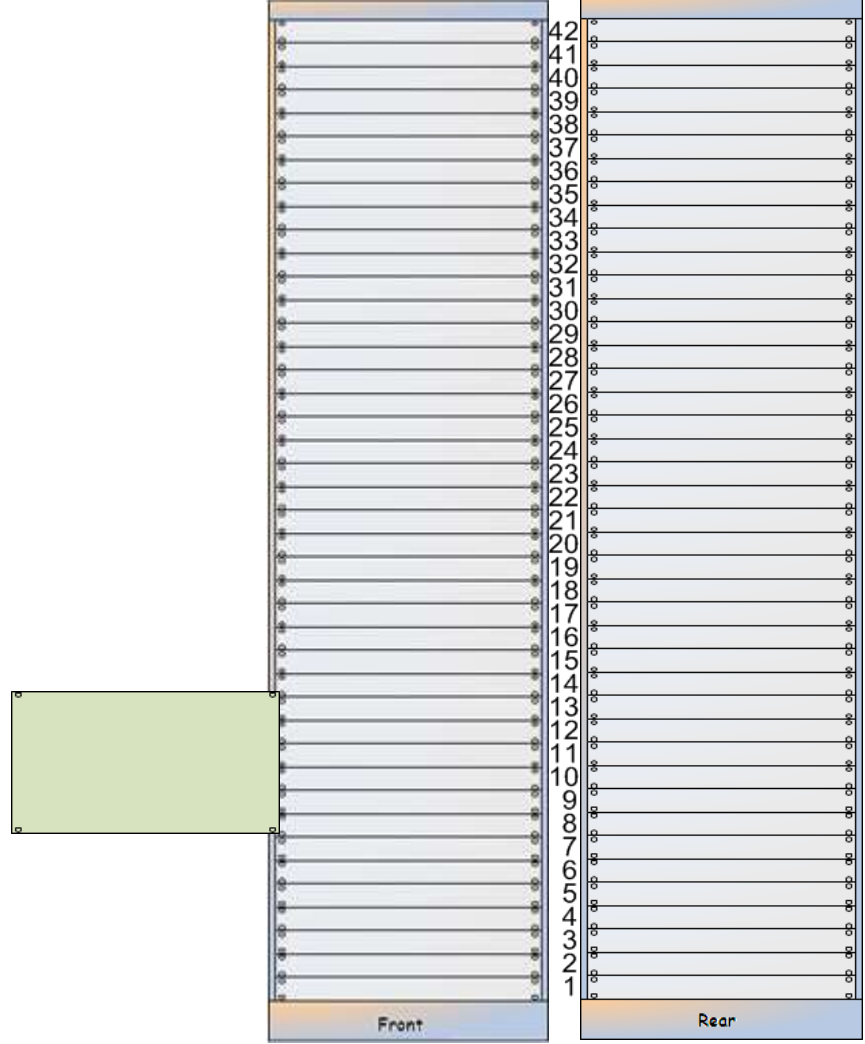
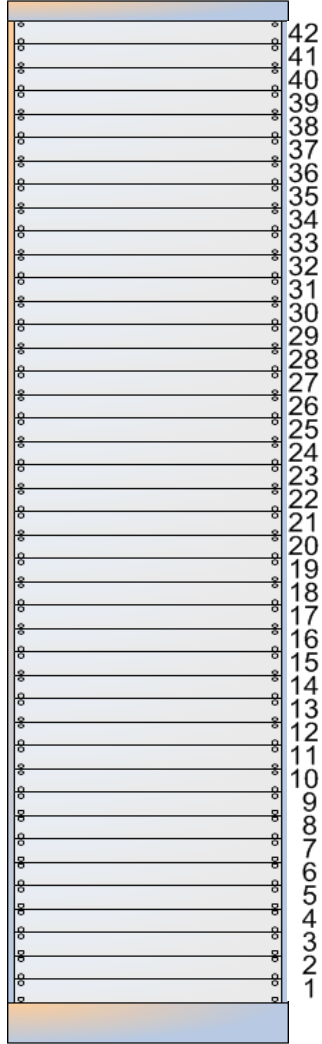
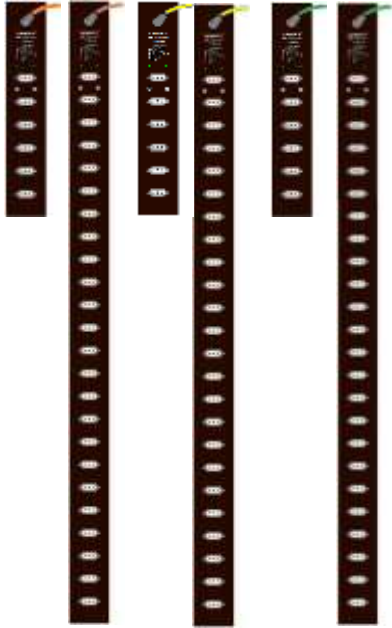

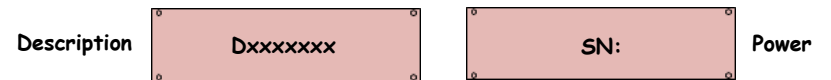
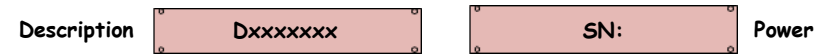
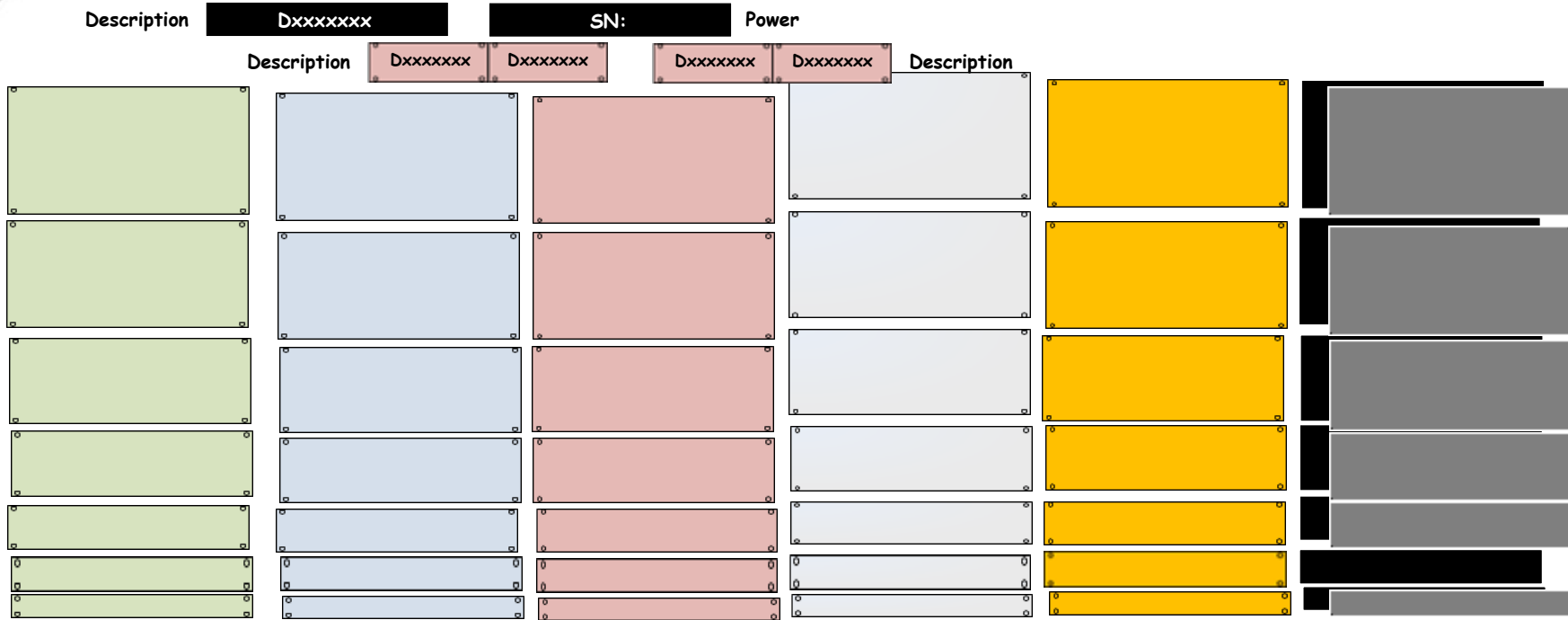

Shelf

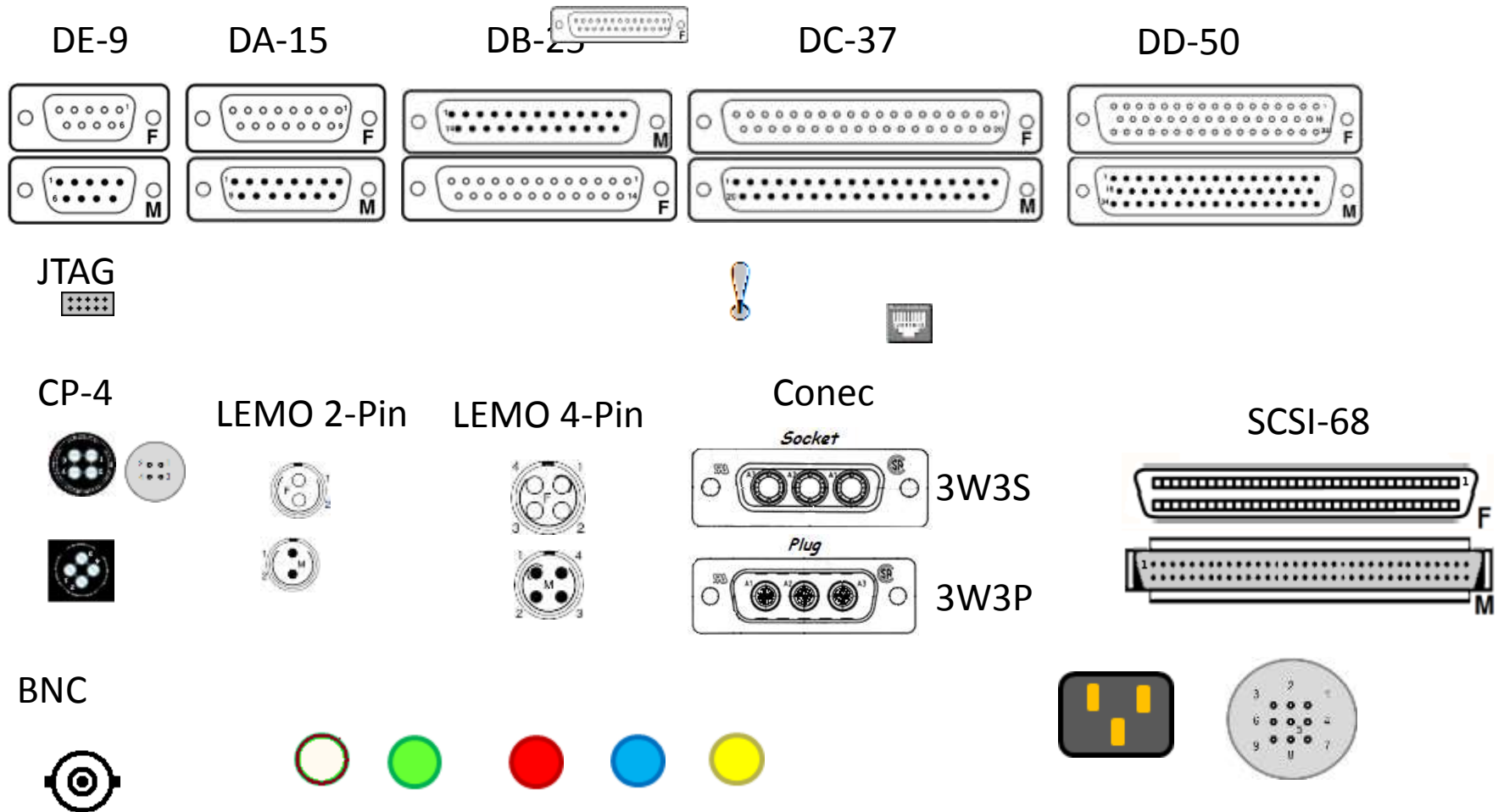

Conec

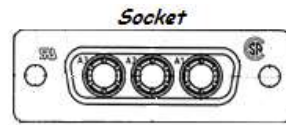

3W3S

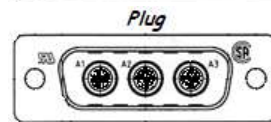

3W3P

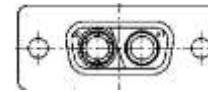

2W2CS

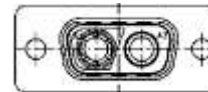

2W2CP

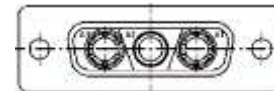

3W3CS

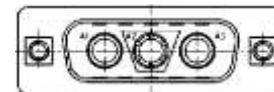

3W3CP

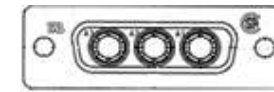

3W3S

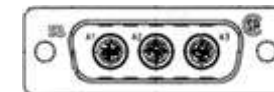

3W3P

CP-4



LEMO 2-Pin



LEMO 1-Pin



LEMO 4-Pin



+V -V Layouts

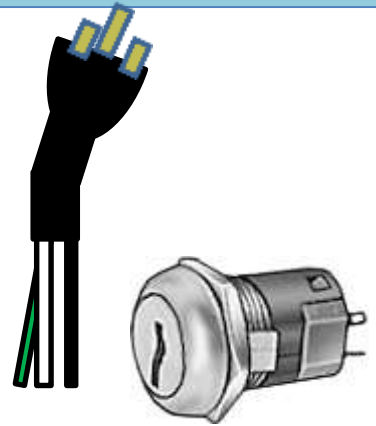
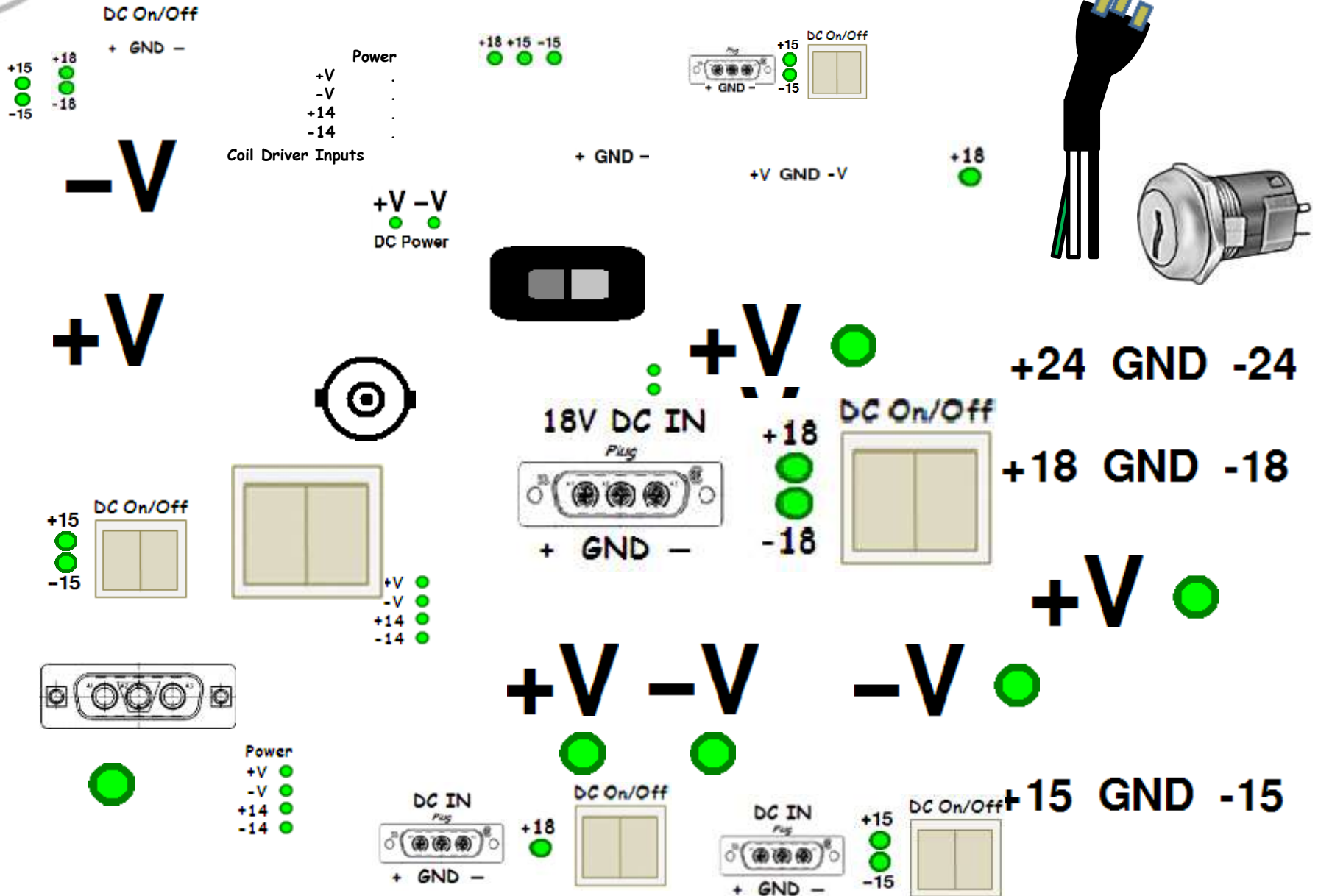

+V -V Layouts



Slot E3

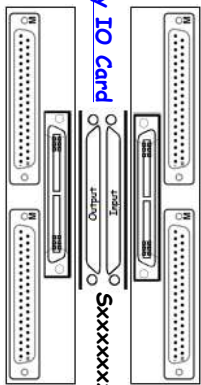

DAC16 Card



Slot P3



Open

Binary IO Card



Slot E3



Open

ADC Card

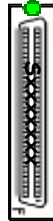

Slot P3



Open

DAC18 Card



Slot P3



Open

Binary IO Card



ADC Card



DAC16 Card



DAC18 Card



+V -V Layouts

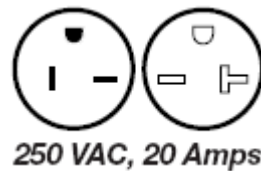
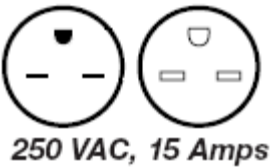
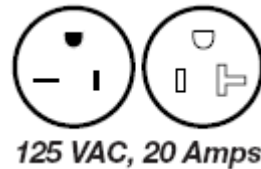
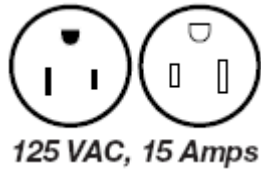

VOLTAGE	NEMA	15 AMPERE		20 AMPERE		30 AMPERE		50 AMPERE		60 AMPERE	
		Receptacle	Plug	Receptacle	Plug	Receptacle	Plug	Receptacle	Plug	Receptacle	Plug
125 V	1	1-15R	1-15P								
250V	2		2-15P	2-20R	2-20P	2-30R	2-30P				
125V	5	5-15R	5-15P	5-20R	5-20P	5-30R	5-30P	5-50R	5-50P		
250V	6	6-15R	6-15P	6-20R	6-20P	6-30R	6-30P	6-50R	6-50P		
277V, A.C.	7	7-15R	7-15P	7-20R	7-20P	7-30R	7-30P	7-50R	7-50P		
125/250V	10			10-20R	10-20P	10-30R	10-30P	10-50R	10-50P		
3Ø 250V	11	11-15R	11-15P	11-20R	11-20P	11-30R	11-30P	11-50R	11-50P		
125/250V	14	14-15R	14-15P	14-20R	14-20P	14-30R	14-30P	14-50R	14-50P	14-60R	14-60P
3Ø 250V	15	15-15R	15-15P	15-20R	15-20P	15-30R	15-30P	15-50R	15-50P	15-60R	15-60P
3Ø Y 120/208V	18	18-15R	18-15P	18-20R	18-20P	18-30R	18-30P	18-50R	18-50P	18-60R	18-60P

Security Cameras Layout

24VAC Power
To Camera

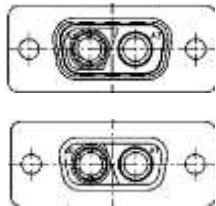

A1 = Black
A2 = White(Y) Red(X)

24VAC



Transformer

110VAC

Signals To
Camera

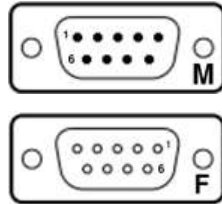

- 1 =
- 2 =
- 3 =
- 4 =
- 5 =
- 6 =
- 7 =
- 8 =
- 9 =



75 Ohm Signal
from Camera

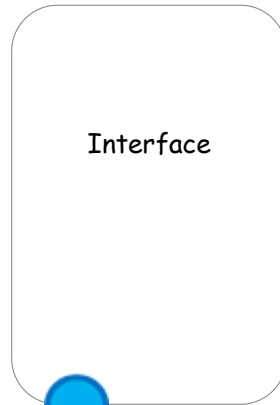
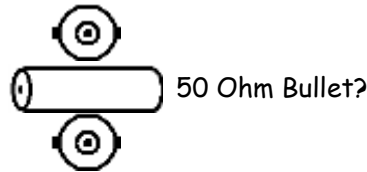

Interface

12VDC

Type N



BNC



SMA

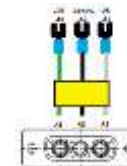

TNC

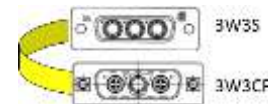

Fiber Optics Connector Types



FC Ferrule Connector or
Fiber Channel



ST / BFOC Straight Tip / Bayonet Fiber
Optic Connector



LC Lucent Connector, or
Little Connector, or
Local Connector



SC Subscriber Connector or
square connector or
Standard Connector

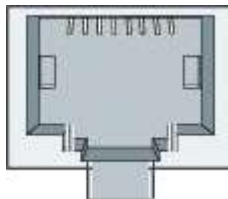
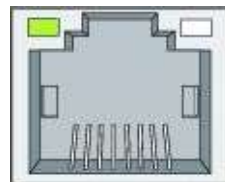

How Rack Documents Relate

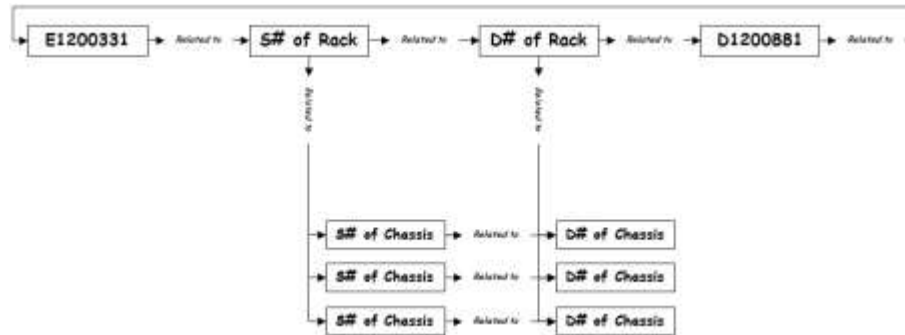
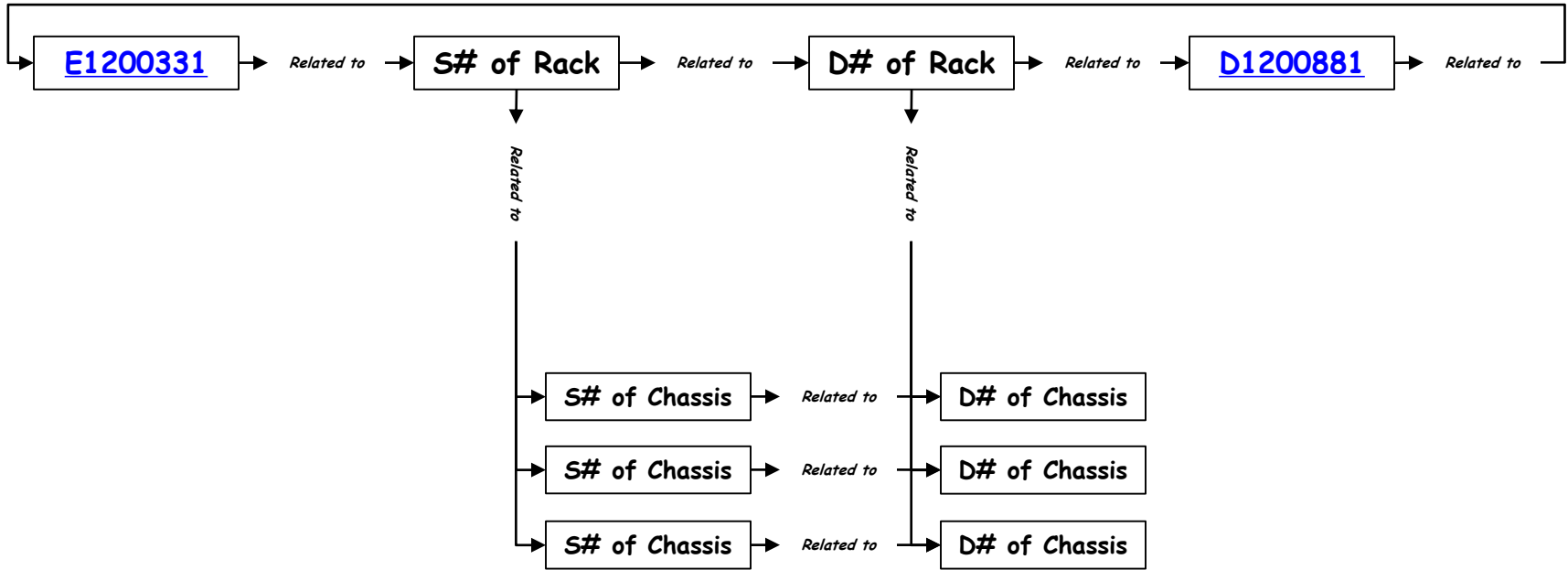

D1100619 - End Link

Beckhoff Slow Controls
End Link

D1100619

SN:

+24VDC

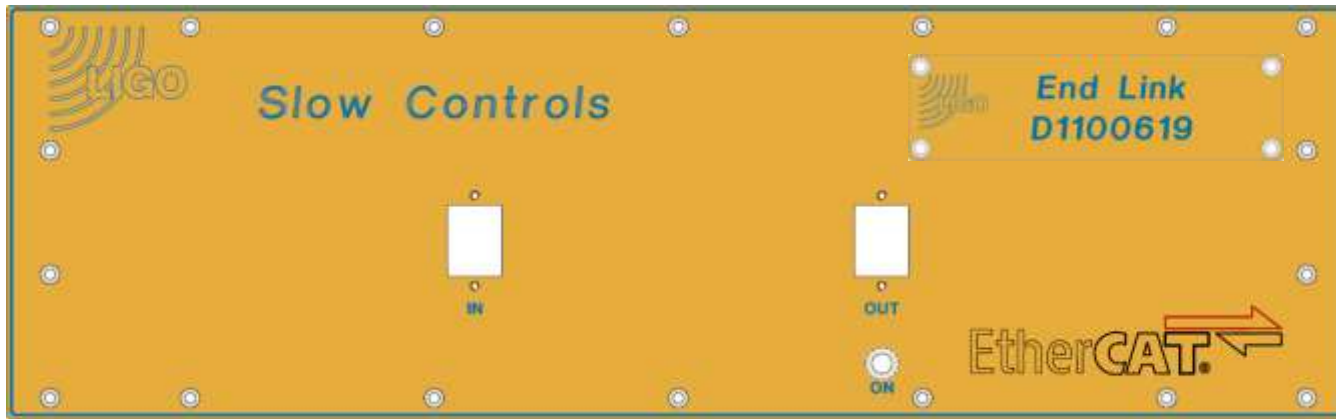

[D1100619](#)

[Front: D0902553](#)

[Name: D1100667](#)

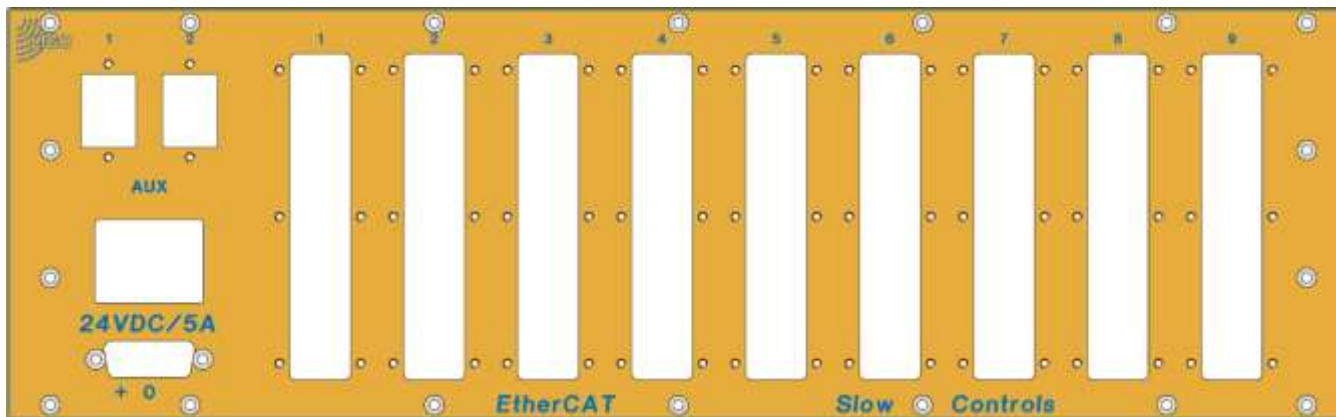

[S1000519](#)

[Rear: D0902554](#)

D1100682 - End Station 2

Beckhoff Slow Controls
End Station 2

D1100682

SN:

+24VDC

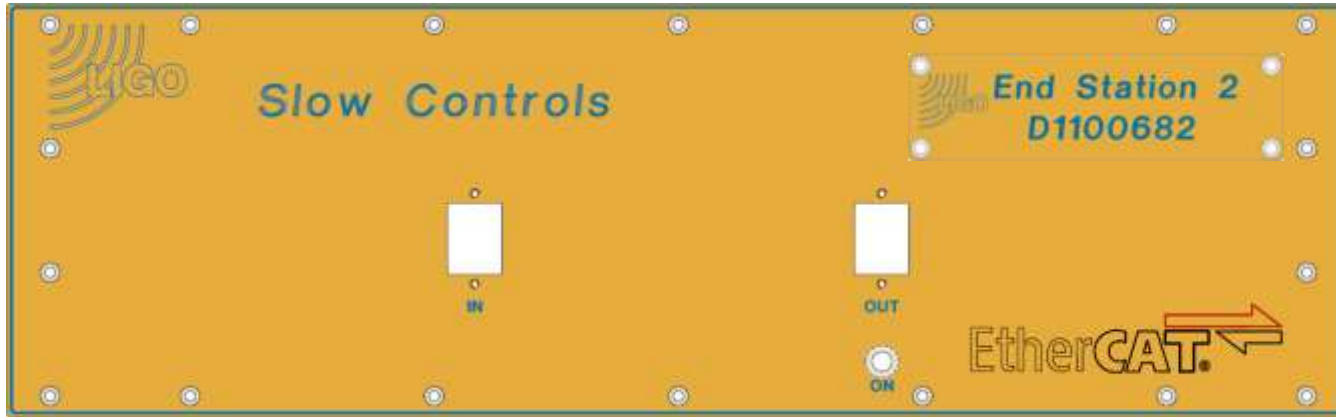

D1100682

Front: D0902553

Name: D1101978

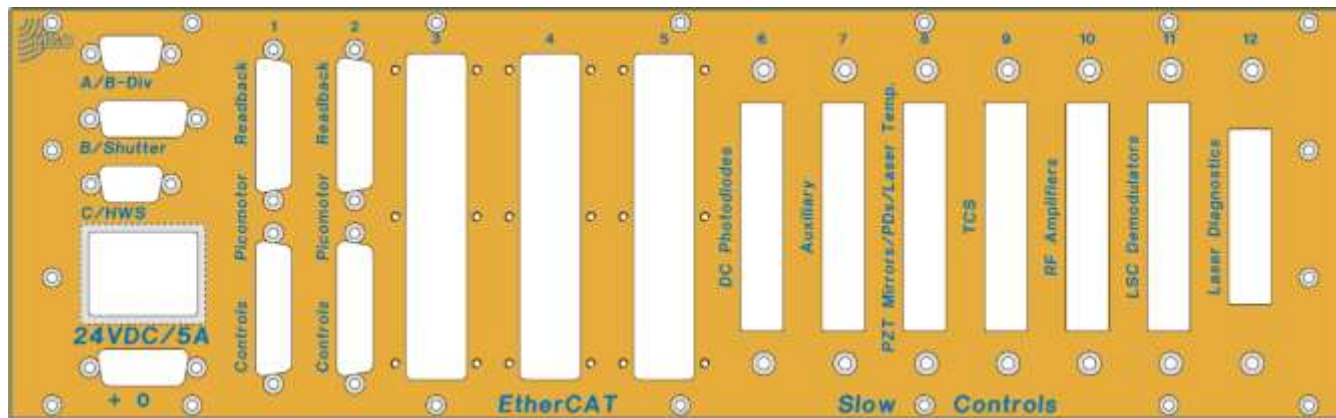

S1000519

Rear: D1101977

D1100680 - Corner 2

Beckhoff Slow Controls
Corner 2

D1100680

SN:

+24VDC

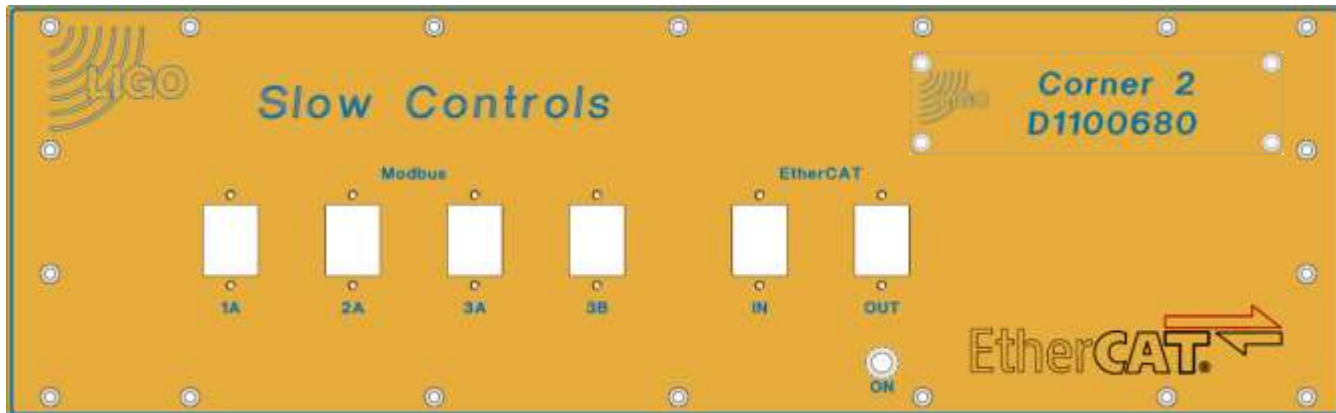

[D1100680](#)

[Front: D1102322](#)

[Name: D1102269](#)

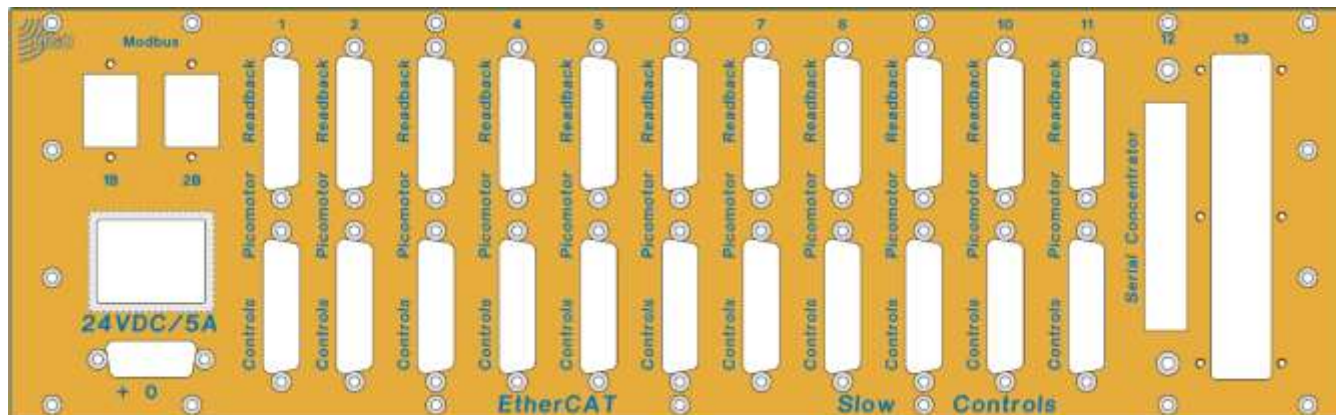

[S1000519](#)

[Rear: D1102268](#)

D1100681 - Corner 3

Beckhoff Slow Controls
Corner 3

D1100681

SN:

+24VDC

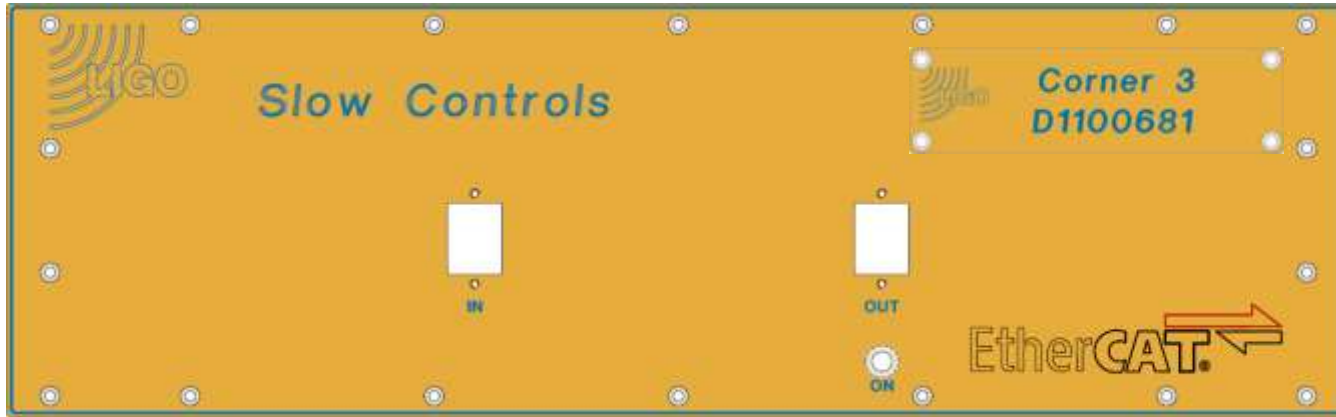

[D1100681](#)

[Front: D0902553](#)

[Name: D1102434](#)

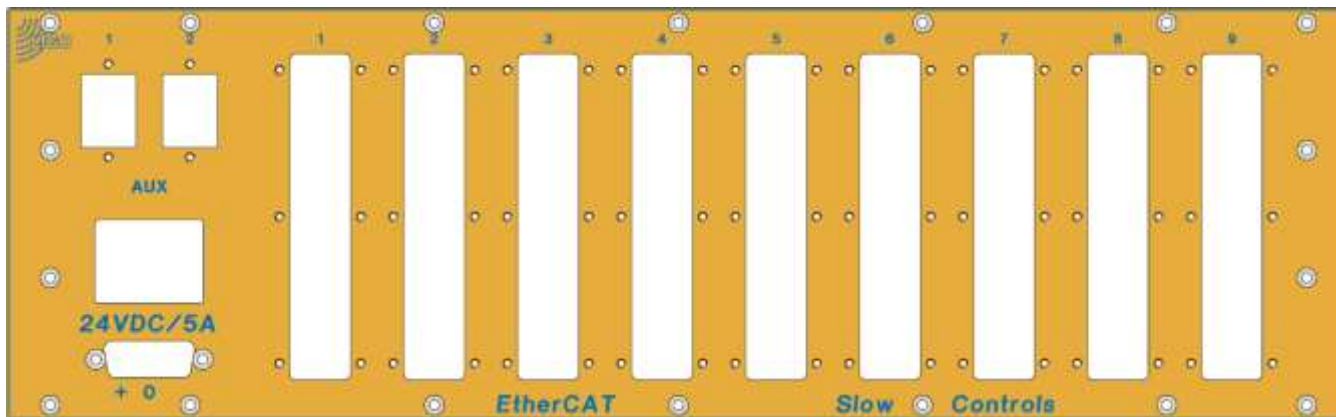

SN:

[Rear: D0902554](#)

D1101266 - Corner 4

Beckhoff Slow Controls
Corner 4

D1101266

SN:

+24VDC

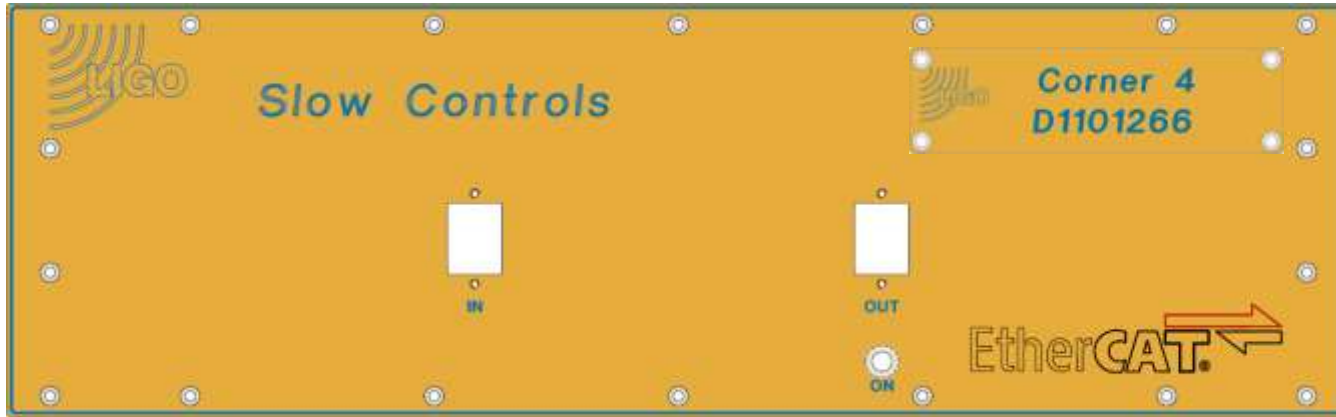

D1101266

Front: D0902553

Name: D1102435

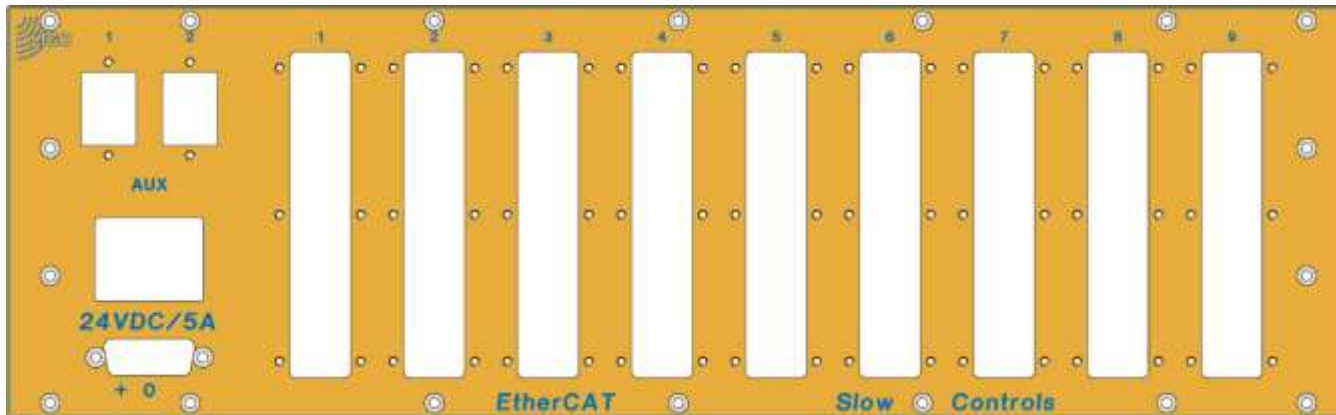

SN:

Rear: D0902554

D1200132 - Corner 5

Beckhoff Slow Controls
Corner 5

D1200132

SN:

+24VDC

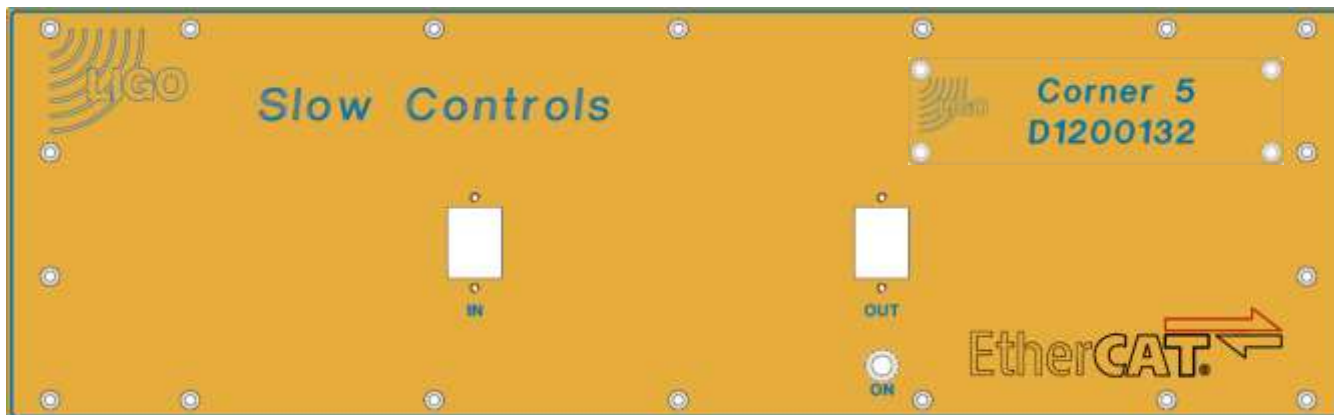

D1200132

Front: D0902553

Name: D1200133

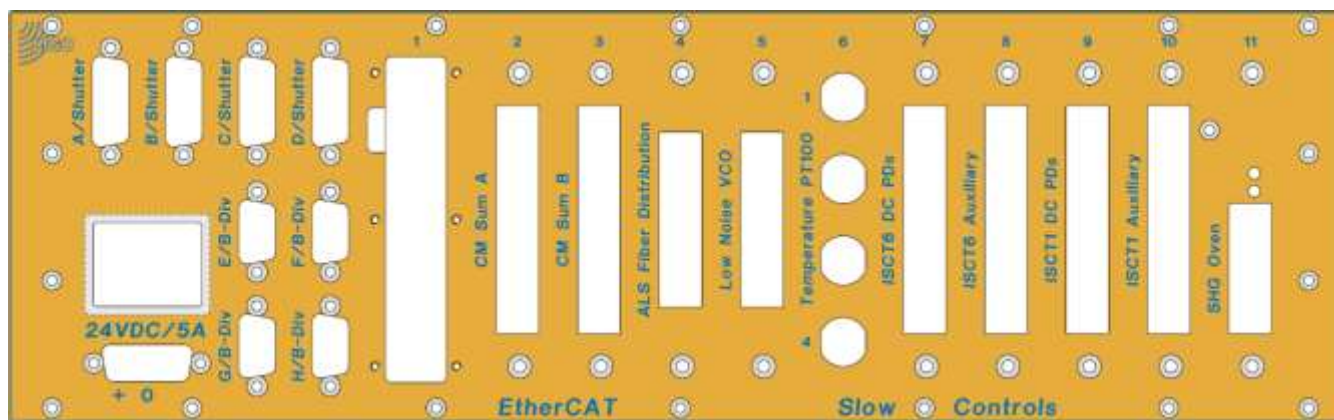

S1000519

Rear: D1201340

D1100618 - Corner MSR

Beckhoff Slow Controls
Corner MSR

D1100618

SN:

+24VDC

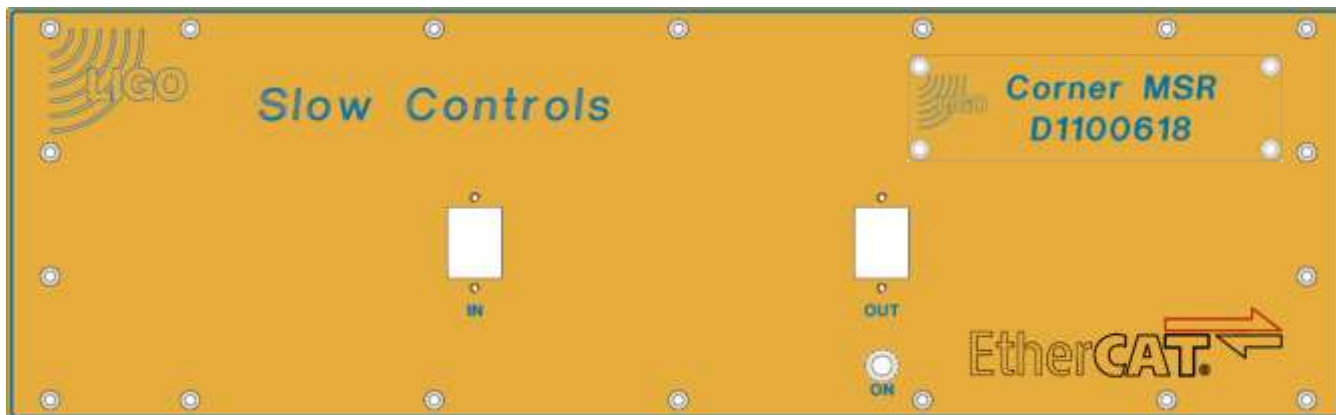

D1100618

Front: D0902553

Name: D1100666

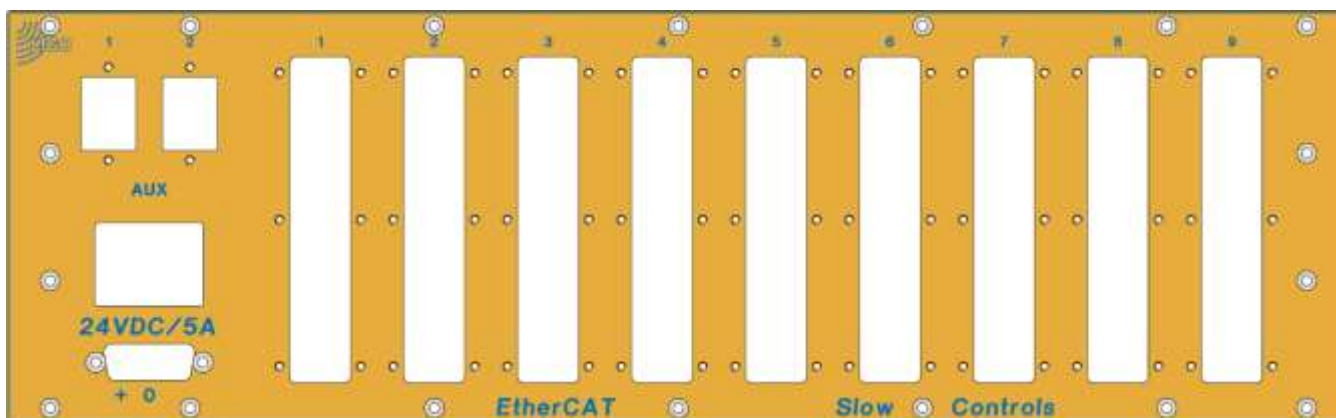

SN:

Rear: D0902554

D1002961 - ISC Common

Beckhoff Slow Controls
ISC Common

D1002961

SN:

+24VDC

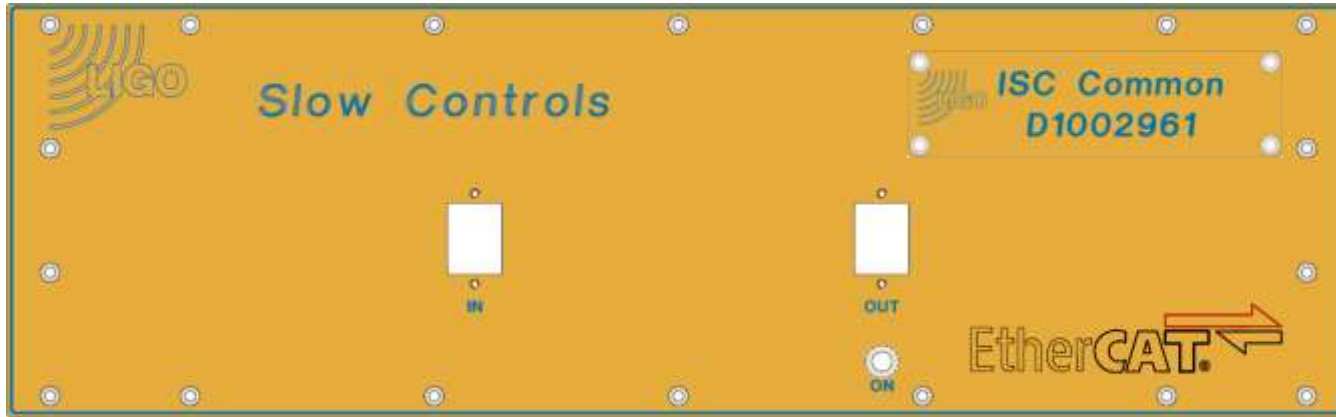

D1002961

Front: D0902553

Name: D1002962

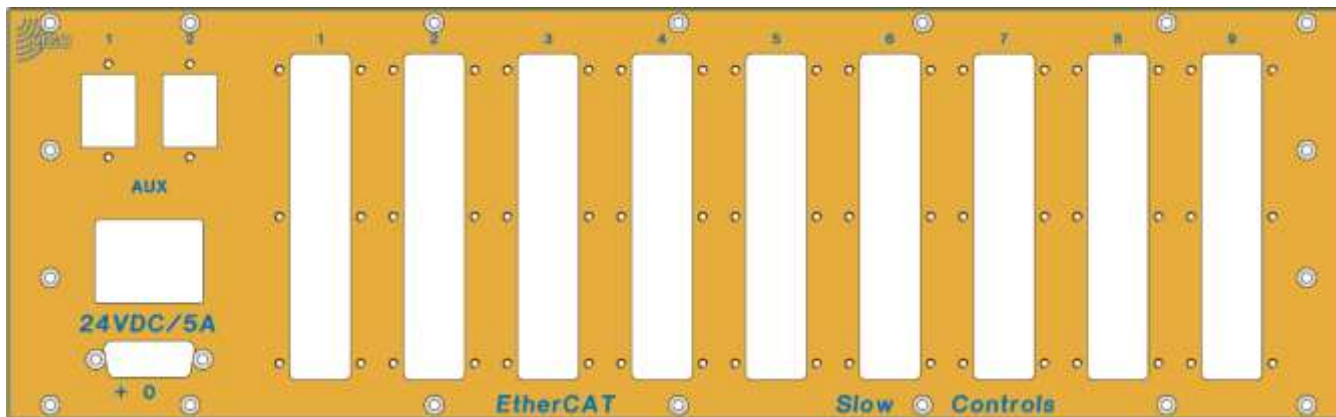

SN:

Rear: D0902554

D0902552 - Empty

Beckhoff Slow Controls
Empty

D0902552

SN:

+24VDC

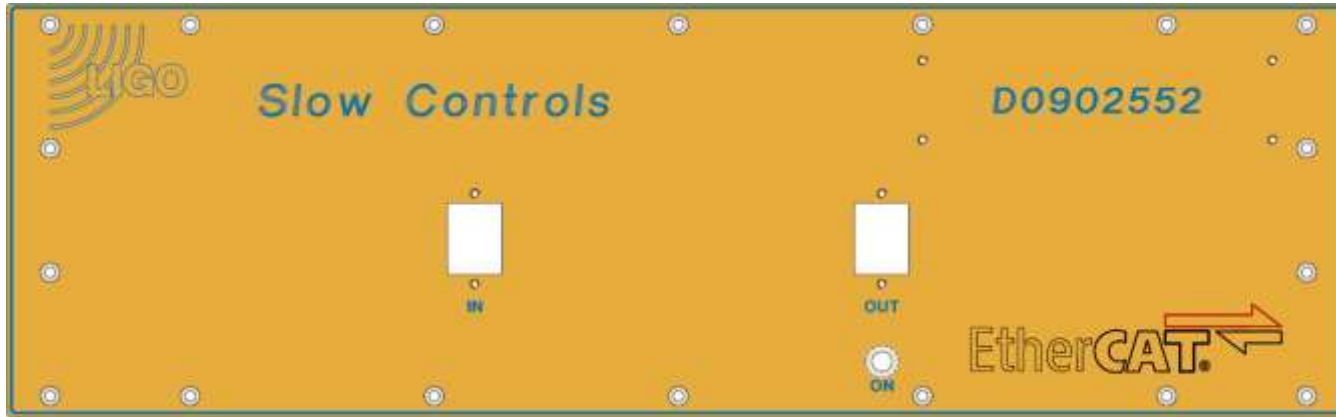

D0902552

Front: D0902553

Name: None

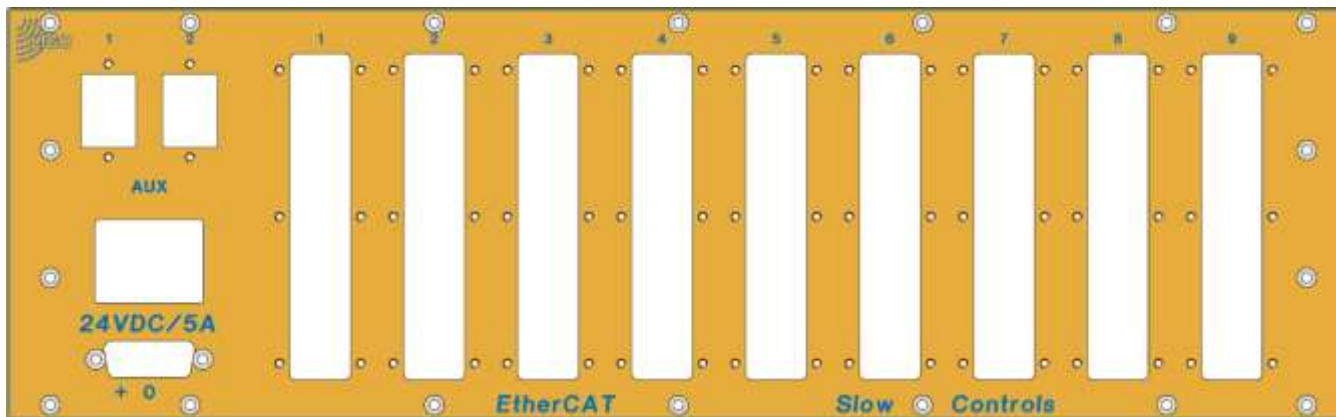

SN:

Rear: D0902554

Flanges

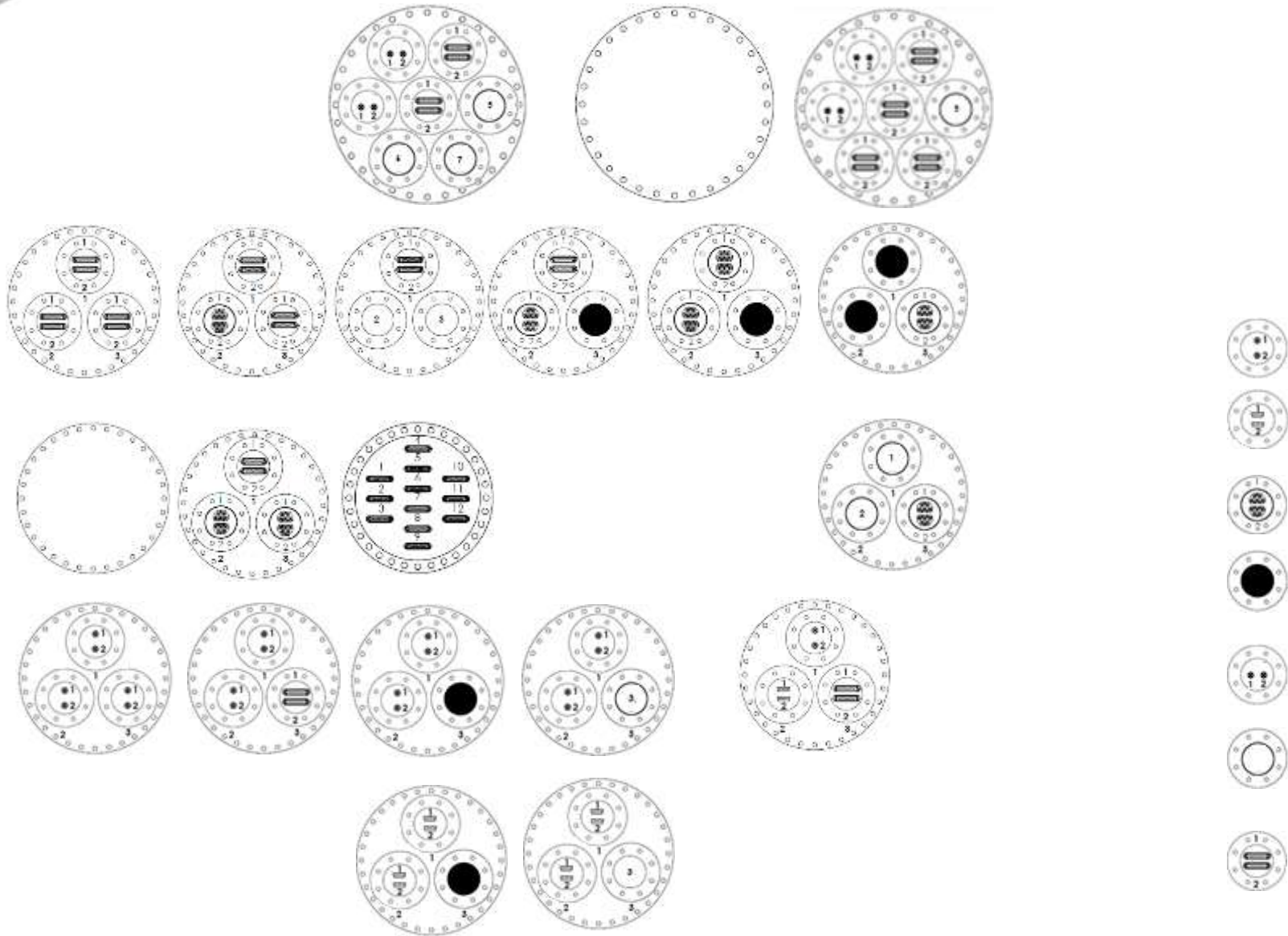

LVEA Vacuum Equipment and Chambers

