

This document provides details about the LLO electronics racks. It may be examined through four separate but interconnected methods: racks may be found searching MAPS of the observatory, or for AREAS in which they reside, or by searching SUBSYSTEMS that they service., or through the DocDB references to their D-numbers or S-numbers.

[Search by LOCATION](#)

[Search by AREA](#)

[Search by SUBSYSTEM](#)

[Search by DocDB](#)

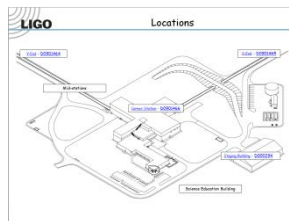

Operator Control Room (OSR)	CD-8 Electronics Room (ES8)	LVEA Racks (LVEA)	Electronics Test Rack (ETR)
Mass Storage Room (MSR)	Laser Diode Room (LDR)	X-End Racks (X-ER)	Other Areas (Other)
Computer User Room (CUR)	ZD-8 Power Room (ZDR)	Y-End Racks (Y-ER)	

Auxiliary Optics CER (LVEA, LVEB) LVEA (LVEA, LVEB) CERX (LVEA, LVEB) VEAX (LVEA, LVEB) CERV (LVEA, LVEB) VEAY (LVEA, LVEB)	Pre-stabilized Laser CER (LVEA) LVEA (LVEA) CERX (LVEA) VEAX (LVEA) CERV (LVEA) VEAY (LVEA)	Vacuum CER (VAC) LVEA (VAC) CERX (VAC) VEAX (VAC) CERV (VAC) VEAY (VAC)
Interferometer Sensing and Control CER (LSC) LVEA (LSC) CERX (LSC) VEAX (LSC) CERV (LSC) VEAY (LSC)	Seismic Isolation CER (SEI) LVEA (SEI) CERX (SEI) VEAX (SEI) CERV (SEI) VEAY (SEI)	DC Power CER (LDC) LVEA (LDC) CERX (LDC) VEAX (LDC) CERV (LDC) VEAY (LDC)
Data Acquisition CER (DAQ, FER, DAF) LVEA (DAQ, FER, DAF) CERX (DAQ, FER, DAF) VEAX (DAQ, FER, DAF) CERV (DAQ, FER, DAF) VEAY (DAQ, FER, DAF)	Suspension CER (SUS) LVEA (SUS) CERX (SUS) VEAX (SUS) CERV (SUS) VEAY (SUS)	Facilities CER (FAC) LVEA (FAC) CERX (FAC) VEAX (FAC) CERV (FAC) VEAY (FAC)



[<< Start](#)

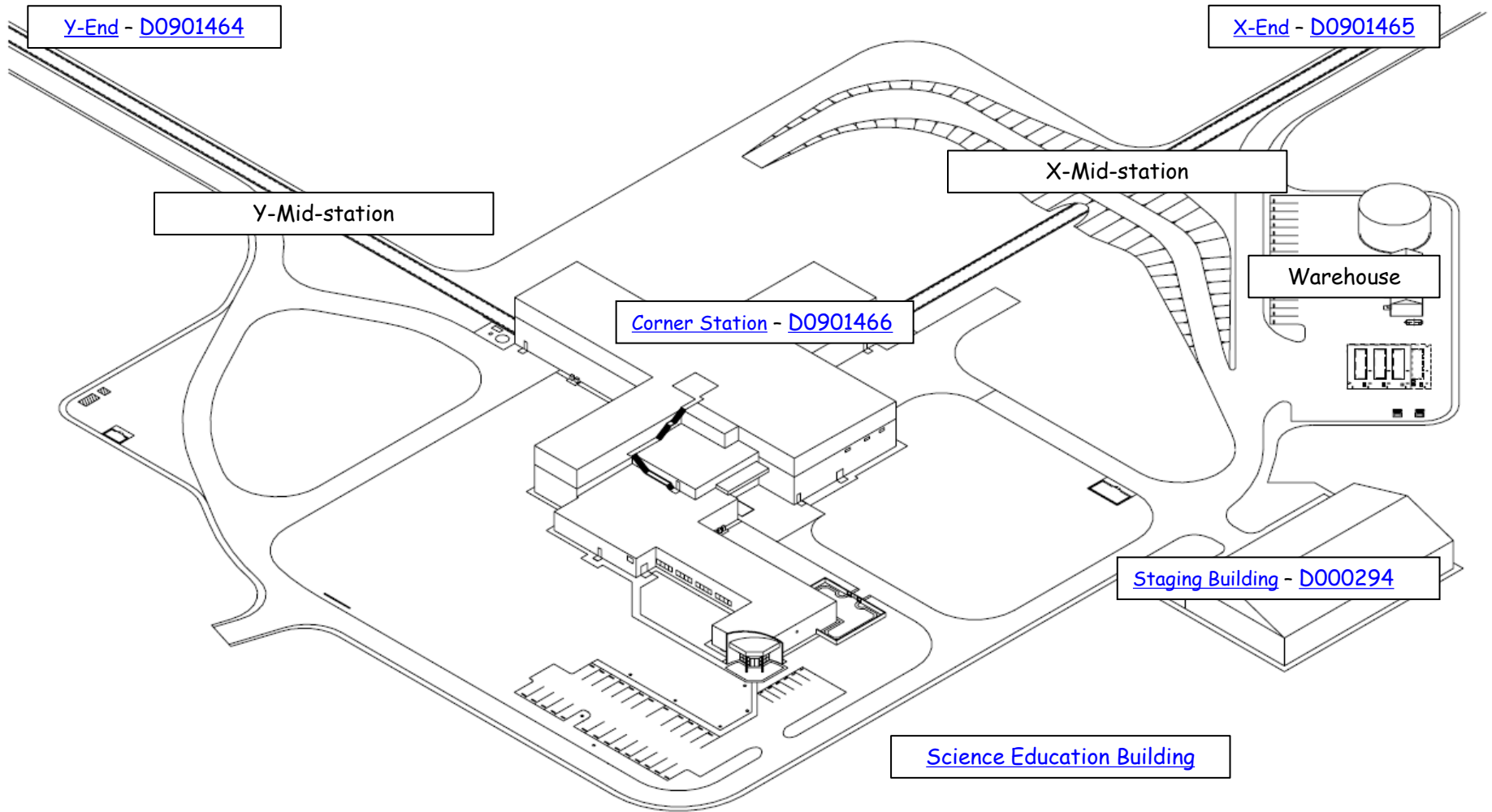

[<< Start](#)

LLO

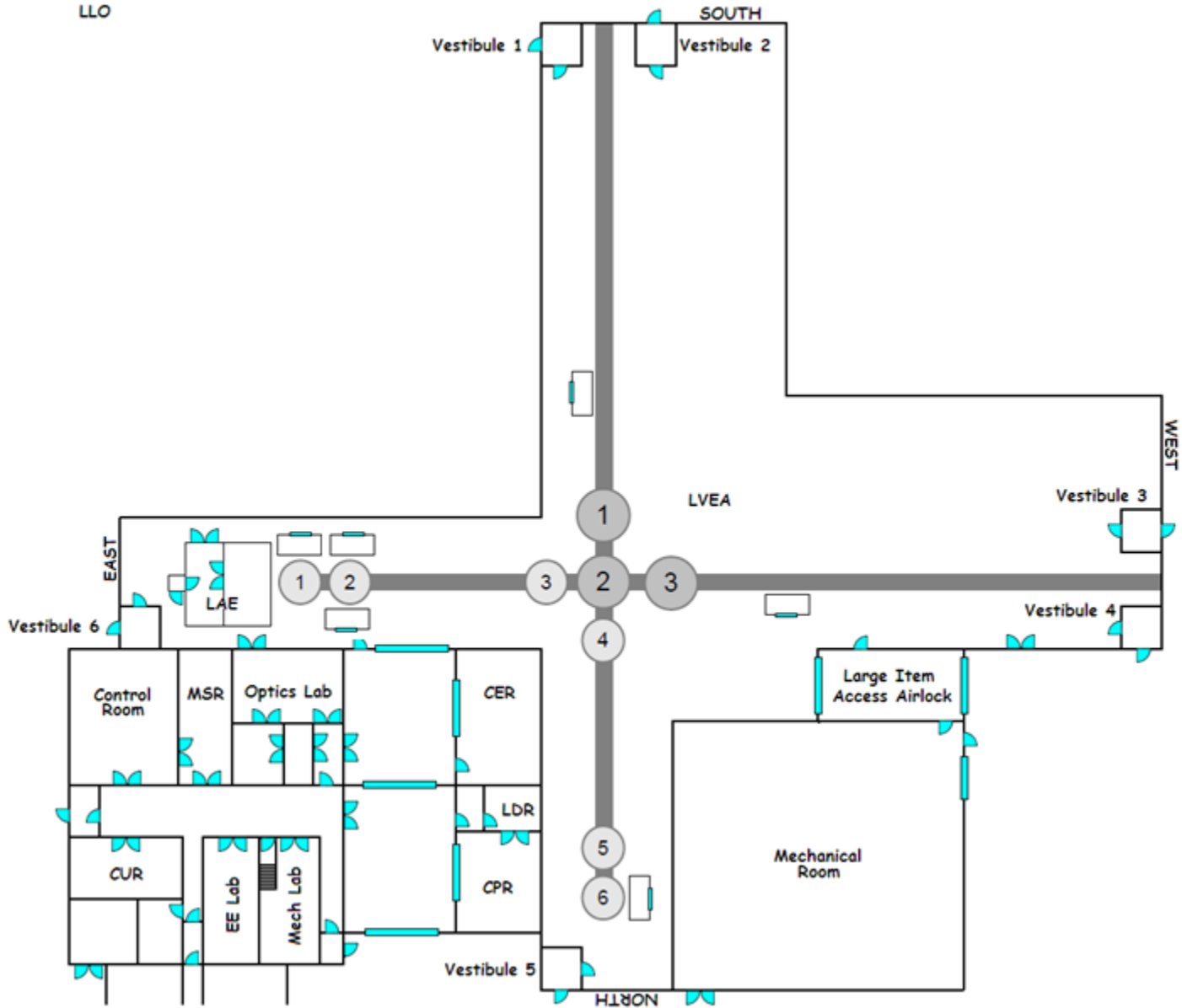

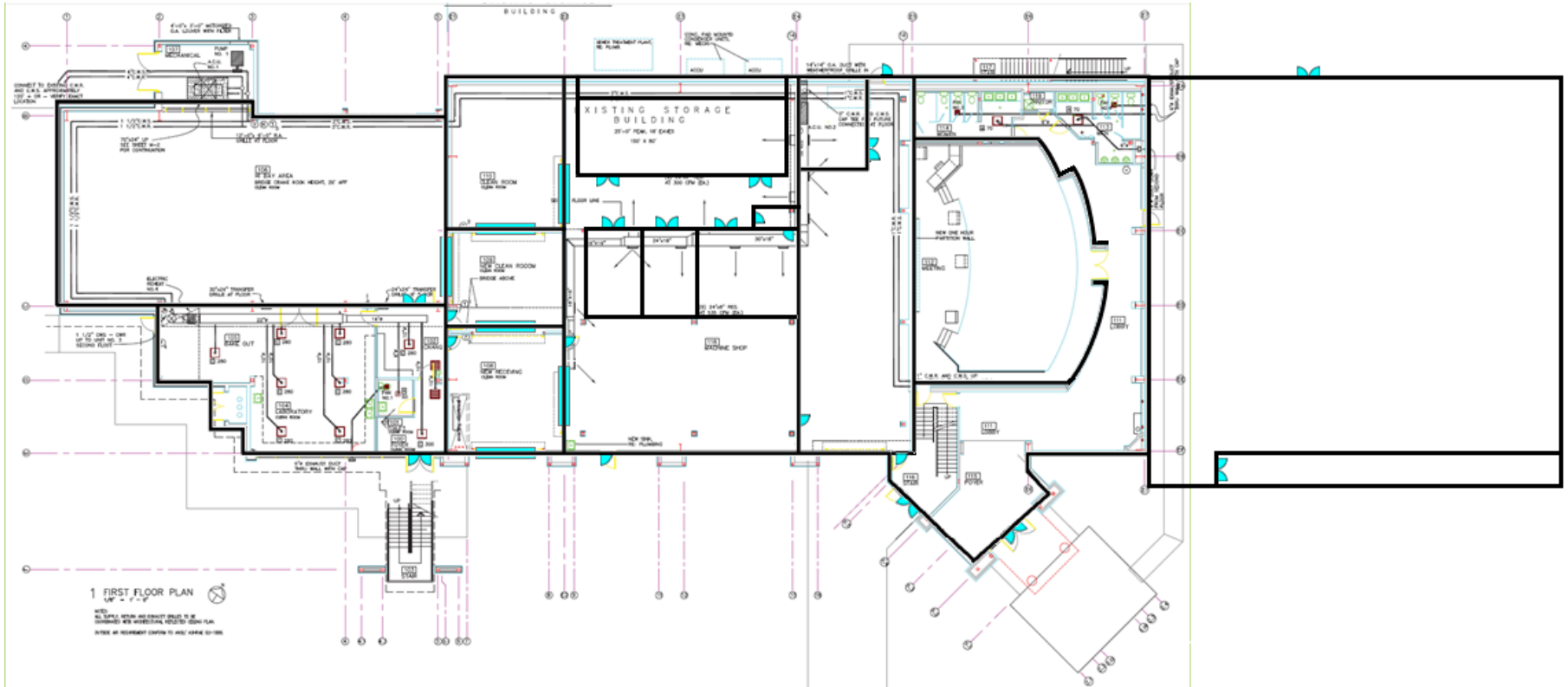

LLO electronics racks are installed in a variety of *LOCATIONS*. Generally speaking, each location houses a specific type of rack. Front-end computers are housed in the [MSR](#). Electronics racks with IO chassis are housed in the [CER](#). Other electronics racks that interface to chambers are located in the [LVEA](#), [X-End](#) and [Y-End](#) areas. Power supplies are housed in the [CPR](#). And finally, test racks for electronics are spread throughout the facility, housed wherever they are required.

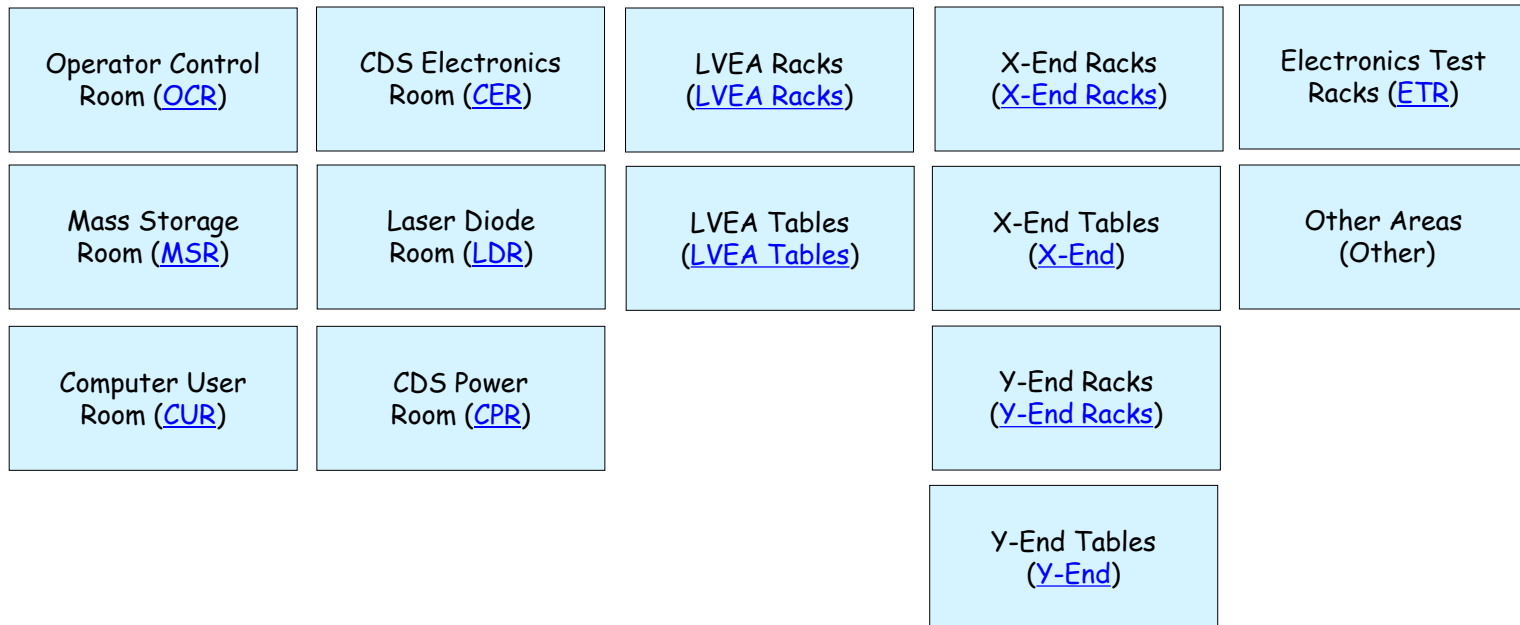

I/O Subsystems are another way to view the racks that are installed in a variety of locations. Generally speaking, each subsystem has racks that are positioned in several physical locations. The subsystems are: AOS, DAQ, ISC, PSL, SEI, SUS, VAC, and VDC. TCS is a part of AOS. PEM and OAF are part of DAQ. HEPI is part of SEI.

<p>Auxiliary Optics CER:(AOS / TCS) LVEA:(AOS / TCS) CERX:(AOS / TCS) VEAX:(AOS / TCS) CERY:(AOS / TCS) VEAY:(AOS / TCS)</p>	<p>Pre-stabilized Laser CER:(PSL) LVEA:(PSL) CERX:(PSL) VEAX:(PSL) CERY:(PSL) VEAY:(PSL)</p>	<p>Vacuum CER:(VAC) LVEA:(VAC) CERX:(VAC) VEAX:(VAC) CERY:(VAC) VEAY:(VAC)</p>
<p>Interferometer Sensing and Control CER:(ISC) LVEA:(ISC) CERX:(ISC) VEAX:(ISC) CERY:(ISC) VEAY:(ISC)</p>	<p>Seismic Isolation CER:(SEI) LVEA:(SEI) CERX:(SEI) VEAX:(SEI) CERY:(SEI) VEAY:(SEI)</p>	<p>DC Power CER:(VDC) LVEA:(VDC) CERX:(VDC) VEAX:(VDC) CERY:(VDC) VEAY:(VDC)</p>
<p>Data Acquisition CER:(DAQ / PEM / OAF) LVEA:(DAQ / PEM / OAF) CERX:(DAQ / PEM / OAF) VEAX:(DAQ / PEM / OAF) CERY:(DAQ / PEM / OAF) VEAY:(DAQ / PEM / OAF)</p>	<p>Suspensions CER:(SUS) LVEA:(SUS) CERX:(SUS) VEAX:(SUS) CERY:(SUS) VEAY:(SUS)</p>	<p>Facilities CER:(FAC) LVEA:(FAC) CERX:(FAC) VEAX:(FAC) CERY:(FAC) VEAY:(FAC)</p>

CDS racks are named according to site, IFO designation, subsystem use, station (location) and sequence. (See [G1001030](#))

Site	Description	IFO	Subsystem	Description	Station	Description	Rack Number
L	Livingston	1	AOS	Auxiliary Optics	C	[Corner] Common	1
H	Hanford	2	DAQ	Data Acquisition	MS	Mass Storage	2
M	MIT		ETR	Electronics Test Rack	R	[Corner] Remote (Field)	3
C	CIT		FAC	Facilities and Infrastructure	XC	X-End Common	4
			ISC	IFO Sensing and Control	XR	X-End Remote [Field]	5
			LDR	Laser Diode Room	YC	Y-End Common	6
			OAF	Online Adaptive Filtering	YR	Y-End Remote [Field]	7
			PEM	Physical Environment Monitoring			8
			PSL	Pre-stabilized Laser			9
			SEI	Seismic Isolation			10
			SUS	Suspensions			11
			TCS	Thermal Compensation System			12
			VAC	Vacuum			etc.
			VDC	Voltage - DC			

LLO CDS Electronics Rack Names

<< Start

CDS racks are named according to site, IFO designation, subsystem use, station (location) and sequence. (See [G1001030](#))

Rack	Rack Designator	Subsystem	Location	Comment	Rack Type	Dxxxxxxx	Sxxxxxxx
1	L1-AOS-C1	AOS	CER		Standard	D1201119	S1202974
2	L1-TCS-R1	AOS	LVEA		Standard	D1201122	S1202975
3	L1-TCS-R2	AOS	LVEA		Standard	D1201123	S1202976
4	L1-TCS-XC1	AOS	CERX		Standard	D1201129	S1202980
5	L1-TCS-YC1	AOS	CERY		Standard	D1201130	S1202981
6	L1-OAF-C1	DAQ	CER	OAF/PEM	Standard	D1200941	S1202404
7	L1-DAQ-XC1	DAQ	CERX		Standard	D1201085	S1202949
8	L1-DAQ-YC1	DAQ	CERY		Standard	D1201092	S1202956
9	L1-ISC-C1	ISC	CER		Standard	D1200949	S1201186
10	L1-ISC-C2	ISC	CER		Standard	D1200975	S1201187
11	L1-ISC-C3	ISC	CER		Standard	D1200976	S1201188
12	L1-ISC-C4	ISC	CER		Standard	D1200977	S1201189
13	L1-ISC-R1	ISC	LVEA		Standard	D1001460	S1201192
14	L1-ISC-R2	ISC	LVEA		Standard	D1001425	S1201193
15	L1-ISC-R3	ISC	LVEA		Standard	D1001426	S1201194
16	L1-ISC-R4	ISC	LVEA		Standard	D1101904	S1201195
17	L1-ISC-R5	ISC	LVEA		Standard	D1200196	S1201196
18	L1-ISC-XC1	ISC	CERX		Standard	D1201084	S1202948
19	L1-ISC-YC1	ISC	CERY		Standard	D1201091	S1202955
20	L1-ISC-XR1	ISC	VEAX		Standard	D1201087	S1202951
21	L1-ISC-YR1	ISC	VEAY		Standard	D1201094	S1202958
22	L1-ETR-04	OPTICS	Test Rack	Optics Electronics Lab Rack	11U		
23	L1-LDR-C1	PSL	LDR		Vendor		
24	L1-LDR-C2	PSL	LDR		Vendor		
25	L1-PSL-C1	PSL	CER		Standard	D1201118	S1202977
26	L1-PSL-R1	PSL	LVEA		Standard	D1201120	S1202978
27	L1-PSL-R2	PSL	LVEA		Standard	D1201121	S1202979
28	L1-SEI-C1	SEI	CER	SET HAM 1 and HAM 6	Standard	D1201112	S1200743
29	L1-SEI-C2	SEI	CER	SET HAM 2 and HAM 3	Standard	D1201113	S1200744
30	L1-SEI-C3	SEI	CER	SET HAM 4 and HAM 5	Standard	D1201114	S1200745
31	L1-SEI-C4	SEI	CER	SET BCS1	Standard	D1201115	S1200746
32	L1-SEI-C5	SEI	CER	SET BCS2	Standard	D1201116	S1200747
33	L1-SEI-C6	SEI	CER	SET BCS3	Standard	D1201117	S1200748
34	L1-SEI-XC1	SEI	CERX	SET BCS4	Standard	D1201081	S1202945
35	L1-SEI-YC1	SEI	CERY	SET BCS5	Standard	D1201088	S1202952
36	L1-ETR-05	SET	Test Rack	HAM ISI Electronics Test Rack			
37	L1-ETR-07	SET	Test Rack	Triple Electronics Test Rack			
38	L1-SUS-C1	SUS	CER	SUS ITM, FM, and BS (1 of 2)	Standard	D1200856	S1104062
39	L1-SUS-C2	SUS	CER	SUS ITM, FM, and BS (2 of 2)	Standard	D1200859	S1104356
40	L1-SUS-C3	SUS	CER	SUS HAM 2 (1 of 2)	Standard	D1200864	S1104357
41	L1-SUS-C4	SUS	CER	SUS HAM 2 (2 of 2)	Standard	D1200867	S1104358
42	L1-SUS-C5	SUS	CER	SUS ITMX, ITMY, and BS (1 of 2)	Standard	D1200874	S1105375
43	L1-SUS-C6	SUS	CER	SUS ITMX, ITMY, and BS (2 of 2)	Standard	D1200875	S1105376
44	L1-SUS-C7	SUS	CER	SUS HAM 5 and HAM 6 (1 of 2)	Standard	D1200876	S1105377
45	L1-SUS-C8	SUS	CER	SUS HAM 5 and HAM 6 (2 of 2)	Standard	D1200877	S1105378
46	L1-SUS-R1	SUS	LVEA		Standard	D1200879	S1200749
47	L1-SUS-R2	SUS	LVEA		Standard	D1200880	S1200750
48	L1-SUS-R3	SUS	LVEA		Standard	D1200883	S1202300

49	L1-SUS-R4	SUS	LVEA		Standard	D1201134	S1202995
50	L1-SUS-R5	SUS	LVEA		Standard	D1201135	S1202996
51	L1-SUS-R6	SUS	LVEA		Standard	D1201136	S1202997
52	L1-SUS-XC1	SUS	CERX		Standard	D1201082	S1202946
53	L1-SUS-XC2	SUS	CERX		Standard	D1201083	S1202947
54	L1-SUS-XR1	SUS	VEAX		Standard	D1201131	S1202993
55	L1-SUS-YC1	SUS	CERY		Standard	D1201089	S1202953
56	L1-SUS-YC2	SUS	CERY		Standard	D1201090	S1202954
57	L1-SUS-YR1	SUS	VEAY		Standard	D1201132	S1202994
58	L1-ETR-02	SUS	Test Rack	BSC Electronics Test Rack			
59	L1-ETR-03	SUS	Test Rack	RM Electronics Test Rack			
60	L1-ETR-06	SUS	Test Rack	STS Huddle Electronics Test Rack			
61	L1-VAC-R1	VAC	LVEA	Vacuum Rack - X Arm	Knurr		
62	L1-VAC-R2	VAC	LVEA	Vacuum Rack - Y Arm	Knurr		
63	L1-VAC-R3	VAC	Mechanical Room	Vacuum Rack - Mechanical Room	Knurr		
64	L1-VAC-XR1	VAC	VEAX	Vacuum Rack - X End	Knurr		
65	L1-VAC-YR1	VAC	VEAY	Vacuum Rack - Y End	Knurr		
66	L1-VDC-C1	VDC	CPR		DC	D1200890	S1105247
67	L1-VDC-C2	VDC	CPR		DC	D1200891	S1105248
68	L1-VDC-C3	VDC	CPR		DC	D1200892	S1105249
69	L1-VDC-C4	VDC	CPR		DC	D1200893	S1105250
70	L1-VDC-C5	VDC	CPR		DC	D1200894	S1105251
71	L1-VDC-C6	VDC	CPR		DC	D1200895	S1105252
72	L1-VDC-C7	VDC	CPR		DC	D1200896	S1105253
73	L1-VDC-C8	VDC	CPR	Planned	DC	D1201137	S1202998
74	L1-VDC-XC1	VDC	CERX		DC	D1200897	S1202311
75	L1-VDC-XC2	VDC	CERX		DC	D1200898	S1202312
76	L1-VDC-YC1	VDC	CERY		DC	D1200899	S1202313
77	L1-VDC-YC2	VDC	CERY		DC	D1200900	S1202314
78	L1-MSR-01	CDS	MSR	Atomic Clock	Knurr	D1201372	S1203487
79	L1-MSR-02	CDS	MSR	Fiber Patch	Knurr	D1201373	S1203488
80	L1-MSR-03	CDS	MSR	EPICS	Knurr	D1201374	S1203489
81	L1-MSR-04	CDS	MSR	EPICS	Knurr	D1201375	S1203490
82	L1-MSR-05	CDS	MSR	Backup Tape	Knurr	D1201376	S1203491
83	L1-MSR-06	CDS	MSR	Video	Knurr	D1201377	S1203492
84	L1-MSR-07	CDS	MSR	IFO Front End Computers	Standard	D1201378	S1203493
85	L1-MSR-08	CDS	MSR	IFO Front End Computers	Standard	D1201379	S1203494
86	L1-MSR-09	CDS	MSR	CDS Computers	Standard	D1201380	S1203495
87	L1-MSR-10	CDS	MSR	CDS Computers	Standard	D1201381	S1203496
88	L1-MSR-11	CDS	MSR	General Computing	Standard	D1201382	S1203497
89	L1-MSR-12	CDS	MSR	DAQ Electronics Test Rack	Standard	D1201383	S1203498
90	L1-MSR-13	CDS	MSR	UPS for IFO and CDS Computers	Linier	D1201384	S1203499
91	L1-FAC-C1	FAC	CER		Standard	D1200940	S1202403
92	L1-FAC-XC1	FAC	CERX		Standard	D1201086	S1202950
93	L1-FAC-YC1	FAC	CERY		Standard	D1201093	S1202957
94	L1-UNK-C1	CER			Standard	D1201356	S1203450
95	L1-UNK-C2	CER			Standard	D1201357	S1203451
96	L1-UNK-C3	CER			Standard	D1201358	S1203452

[<< Locations](#)

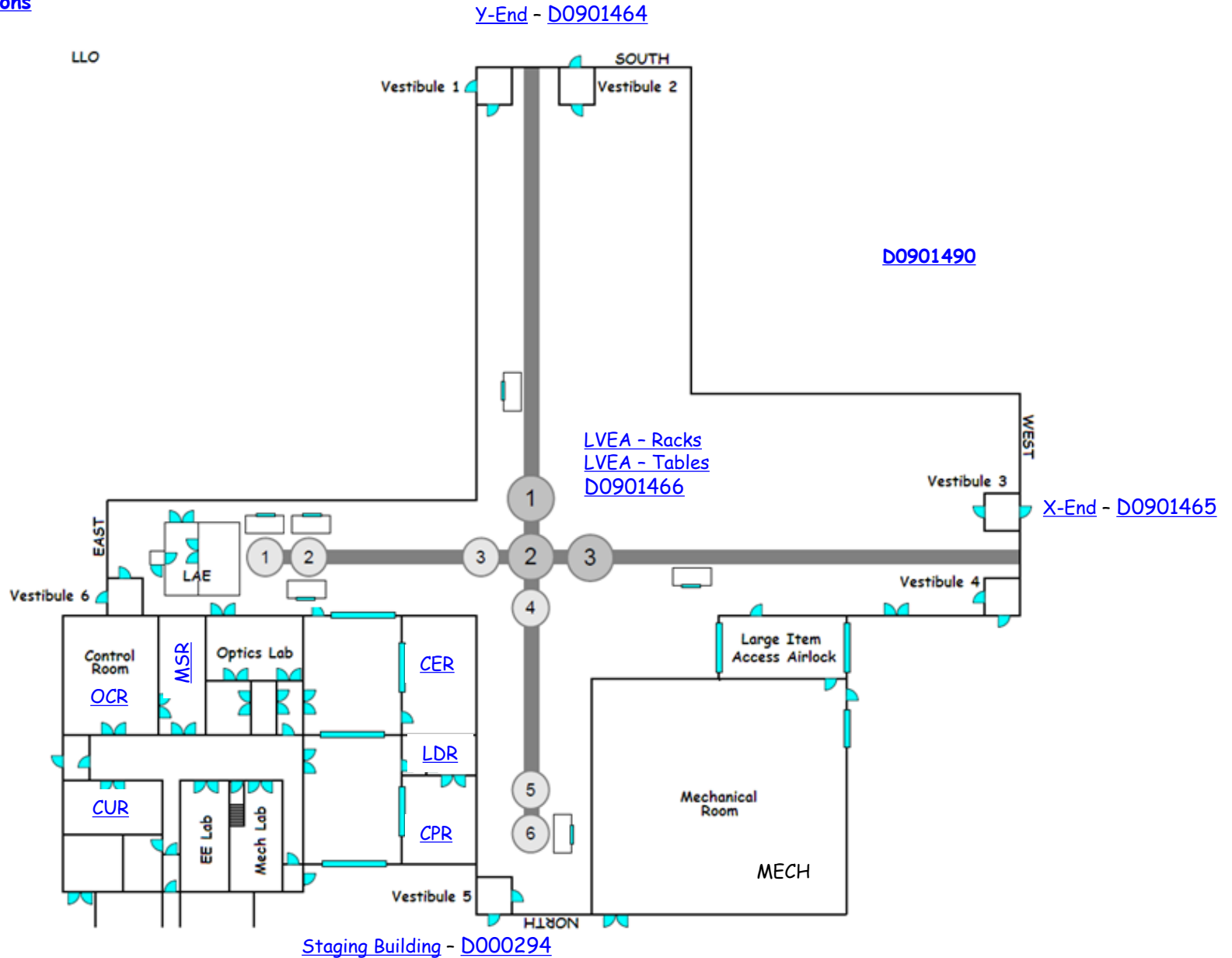

[<< LLO Corner Station](#)

[<< LLO Racks by AREA](#)

[<< LLO CDS Components](#)

OCR

[OCR Documentation](#)

[<< LLO Corner Station](#)

[<< LLO Racks by AREA](#)

[<< LLO CDS Components](#)

CUR

[CUR Documentation](#)

[<< LLO Corner Station](#)

[<< LLO Racks by AREA](#)

[<< LLO CDS Components](#)

MSR

[MSR Documentation](#)

[MSR Layout](#)

[IO Extenders Index](#)

MSR (Mass Storage Room) Layout

- << LLO Corner Station
- << LLO Racks by AREA
- << LLO CDS Components

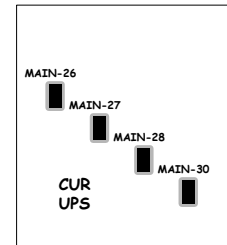
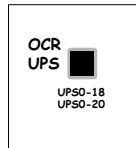
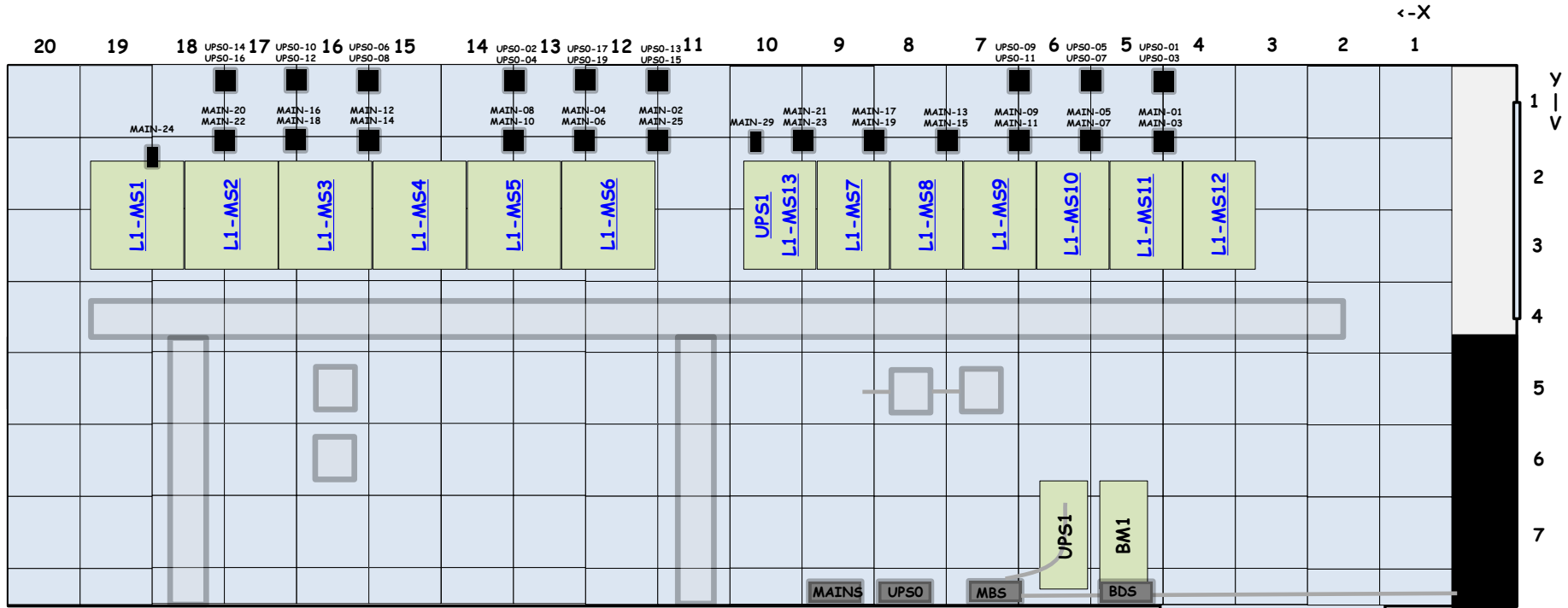

MSR Power Panels

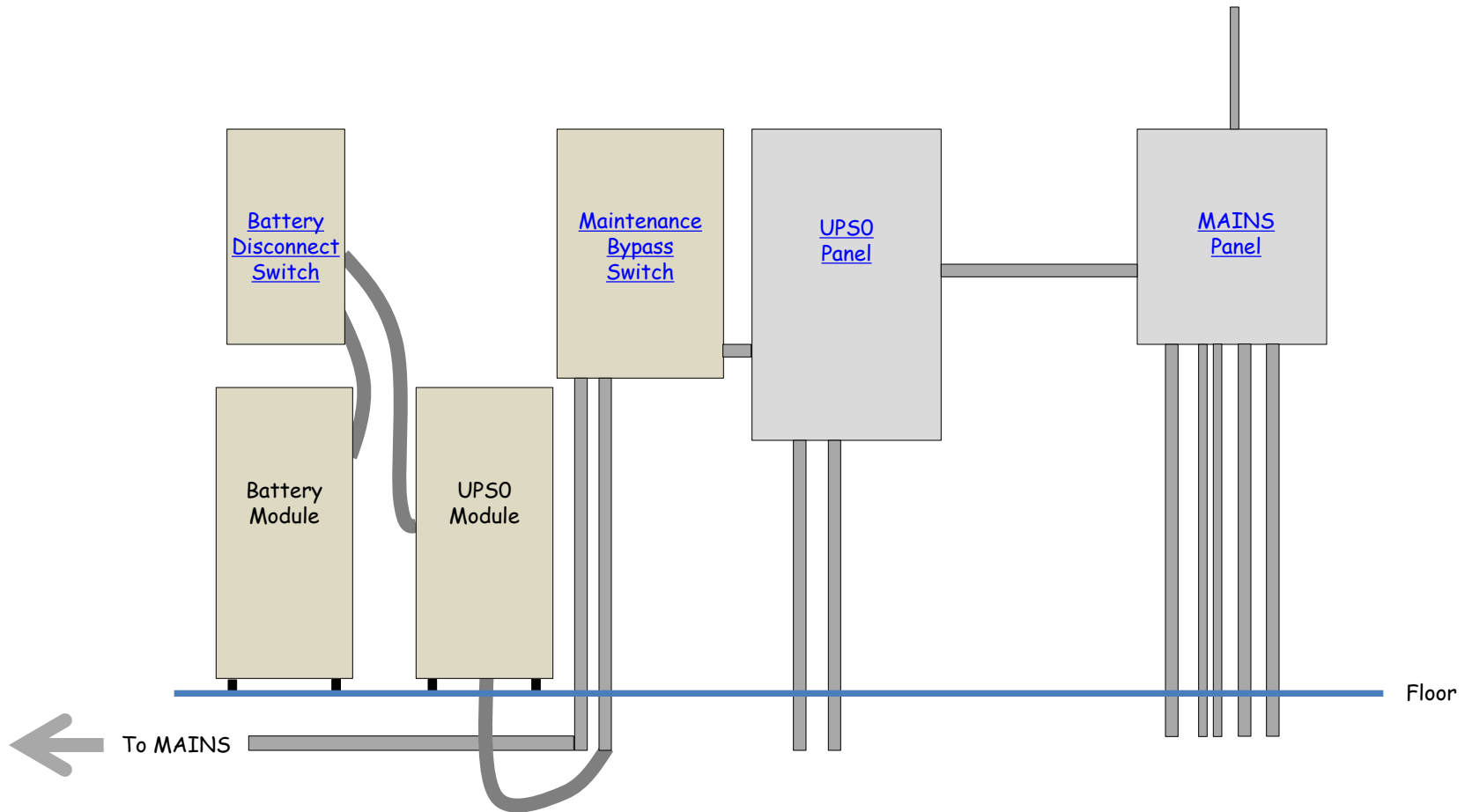

Panel	Circuit	Circuit Voltage	Breaker Amperage	Outlet Box Label	Type	Outlet Amperage	Outlet Color	Outlet Strip	Rack
UPS Panel	1	110	20	UPS CKT 1	DD 5-20R	110VAC 20A	Orange	Open	Open
UPS Panel	2	110	20	UPS CKT 2	DD 5-20R	110VAC 20A	Orange	20A-009	MS4-2
UPS Panel	3	110	20	UPS CKT 3	DD 5-20R	110VAC 20A	Orange	Open	Open
UPS Panel	4	110	20	UPS CKT 4	DD 5-20R	110VAC 20A	Orange	20A-011	MS4-1
UPS Panel	5	110	20	UPS CKT 5	DD 5-20R	110VAC 20A	Orange	20A-028	MS11-1
UPS Panel	6	110	20	UPS CKT 6	DD 5-20R	110VAC 20A	Orange	20A-004	MS3-1
UPS Panel	7	110	20	UPS CKT 7	DD 5-20R	110VAC 20A	Orange	20A-045	MS11-2
UPS Panel	8	110	20	UPS CKT 8	DD 5-20R	110VAC 20A	Orange	20A-003	MS3-2
UPS Panel	9	110	20	UPS CKT 9	DD 5-20R	110VAC 20A	Orange	20A-047	MS10-2
UPS Panel	10	110	20	UPS CKT 10	DD 5-20R	110VAC 20A	Orange	20A-002	MS2-1
UPS Panel	11	110	20	UPS CKT 11	DD 5-20R	110VAC 20A	Orange	20A-048	MS10-1
UPS Panel	12	110	20	UPS CKT 12	DD 5-20R	110VAC 20A	Orange	20A-001	MS2-2
UPS Panel	13	110	20	UPS CKT 13	DD 5-20R	110VAC 20A	Orange	15A-001	MS6-1
UPS Panel	14	110	20	UPS CKT 14	DD 5-20R	110VAC 20A	Orange	Open	Open
UPS Panel	15	110	20	UPS CKT 15	DD 5-20R	110VAC 20A	Orange	Open	Open
UPS Panel	16	110	20	UPS CKT 16	DD 5-20R	110VAC 20A	Orange	20A-007	MS1-1
UPS Panel	17	110	20	UPS CKT 17	DD 5-20R	110VAC 20A	Orange	20A-005	MS5-1
UPS Panel	18	110	20	UPS CKT 18	DD 5-20R	110VAC 20A	Orange	Operator Desk	OCR X11Y2
UPS Panel	19	110	20	UPS CKT 19	DD 5-20R	110VAC 20A	Orange	20A-008	MS5-2
UPS Panel	20	110	20	UPS CKT 20	DD 5-20R	110VAC 20A	Orange	Operator Desk	OCR X11Y2
									As of 4/8/2013

Panel	Circuit	Circuit Voltage	Breaker Amperage	Outlet Box Label	Type	Outlet Amperage	Outlet Color	Outlet Strip	Destination
MAINS	01	110	20	MAIN CKT 1	DD 5-20R	110VAC 20A	White	15A-005	MS12-2
MAINS	02	110	20	MAIN CKT 2	DD 5-20R	110VAC 20A	White	20A-021	MS7-3
MAINS	03	110	20	MAIN CKT 3	DD 5-20R	110VAC 20A	White	15A-006	MS12-1
MAINS	04	110	20	MAIN CKT 4	DD 5-20R	110VAC 20A	White	20A-014	MS5-1
MAINS	05	110	20	MAIN CKT 5	DD 5-20R	110VAC 20A	White	20A-027	MS11-1
MAINS	06	110	20	MAIN CKT 6	DD 5-20R	110VAC 20A	White	20A-015	MS5-2
MAINS	07	110	20	MAIN CKT 7	DD 5-20R	110VAC 20A	White	20A-046	MS11-2
MAINS	08	110	20	MAIN CKT 8	DD 5-20R	110VAC 20A	White	20A-029	MS4-2
MAINS	09	110	20	MAIN CKT 9	DD 5-20R	110VAC 20A	White	20A-044	MS10-2
MAINS	10	110	20	MAIN CKT 10	DD 5-20R	110VAC 20A	White	20A-010	MS4-1
MAINS	11	110	20	MAIN CKT 11	DD 5-20R	110VAC 20A	White	20A-043	MS10-1
MAINS	12	110	20	MAIN CKT 12	DD 5-20R	110VAC 20A	White	20A-016	MS3-2
MAINS	13	110	20	MAIN CKT 13	DD 5-20R	110VAC 20A	White	20A-025	MS9-2
MAINS	14	110	20	MAIN CKT 14	DD 5-20R	110VAC 20A	White	20A-012	MS3-1
MAINS	15	110	20	MAIN CKT 15	DD 5-20R	110VAC 20A	White	20A-026	MS9-1
MAINS	16	110	20	MAIN CKT 16	DD 5-20R	110VAC 20A	White	20A-013	MS2-1
MAINS	17	110	20	MAIN CKT 17	DD 5-20R	110VAC 20A	White	20A-024	MS8-1
MAINS	18	110	20	MAIN CKT 18	DD 5-20R	110VAC 20A	White	20A-017	MS2-2
MAINS	19	110	20	MAIN CKT 19	DD 5-20R	110VAC 20A	White	20A-018	MS8-2
MAINS	20	110	20	MAIN CKT 20	DD 5-20R	110VAC 20A	White	Open	Open
MAINS	21	110	20	MAIN CKT 21	DD 5-20R	110VAC 20A	White	20A-019	MS7-2
MAINS	22	110	20	MAIN CKT 22	DD 5-20R	110VAC 20A	White	20A-038	MS1-1
MAINS	23	110	20	MAIN CKT 23	DD 5-20R	110VAC 20A	White	20A-020	MS7-1
MAINS	24	110	30	MAIN CKT 24	L6-30R	110VAC 30A	Brown	Single Outlet	Open
MAINS	25	110	20	MAIN CKT 25	DD 5-20R	110VAC 20A	White	15A-002	MS6-1
MAINS	26	110	30	MAIN CKT 26	L6-30R	110VAC 30A	Brown	Single Outlet	CUR-UPS 1
MAINS	27	110	30	MAIN CKT 27	L6-30R	110VAC 30A	Brown	Single Outlet	CUR-UPS 2
MAINS	28	110	30	MAIN CKT 28	L6-30R	110VAC 30A	Brown	Single Outlet	CUR-UPS 3
MAINS	29	110	20	MAIN CKT 29	DD 5-20R	110VAC 20A	White	20A-055	MS9-3
MAINS	30	110	30	MAIN CKT 30	L6-30R	110VAC 30A	Brown	Single Outlet	CUR-UPS 3
MAINS	31/32/33		100						As of 4/8/2013

Battery Module

30 each NPX-150R

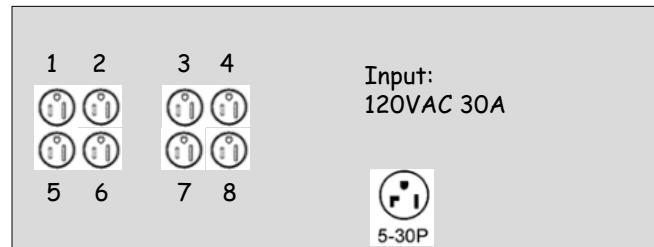

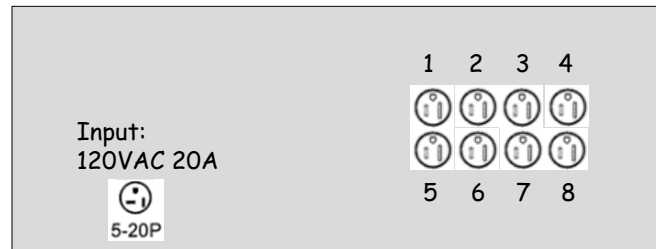

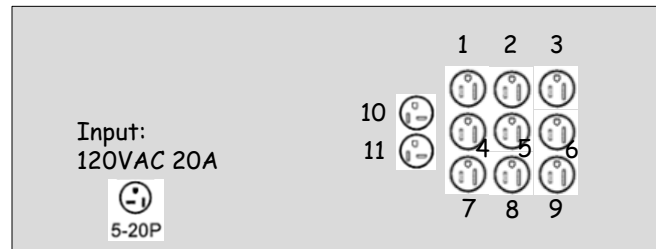

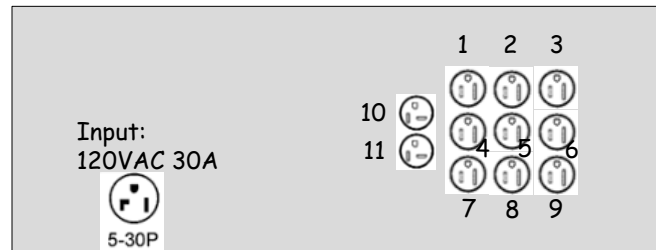

UPS1 ACP 10000XL

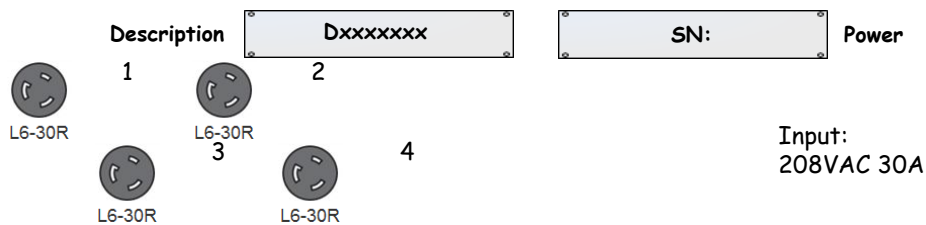
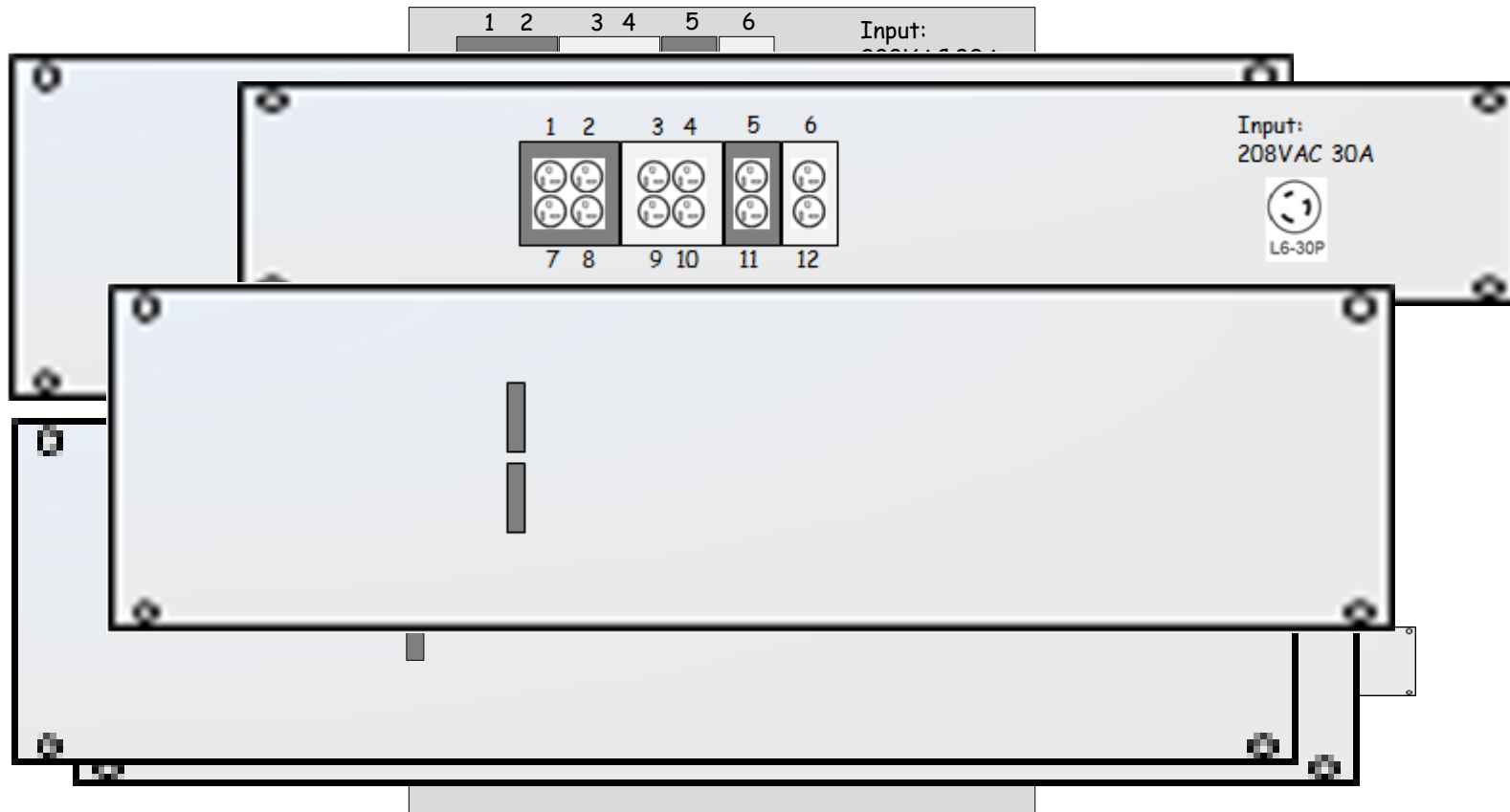

UPS0 Battery Module Switch Box



UPS0 Maintenance Bypass Switch Box



UPS0 Circuit Breaker Box



Mains Circuit Breaker Box



Mains Circuit Breaker Box - Floor Penetration



Mains and UPS Subfloor Distribution Boxes



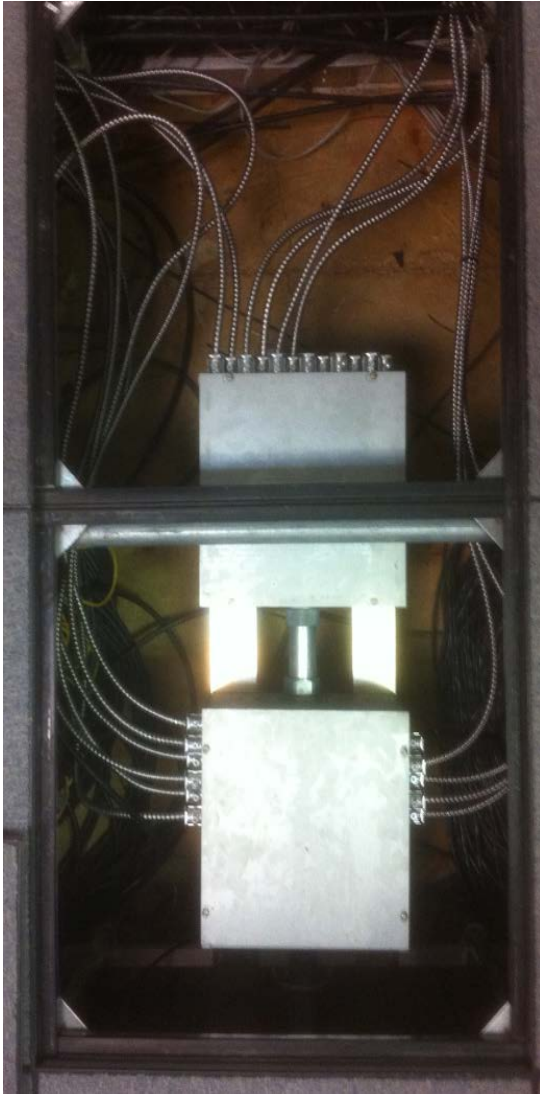

Old UPS Distribution Box



L1-MS1

CDS MSR Rack 1 Layout (Txxxxxxx)

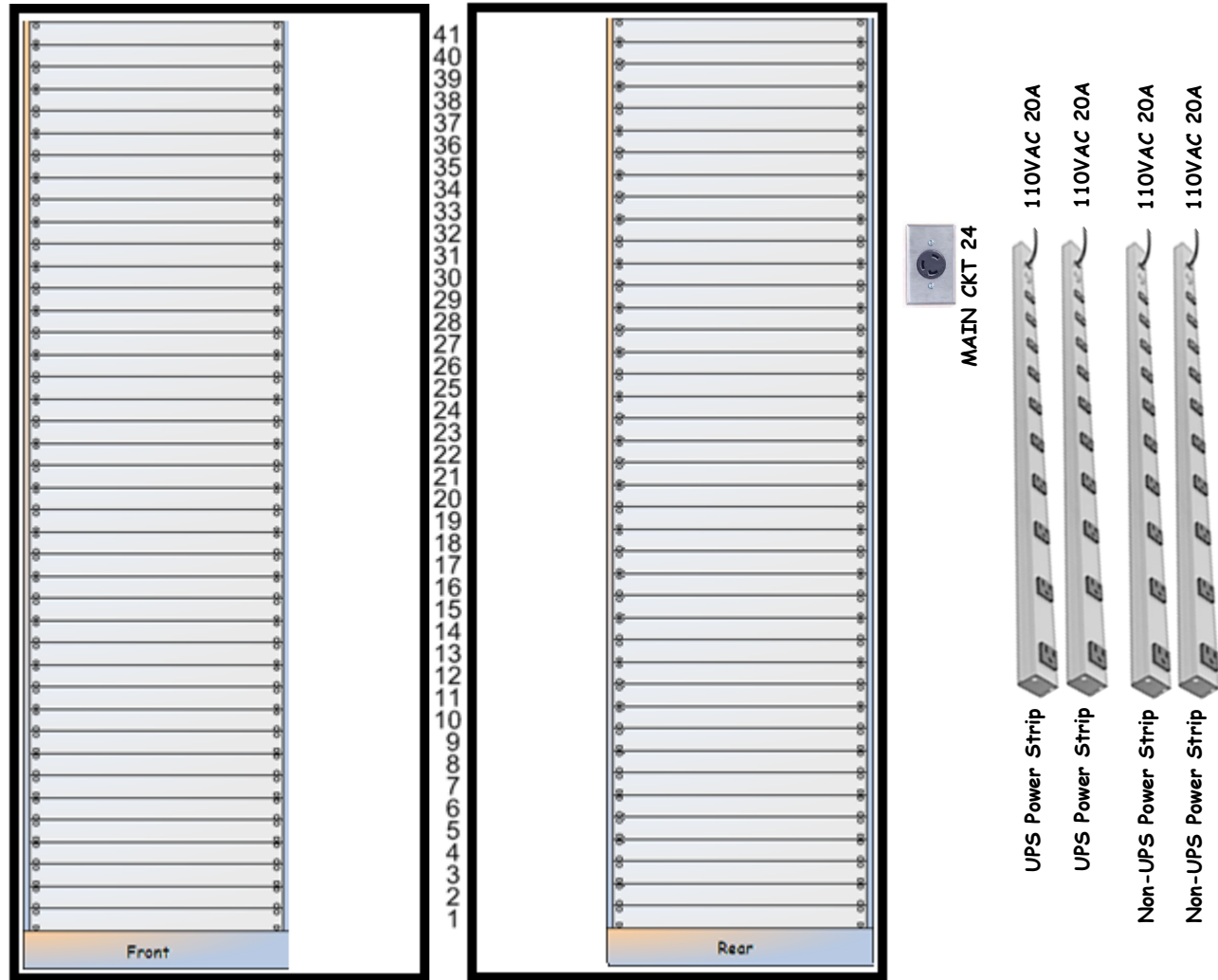

L1-MS2

CDS MSR Rack 2 Layout (Txxxxxxx)

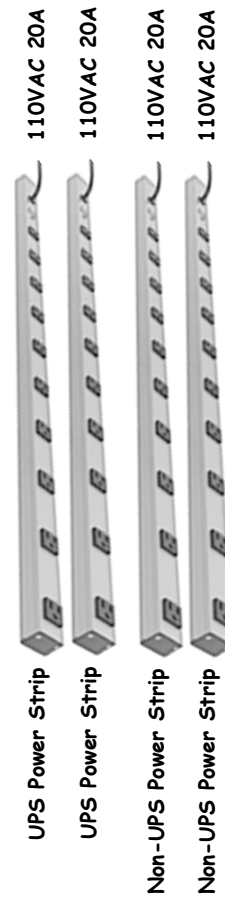

L1-MS3

CDS MSR Rack 3 Layout (Txxxxxxx)

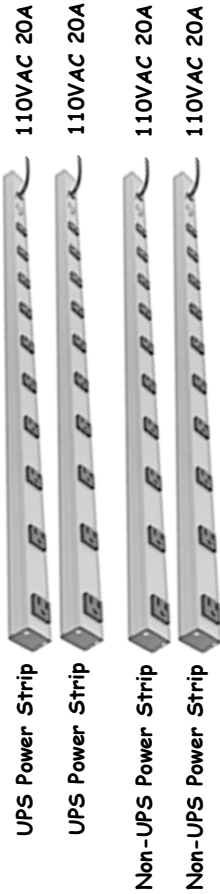
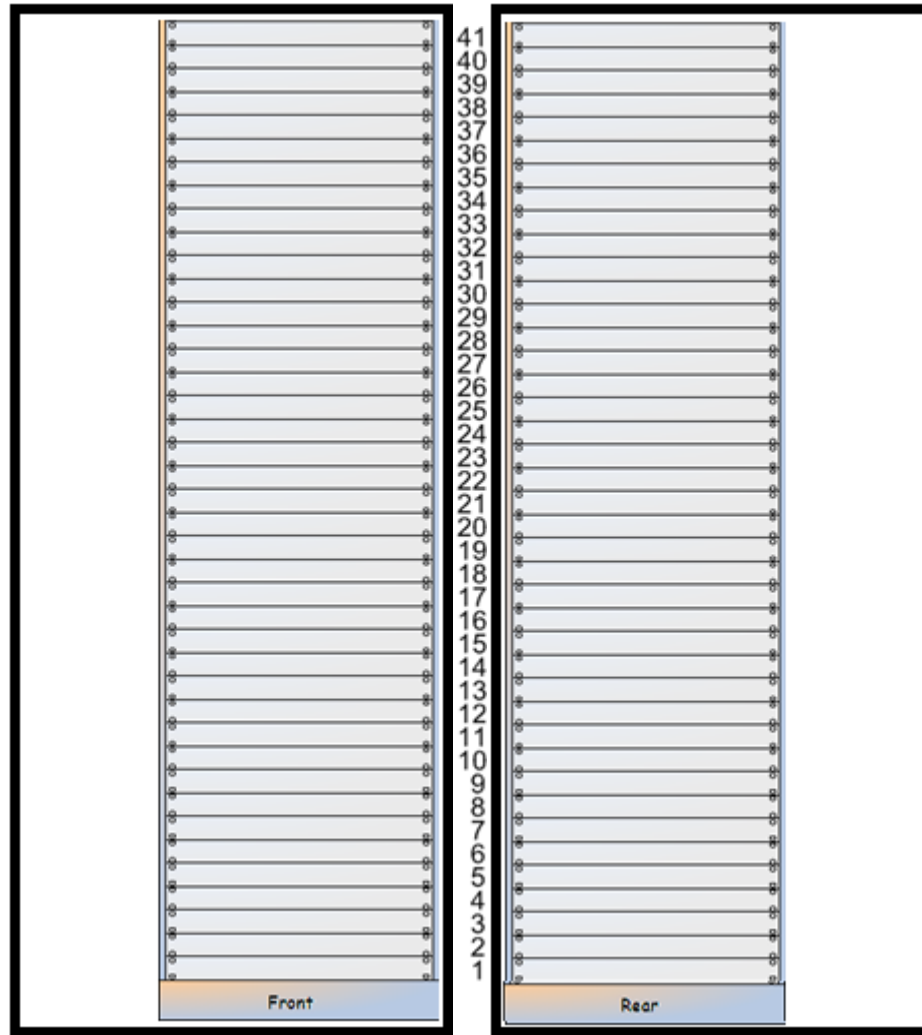

L1-MS4

CDS MSR Rack 4 Layout (Txxxxxxx)

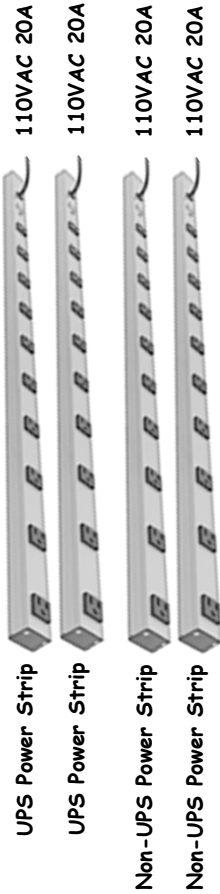
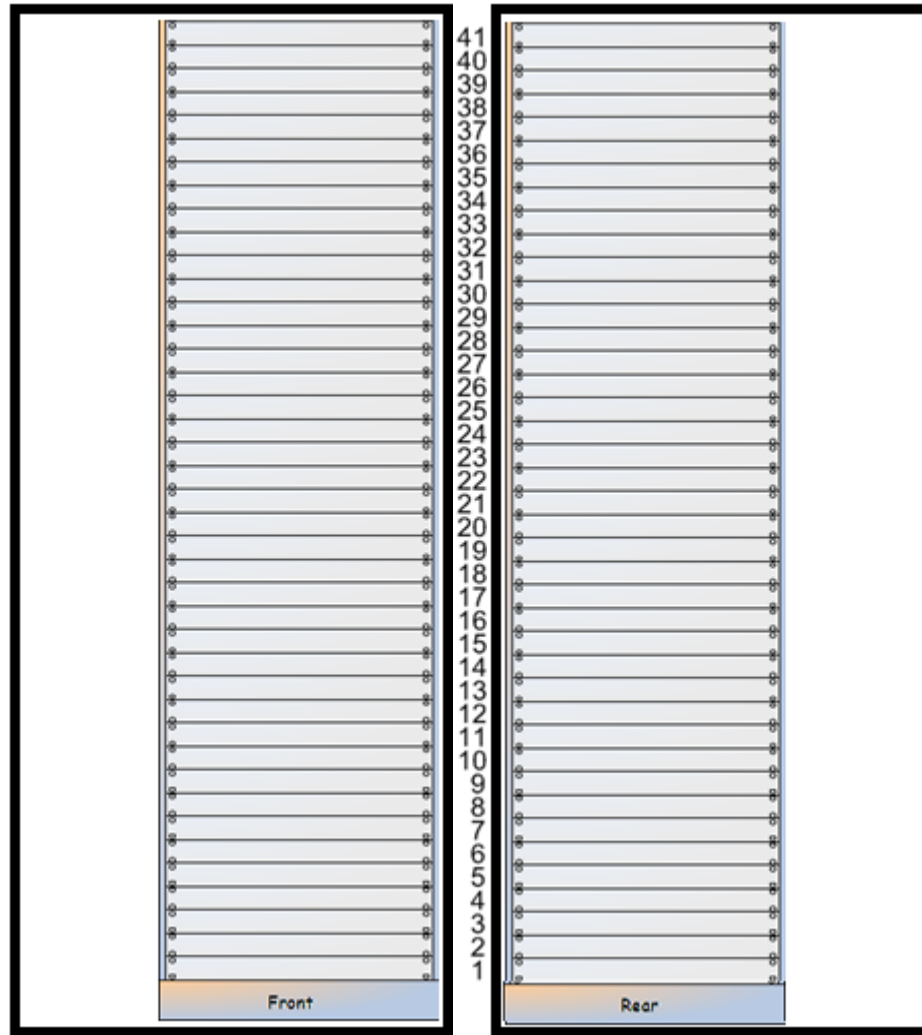

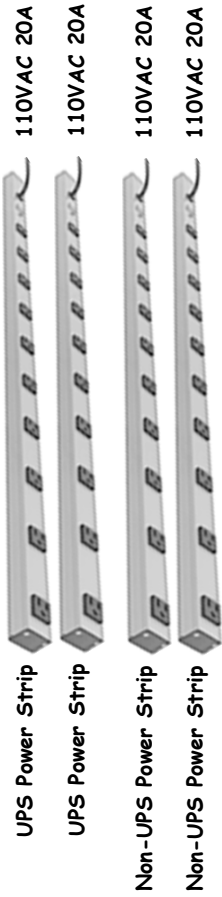

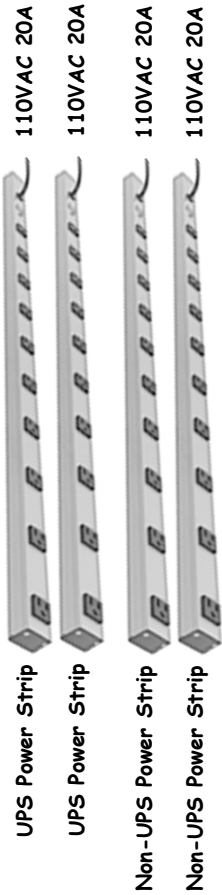

CDS MSR Rack 7 Layout (Txxxxxxx)

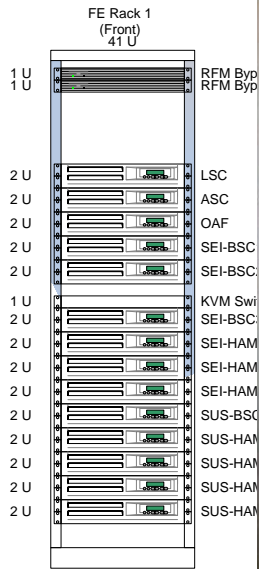

Switch 1
Switch 2

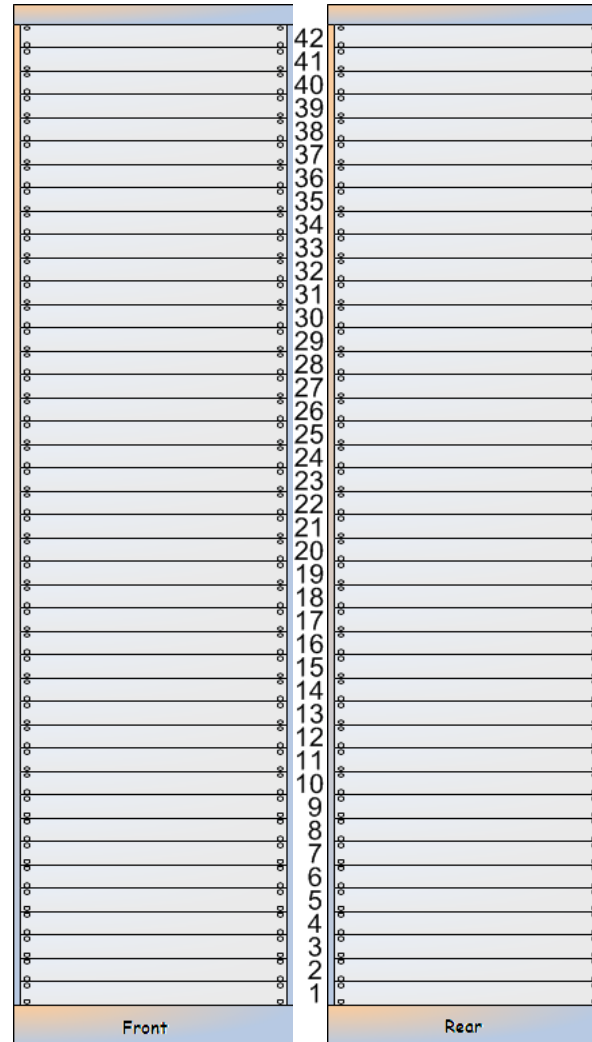

CDS MSR Rack 8 Layout (Txxxxxxx)

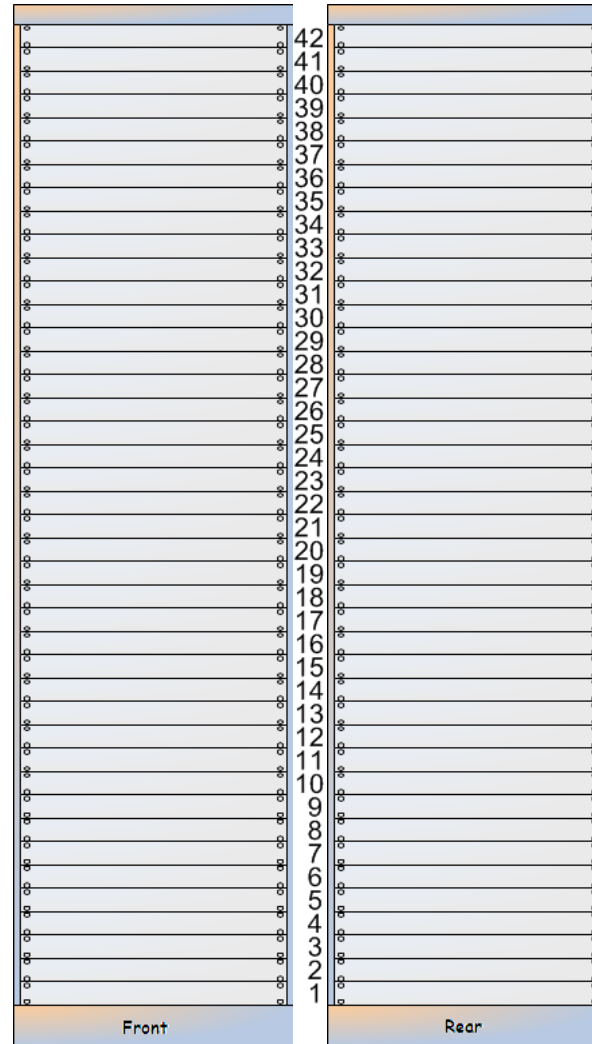
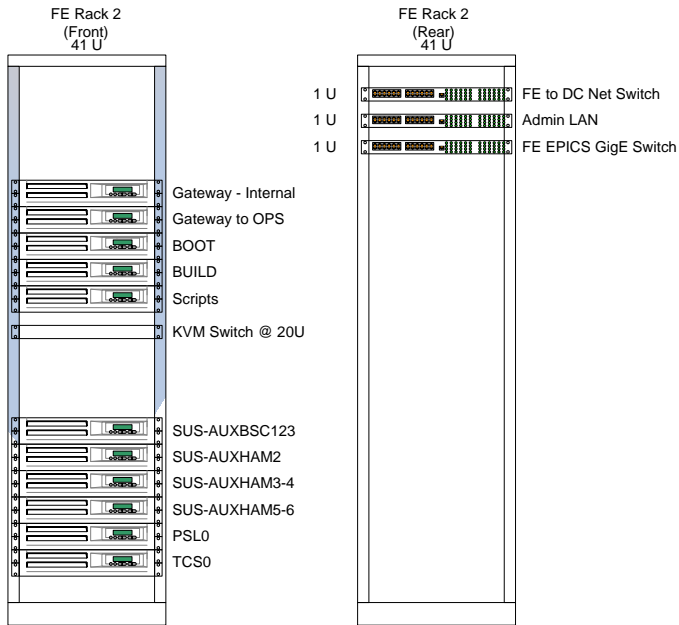

CDS MSR Rack 9 Layout (T1000588)

Timing IRIG-B Chassis
MasterClock GPS Seconds Display
Power 10 DC Power Supply

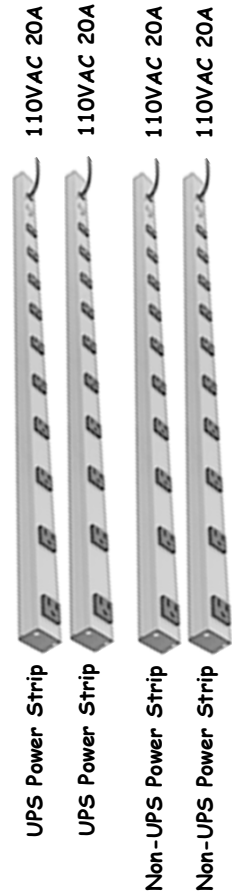
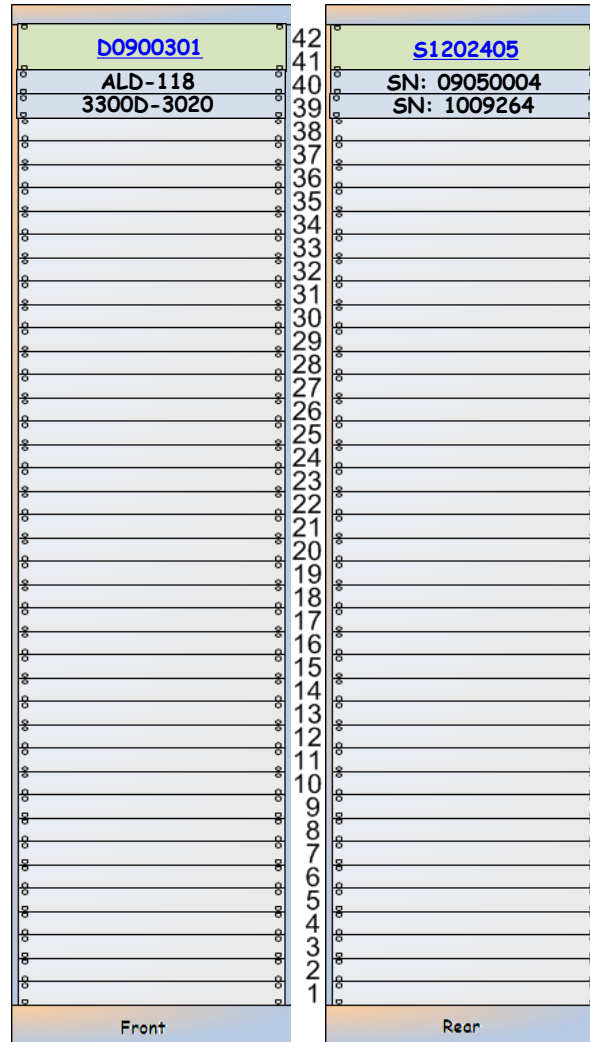
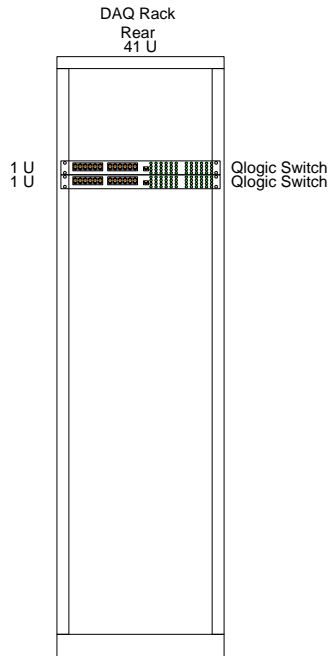
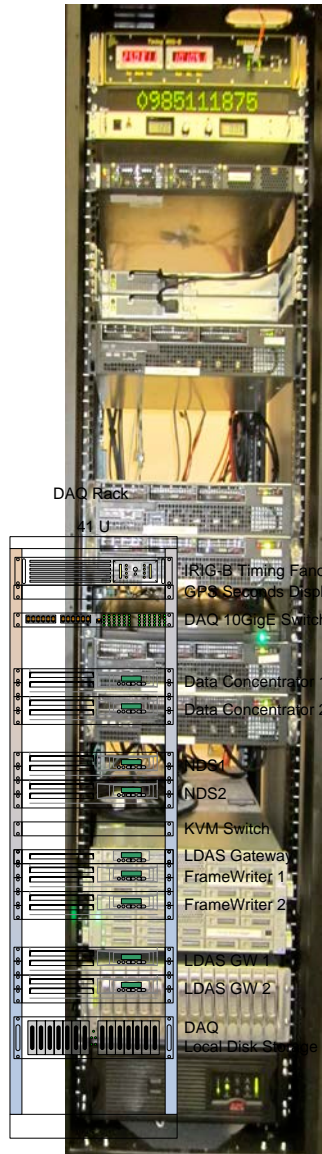

<< L1-MS9

Timing IRIG-B Interface Chassis

D0900301

S1202405

+12VDC

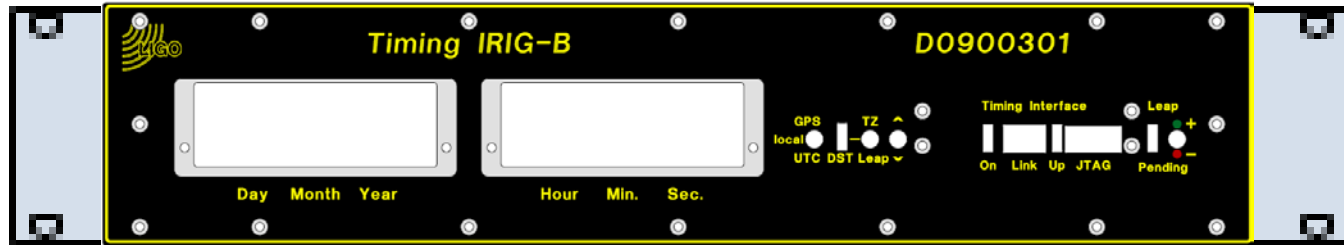

D0900301

Front

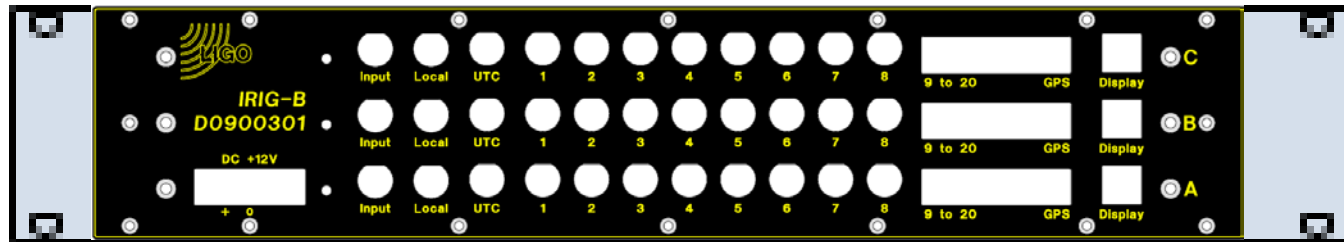

S1202405

Rear

MasterClock GPS Seconds Display UPS

[D0900301](#)

Front

[S1202405](#)

Rear

Power 10 DC Power Supply

The LIGO logo consists of the word "LIGO" in a bold, black, sans-serif font. To the left of the text is a stylized graphic of concentric, overlapping circles, resembling a ripple effect or a signal waveform.

[<< L1-MS9](#)

Power 10 DC Power Supply UPS

[D0900301](#)

Front

[S1202405](#)

Rear

L1-MS10

CDS MSR Rack 10 Layout (Txxxxxxx)

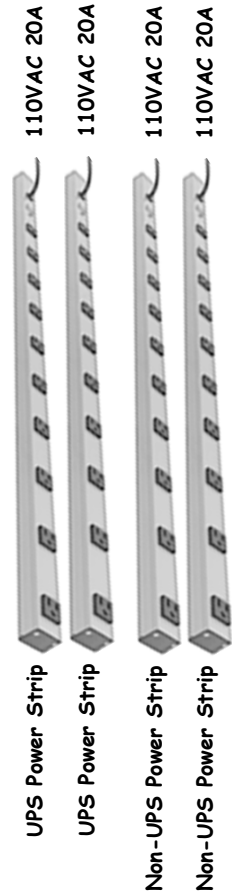

L1-MS11

CDS MSR Rack 11 Layout (Txxxxxxx)

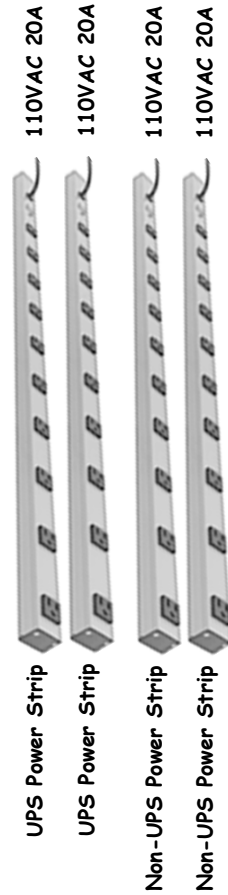
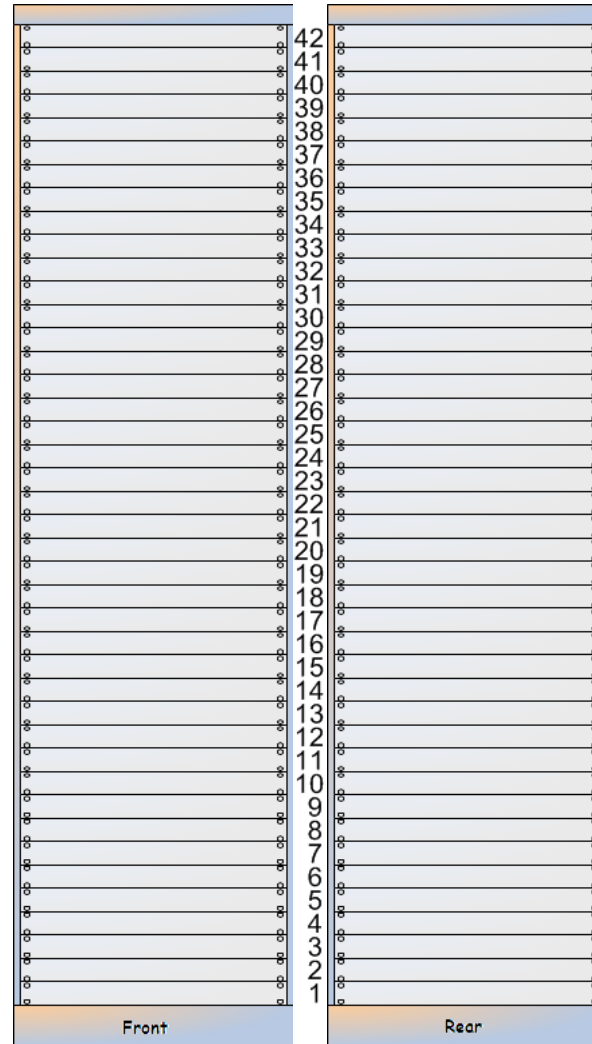

L1-MS12

CDS MSR Rack 12 Layout (Txxxxxxx)

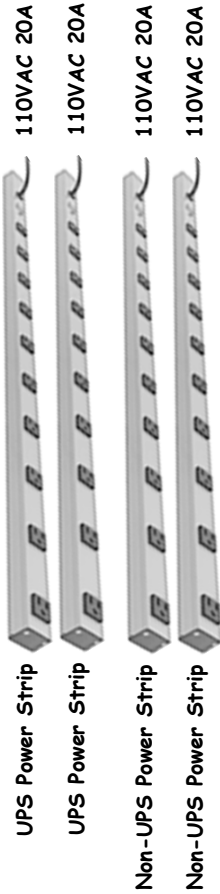
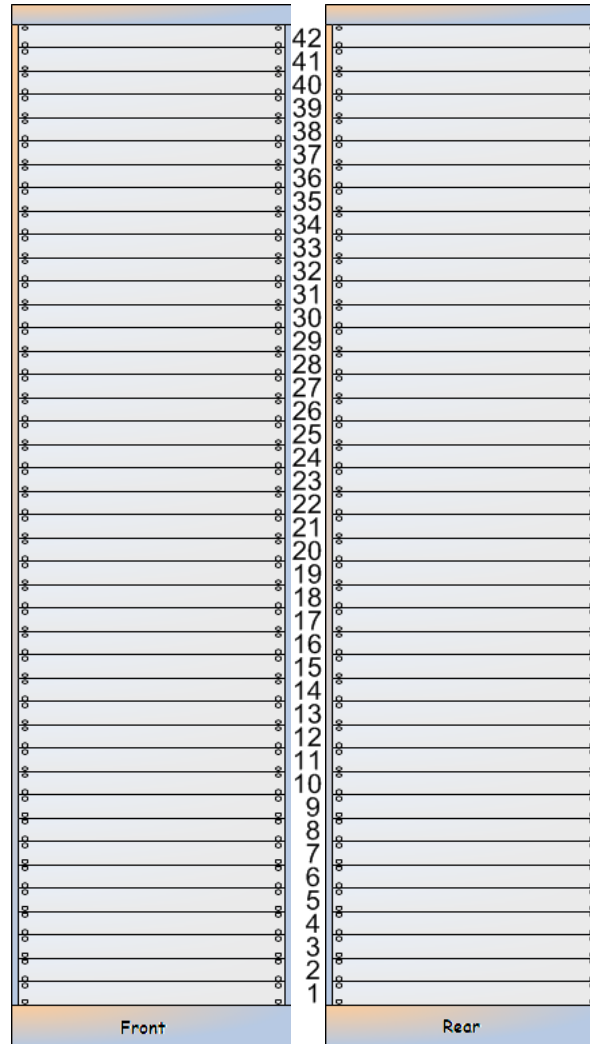

L1-MS13

CDS MSR Rack 13 Layout (Txxxxxxx)

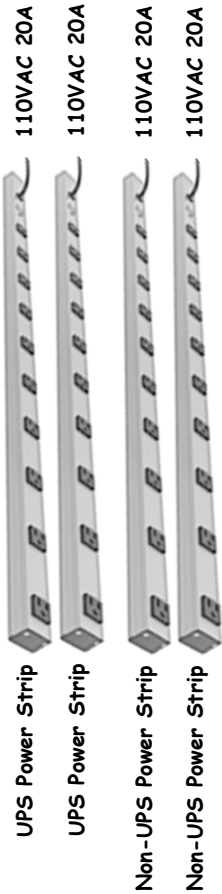

IO Extender Communications and Timing Fibers

l1psl0	S1001134	L1-PSL-C1	L1:FE-IO-19	L1:TIM-PSL-C1-A
l1oaf0	S1103894	L1-OAF-C1	L1:FE-IO-03	
l1tcs0	S1103894	L1-AOS-C1	L1:FE-IO-22	
l1seiham16	S1001144	L1-SEI-C1	L1:FE-IO-07	
l1seiham23	S1001145	L1-SEI-C2	L1:FE-IO-08	
l1seiham45	S1001146	L1-SEI-C3	L1:FE-IO-09	
l1seibsc1	S1001147	L1-SEI-C4	L1:FE-IO-04	
l1seibsc2	S1001148	L1-SEI-C5	L1:FE-IO-20	
l1seibsc3	S1100946	L1-SEI-C6	L1:FE-IO-23	
l1asc0	S1106300	L1-ISC-C1	L1:FE-IO-02	
l1lsc0	S1106342	L1-ISC-C1	L1:FE-IO-01	
l1susauxham34	S1001141	L1-SUS-C2	L1:FE-IO-17	
l1susham34	S1001140	L1-SUS-C2	L1:FE-IO-13	
l1susauxham2	S1103891	L1-SUS-C3	L1:FE-IO-16	
l1susham2a	S1001133	L1-SUS-C3	L1:FE-IO-11	
l1susham2b	S1001139	L1-SUS-C3	L1:FE-IO-12	
l1susbsc123	S1001143	L1-SUS-C5	L1:FE-IO-10	
l1susauxbsc123	S1103888	L1-SUS-C5	L1:FE-IO-21	
l1susauxham56	S1103889	L1-SUS-C8	L1:FE-IO-18	
l1susham56	S1001142	L1-SUS-C8	L1:FE-IO-14	
l1iscex	S1000536	L1-ISC-XC1	L1:FE-IO-33	L1:ISCEX
l1seiex	S1201774	L1-SEI-XC1	L1:FE-IO-30	L1:SEIEX
l1susauxex	S1201779	L1-SUS-XC2	L1:FE-IO-32	L1:SUSAUXEX
l1susex	S1103367	L1-SUS-XC2	L1:FE-IO-31	L1:SUSEX
l1pemey	S1000528	L1-ISC-YC1		
l1seiye	S1200166	L1-SEI-YC1		
l1susauxey	S1201775	L1-SUS-YC2		
l1susey	S1201776	L1-SUS-YC2		

Binary IO Card - DIO6464L-PE

DIO6464L-PE

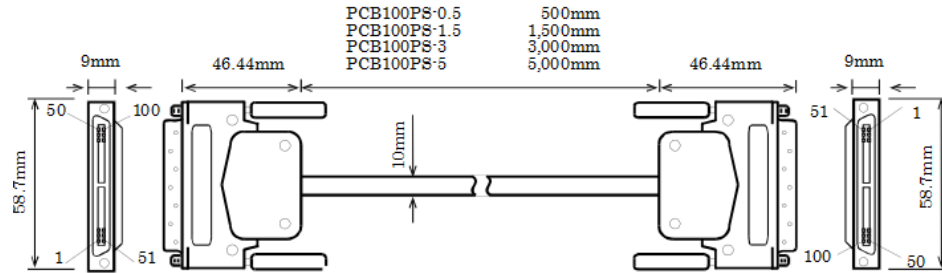

37-pin D-SUB × for 100-pin
0.8mm pitch connector shielded
cable distribution 2 (3m)

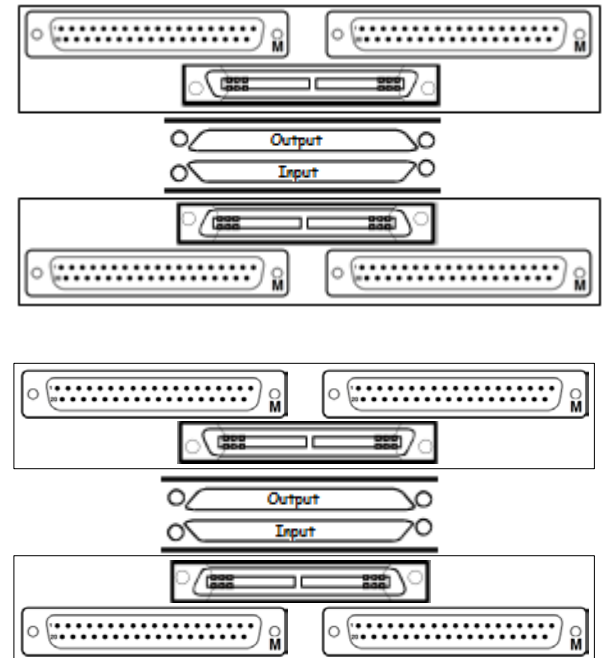
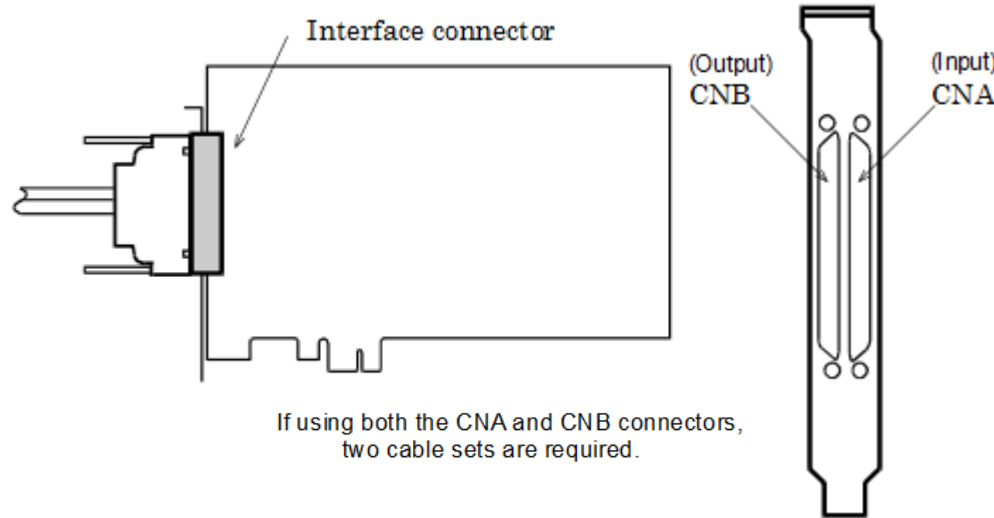

[<< LLO Corner Station](#)

[<< LLO Racks by AREA](#)

[<< LLO CDS Components](#)

CER

[Rack Layout >>](#)

LLO CER - Rack Layout

- << LLO Corner Station
- << LLO Racks by Area
- << LLO CDS Components

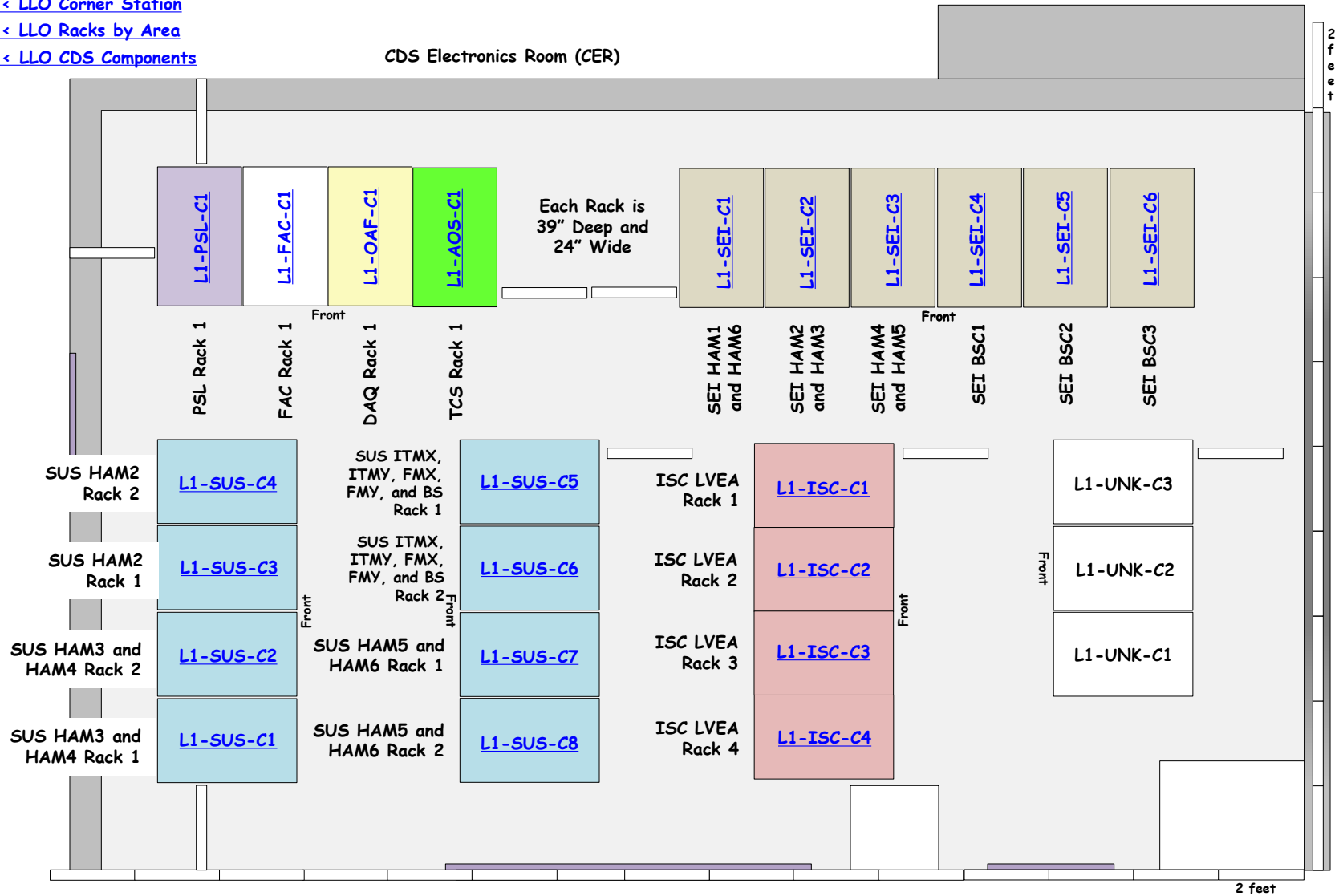

LLO CER, LDR, and CPR Cable Tray Layout

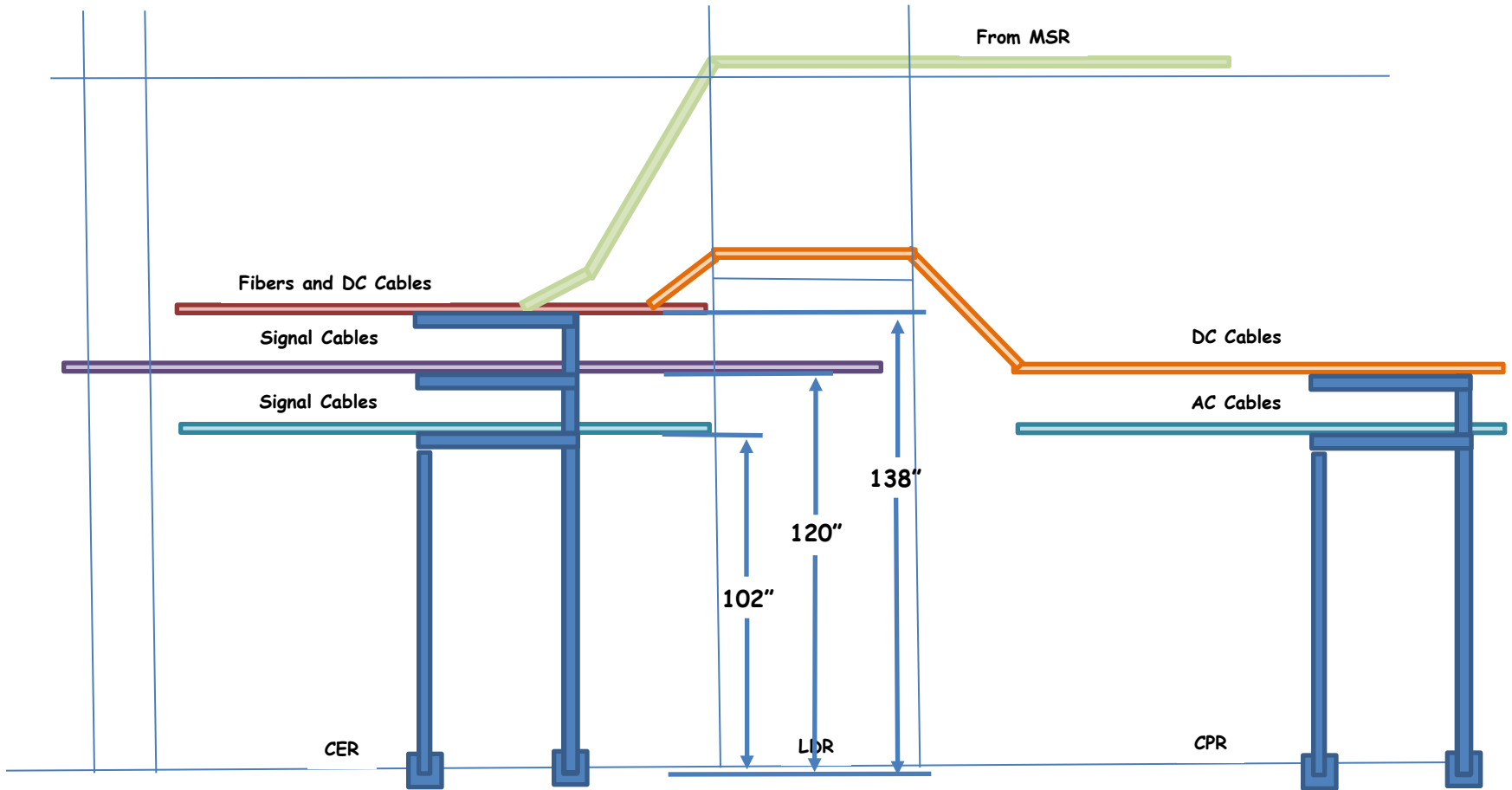

LLO CER - 8.5ft Cable Tray Layout

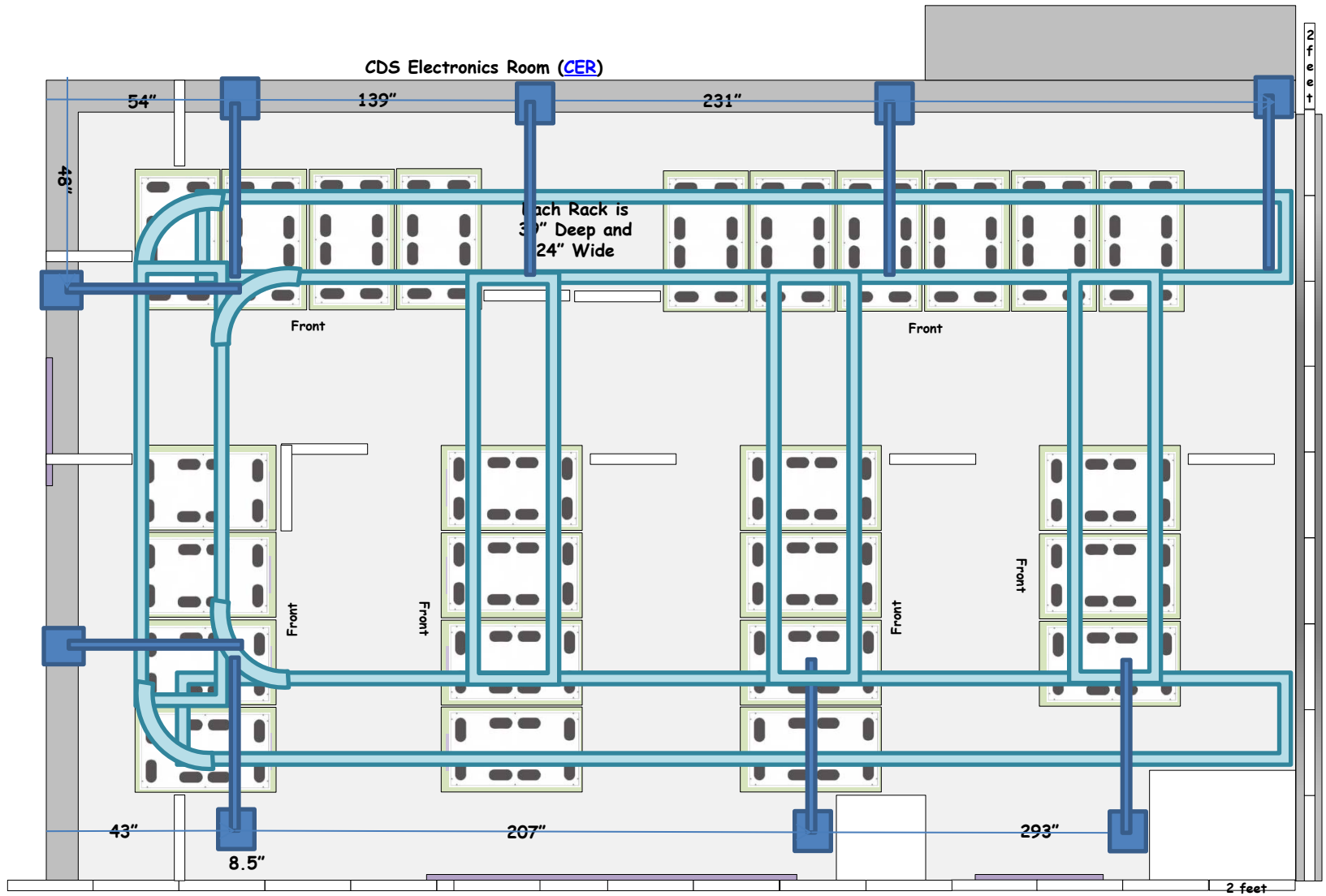

All posts are E-Posts

LIGO CER - 10ft Cable Tray Layout

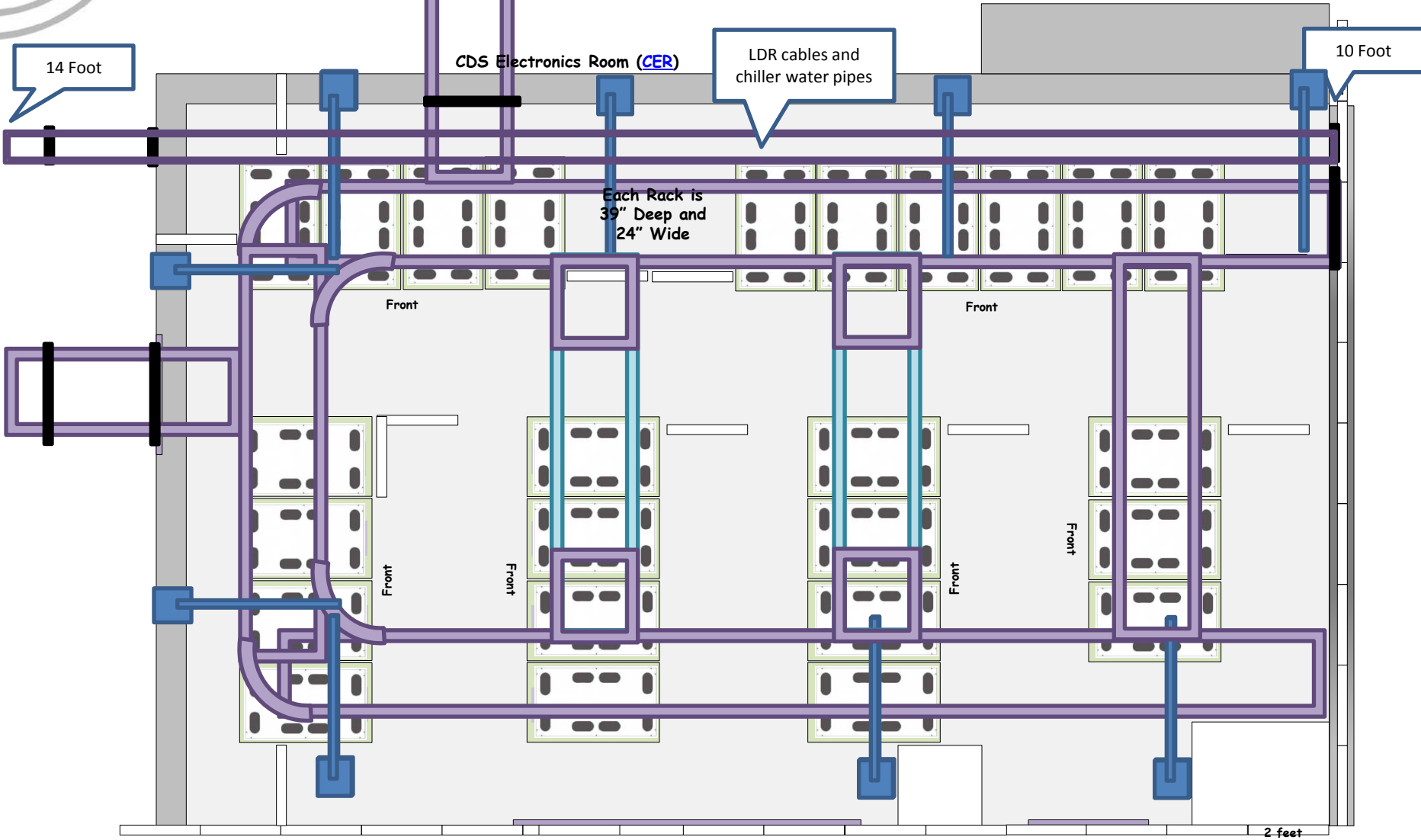

All posts are E-Posts

LLO CER - 11.5ft Cable Tray Layout

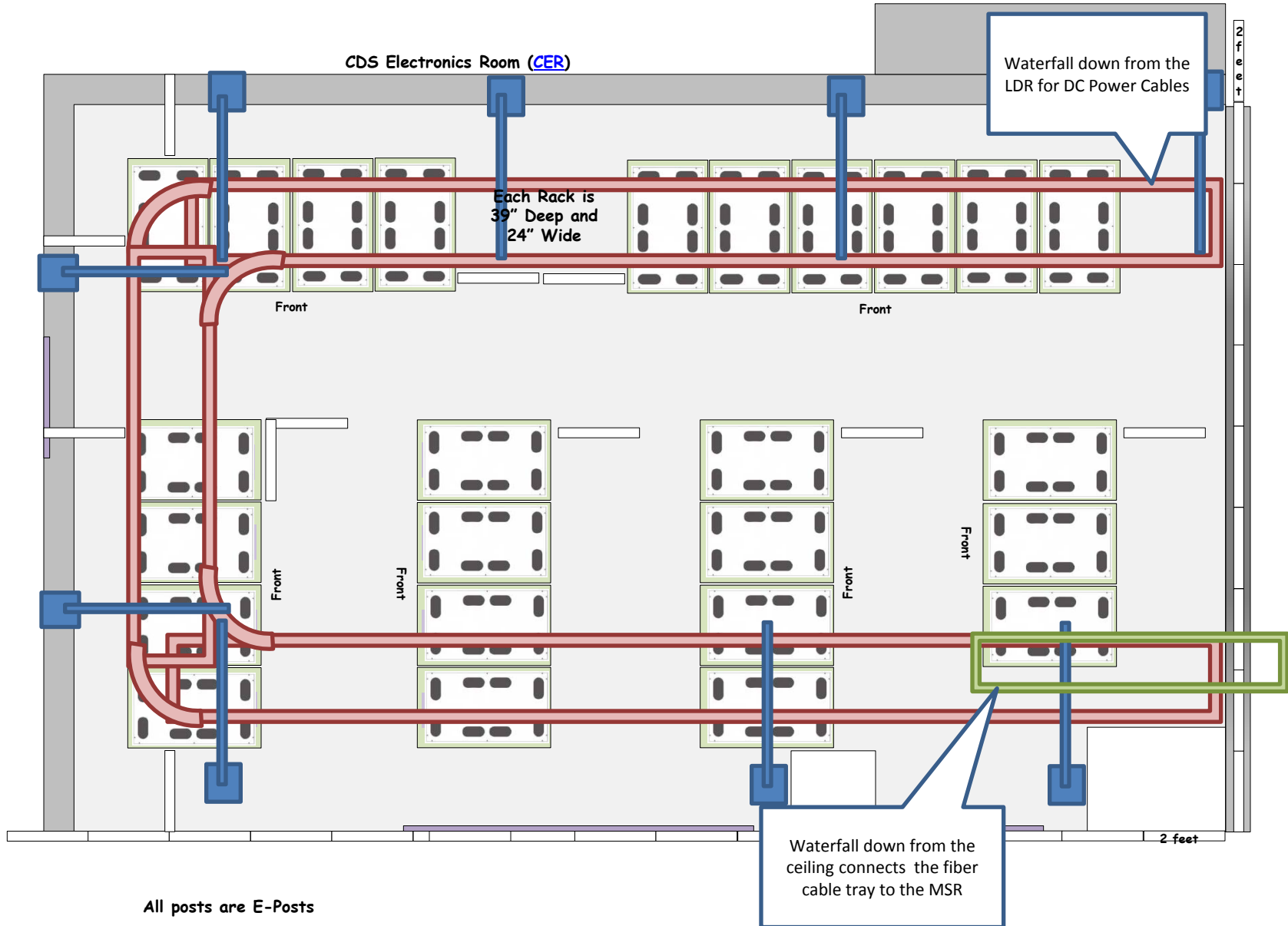

LLO CER - Rack Layout

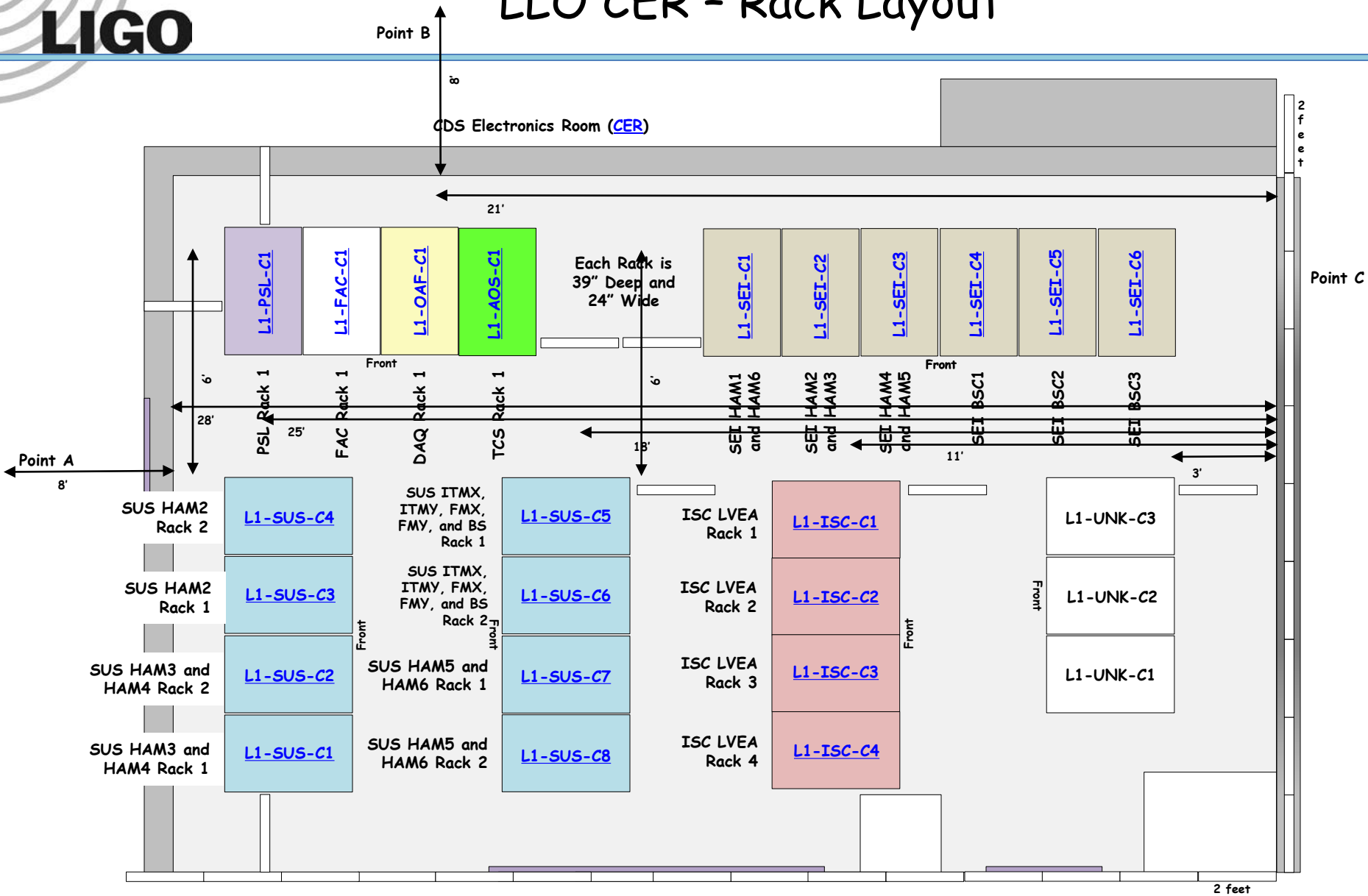

[<< LLO Corner Station](#)

[<< LLO Racks by AREA](#)

[<< LLO CDS Components](#)

LDR

- << [LLO Corner Station](#)
- << [LLO Racks by AREA](#)
- << [LLO CDS Components](#)

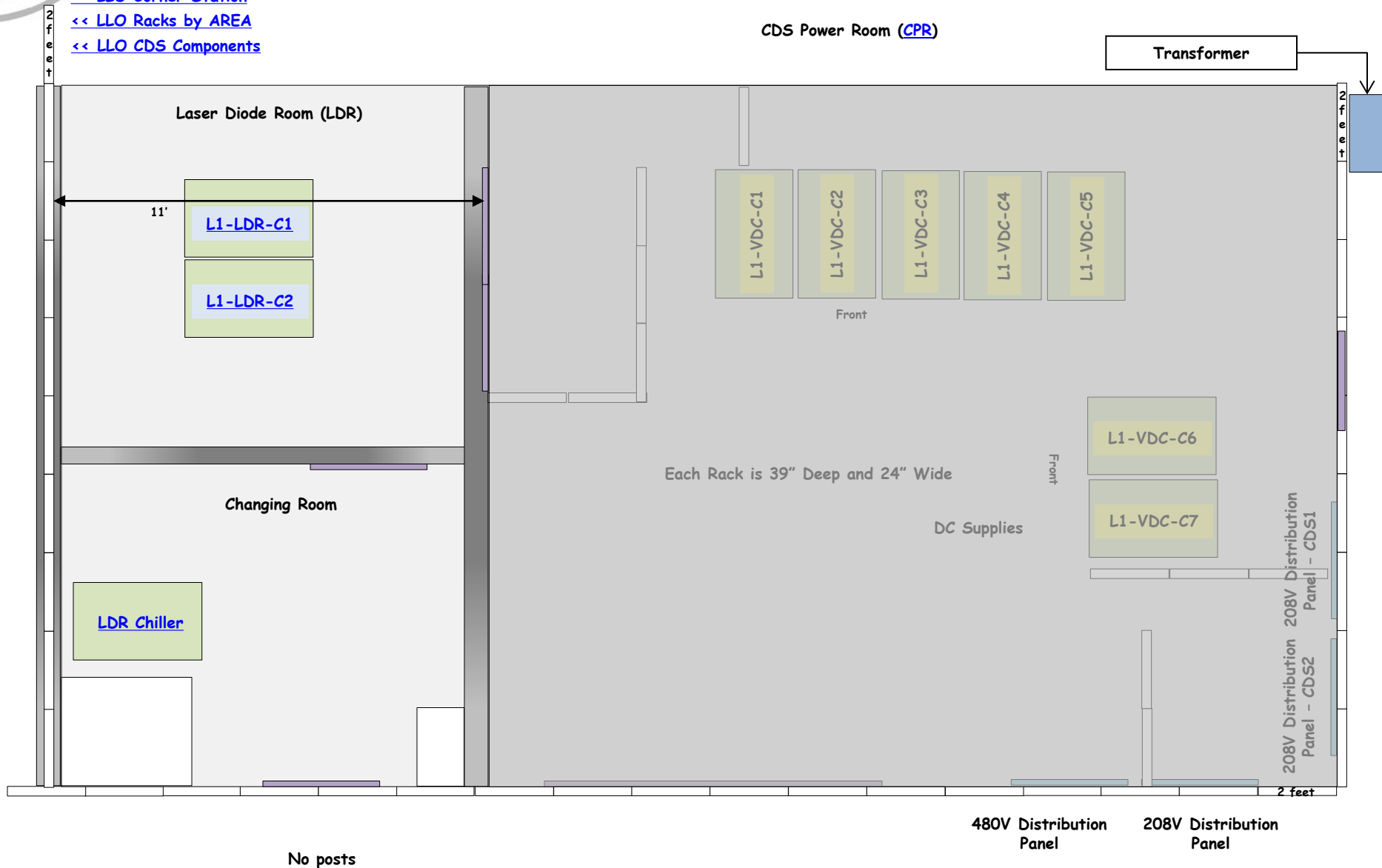

LLO LDR - 10ft Cable Tray Layout

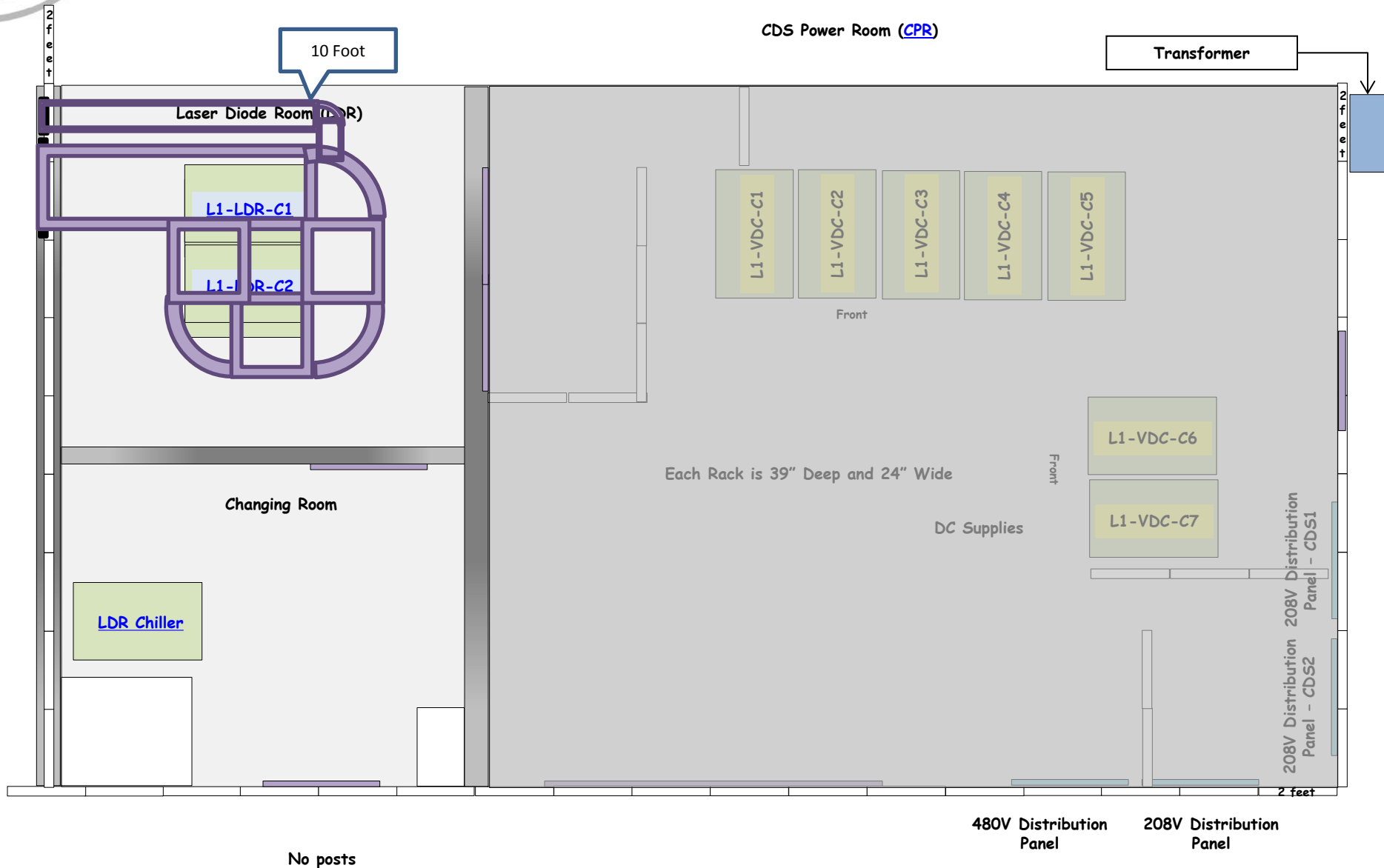

[<< LLO Corner Station](#)

[<< LLO Racks by AREA](#)

[<< LLO CDS Components](#)

CPR

LLO CPR - Rack Layout

- << [LLO Corner Station](#)
- << [LLO Racks by AREA](#)
- << [LLO CDS Components](#)

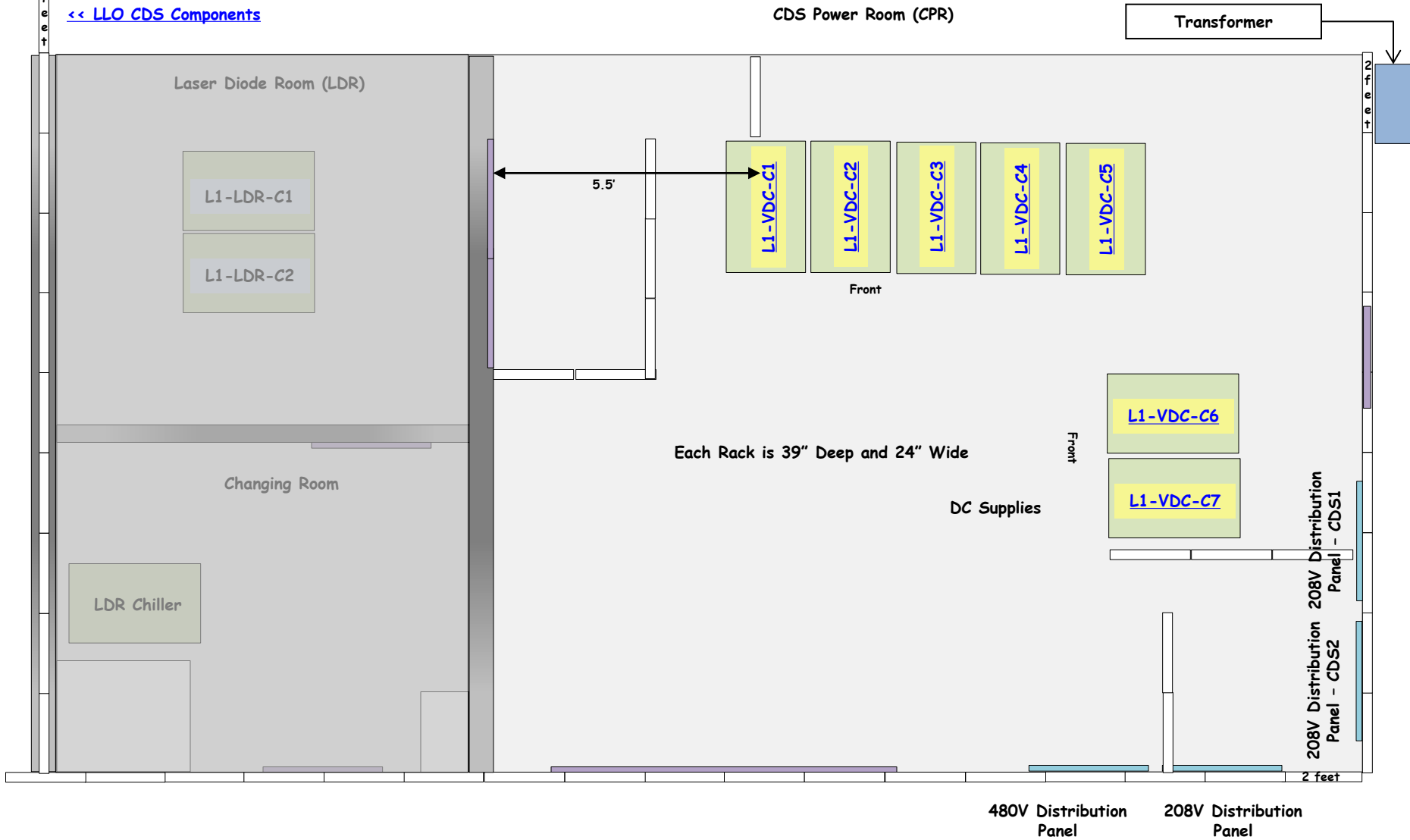

LLO CPR - 8.5ft (AC) Cable Tray Layout

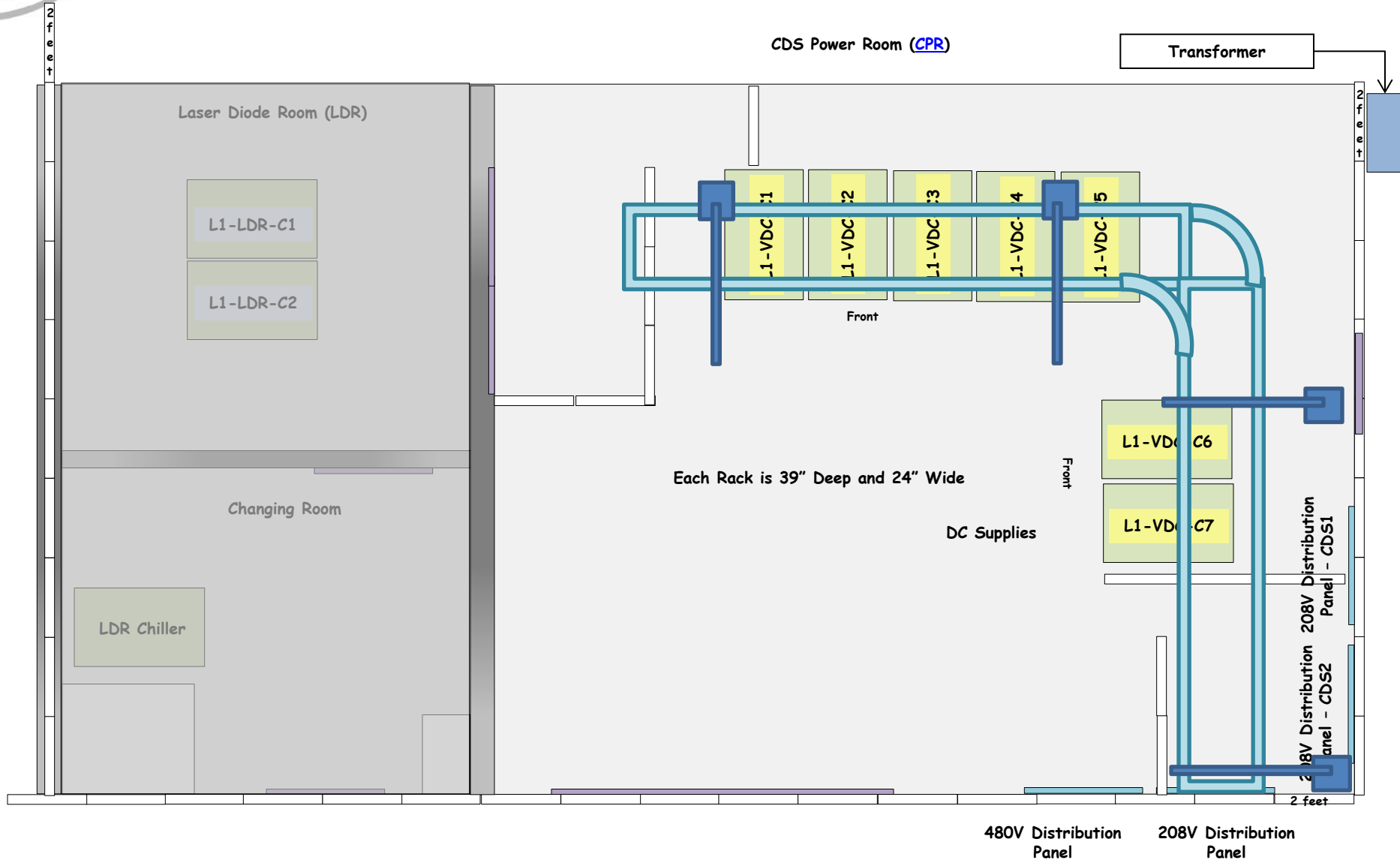

All posts are F-Posts

LLO CPR - 10ft (DC) Cable Tray

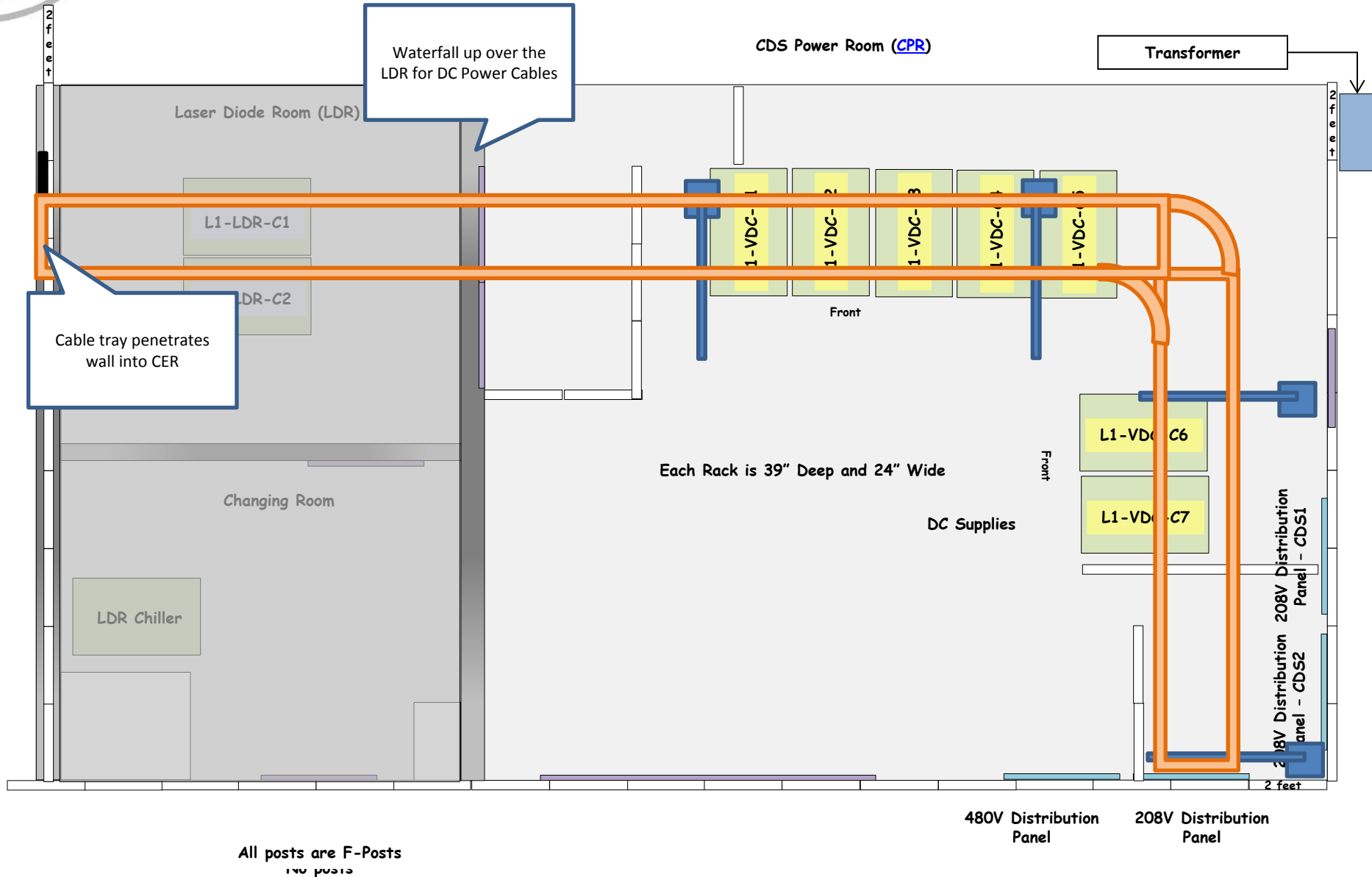

[<< LLO Corner Station](#)
[<< LLO Racks by AREA](#)
[<< LLO CDS Components](#)
[<< LLO Racks by Subsystem](#)

VDC

[DC Power Supplies >>](#)

[CPR Rack Layout >>](#)

[CERX DC Rack Layout >>](#)

[CERY DC Rack Layout >>](#)

[KEPCO BHK500-80MG](#)

[KEPCO JQE25-20MVPY27274](#)

[KEPCO JQE36-30M](#)

Picture: Front Panel

Picture: Rear Panel

Specifications

Inventory of Serial Numbers / Dates received / scheduled maintenance / assigned use / etc.

Acceptance Testing: LIGO-Txxxxxxx

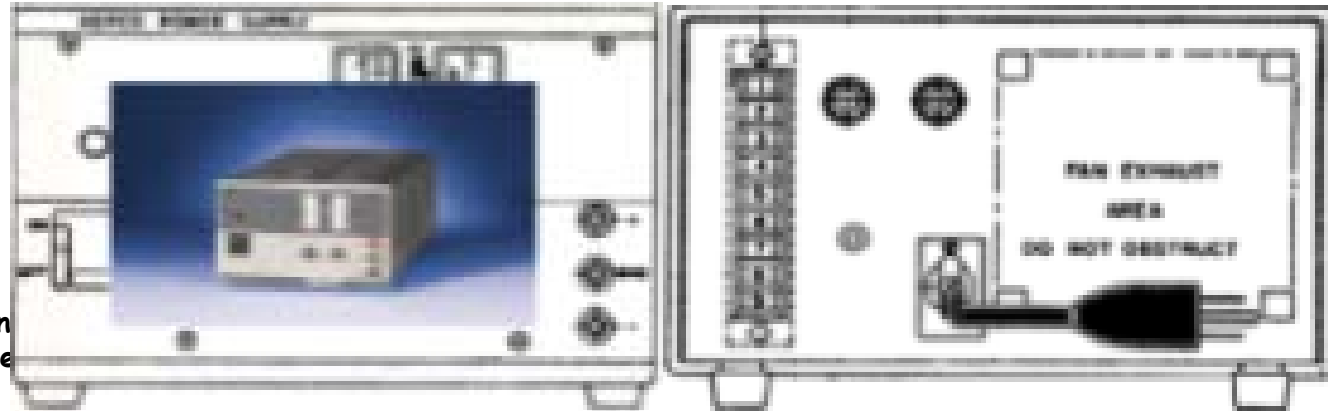

Picture: Front Panel

Picture: Rear Panel

Specifications

Inventory of Serial Numbers / Dates received / scheduled maintenance / assigned use / etc.

Acceptance Testing: [LIGO-T1100478](#)

Picture: Front Panel

Picture: Rear Panel

Specifications

**Inventory of Serial Numbers / Dates received / scheduled
maintenance / assigned use / etc.**

Acceptance Testing: LIGO-Txxxxxxx

DC Power Rack - Required VDC

<< CPR

5 Standard Banks
per Rack

10 x 4U => 40U

DC Power Rack

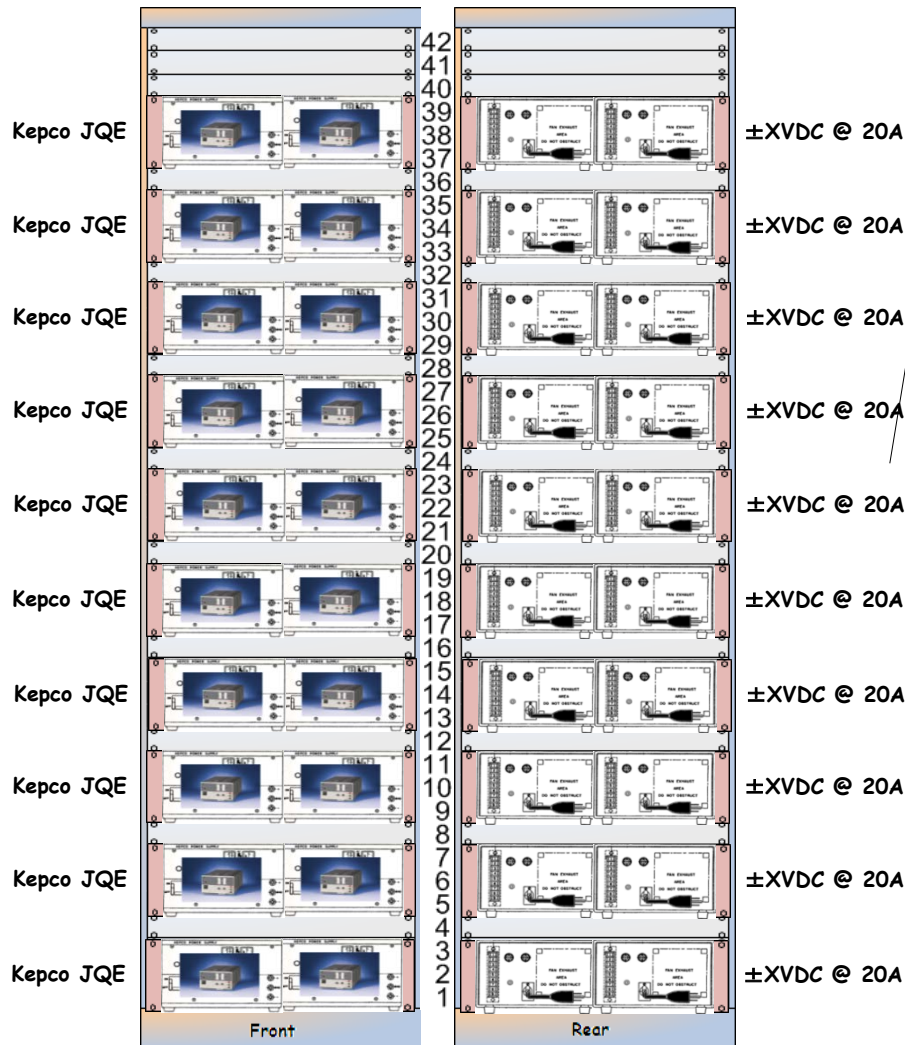

A Standard Bank (SB) of power supplies consists of 4 supplies, and services 1 Electronics Rack.

The 4 supplies are:
+18V@20A, -18V@20A,
+24V@20A, and -24V@20A.

Each Standard Bank of DC Power Supplies provides

18V * 20A => 360W
360W * 2 PS => 720W
24V * 20A => 480W
480W * 2 PS => 960W
720W + 960W => 1680W

There are 5 SB (20 PS) / Power Rack. Each Power Rack therefore provides 8400W

Each Power Rack services 5 Electronics Racks.

There are roughly 22 racks per interferometer.

Therefore 5 DC Power Racks are required and will **provide** for a total of 42,000 W.

DC Power Rack - Required VAC

<< CPR

5 Standard Banks
per Rack

10 x 4U => 40U

DC Power Rack

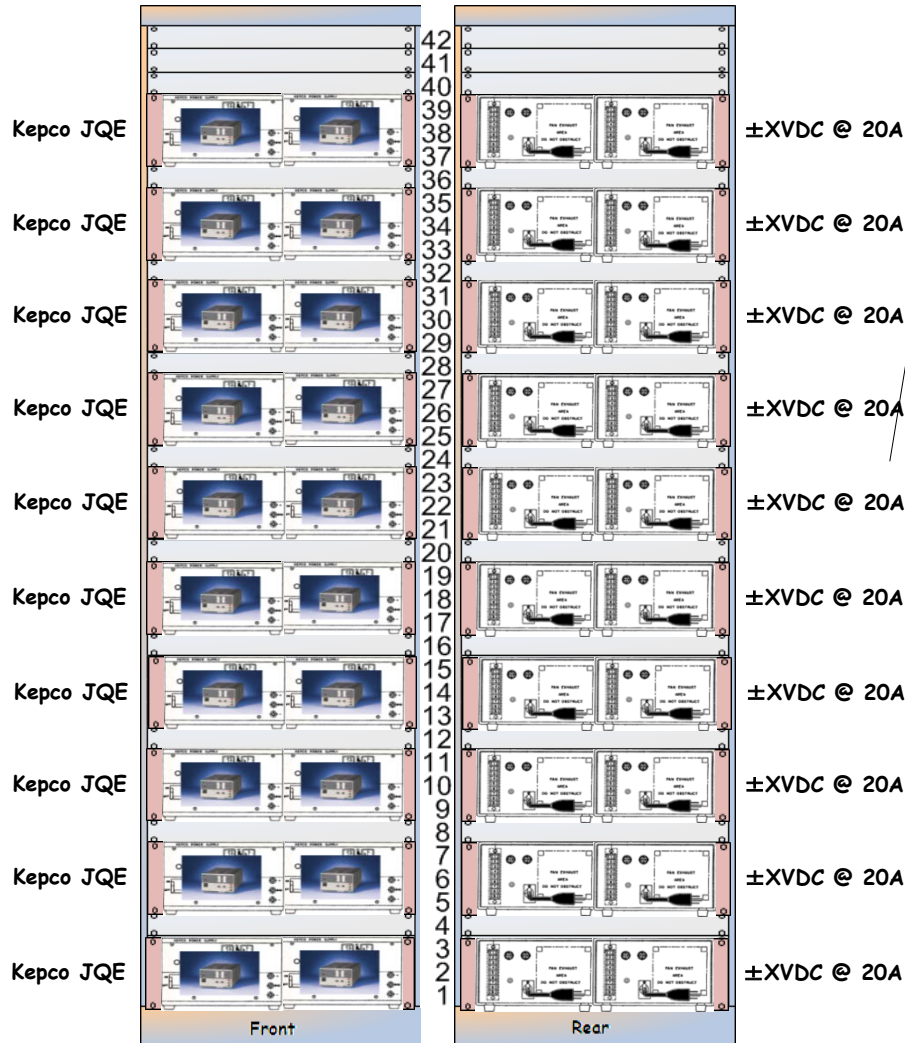

A Standard Bank (SB) of power supplies consists of 4 supplies, and services 1 Electronics Rack.

The 4 supplies are:
+18V@20A, -18V@20A,
+24V@20A, and -24V@20A.

Each (~JQE25-20M) DC Power Supply requires 10.5A @ 125VAC

Each Standard Bank of DC Power Supplies requires 42A @ 125VAC

There are 5 SB (20 PS) / Power Rack. Each Power Rack therefore requires 210A @ 125VAC.

10 - 125V@20A circuits per Power Rack should suffice.

Each Power Rack services 5 Electronics Racks.

There are roughly 22 racks per interferometer.

70 - 125V @20A circuits are required for a total of 183,750W.

Therefore 2 - 480VAC * 200A circuits would provide 192,000W

DC Power Rack

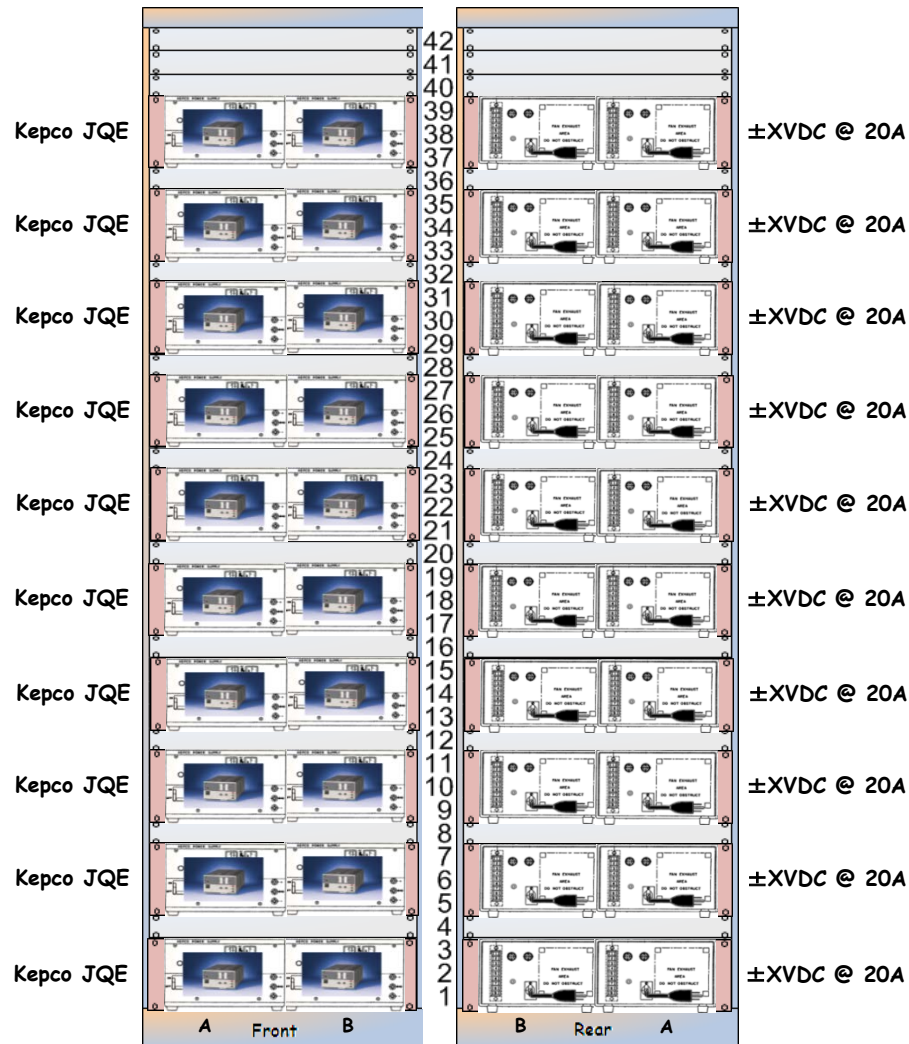

12 @ 125V, 20A Circuits per Rack

Outlet 1

Outlet 2

Outlet 3

Outlet 4

Outlet 5

Outlet 6

Outlet 7

Outlet 8

Outlet 9

Outlet 10

Outlet 11

Outlet 12



Rear

L1-VDC-C1 Power Racks - Required Supplies

<< CPR

L1-VDC-C1 Corner Station DC Power Rack Layout ([D1200890](#)) ([S1105247](#))

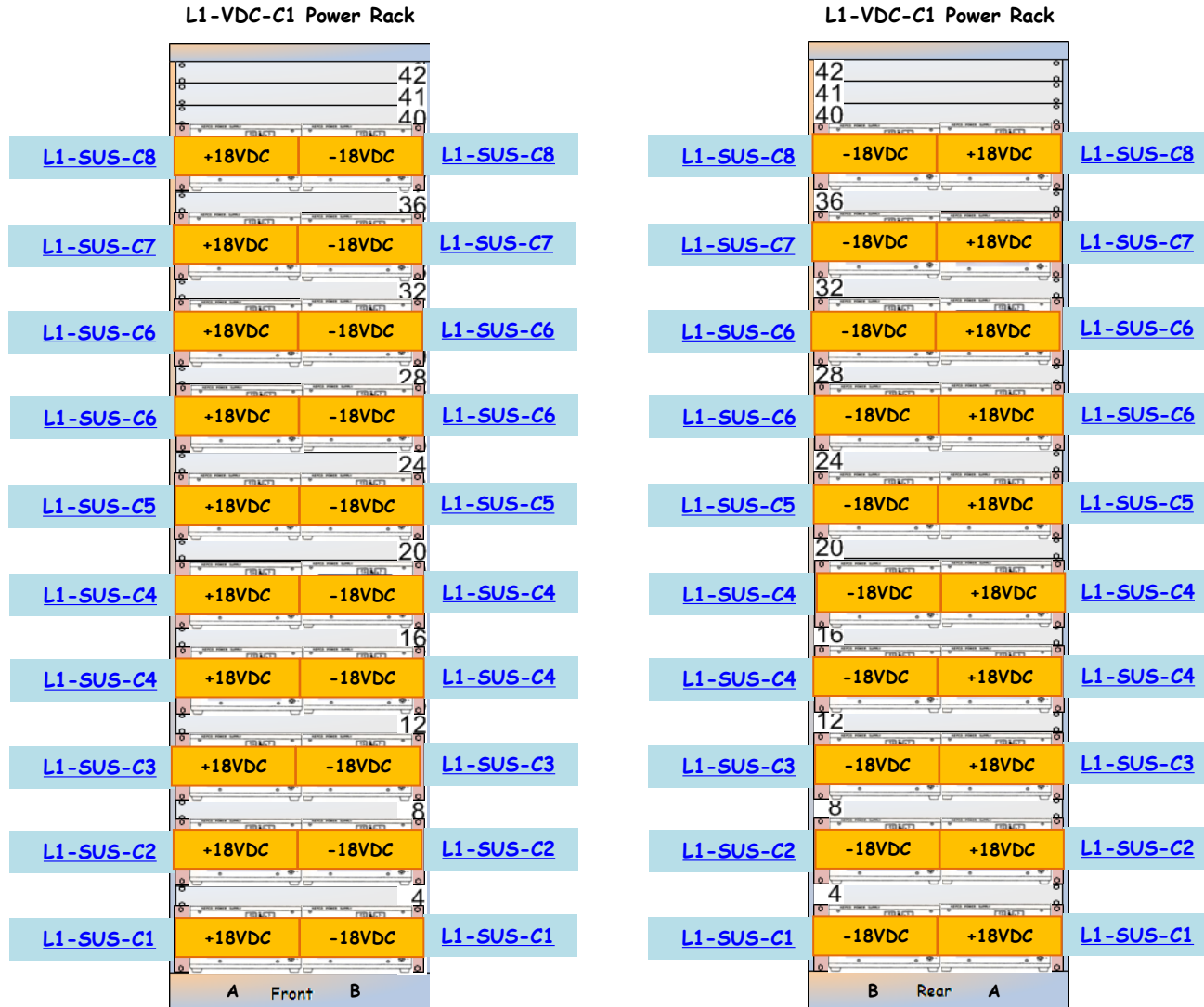

[Cable Runs >>](#)

L1-VDC-C1 Cable Runs

<< [L1-VDC-C1](#)

L1-VDC-C1 Corner Station DC Cable Runs ([D1200890](#)) ([S1105247](#))

L1-VDC-C1 S1105247	Power Panel	Circuit	DC Power Rack	Outlet	Plug Position	Rack U	Power Supply Model	Power Supply Serial	Polarity	DC Extension Cable	Electronics Rack	DC Power Strip
1	CDS-1	06	L1-VDC-C1	08	Top	U37-A (Left)	JQE 25V 20A	H236464	Plus	PTO-001	L1-SUS-C8	PSO-001
2	CDS-1	06	L1-VDC-C1	08	Bottom	U37-B (Right)	JQE 25V 20A	H236467	Minus	PTO-001	L1-SUS-C8	PSO-001
3	CDS-1	27	L1-VDC-C1	02	Top	U33-A (Left)	JQE 25V 20A	H236434	Plus	PTO-002	L1-SUS-C7	PSO-002
4	CDS-1	27	L1-VDC-C1	02	Bottom	U33-B (Right)	JQE 25V 20A	H236427	Minus	PTO-002	L1-SUS-C7	PSO-002
5	CDS-1	08	L1-VDC-C1	09	Top	U29-A (Left)	JQE 25V 20A	H236468	Plus	PTO-021	L1-SUS-C6A	PSO-003
6	CDS-1	08	L1-VDC-C1	09	Bottom	U29-B (Right)	JQE 25V 20A	H236372-R1	Minus	PTO-021	L1-SUS-C6A	PSO-003
7	CDS-1	29	L1-VDC-C1	03	Top	U25-A (Left)	JQE 25V 20A	H236447	Plus	PTO-003	L1-SUS-C6B	PSO-021
8	CDS-1	29	L1-VDC-C1	03	Bottom	U25-B (Right)	JQE 25V 20A	H236463	Minus	PTO-003	L1-SUS-C6B	PSO-021
9	CDS-1	10	L1-VDC-C1	10	Top	U21-A (Left)	JQE 25V 20A	H236388	Plus	PTO-004	L1-SUS-C5	PSO-004
10	CDS-1	10	L1-VDC-C1	10	Bottom	U21-B (Right)	JQE 25V 20A	H236406	Minus	PTO-004	L1-SUS-C5	PSO-004
11	CDS-1	31	L1-VDC-C1	04	Top	U17-A (Left)	JQE 25V 20A	H236396	Plus	PTO-005	L1-SUS-C4A	PSO-005
12	CDS-1	31	L1-VDC-C1	04	Bottom	U17-B (Right)	JQE 25V 20A	H236404	Minus	PTO-005	L1-SUS-C4A	PSO-005
13	CDS-1	12	L1-VDC-C1	11	Top	U13-A (Left)	JQE 25V 20A	H236418	Plus	PTO-022	L1-SUS-C4B	PSO-022
14	CDS-1	12	L1-VDC-C1	11	Bottom	U13-B (Right)	JQE 25V 20A	H236424	Minus	PTO-022	L1-SUS-C4B	PSO-022
15	CDS-1	33	L1-VDC-C1	05	Top	U09-A (Left)	JQE 25V 20A	H236469	Plus	PTO-006	L1-SUS-C3	PSO-006
16	CDS-1	33	L1-VDC-C1	05	Bottom	U09-B (Right)	JQE 25V 20A	H236443	Minus	PTO-006	L1-SUS-C3	PSO-006
17	CDS-1	14	L1-VDC-C1	12	Top	U05-A (Left)	JQE 25V 20A	H210616	Plus	PTO-007	L1-SUS-C2	PSO-007
18	CDS-1	14	L1-VDC-C1	12	Bottom	U05-B (Right)	JQE 25V 20A	H210622	Minus	PTO-007	L1-SUS-C2	PSO-007
19	CDS-1	02	L1-VDC-C1	06	Top	U01-A (Left)	JQE 25V 20A	H210617	Plus	PTO-008	L1-SUS-C1	PSO-008
20	CDS-1	02	L1-VDC-C1	06	Bottom	U01-B (Right)	JQE 25V 20A	H210619	Minus	PTO-008	L1-SUS-C1	PSO-008
D1200890												

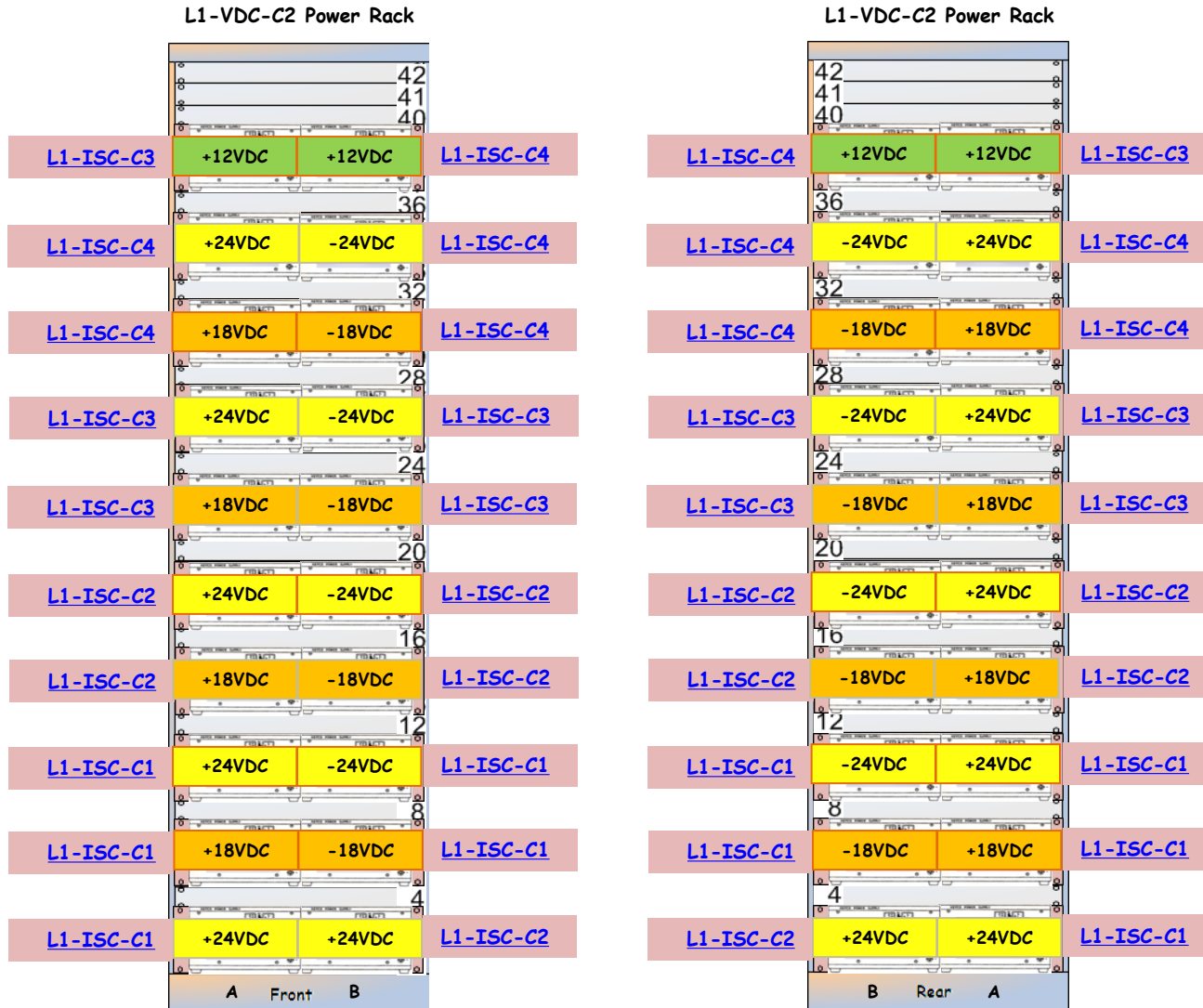

L1-VDC-C2 Cable Runs

<< [L1-VDC-C2](#)

L1-VDC-C2 Corner Station DC Cable Runs ([D1200891](#)) ([S1105248](#))

L1-VDC-C2 S1105248	Power Panel	Circuit	DC Power Rack	Outlet	Plug Position	Rack U	Power Supply Model	Power Supply Serial	Polarity	DC Extension Cable	Electronics Rack
1	CDS-1	15	L1-VDC-C2	08	Top	U37-A (Left)	JQE 15V 6A		Plus	PTG-002	L1-ISC-C3
2	CDS-1	15	L1-VDC-C2	08	Bottom	U37-B (Right)	JQE 15V 6A		Plus	PTG-003	L1-ISC-C4
3	CDS-1	03	L1-VDC-C2	02	Top	U33-A (Left)	JQE 25V 20A	H236408	Plus	PTY-012	L1-ISC-C4
4	CDS-1	03	L1-VDC-C2	02	Bottom	U33-B (Right)	JQE 25V 20A	H236466	Minus	PTY-012	L1-ISC-C4
5	CDS-1	17	L1-VDC-C2	09	Top	U29-A (Left)	JQE 25V 20A	H236426	Plus	PTO-057	L1-ISC-C4
6	CDS-1	17	L1-VDC-C2	09	Bottom	U29-B (Right)	JQE 25V 20A	H236439	Minus	PTO-057	L1-ISC-C4
7	CDS-1	05	L1-VDC-C2	03	Top	U25-A (Left)	JQE 25V 20A	H236437	Plus	PTY-011	L1-ISC-C3
8	CDS-1	05	L1-VDC-C2	03	Bottom	U25-B (Right)	JQE 25V 20A	H236425	Minus	PTY-011	L1-ISC-C3
9	CDS-1	19	L1-VDC-C2	10	Top	U21-A (Left)	JQE 25V 20A	H236444	Plus	PTO-056	L1-ISC-C3
10	CDS-1	19	L1-VDC-C2	10	Bottom	U21-B (Right)	JQE 25V 20A	H236471	Minus	PTO-056	L1-ISC-C3
11	CDS-1	07	L1-VDC-C2	04	Top	U17-A (Left)	JQE 25V 20A	H236431			
12	CDS-1	07	L1-VDC-C2	04	Bottom	U17-B (Right)	JQE 25V 20A	H236470			
13	CDS-1	21	L1-VDC-C2	11	Top	U13-A (Left)	JQE 25V 20A	H236430	Plus	PTO-055	L1-ISC-C2
14	CDS-1	21	L1-VDC-C2	11	Bottom	U13-B (Right)	JQE 25V 20A	H236445	Minus	PTO-055	L1-ISC-C2
15	CDS-1	09	L1-VDC-C2	05	Top	U09-A (Left)	JQE 25V 20A	H236395			
16	CDS-1	09	L1-VDC-C2	05	Bottom	U09-B (Right)	JQE 25V 20A	H236438			
17	CDS-1	23	L1-VDC-C2	12	Top	U05-A (Left)	JQE 25V 20A	H236475	Plus	PTO-054	L1-ISC-C1
18	CDS-1	23	L1-VDC-C2	12	Bottom	U05-B (Right)	JQE 25V 20A	H236455	Minus	PTO-054	L1-ISC-C1
19	CDS-1	06	L1-VDC-C2	06	Top	U01-A (Left)	JQE 25V 20A	H236399	Plus	L1-TB02	L1-ISC-C1
20	CDS-1	06	L1-VDC-C2	06	Bottom	U01-B (Right)	JQE 25V 20A	H236407	Plus	L1-TB07	L1-ISC-C2
D1200891											

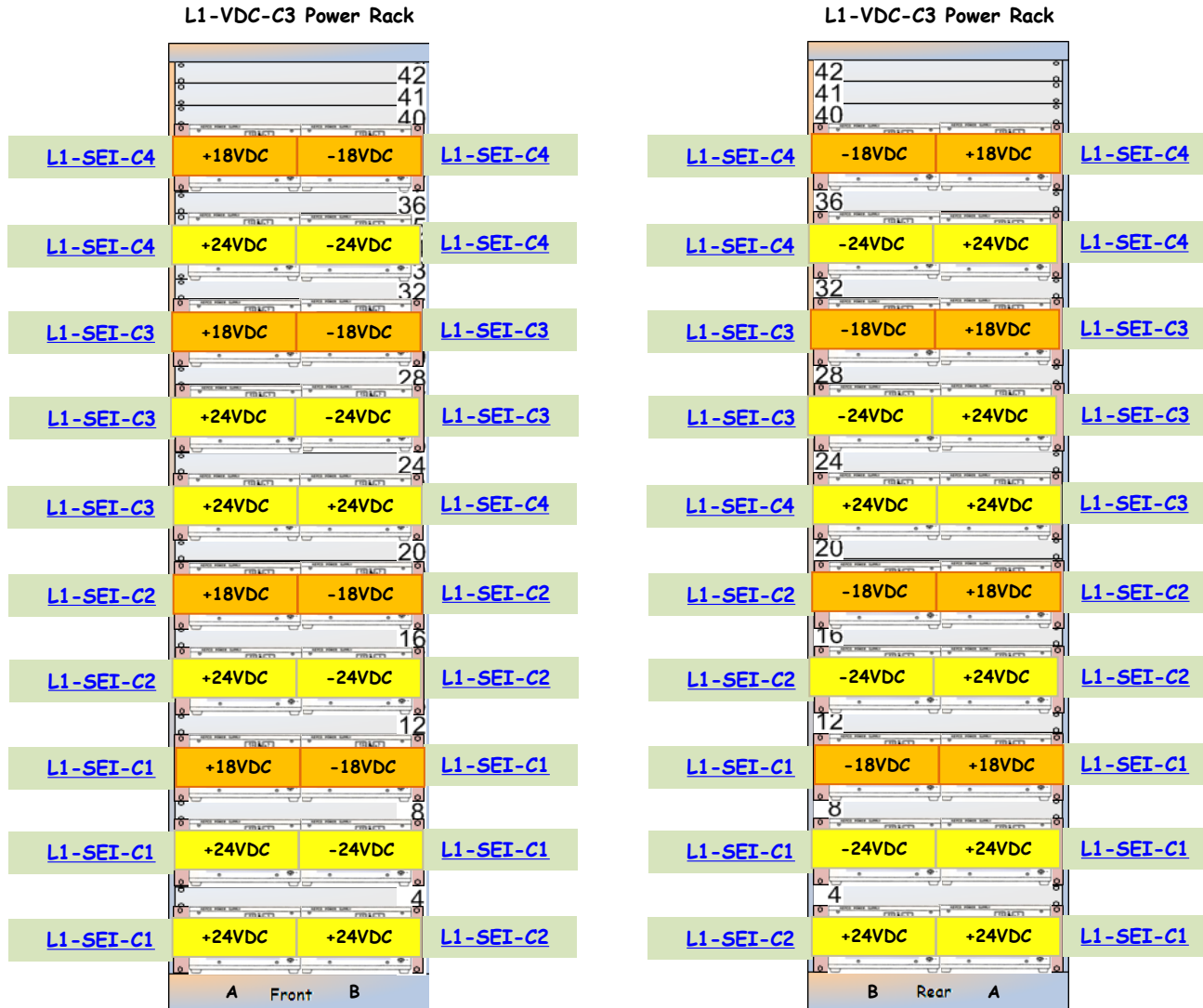

L1-VDC-C3 Cable Runs

<< [L1-VDC-C3](#)

L1-VDC-C3 Corner Station DC Cable Runs ([D1200892](#)) ([S1105249](#))

L1-VDC-C3 S1105249	Power Panel	Circuit	DC Power Rack	Outlet	Plug Position	Rack U	Power Supply Model	Power Supply Serial	Polarity	DC Extension Cable	Electronics Rack	DC Power Strip
1	CDS-2	15	L1-VDC-C3	08	Top	U37-A (Left)	JQE 25V 20A	H236457	Plus	PTO-014	L1-SEI-C4	PSO-014
2	CDS-2	15	L1-VDC-C3	08	Bottom	U37-B (Right)	JQE 25V 20A	H236456	Minus	PTO-014	L1-SEI-C4	PSO-014
3	CDS-2	03	L1-VDC-C3	02	Top	U33-A (Left)	JQE 25V 20A	H236450	Plus	PTY-013	L1-SEI-C4	PSY-013
4	CDS-2	03	L1-VDC-C3	02	Bottom	U33-B (Right)	JQE 25V 20A	H236454	Minus	PTY-013	L1-SEI-C4	PSY-013
5	CDS-2	17	L1-VDC-C3	09	Top	U29-A (Left)	JQE 25V 20A	H236452	Plus	PTO-015	L1-SEI-C3	PSO-015
6	CDS-2	17	L1-VDC-C3	09	Bottom	U29-B (Right)	JQE 25V 20A	H236451	Minus	PTO-015	L1-SEI-C3	PSO-015
7	CDS-2	05	L1-VDC-C3	03	Top	U25-A (Left)	JQE 25V 20A	H236458	Plus	PTY-014	L1-SEI-C3	PSY-014
8	CDS-2	05	L1-VDC-C3	03	Bottom	U25-B (Right)	JQE 25V 20A	H236432	Minus	PTY-014	L1-SEI-C3	PSY-014
9	CDS-2	19	L1-VDC-C3	10	Top	U21-A (Left)	JQE 25V 20A	H236435	Plus	PTY-015	L1-SEI-C3	PSY-015
10	CDS-2	19	L1-VDC-C3	10	Bottom	U21-B (Right)	JQE 25V 20A	H236436	Plus	PTY-016	L1-SEI-C4	PSY-016
11	CDS-2	07	L1-VDC-C3	04	Top	U17-A (Left)	JQE 25V 20A	H236402	Plus	PTO-016	L1-SEI-C2	PSO-016
12	CDS-2	07	L1-VDC-C3	04	Bottom	U17-B (Right)	JQE 25V 20A	H236477	Minus	PTO-016	L1-SEI-C2	PSO-016
13	CDS-2	21	L1-VDC-C3	11	Top	U13-A (Left)	JQE 25V 20A	H236384	Plus	PTY-017	L1-SEI-C2	PSY-017
14	CDS-2	21	L1-VDC-C3	11	Bottom	U13-B (Right)	JQE 25V 20A	H236390	Minus	PTY-017	L1-SEI-C2	PSY-017
15	CDS-2	09	L1-VDC-C3	05	Top	U09-A (Left)	JQE 25V 20A	H236383	Plus	PTO-017	L1-SEI-C1	PSO-017
16	CDS-2	09	L1-VDC-C3	05	Bottom	U09-B (Right)	JQE 25V 20A	H236391	Minus	PTO-017	L1-SEI-C1	PSO-017
17	CDS-2	23	L1-VDC-C3	12	Top	U05-A (Left)	JQE 25V 20A	H236372-R2	Plus	PTY-018	L1-SEI-C1	PSY-018
18	CDS-2	23	L1-VDC-C3	12	Bottom	U05-B (Right)	JQE 25V 20A	H236377	Minus	PTY-018	L1-SEI-C1	PSY-018
19	CDS-2	11	L1-VDC-C3	06	Top	U01-A (Left)	JQE 25V 20A	H236401	Plus	PTY-019	L1-SEI-C1	PSY-019
20	CDS-2	11	L1-VDC-C3	06	Bottom	U01-B (Right)	JQE 25V 20A	H236392	Plus	PTY-020	L1-SEI-C2	PSY-020
D1200892												



L1-VDC-C4 Cable Runs

<< [L1-VDC-C4](#)

L1-VDC-C4 Corner Station DC Cable Runs ([D1200893](#)) ([S1105250](#))

L1-VDC-C4 S1105250	Power Panel	Circuit	DC Power Rack	Outlet	Plug Position	Rack U	Power Supply Model	Power Supply Serial	Polarity	DC Extension Cable	Electronics Rack	DC Power Strip
1	CDS-2	26	L1-VDC-C4	08	Top	U37-A (Left)	JQE 25V 20A	H236442	Plus	PTO-018	L1-PSL-C1	PSO-018
2	CDS-2	26	L1-VDC-C4	08	Bottom	U37-B (Right)	JQE 25V 20A	H236416	Minus	PTO-018	L1-PSL-C1	PSO-018
3	CDS-2	14	L1-VDC-C4	02	Top	U33-A (Left)	JQE 25V 20A	H236449				
4	CDS-2	14	L1-VDC-C4	02	Bottom	U33-B (Right)	JQE 25V 20A	H236453	Plus	PTY-009	L1-PSL-C1	PSY-009
5	CDS-2	28	L1-VDC-C4	09	Top	U29-A (Left)	JQE 25V 20A	H236495	Plus	PTY-002	L1-SUS-C5A	None
6	CDS-2	28	L1-VDC-C4	09	Bottom	U29-B (Right)	JQE 25V 20A	H236375	Plus	PTY-005	L1-SUS-C3A	PSY-027
7	CDS-2	16	L1-VDC-C4	03	Top	U25-A (Left)	JQE 25V 20A	H210621	Plus	L1-TB03	L1-SUS-C2	PSY-004
8	CDS-2	16	L1-VDC-C4	03	Bottom	U25-B (Right)	JQE 25V 20A	H210620	Plus	L1-TB04	L1-SUS-C3B	PSY-005
9	CDS-2	30	L1-VDC-C4	10	Top	U21-A (Left)	JQE 25V 20A	H210618	Plus	L1-TB01	L1-SUS-C5B	PSY-002
10	CDS-2	30	L1-VDC-C4	10	Bottom	U21-B (Right)	JQE 25V 20A	H236386	Plus	PTY-001	L1-SUS-C8	PSY-001
11	CDS-2	18	L1-VDC-C4	04	Top	U17-A (Left)	JQE 25V 20A	H236374	Plus	PTO-019	L1-SEI-C6	PSO-019
12	CDS-2	18	L1-VDC-C4	04	Bottom	U17-B (Right)	JQE 25V 20A	H236382	Minus	PTO-019	L1-SEI-C6	PSO-019
13	CDS-2	32	L1-VDC-C4	11	Top	U13-A (Left)	JQE 25V 20A	H236373	Plus	PTY-021	L1-SEI-C6	PSY-021
14	CDS-2	32	L1-VDC-C4	11	Bottom	U13-B (Right)	JQE 25V 20A	H236387	Minus	PTY-021	L1-SEI-C6	PSY-021
15	CDS-2	20	L1-VDC-C4	05	Top	U09-A (Left)	JQE 25V 20A	H236376	Plus	PTO-020	L1-SEI-C5	PSO-020
16	CDS-2	20	L1-VDC-C4	05	Bottom	U09-B (Right)	JQE 25V 20A	H236379	Minus	PTO-020	L1-SEI-C5	PSO-020
17	CDS-2	34	L1-VDC-C4	12	Top	U05-A (Left)	JQE 25V 20A	H236381	Plus	PTY-022	L1-SEI-C5	PSY-022
18	CDS-2	34	L1-VDC-C4	12	Bottom	U05-B (Right)	JQE 25V 20A	H236385	Minus	PTY-022	L1-SEI-C5	PSY-022
19	CDS-2	22	L1-VDC-C4	06	Top	U01-A (Left)	JQE 25V 20A	H236415	Plus	PTY-023	L1-SEI-C5	PSY-023
20	CDS-2	22	L1-VDC-C4	06	Bottom	U01-B (Right)	JQE 25V 20A	H236403	Plus	PTY-024	L1-SEI-C6	PSY-024
D1200893												



L1-VDC-C5 Cable Runs

<< [L1-VDC-C5](#)

L1-VDC-C5 Corner Station DC Cable Runs ([D1200894](#)) ([S1105251](#))

L1-VDC-C5 S1105251	Power Panel	Circuit	DC Power Rack	Outlet	Plug Position	Rack U	Power Supply Model	Power Supply Serial	Polarity	DC Extension Cable	Electronics Rack	Cable Length	DC Power Strip
1	CDS-1	25	L1-VDC-C5	08	Top	U37-A (Left)							
2	CDS-1	25	L1-VDC-C5	08	Bottom	U37-B (Right)	JQE 25V 10A	H192374					
3	CDS-2	13	L1-VDC-C5	02	Top	U33-A (Left)							
4	CDS-2	13	L1-VDC-C5	02	Bottom	U33-B (Right)							
5	CDS-1	13	L1-VDC-C5	09	Top	U29-A (Left)	JQE 25V 4A JQE 25V 4A						
6	CDS-1	13	L1-VDC-C5	09	Bottom	U29-B (Right)	BHK 300V 130mA	A100472					
7	CDS-2	38	L1-VDC-C5	03	Top	U25-A (Left)	JQE 150V 3.5A	H179839					
8	CDS-2	38	L1-VDC-C5	03	Bottom	U25-B (Right)	JQE 150V 3.5A	H179837					
9	CDS-1	01	L1-VDC-C5	10	Top	U21-A (Left)	JQE 25V 20A	H236420	Plus	PTO-027 PTO-028 PTO-030	L1-SUS-R3 L1-SUS-R5 L1-SUS-R6		PSO-027 PSO-028 PSO-030
10	CDS-1	01	L1-VDC-C5	10	Bottom	U21-B (Right)	JQE 25V 20A	H236378	Minus	PTO-027 PTO-028 PTO-030	L1-SUS-R3 L1-SUS-R5 L1-SUS-R6		PSO-027 PSO-028 PSO-030
11	CDS-2	12	L1-VDC-C5	04	Top	U17-A (Left)	JQE 25V 20A	H236409	Plus	PTO-023 PTO-024	L1-SUS-R1 L1-SUS-R2		PSO-023 PSO-024
12	CDS-2	12	L1-VDC-C5	04	Bottom	U17-B (Right)	JQE 25V 20A	H236410	Minus	PTO-023 PTO-024	L1-SUS-R1 L1-SUS-R2		PSO-023 PSO-024
13	CDS-1	04	L1-VDC-C5	11	Top	U13-A (Left)	JQE 25V 20A	H236380	Plus	PTO-025	L1-PSL-R2		PSO-025
14	CDS-1	04	L1-VDC-C5	11	Bottom	U13-B (Right)	JQE 25V 20A	H236465	Minus	PTO-025	L1-PSL-R2		PSO-025
15	CDS-2	24	L1-VDC-C5	05	Top	U09-A (Left)	JQE 25V 20A	H236459	Plus	PTY-025	L1-PSL-R2		PSY-025
16	CDS-2	24	L1-VDC-C5	05	Bottom	U09-B (Right)	JQE 25V 20A	H236394	Minus	PTY-025	L1-PSL-R2		PSY-025
17	CDS-2	01	L1-VDC-C5	12	Top	U05-A (Left)	JQE 25V 20A	H236397	Plus	PTO-026	L1-PSL-R1		PSO-026
18	CDS-2	01	L1-VDC-C5	12	Bottom	U05-B (Right)	JQE 25V 20A	H236400	Minus	PTO-026	L1-PSL-R1		PSO-026
19	CDS-2	36	L1-VDC-C5	06	Top	U01-A (Left)	JQE 25V 20A	H236393	Plus	L1-TB05	L1-PSL-R1		PSY-026
20	CDS-2	36	L1-VDC-C5	06	Bottom	U01-B (Right)	JQE 25V 20A	H236398	Minus	L1-TB05	L1-PSL-R1		PSY-026

L1-VDC-C6 Power Racks - Required Supplies

<< CPR

L1-VDC-C6 Corner Station DC Power Rack Layout ([D1200895](#)) ([S1105252](#))

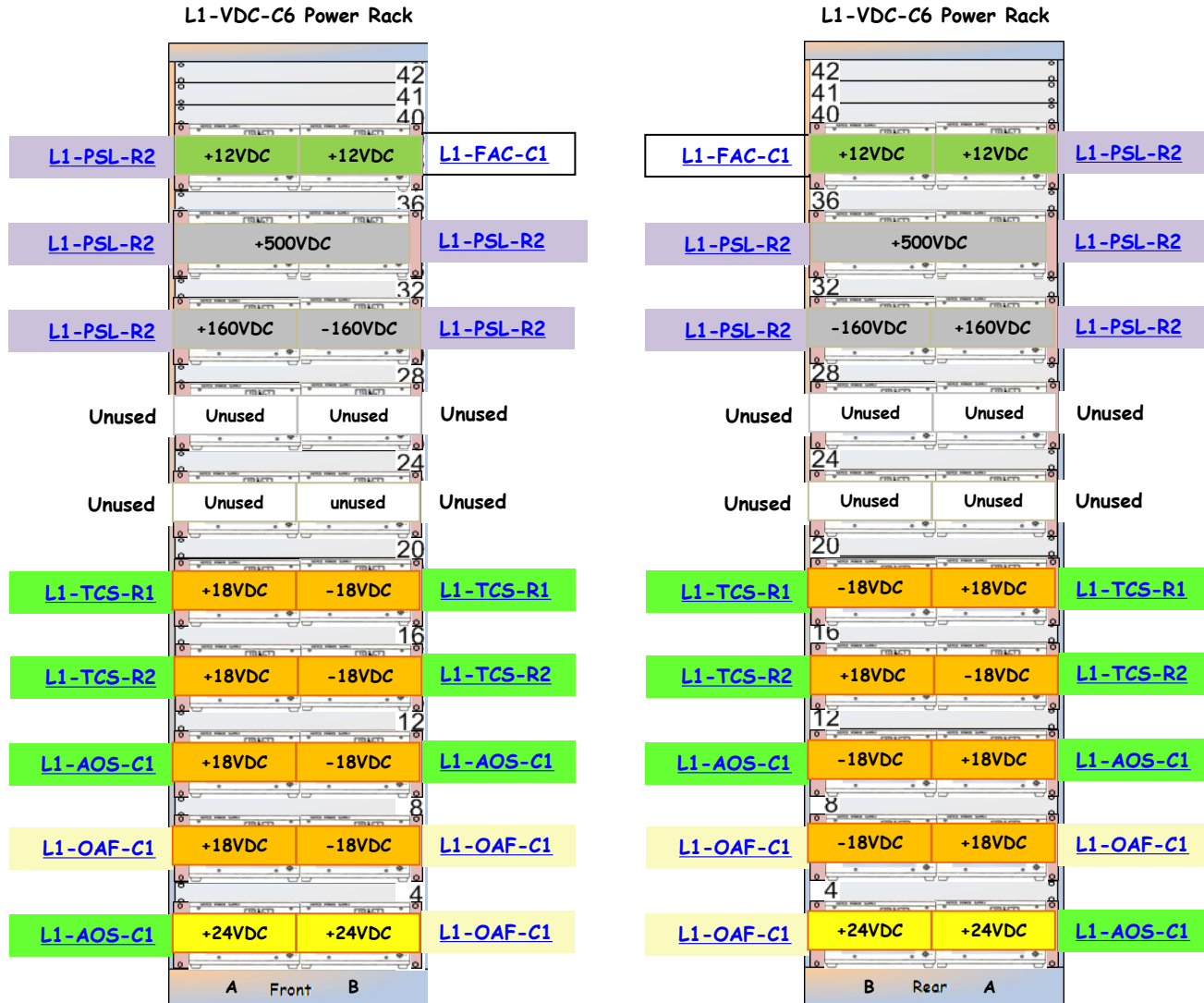

[Cable Runs >>](#)

L1-VDC-C6 Cable Runs

<< [L1-VDC-C6](#)

L1-VDC-C6 Corner Station DC Cable Runs ([D1200895](#)) ([S1105252](#))

L1-VDC-C6 S1105252	Power Panel	Circuit	DC Power Rack	Outlet	Plug Position	Rack U	Power Supply Model	Power Supply Serial	Polarity	DC Extension Cable	Electronics Rack	Cable Length	DC Power Strip
1	CDS-2	37	L1-VDC-C6	08	Top	U37-A (Left)	JQE 15V 6A		Plus	PTB-001	L1-PSL-R2		PSG-002
2	CDS-2	37	L1-VDC-C6	08	Bottom	U37-B (Right)	JQE 15V 6A		Plus	PTG-001	L1-OAF-C1	-	PSG-001
3	CDS-2	31	L1-VDC-C6	02	Top	U33-A (Left)	BHK 500V 0.4A	C72508	Plus	PBX-001	L1-PSL-R2		
4	CDS-2	31	L1-VDC-C6	02	Bottom	U33-B (Right)	BHK 500V 0.4A	C72508	Plus	PBX-001	L1-PSL-R2		
5	CDS-2	27	L1-VDC-C6	09	Top	U29-A (Left)	PCX 200V 0.1A		Plus	PBX-002	L1-PSL-R2		
6	CDS-2	27	L1-VDC-C6	09	Bottom	U29-B (Right)	PCX 200V 0.1A		Minus	PBX-002	L1-PSL-R2		
7	CDS-2	08	L1-VDC-C6	03	Top	U25-A (Left)	BHK 500V 80mA	A107262	Plus	Spare	L1-TSC-XR1		
8	CDS-2	08	L1-VDC-C6	03	Bottom	U25-B (Right)	BHK 500V 80mA	A107265	Minus	Spare	L1-TSC-YR1		
9	CDS-2	39	L1-VDC-C6	10	Top	U21-A (Left)	JQE 15V 12A	H114633					
10	CDS-2	39	L1-VDC-C6	10	Bottom	U21-B (Right)	JQE 15V 12A	H114642					
11	CDS-2	33	L1-VDC-C6	04	Top	U17-A (Left)	JQE 15V 12A	H114630					
12	CDS-2	33	L1-VDC-C6	04	Bottom	U17-B (Right)	JQE 15V 12A	H114625					
13	CDS-2	29	L1-VDC-C6	11	Top	U13-A (Left)	JQE 15V 12A	H114649					
14	CDS-2	29	L1-VDC-C6	11	Bottom	U13-B (Right)	JQE 15V 12A	H114648					
15	CDS-2	10	L1-VDC-C6	05	Top	U09-A (Left)							
16	CDS-2	10	L1-VDC-C6	05	Bottom	U09-B (Right)	JQE 150V 1.5A				L1-TSC-C1		
17	CDS-2	41	L1-VDC-C6	12	Top	U05-A (Left)	JQE 25V 20A	H236423	Plus	PTO-012	L1-OAF-C1	-	
18	CDS-2	41	L1-VDC-C6	12	Bottom	U05-B (Right)	JQE 25V 20A	H236413	Minus	PTO-012	L1-OAF-C1	-	
19	CDS-2	35	L1-VDC-C6	06	Top	U01-A (Left)	JQE 25V 20A	H236491	Plus	PTY-055	L1-TSC-C1		
20	CDS-2	35	L1-VDC-C6	06	Bottom	U01-B (Right)	JQE 25V 20A	H236472	Plus	PTY-053	L1-OAF-C1	-	
D1200895													

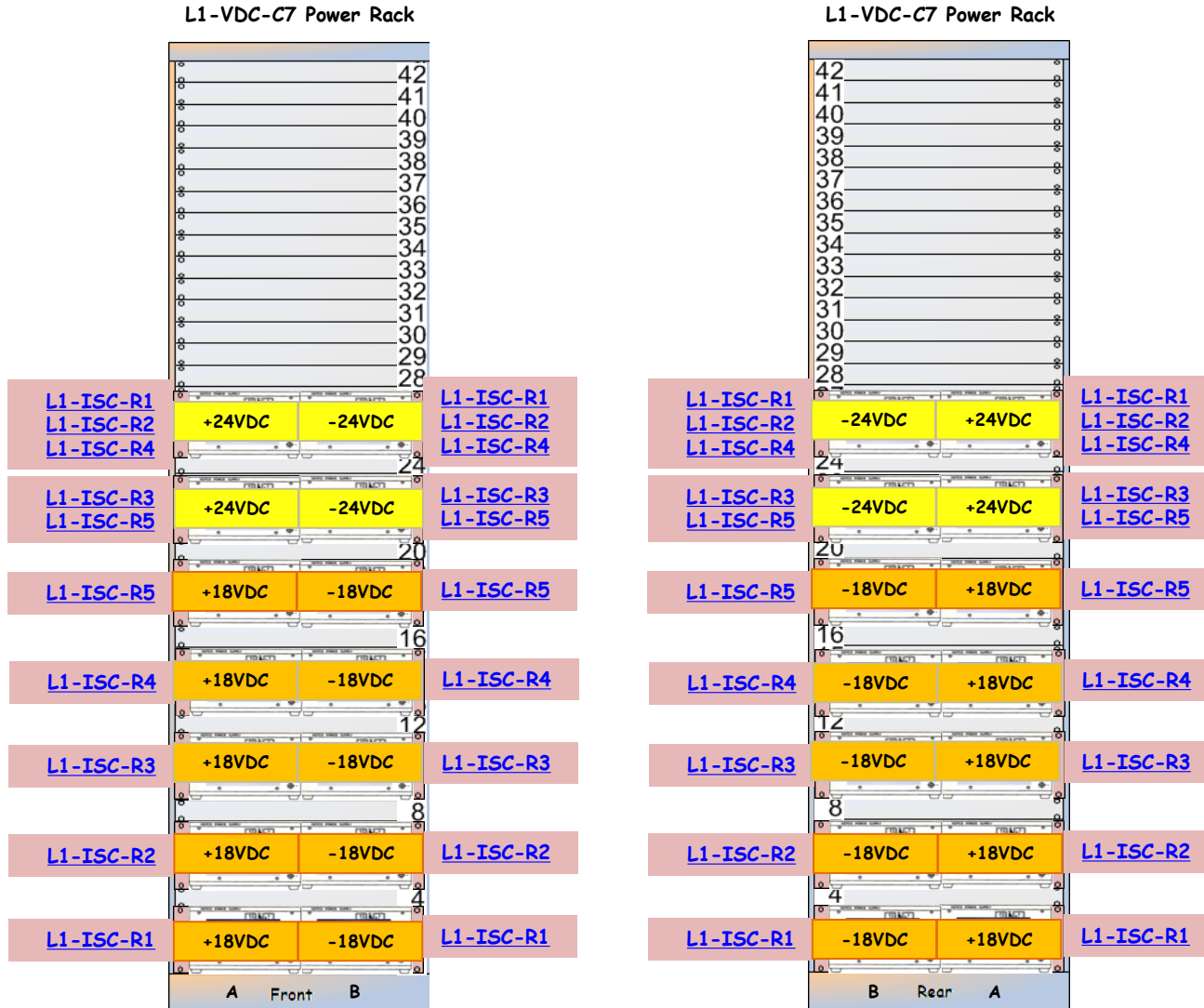

L1-VDC-C7 Cable Runs

<< [L1-VDC-C7](#)

L1-VDC-C7 Corner Station DC Cable Runs ([D1200896](#)) ([S1105253](#))

L1-VDC-C7 S1105253	Power Panel	Circuit	DC Power Rack	Outlet	Plug Position	Rack U	Power Supply Model	Power Supply Serial	Polarity	DC Extension Cable	Electronics Rack
1	CDS-1	22	L1-VDC-C7	07	Top	U37-A (Left)					
2	CDS-1	22	L1-VDC-C7	07	Bottom	U37-B (Right)					
3	CDS-1	16	L1-VDC-C7	01	Top	U33-A (Left)	JQE 15V 12A	H114617			
4	CDS-1	16	L1-VDC-C7	01	Bottom	U33-B (Right)	JQE 15V 12A	H114627			
5	CDS-1	34	L1-VDC-C7	08	Top	U29-A (Left)	JQE 15V 12A	H114645			
6	CDS-1	34	L1-VDC-C7	08	Bottom	U29-B (Right)	JQE 15V 12A	H114641			
7	CDS-1	28	L1-VDC-C7	02	Top	U25-A (Left)	JQE 25V 20A	H236405	Plus	L1-TB06 PTY-048 PTY-049	L1-ISC-R1 L1-ISC-R2 L1-ISC-R4
8	CDS-1	28	L1-VDC-C7	02	Bottom	U25-B (Right)	JQE 25V 20A	H236411	Minus	L1-TB06 PTY-048 PTY-049	L1-ISC-R1 L1-ISC-R2 L1-ISC-R4
9	CDS-1	24	L1-VDC-C7	09	Top	U21-A (Left)	JQE 25V 20A	H236460	Plus	PTY-050 PTY-051	L1-ISC-R3 L1-ISC-R5
10	CDS-1	24	L1-VDC-C7	09	Bottom	U21-B (Right)	JQE 25V 20A	H236433	Minus	PTY-050 PTY-051	L1-ISC-R3 L1-ISC-R5
11	CDS-1	18	L1-VDC-C7	03	Top	U17-A (Left)	JQE 25V 20A	H236448	Plus	PTO-061	L1-ISC-R5
12	CDS-1	18	L1-VDC-C7	03	Bottom	U17-B (Right)	JQE 25V 20A	H236446	Minus	PTO-061	L1-ISC-R5
13	CDS-2	02	L1-VDC-C7	10	Top	U13-A (Left)	JQE 25V 20A	H236440	Plus	PTO-060	L1-ISC-R4
14	CDS-2	02	L1-VDC-C7	10	Bottom	U13-B (Right)	JQE 25V 20A	H236485	Minus	PTO-060	L1-ISC-R4
15	CDS-1	30	L1-VDC-C7	04	Top	U09-A (Left)	JQE 25V 20A	H236419	Plus	PTO-062	L1-ISC-R3
16	CDS-1	30	L1-VDC-C7	04	Bottom	U09-B (Right)	JQE 25V 20A	H236412	Minus	PTO-062	L1-ISC-R3
17	CDS-1	26	L1-VDC-C7	11	Top	U05-A (Left)	JQE 25V 20A	H236429	Plus	PTO-059	L1-ISC-R2
18	CDS-1	26	L1-VDC-C7	11	Bottom	U05-B (Right)	JQE 25V 20A	H236462	Minus	PTO-059	L1-ISC-R2
19	CDS-1	20	L1-VDC-C7	05	Top	U01-A (Left)	JQE 25V 20A	H236417	Plus	PTO-058	L1-ISC-R1
20	CDS-1	20	L1-VDC-C7	05	Bottom	U01-B (Right)	JQE 25V 20A	H236421	Minus	PTO-058	L1-ISC-R1
D1200896											

<< LLO Racks by Subsystem

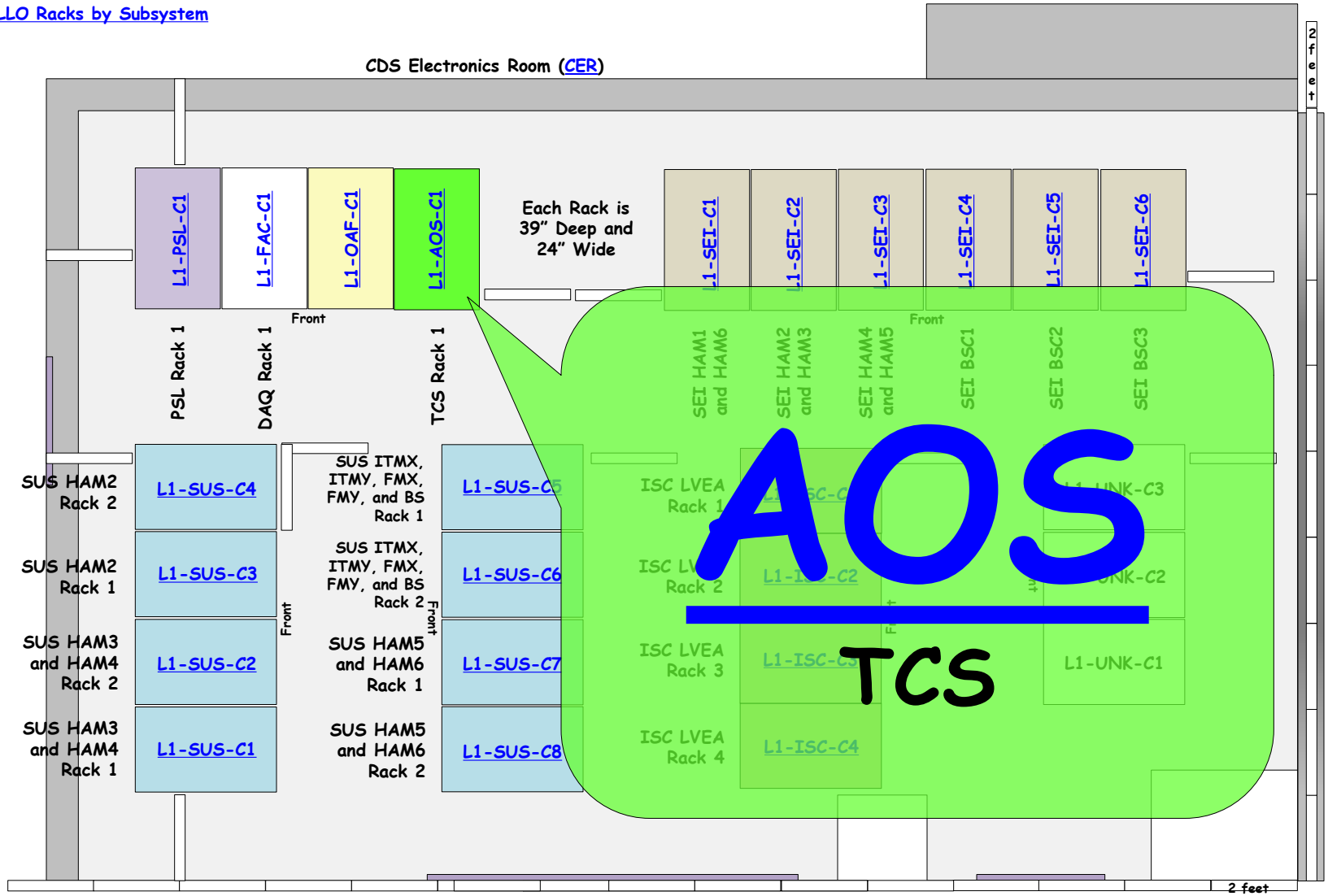

IO Diagram: [D1100909](#)

Op Lev Docs : [E1200031](#) and [T1000097](#)

[D1200258](#)

AOS Rack Layout ([D1201119](#)) ([S1202974](#))

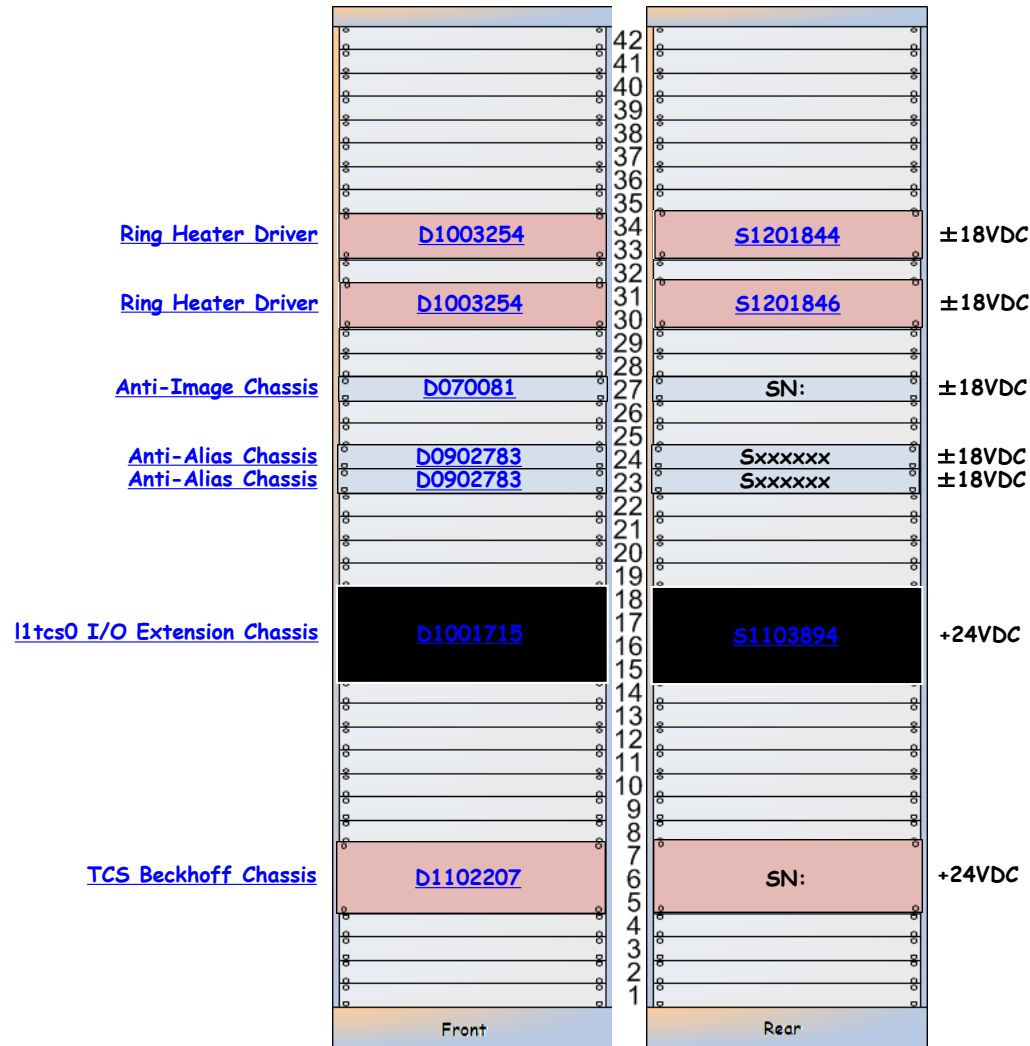

L1-AOS-C1 is part of [E1100895](#)

L1-AOS-C1 is part of [D1200258](#)

L1-AOS-C1 Details

Ring Heater Driver

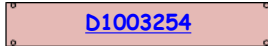

±18VDC

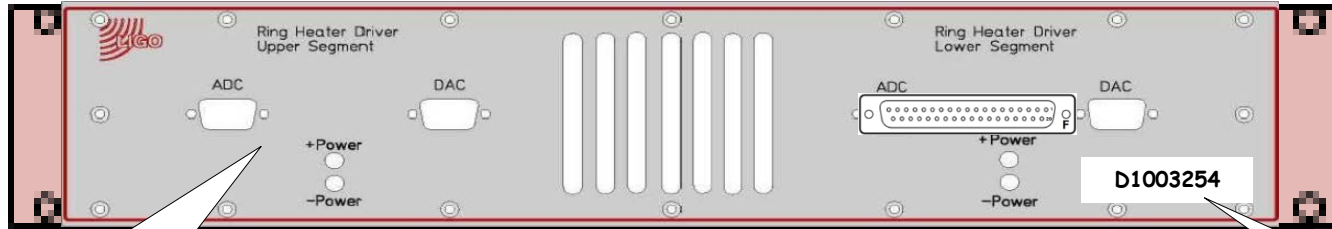

[D1003254](#)

Front

This is an early revision of the front panel. It now has one DB37M connector. 20121205 dlk

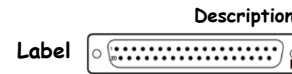

White label 20121205 dlk

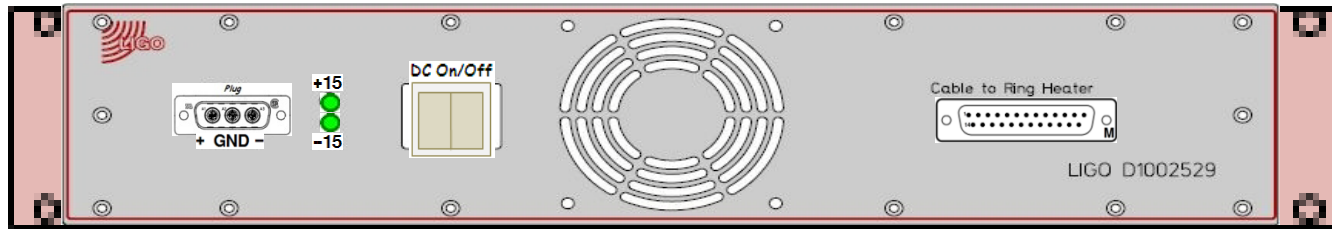

[S1201844](#)

Rear



Ring Heater Driver

D1003254

S1201846

±18VDC

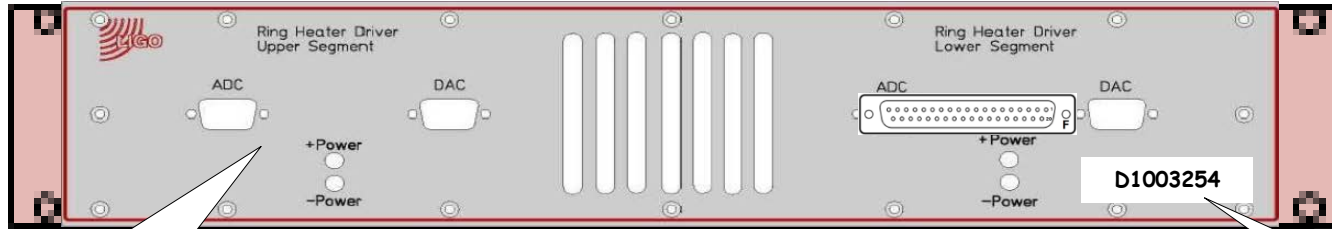

D1003254

Front

This is an early revision of the front panel. It now has one DB37M connector. 20121205 dlk



White label 20121205 dlk

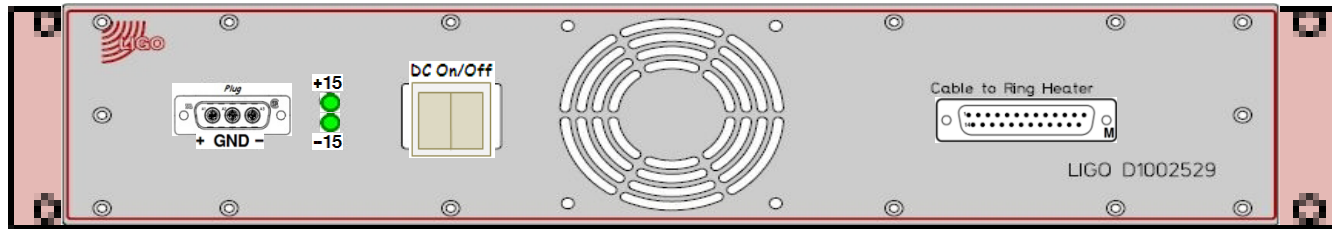

S1201846

Rear



Anti-Image Chassis D070081 Sxxxxxxx ±18VDC

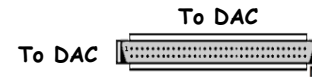
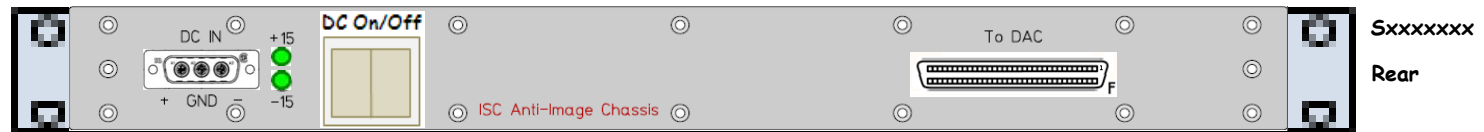
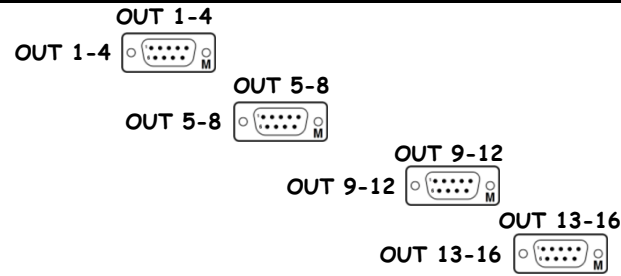
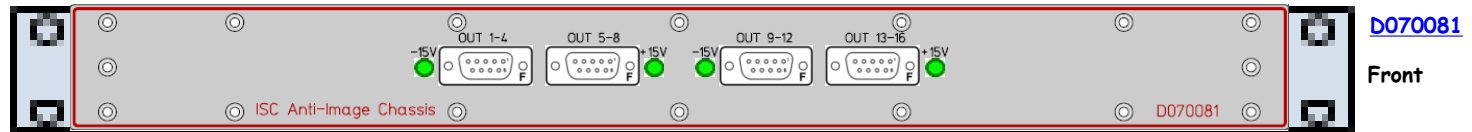

Anti-Alias Chassis D0902783 Sxxxxxxx ±18VDC

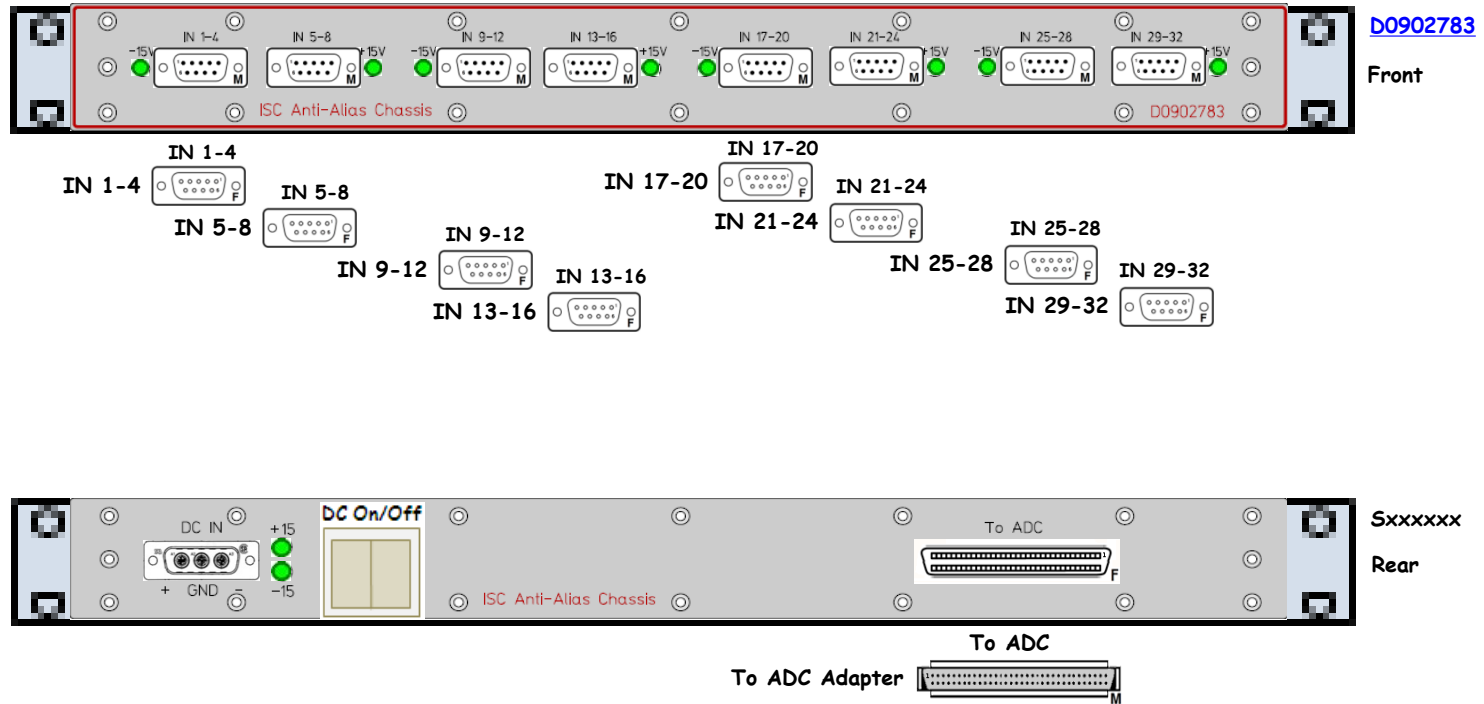

Anti-Alias Chassis D0902783 Sxxxxxxx ±18VDC

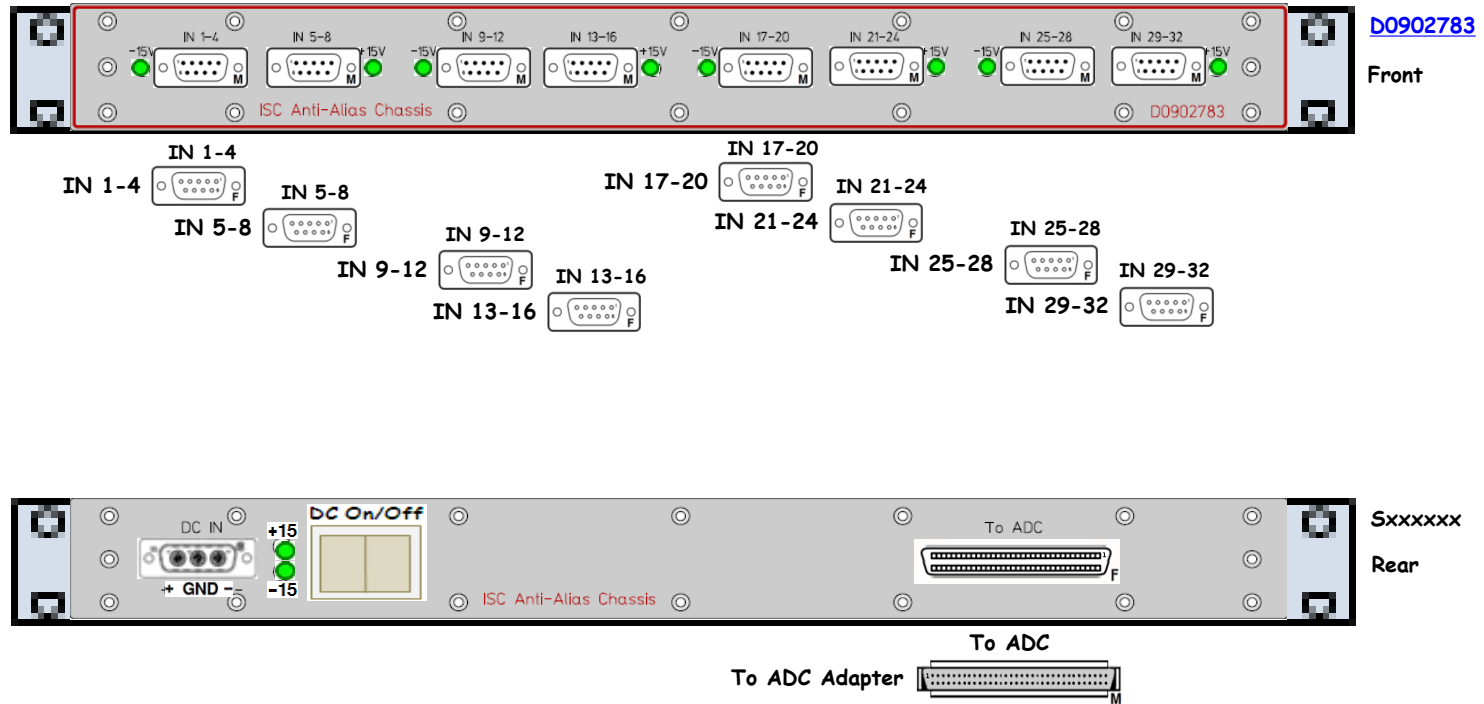

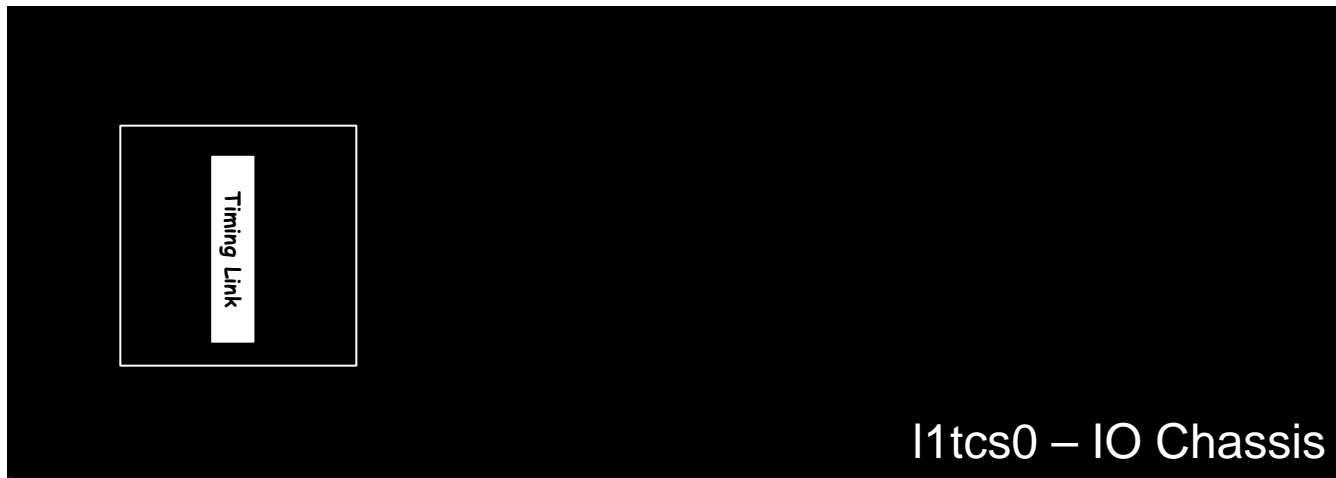

D1001715

Front

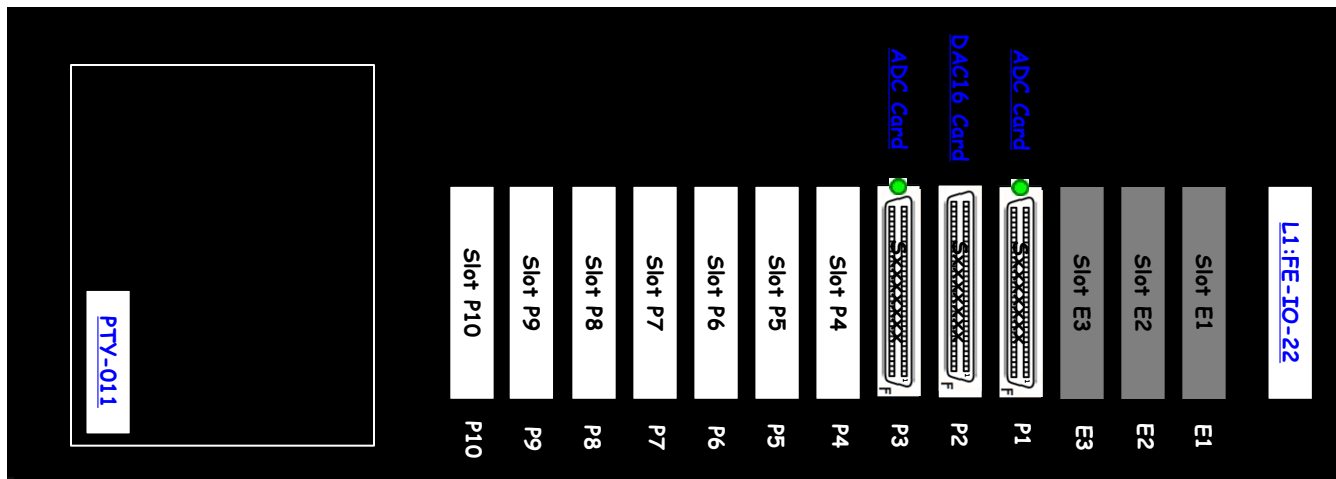

S1103894

Rear

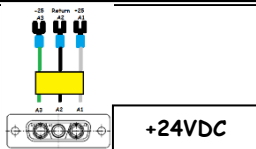
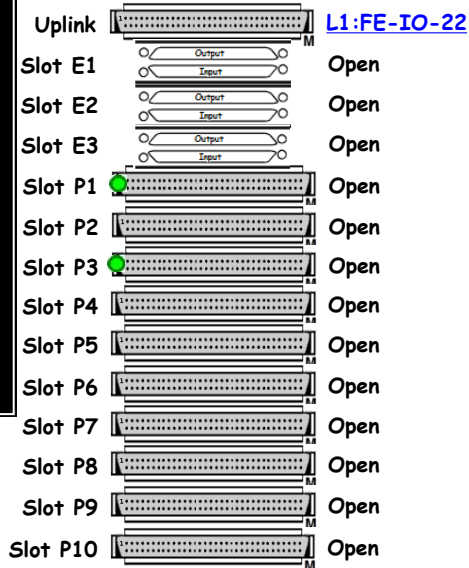

<< L1-AOS-C1

TCS Beckhoff Chassis

[D1102207](#)

SN:

+24VDC

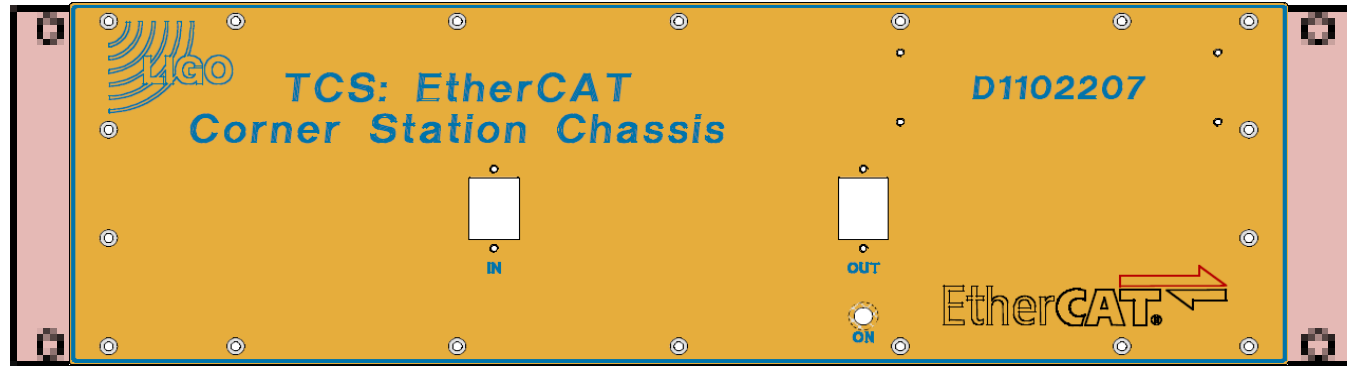

[D1102207](#)

Front

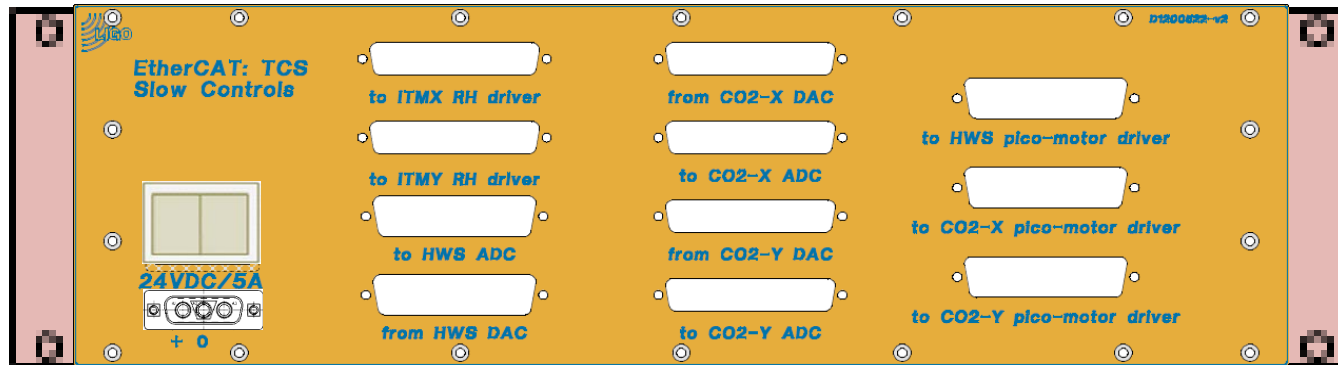

Sxxxxxx

Rear

<< LLO Racks by Subsystem

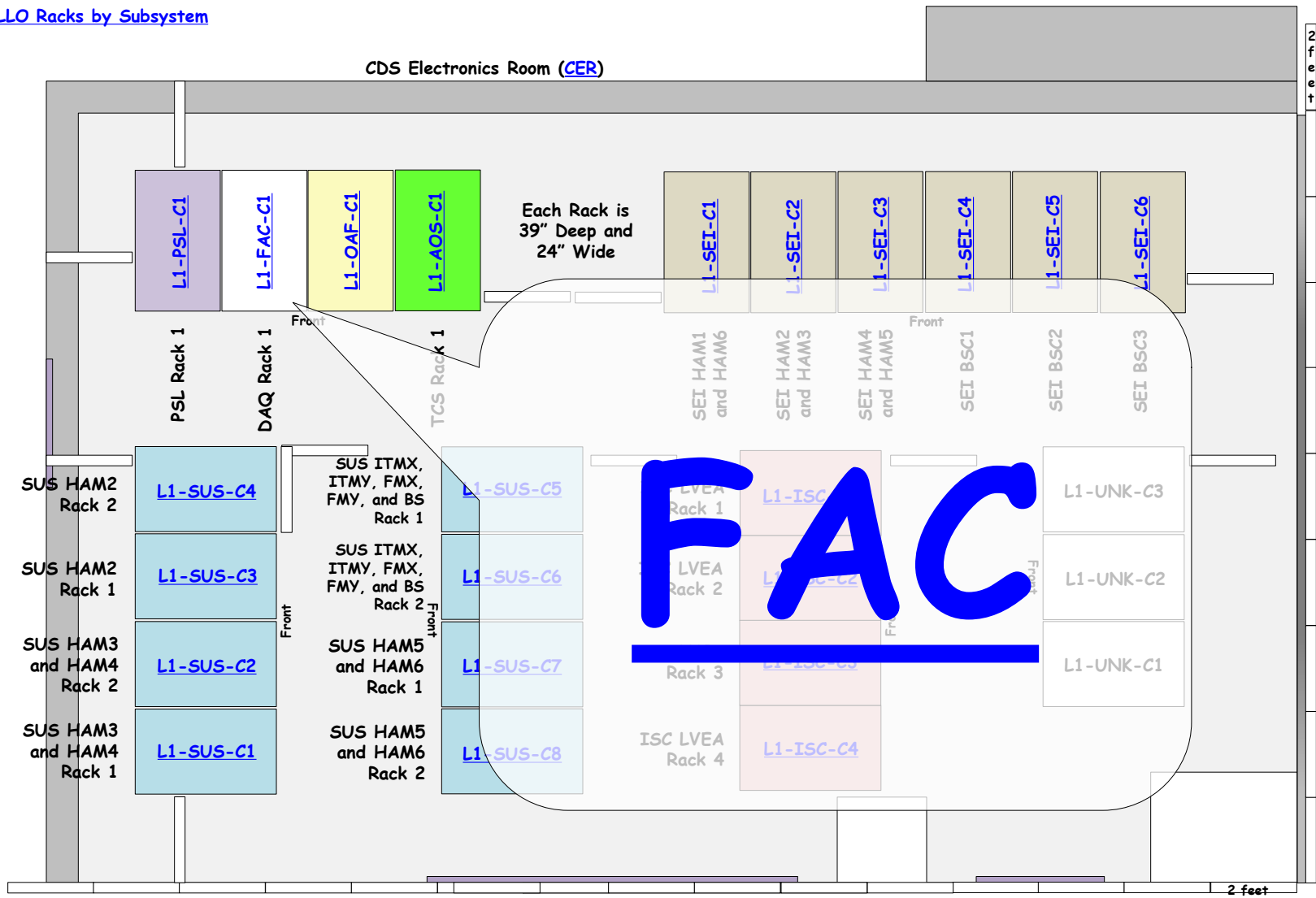

L1-FAC-C1

L1-FAC-C1 Rack Layout (D1200940) (S1202403)

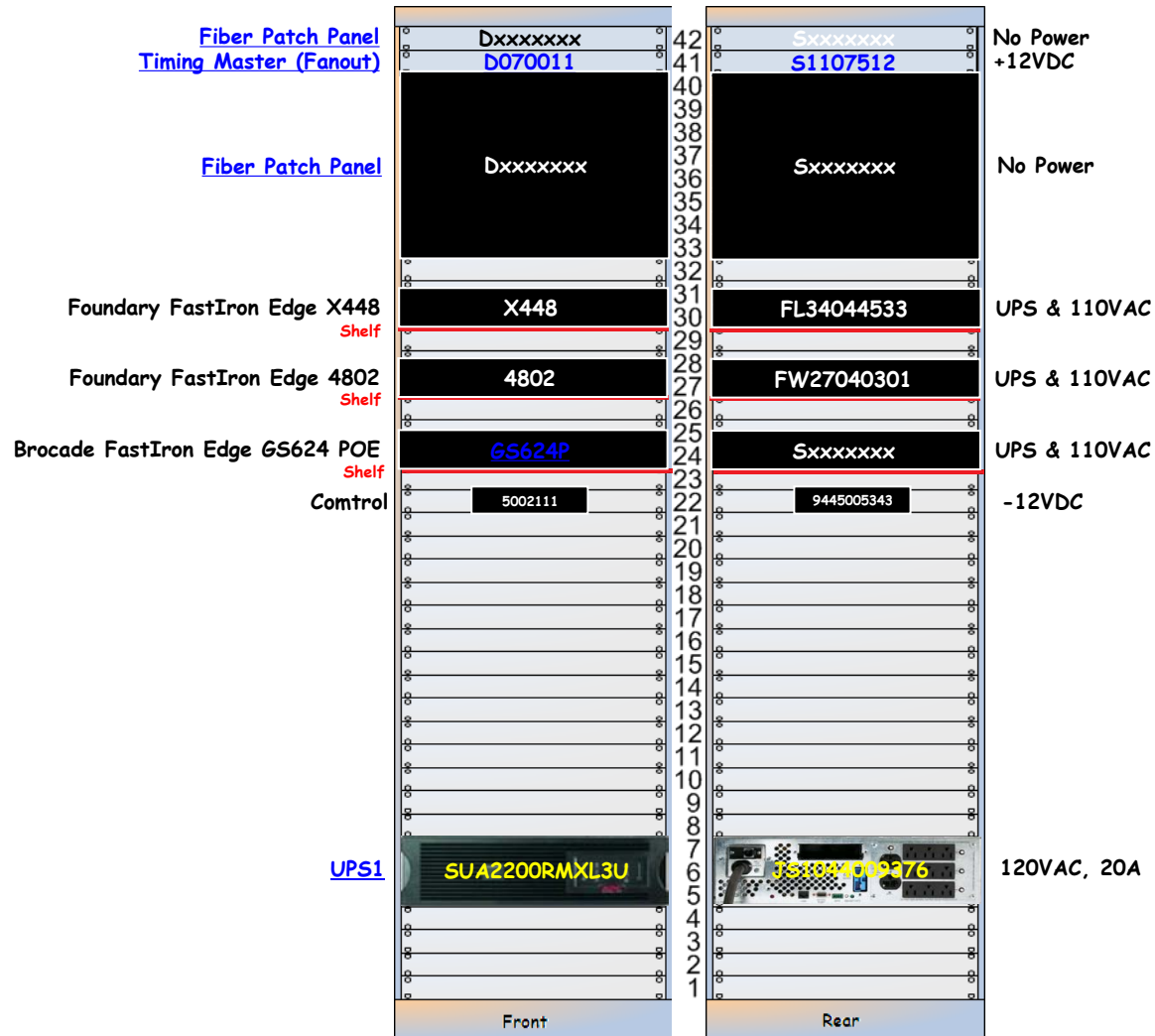

L1-FAC-C1 Details

<< [L1-FAC-C1](#)

Fiber Patch Panel No Power

Fibercables.com



[D070011](#)

Front

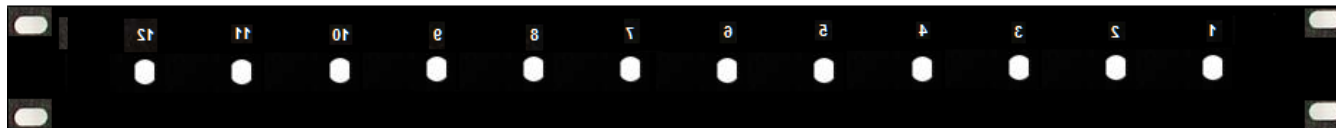

[S1107511](#)

Rear



[D070011](#)

Front



[S1107512](#)

Rear

Fiber Patch Panel

Fiber Patch Panel

Dxxxxxxx

Sxxxxxxx

No Power

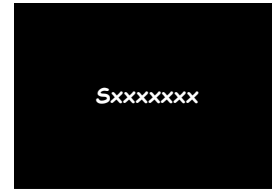

SUA2200RMXL3U - JS1044009376 UPS

<< L1-FAC-C1

UPS1

SUA2200RMXL3U



120VAC, 20A



<< LLO Racks by Subsystem

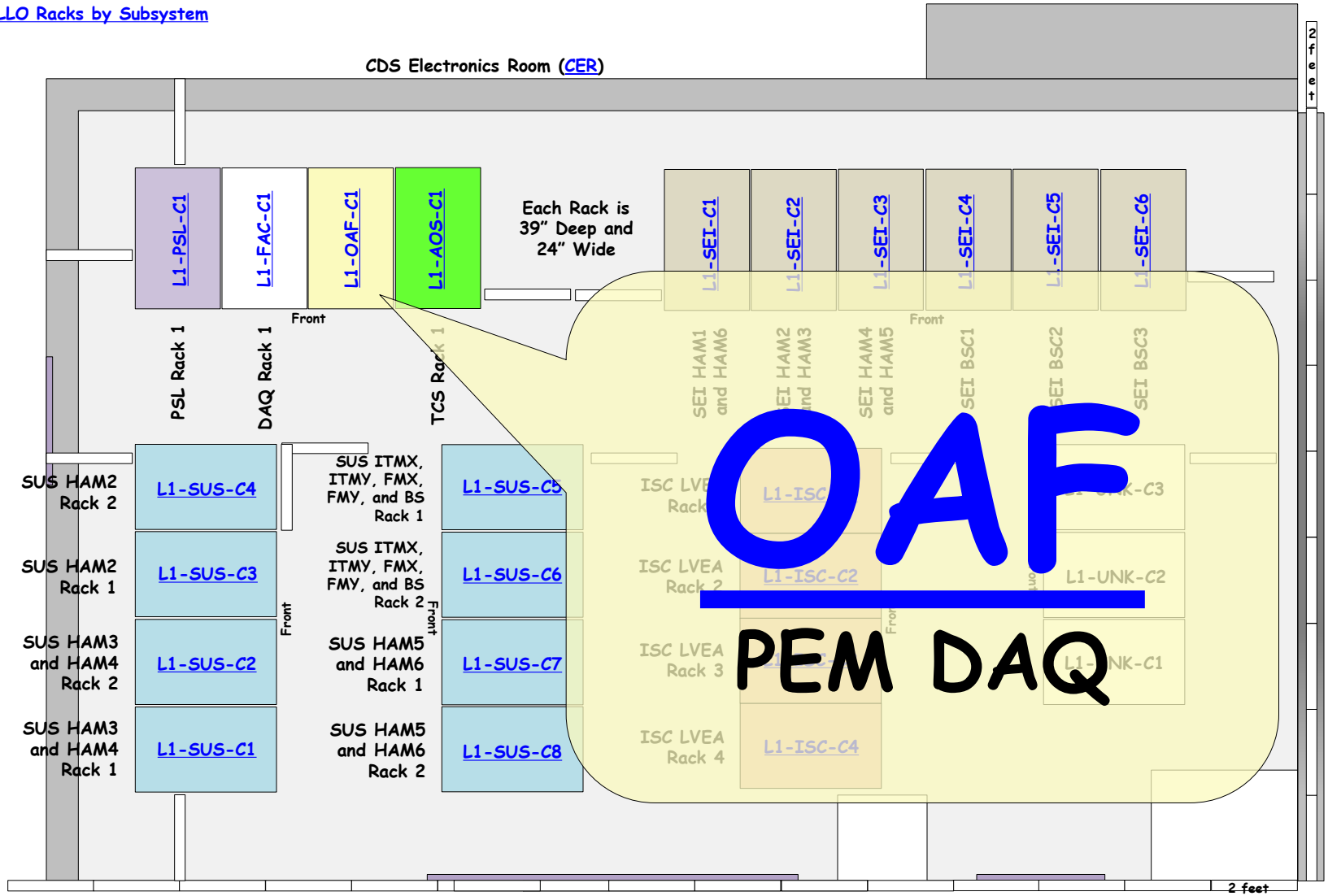

L1-OAF-C1

L1-OAF-C1 Rack Layout ([D1200941](#)) ([S1202404](#))

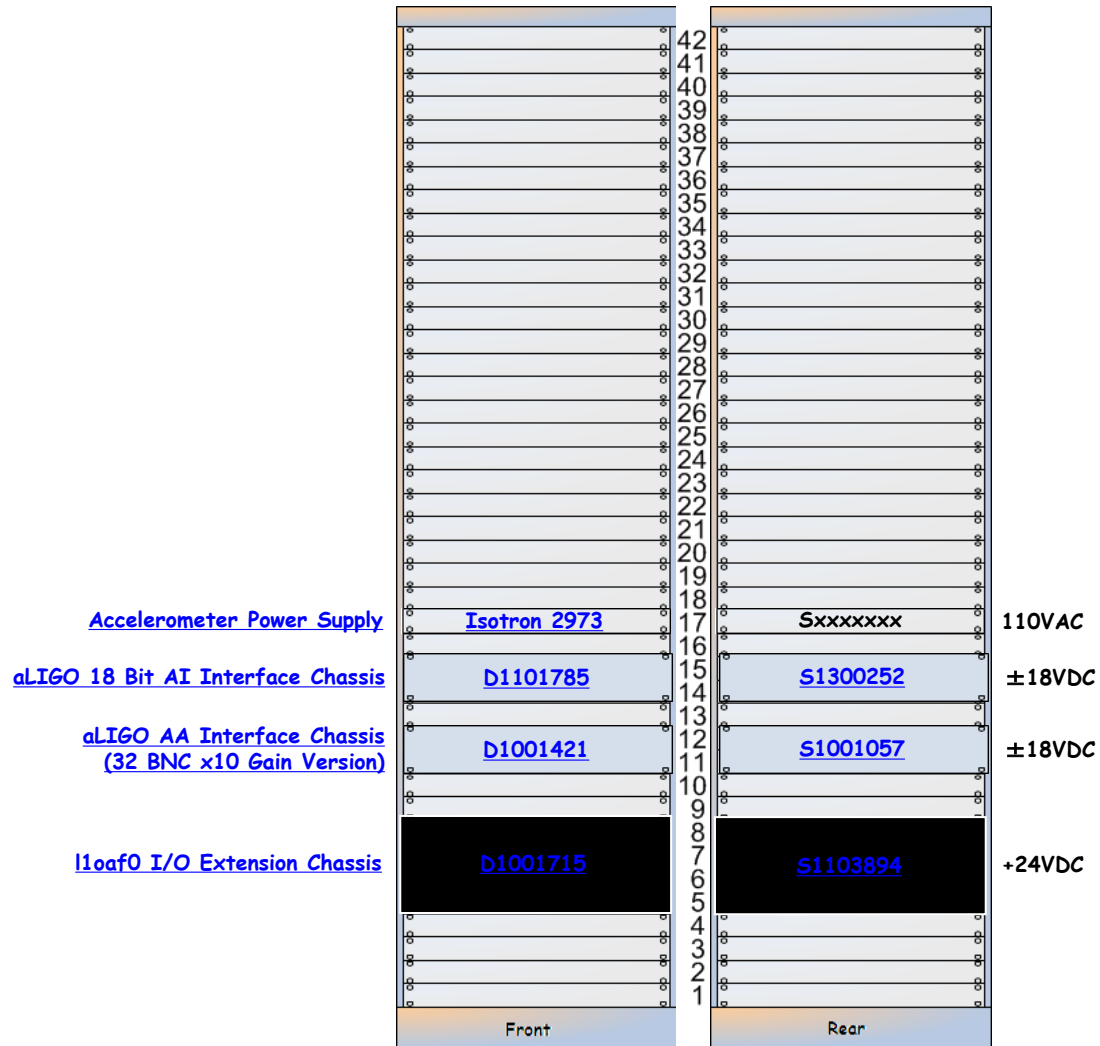

L1-OAF-C1 Details

Accelerometer Power Supply 110VAC

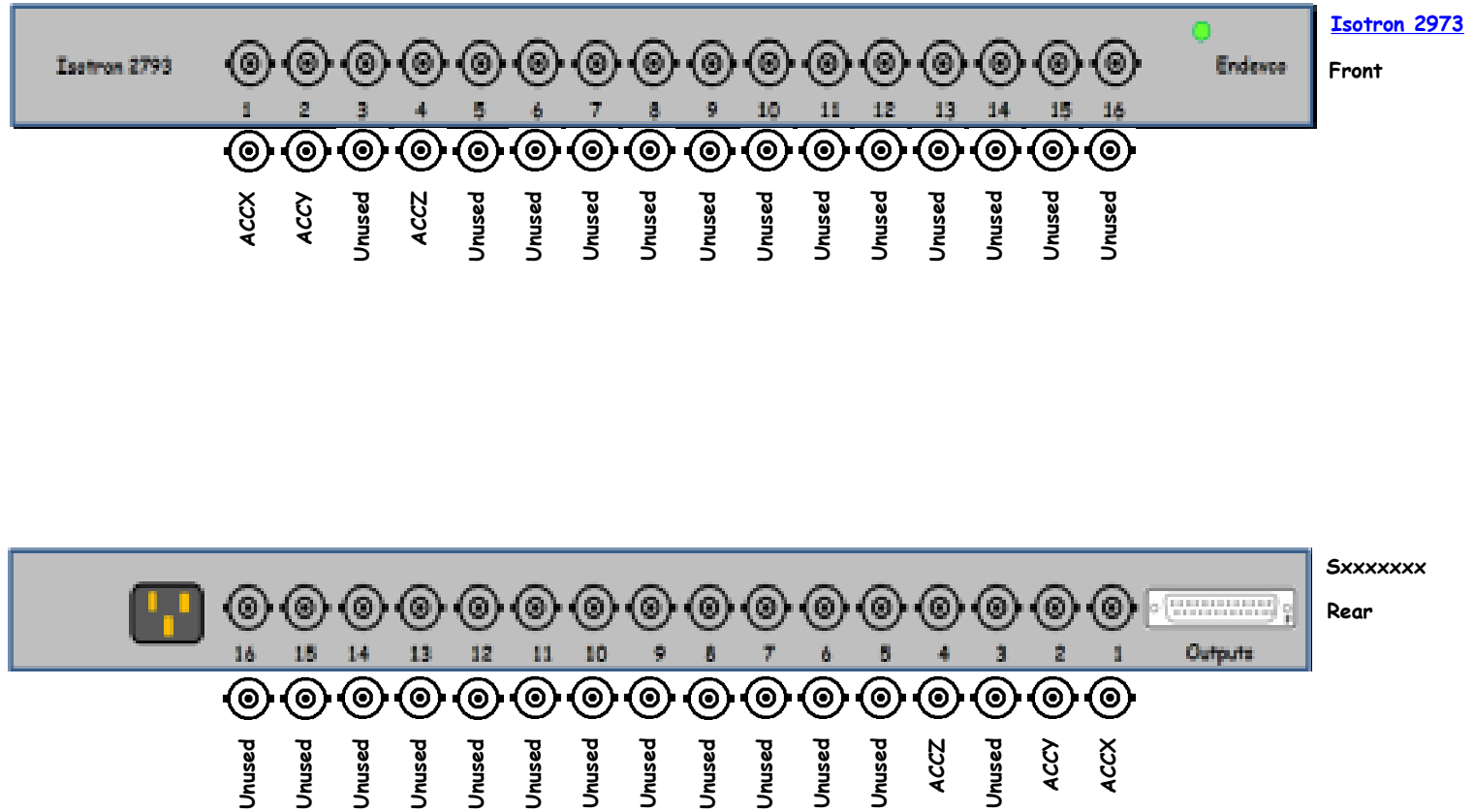

aLIGO 18 Bit AI Interface Chassis

D1101785

S1300252

±18VDC

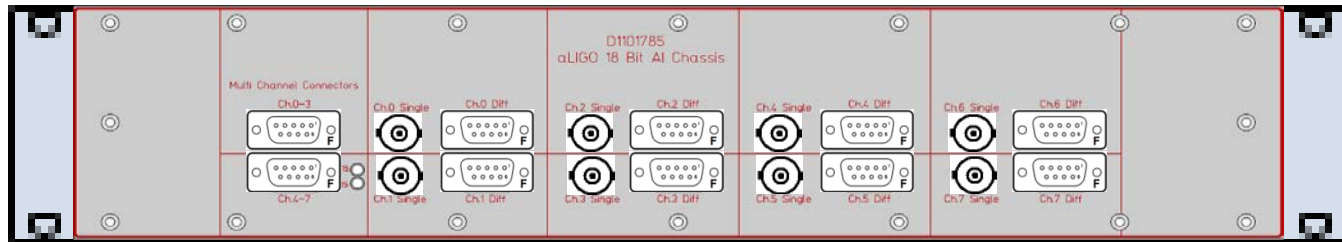

D1101785

Front

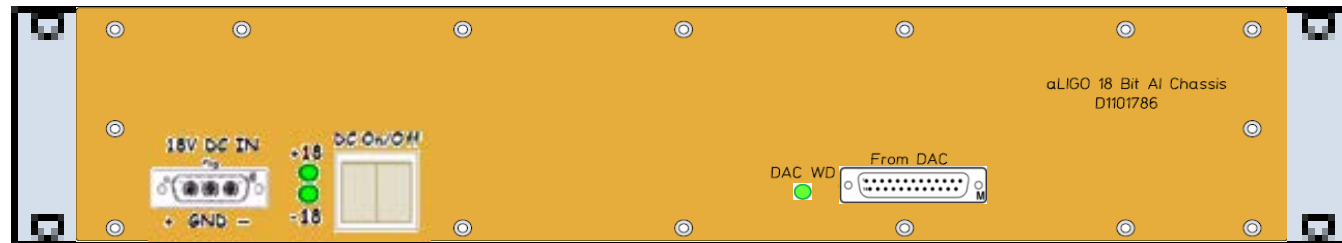
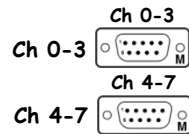

S1300252

Rear



<< L1-OAF-C1

aLIGO AA Interface Chassis
(32 BNC, x10 Gain Version)

[D1001421](#)

[S1001057](#) :

±18VDC

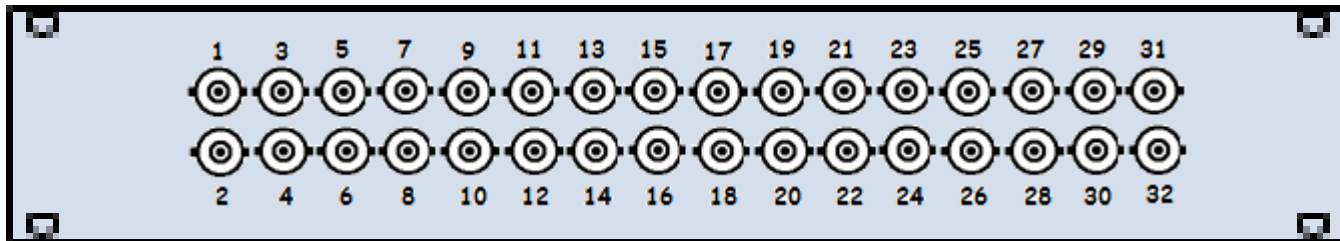

[D1001421](#)

Front

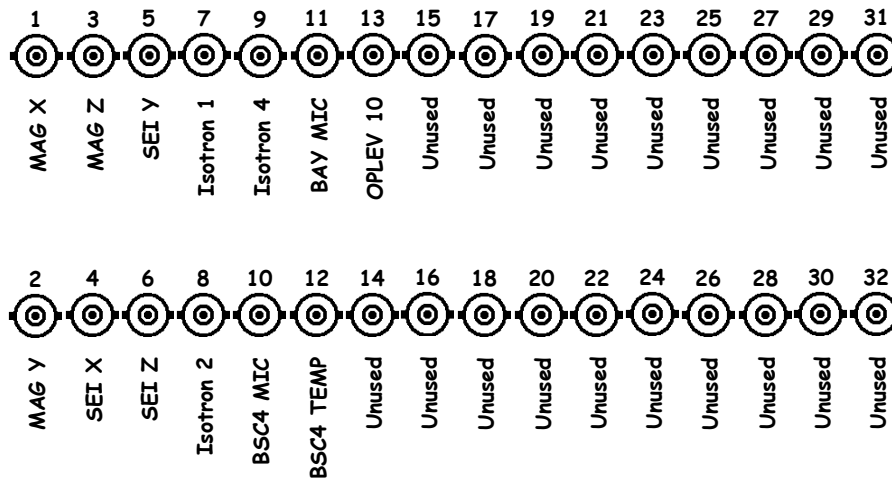

[S1001057](#)

Rear

[To I1oaf0 Slot P1](#)

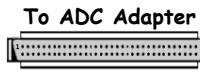

To ADC Adapter

L1 PEM Sensor Details

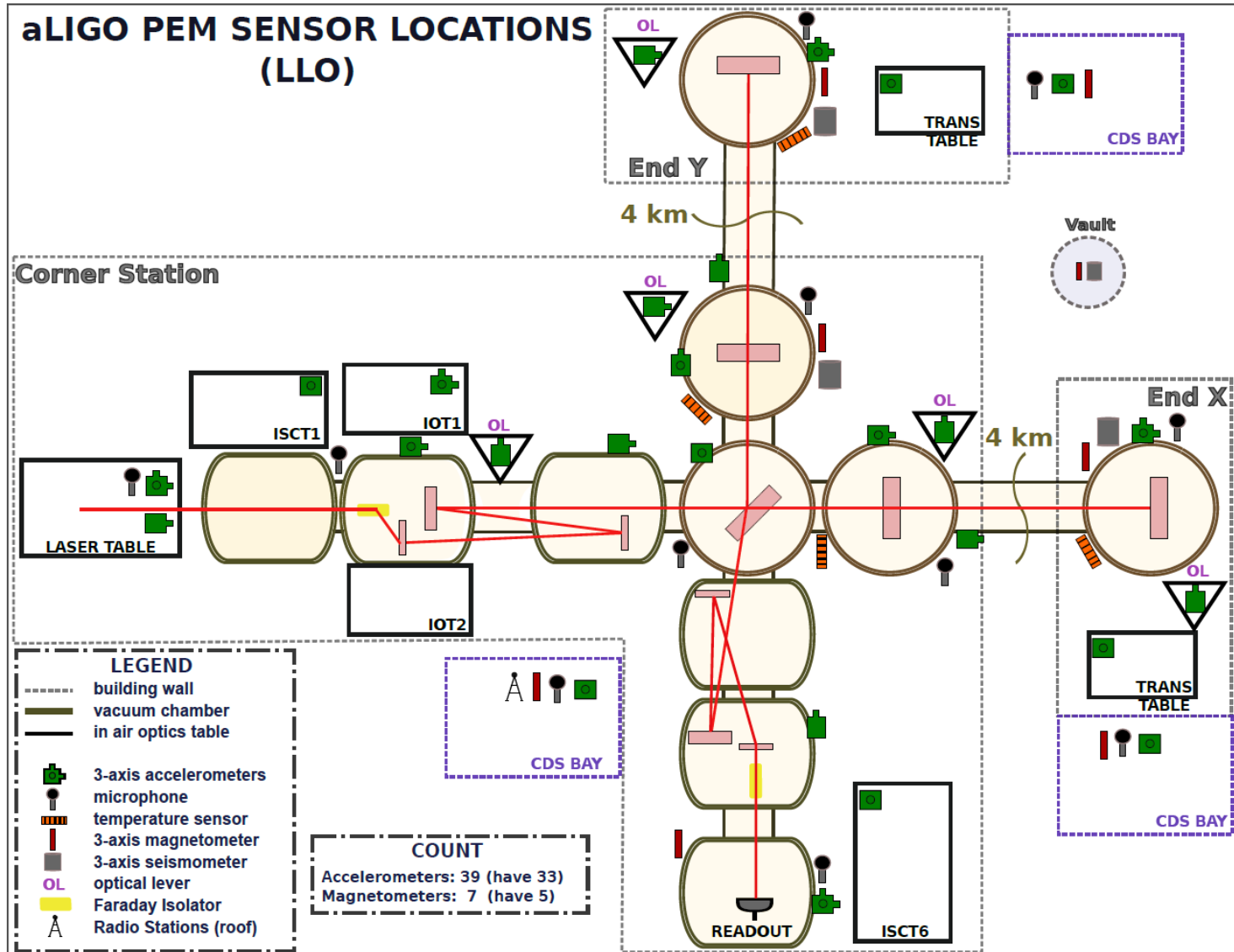

D1200615

- **Accelerometers**
 - $10^{-8} f^{-2} \text{ m Hz}^{-1/2}$
 - 10-200Hz (256Hz, 16bit)
- **Seismometers**
 - $3 \times 10^{-10} f^{-2} \text{ m Hz}^{-1/2}$
 - 0-10 Hz (256Hz, 16bit, 3 axis)
- **Microphones**
 - $10 \text{ Pa Hz}^{-1/2}$
 - 10-1000Hz (2048Hz, 16bit)
- **RF receivers**
 - $10 \mu\text{V/m}$
 - 1.3GHz (2048Hz, 6x16bit)
- **Residual Gas in Vacuum System**
- **Vacuum contamination Monitor**
- **Weather Station**
 - T (1K), RH (10%), precipitation (10%), Wind (1mph)

- **Tiltmeters**
 - $2 \times 10^{-9} f^{-2} \text{ rad Hz}^{-1/2}$
 - 0-10Hz (256Hz, 16bit, 2 axis)
- **Dust Monitors**
- **Muon (Charged Particle) Detector**
 - $10^{-4} \mu/\text{s}/\text{m}^2$
 - 1 msec (2048Hz, 16bit)
- **Cosmic Rays**
- **Magnetometer**
 - $2 \times 10^{-11} \text{ T.Hz}^{-1/2}$
 - 1 kHz (2048Hz, 3x16bit)
- **Coil magnetometer**
 - $2 \times 10^{-12} \text{ T.Hz}^{-1/2}$
 - 1 kHz (2048Hz, 16bit)
- **Scintillator detector**
- **Power Line Monitor**

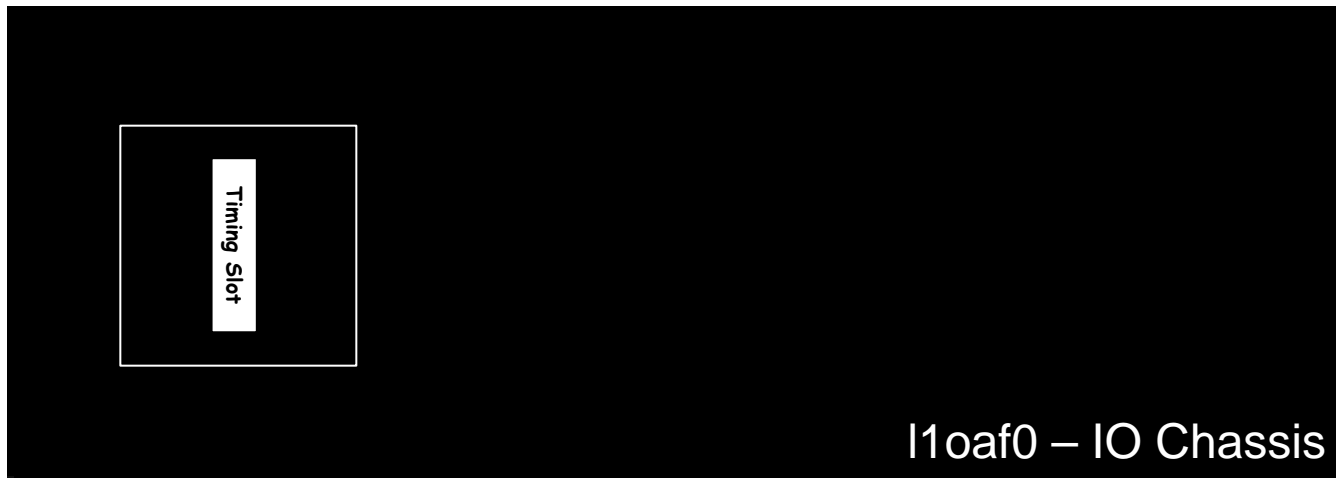

D1001715
Front

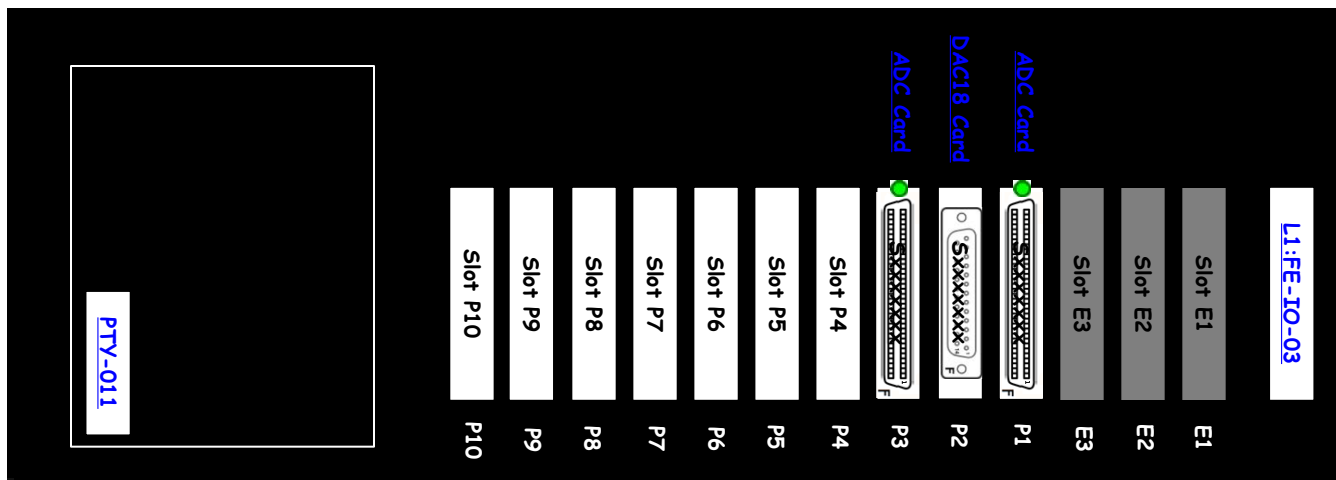

S1103894
Rear

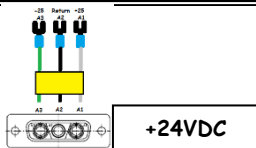
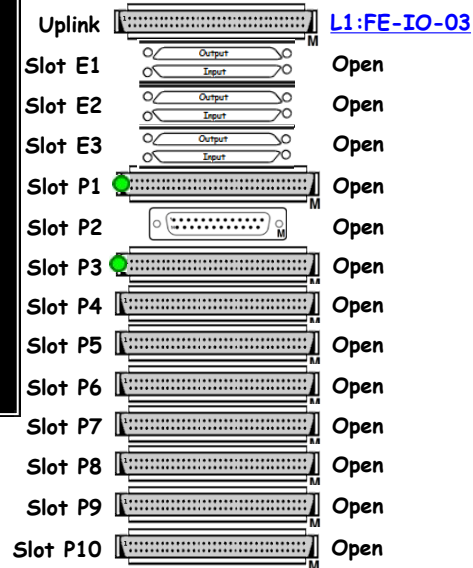

PCIe to Fiber Cable Adapter



Accelerometers (1)

1X5
1X20
1Y20

Isotron Power Supply Model 2793 has 16 channels
This model does NOT come with a DC option.
There is a 3-channel Power Supply that has a DC option,
but it has many other features not desired.

It appears that a short (6") 10-32 to BNC cable can be ordered, but
care should be given to strain relief considerations.

Only Wilcoxon Accelerometers are used for PEM

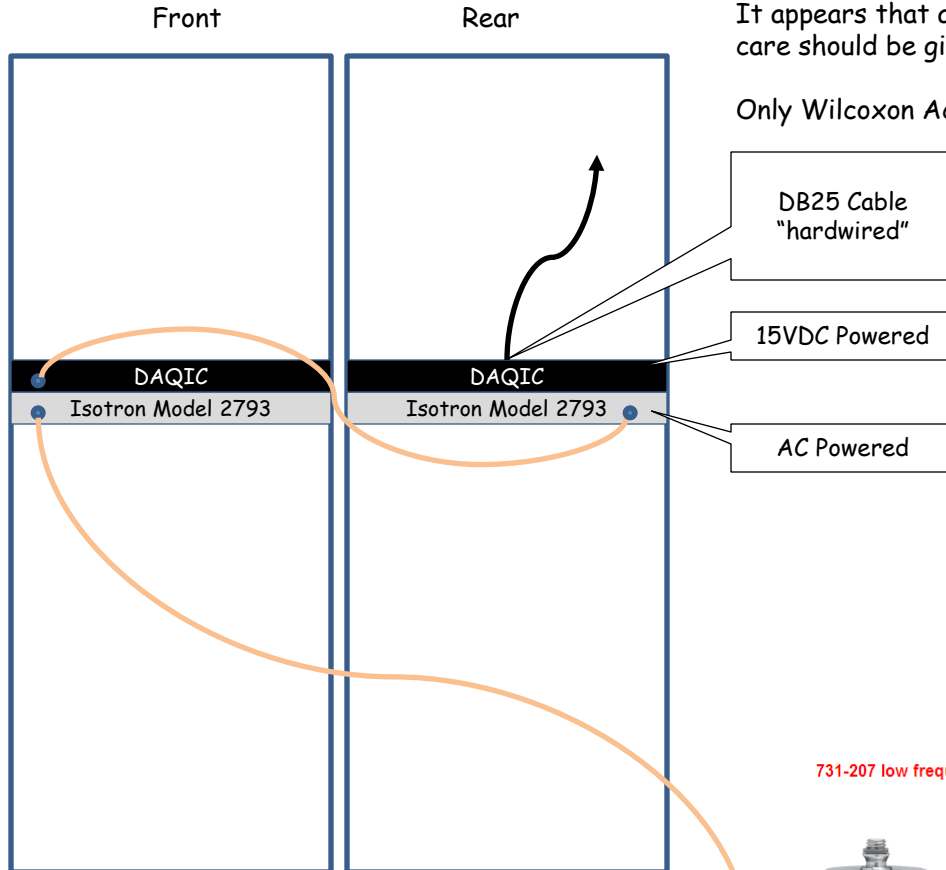

Accelerometer locations:

- | | |
|-----------------------|-------------------|
| 1) PSL X | 16) BSC1 X |
| 2) PSL Y | 17) BSC1 Y |
| 3) PSL Z | 18) BSC1 Z |
| 4) ISCT1 X | 19) BSC2 X |
| 5) ISCT1 Y | 20) BSC2 Y |
| 6) ISCT1 Z | 21) BSC2 Z |
| 7) HAM1 X | 22) BSC3 X |
| 8) HAM1 Y aka HAM6 X | 23) BSC3 Y |
| 9) HAM1 Z | 24) BSC3 Z |
| 10) HAM2 X | 25) HAM6 X |
| 11) HAM2 Y aka HAM6 Y | 26) HAM6 Y |
| 12) HAM2 Z | 27) HAM6 Z |
| 13) HAM3 X | 28) BSC4 X (VEAX) |
| 14) HAM3 Y aka HAM6 Z | 29) BSC4 Y (VEAX) |
| 15) HAM3 Z | 30) BSC4 Z (VEAX) |
| | 31) BSC5 X (VEAY) |
| | 32) BSC5 Y (VEAY) |
| | 33) BSC5 Z (VEAY) |

731-207 low frequency seismic accelerometer

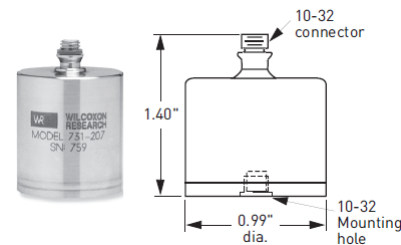

Accelerometer
(in the field)

731-207 low frequency seismic accelerometer

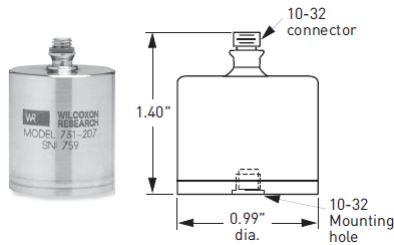

3061

The Endevo model 3061 cable is a non-low noise treated version of the 3090CM12 cable assembly. This cable has a male 10-32 miniature coax connector at one end and a male BNC at the other. The model 3061 is temperature rated from -85°F to +350°F.

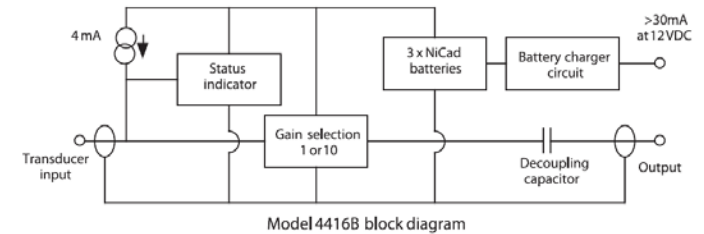
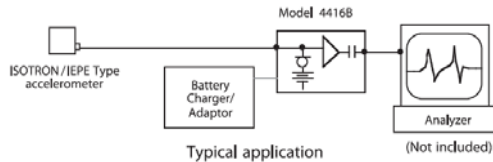
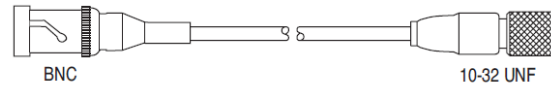

Notes:

1. For ultra-low noise application, model 4416BM1 offers the same basic design without the gain stage.

Avoiding ground loops

In order to provide proper shielding and prevent ground loops, shield and common grounding should be carefully considered. Ground loops are developed when a common line (i.e. signal return/shield) is grounded at two points of differing electrical potential.

For sensors with coaxial cable, the center conductor carries the signal and power, while the outer braiding provides the shielding and signal return. Normally the cable shield is electrically isolated from the sensor housing. This isolates the shield from the mounting point of the machine and prevents ground loops. If a non-isolated sensor is used, it is recommended that an isolated mounting pad be used to break up possible ground loops.

For sensors using two conductor/shielded cable, the signal and power are carried on one lead and the signal common on the other. The cable shield serves to protect the signal from Electrostatic Discharge (ESD) and Electromagnetic Interference (EMI). The shield should be grounded at only one point, normally to the readout equipment.

In all cases, it is very important that the cable shield terminations be properly grounded. Failure to do so in high ESD/EMI environments can result in damage to the sensor electronics.

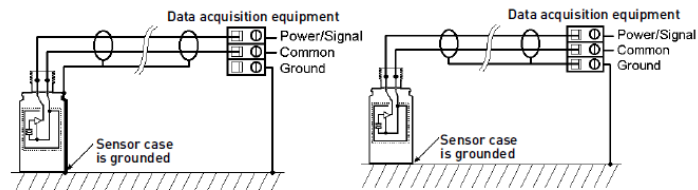

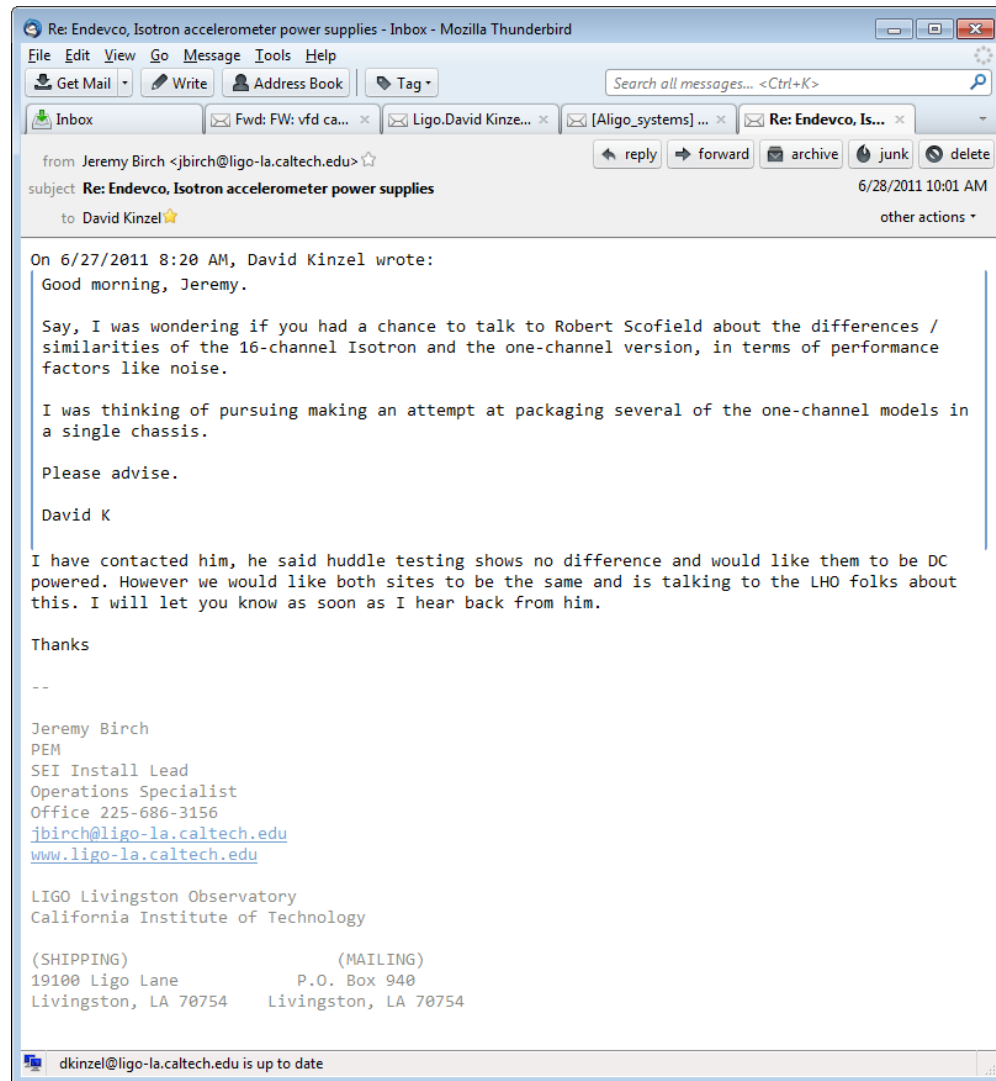

Re: Endeveco, Isotron accelerometer power supplies - Inbox - Mozilla Thunderbird

File Edit View Go Message Tools Help

Get Mail Write Address Book Tag Search all messages... <Ctrl+K>

Inbox Fwd: FW: vfd ca... Ligo.David Kinze... [Aligo_systems] ... Re: Endeveco, Is...

from Jeremy Birch <jbirch@ligo-la.caltech.edu>

subject **Re: Endeveco, Isotron accelerometer power supplies** 6/28/2011 10:01 AM

to David Kinzel

reply forward archive junk delete other actions

On 6/27/2011 8:20 AM, David Kinzel wrote:

Good morning, Jeremy.

Say, I was wondering if you had a chance to talk to Robert Scofield about the differences / similarities of the 16-channel Isotron and the one-channel version, in terms of performance factors like noise.

I was thinking of pursuing making an attempt at packaging several of the one-channel models in a single chassis.

Please advise.

David K

I have contacted him, he said huddle testing shows no difference and would like them to be DC powered. However we would like both sites to be the same and is talking to the LHO folks about this. I will let you know as soon as I hear back from him.

Thanks

--

Jeremy Birch
PEM
SEI Install Lead
Operations Specialist
Office 225-686-3156
jbirch@ligo-la.caltech.edu
www.ligo-la.caltech.edu

LIGO Livingston Observatory
California Institute of Technology

(SHIPPING) (MAILING)
19100 Ligo Lane P.O. Box 940
Livingston, LA 70754 Livingston, LA 70754

dkinzel@ligo-la.caltech.edu is up to date

- There are two antennas of interest.
- 1) Roof Antenna
 - 2) CDS High-bay Antenna

The Roof Antenna

- 1) Receiver is located in the MSR
- 2) 219.84 MHz FM

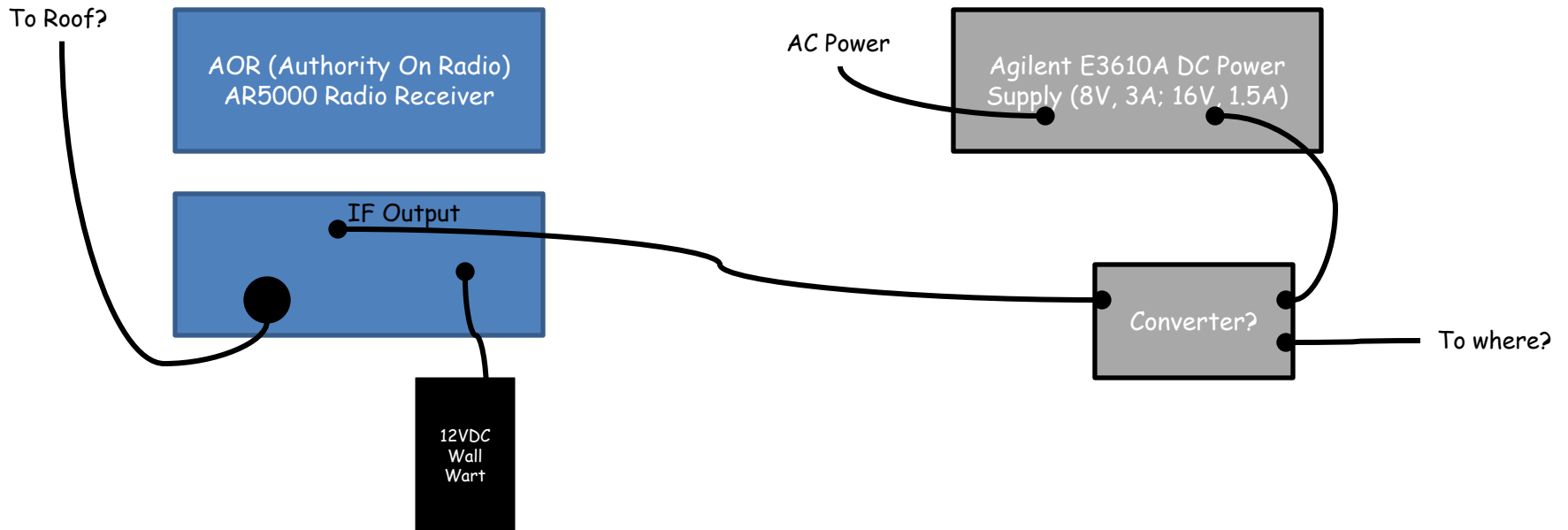



Humidity sensor locations
1) Room 172 - LDR Changing Room

Relative Humidity/Temperature Transmitter with dual Voltage or Current Output, Compact Size
Discontinued Product! See Note Below

HX93 Series



- 4-20mA or 0-1V Output
- RH and Temperature Output
- Compact Size for Mounting Versatility
- Watertight Enclosure
- Accurate to 2.5% RH and 0.6°C

Click for [larger image](#).

[To Order](#) [Specs](#)

The HX93 Series is no longer available. Please see the [HX93A Series](#) as a substitute or contact Sales/Temperature Engineering.

(J.) David Barker says this is the Siemens System



Magnetometer (1)

Magnetometer: Bartington Instruments
MAG-03MC

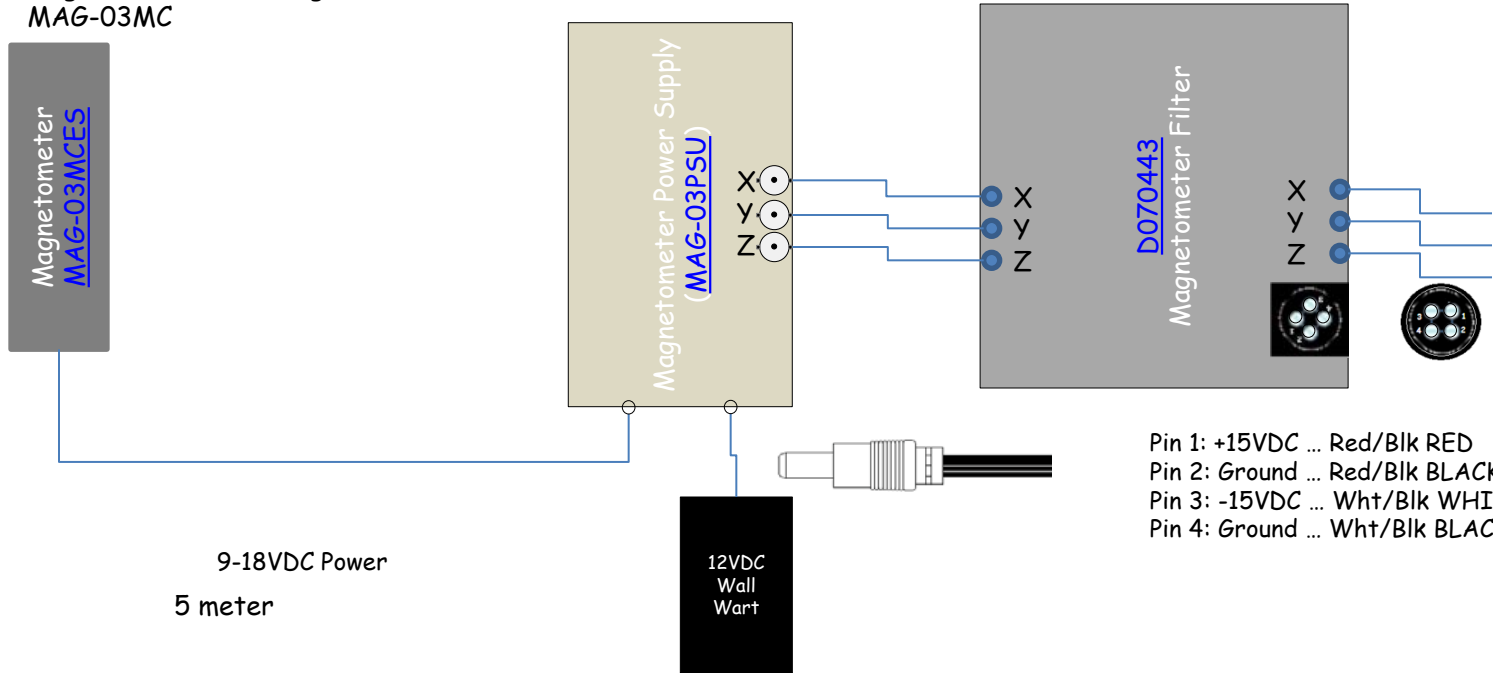

9-18VDC Power
5 meter

- Pin 1: +15VDC ... Red/Blk RED
- Pin 2: Ground ... Red/Blk BLACK
- Pin 3: -15VDC ... Wht/Blk WHITE
- Pin 4: Ground ... Wht/Blk BLACK



D030574
T1100382

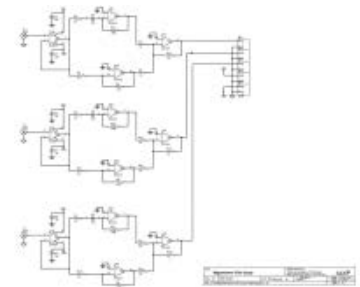

Magnetometers (2) Filter Schematic

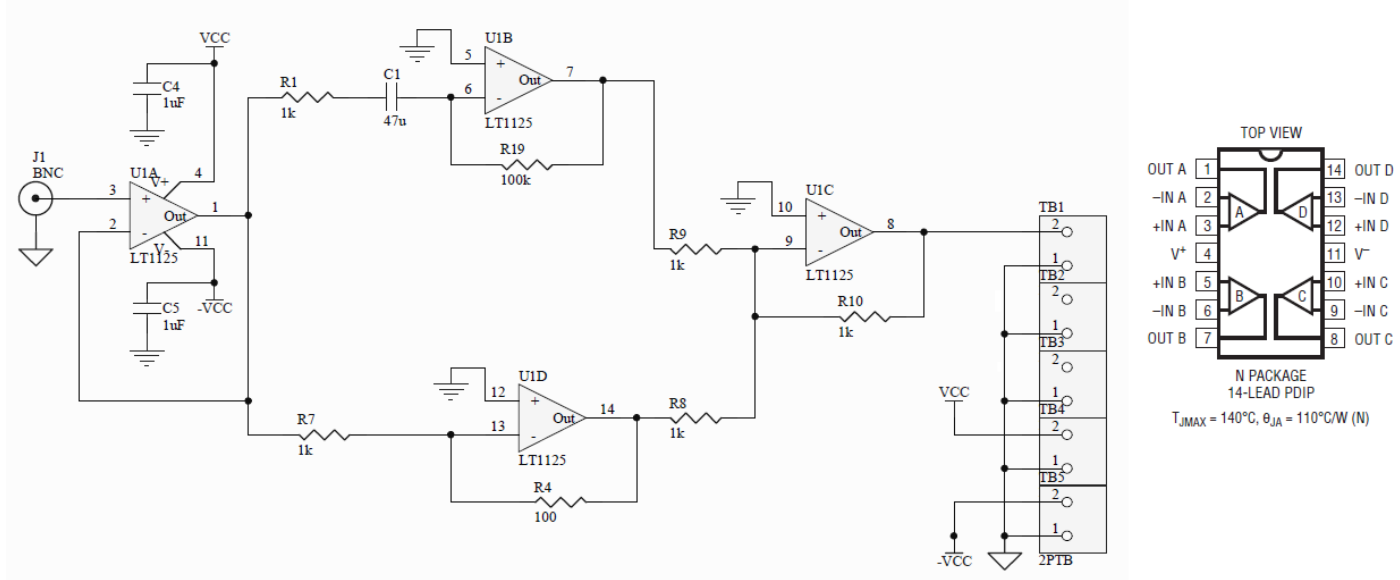

[D030574](#)

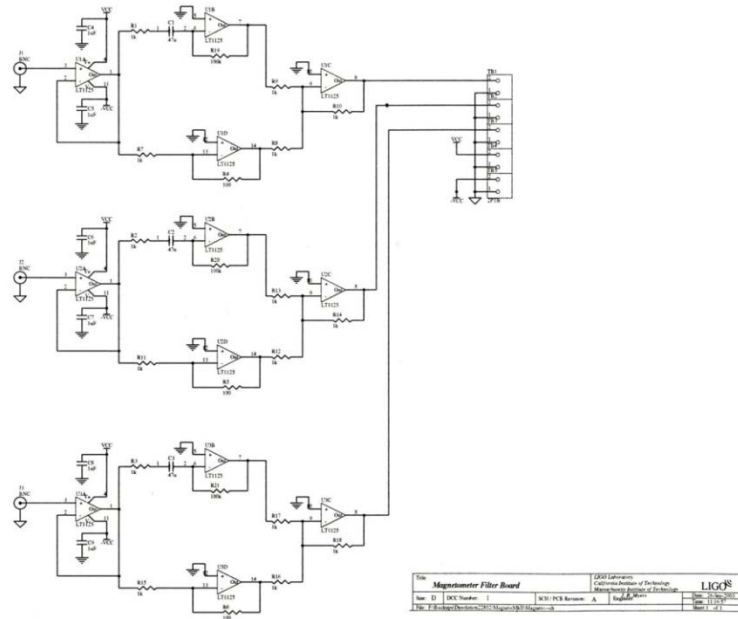

Magnetometers (3) Amplifier Sketch

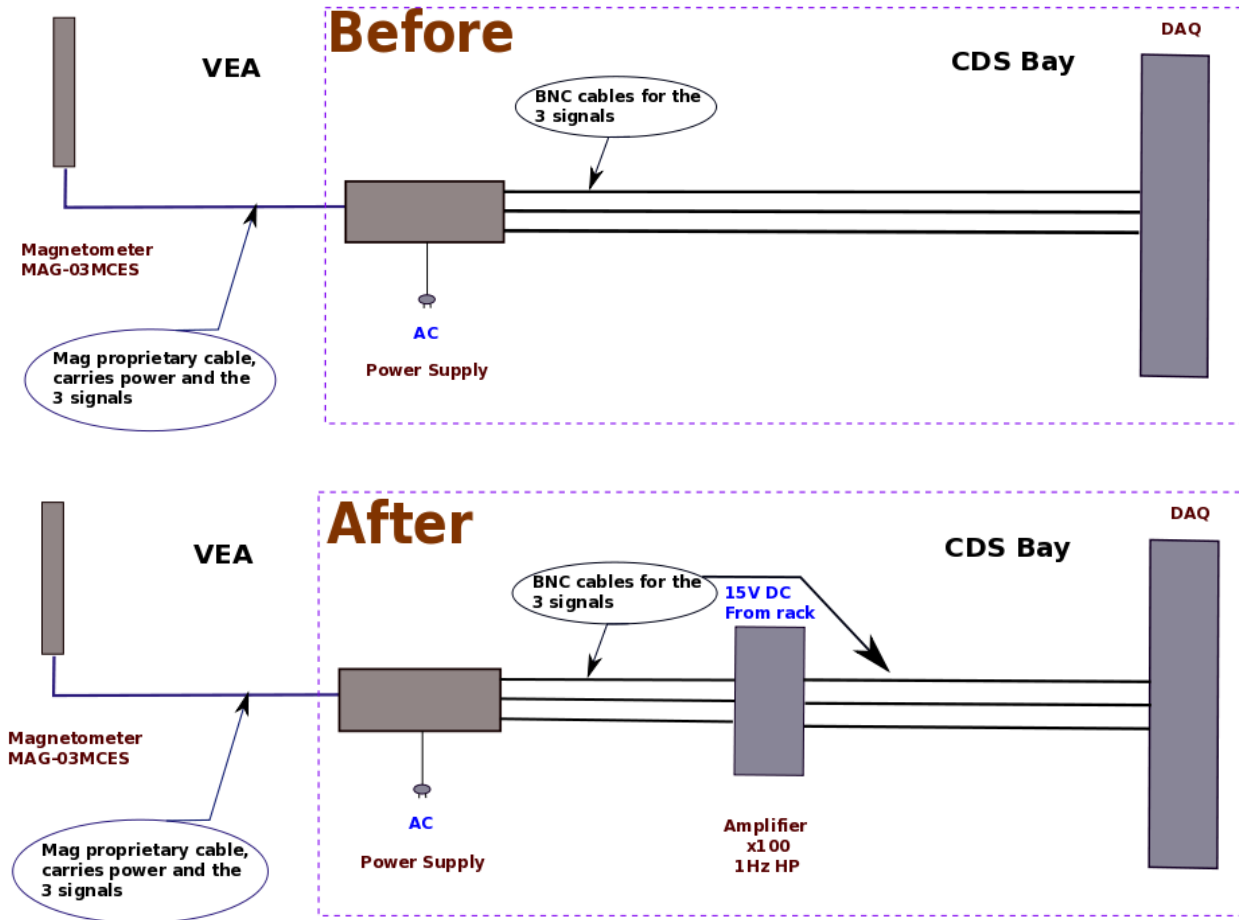

Microphone locations / Pair

- 1) PSL / ISCT1
- 2) ISCT1 / PSL
- 3) HAM1 / HAM3
- 4) HAM3 / HAM1
- 5) BSC2 (aka LVEA) / HAM6
- 6) BSC1 / BSC3
- 7) BSC3 / BSC1
- 8) HAM6 / LVEA
- 9) BSC4 (X) / not paired
- 10) BSC5 (Y) / not paired
- 11) LSR (aka CDS High-bay) / not paired
- 12) VEAX Bay Mic / not paired
- 13) VEAY Bay Mic / not paired

The Manufacturer is Bruel & Kjaer

Since the power supply handles two microphones, the microphones are 'paired' in certain places.

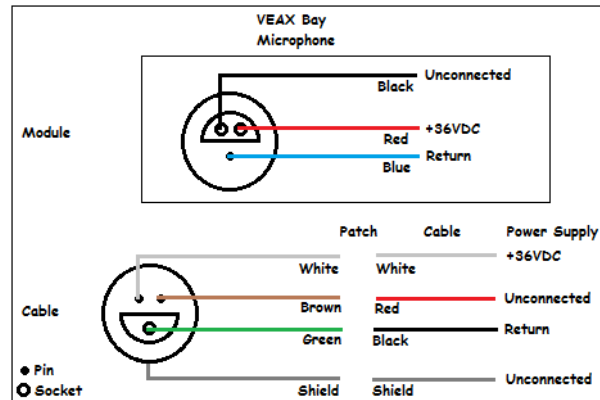

Extension cables are available - 3m, 10m, and 30m

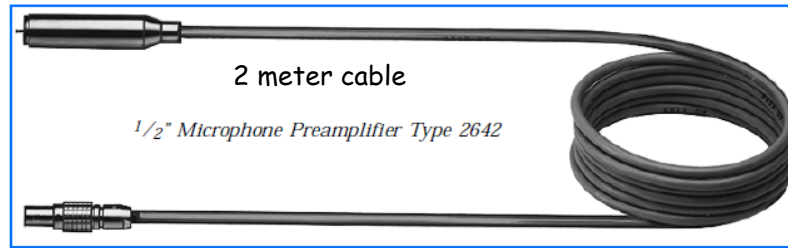

Microphones - Power Adaptor Cable

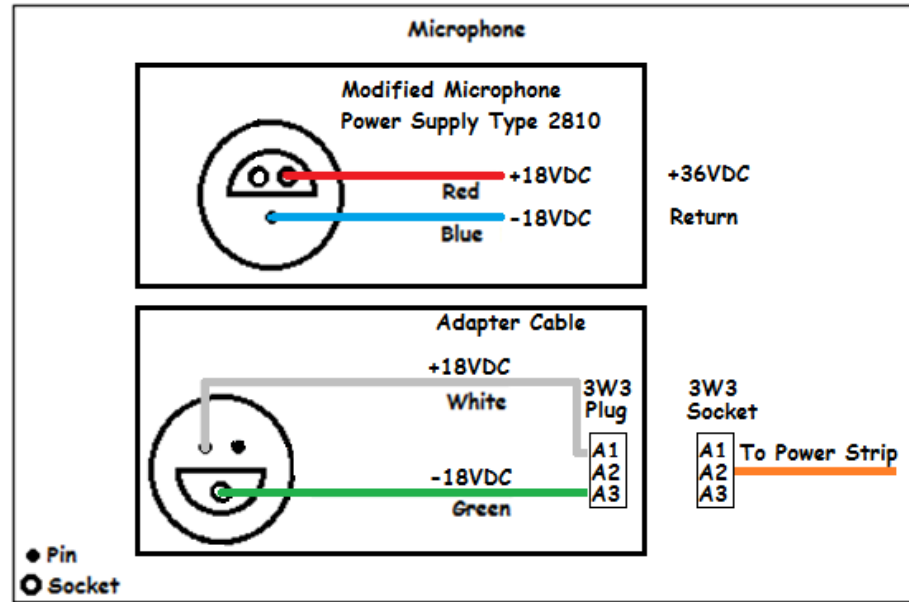

Particle Counters (Dust Monitors)

Dust Monitors are not on during Science Mode due to the acoustic noise. This noise is the air pump. It is always on.

The manufacturer is Pacific Scientific
 Old ones (being replaced) are MET One 227B. (9VDC)
 New ones (replacements) are MET One GT-321. (9VDC, 2A)

These are scattered throughout the LVEA and usually two of them share a power supply via a cable to a junction box. They are powered from the serial interface port. Not sure if this is a homemade adaptation.

The Junction Box needs documentation.

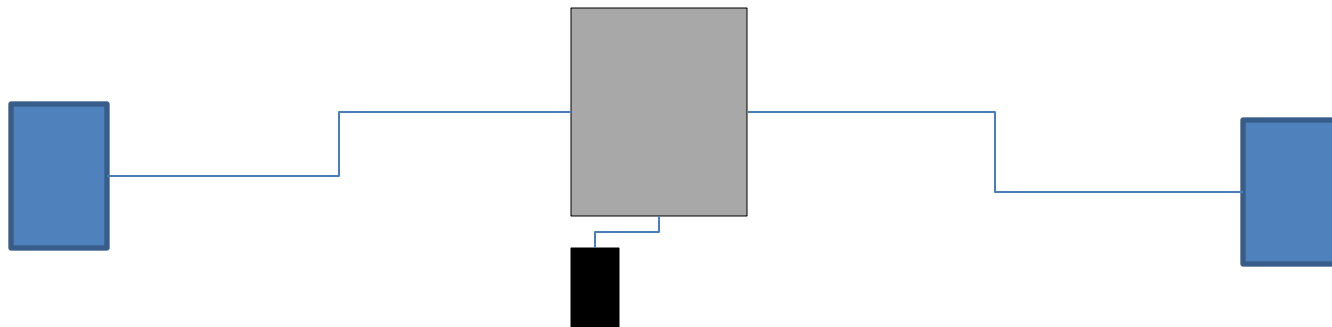
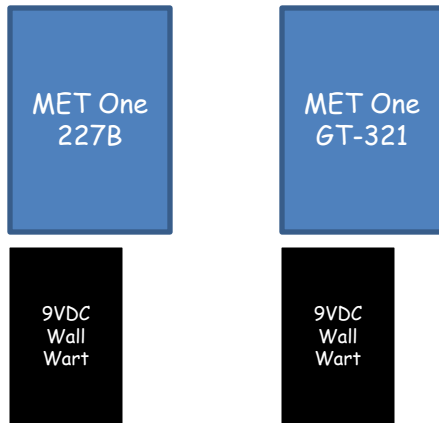

Control DeviceMaster with DB9 Ports

Control DeviceMaster 4 with DB9 Ports

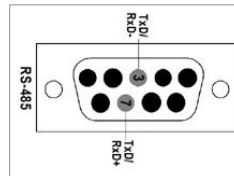

4-Port Power Supply

This table provides the specifications for the power supply shipped with the DeviceMaster 4-port.

Control Power Supply: 4-Port	
Input line frequency	47 - 63 Hz
Input line voltage	90 - 260 VAC
Output voltage	24VDC
Output current	500 mA @ 24VDC



Housing Molex P/N:
39-01-4030
Pins Molex P/N:
44485-1211



3M Shell 3357-9209



2.1mm Socket
(Note polarity)

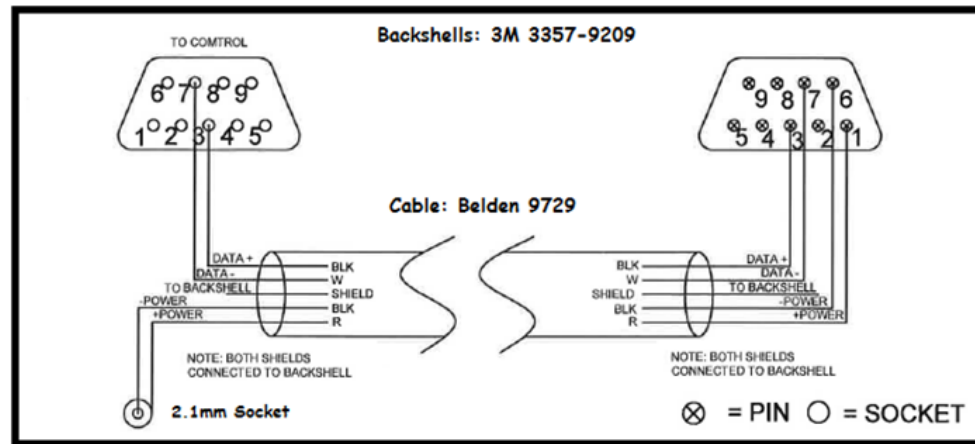

3M Shell 3357-9209

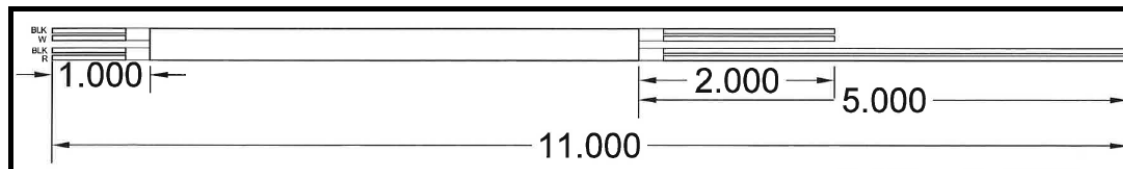



3M Shell 3357-9209



2.1mm Socket
(Note polarity)

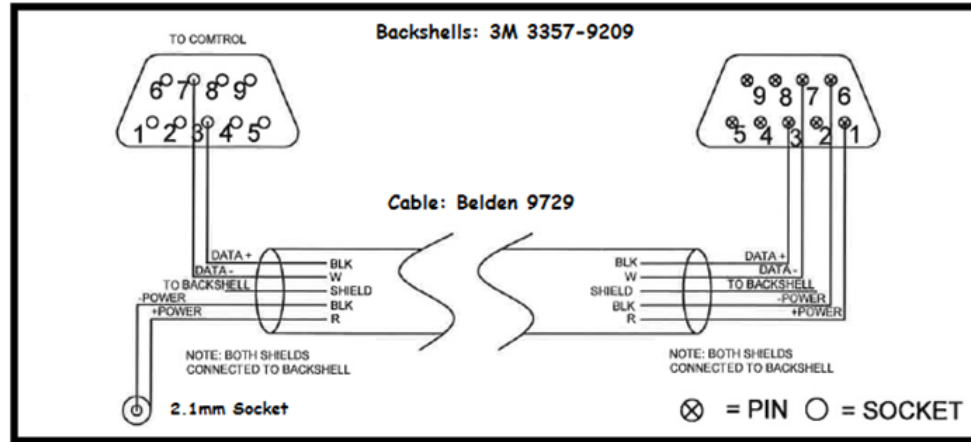

3M Shell 3357-9209

This cable is configured to carry both DC Power and RS485 Signals. The 2.1mm Socket can come from a commercially available 2.1mm Cable Assembly. Note the center pin of the 2.1mm is NEGATIVE. And both shields are tied together and tied to both backshells.

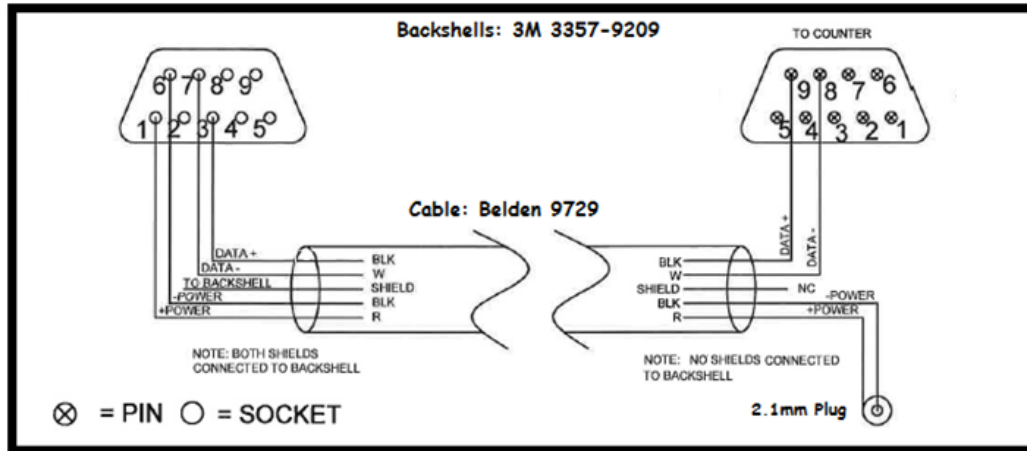

2.1mm Plug
(Note polarity)

This cable is configured to carry both DC Power and RS485 Signals. The 2.1mm Plug can come from a commercially available 2.1mm Cable Assembly. Note the center conductor of the 2.1mm is NEGATIVE. And both shields are tied together and are tied only to the backshell that connects to the cable. The backshell connected to the Particle Counter is NOT tied to the shields.

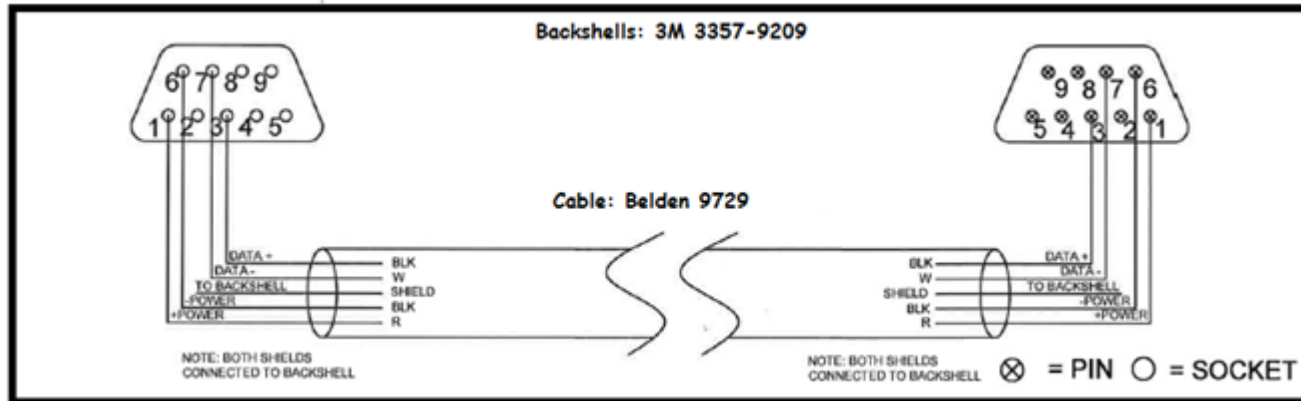

This cable is configured to carry both DC Power and RS485 Signals. Note that both shields are tied together and tied to both backshells.

It is 70' from the L1-FAC-XC1 Rack to the knee of the waterfall in the VEAX.

It is 65' from the L1-FAC-YC1 Rack to the knee of the waterfall in the VEAY.

3M Backshell Assembly

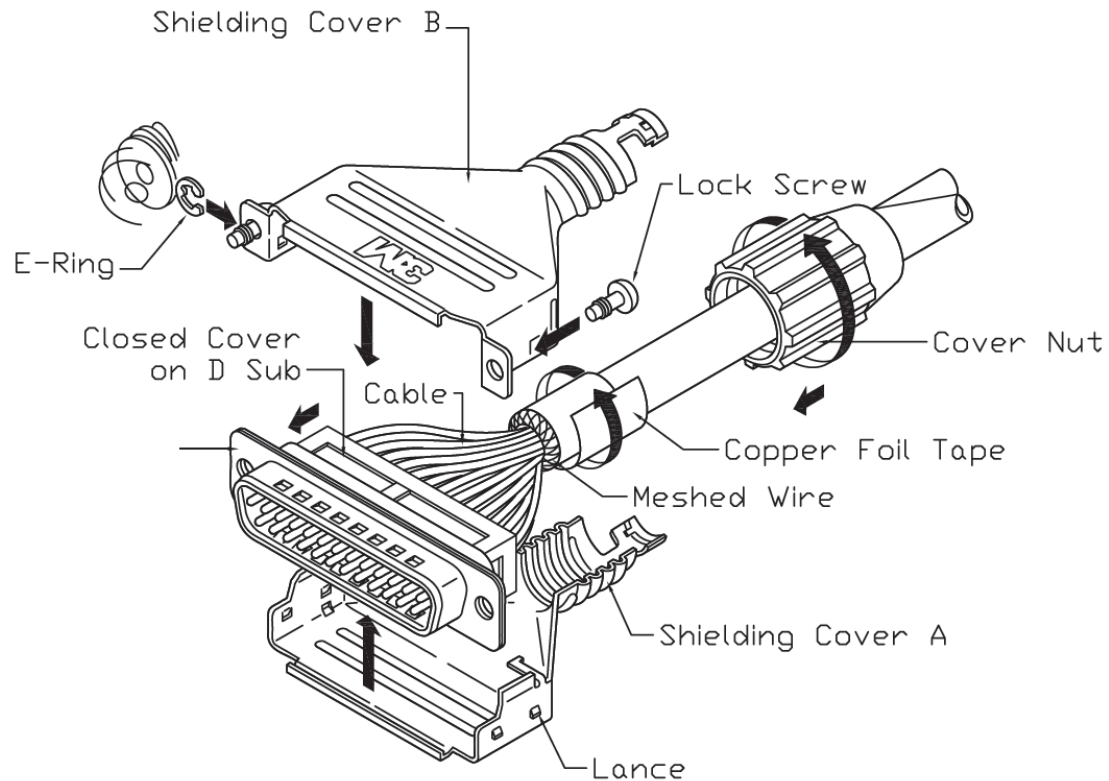

This is a sample drawing of the 3M backshell showing how the E-Ring is attached to the Lock Screw, and showing how the Cover Nut holds the backshell in place.

Particle Counters (Met One 227B)



Model 227 Series Hand-Held Particle Counter
With Temperature/Relative Humidity Probe

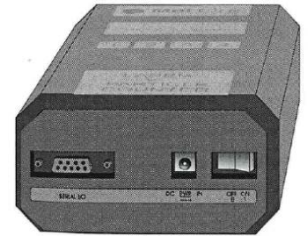
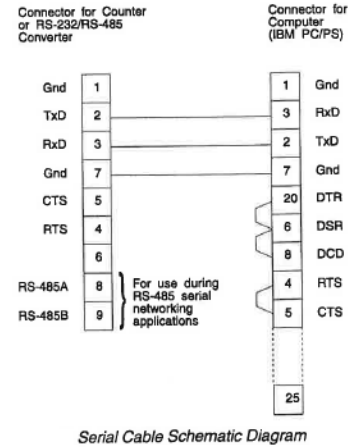

3M Shell 3357-9209

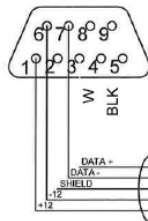

Belden 9729

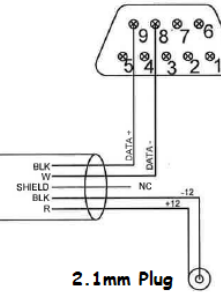

3M Shell 3357-9209

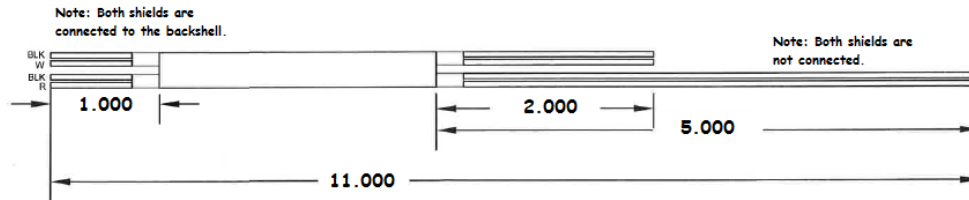

⊗ = PIN ○ = SOCKET



2.1mm Plug
(Note polarity)

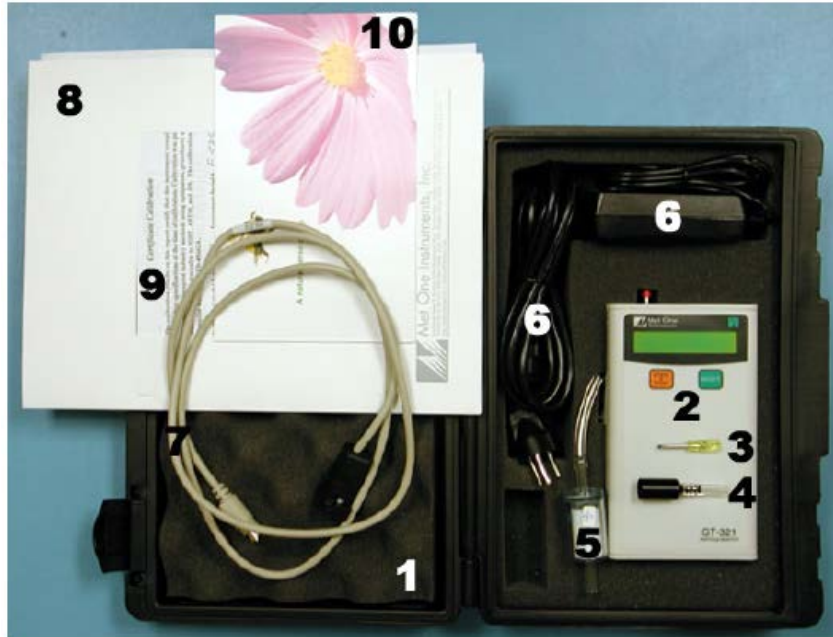

1. Carrying case
2. GT-321 Hand Held Particle Counter
3. Miniature screwdriver
4. Iso-kinetic Sample Probe with a short piece of tubing
5. Zero Particulate Filter (Met One Part Number G3111)
6. Universal AC to DC converter module with IEC AC power cord
7. RS-232 Serial Cable
8. Operation Manual
9. GT-321 Calibration Certificate
10. Color Brochure (optional)

Temperature Sensor locations

- 1) BSC1 (LVEA) - one old, one new
- 2) BSC3 (LVEA)
- 3) BSC4 (VEAX)
- 4) BSC5 (VEAY)

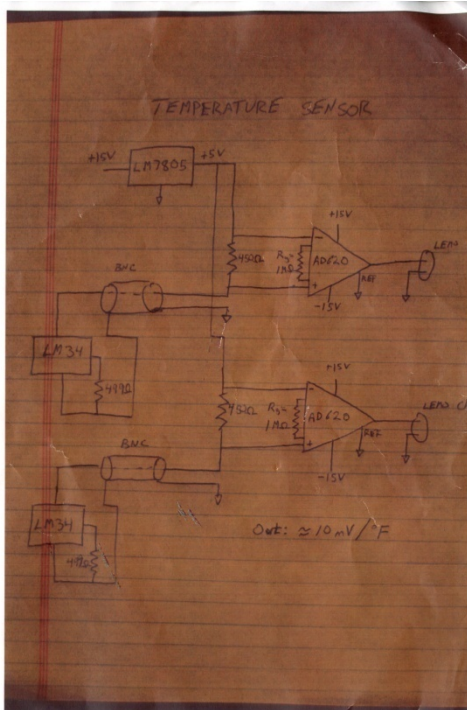

Temperature Sensors include thermocouples:

- 1) Are there any read in the chiller lines? TCS, PSL?
- 2) There are thermocouples in the vacuum system for the N2 tanks.

10:05:43
Tue Jan 9
2007
(Local)

Topic: Commissioning Author: Valera Frolov Tue Jan 9 16:05:43 2007 UTC

Thermocouple readout

According to Rus the thermocouple goes straight to ADC.
The 12 bit ADC is not sensitive enough for the K type Omega thermocouple that has EMF/temp $\approx 40 \mu\text{V}/^\circ\text{C}$.

- Valera Frolov <http://log.ligo-la.caltech.edu/cgi-bin/...> (ref:1)

NO_KEYWORD Add or Remove Keyword: NO_KEYWORD Submit

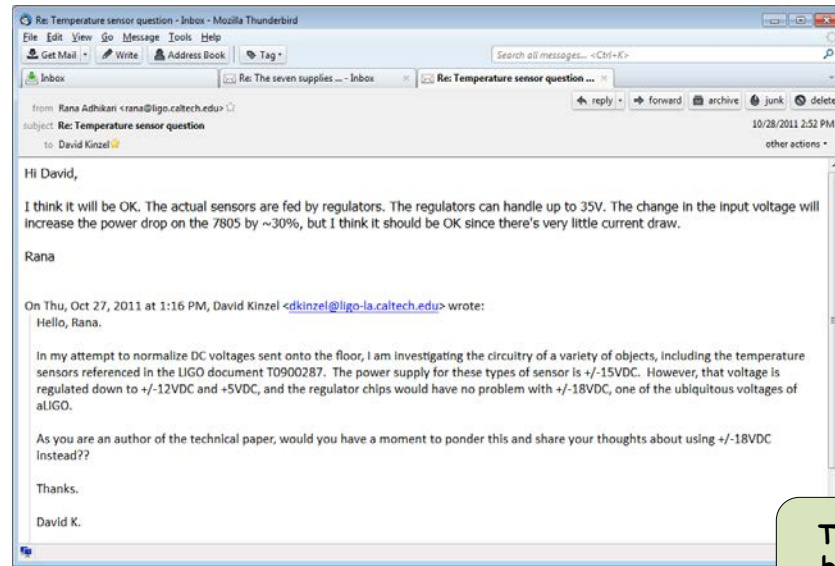

These cables can be replaced with standard +/-18VDC

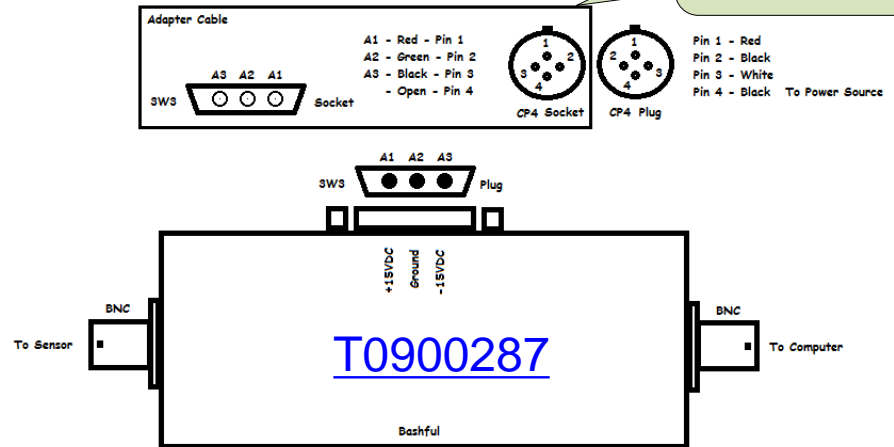

Comments as of 20100525

PEM Voltage Monitor locations:

- 1) LVEA - Rack 1X5 - DAQIC2, BNC Port 13
- 2) VEAX - Rack 1X20 - DAQIC2, BNC Port ?
- 3) VEAY - Rack 1Y20 - DAQIC2, BNC Port 10

This monitor is labeled, "PEM Voltage Monitor No. CAS-Vxx." The circuit board inside says, "LHO EE Power Monitor Board D000TBD." Documentation is scarce. This device is probably OK for monitoring the single balanced power into which it is plugged in Rack 1X5. It is intended to record the differential between the two phases of the balanced power. But if it is used on any 'real' AC circuit, it creates the potential for a $\frac{1}{2}$ line voltage ground loop between neutral and ground, and another between hot and ground.

Additionally, even in the balanced power situation, NEUTRAL is the wrong designation, for none of the conductors is neutral in a balanced power circuit: it is the negative AC power.

The circuit ties all shields together, so current loops exist between 2 potentially different AC circuits.

And also the cable ties all shields together, creating the same problem.

And most ironic, the monitor in Rack 1X5 is NOT being read at all: there is no signal name, but it is plugged in. (This was NOT true in September 2009 when inventory of the DAQIC signals was last taken.)

At the Y-end, the AC cable has only three BNC connectors. Two are connected to the Voltage Monitor box.

At the X-end, the AC cable has all four BNC connectors, but they are cross-connected to the Voltage Monitor Box: Cable HOT1, NEU1, HOT2, NEU2 are connected to Box HOT2, NEU2, HOT1, NEU1 and I did not check the cable for accuracy. I did note it only has 2 wires coming into the CP4 port, however, but which two is not clear.



LHO EE
Power
Monitor
Board
D000TBD?

Voltage Monitor (2)

Photos as of 20100525



Internal Design and Interfaces as of 20100525

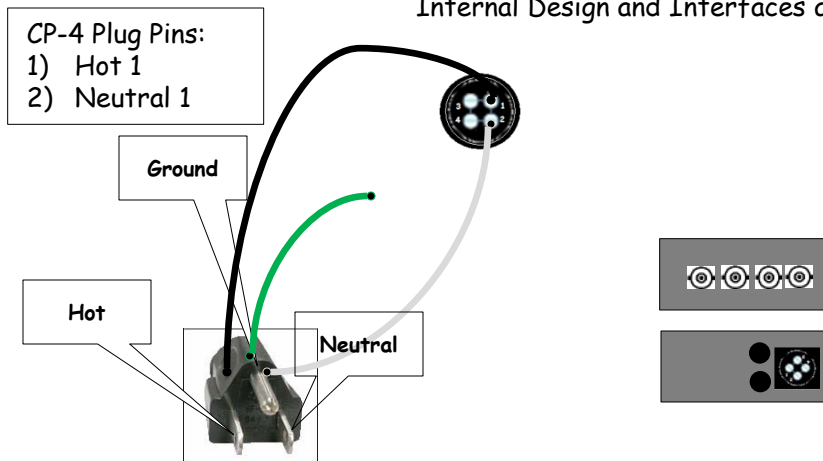

CP-4 Socket Pins:
 1) Hot 1 - fused
 2) Neutral 1
 3) Hot 2 - fused
 4) Neutral 2

R1,R3,R5,R7 = 1M Ω
 R2,R4,R6,R8 = 1k Ω
 Fuse1,2 = 250V, $\frac{1}{4}$ A

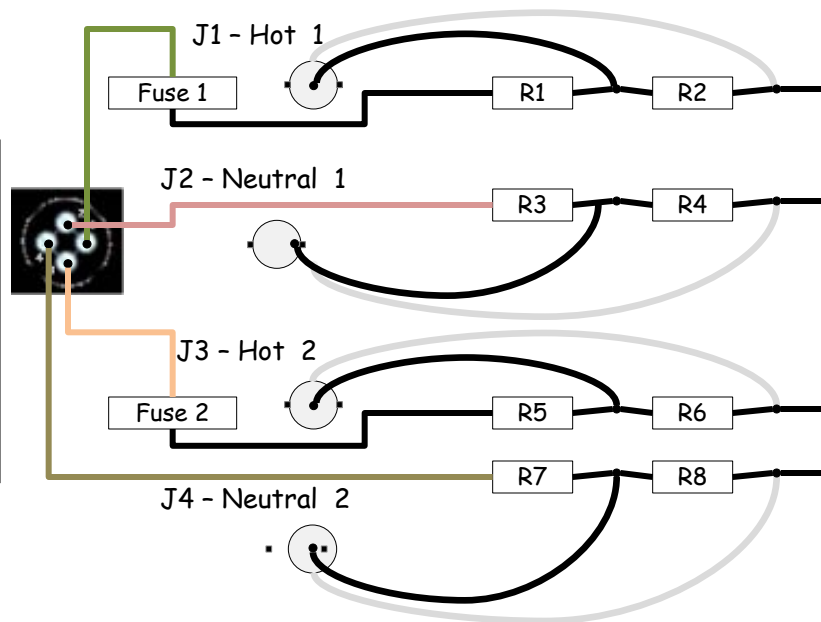

AC Power (input to monitor)
 2 - Fuses - 250V $\frac{1}{4}$ A

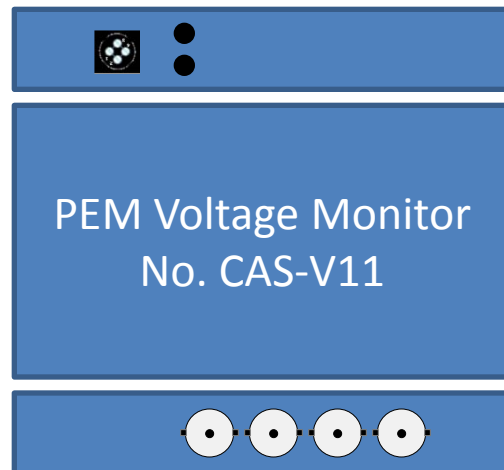

J4 - Neutral 2
 J3 - Hot 2
 J2 - Neutral 1
 J1 - Hot 1

Outputs

Voltage Monitor (4)

Cable design as of 20100525

Cable: From 4 BNC connectors to 4-Pin Lemo on DAQIC-2

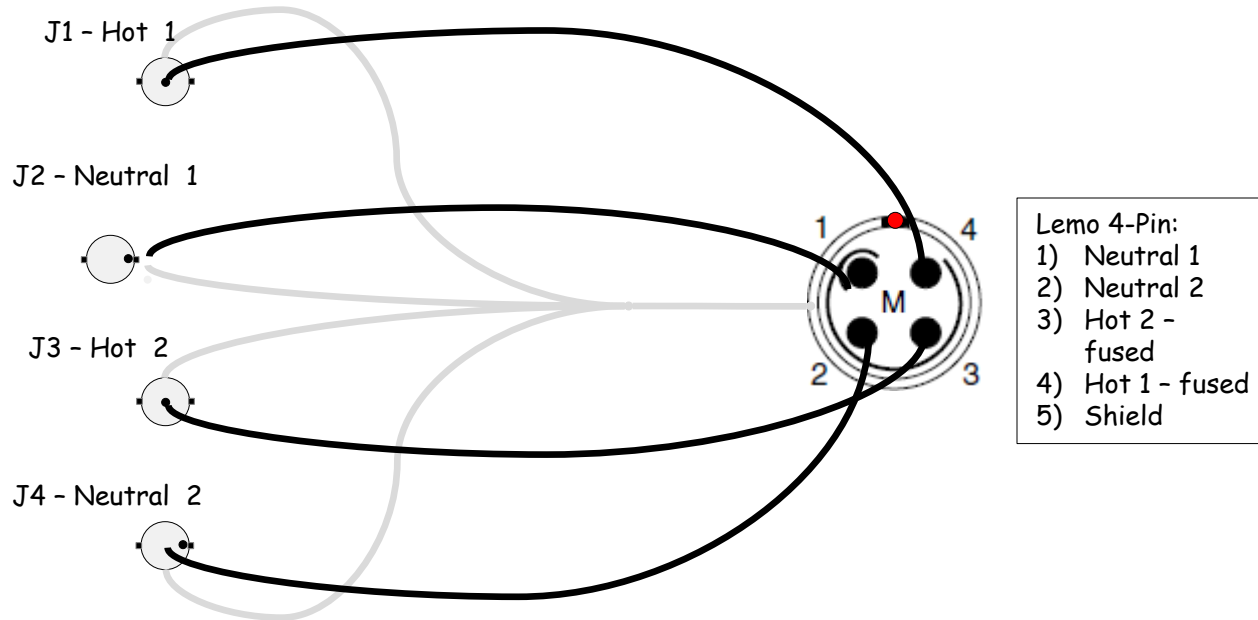

- Lights
- Vacuum Equipment
- Rechargeable Flashlights
- Computer Monitors
- Optical Isolators
- Trouble Lights
- Warning Signs
- Laser Hazard Status Signs
- Laser Danger Signs
- Loudspeakers
- Telephones

Weather Sensor locations

LLO network

LSU network



<< LLO Racks by Subsystem

CDS Electronics Room (CER)

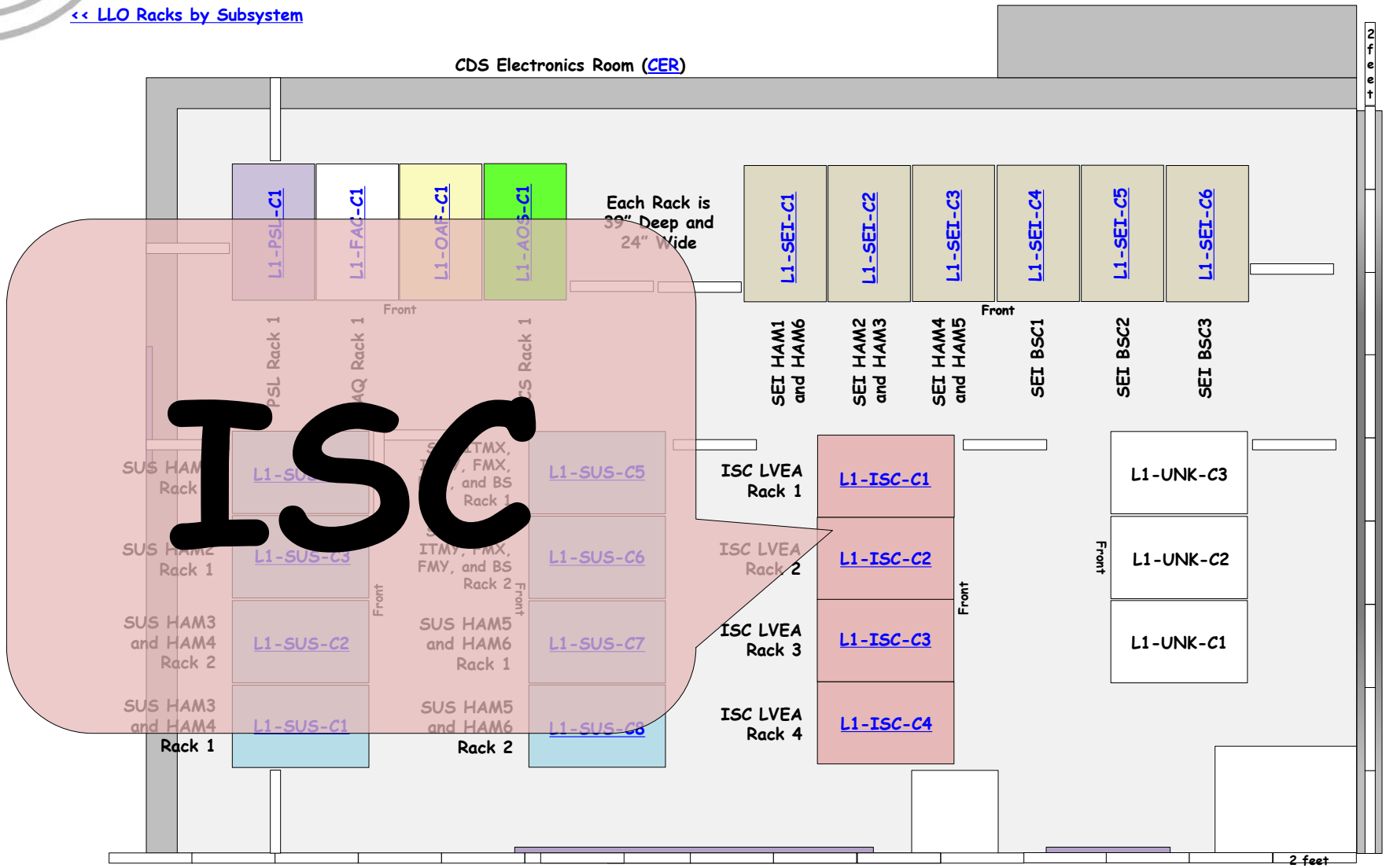

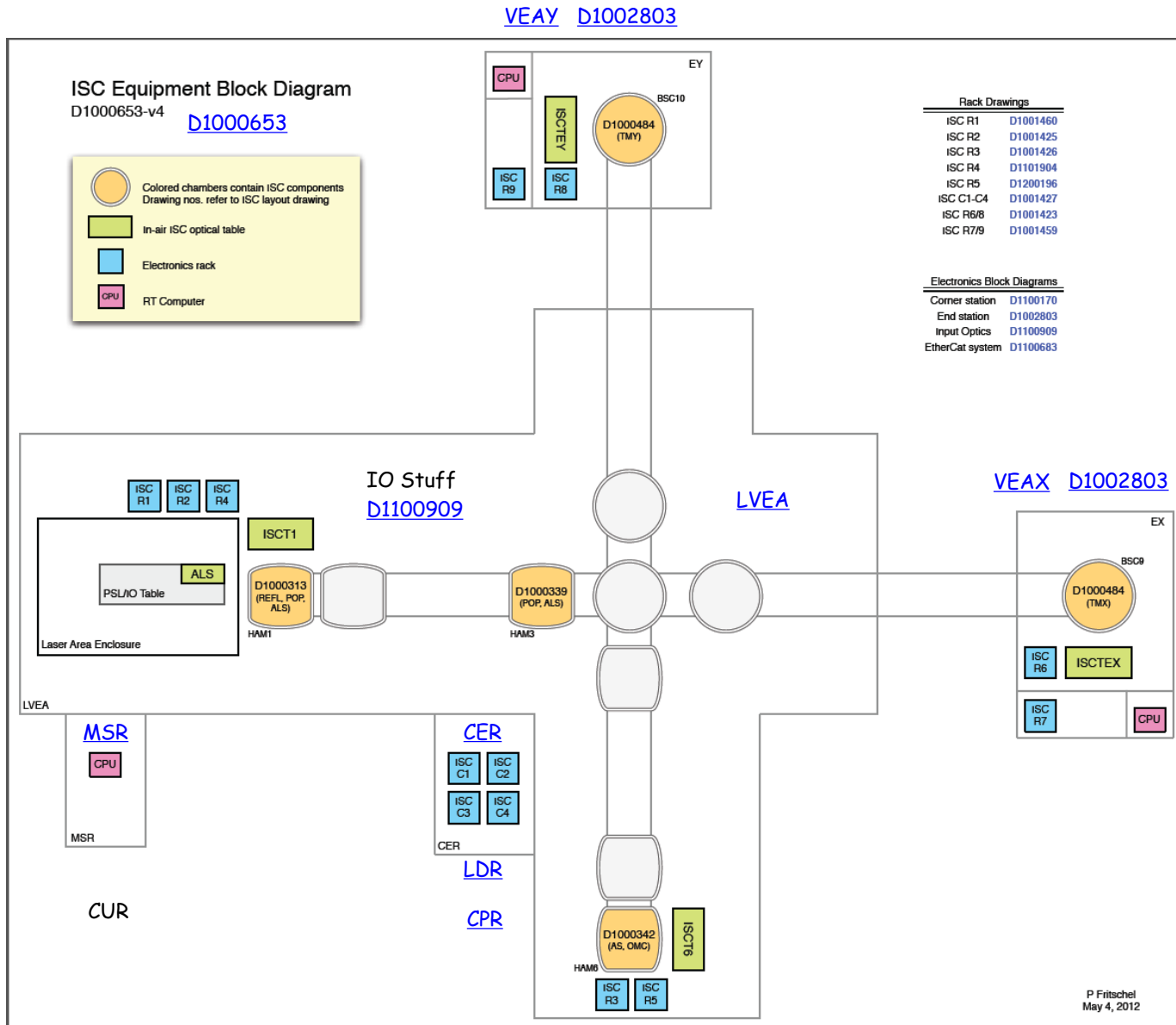

L1-ISC-C1

ISC LVEA Rack 1 Layout ([D1200949](#)) ([S1201186](#))

Beam Diverter Controller	Dxxxxxxx	42	Sxxxxxx	+?@1A
Beam Diverter Controller	Dxxxxxxx	41	Sxxxxxx	+?@1A
		40		
OMC Piezo Driver	Dxxxxxxx	39	Sxxxxxx	+?@1A
		38		
Anti-Alias Chassis (ASC)	D0902783	37	S1102773	±18VDC
Anti-Alias Chassis (ASC)	D0902783	36	S1102772	±18VDC
		35		
Anti-Alias Chassis (ASC)	D0902783	34	S1102767	±18VDC
Anti-Alias Chassis (ASC)	D0902783	33	S1102769	±18VDC
		32		
Anti-Alias Chassis (ASC)	D0902783	31	S1102775	±18VDC
Anti-Alias Chassis (ASC)	D0902783	30	S1102771	±18VDC
		29		
Anti-Alias Chassis (ASC)	D0902783	28	S1102708	±18VDC
Anti-Alias Chassis (ASC)	D0902783	27	S1102780	±18VDC
		26		
ISC HAM-A Coil Driver (Tip/Tilt REFL)	D1100687	25	S1106047	±18VDC
ISC HAM-A Coil Driver (Tip/Tilt REFL)	D1100687	24	S1200604	±18VDC
		23		
		22		
ISC HAM-A Coil Driver (Tip/Tilt OMC)	D1100687	21	S1200610	±18VDC
		20		
ISC HAM-A Coil Driver (Tip/Tilt OMC)	D1100687	19	S1200607	±18VDC
ISC Anti-Image Chassis (ASC)	b070081	18	S1102757	±18VDC
		17		
ISC Anti-Image Chassis (ASC)	D070081	16	S1102756	±18VDC
		15		
		14		
l1asc0 I/O Extension Chassis	D1001715	12	S1106300	+24VDC
		11		
		10		
ISC Anti-Alias Chassis (LSC)	D0902783	9	S1102768	±18VDC
ISC Anti-Alias Chassis (LSC)	D0902783	8	S1102779	±18VDC
		7		
		6		
		5		
l1lsc0 I/O Extension Chassis	D1001715	4	S1106342	+24VDC
		3		
		2		
		1		
	Front		Rear	

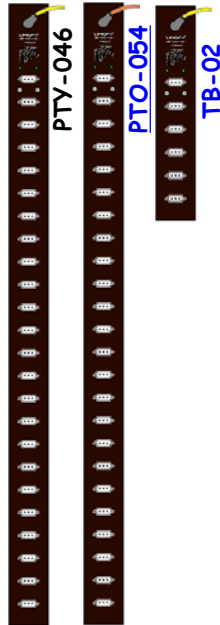

ISC-C1 is part of [D1001427](#).

IO Diagram: [D1100909](#)

Vertex ISC: [D1100170](#)

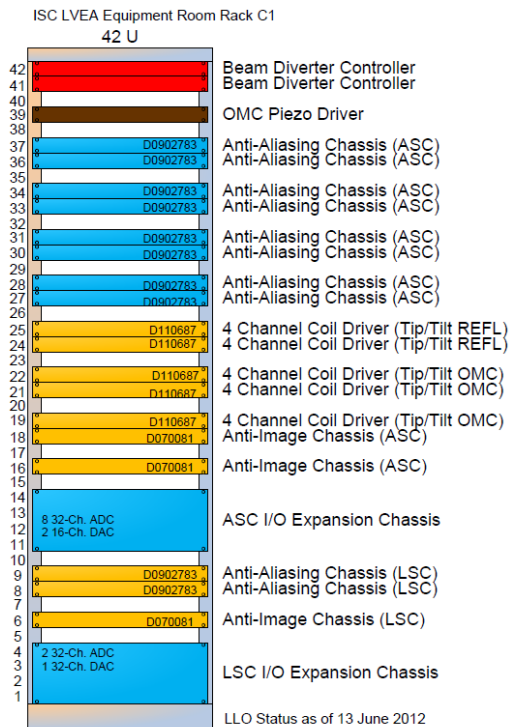

LIGO-D1001427-v13

([D1001427](#))

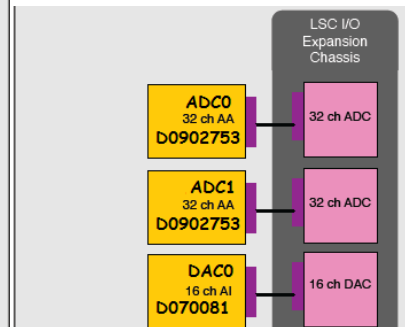
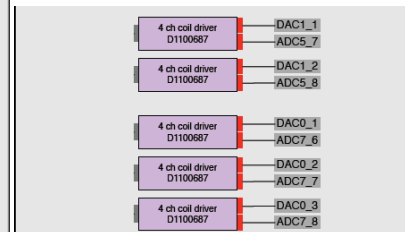
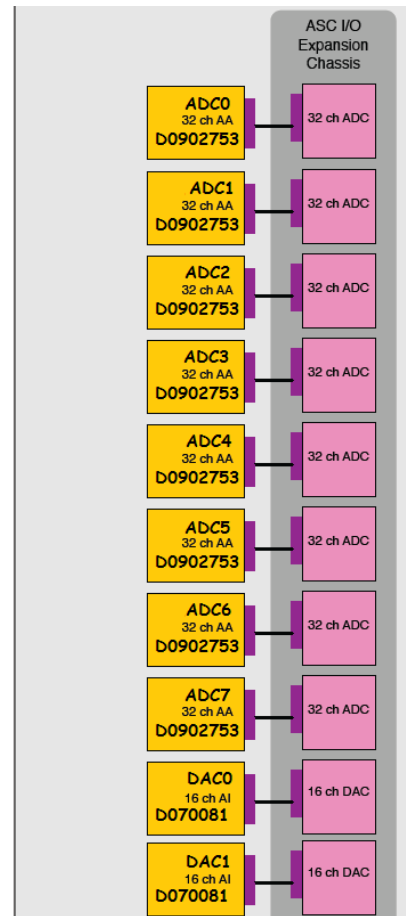

([D1100170](#))

L1-ISC-C1 Details

ISC-C1 is part of [D1001427](#).

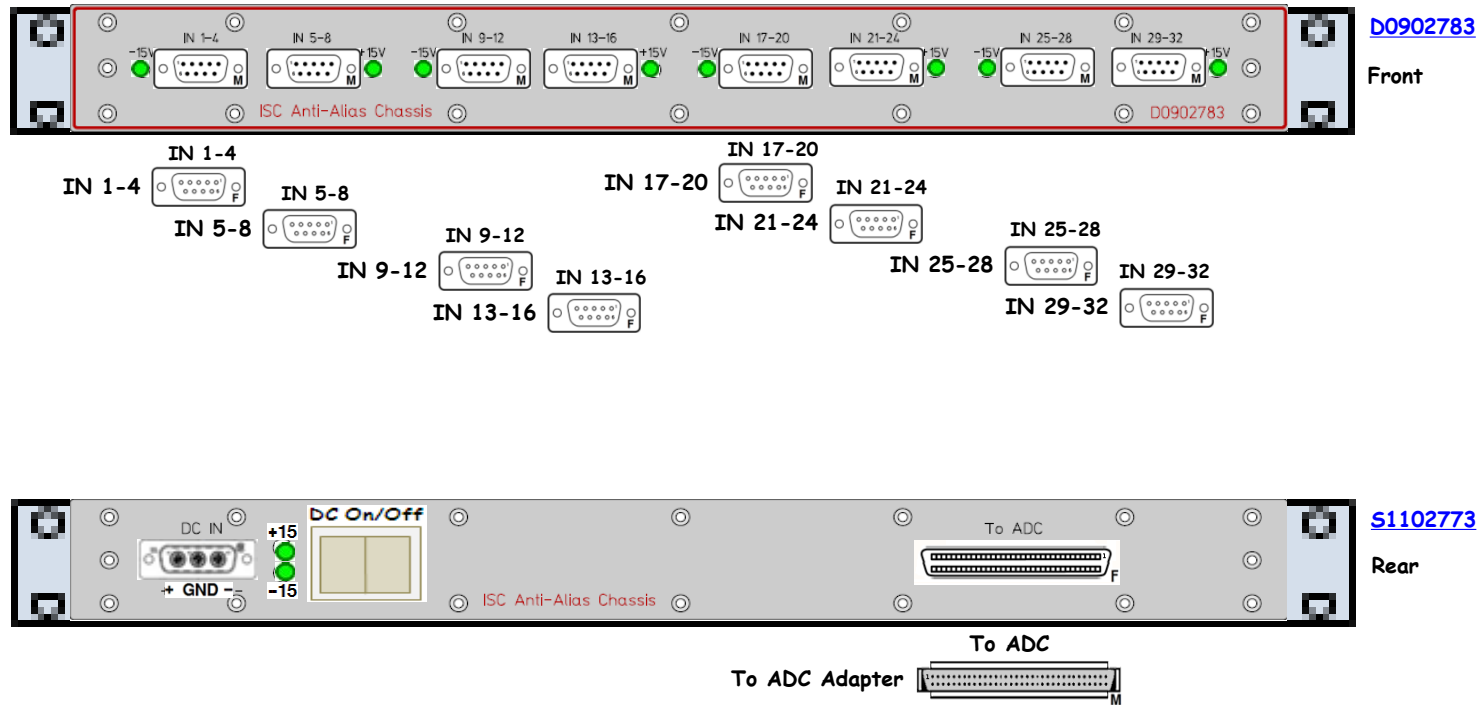

D0902783 - S1102772



<< L1-ISC-C1

Anti-Alias Chassis (ASC) D0902783 S1102772 ±18VDC

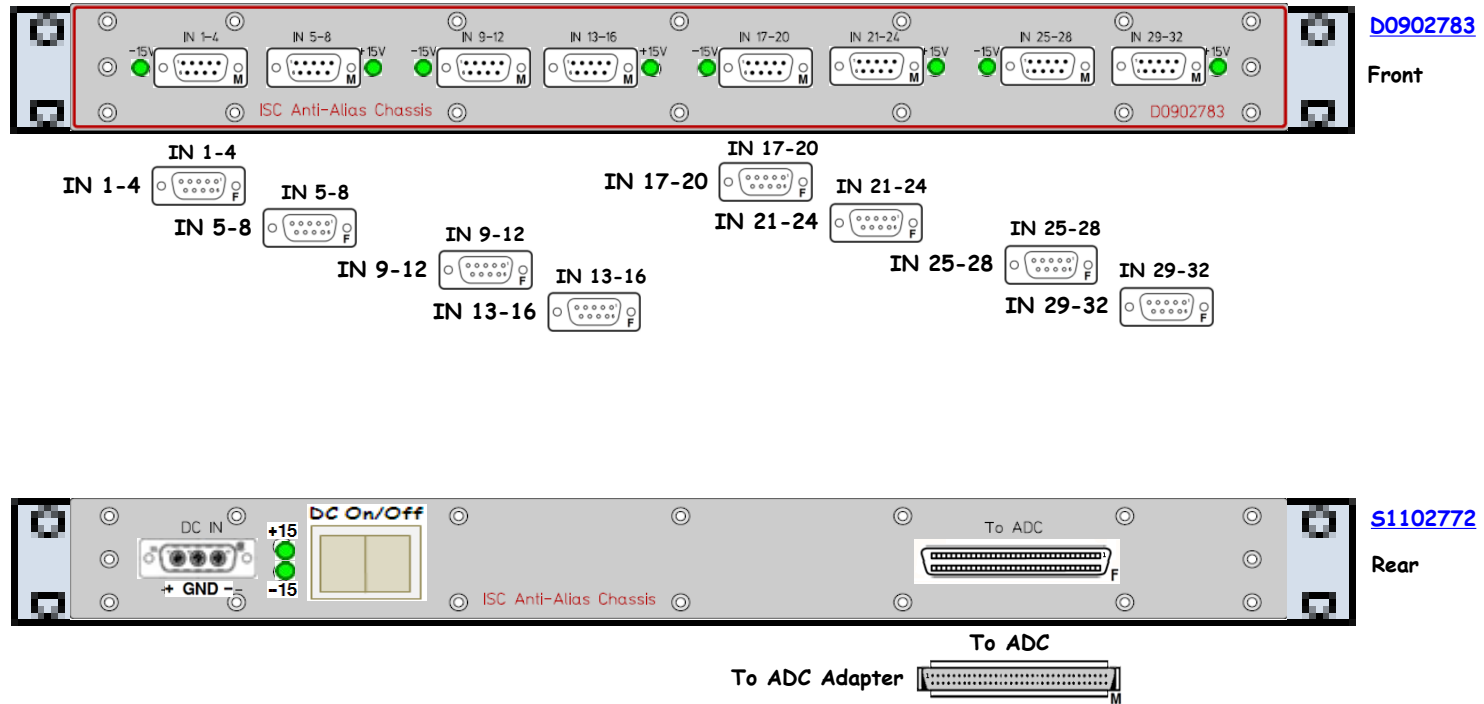

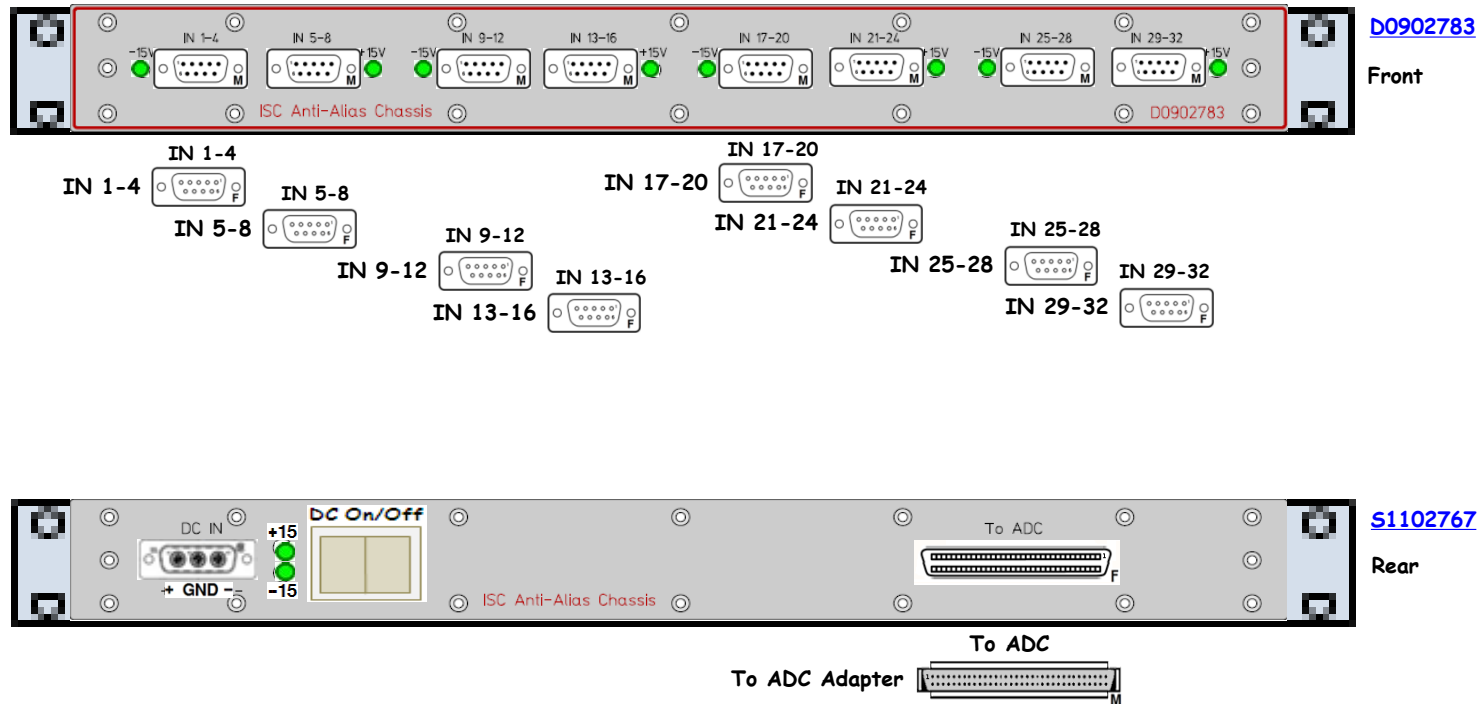

D0902783 - S1102769



<< L1-ISC-C1

Anti-Alias Chassis (ASC) D0902783 S1102769 ±18VDC

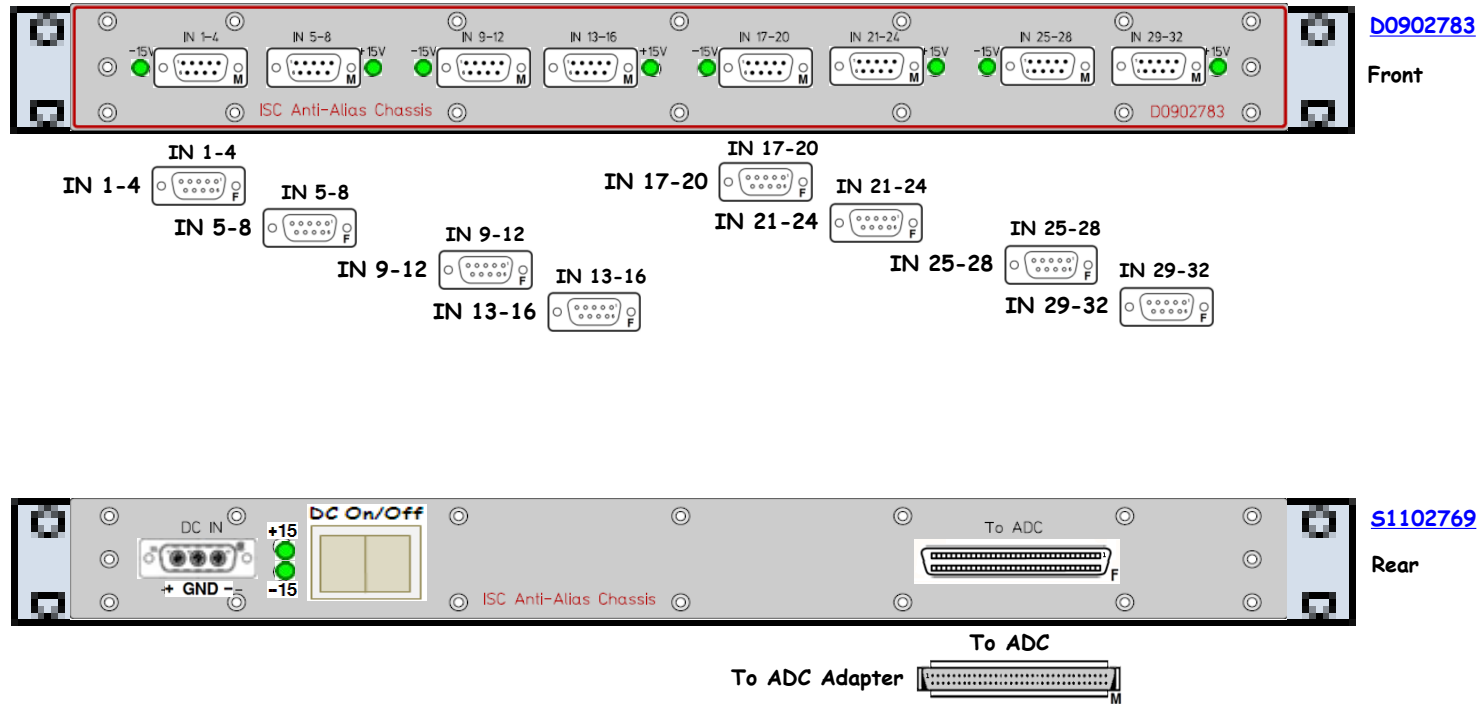

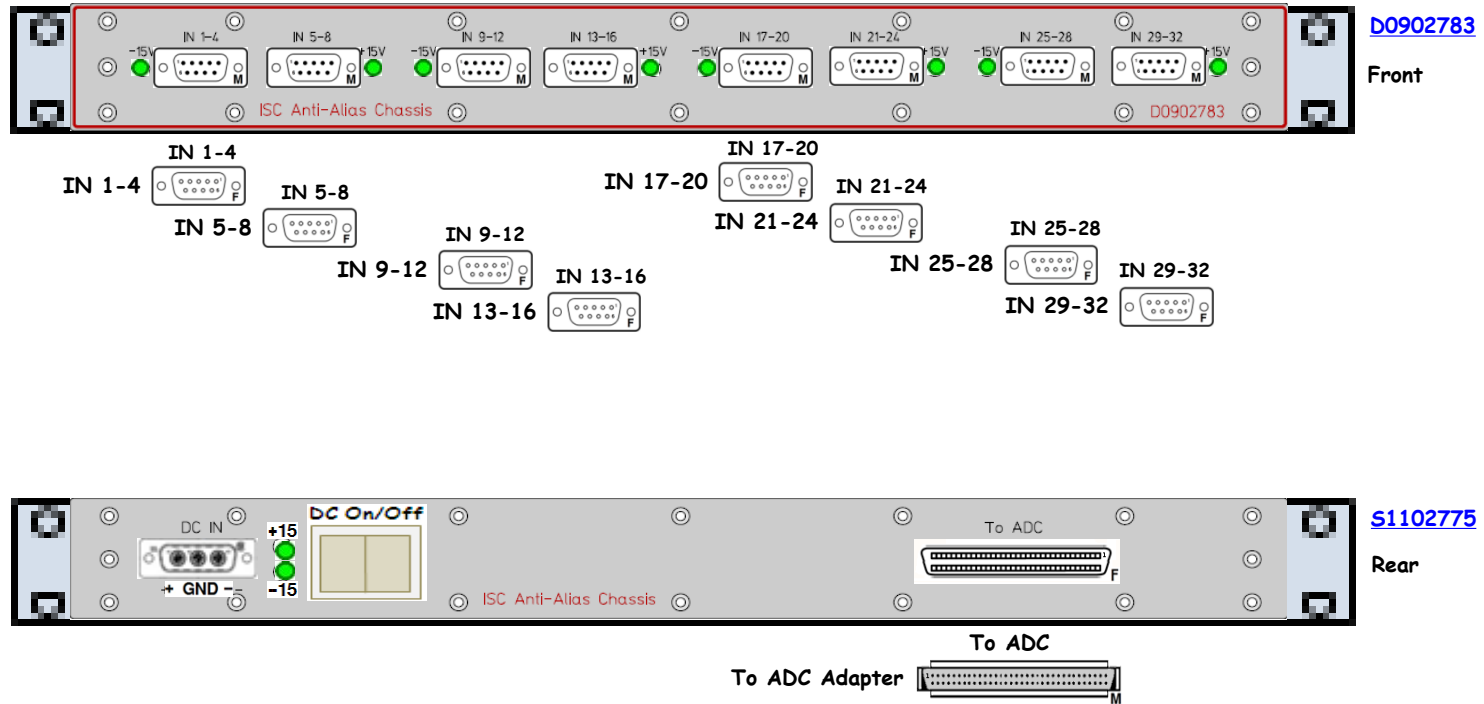

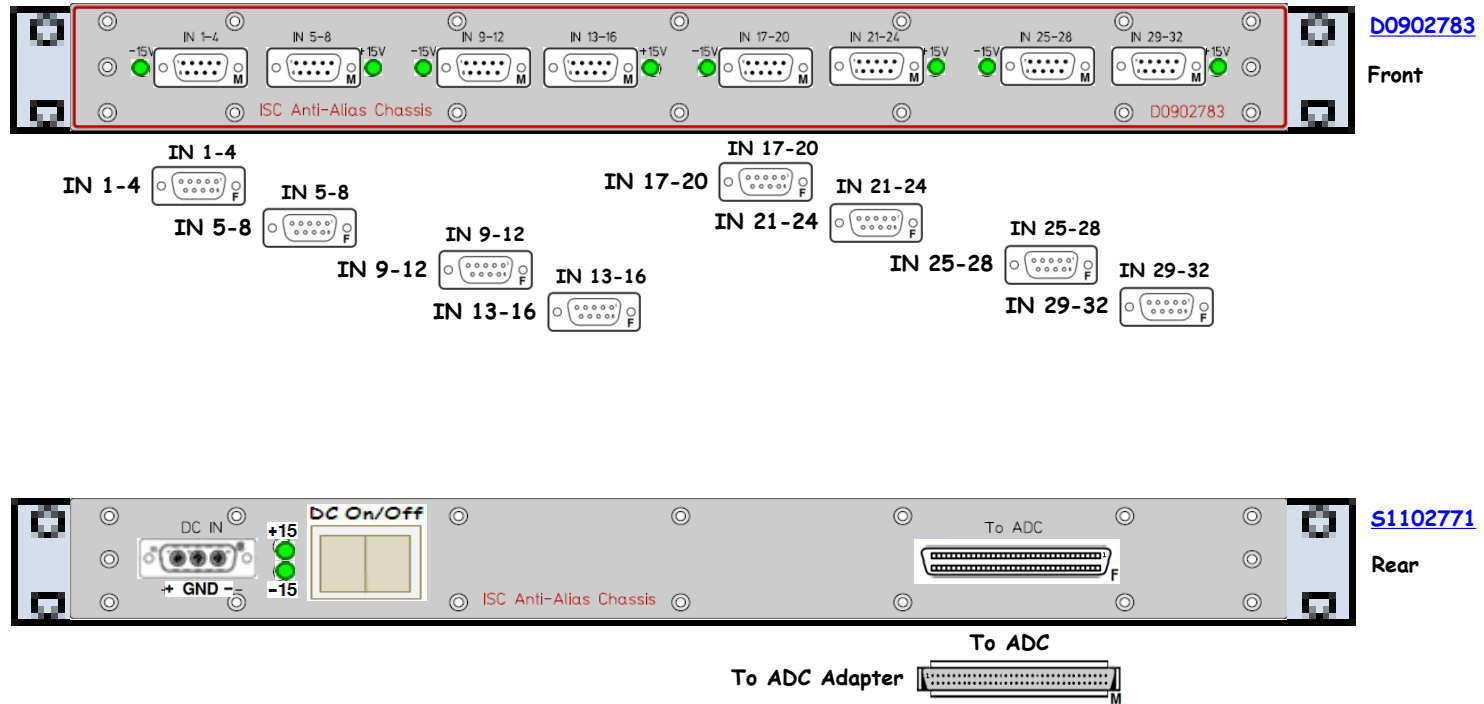

D0902783 - S1102708



<< L1-ISC-C1

Anti-Alias Chassis (ASC) D0902783 S1102708 ±18VDC

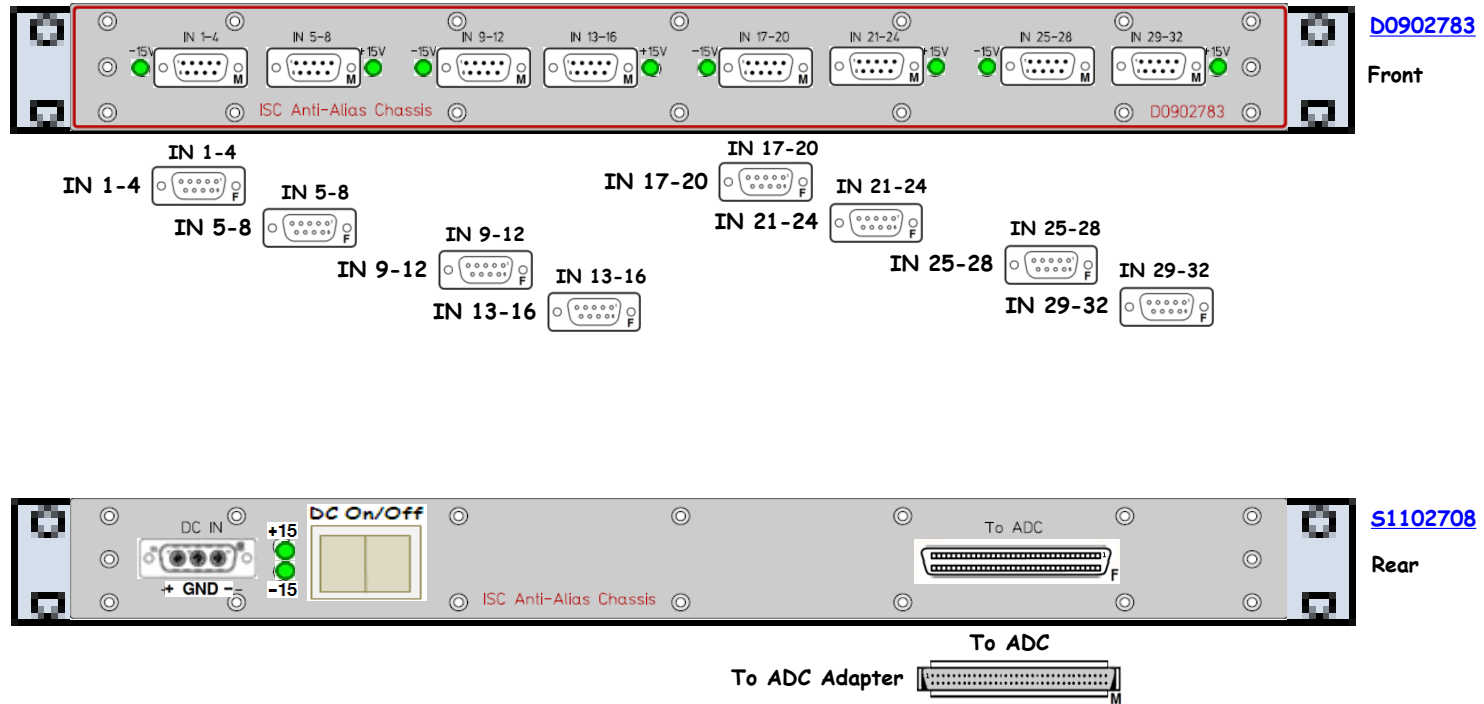

D0902783 - S1102780



<< L1-ISC-C1

Anti-Alias Chassis (ASC) D0902783 S1102780 ±18VDC

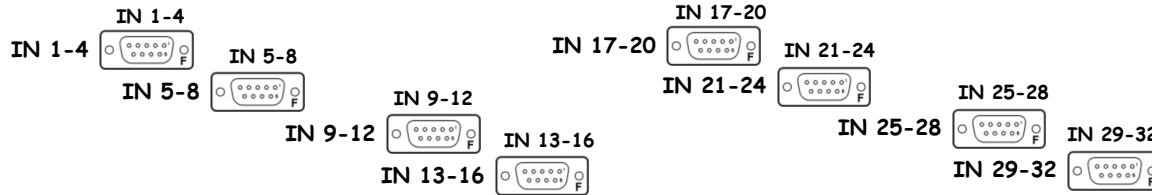
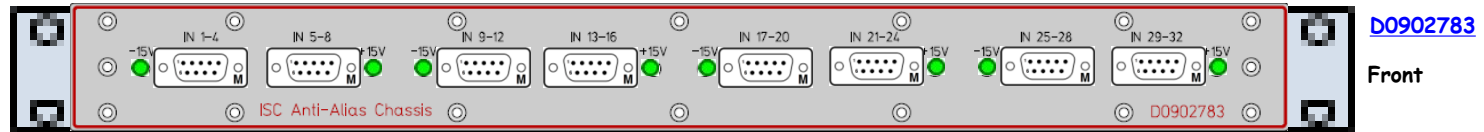

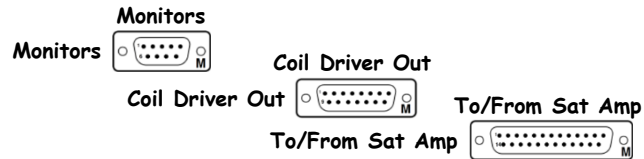
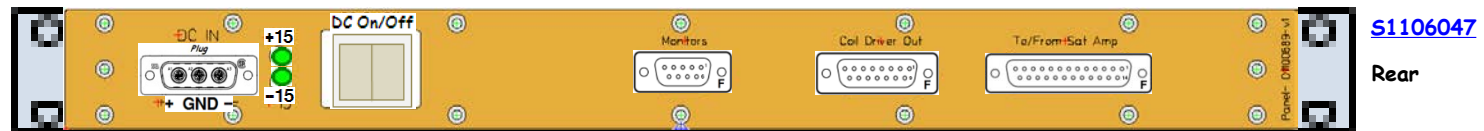
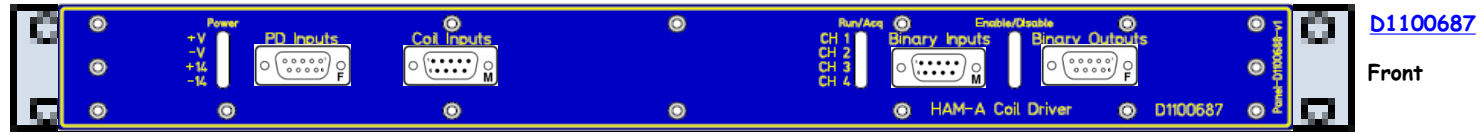

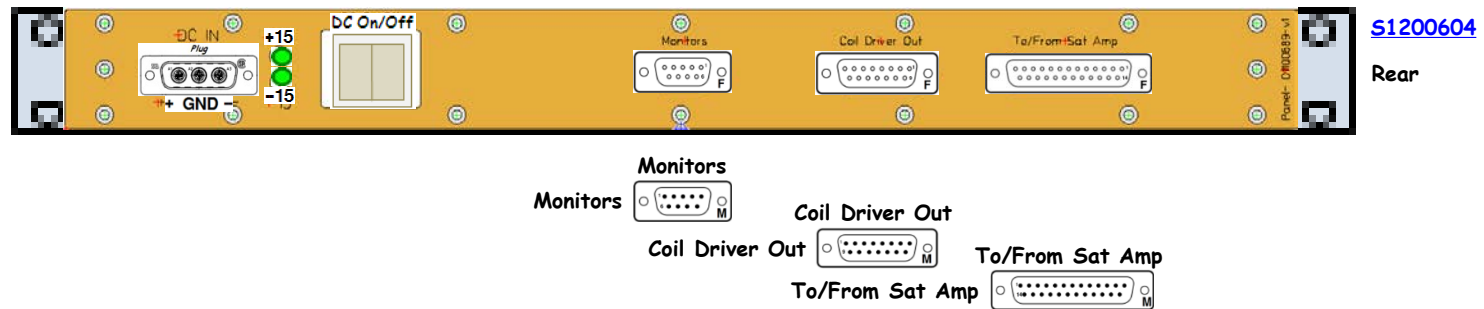
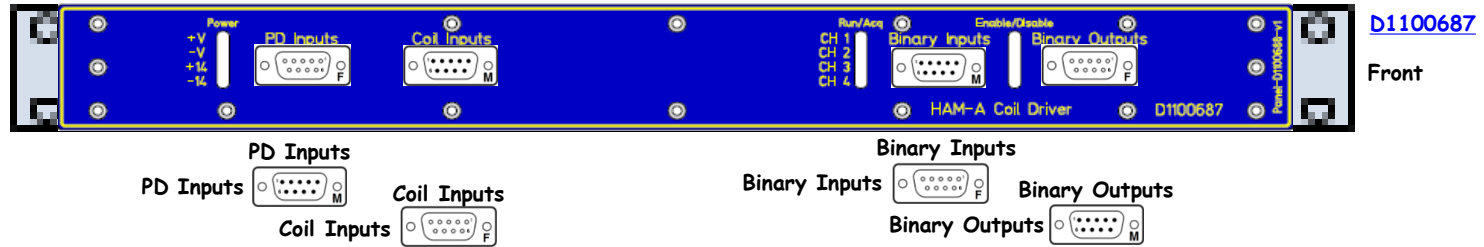

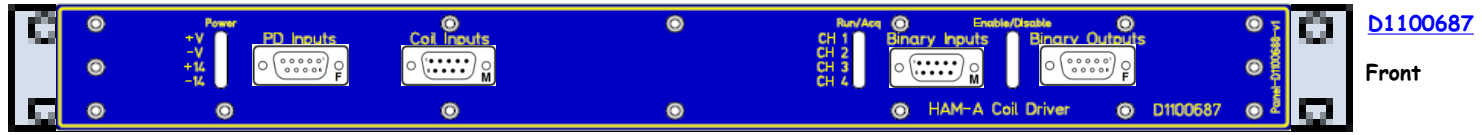

D1100687

Front

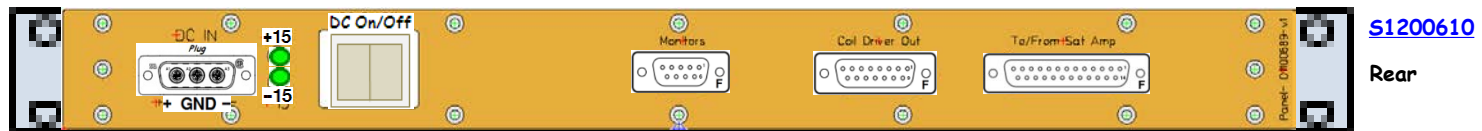

S1200610

Rear

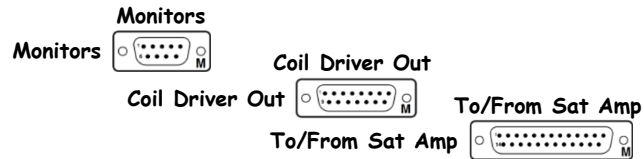



D1100687

Front

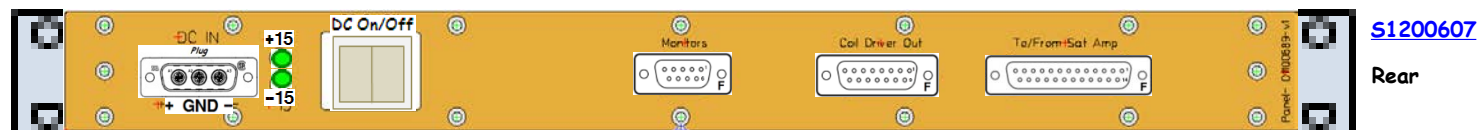

S1200607

Rear

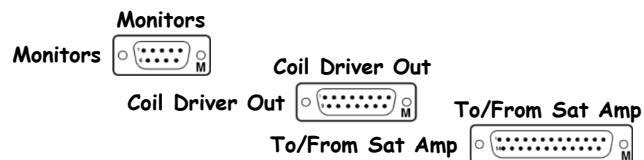

ISC Anti-Image Chassis (ASC) D070081 S1102757 ±18VDC

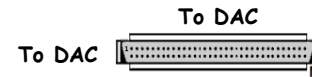
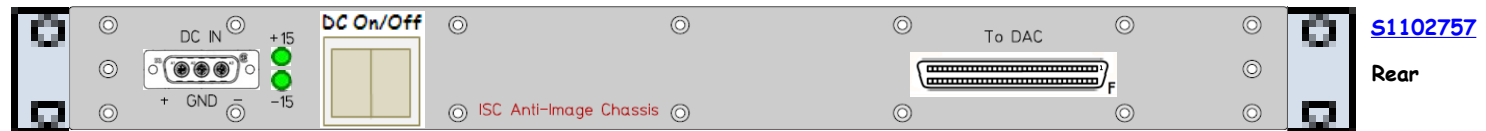
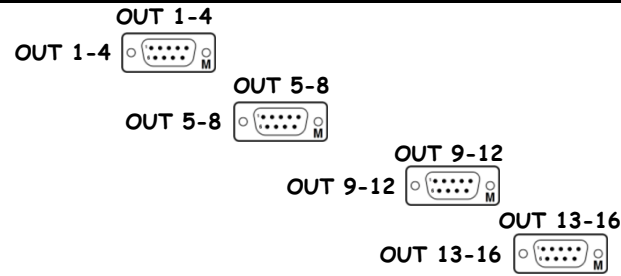
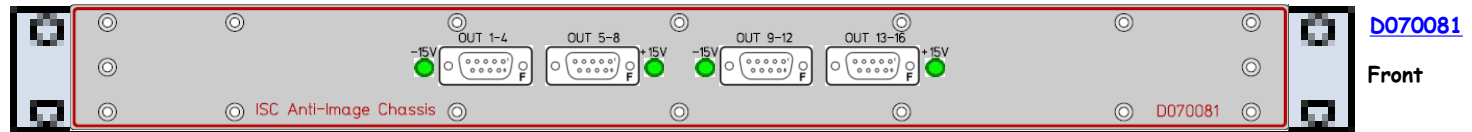

ISC Anti-Image Chassis (ASC) D070081 S1102756 ±18VDC

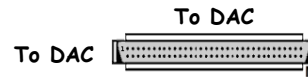
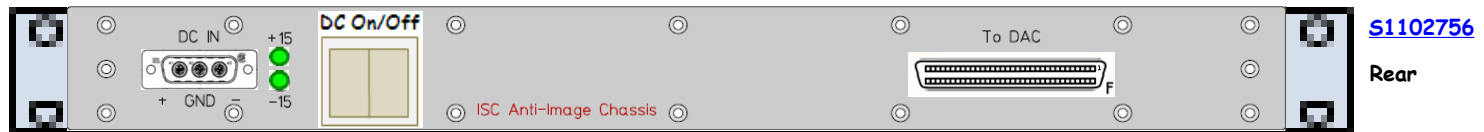
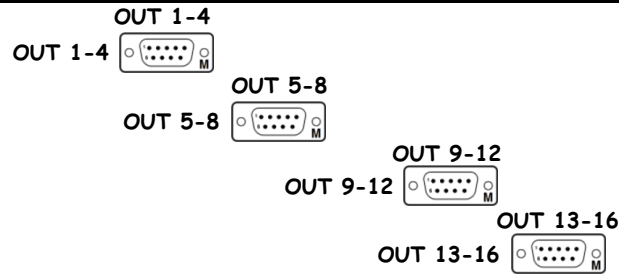
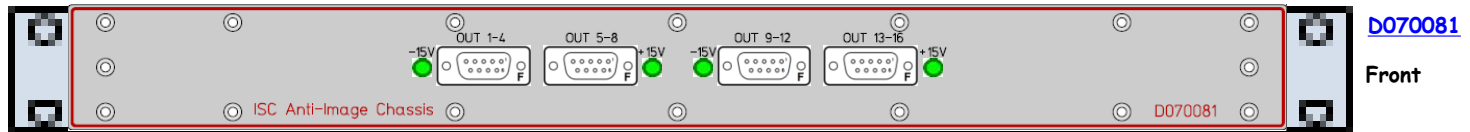



D1001715

Front

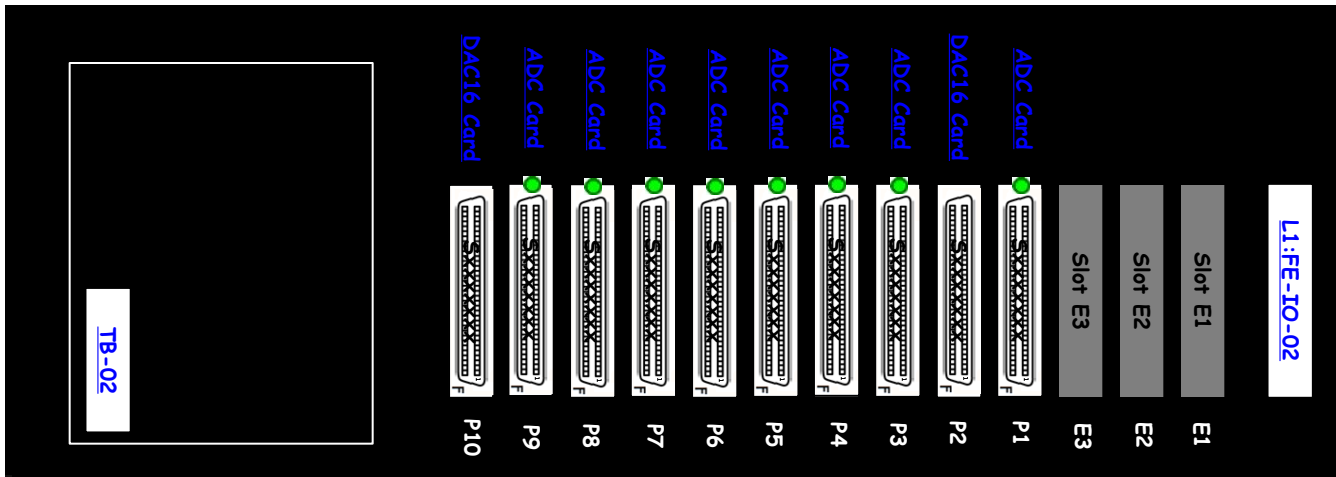

S1106300

Rear

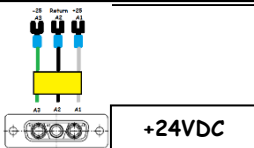
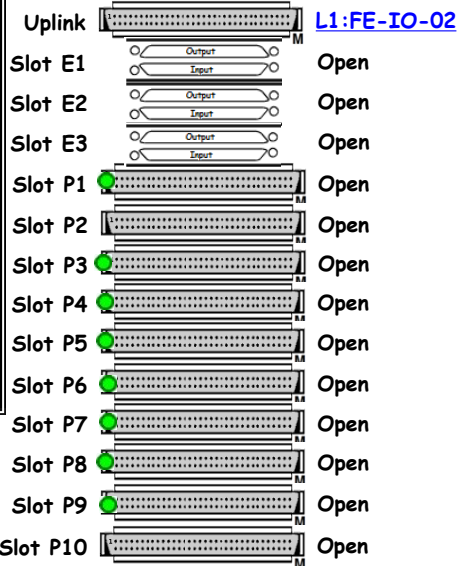

D0902783 - S1102768



<< L1-ISC-C1

ISC Anti-Alias Chassis (LSC) D0902783 S1102768 ±18VDC

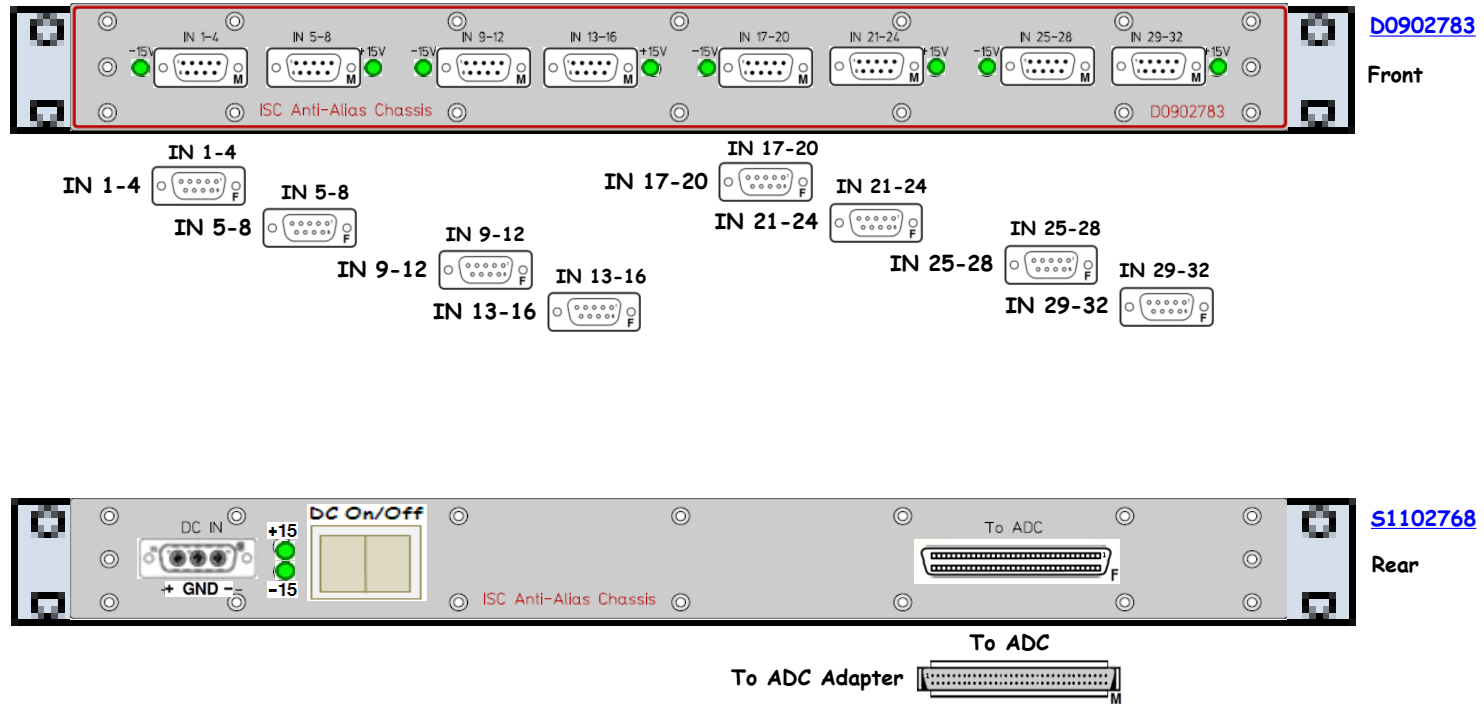

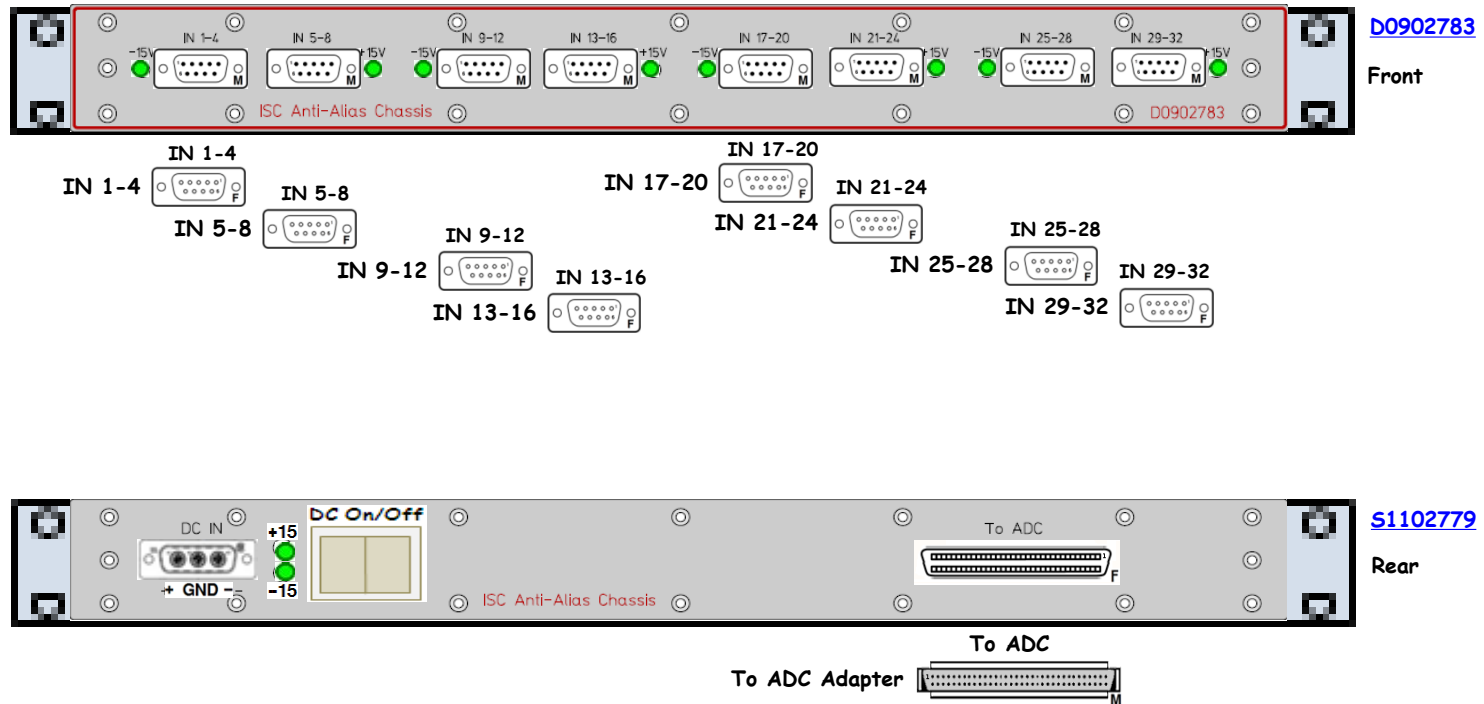

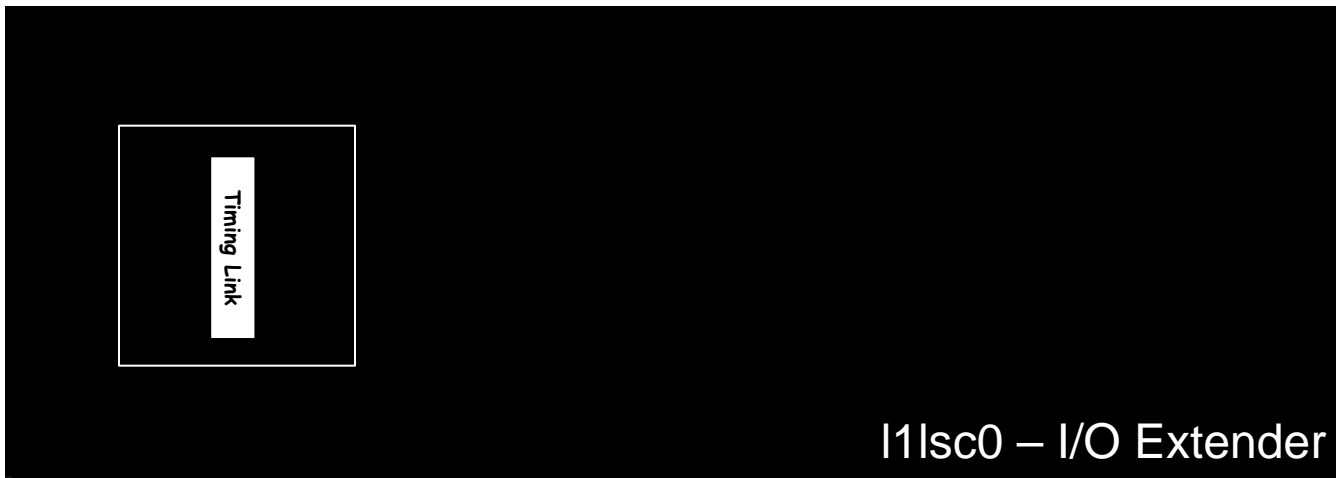

[D1001715](#)

Front

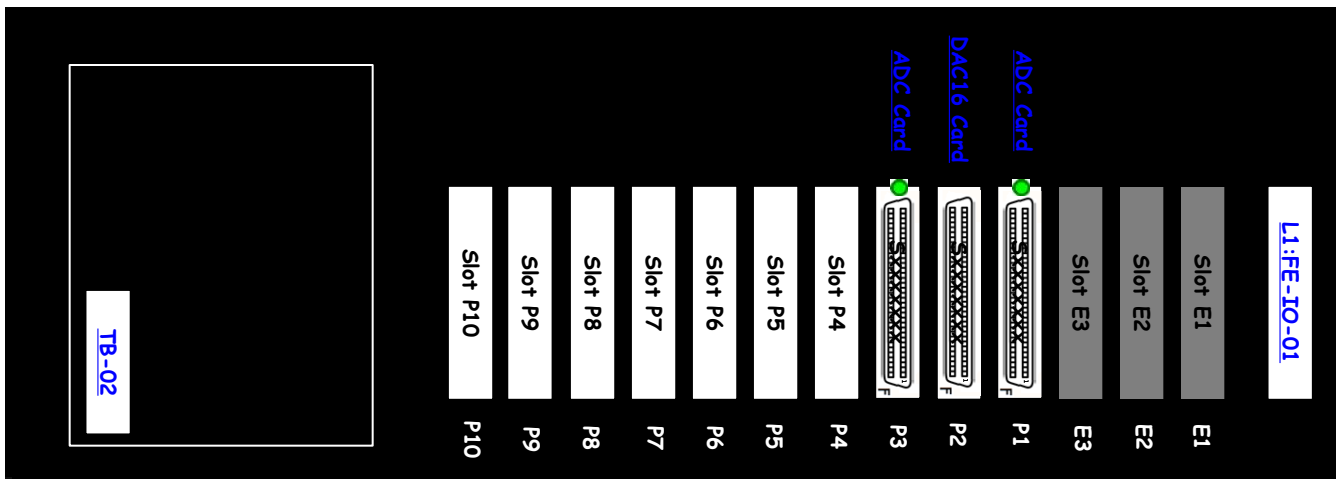

[S1106342](#)

Rear

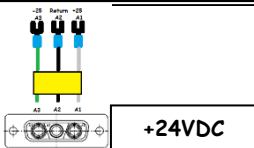
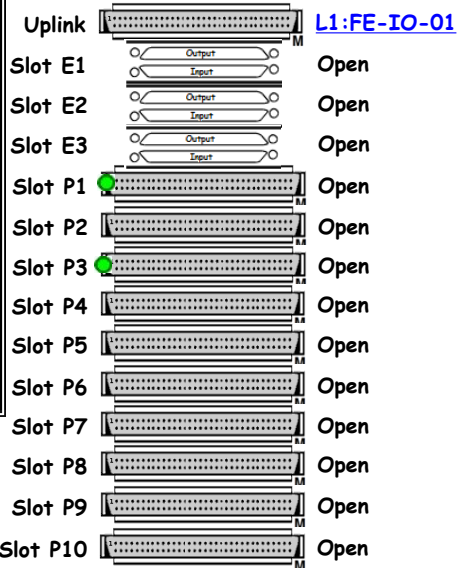

L1-ISC-C2

ISC LVEA Rack 2 Layout ([D1200975](#)) ([S1201187](#))

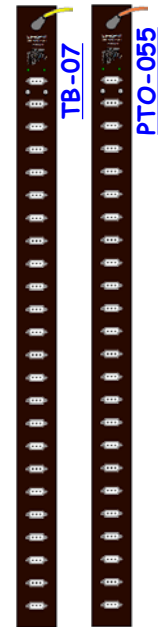
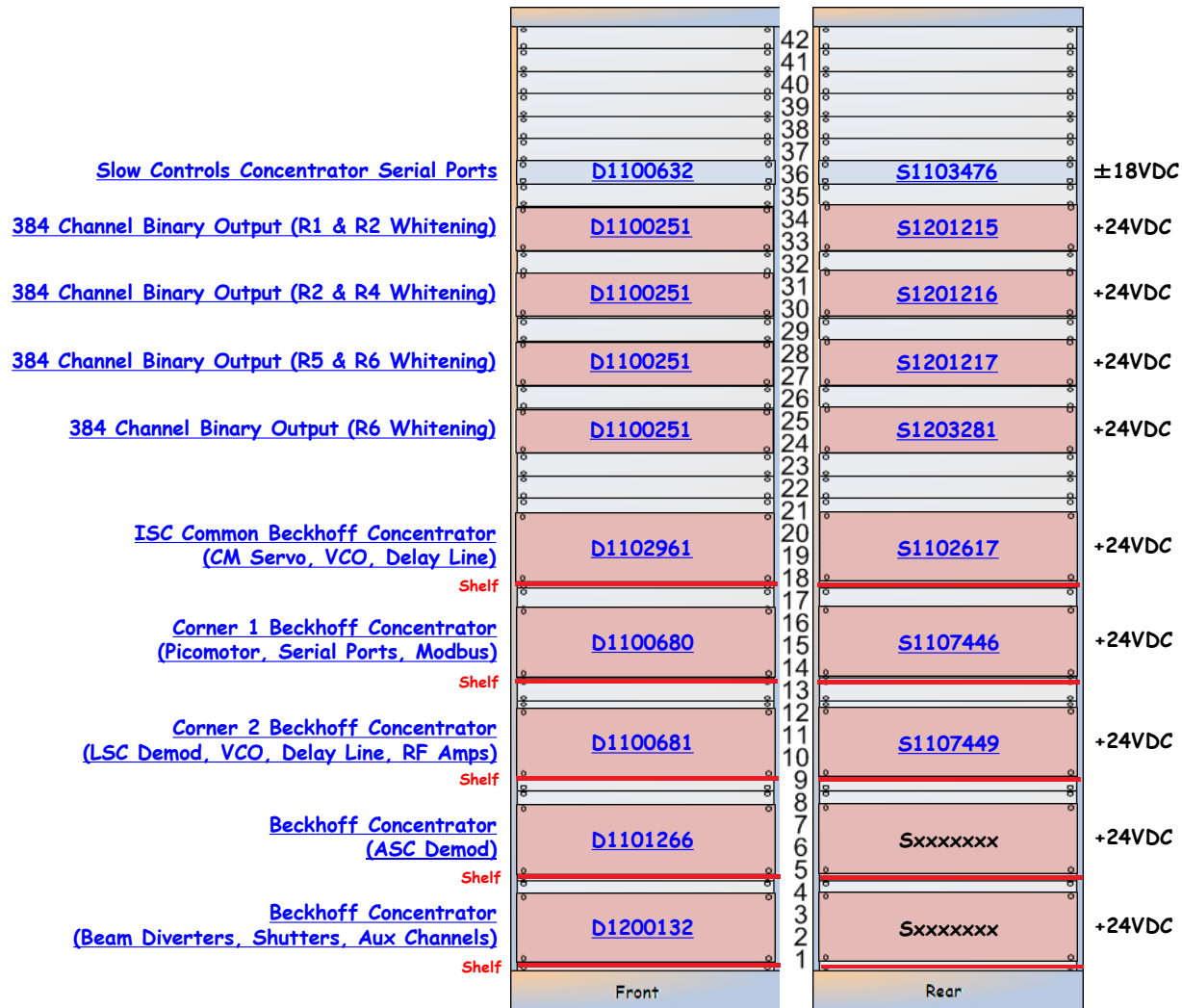

ISC-C2 is part of [D1001427](#).

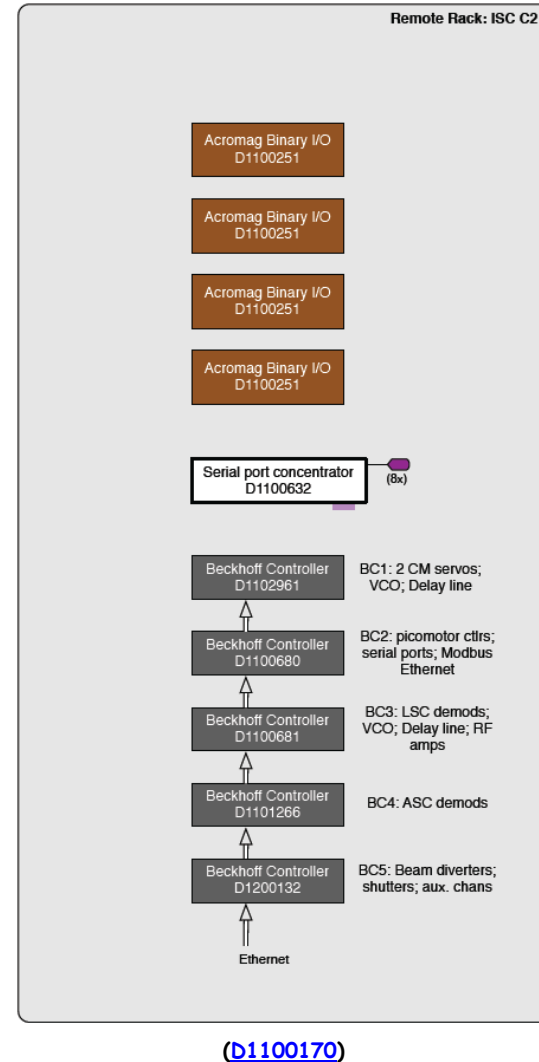
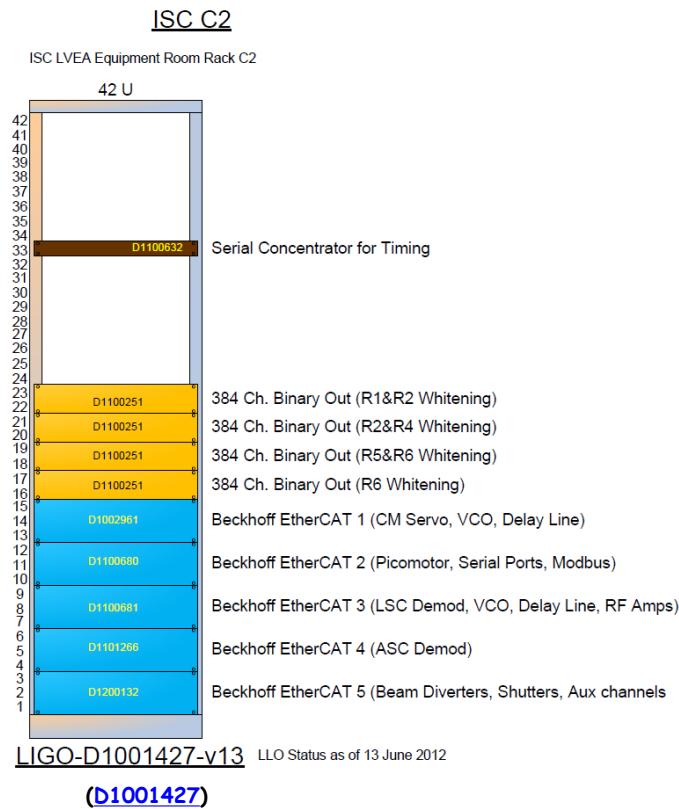

L1-ISC-C2 Details

ISC-C2 is part of [D1001427](#).

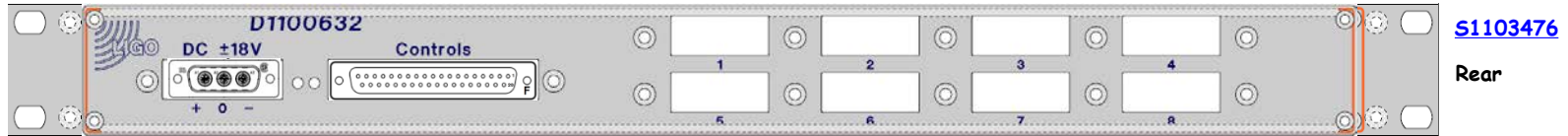
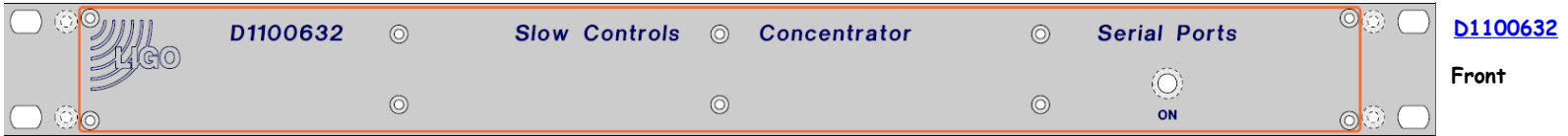

384 Channel Binary Output (R1 & R2 Whitening)

D1100251

S1201215

+24VDC

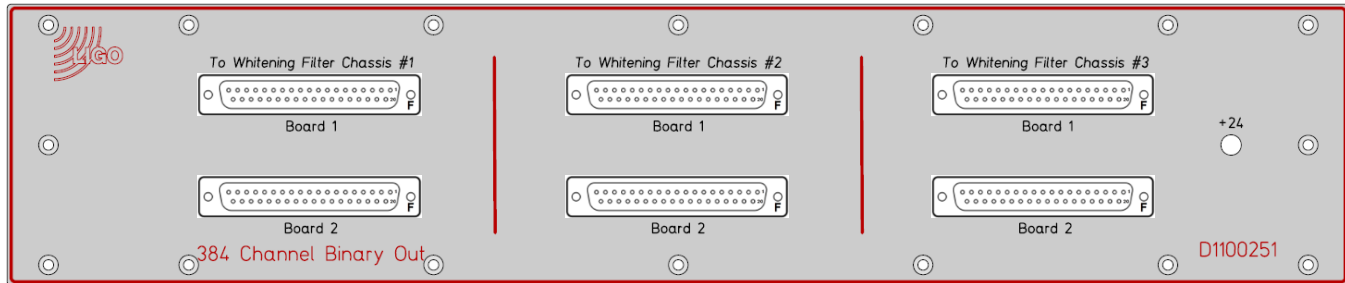

D1100251

Front

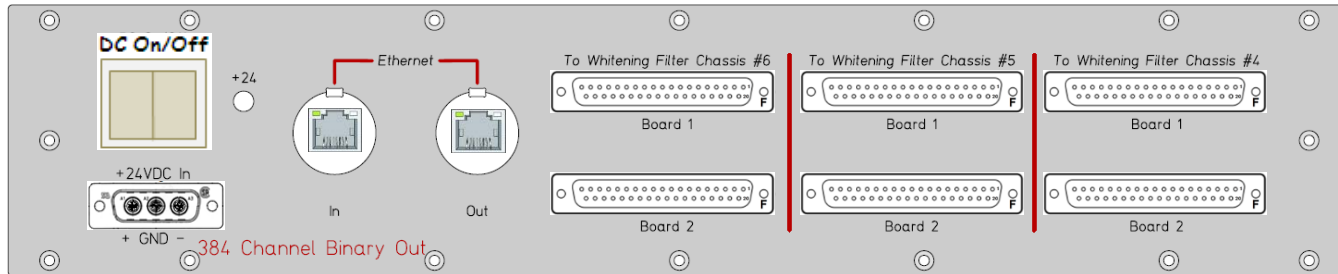
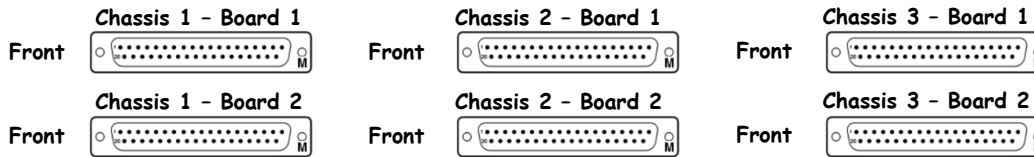

S1201215

Rear

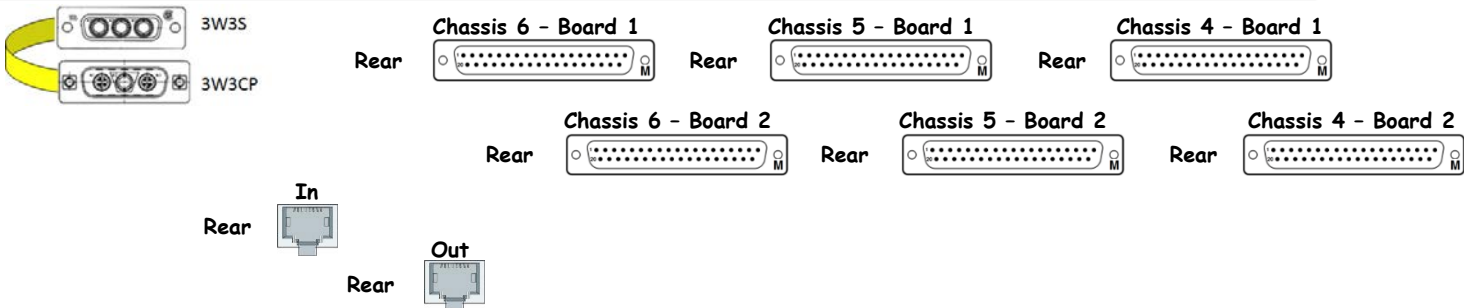

384 Channel Binary Output (R2 & R4 Whitening)

D1100251

S1201216

+24VDC

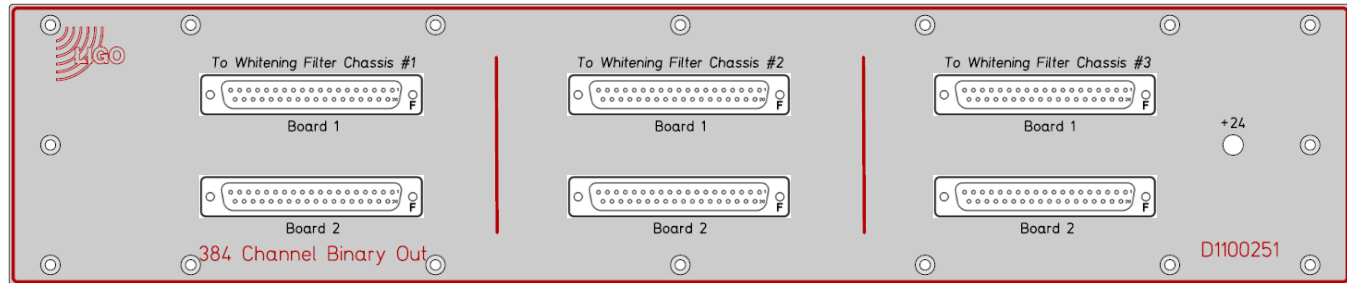

D1100251

Front

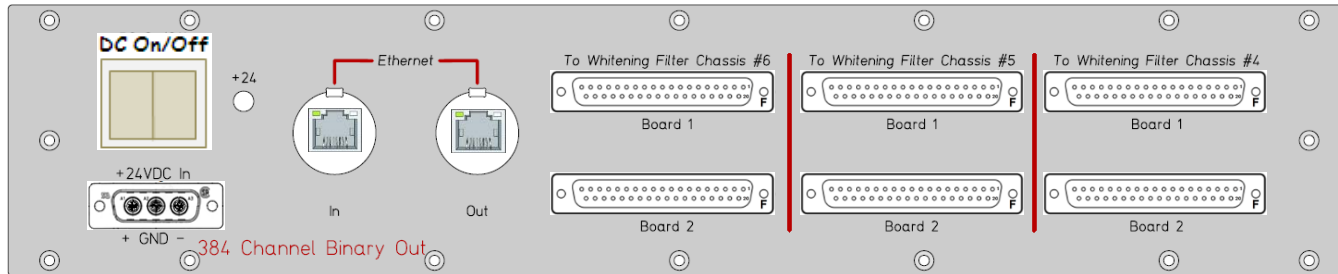
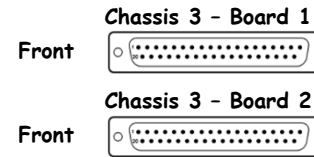
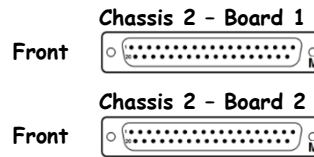
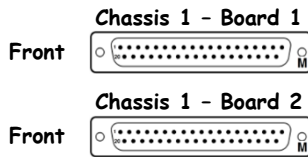

S1201216

Rear

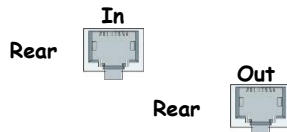
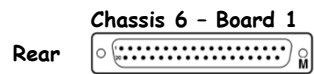
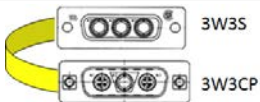

384 Channel Binary Output (R5 & R6 Whitening)

D1100251

S1201217

+24VDC

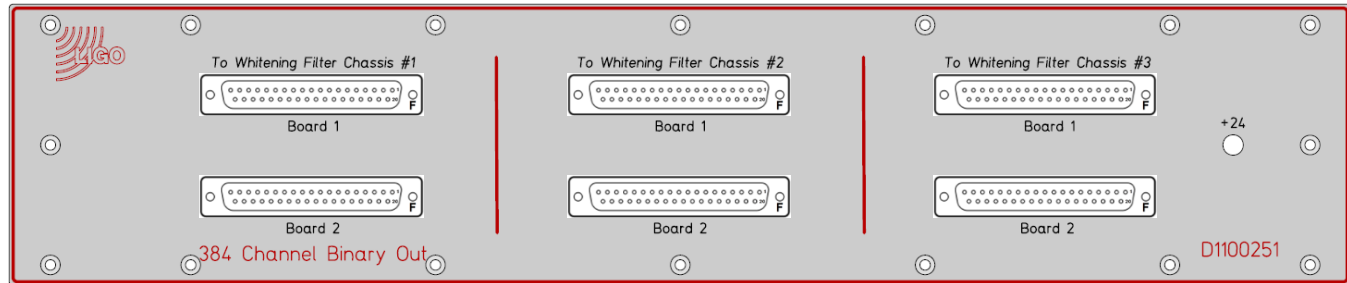

D1100251

Front

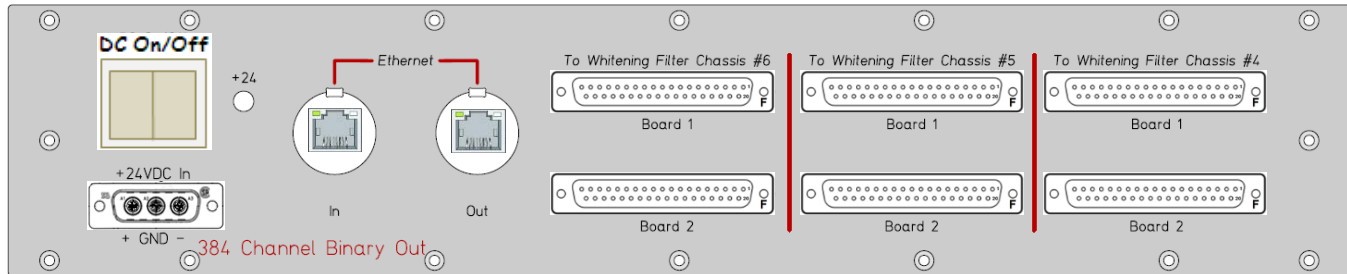
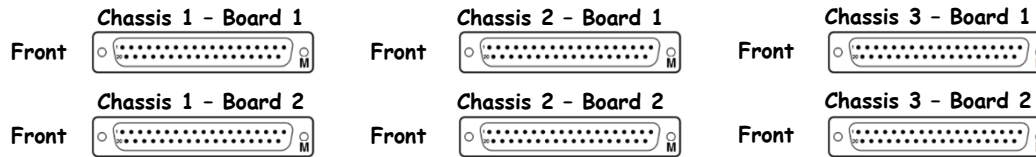

S1201217

Rear

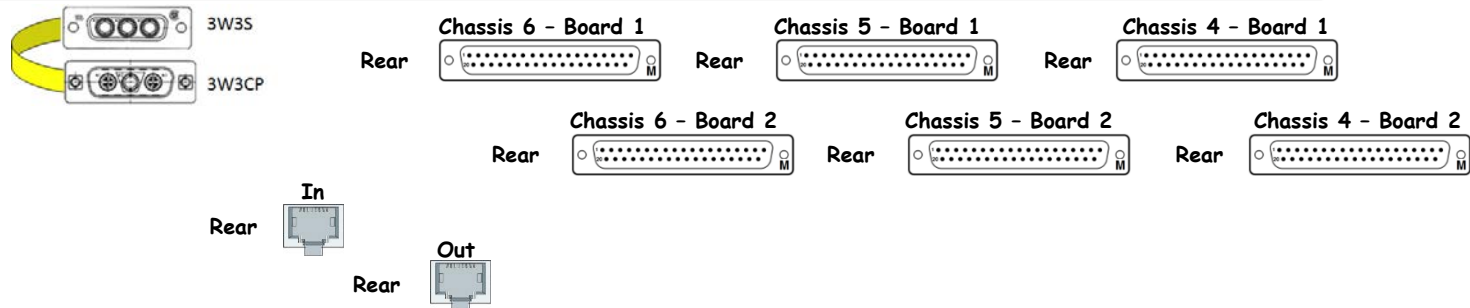

384 Channel Binary Output (R6 Whitening)

D1100251

S1203281

+24VDC

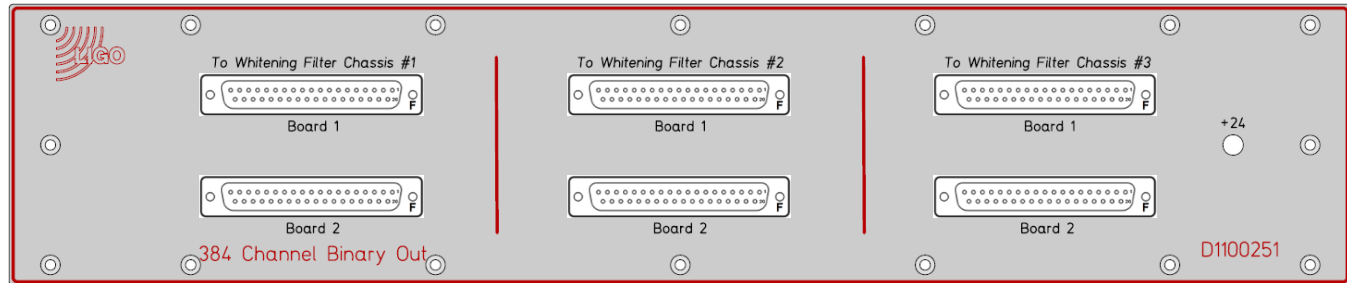

D1100251

Front

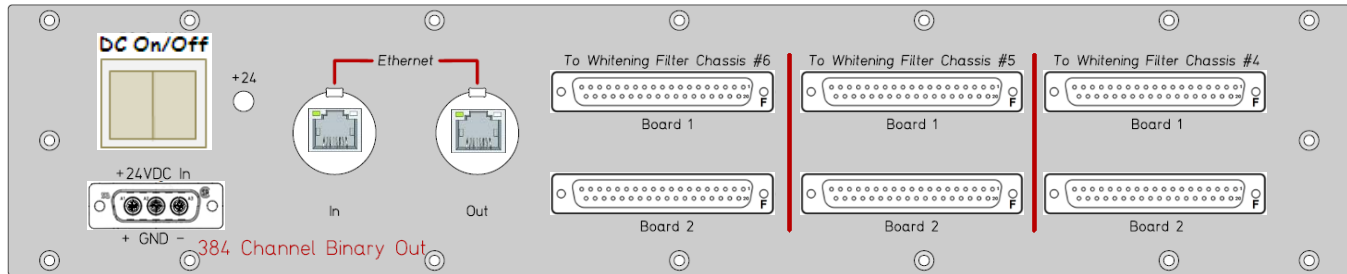
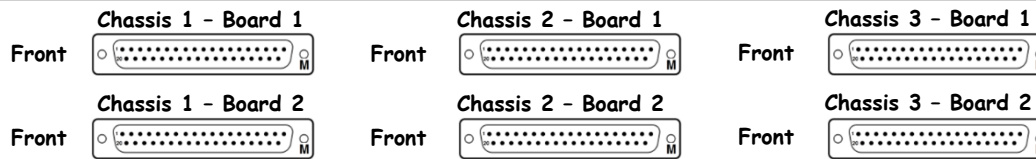

S1203281

Rear

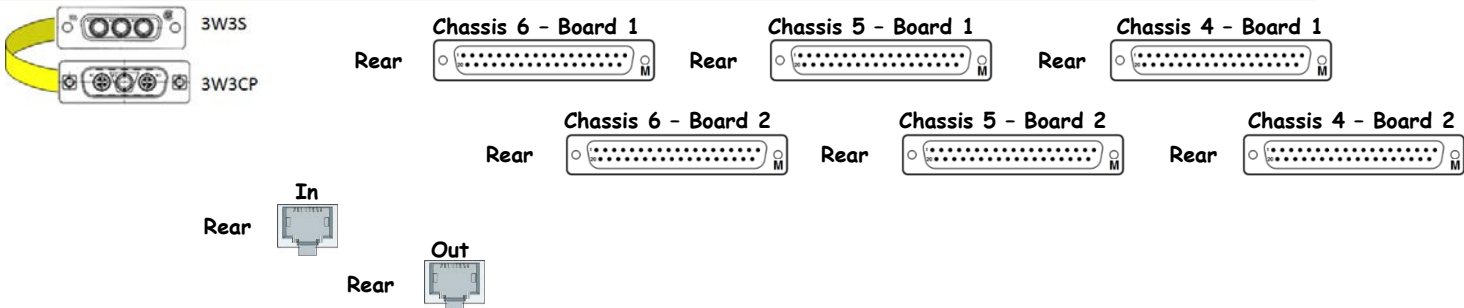

<< [L1-ISC-C2](#)

ISC Common Beckhoff Concentrator
(CM Servo, VCO, Delay Line)

[D1102961](#)

[S1102617](#)

Power

[D1102961](#)

Front

[S1102617](#)

Rear

DC On/Off

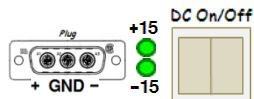

From DAC Adapter

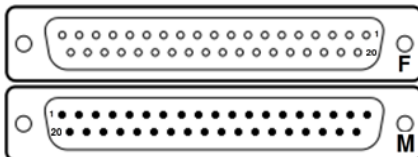

<< [L1-ISC-C2](#)

Corner 1 Beckhoff Concentrator
(Picomotor, Serial Ports, Modbus)

[D1100680](#)

[S1107446](#)

Power

[D1100680](#)

Front

[S1107446](#)

Rear

DC On/Off

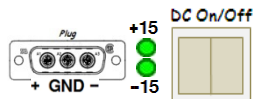

From DAC Adapter

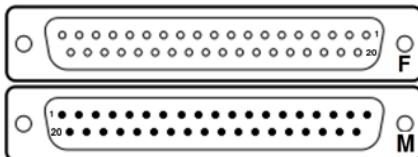
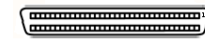

<< [L1-ISC-C2](#)

Corner 2 Beckhoff Concentrator
(LSC Demod, VCO, Delay Line, RF Amps)

[D1100681](#)

[S1107449](#)

Power

[D1100681](#)

Front

[S1107449](#)

Rear

DC On/Off

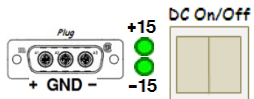

From DAC Adapter

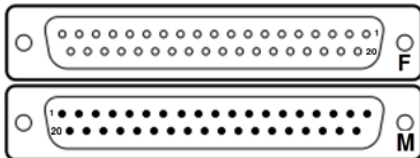

<< [L1-ISC-C2](#)

Beckhoff Concentrator
(ASC Demod)

[D1101266](#)

Sxxxxxxx

Power

[D1101266](#)

Front

Sxxxxxxx

Rear

DC On/Off

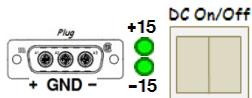

From DAC Adapter

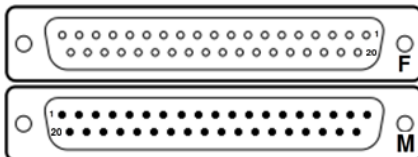

<< [L1-ISC-C2](#)

Beckhoff Concentrator
(Beam Diverters, Shutters, Aux Channels)

[D1200132](#)

Sxxxxxxx

Power

[D1200132](#)

Front

Sxxxxxxx

Rear

DC On/Off

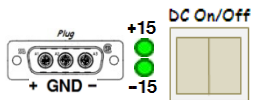

From DAC Adapter

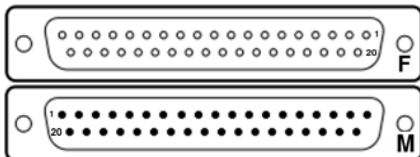

RF Patch Panel 7	Dxxxxxxx	42	Sxxxxxxx	No Power
RF Patch Panel 8	Dxxxxxxx	41	Sxxxxxxx	No Power
RF Patch Panel 9	Dxxxxxxx	40	Sxxxxxxx	No Power
		39		
		38		
		37		
		36		
		35		
		34		
		33		
21.5 MHz RF Source	D080702	32	S1000546	+12VDC, ±24VDC
21.5 MHz Distribution Amplifier	D1000124	31	S1000649	±17VDC, ±24VDC
35.5 MHz RF Source	D080702	30	S1000551	+12VDC, ±24VDC
35.5 MHz Distribution Amplifier	D1000124	29	S1000650	±17VDC, ±24VDC
		28		
		27		
		26		
80 MHz RF Source	D080702	25	S1000567	+12VDC, ±24VDC
80 MHz Distribution Amplifier	D1000124	24	S1000654	±17VDC, ±24VDC
40 MHz Frequency Divider	D1002182	23	S1000751	±17VDC, ±24VDC
40 MHz Distribution Amplifier	D1000124	22	S1000655	±17VDC, ±24VDC
10 MHz Frequency Divider	D1100974	21	S1103488	±17VDC, ±24VDC
10 MHz Distribution Amplifier	D1000124	20	S1000671	±17VDC, ±24VDC
		19		
		18		
RF Amplifier Concentrator 1	D1100262	17	S1103461	±18VDC
RF Amplifier Concentrator 2	D1100262	16	S1103460	±18VDC
		15		
		14		
		13		
Timing Comparator / Frequency Counter	D1001370	12	Sxxxxxxx	+12VDC
Timing Fanout Module	D070011	11	Sxxxxxxx	+12VDC
		10		
		9		
		8		
		7		
		6		
		5		
		4		
		3		
		2		
		1		

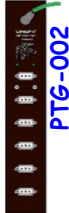
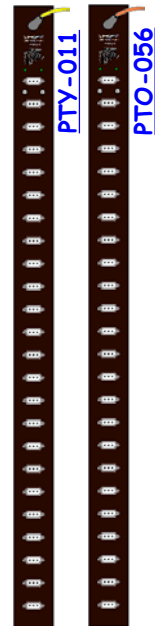

ISC-C3 is part of [D1001427](#).

Front

Rear

ISC C3

ISC LVEA Equipment Room Rack C3

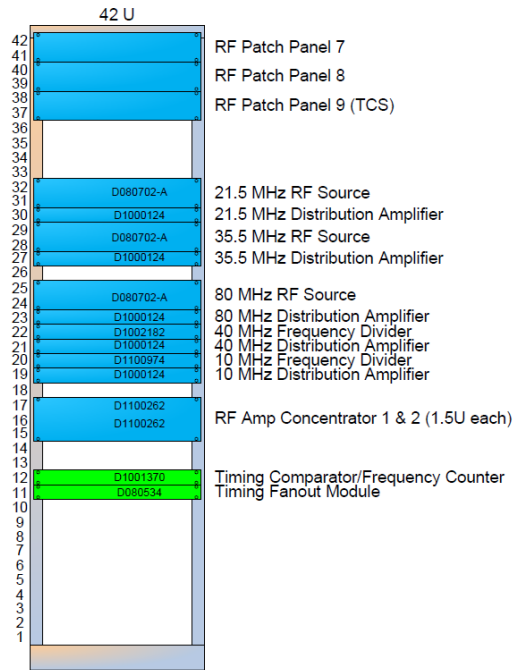

LIGO-D1001427-v13 Status as of 13 June 2012

([D1001427](#))

Remote Rack: ISC C3

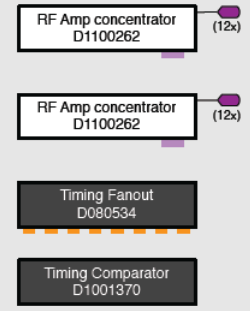
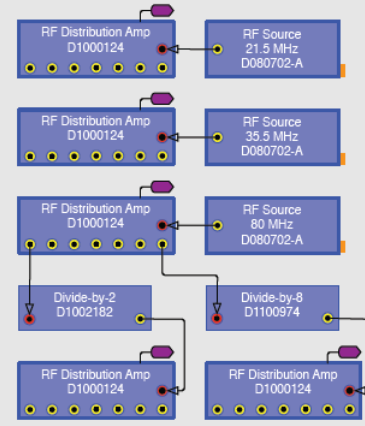

([D1100170](#))

L1-ISC-C3 Details

ISC-C3 is part of [D1001427](#).

RF Patch Panel 7

Dxxxxxxx

Sxxxxxxx

No Power

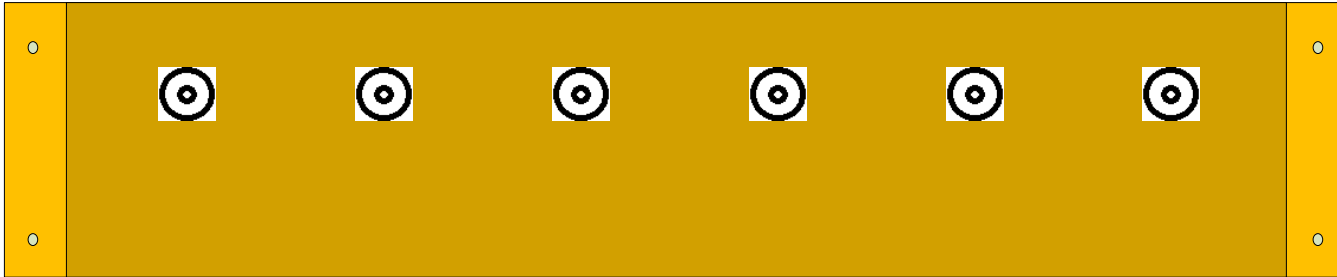

Dxxxxxxx

Front

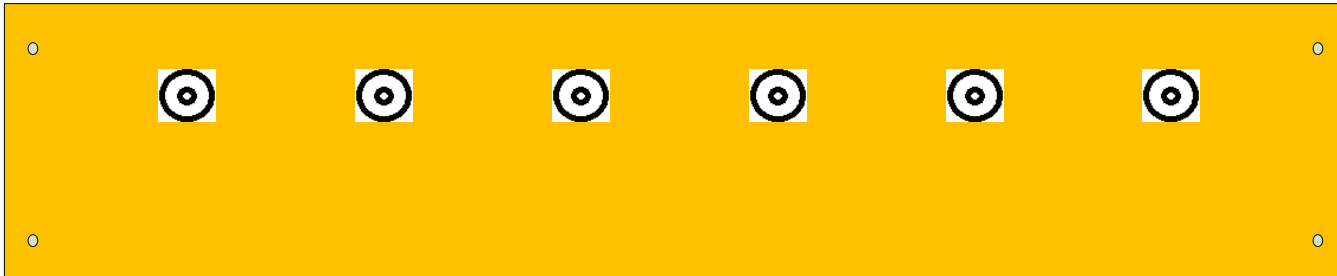

Sxxxxxxx

Rear

RF Patch Panel 8

Dxxxxxxx

Sxxxxxxx

No Power

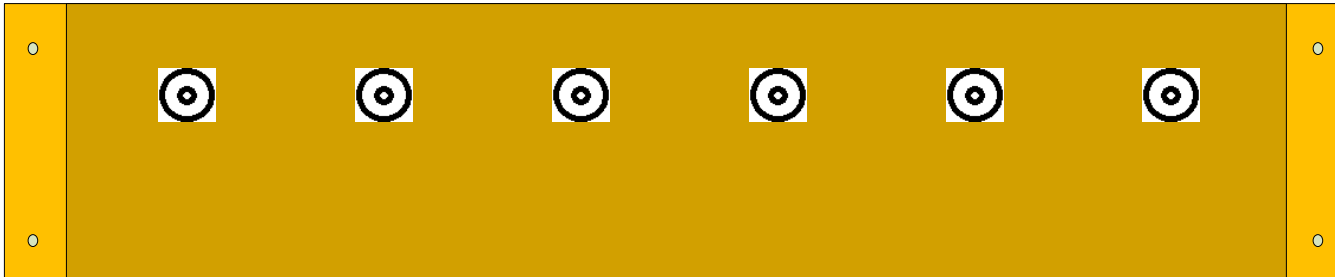

Dxxxxxxx

Front

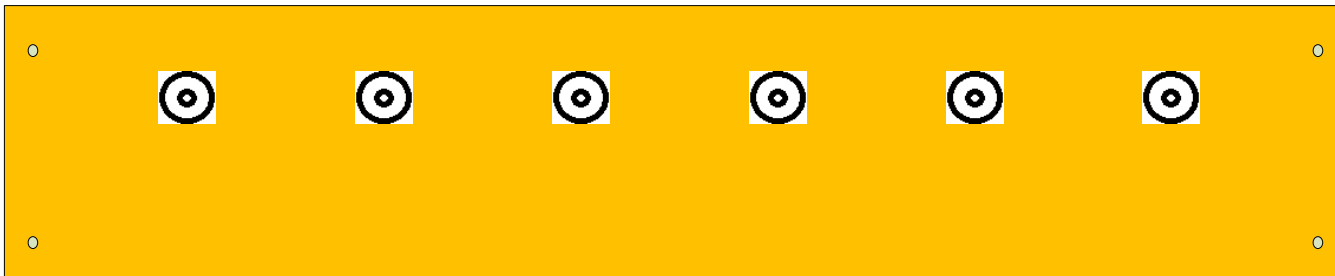

Sxxxxxxx

Rear

RF Patch Panel 9

Dxxxxxxx

Sxxxxxxx

No Power

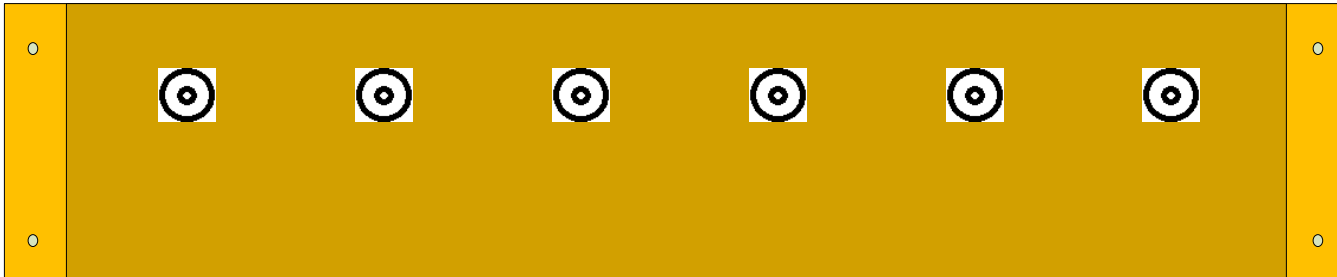

Dxxxxxxx

Front

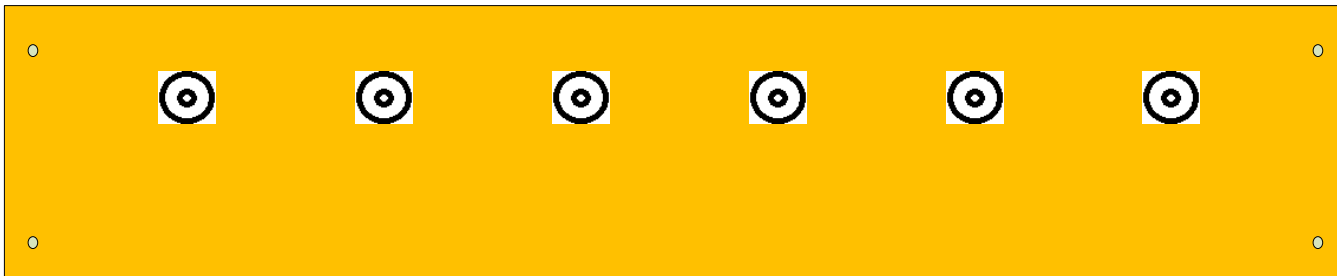

Sxxxxxxx

Rear

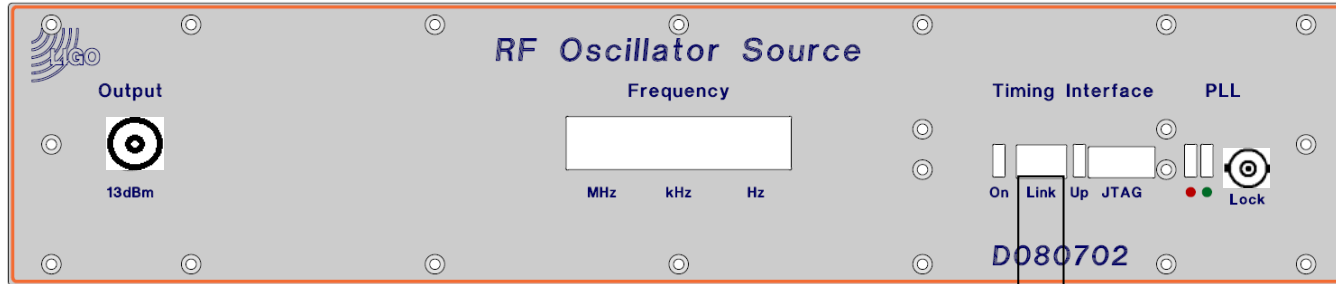

D080702

Front

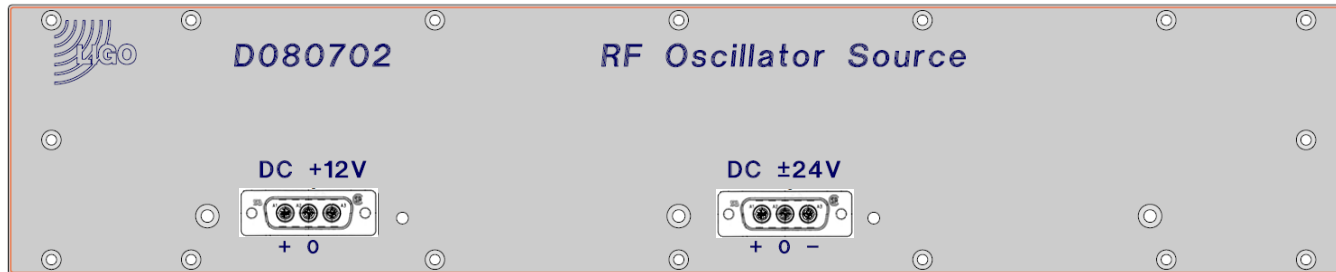
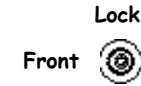

S1000546

Rear

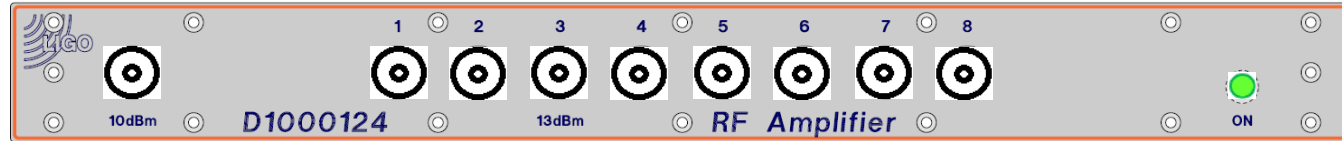

D1000124

Front

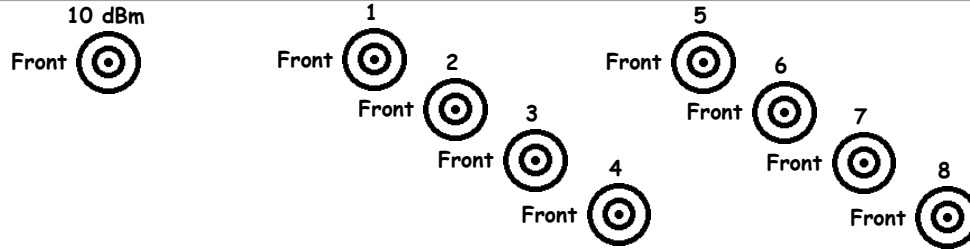

S1000649

Rear

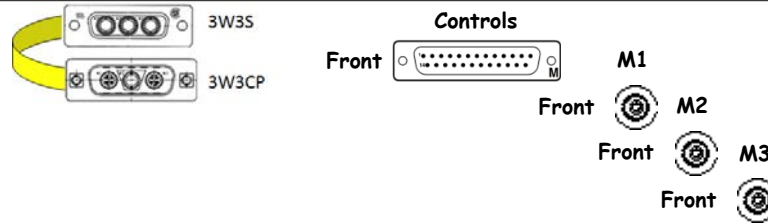

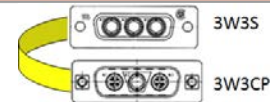
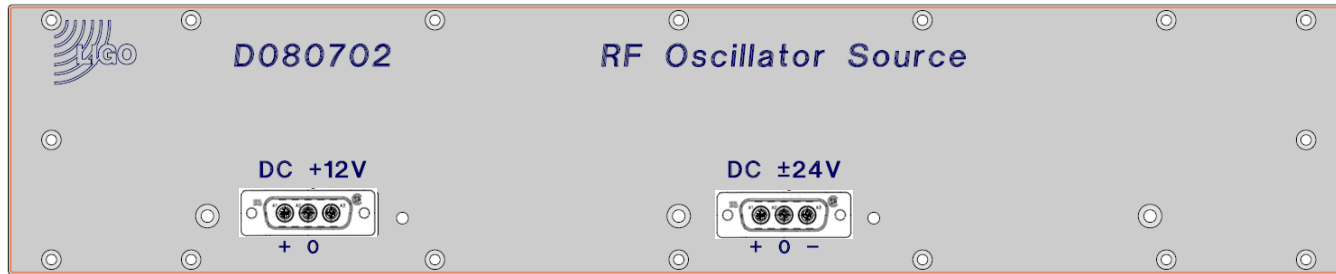
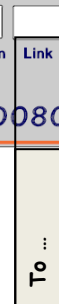
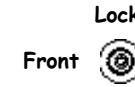
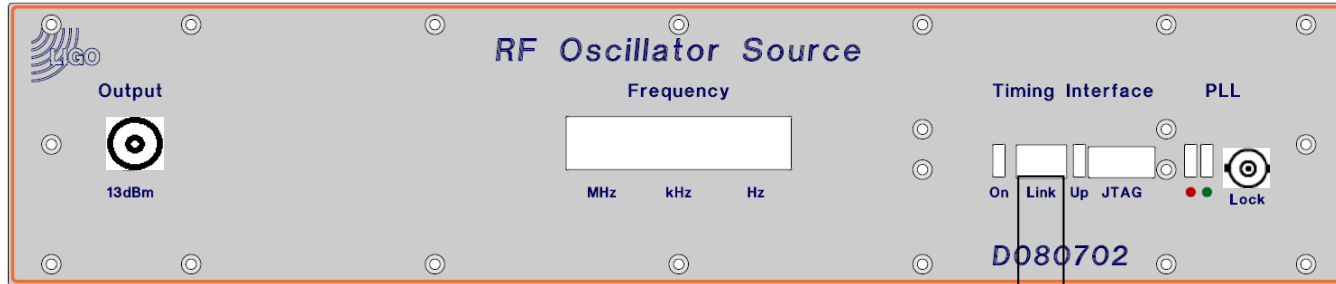

D080702

Front

S1000551

Rear

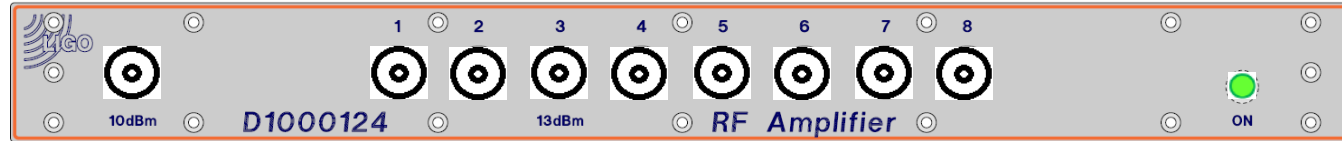

D1000124

Front

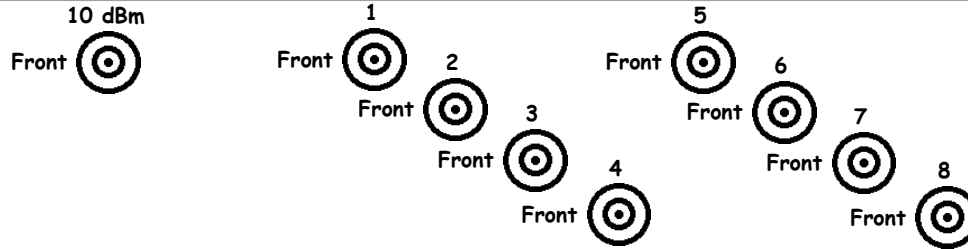

S1000650

Rear

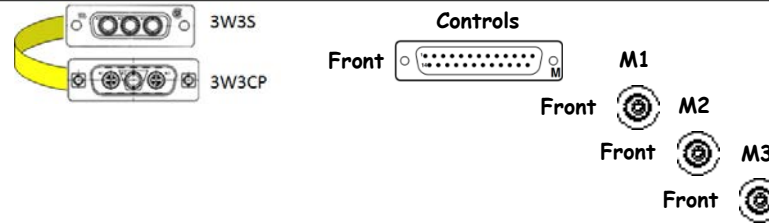

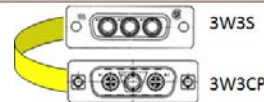
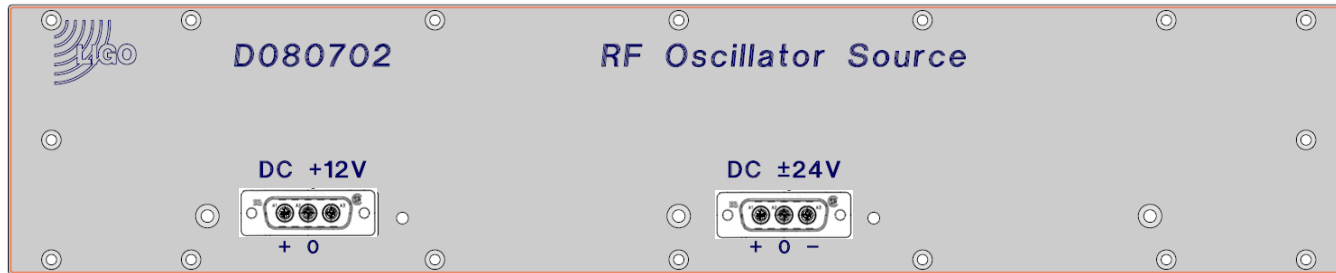
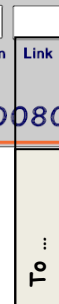
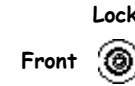
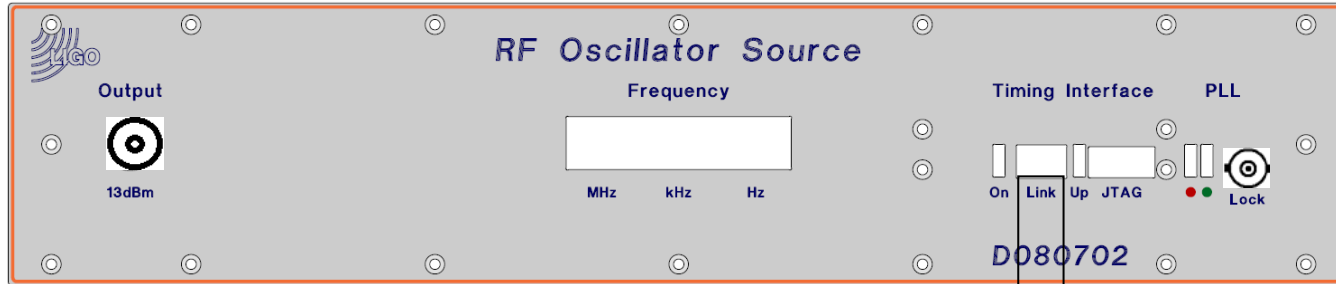

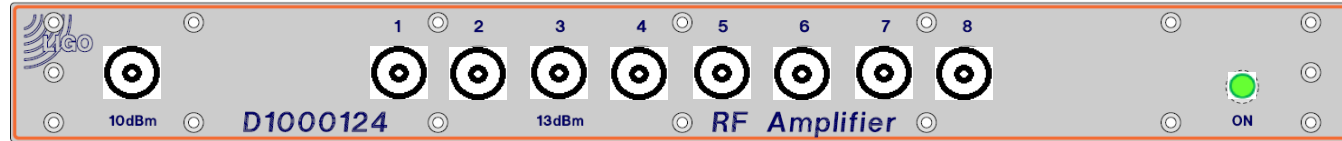

D1000124

Front

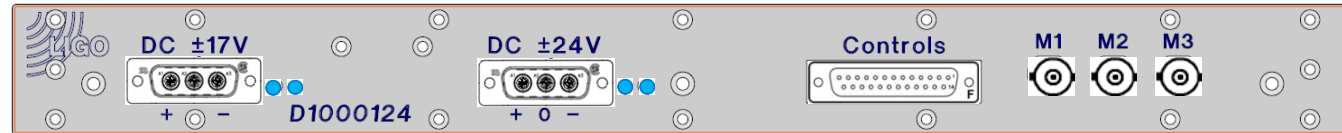
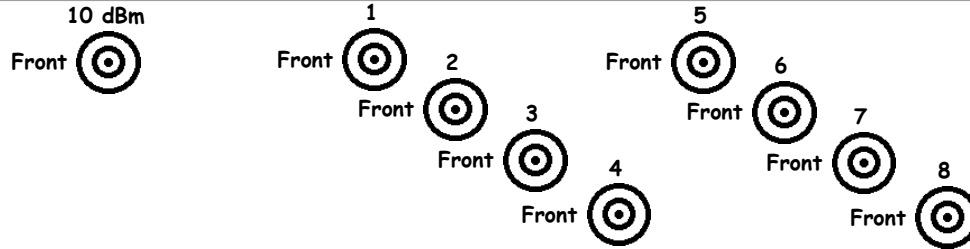

Sxxxxxxx

Rear

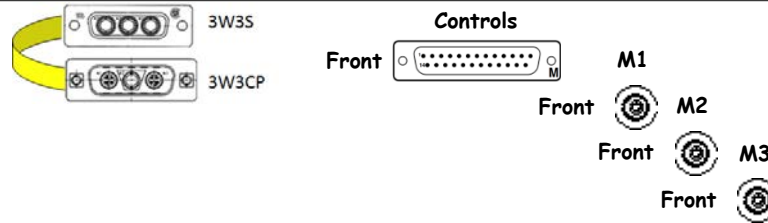

D1002182 - Sxxxxxxx

<< L1-ISC-C3

40 MHz Frequency Divider D1002182 Sxxxxxxx ±17VDC, ±24VDC

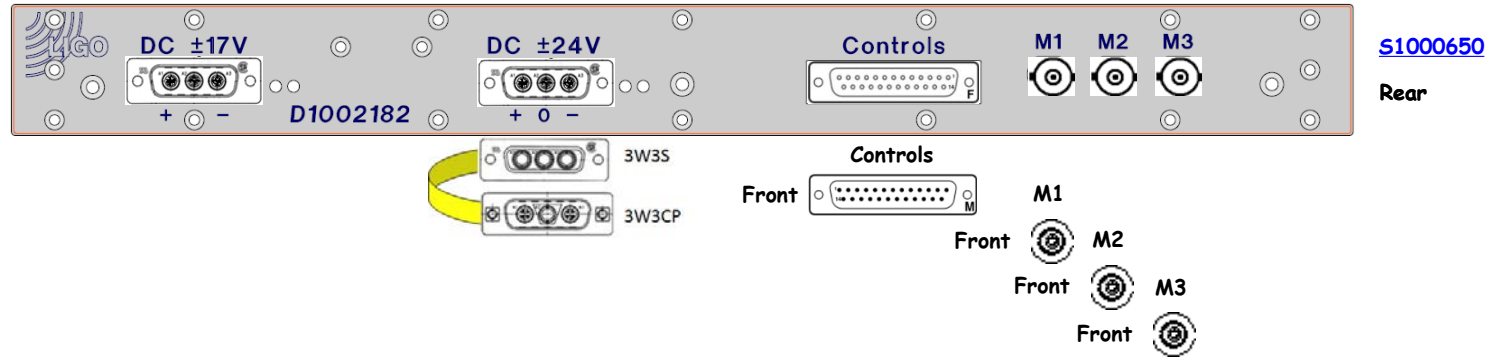
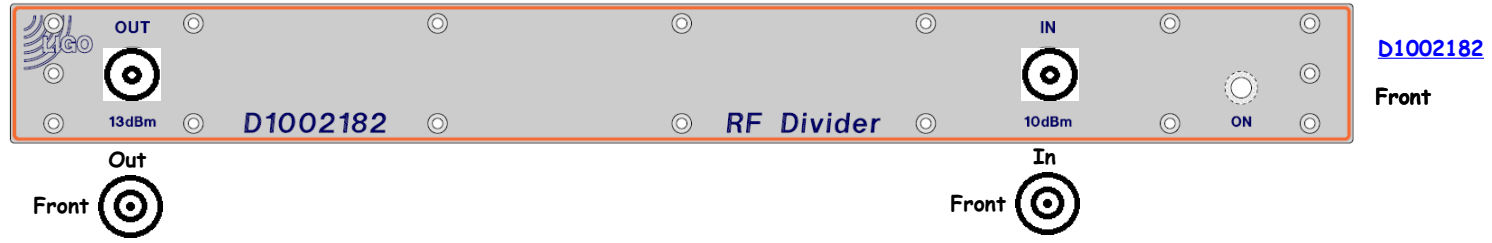

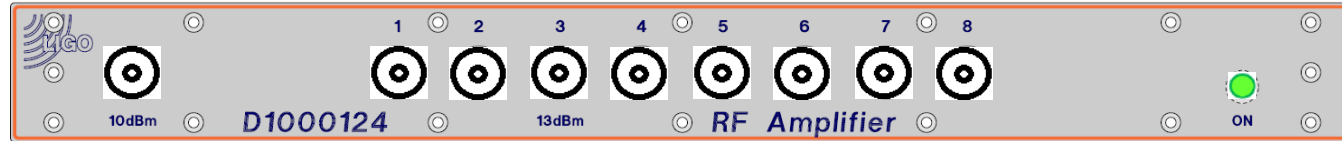

D1000124

Front

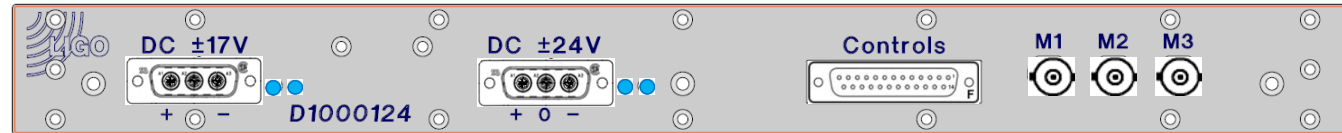
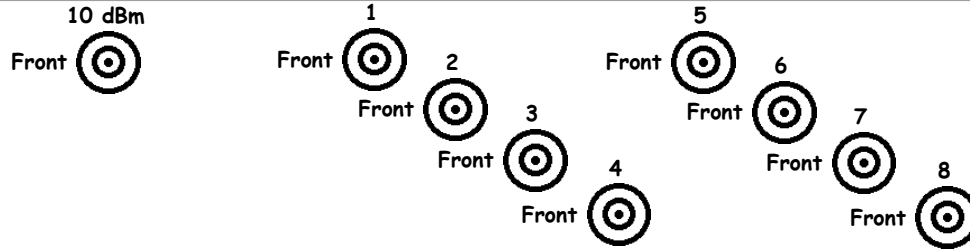

Sxxxxxxx

Rear

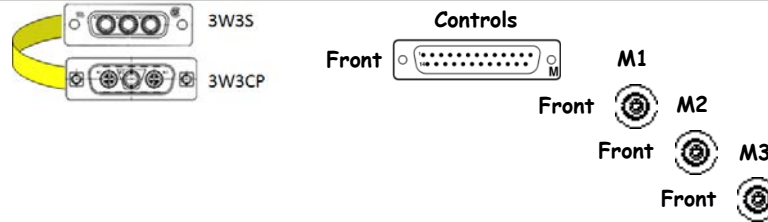

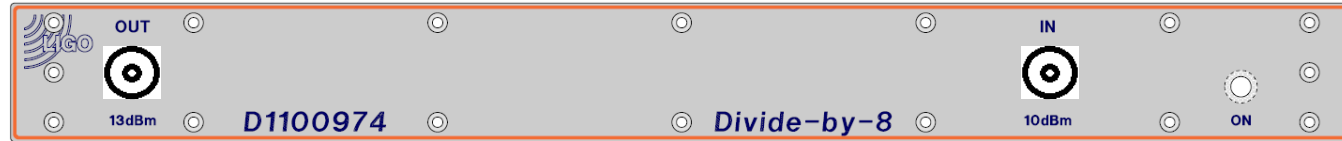

D1100974

Front

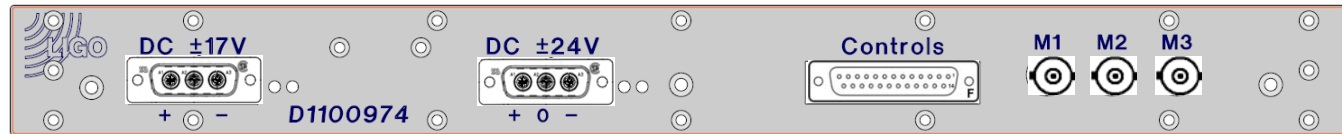

S1000650

Rear

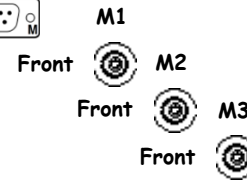
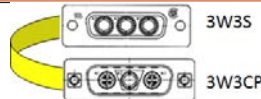

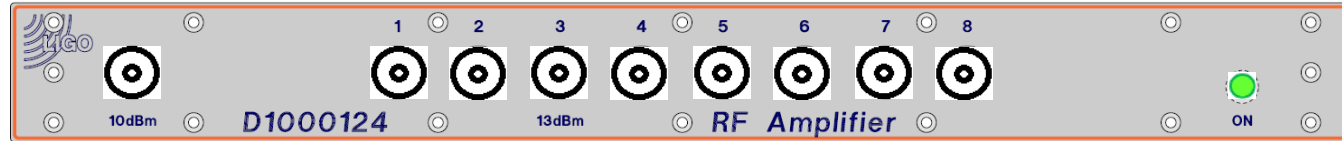

D1000124

Front

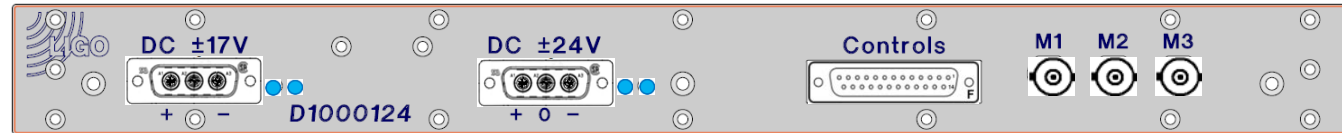
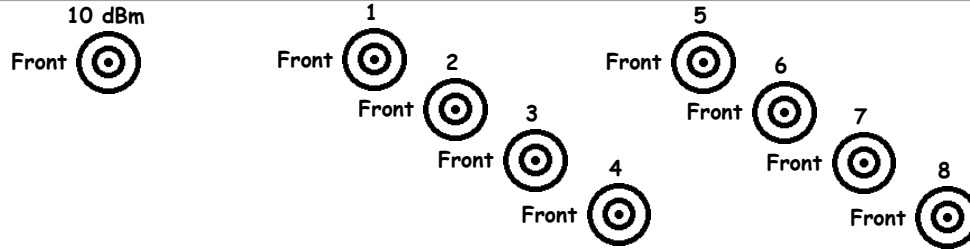

Sxxxxxxx

Rear

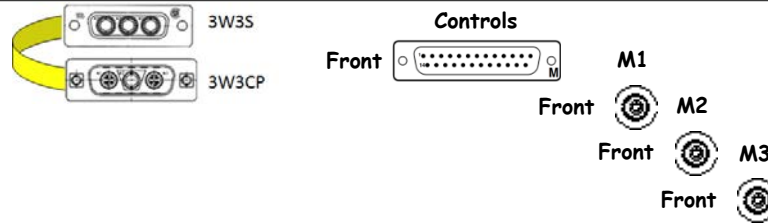



[D1100262](#)

Front

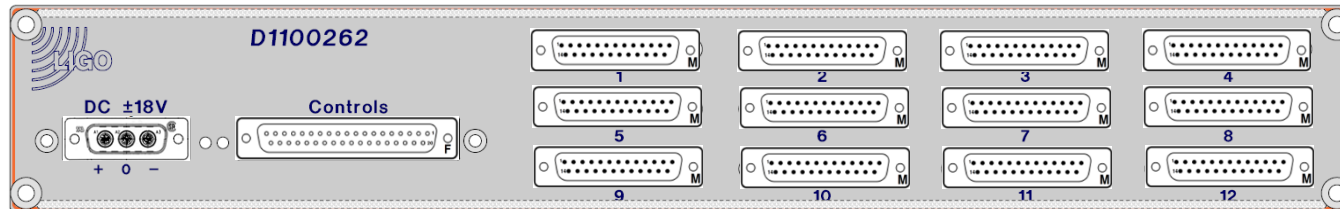

[S1001232](#)

Rear

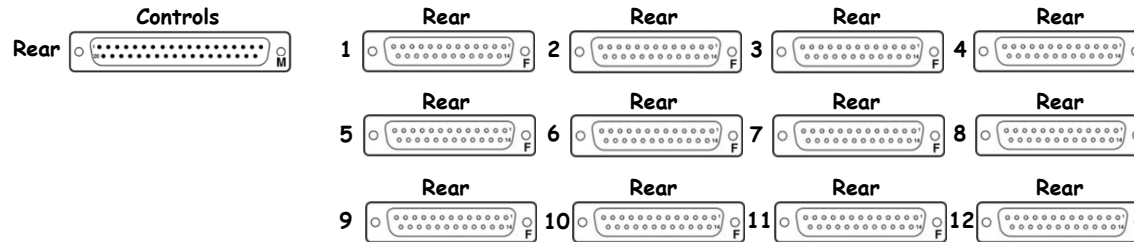



D1100262

Front

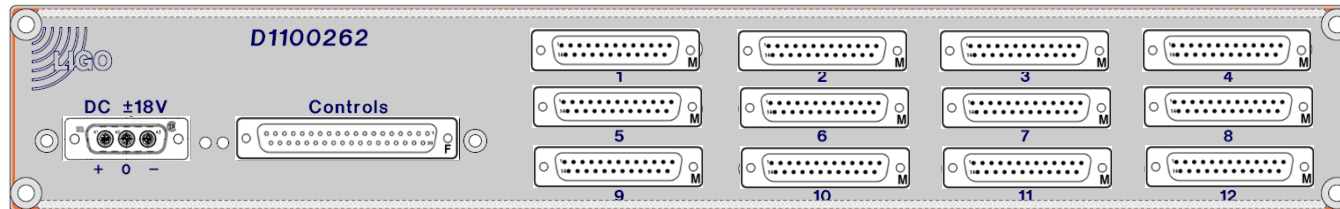

S1001232

Rear

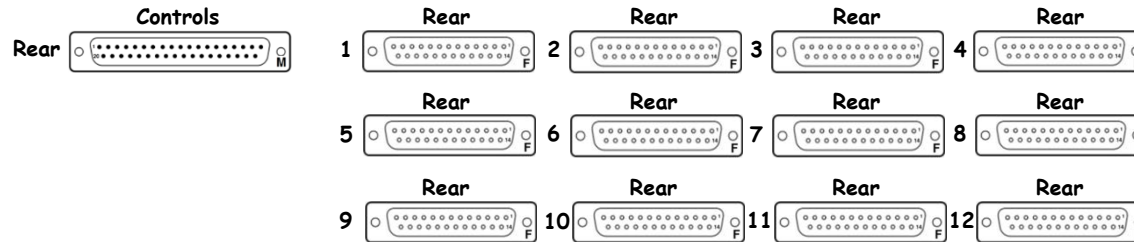

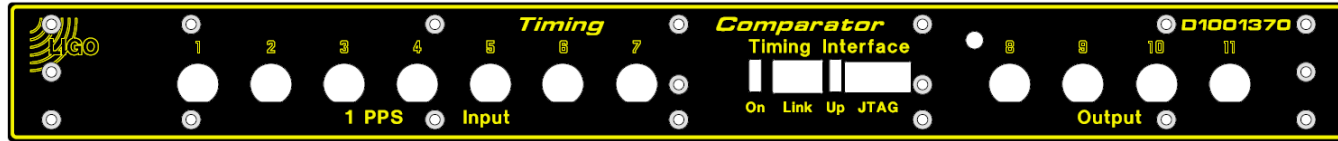

[D1001370](#)

Front

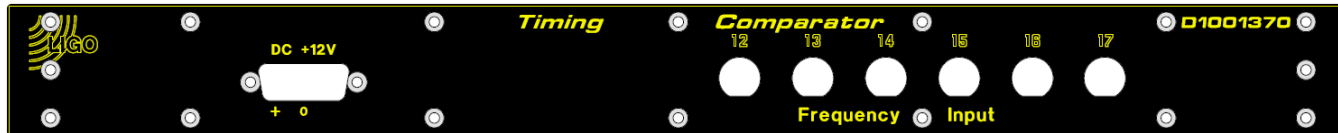

[S1001232](#)

Rear

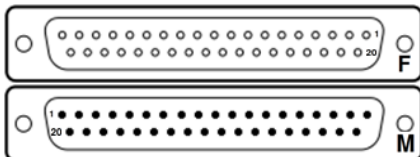

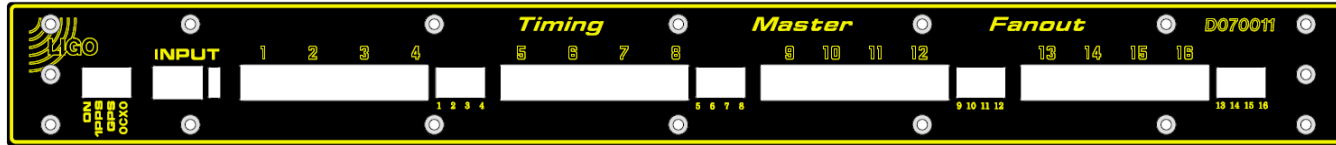

[D080534](#)

D070011

Front

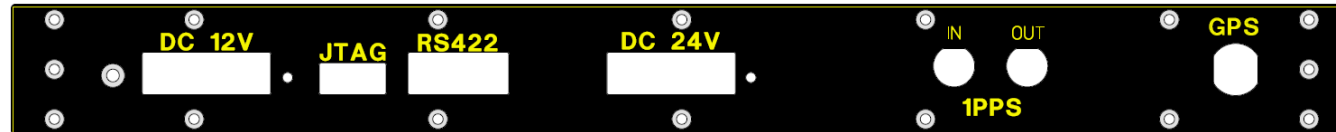

Master

[S1001232](#)

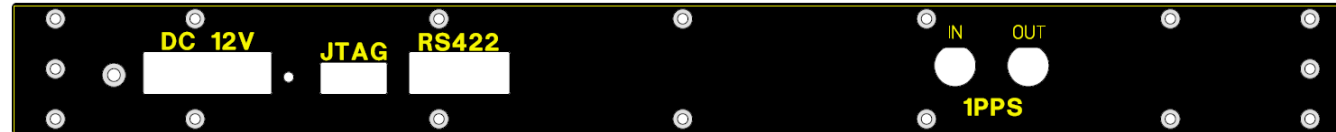

Fanout

Rear

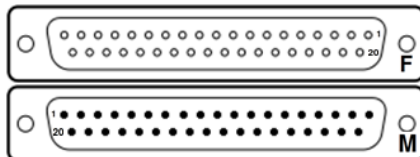

L1-ISC-C4

ISC LVEA Rack 4 Layout ([D1200977](#)) ([S1201189](#))

[D1200757](#)
Sequencer

[S1202562](#)



RF Patch Panel 1	Dxxxxxxx	42	Sxxxxxxx	No Power
RF Patch Panel 2	Dxxxxxxx	41	Sxxxxxxx	No Power
RF Patch Panel 3	Dxxxxxxx	40	Sxxxxxxx	No Power
RF Patch Panel 4	Dxxxxxxx	39	Sxxxxxxx	No Power
RF Patch Panel 5	Dxxxxxxx	38	Sxxxxxxx	No Power
RF Patch Panel 6	Dxxxxxxx	37	Sxxxxxxx	No Power
Aeroflex 2023A Diagnostics	Dxxxxxxx	36	Sxxxxxxx	No Power
9.099 / 8.684 MHz RF Source	D080702	35	Sxxxxxxx	No Power
9.099 / 8.684 MHz Distribution Amplifier	D1000124	34	Sxxxxxxx	No Power
9.099 / 8.684 MHz Harmonic Generator	Dxxxxxxx	33	Sxxxxxxx	No Power
9.099 / 8.684 MHz Harmonic Power Supply	D1002735	32	Sxxxxxxx	No Power
18 MHz Distribution Amplifier	D1000124	31	Sxxxxxxx	No Power
27 MHz Distribution Amplifier	D1000124	30	Sxxxxxxx	Power
36 MHz Distribution Amplifier	D1000124	29	Sxxxxxxx	+12VDC, ±24VDC
45 MHz Distribution Amplifier	D1000124	28	Sxxxxxxx	±17VDC, ±24VDC
90 MHz Distribution Amplifier	D1000124	27	Sxxxxxxx	
135 MHz Distribution Amplifier	D1000124	26	Sxxxxxxx	
		25		
		24		
	Dxxxxxxx	23	Sxxxxxxx	From D1002735
	D1002735	22	Sxxxxxxx	±17VDC, ±24VDC
	D1000124	21	Sxxxxxxx	±17VDC, ±24VDC
	D1000124	20	Sxxxxxxx	±17VDC, ±24VDC
	D1000124	19	Sxxxxxxx	±17VDC, ±24VDC
	D1000124	18	Sxxxxxxx	±17VDC, ±24VDC
	D1000124	17	Sxxxxxxx	±17VDC, ±24VDC
	D1000124	16	Sxxxxxxx	±17VDC, ±24VDC
		15		
		14		
24.078 / 22.993 MHz RF Source	D080702	13	Sxxxxxxx	+12VDC, ±24VDC
24.078 / 22.993 MHz Distribution Amplifier	D1000124	12	Sxxxxxxx	±17VDC, ±24VDC
71 MHz RF Source	D080702	11	Sxxxxxxx	+12VDC, ±24VDC
71 MHz Distribution Amplifier	D1000124	10	Sxxxxxxx	±17VDC, ±24VDC
		9		
		8		
		7		
		6		
		5		
		4		
		3		
		2		
		1		
	Front		Rear	

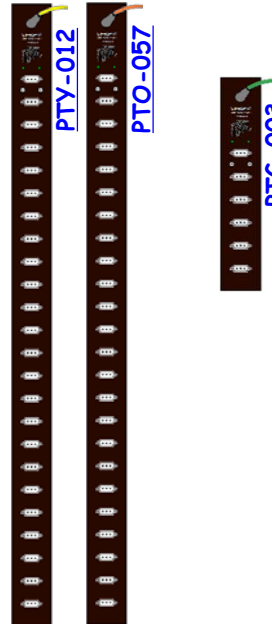

ISC-C4 is part of [D1001427](#).

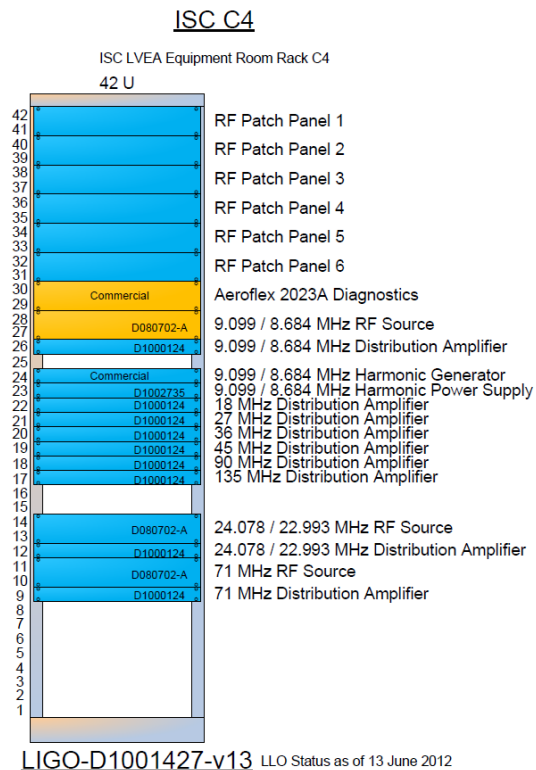

([D1001427](#))

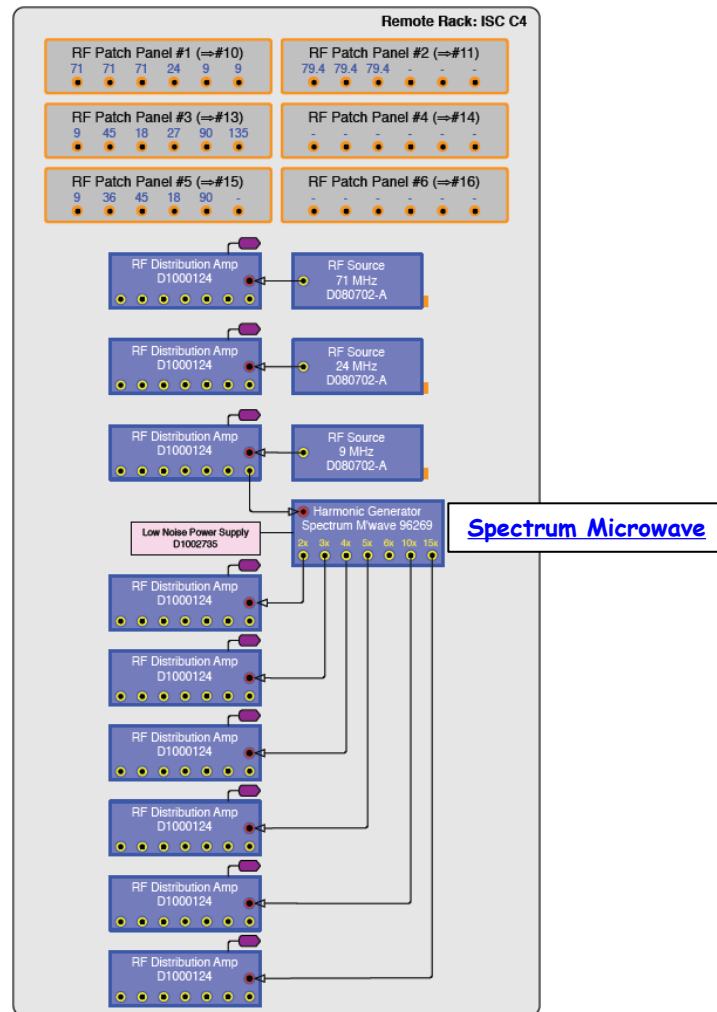

([D1100170](#))

L1-ISC-C4 Details

ISC-C4 is part of [D1001427](#).

RF Patch Panel 1

<< [L1-ISC-C4](#)

RF Patch Panel 1

Dxxxxxxx

Sxxxxxxx

No Power

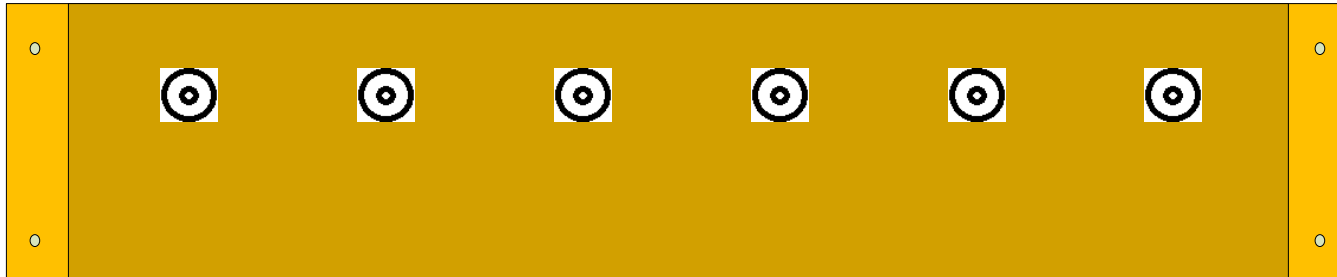

Dxxxxxxx

Front

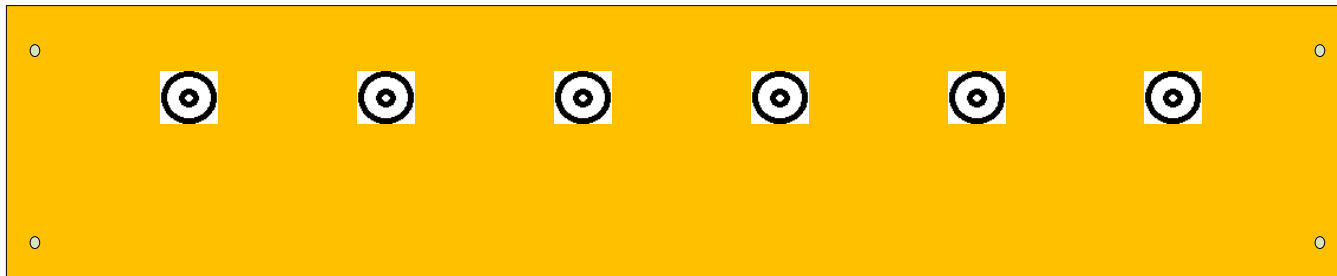

Sxxxxxxx

Rear

RF Patch Panel 2

Dxxxxxxx

Sxxxxxxx

No Power

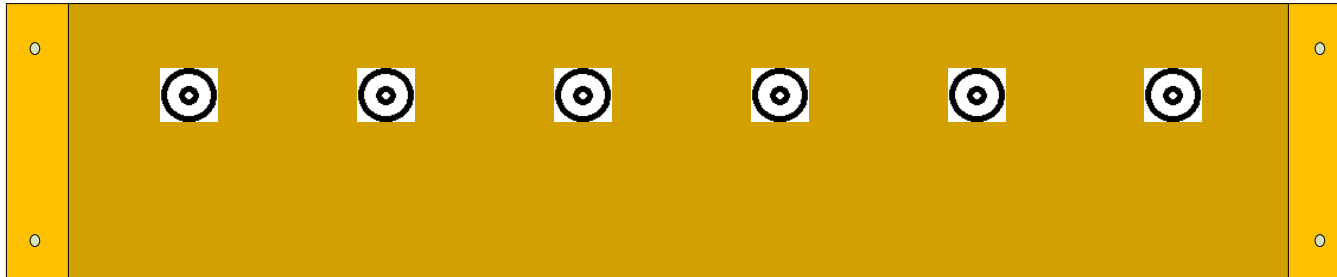

Dxxxxxxx

Front

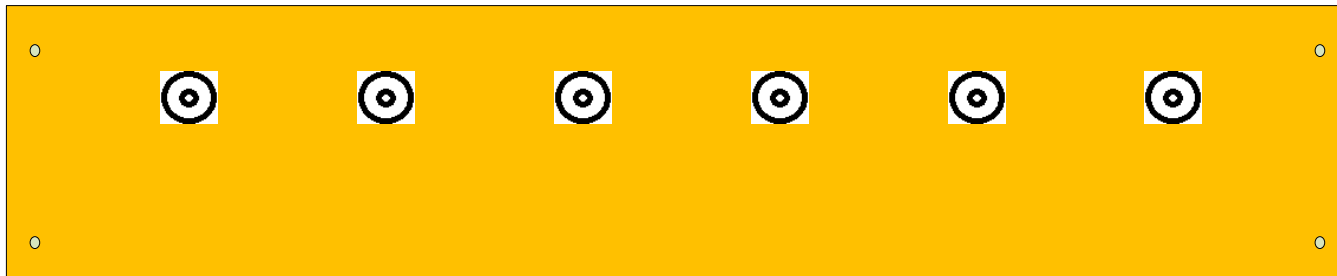

Sxxxxxxx

Rear

RF Patch Panel 3

Dxxxxxxx

Sxxxxxxx

No Power

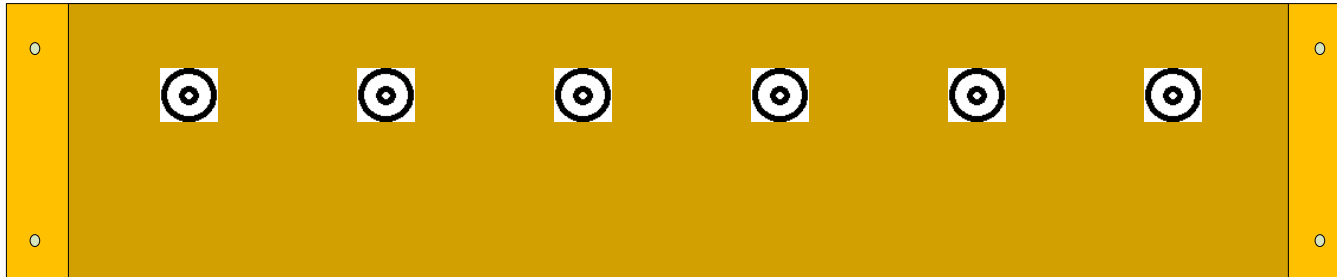

Dxxxxxxx

Front

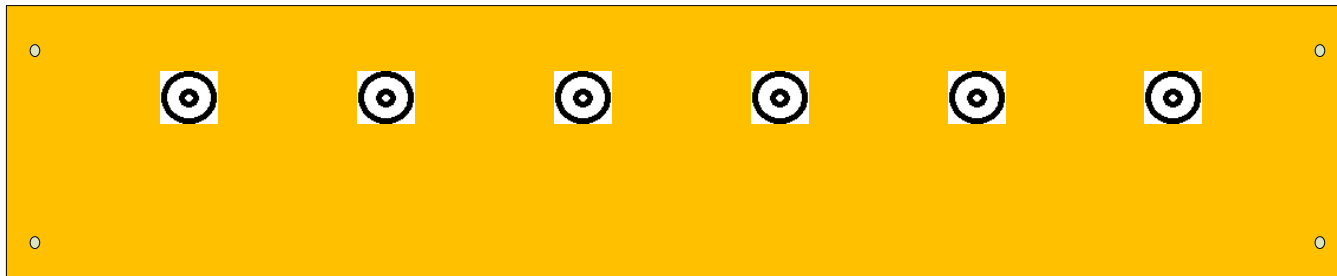

Sxxxxxxx

Rear

RF Patch Panel 4

Dxxxxxxx

Sxxxxxxx

No Power

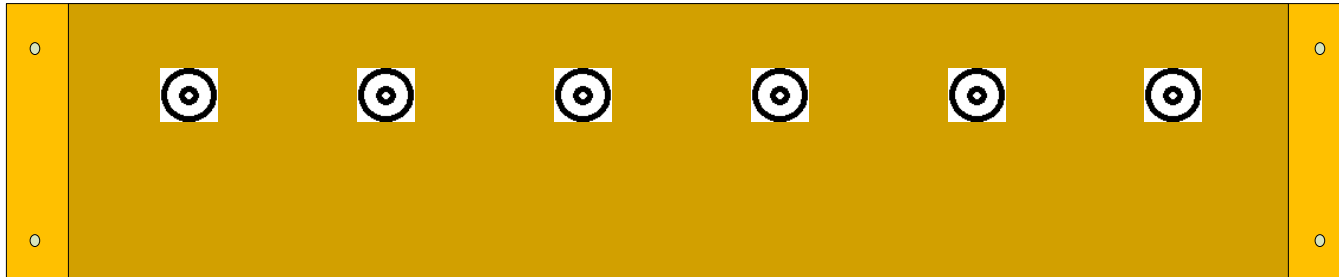

Dxxxxxxx

Front

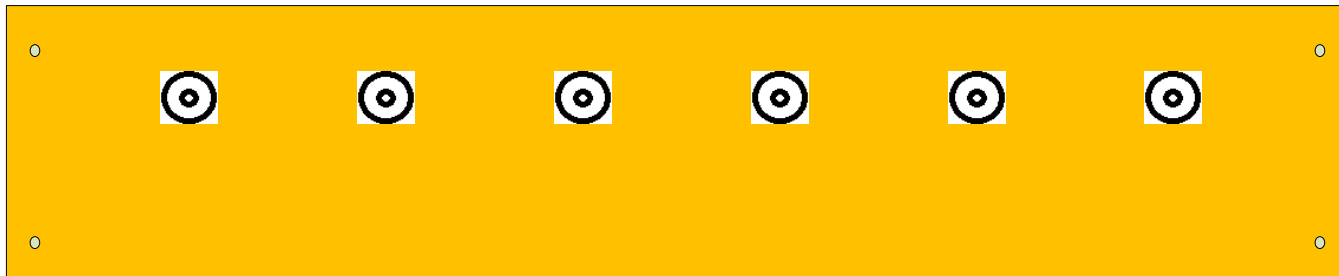

Sxxxxxxx

Rear

RF Patch Panel 5

Dxxxxxxx

Sxxxxxxx

No Power

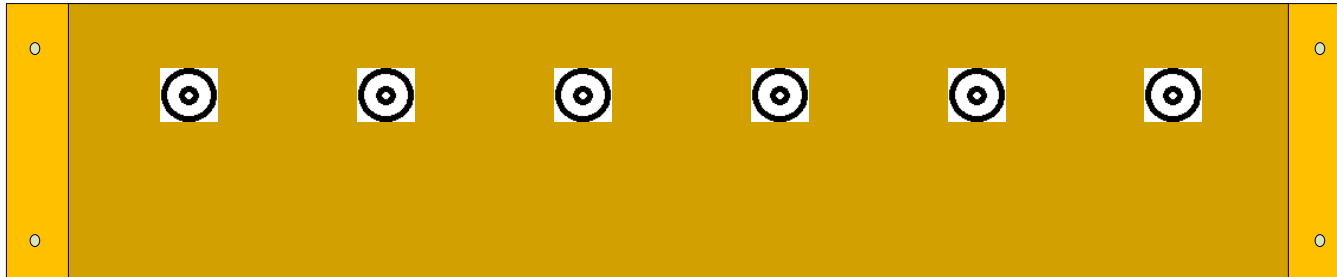

Dxxxxxxx

Front

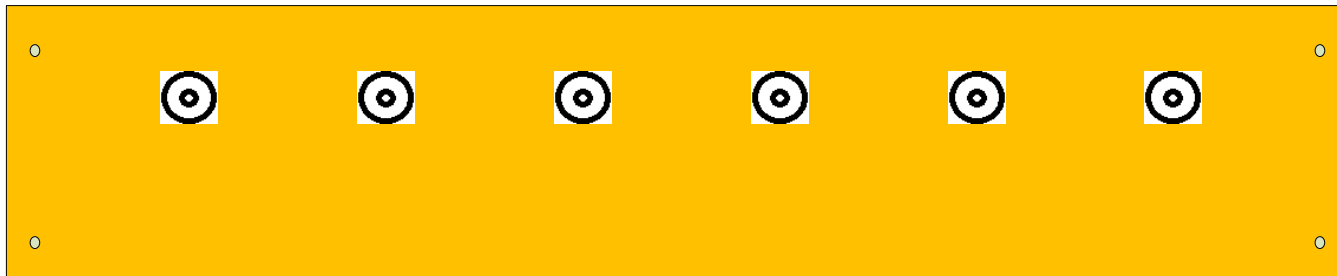

Sxxxxxxx

Rear

RF Patch Panel 6

Dxxxxxxx

Sxxxxxxx

No Power

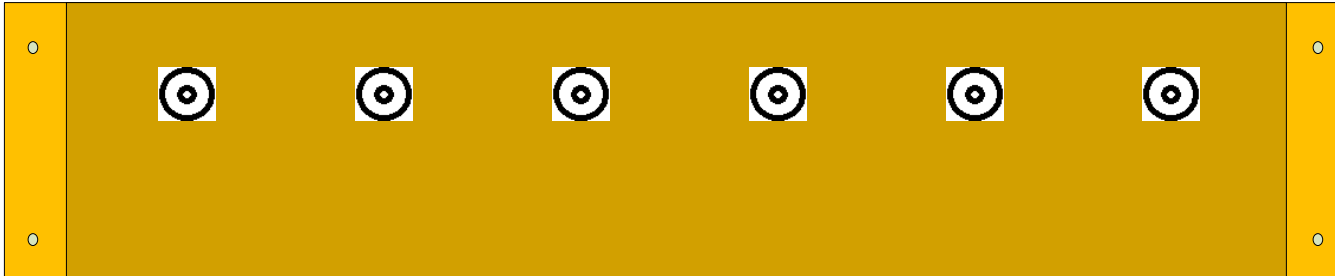

Dxxxxxxx

Front

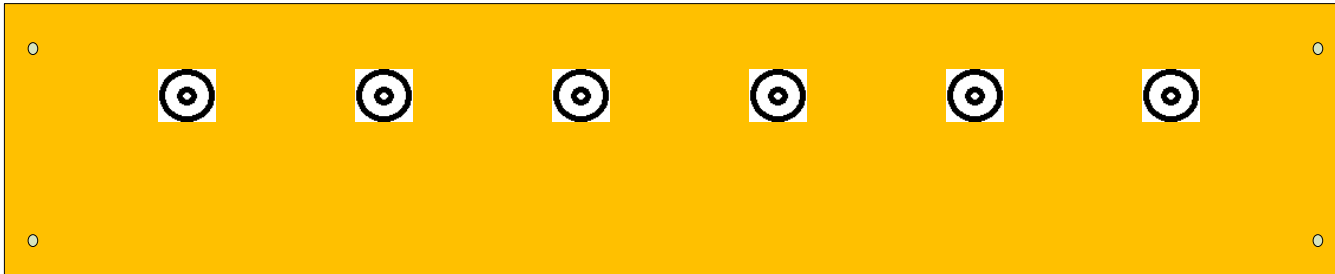

Sxxxxxxx

Rear

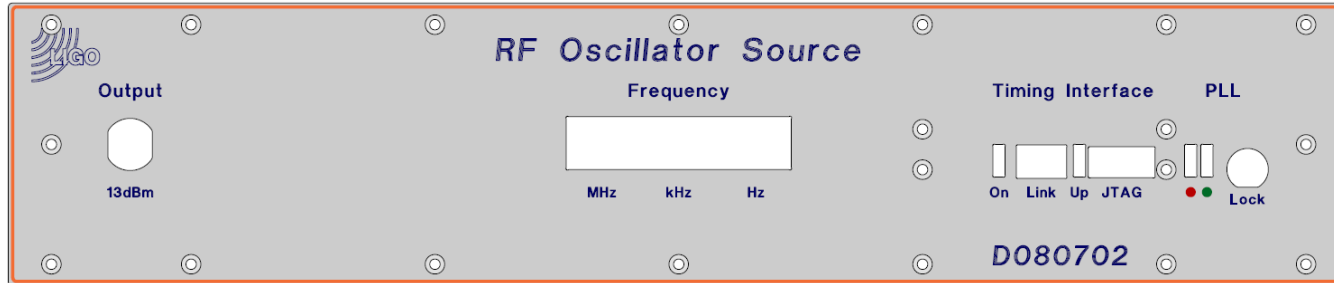

[D080702](#)

Front

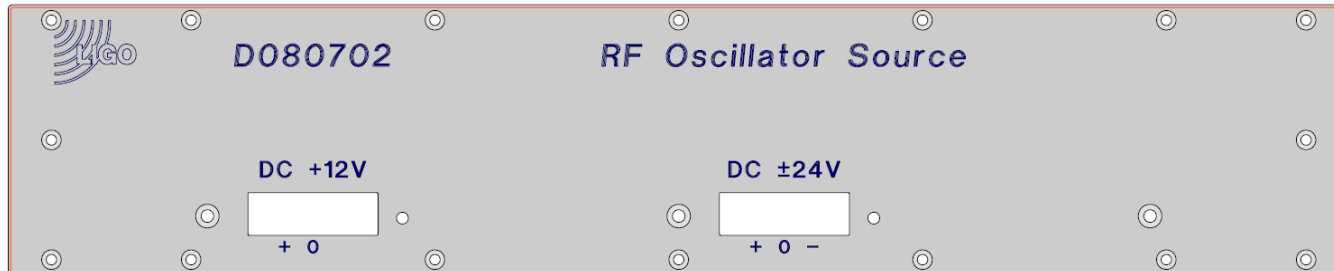

[S1001232](#)

Rear

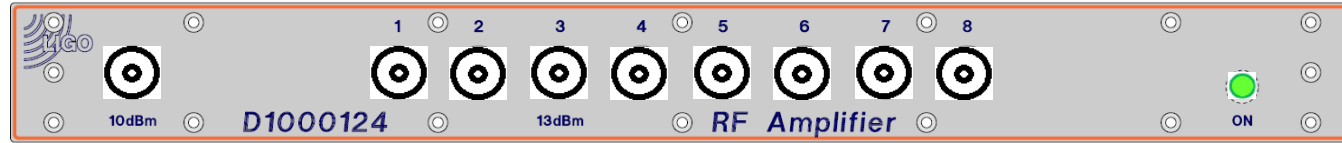

D1000124

Front

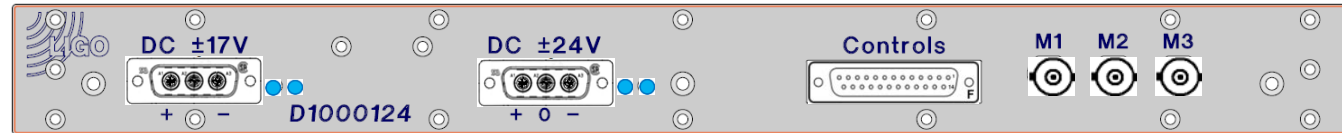
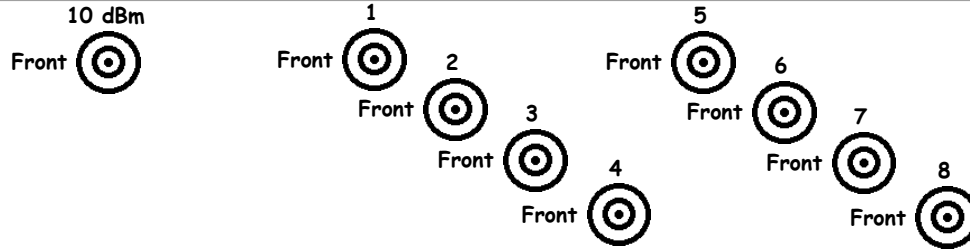

Sxxxxxxx

Rear

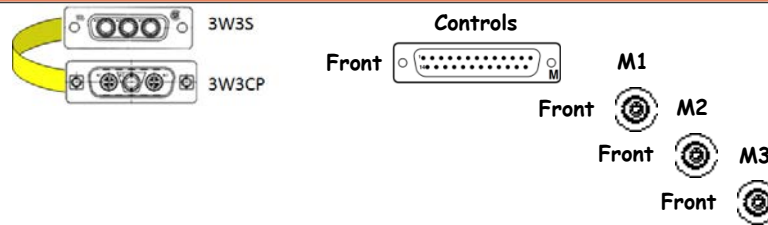

D1002735 - Sxxxxxxx

<< L1-ISC-C4

9.099 / 8.684 MHz Harmonic Generator Power Supply

D1002735

SN:

±17VDC, ±24VDC

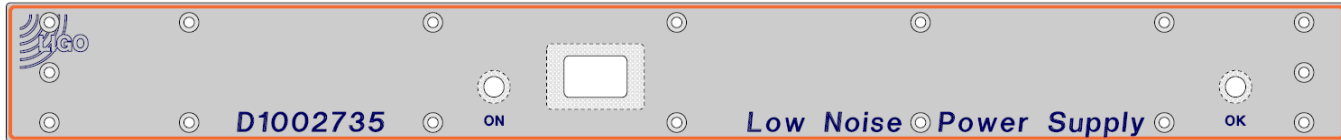

D1002735

Front

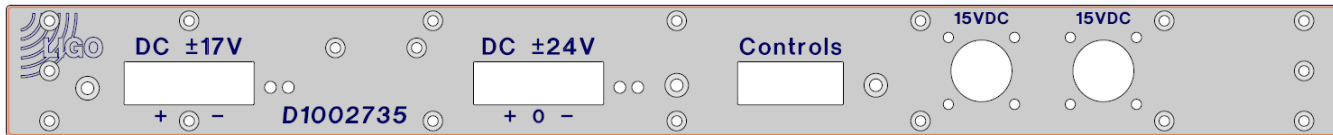

Sxxxxxxx

Rear

From DAC Adapter

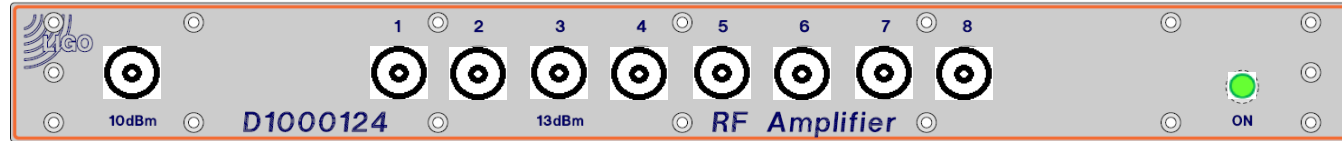

D1000124

Front

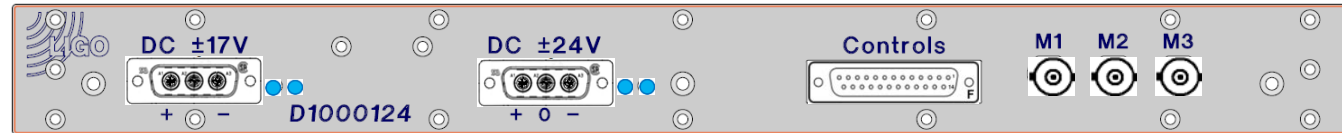
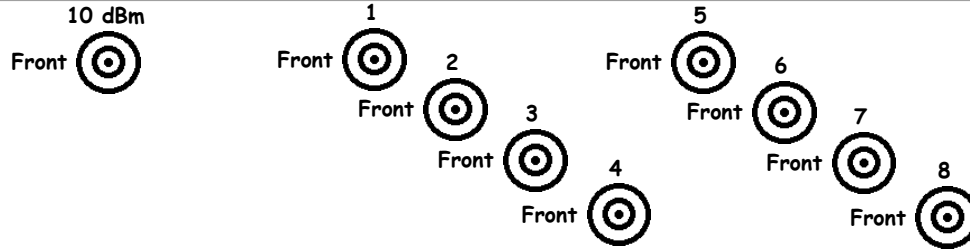

Sxxxxxxx

Rear

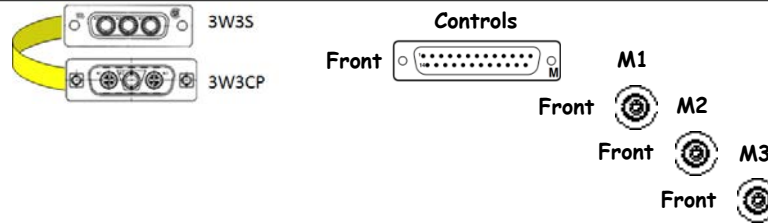

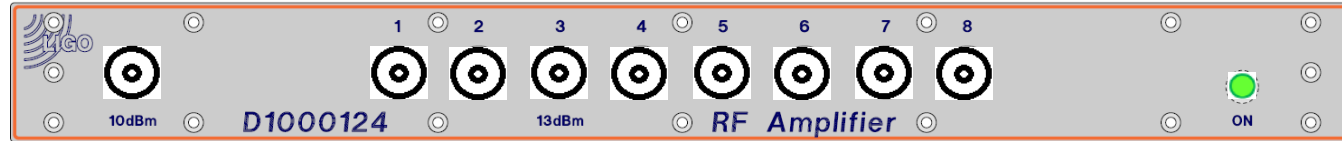

D1000124

Front

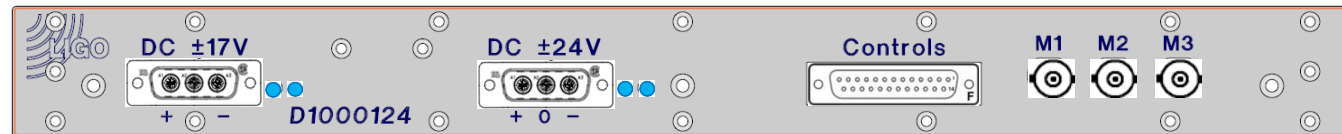
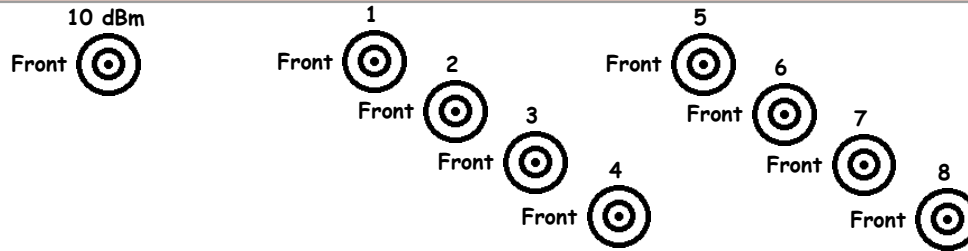

Sxxxxxxx

Rear

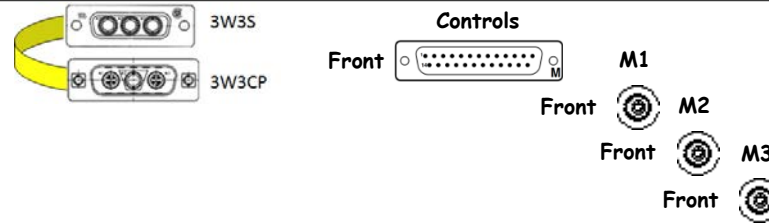

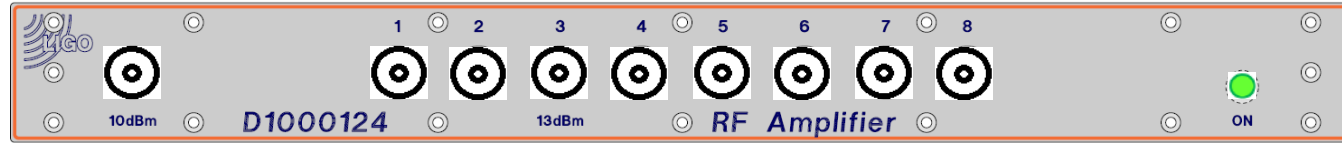

D1000124

Front

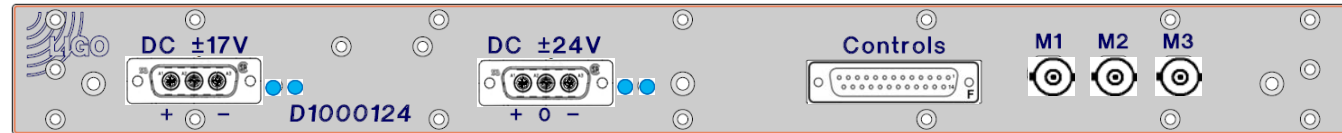
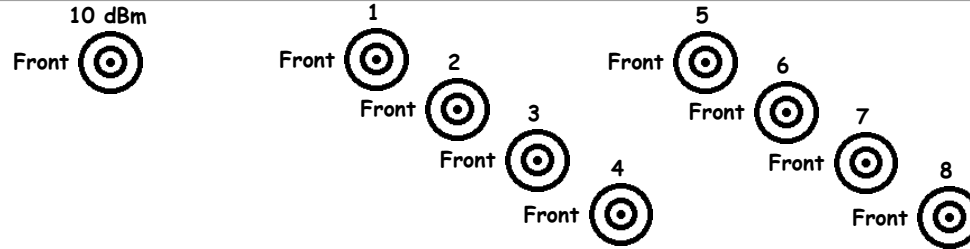

Sxxxxxxx

Rear

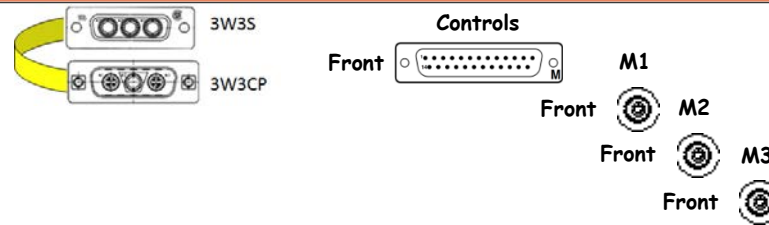

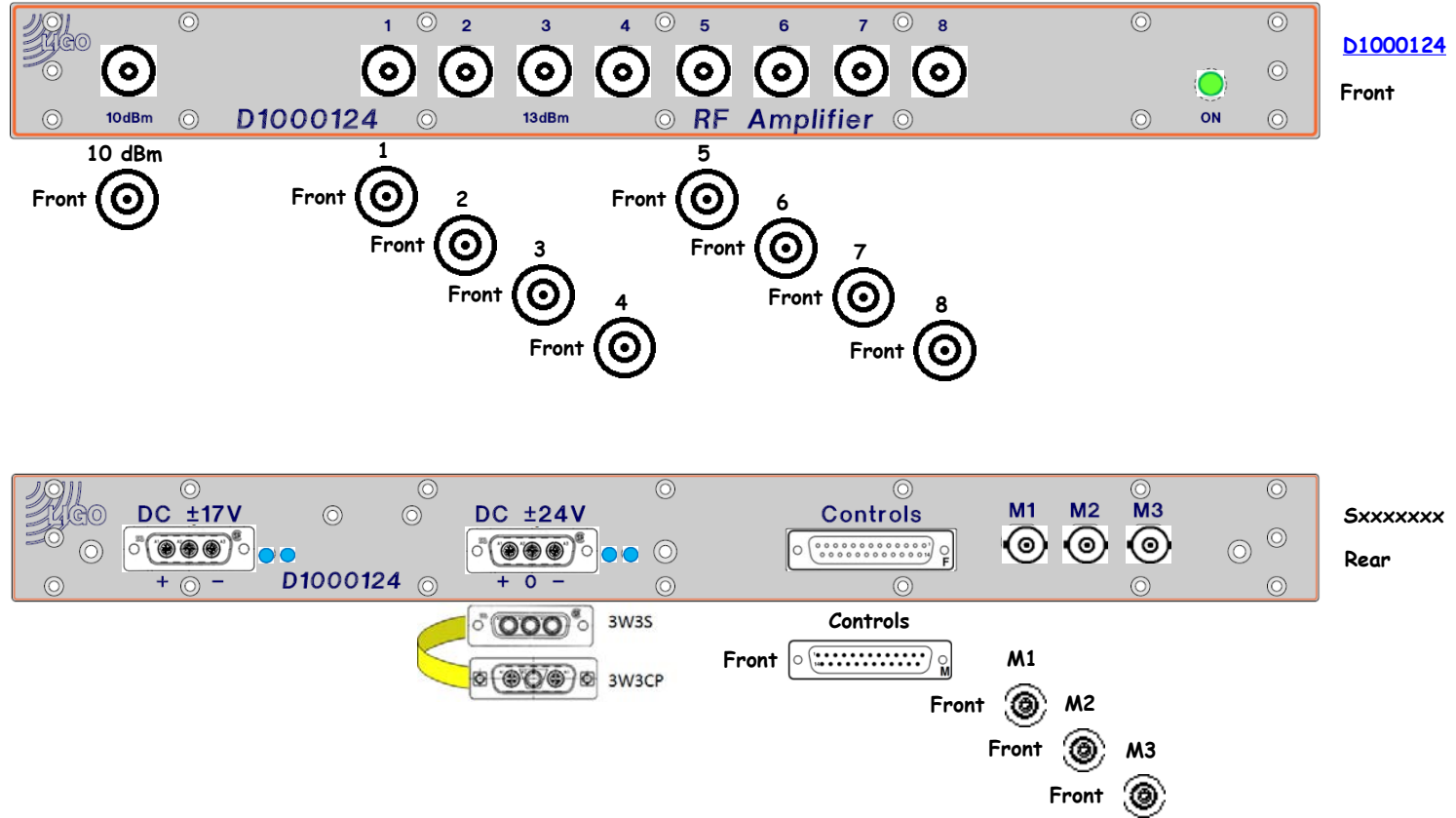

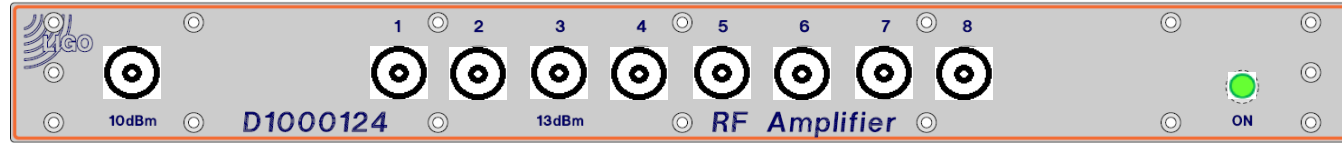

D1000124

Front

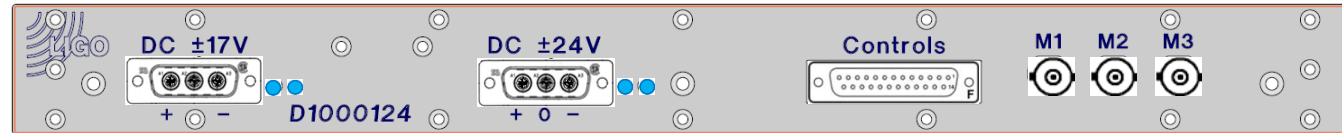
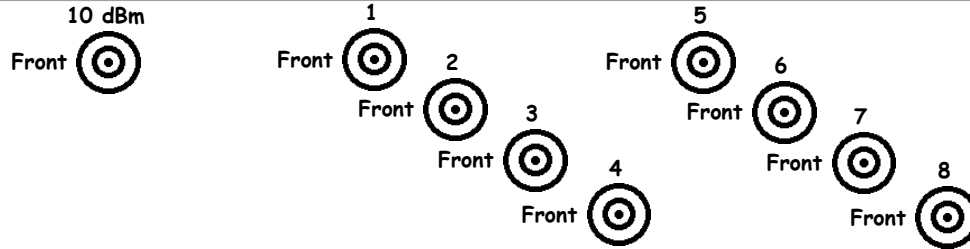

Sxxxxxxx

Rear

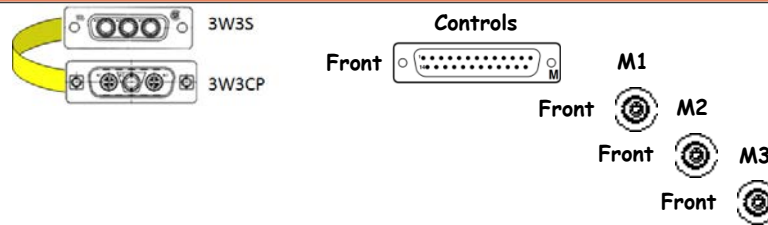

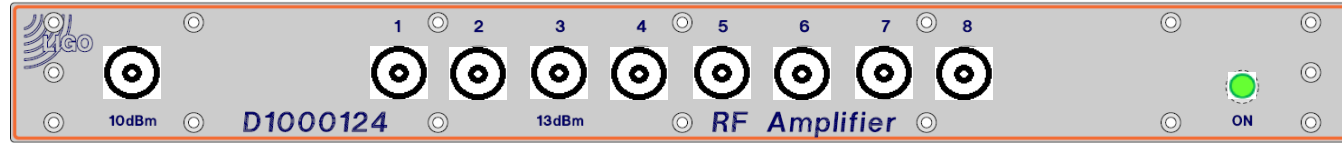

D1000124

Front

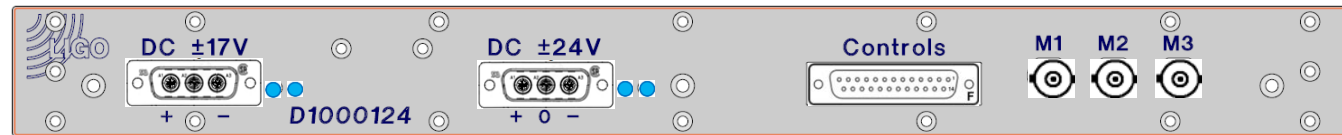
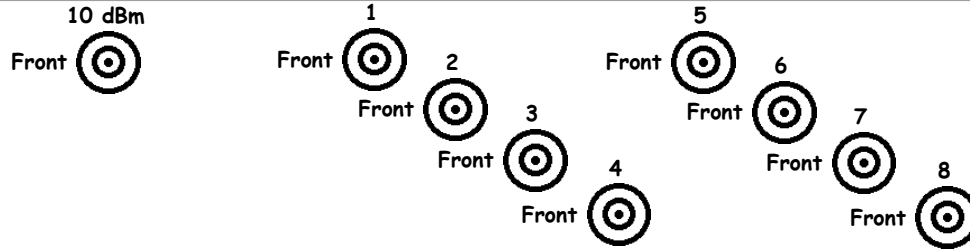

Sxxxxxxx

Rear

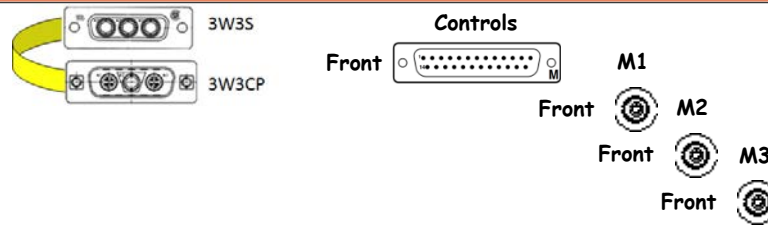

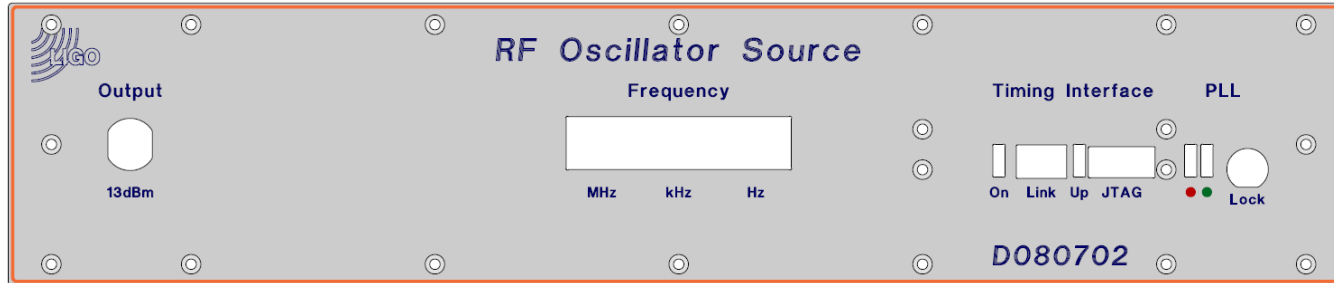

[D080702](#)

Front

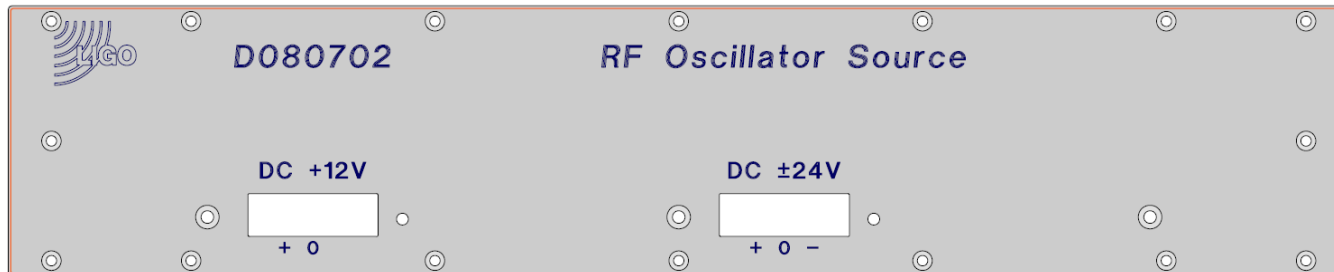

[S1001232](#)

Rear

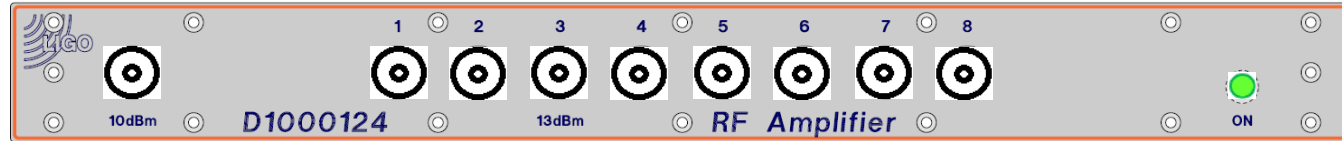

D1000124

Front

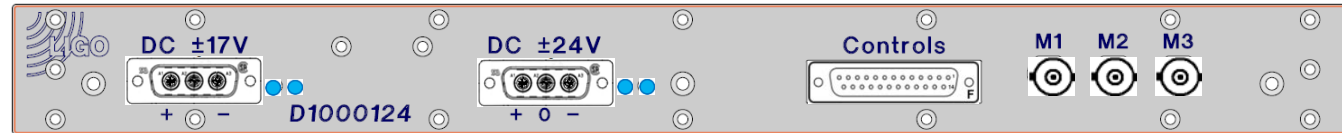
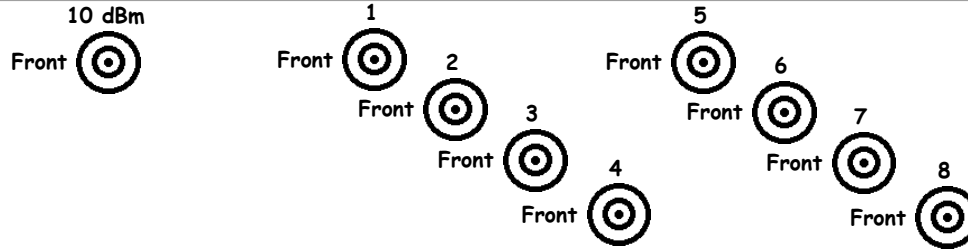

Sxxxxxxx

Rear

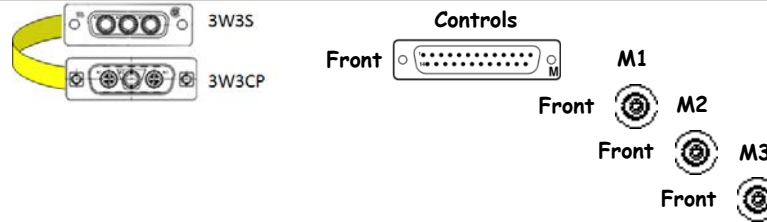

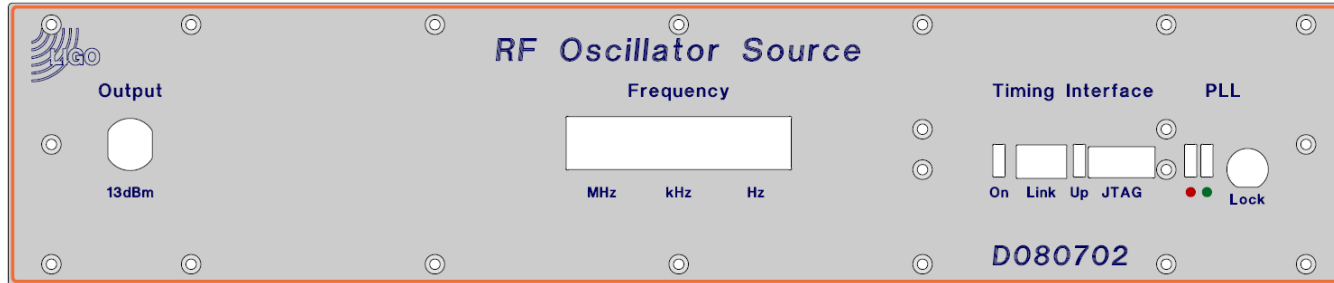

[D080702](#)

Front

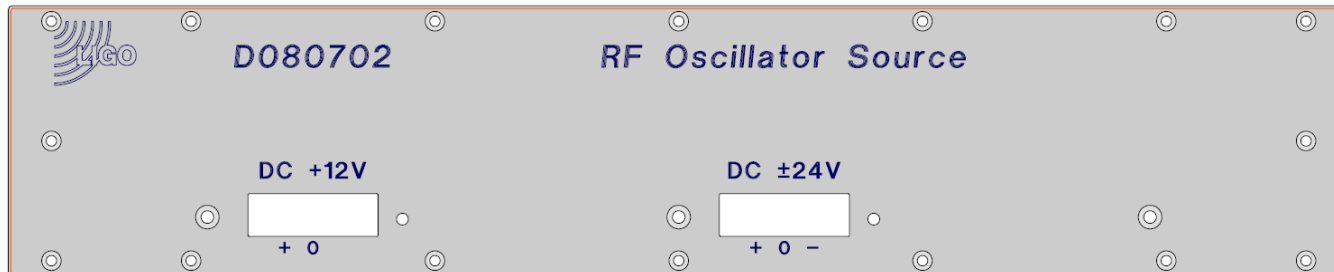

[S1001232](#)

Rear

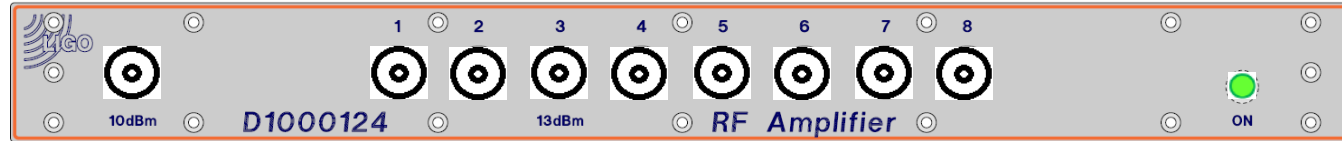

D1000124

Front

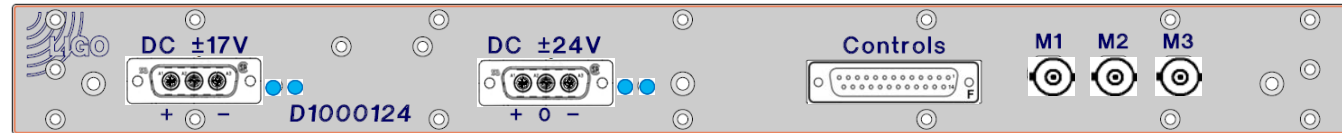
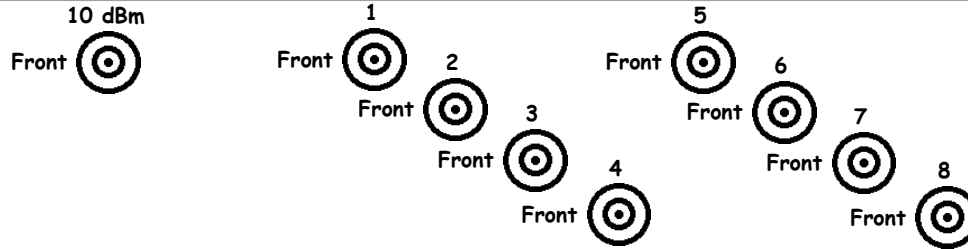

Sxxxxxxx

Rear

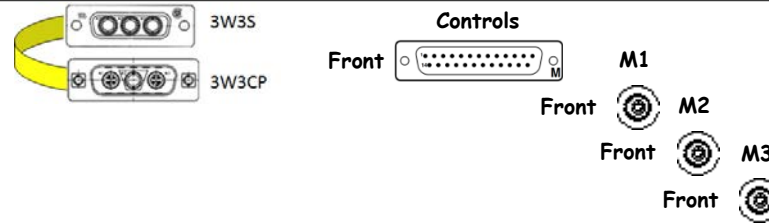

<< LLO Racks by Subsystem

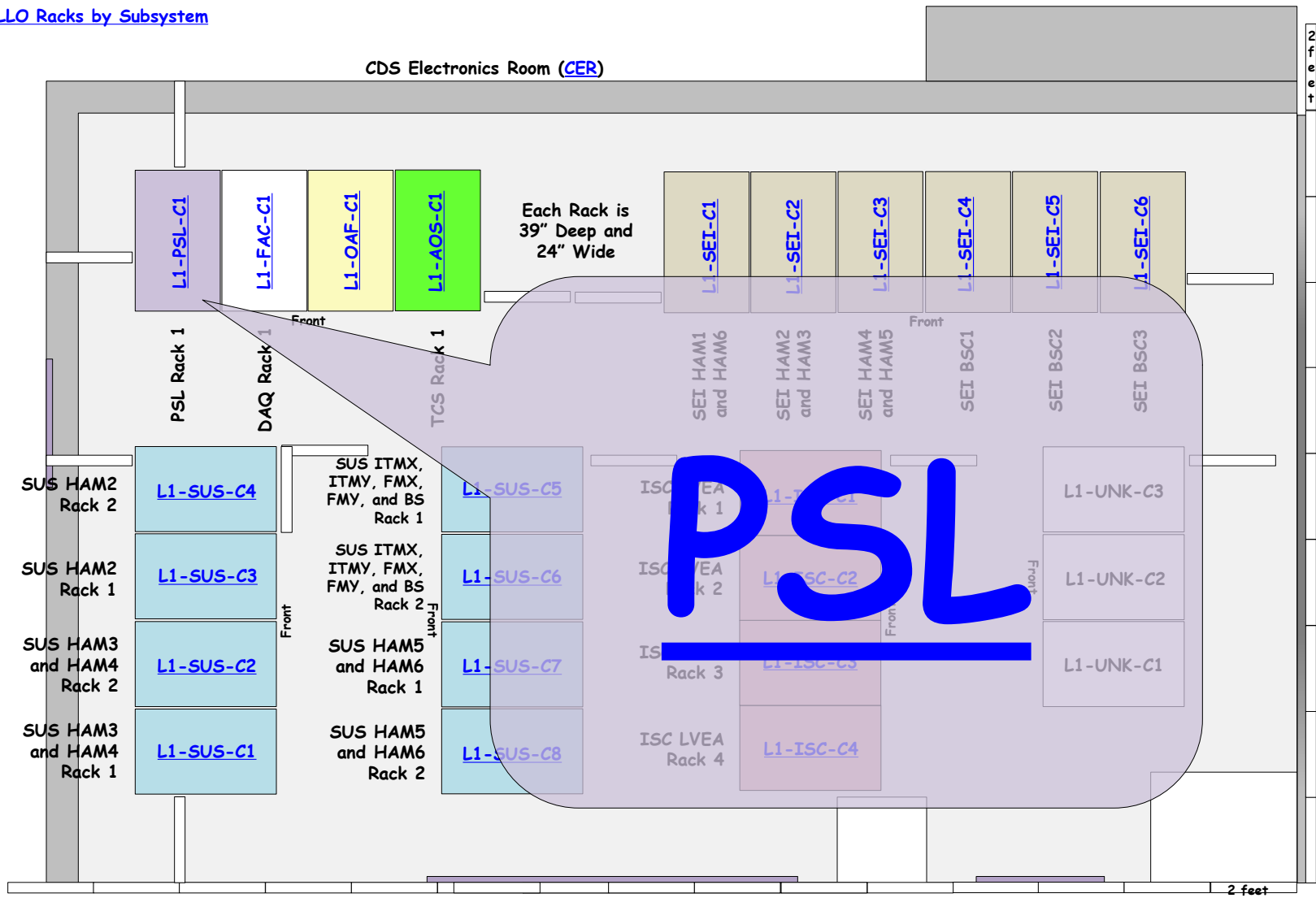

PSL Component List: [LIGO-T0900633](#)

PSL Table Layout: [LIGO-T0900610](#)

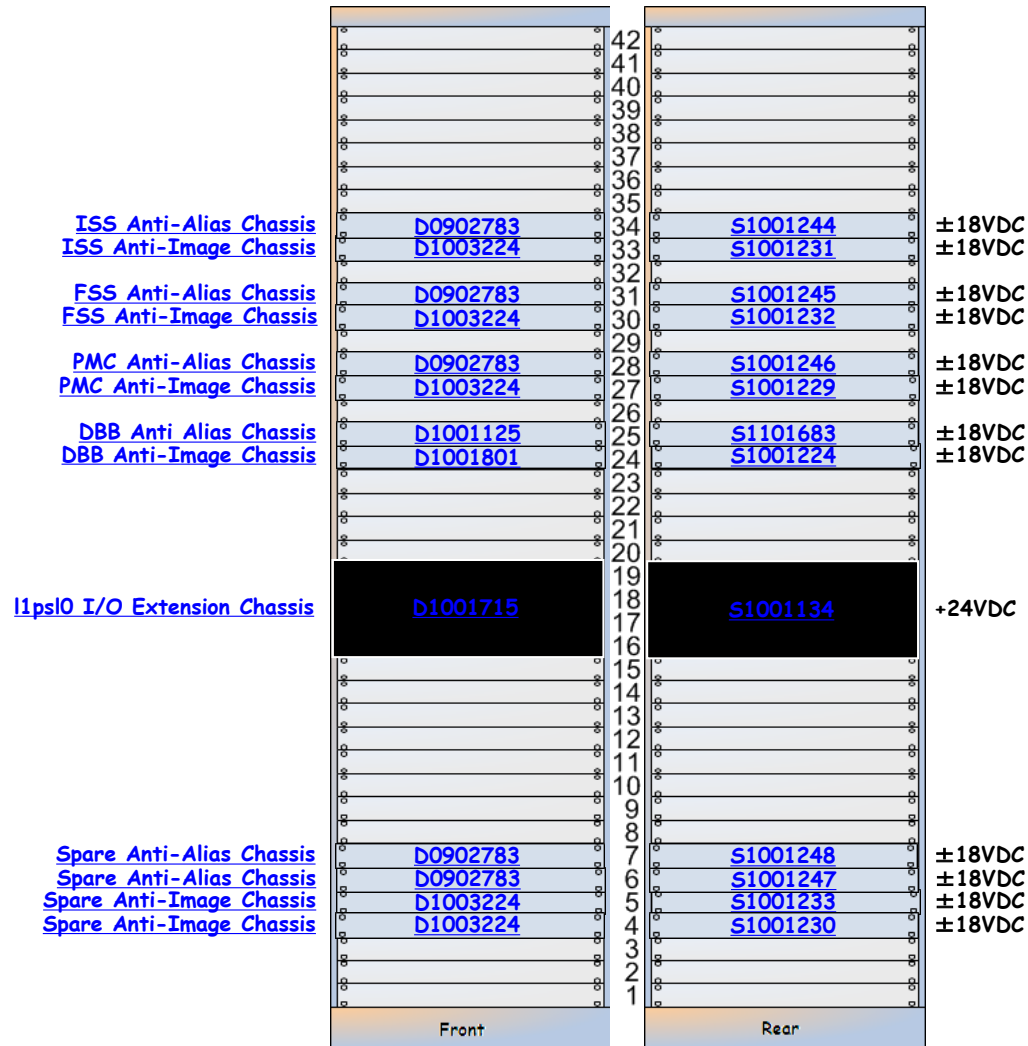

L1-PSL-C1 Details

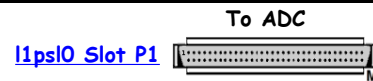
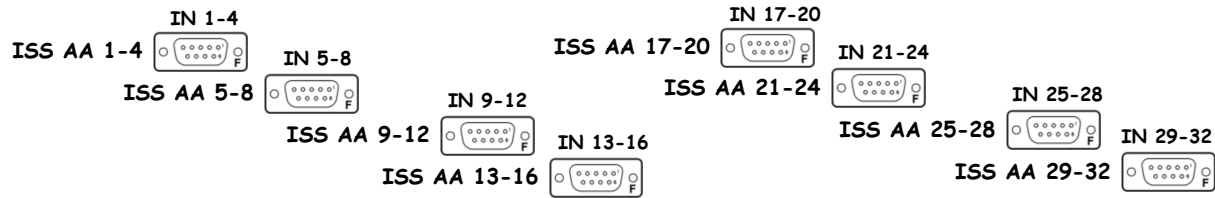
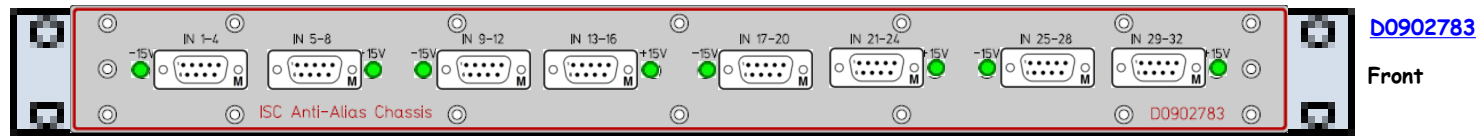

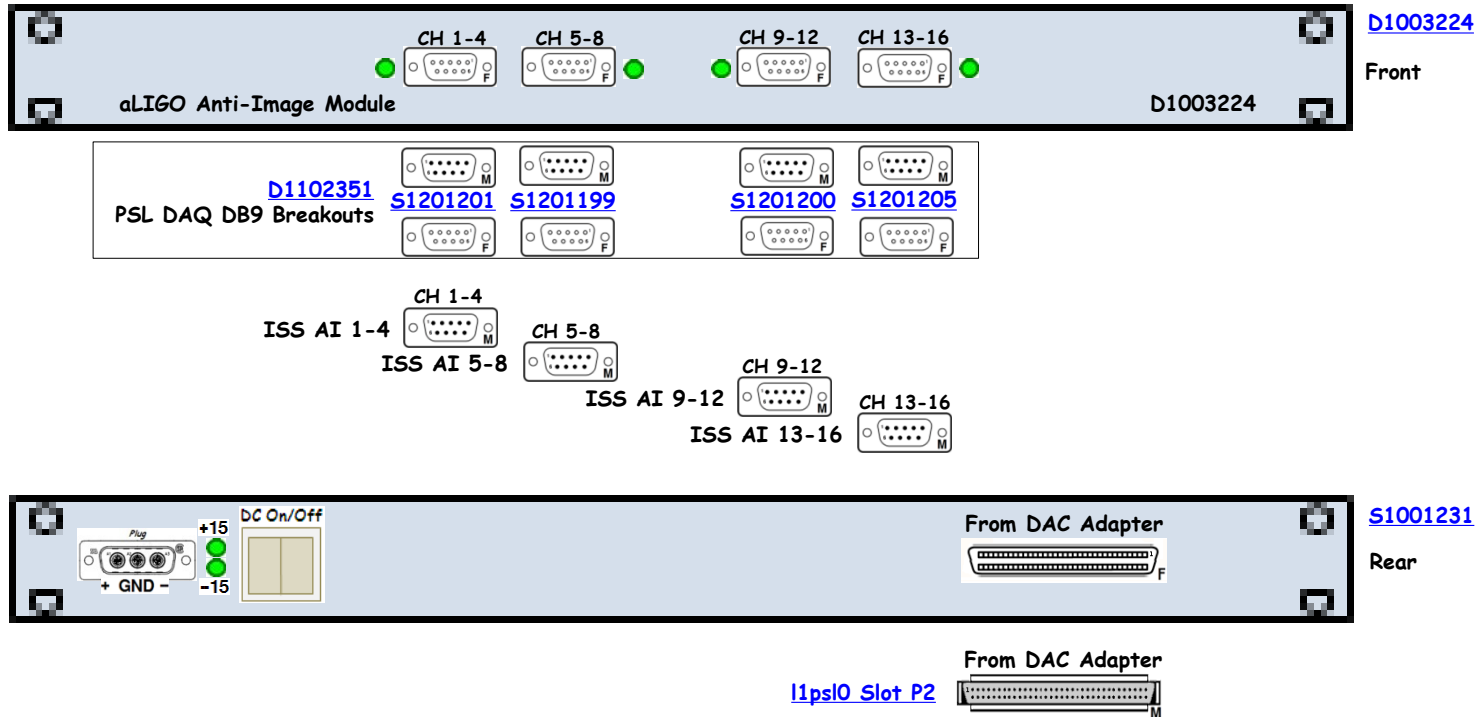

D0902783 - S1001245



<< L1-PSL-C1

FSS Anti-Alias Chassis D0902783 S1001245 ±18VDC

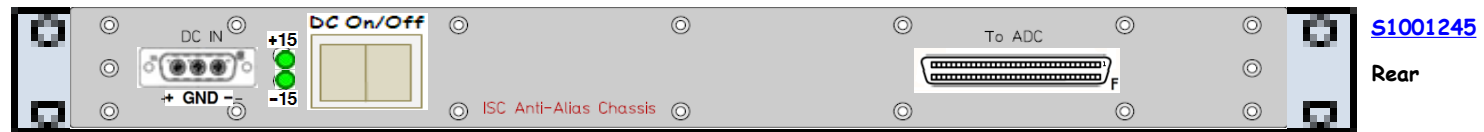
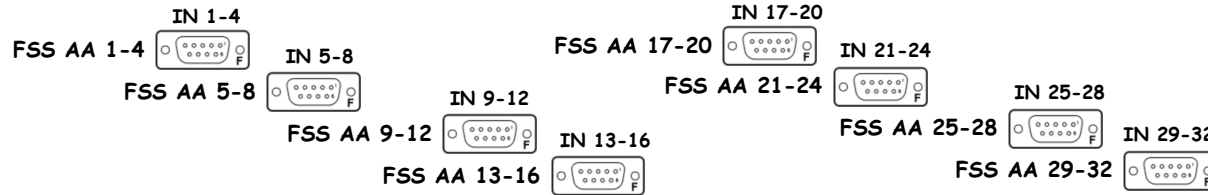
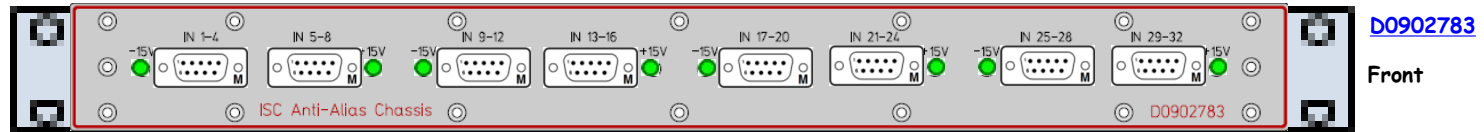

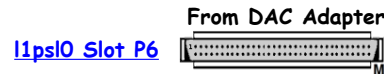
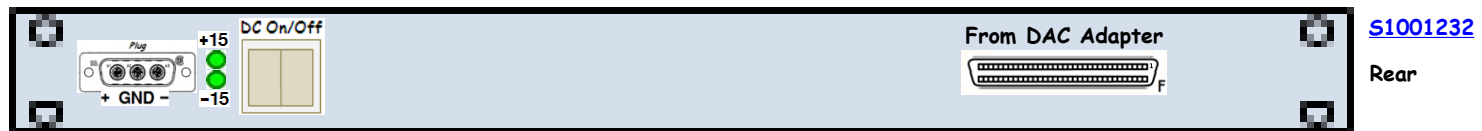
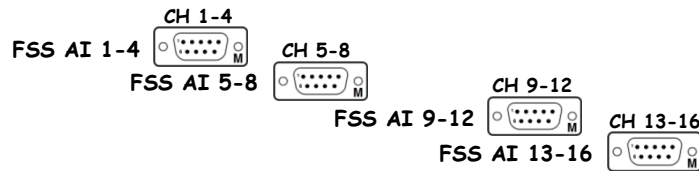
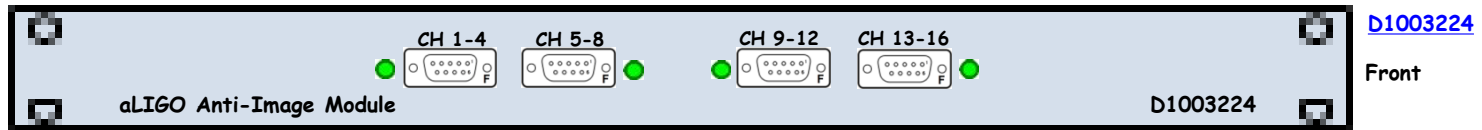

D0902783 - S1001246



<< L1-PSL-C1

PMC Anti-Image Chassis D0902783 S1001246 ±18VDC

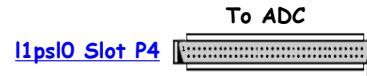
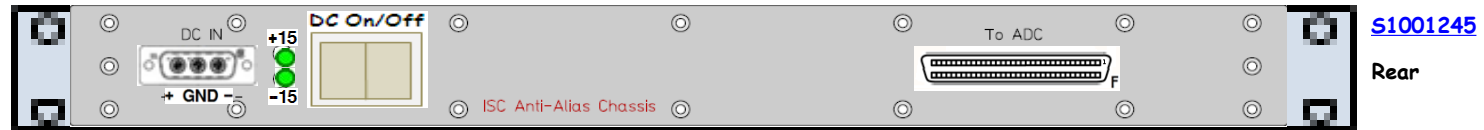
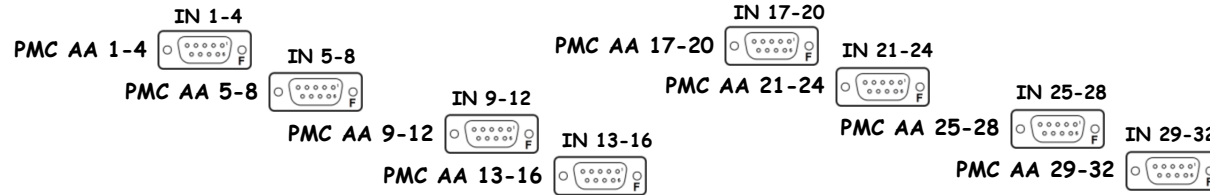
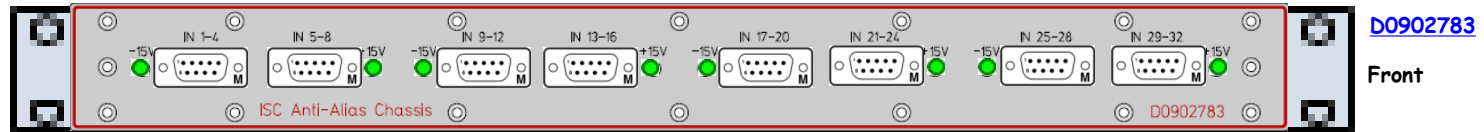

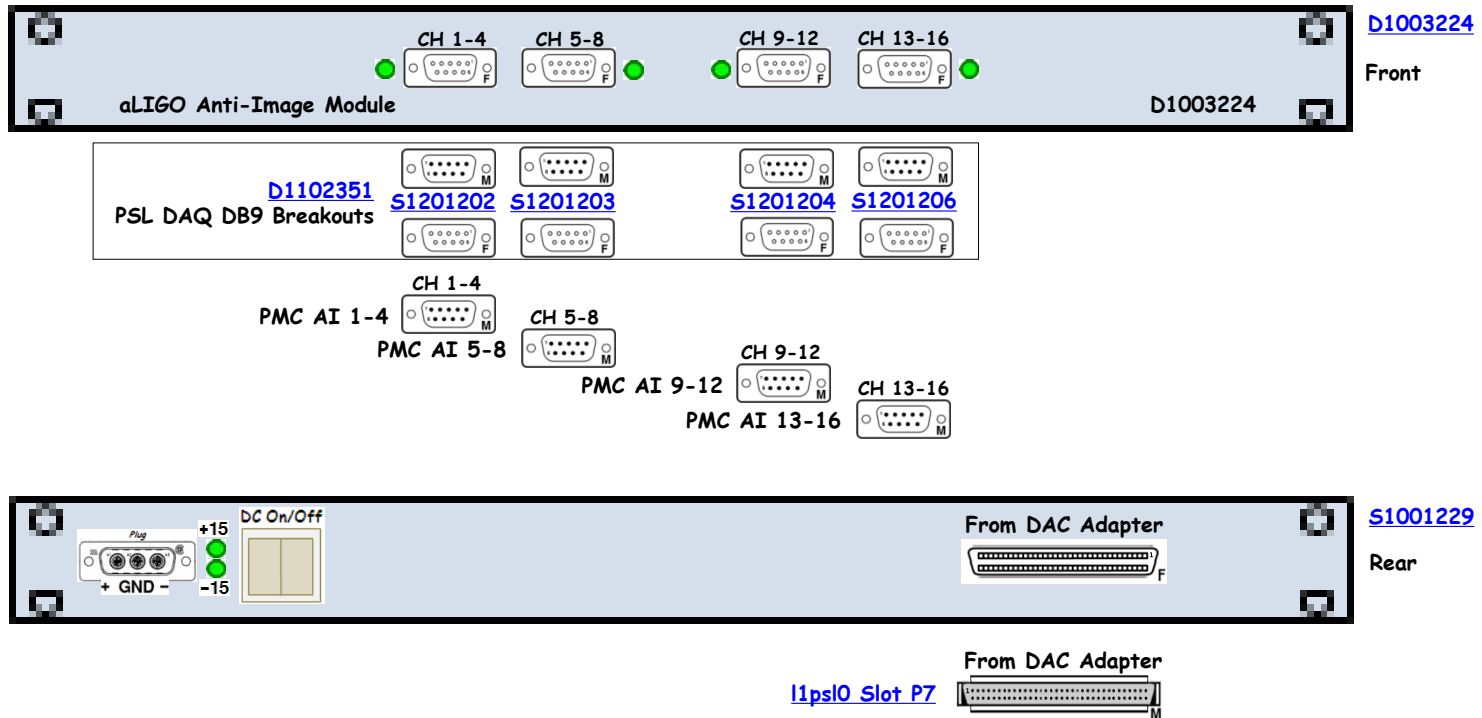

DBB Anti-Alias Chassis ±18VDC

AI Module aLIGO PSL DBB Assembly Drawing [D1100292](#)

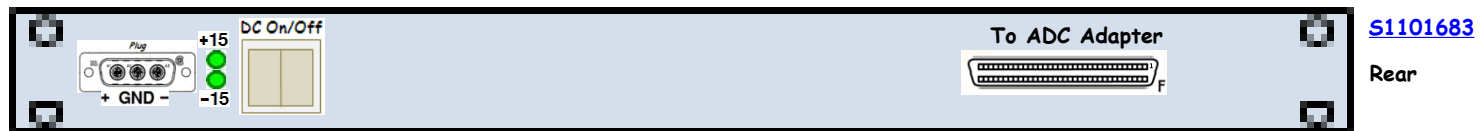
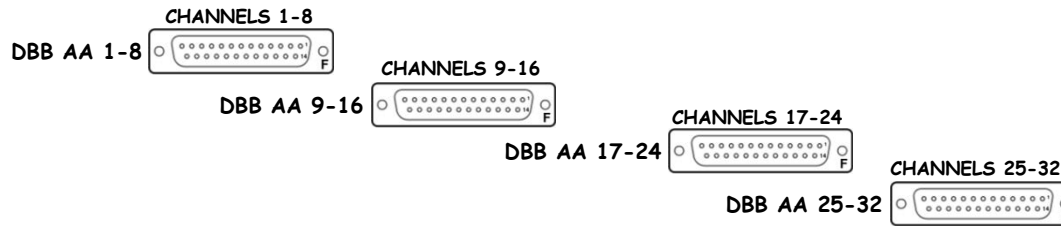

<< L1-PSL-C1

DBB Anti-Image Chassis ±18VDC

AI Module aLIGO PSL DBB Assembly Drawing [D1002103](#)

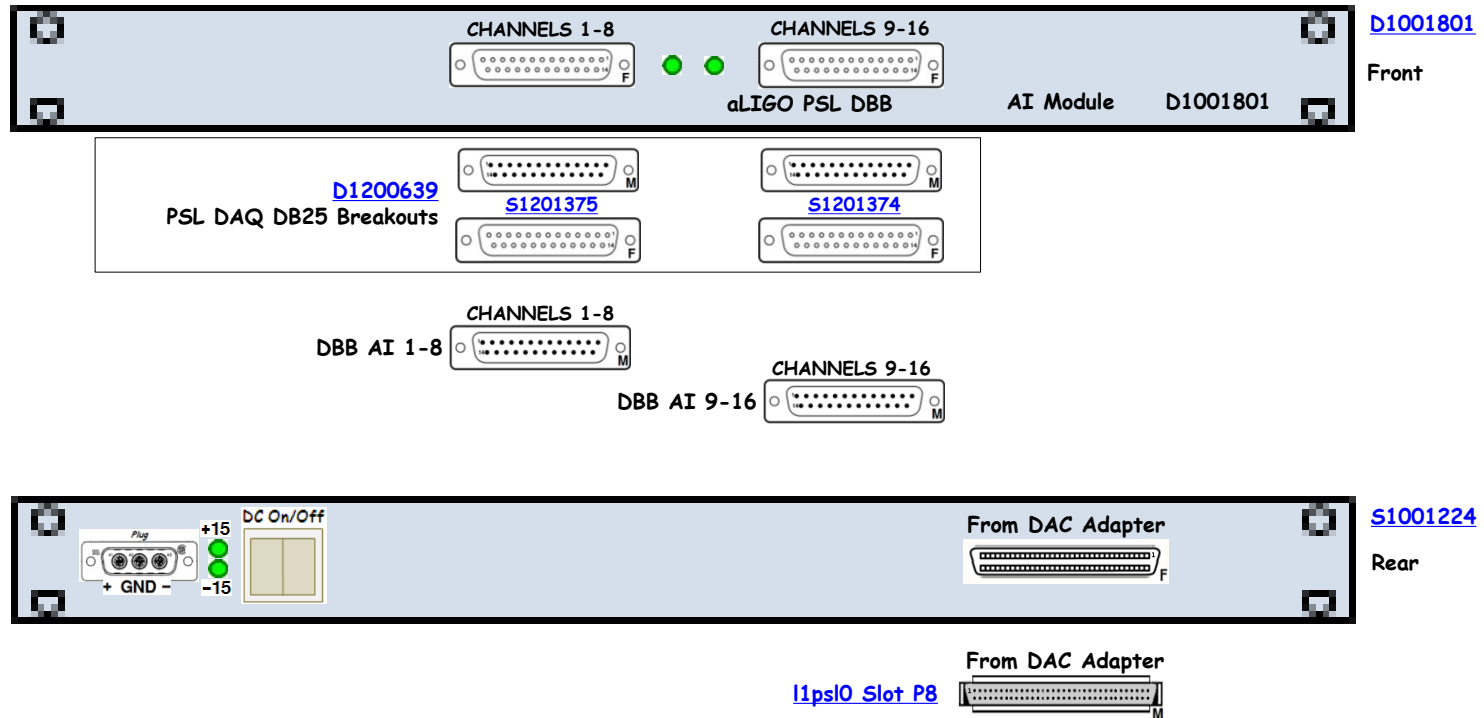



D1001715

Front

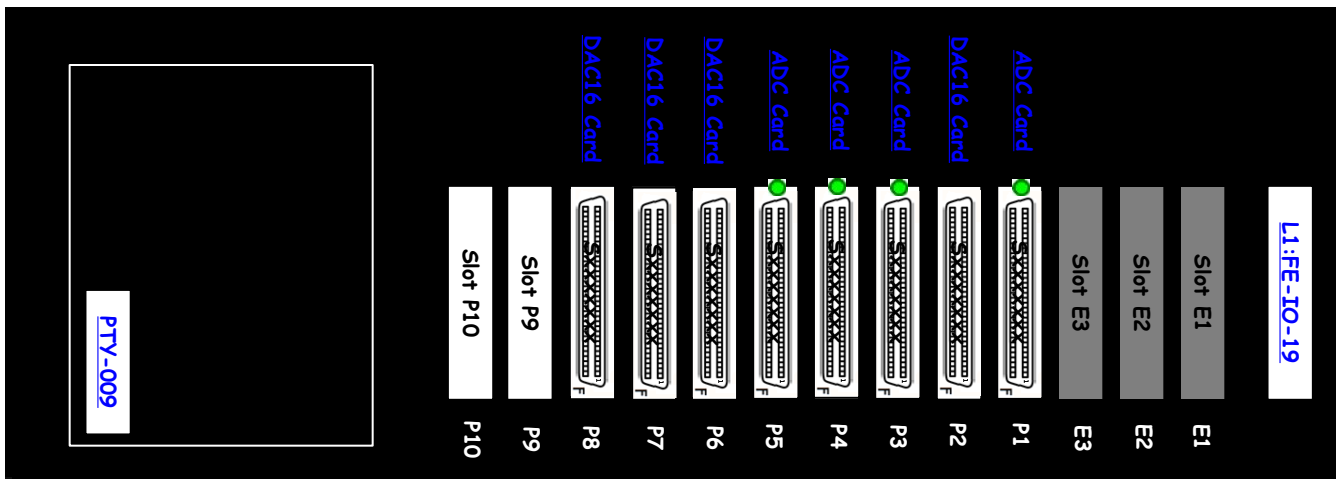

S1001134

Rear

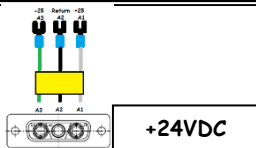
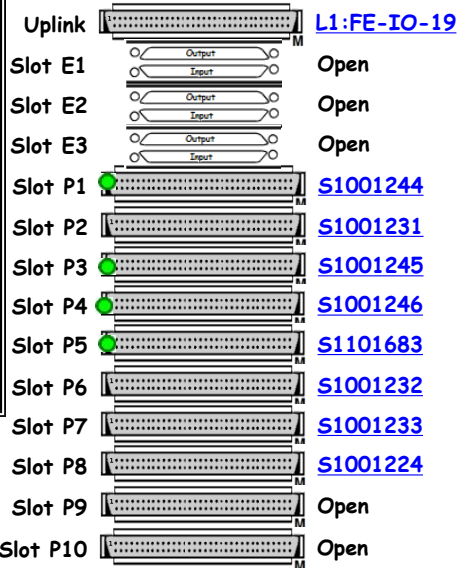

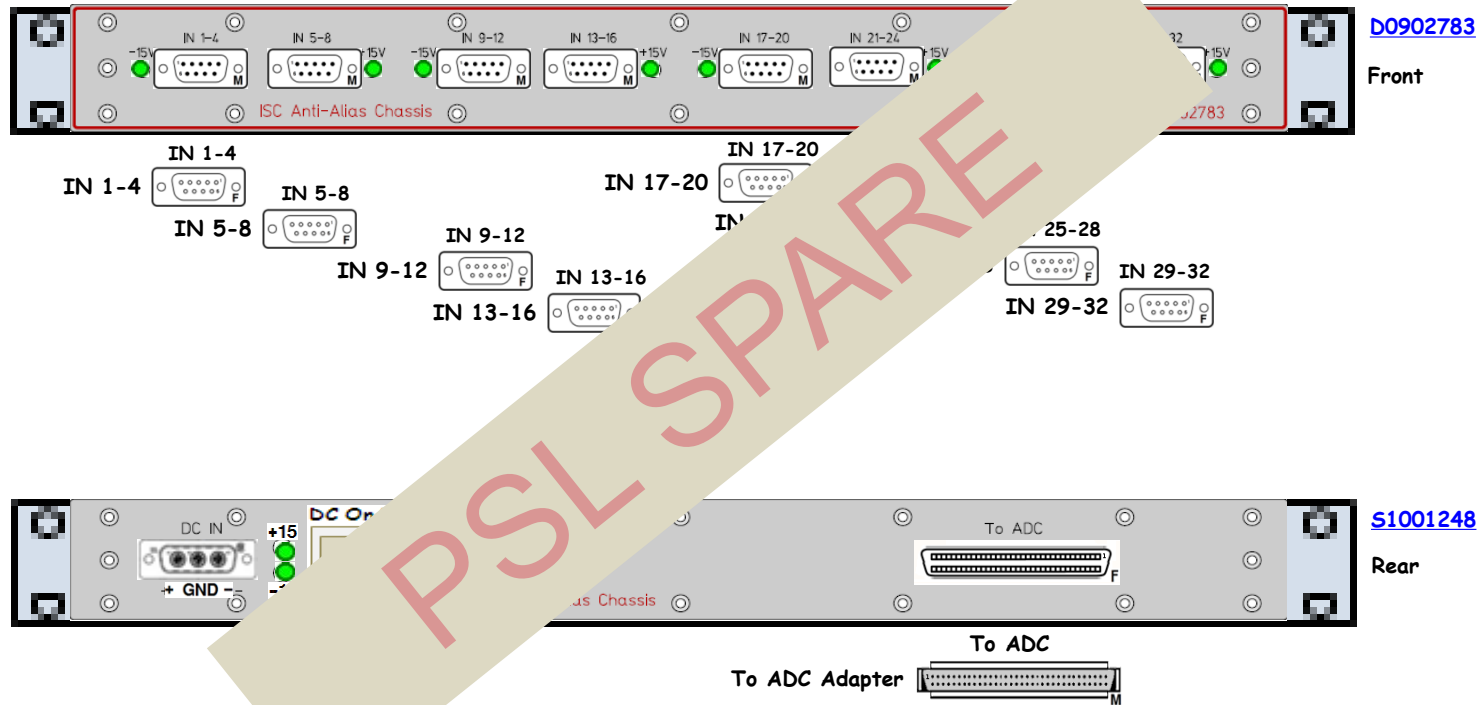

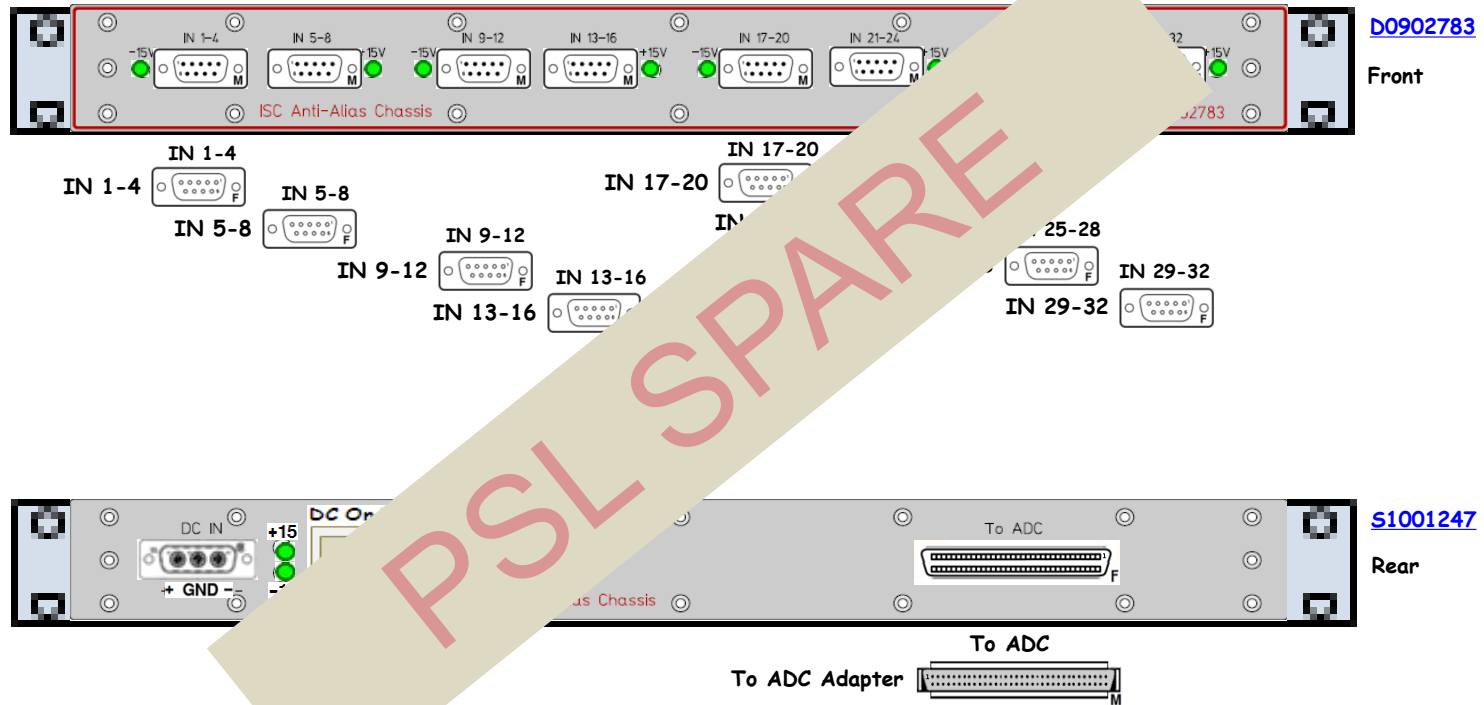

Anti-Image Chassis ±18VDC

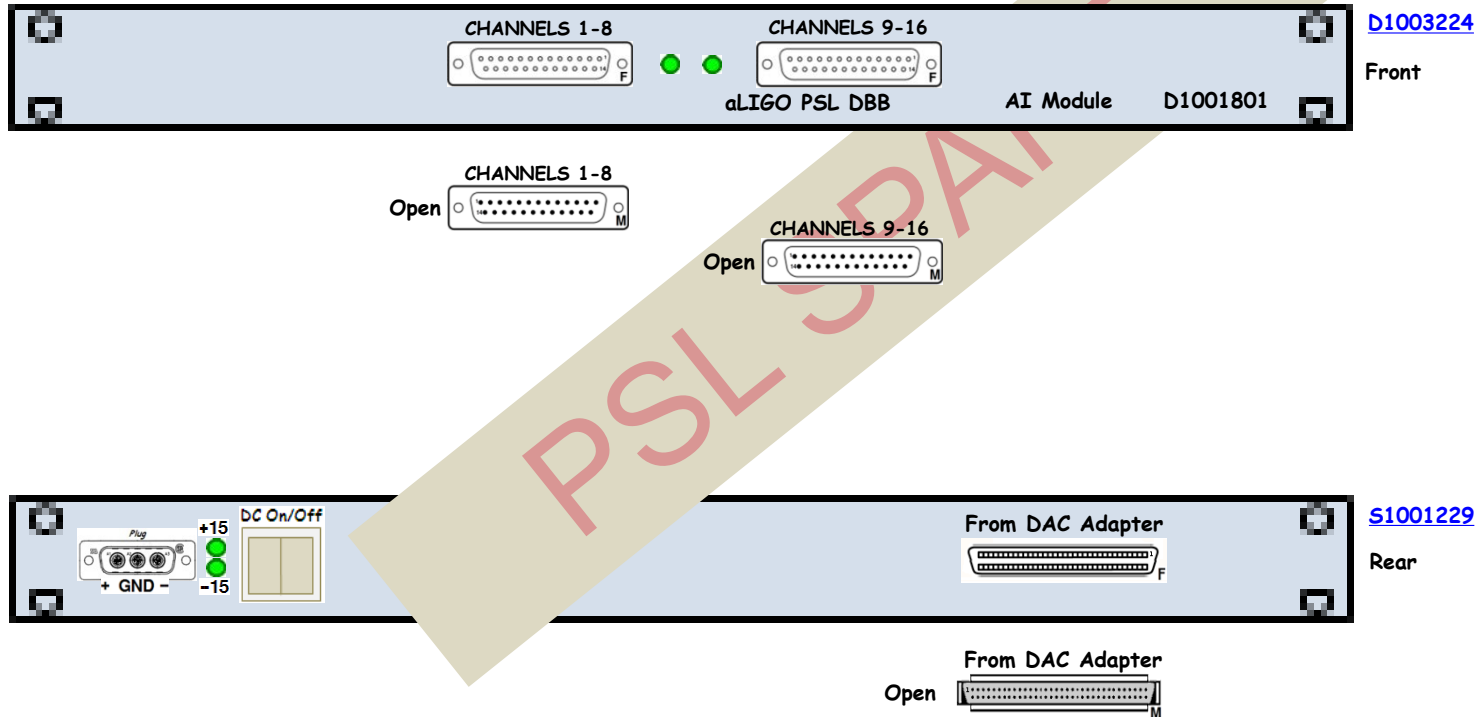

Anti-Image Chassis ±18VDC

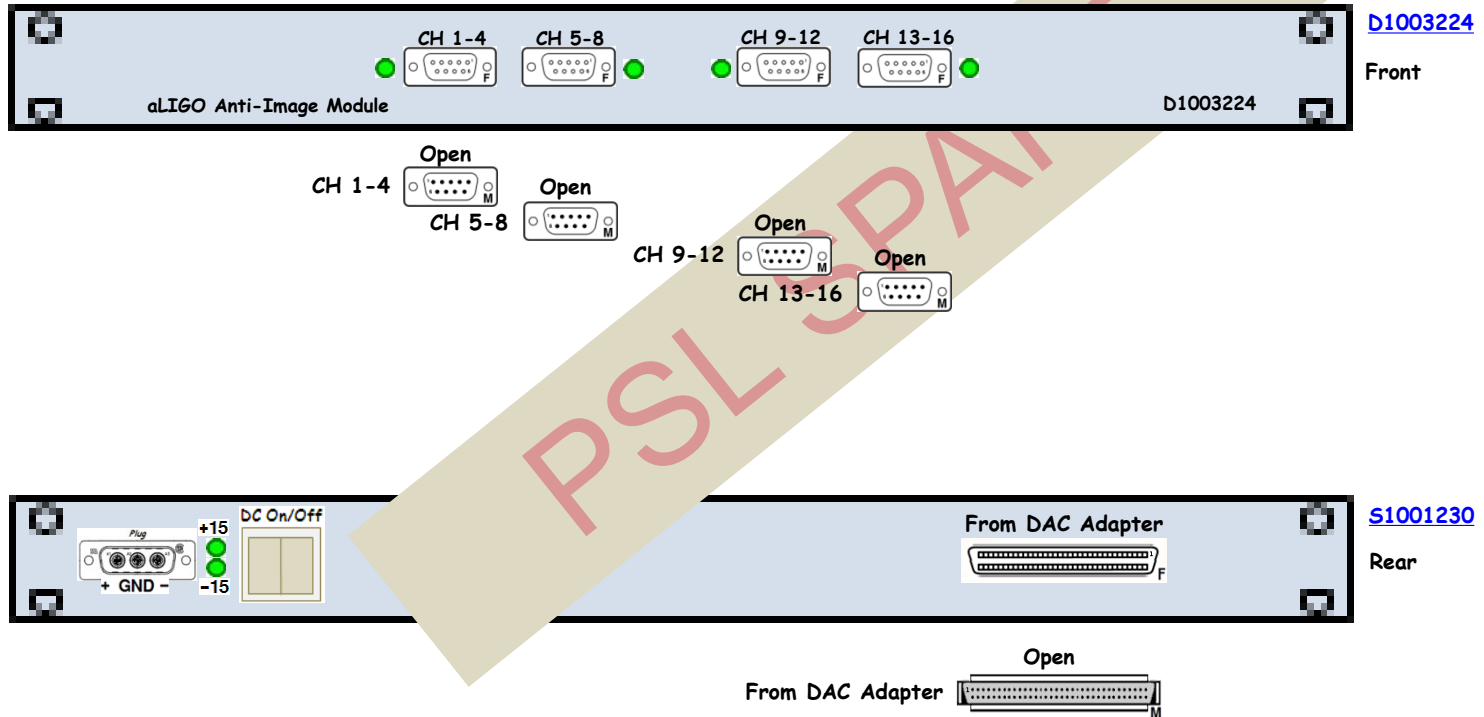

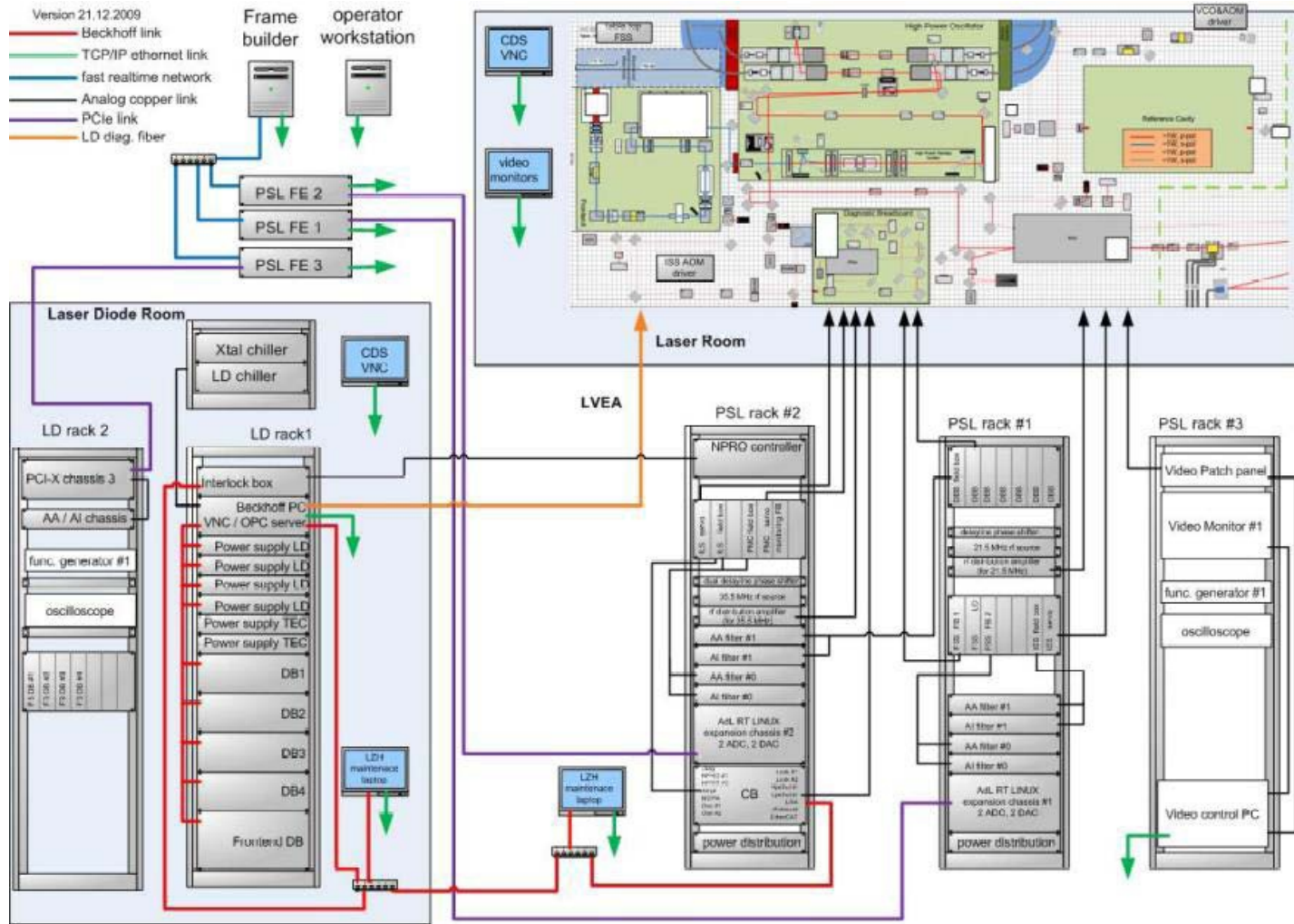

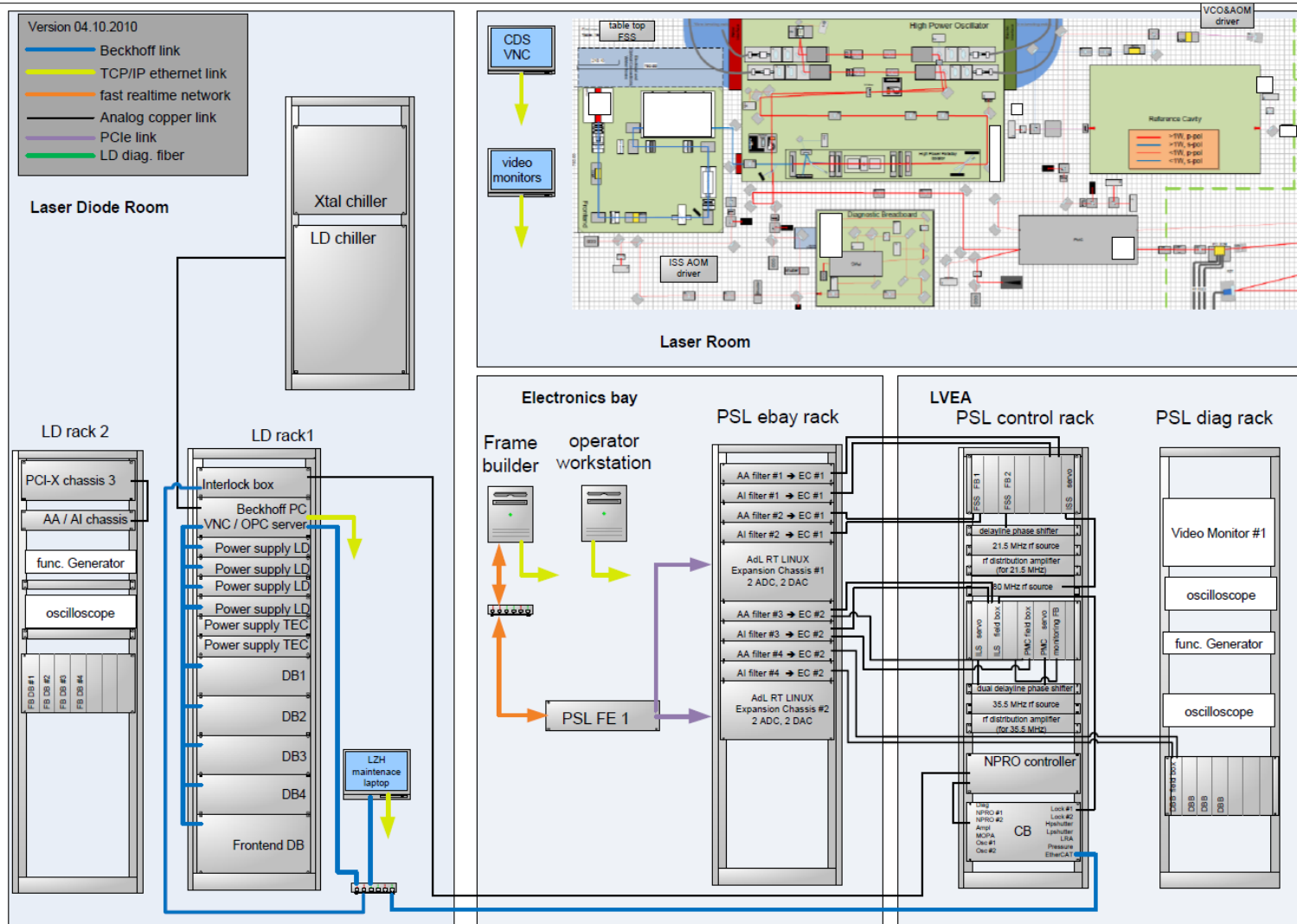

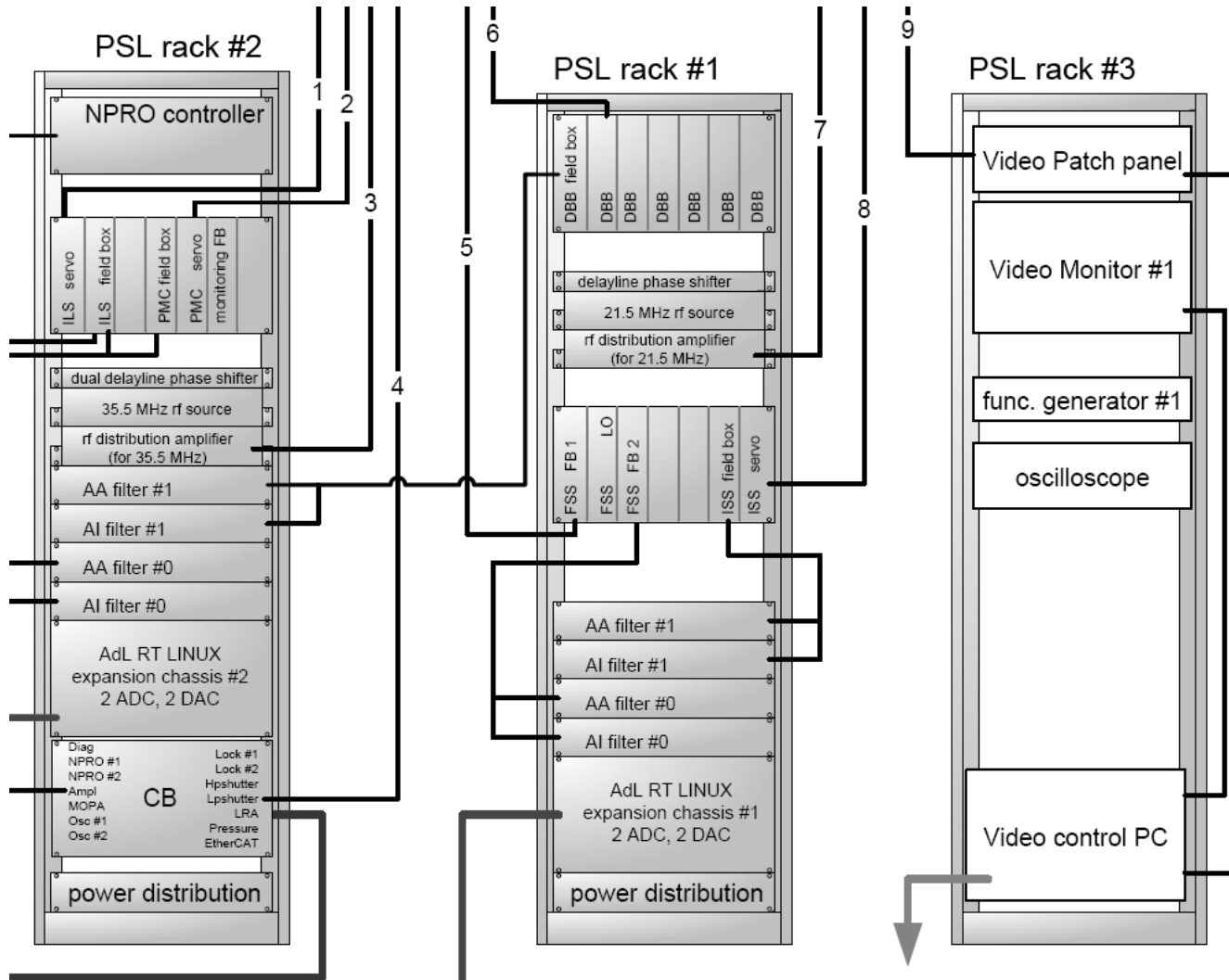

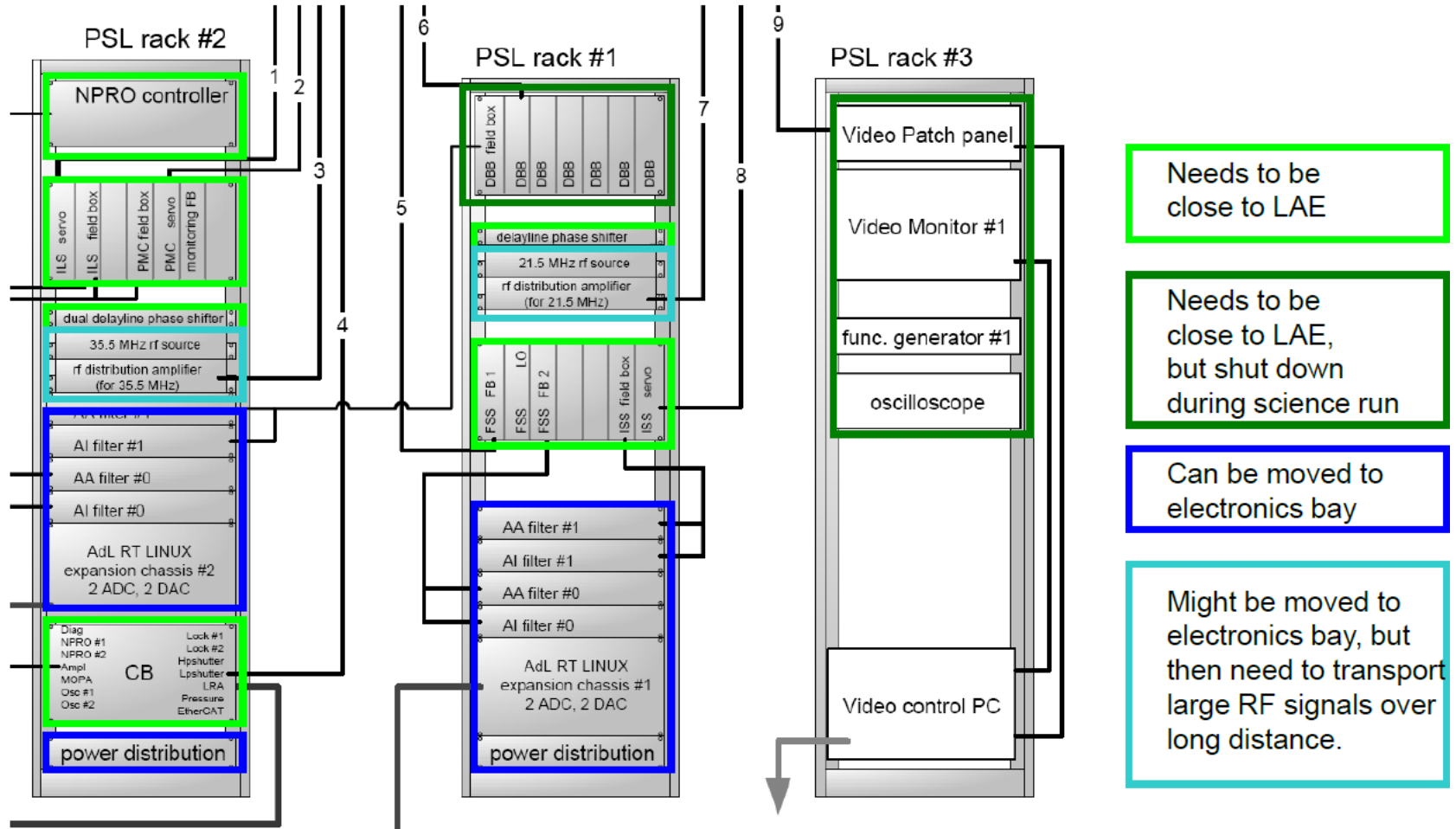

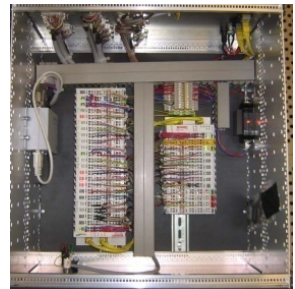
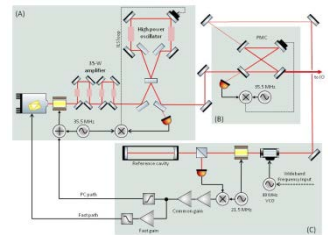
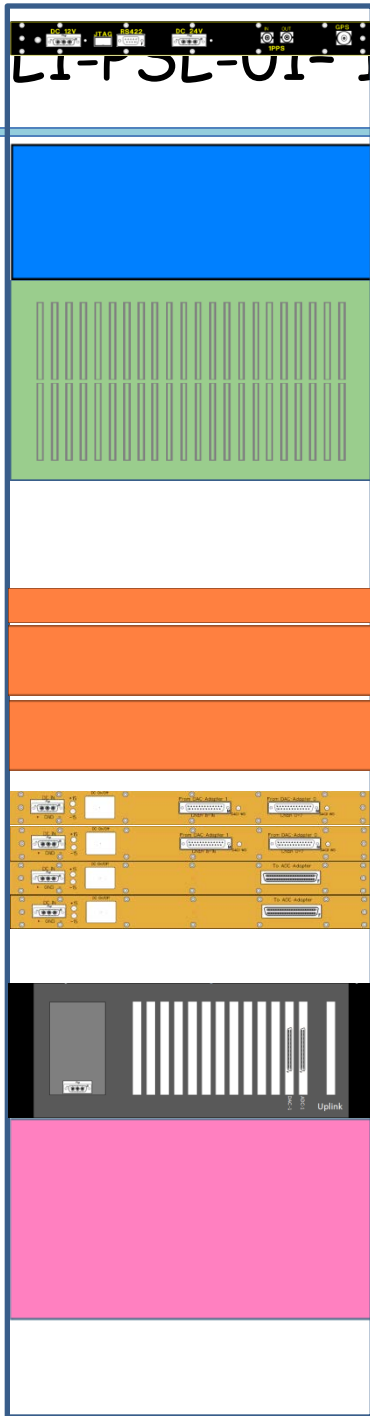
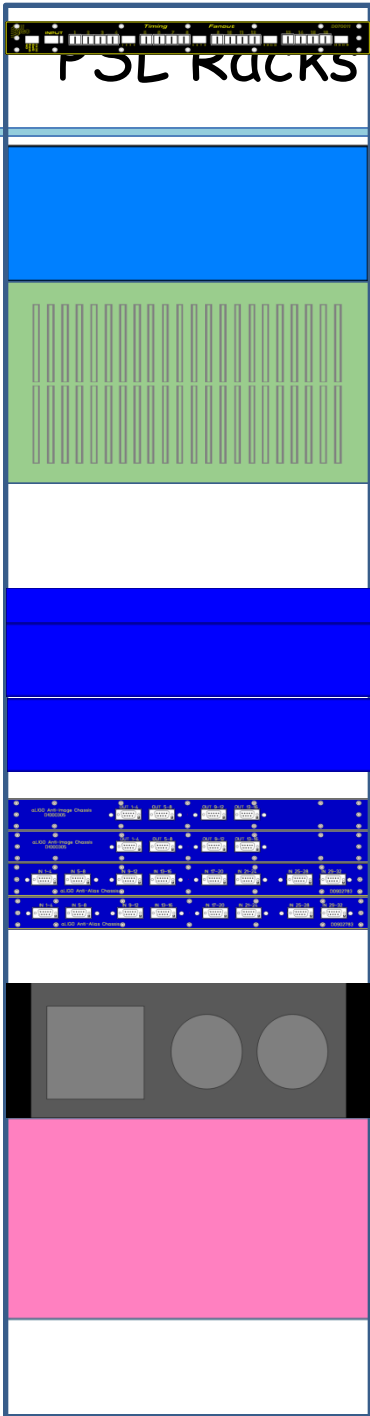

PSL Racks - L1-PSL-1-ECC-1 (ILS and PMC)

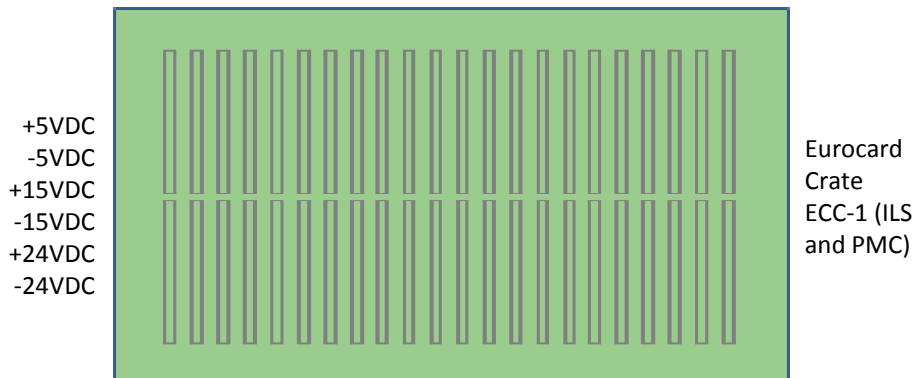
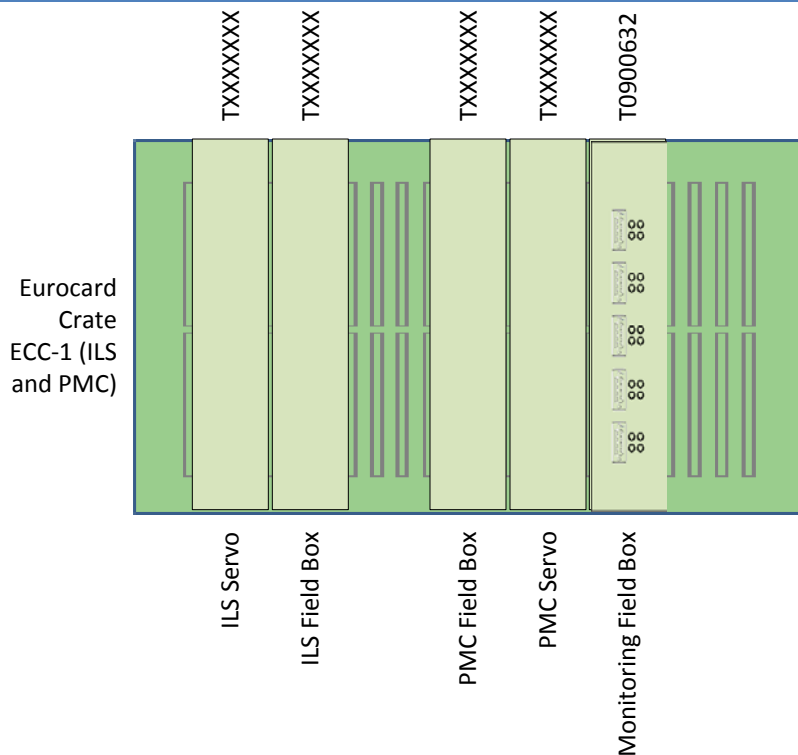



PSL RACKS - L1-PSL-02 (DBB, FSS, and ISS)

L1-PSL-02 (DBB, FSS, and ISS)

L1-PSL-02
Front Eurocard
Crate
ECC-1 (DBB)



Eurocard
Crate
ECC-2 (FSS
and ISS)

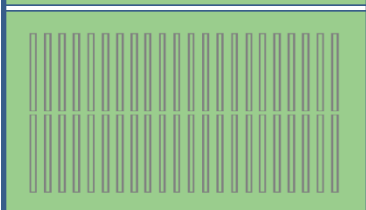

DXXXXXXXXX Delay Line Chassis



DXXXXXXXXX 21.5MHz Amplifier Chassis



DXXXXXXXXX 21.5MHz Amplifier Chassis



D1000305 AI Chassis
D1000305 AI Chassis
D0902783 AA Chassis
D0902783 AA Chassis

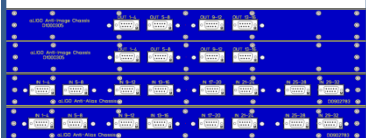

I/O Extension
2 ADC
2 DAC



Frequency Stabilization Servo
Intensity Stabilization Servo
Diagnostic Breadboard



L1-PSL-02
Rear Eurocard
Crate
ECC-1 (DBB)

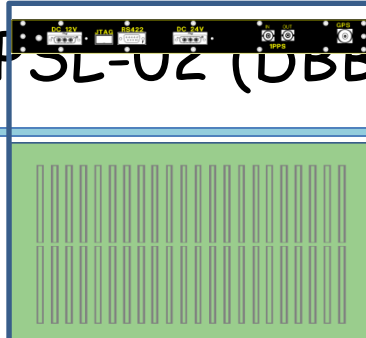

Eurocard
Crate
ECC-2 (FSS
and ISS)

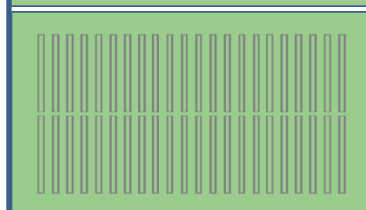

DXXXXXXXXX SYYYYYYYYY



DXXXXXXXXX SYYYYYYYYY



DXXXXXXXXX SYYYYYYYYY



D1000305 SYYYYYYYYY
D1000305 SYYYYYYYYY
D0902783 SYYYYYYYYY
D0902783 SYYYYYYYYY

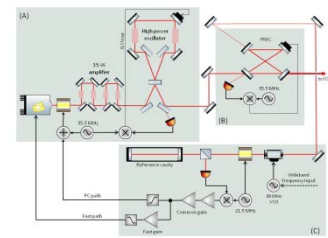
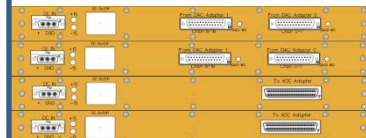

L1-PSL-02-ECC-1 (DBB)

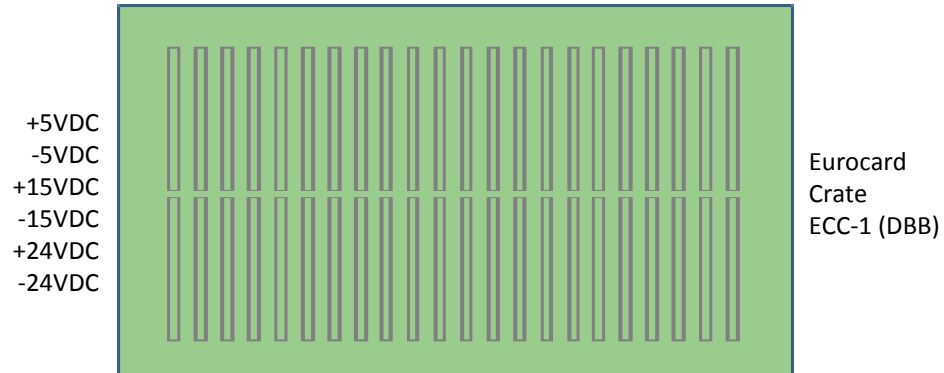
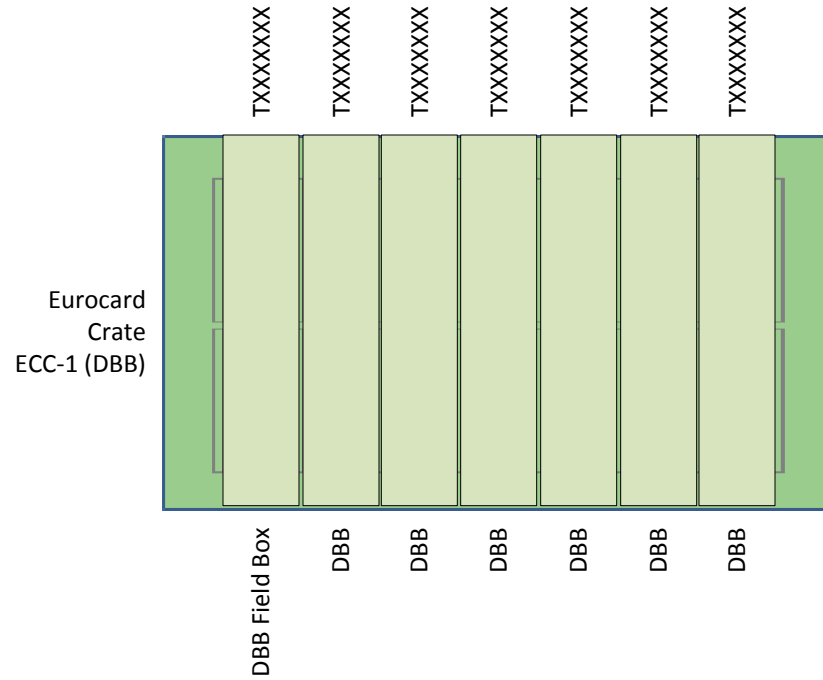

L1-PSL-02-ECC-2 (FSS and ISS)

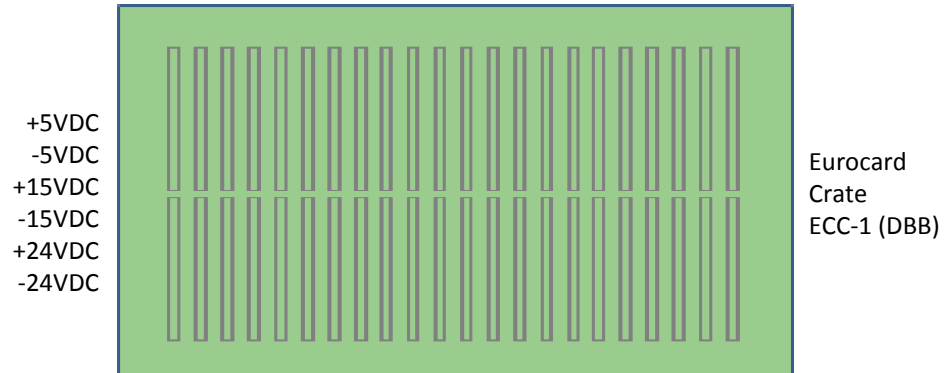
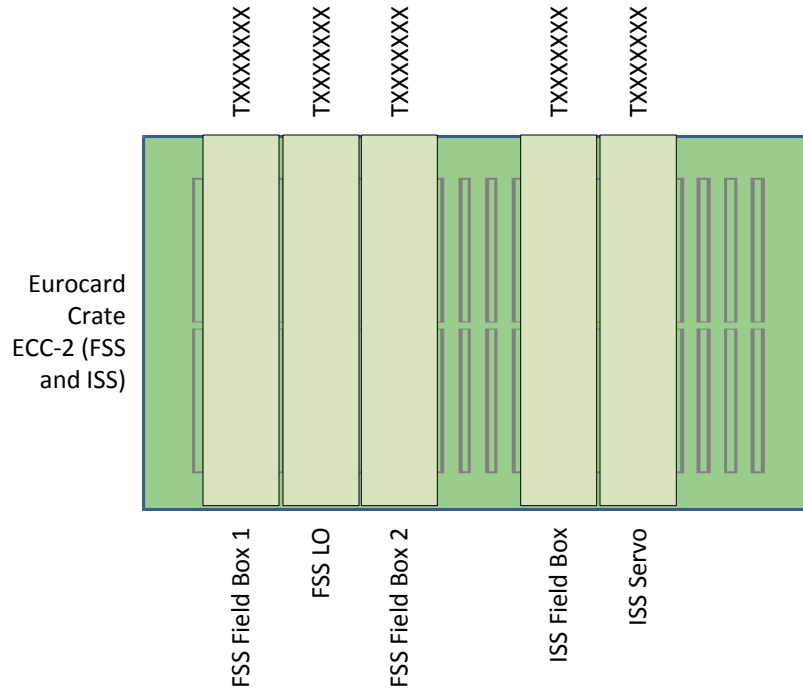



NPRO Controller

L1-PSL-01 Front

Eurocard Crate ECC-1 (DBB)

Eurocard Crate ECC-2 (FSS and ISS)

Eurocard Crate ECC-3 (ILS and PMC)

DXXXXXXXXX Delay Line Chassis

DXXXXXXXXX 21.5MHz Amplifier Chassis

DXXXXXXXXX 21.5MHz Amplifier Chassis

DXXXXXXXXX Delay Line Chassis

DXXXXXXXXX 35.5MHz Amplifier Chassis

DXXXXXXXXX 35.5MHz Amplifier Chassis

Control Box (CB)

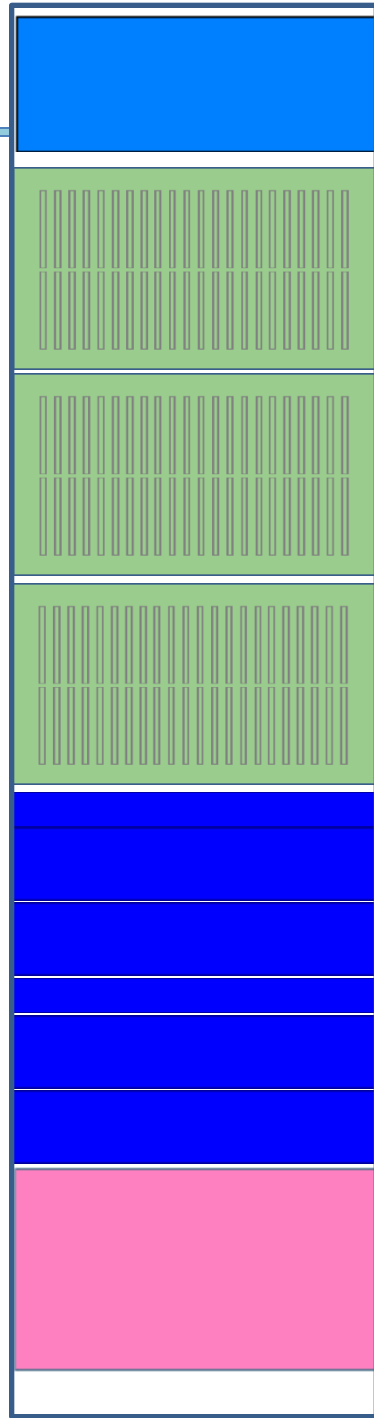

NPRO Controller

L1-PSL-01 Rear

Eurocard Crate ECC-1 (DBB)

Eurocard Crate ECC-2 (FSS and ISS)

Eurocard Crate ECC-3 (ILS and PMC)

DXXXXXXXXX SYYYYYYYYY

DXXXXXXXXX SYYYYYYYYY

DXXXXXXXXX SYYYYYYYYY

DXXXXXXXXX SYYYYYYYYY

DXXXXXXXXX SYYYYYYYYY

DXXXXXXXXX SYYYYYYYYY

Control Box (CB)

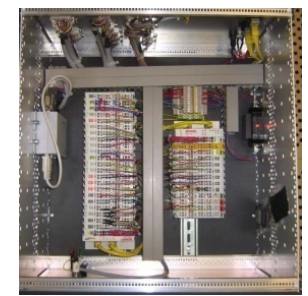
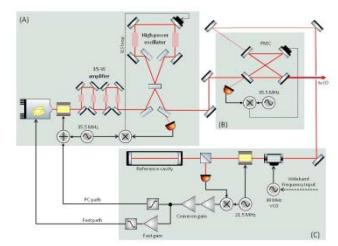
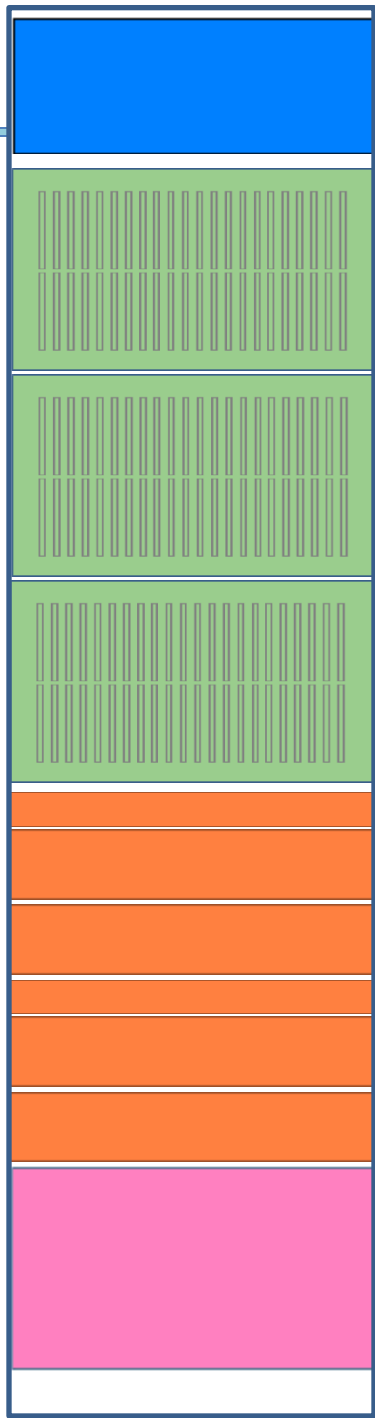



PSL Table

[T0900610](#)

L1-LDR-C1

LDR Rack 1 Layout (Dxxxxxxx)

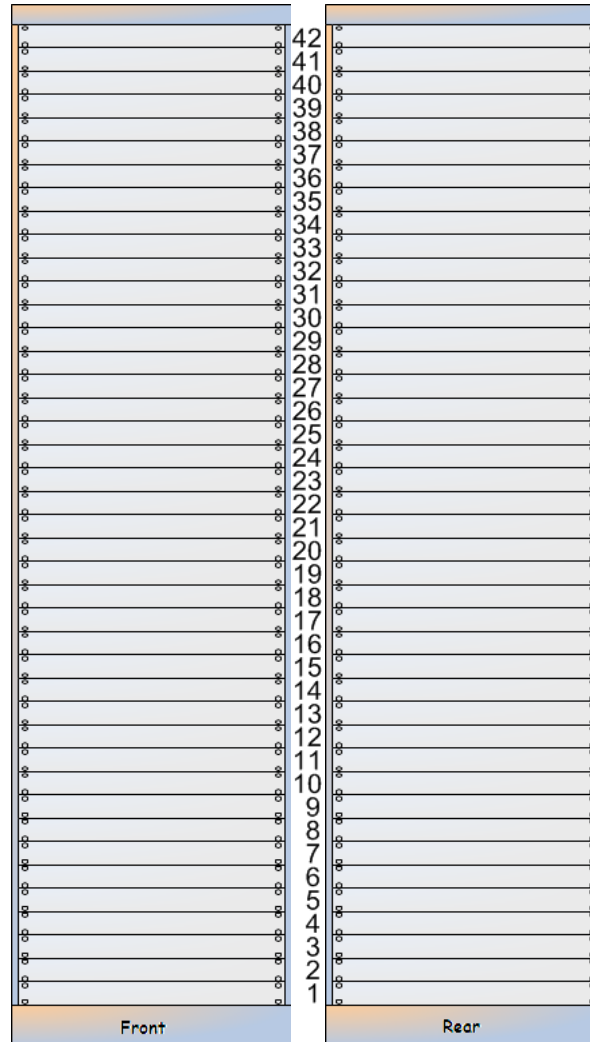

L1-LDR-C2

LDR Rack 2 Layout (Dxxxxxxx)

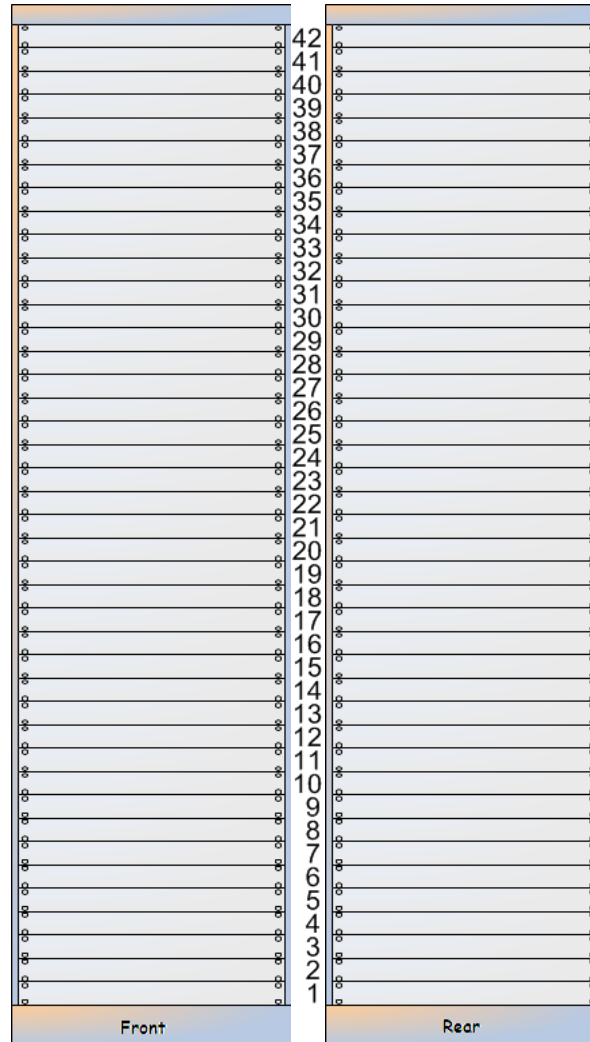

L1-LDR-C3

LDR Rack 3 Layout (Dxxxxxxx)



LDR Chiller

LDR Rack 4 Layout (Chillers) (Dxxxxxxx)

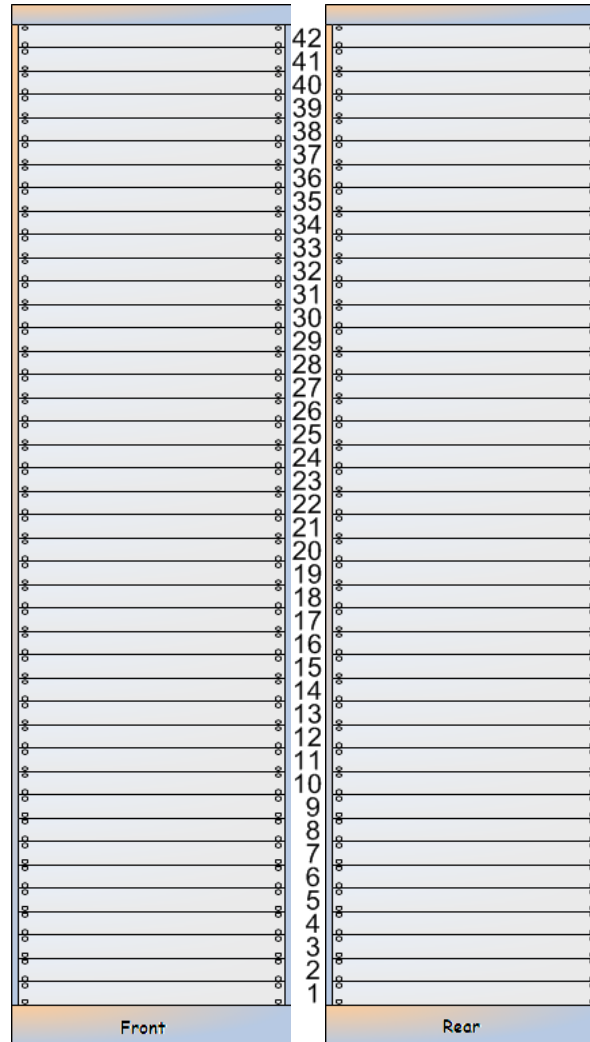

<< LLO Racks by Subsystem

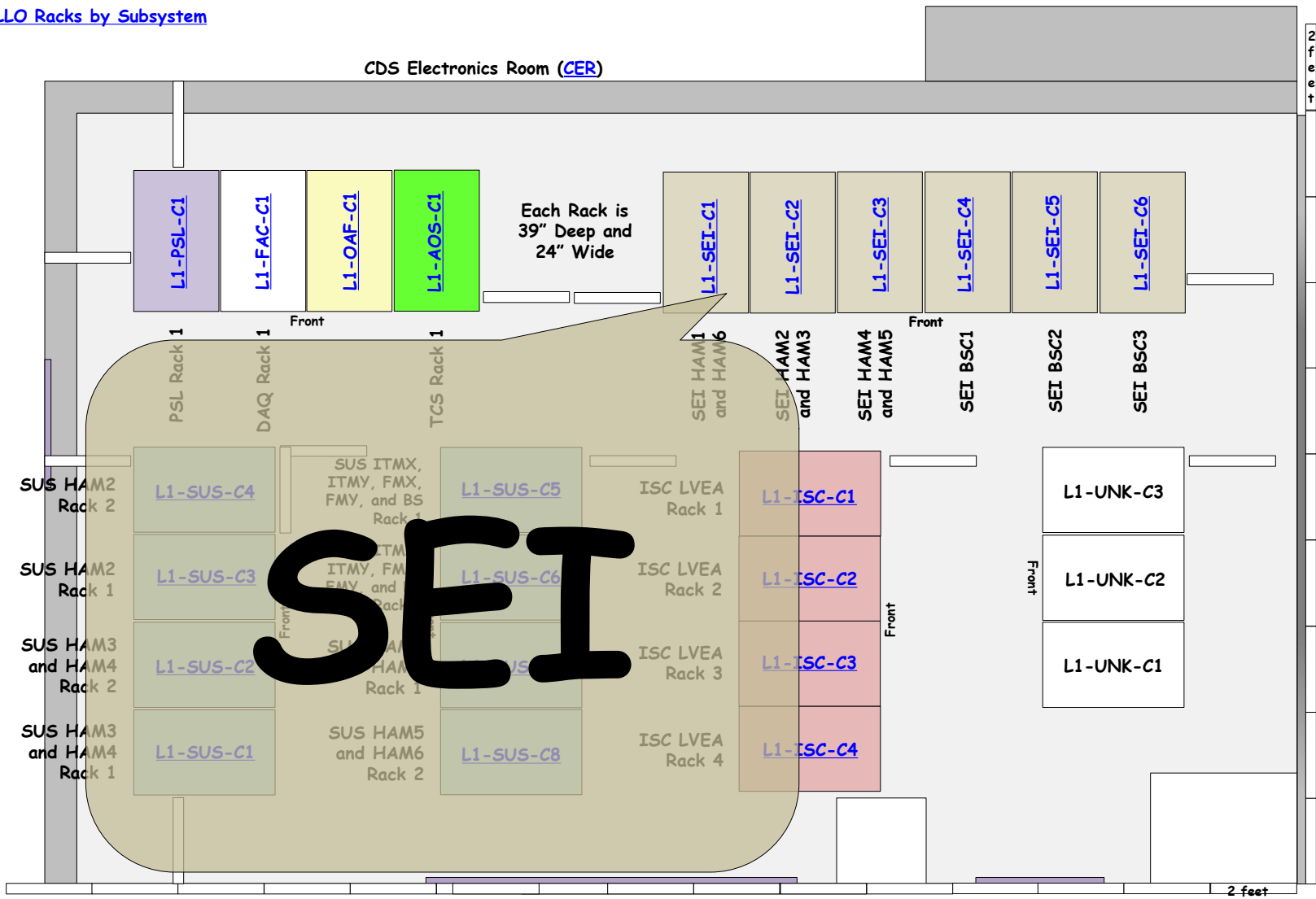

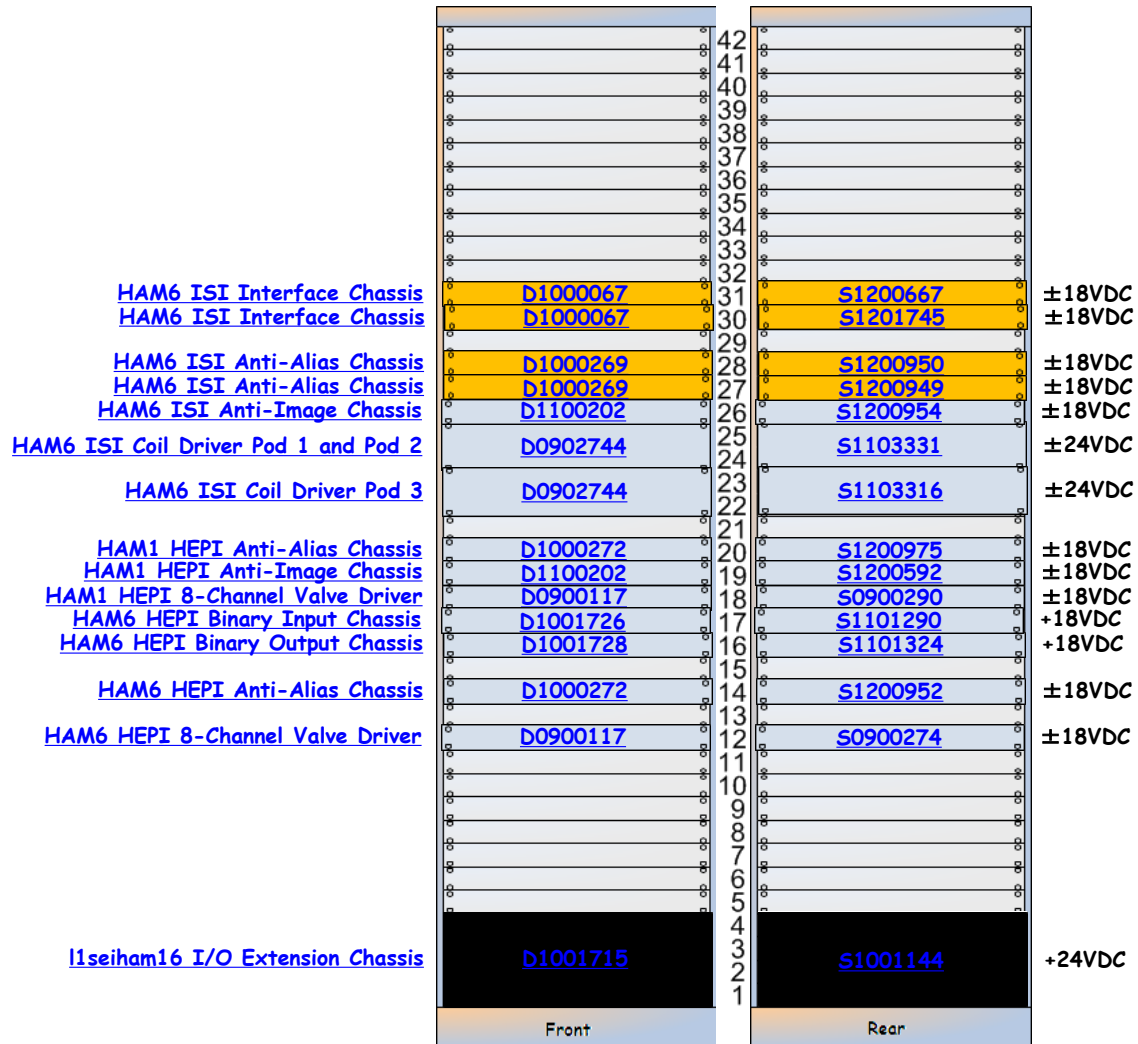

SEI-C1 is part of [D1101584](#)

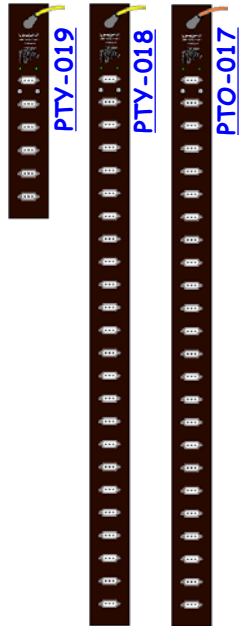

L1-SEI-C1 Details

SEI-C1 is part of [D1101584](#)

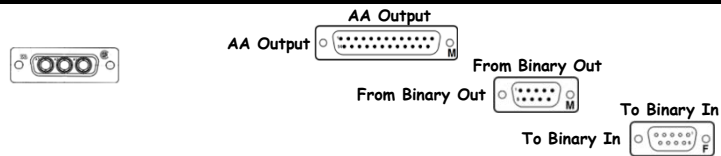
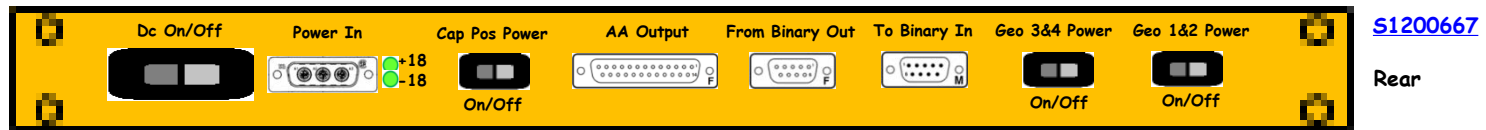

D1000067

Front

S1200667

Rear

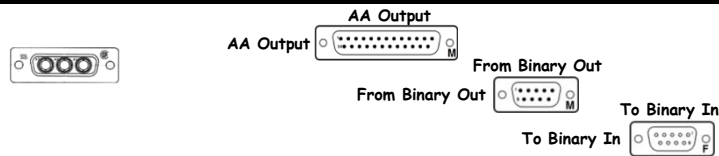
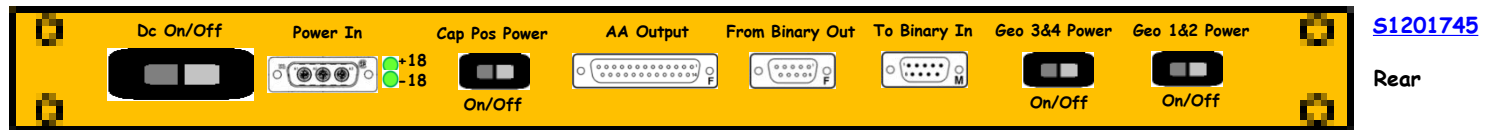
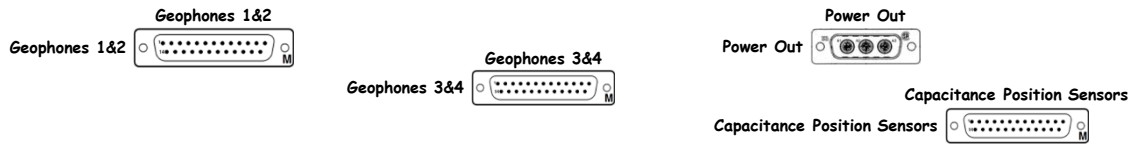

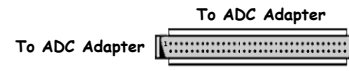
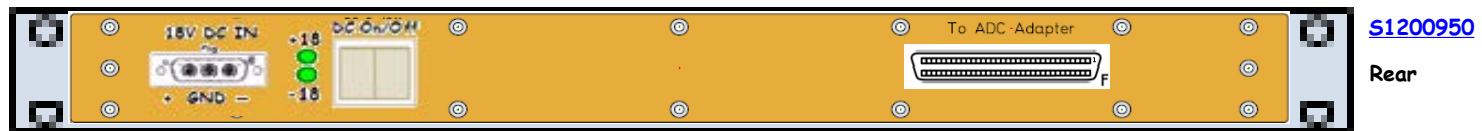
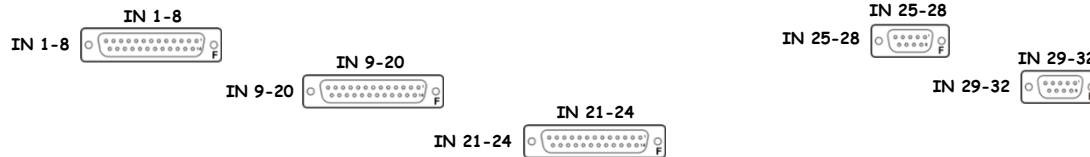

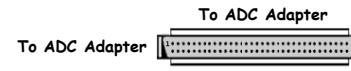
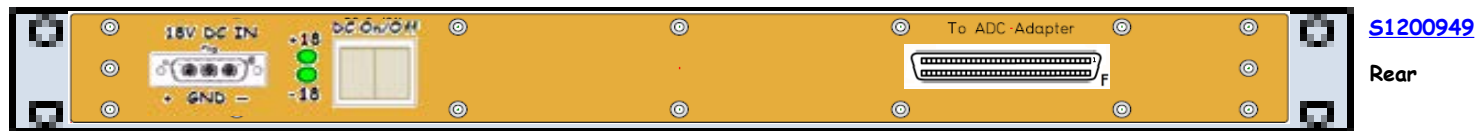
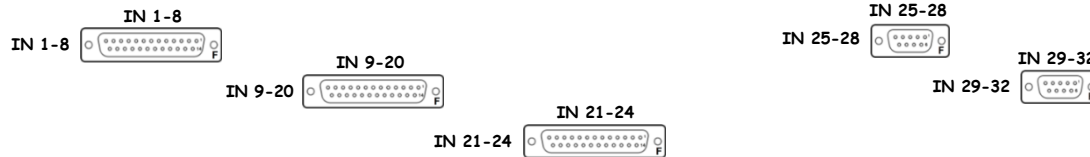

D1100202 - S1200954



<< L1-SEI-C1

HAM6 ISI Anti-Image Chassis D1100202 S1200954 ±18VDC

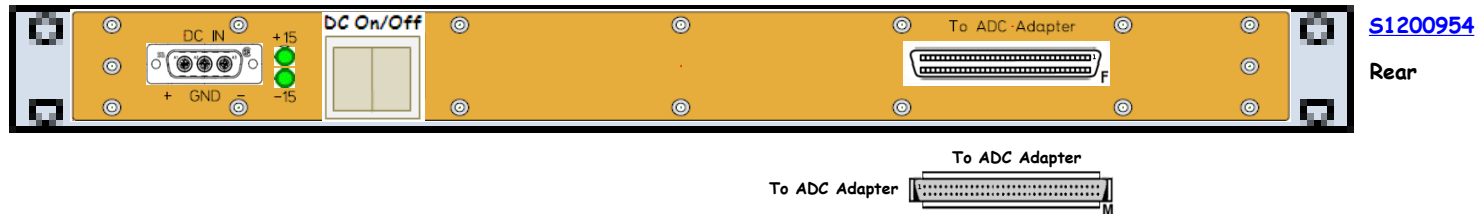
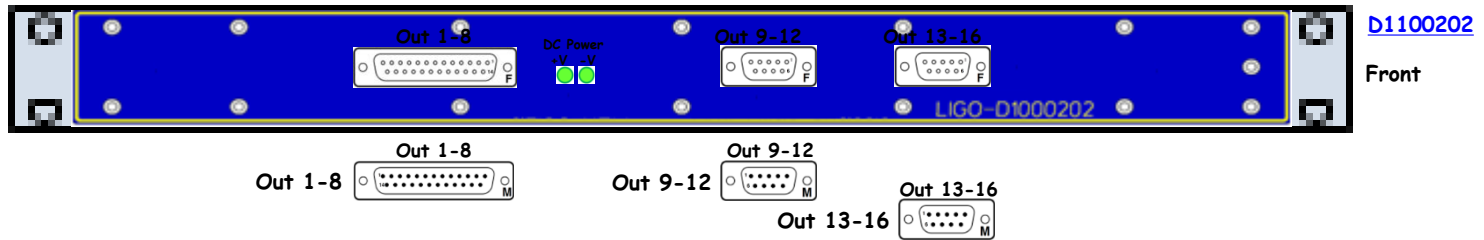

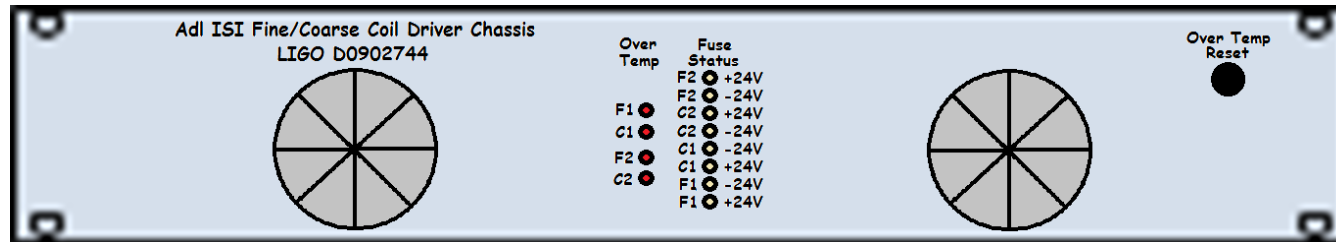

[D0902744](#)

Front

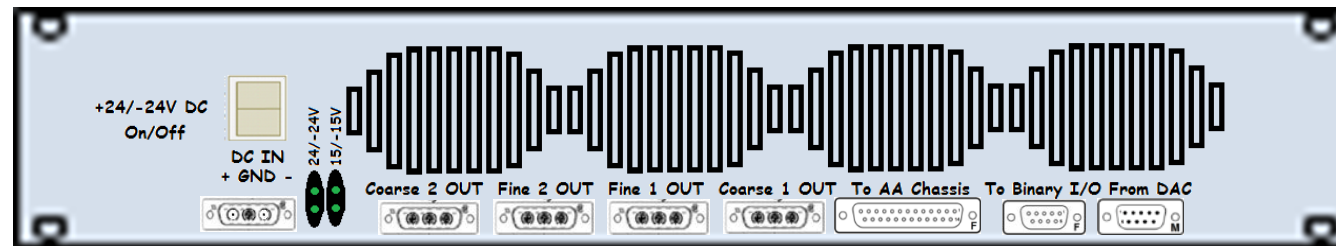

[S1103331](#)

Rear

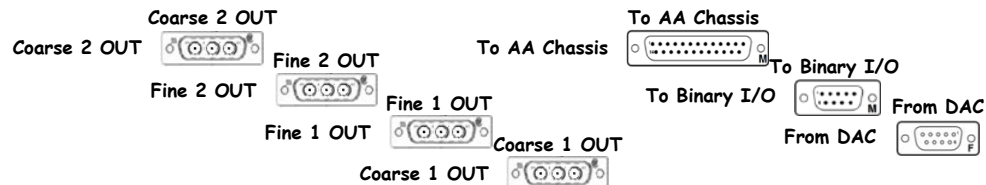

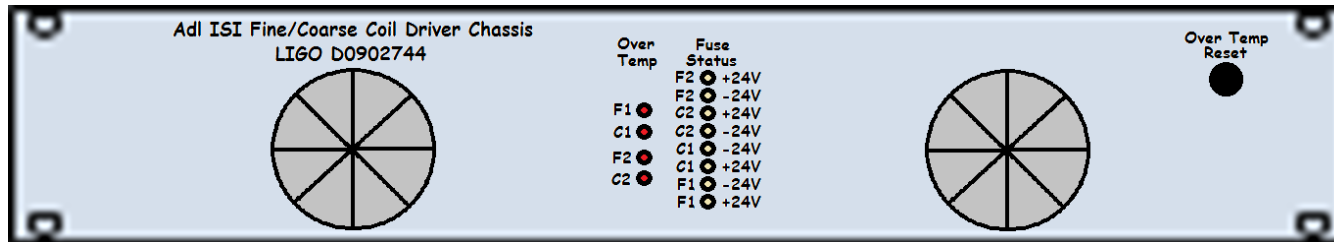

[D0902744](#)

Front

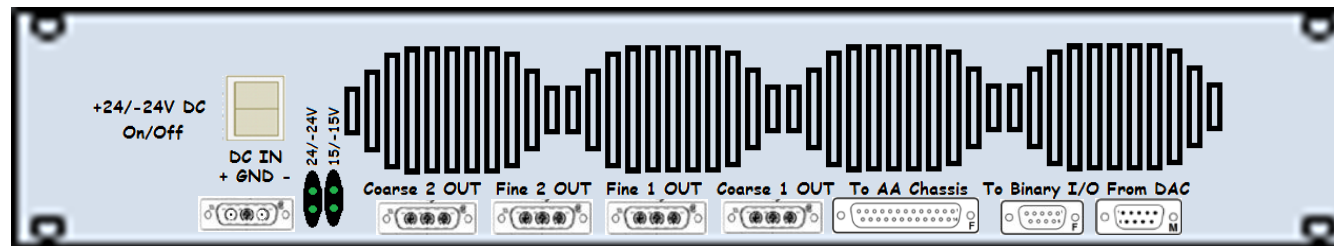

[S1103316](#)

Rear

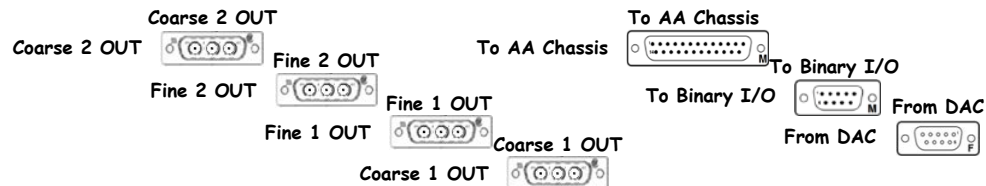

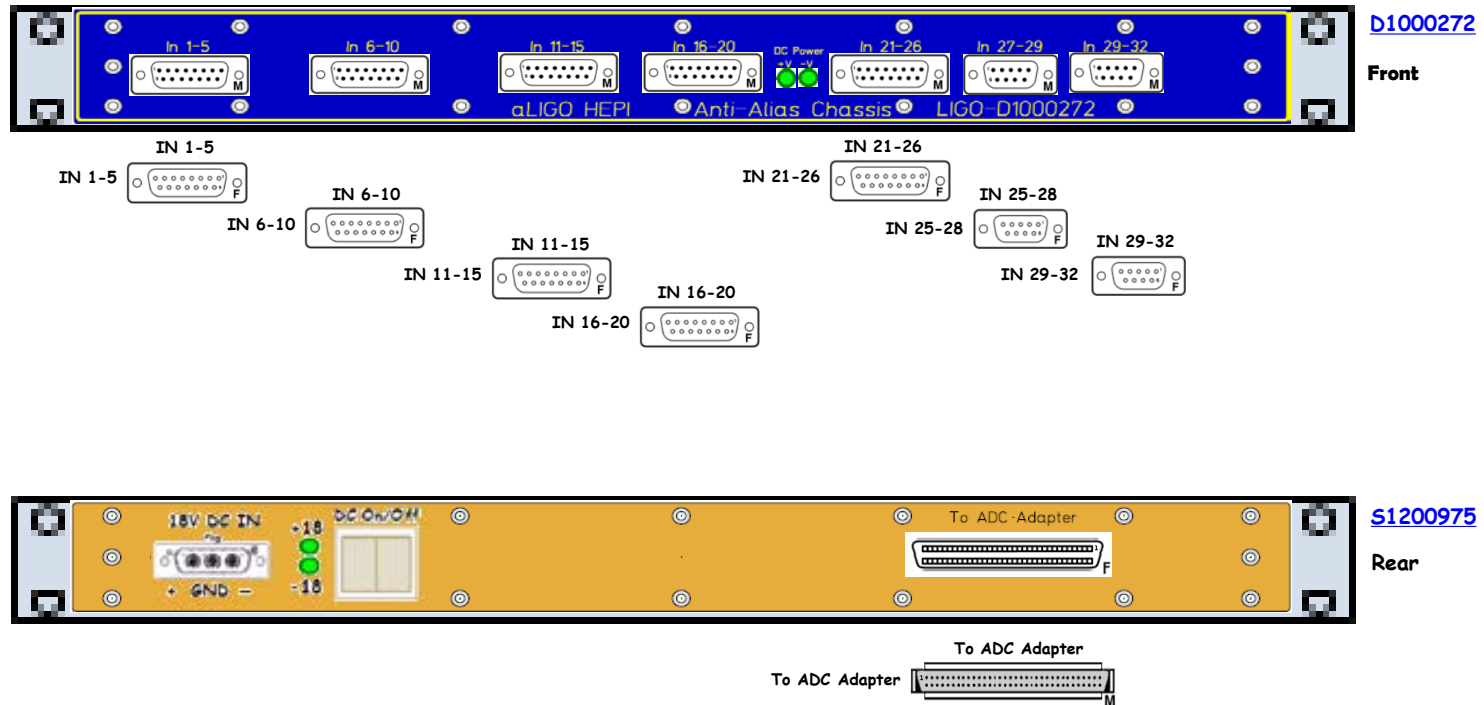

D1100202 - S1200592



<< L1-SEI-C1

HAM1 HEPI Anti-Image Chassis D1100202 S1200592 ±18VDC

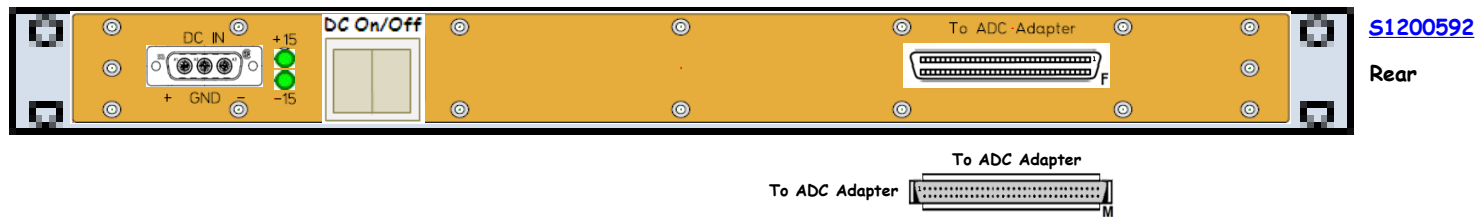
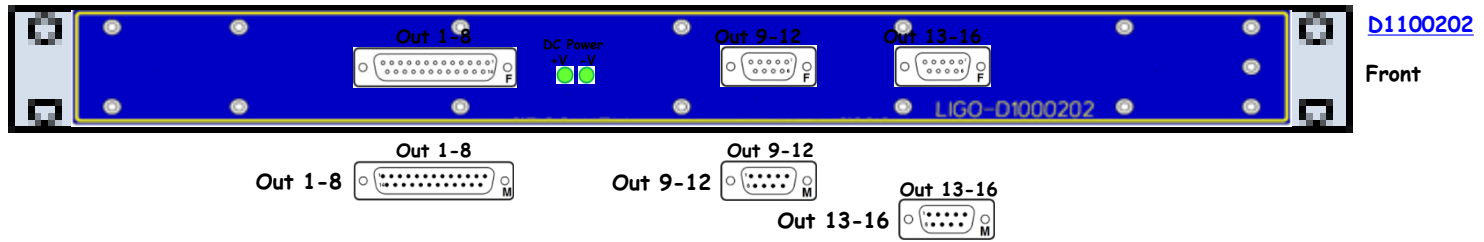

D0900117 - S0900290



<< L1-SEI-C1

HAM1 HEPI 8-Channel Valve Driver D0900117 S0900290 ±18VDC

HAM1

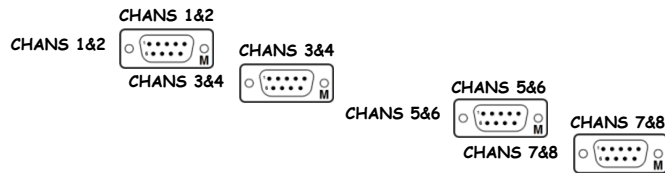
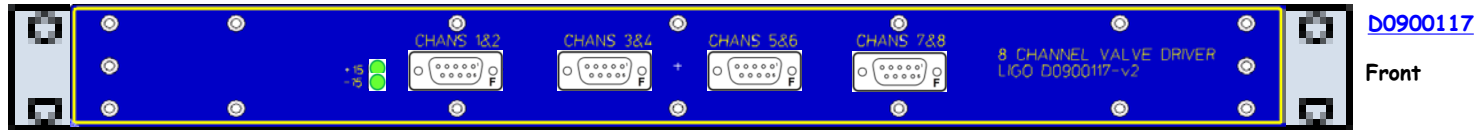

[D0900117](#) is part of [D0901338](#)

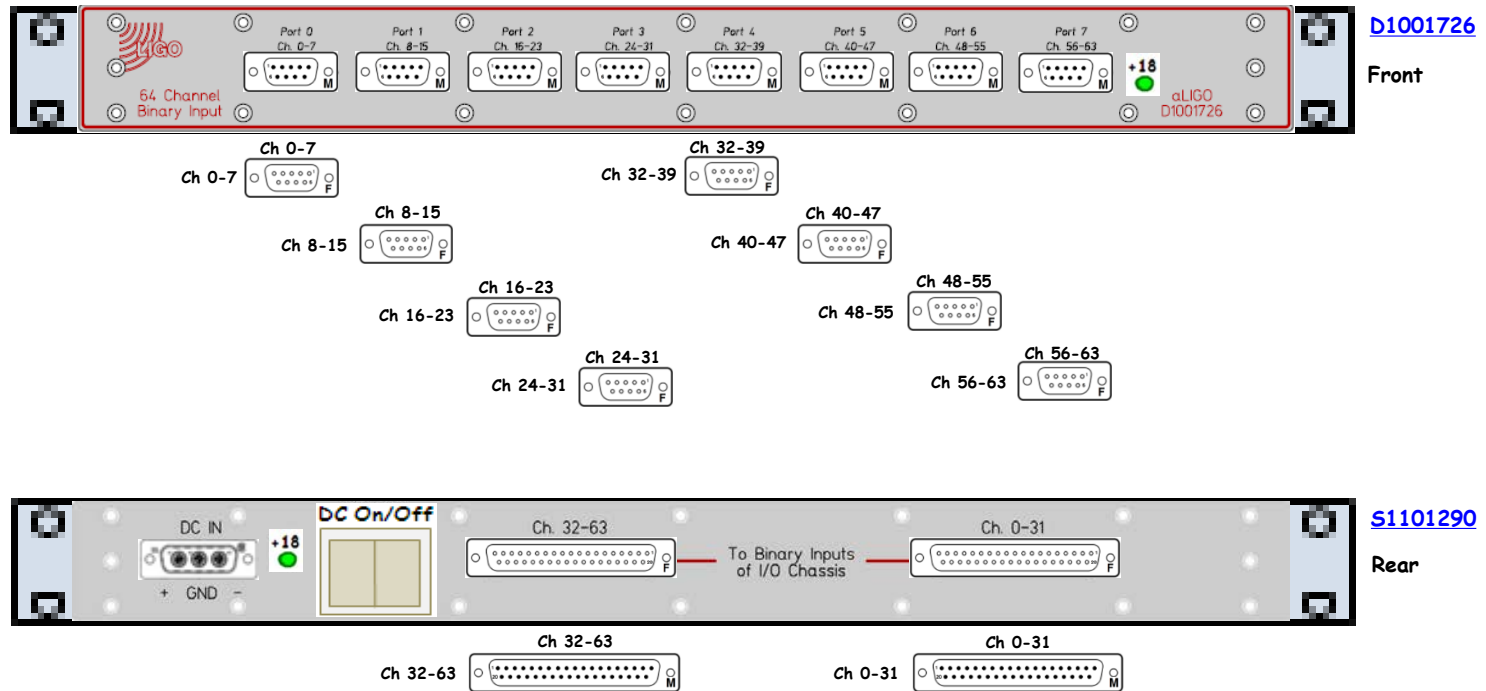

HAM6 HEPI Binary Output Chassis D1001728 S1101324 +18VDC

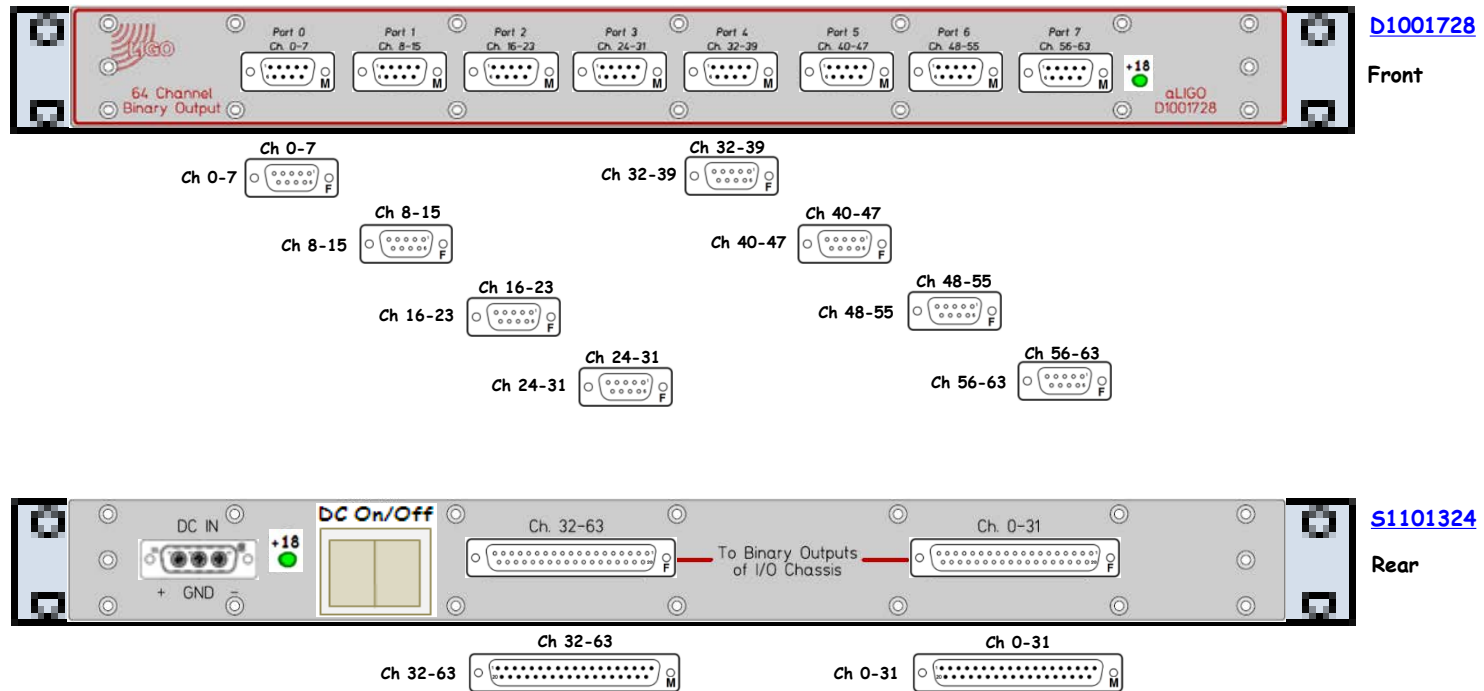

D1000272 - S1200952



<< L1-SEI-C1

HAM6 HEPI Anti-Alias Chassis D1000272 S1200952 ±18VDC

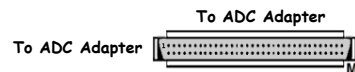
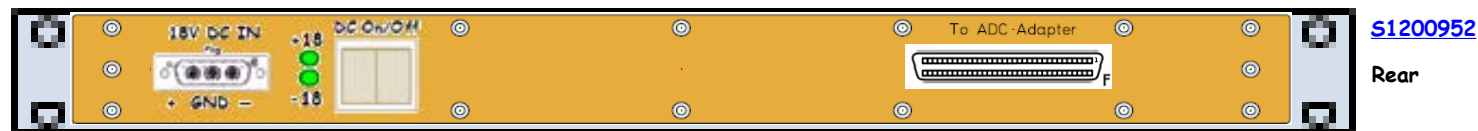
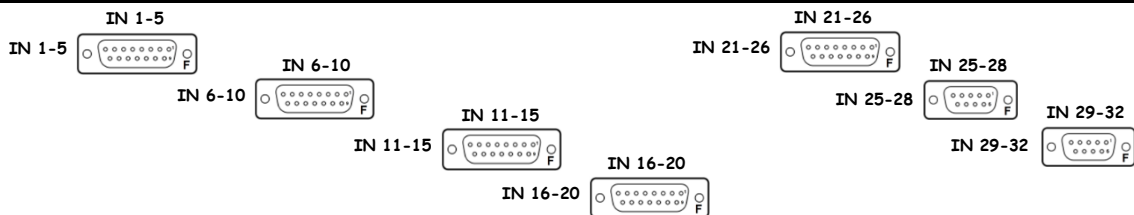
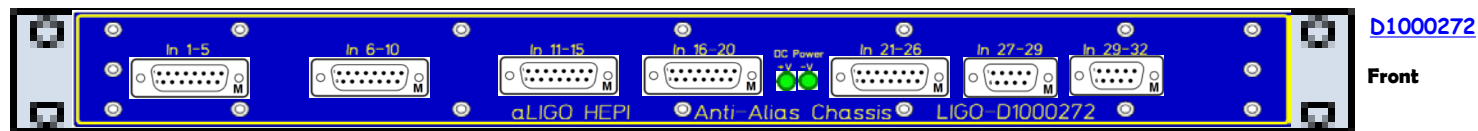

D0900117 - S0900274



<< L1-SEI-C1

HAM6 HEPI 8-Channel Valve Driver D0900117 S0900274 ±18VDC

HAM6

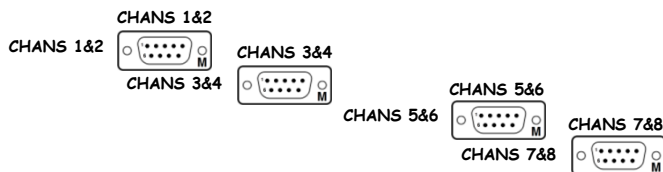
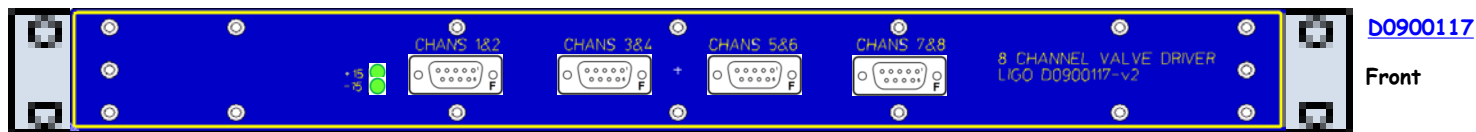

[D0900117](#) is part of [D0901338](#)



D1001715

Front

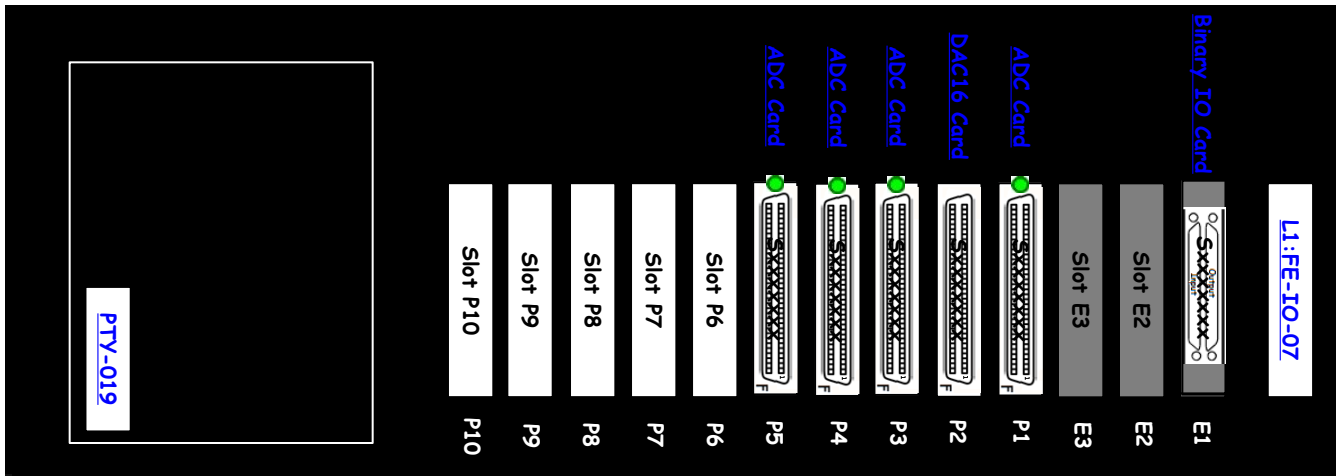

S1001144

Rear

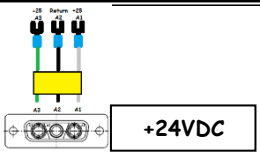
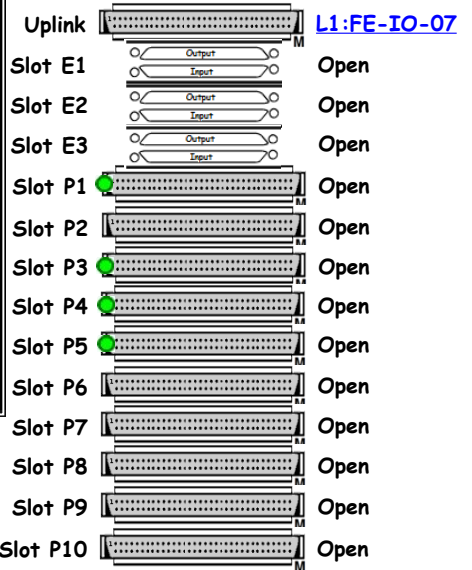

HAM2 ISI Interface Chassis	D1000067	42	S1107434	±18VDC
HAM2 ISI Interface Chassis	D1000067	41	S1107435	±18VDC
		40		
HAM2 ISI Anti-Alias Chassis	D1000269	39	S1104621	±18VDC
HAM2 ISI Anti-Alias Chassis	D1000269	38	S1104638	±18VDC
HAM2 HEPI Anti-Image Chassis	D1100202	37	S1104572	±18VDC
HAM2 ISI Coil Driver Pod 1 and Pod 2	D0902744	36	S1103300	±24VDC
		35		
HAM2 ISI Coil Driver Pod 3	D0902744	34	S1103332	±24VDC
		33		
		32		
HAM3 ISI Interface Chassis	D1000067	31	S1107436	±18VDC
HAM3 ISI Interface Chassis	D1000067	30	S1200668	±18VDC
		29		
HAM3 ISI Anti-Alias Chassis	D1000269	28	S1104632	±18VDC
HAM3 ISI Anti-Alias Chassis	D1000269	27	S1104635	±18VDC
HAM3 HEPI Anti-Image Chassis	D1100202	26	S1104573	±18VDC
HAM3 ISI Coil Driver Pod 1 and Pod 2	D0902744	25	S1103306	±24VDC
		24		
HAM3 ISI Coil Driver Pod 3	D0902744	23	S1103304	±24VDC
		22		
		21		
HAM2 HEPI Anti-Alias Chassis	D1000272	20	S1104616	±18VDC
		19		
HAM2 HEPI 8-Channel Valve Driver	D0900117	18	S0900275	±18VDC
HAM2 HEPI Binary Input Chassis	D1001726	17	S1101286	+18VDC
HAM2/3 HEPI Binary Output Chassis	D1001728	16	S1101321	+18VDC
		15		
HAM3 HEPI Anti-Alias Chassis	D1000272	14	S1104615	±18VDC
		13		
HAM3 HEPI 8-Channel Valve Driver	D0900117	12	S0900291	±18VDC
		11		
		10		
		9		
		8		
		7		
		6		
		5		
		4		
l1seiham23 I/O Extension Chassis	D1001715	3	S1001145	+24VDC
		2		
		1		

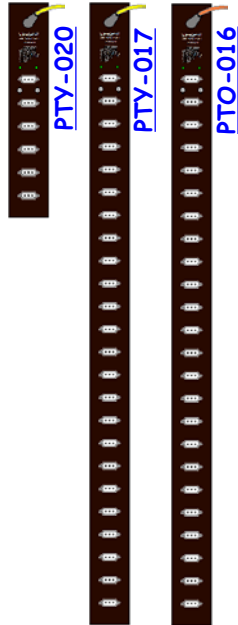

SEI-C2 is part of [D1101576](#)

Front

Rear

L1-SEI-C2 Details

SEI-C2 is part of [D1101576](#)

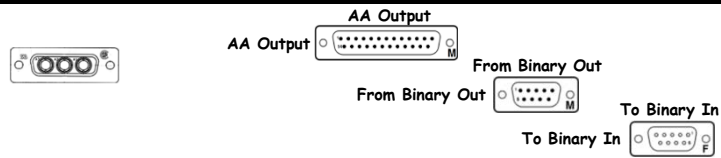
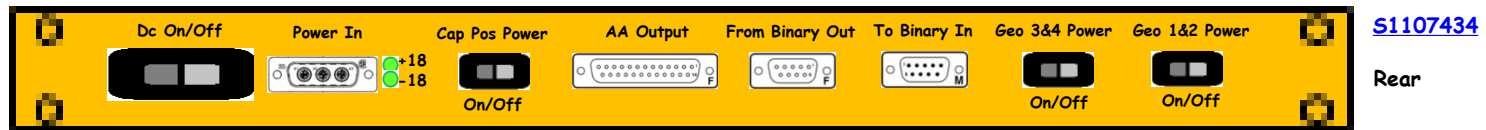
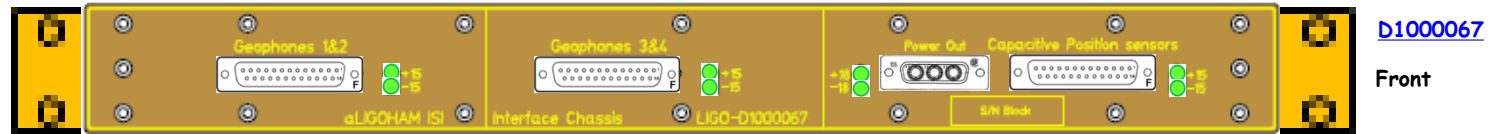

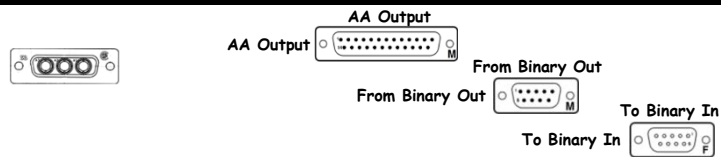
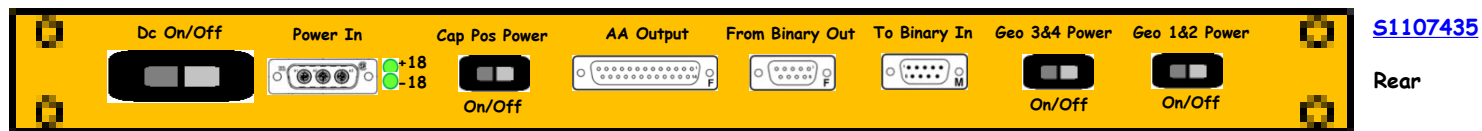
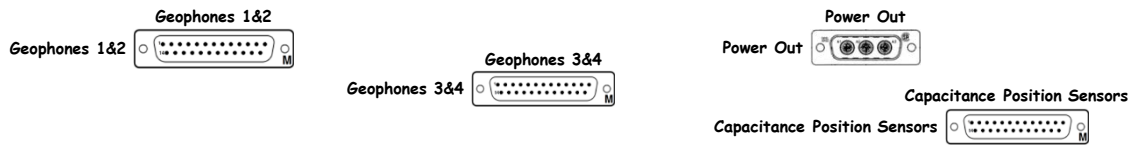
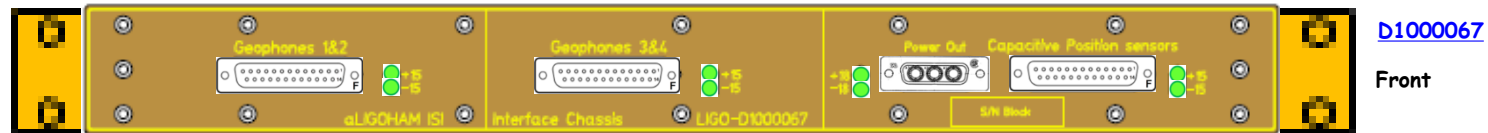

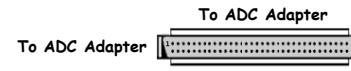
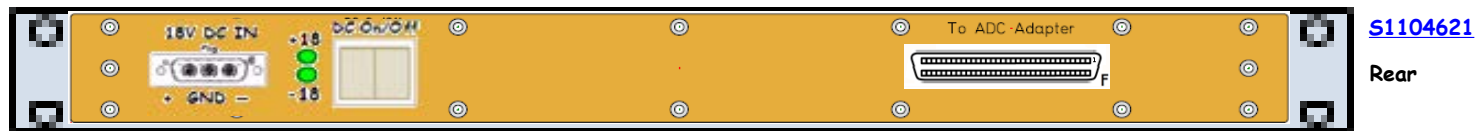
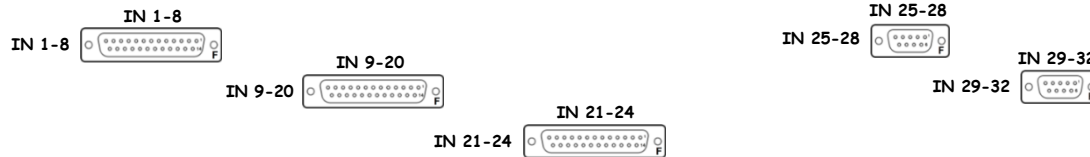

D1000269 - S1104638



<< L1-SEI-C2

HAM2 ISI Anti-Alias Chassis

D1000269

S1104638

±18VDC

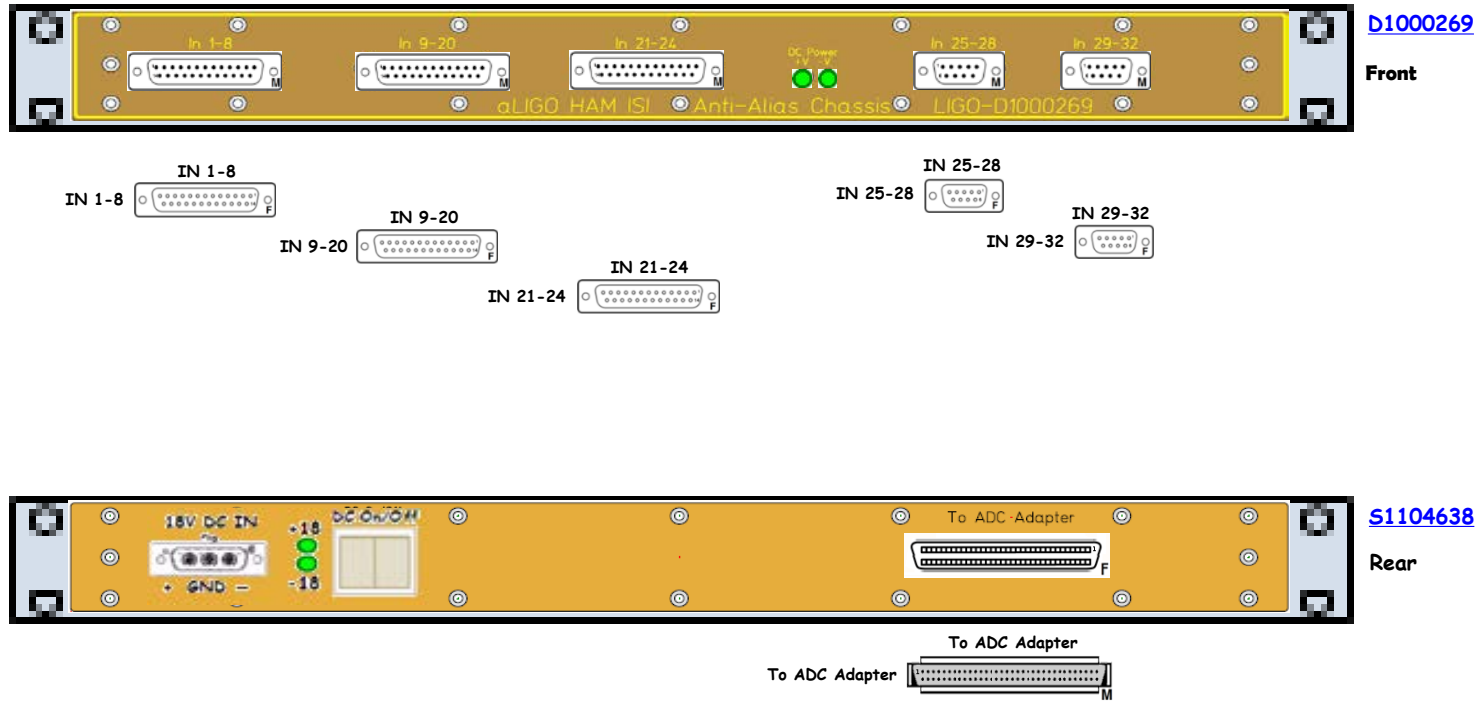

D1000269

Front

S1104638

Rear

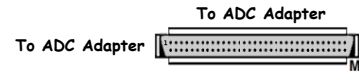

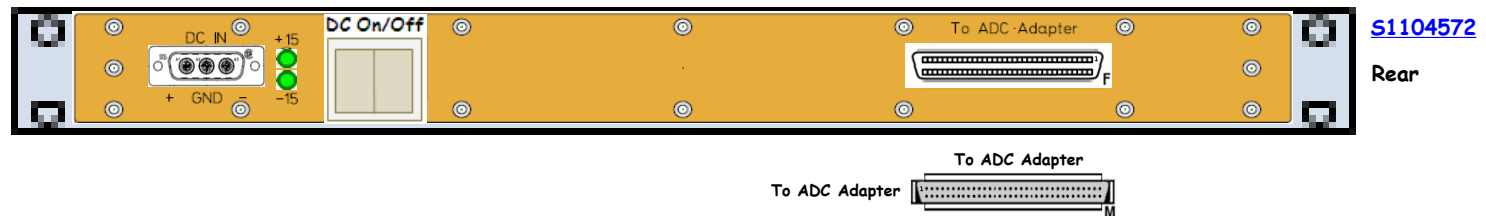
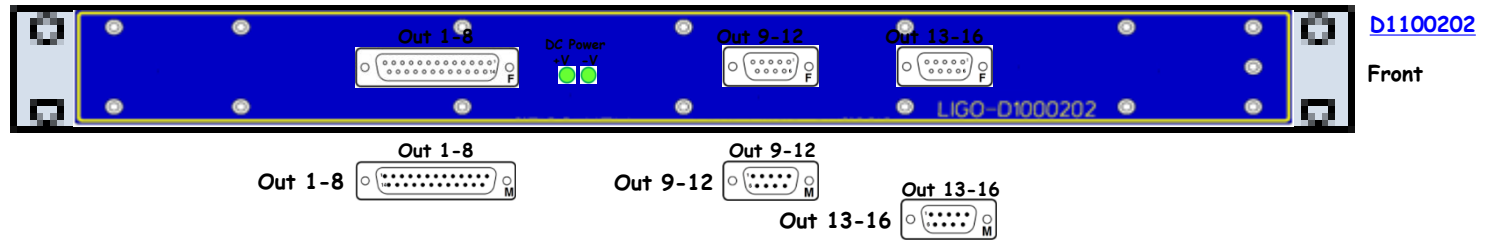

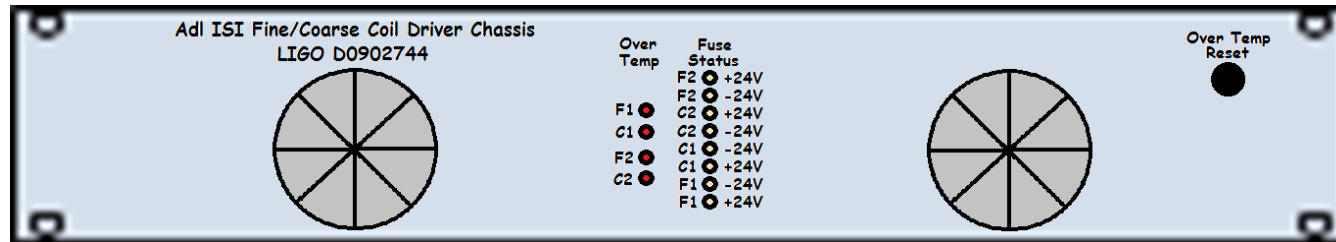

D0902744

Front

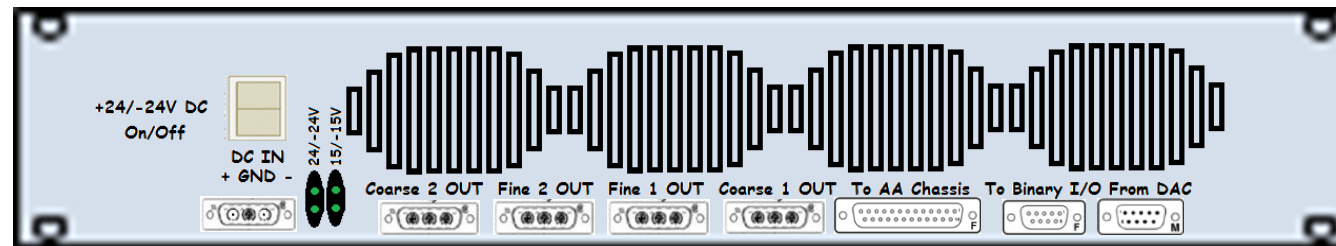

S1103300

Rear

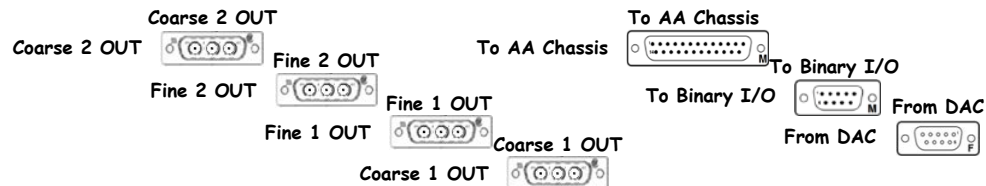

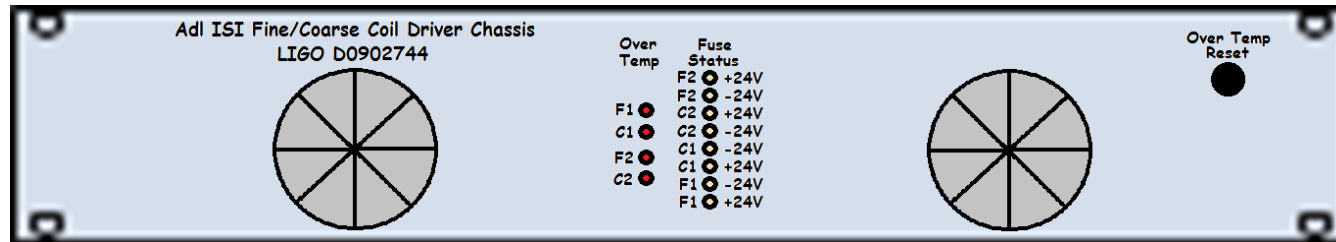

[D0902744](#)

Front

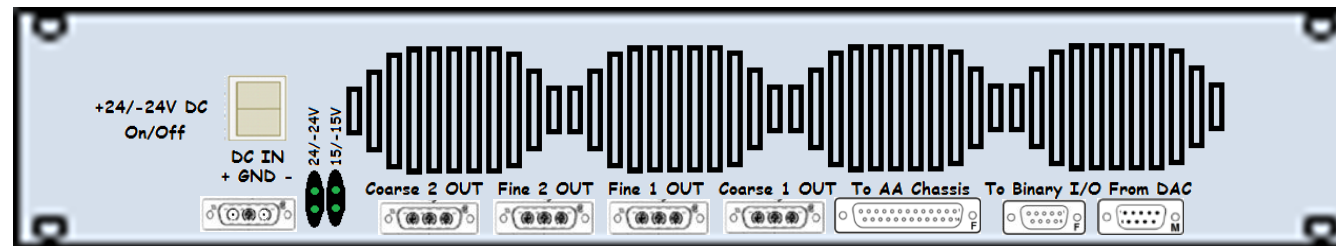

[S1103332](#)

Rear

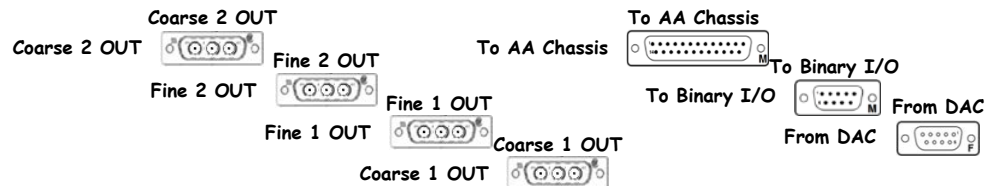

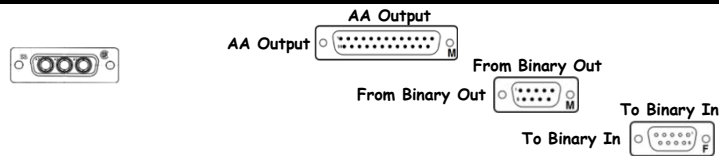
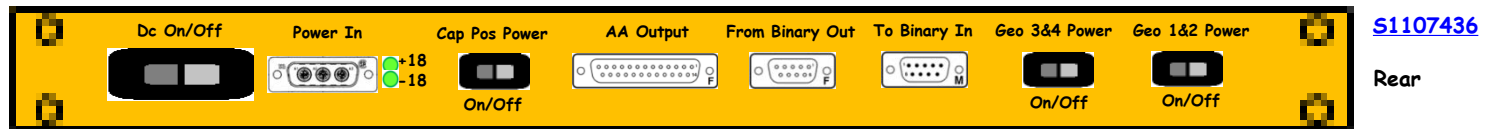
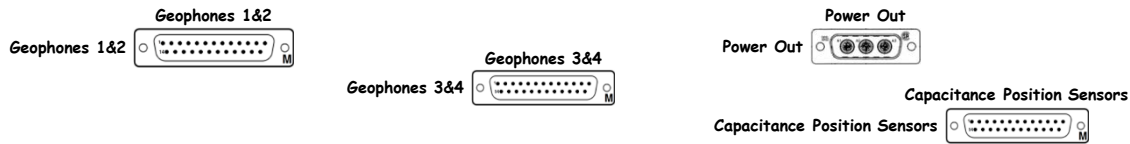
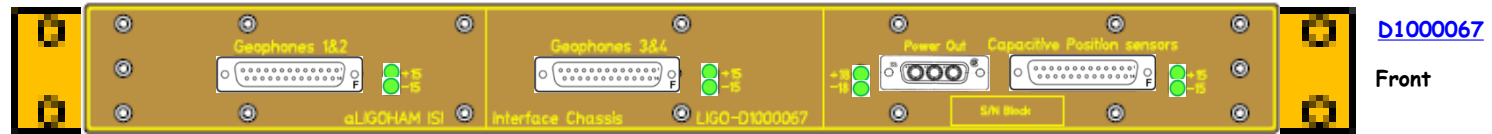

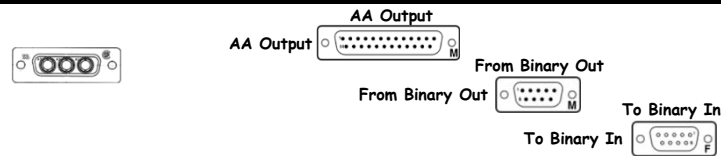
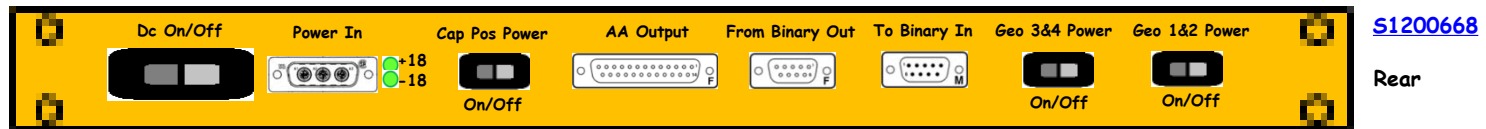
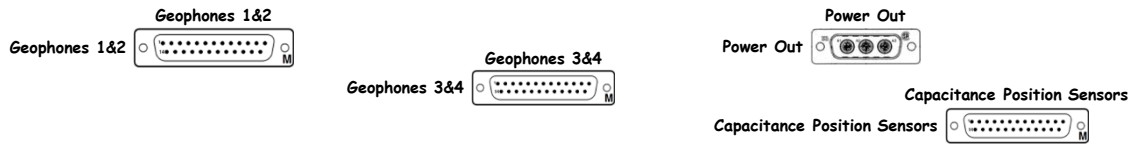
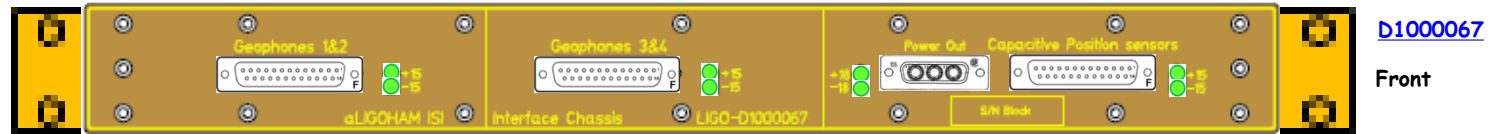

D1000269 - S1104632



<< L1-SEI-C2

HAM3 ISI Anti-Alias Chassis

D1000269

S1104632

±18VDC

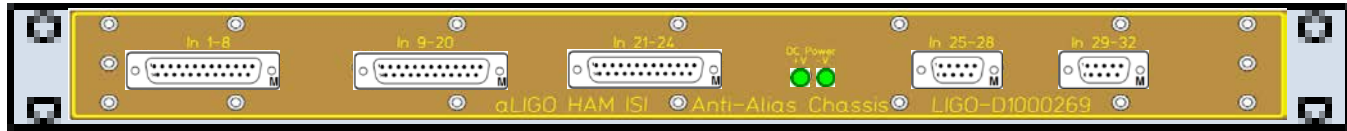

D1000269

Front

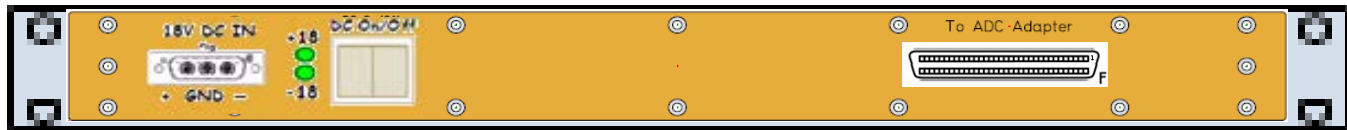
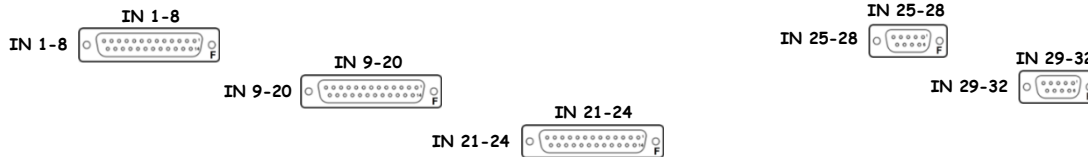

S1104632

Rear

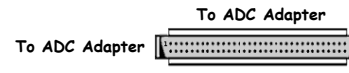

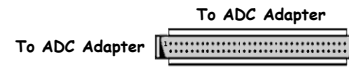
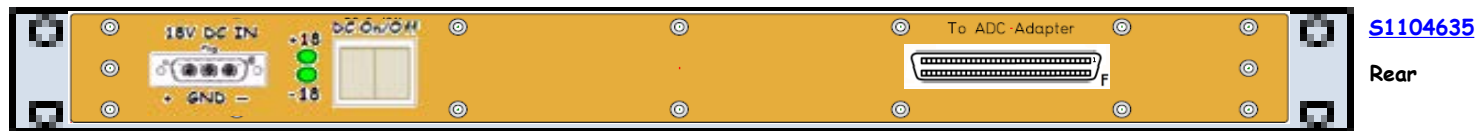
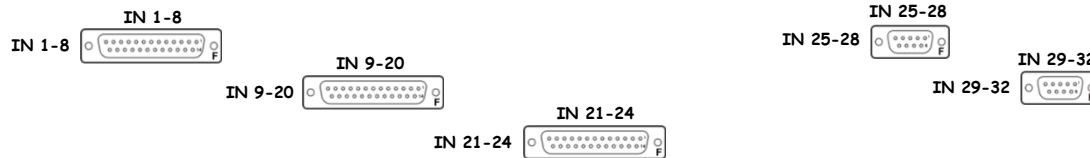
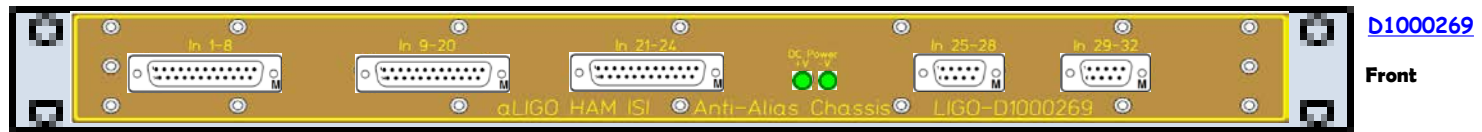

HAM3 HEPI Anti-Image Chassis D1100202 S1104573 ±18VDC

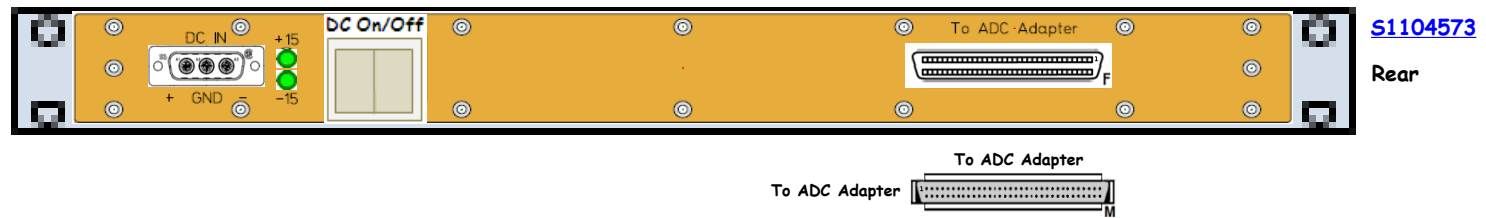
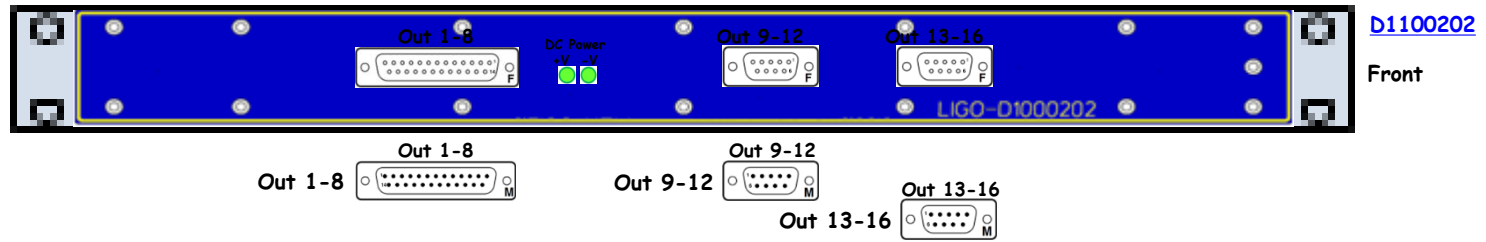

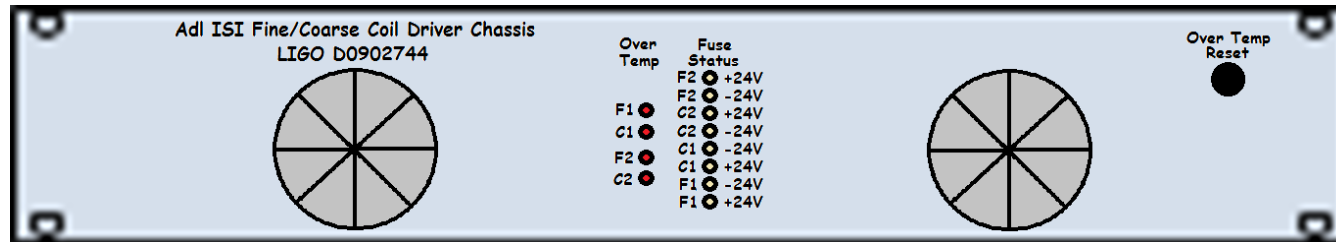

[D0902744](#)

Front

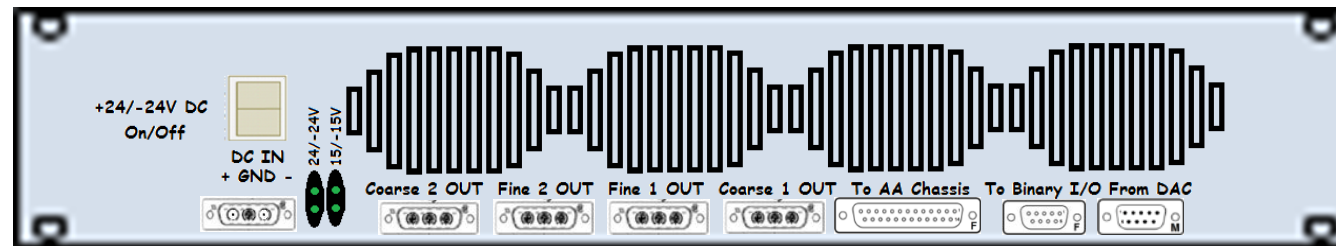

[S1103306](#)

Rear

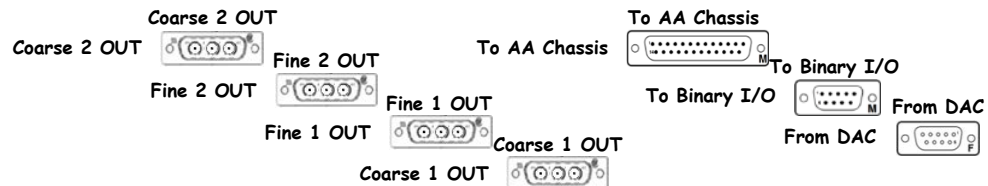

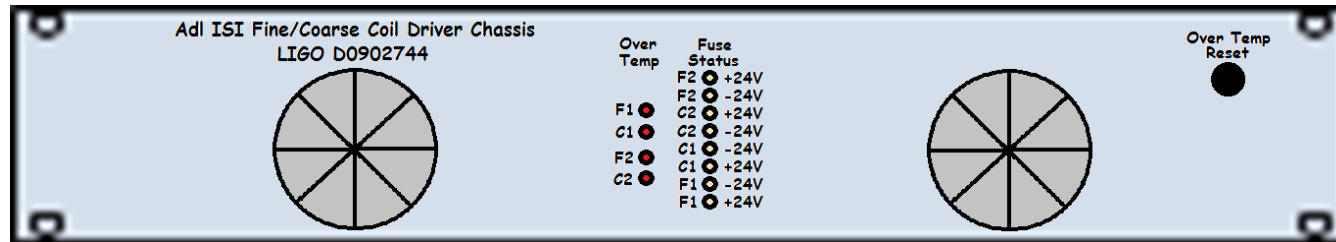

[D0902744](#)

Front

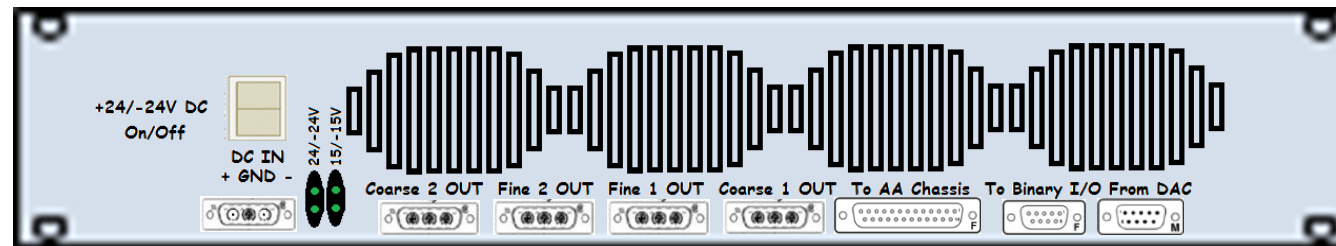

[S1103304](#)

Rear

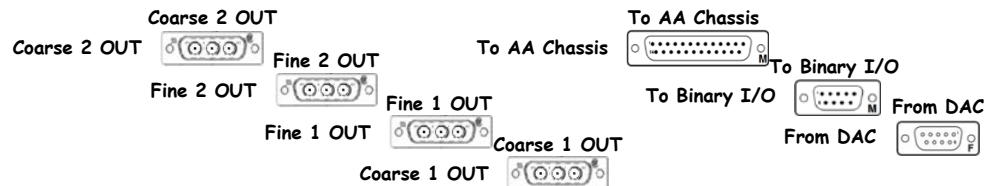

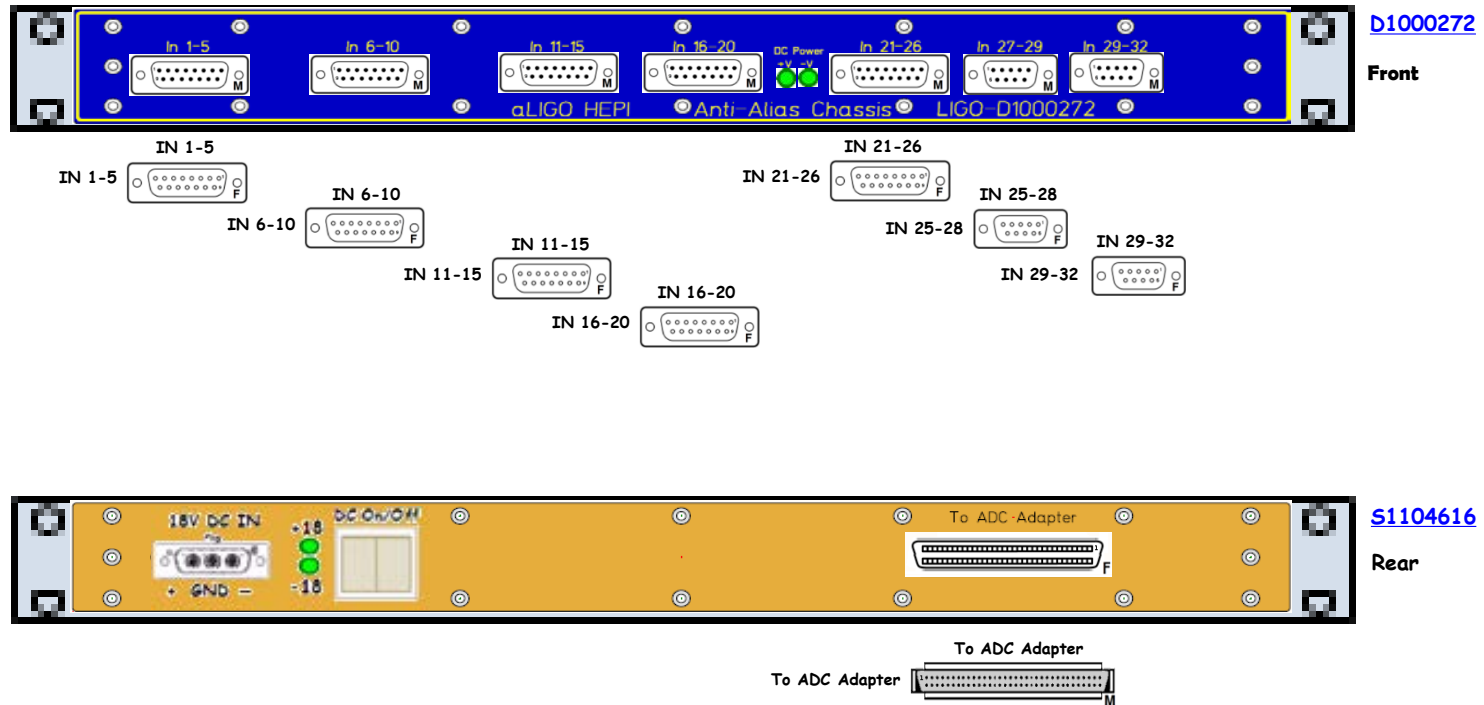

D0900117 - S0900275



<< L1-SEI-C2

HAM2 HEPI 8-Channel Valve Driver D0900117 S0900275 ±18VDC

HAM2

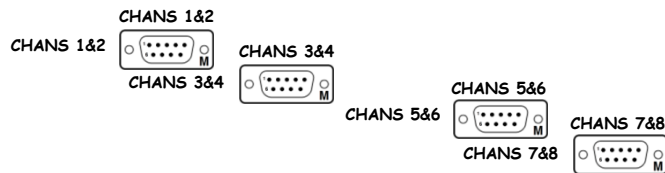
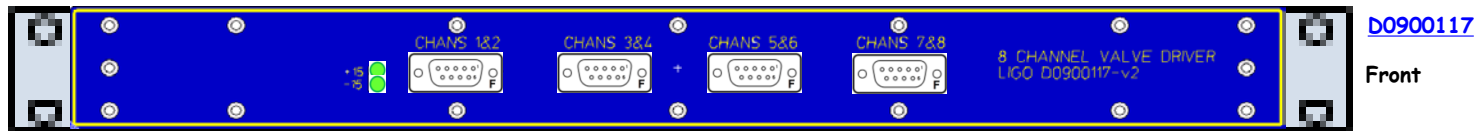

[D0900117](#) is part of [D0901338](#)

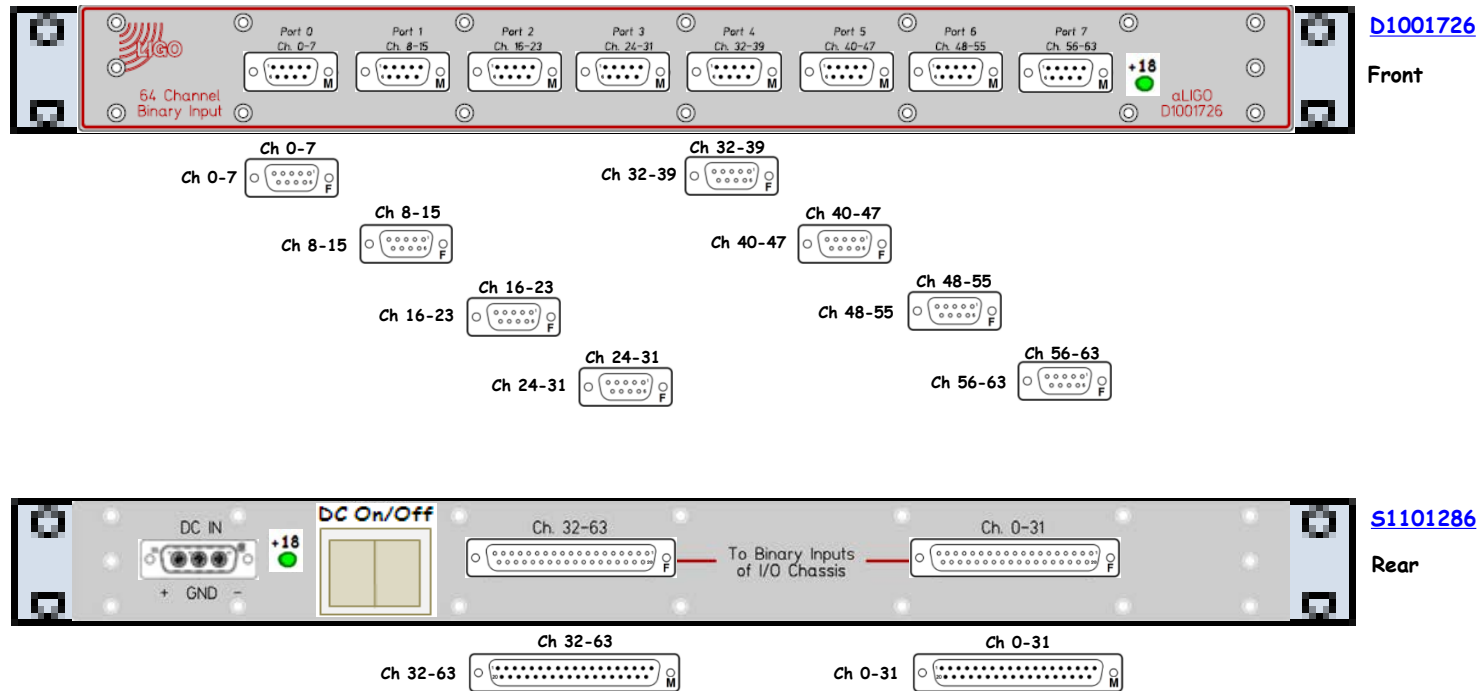

HAM2/3 HEPI Binary Output Chassis D1001728 S1101321 +18VDC

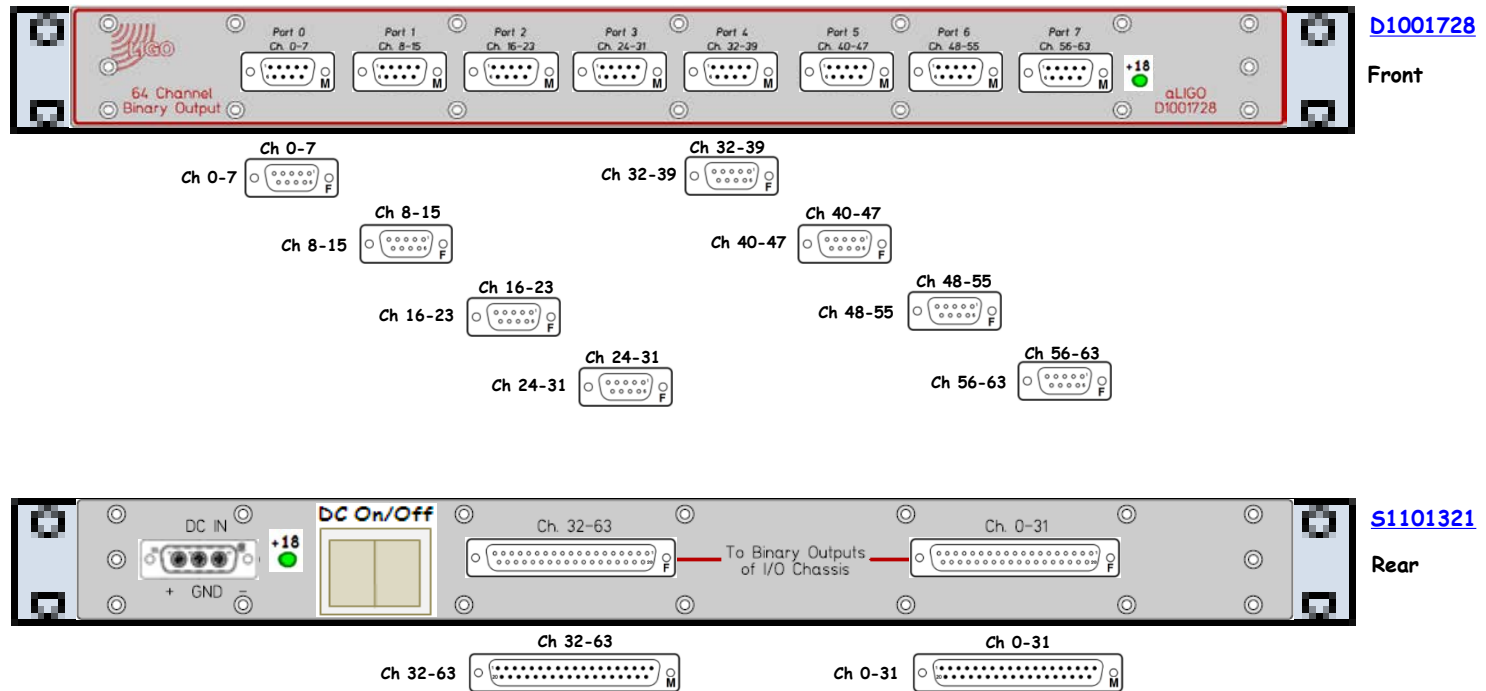

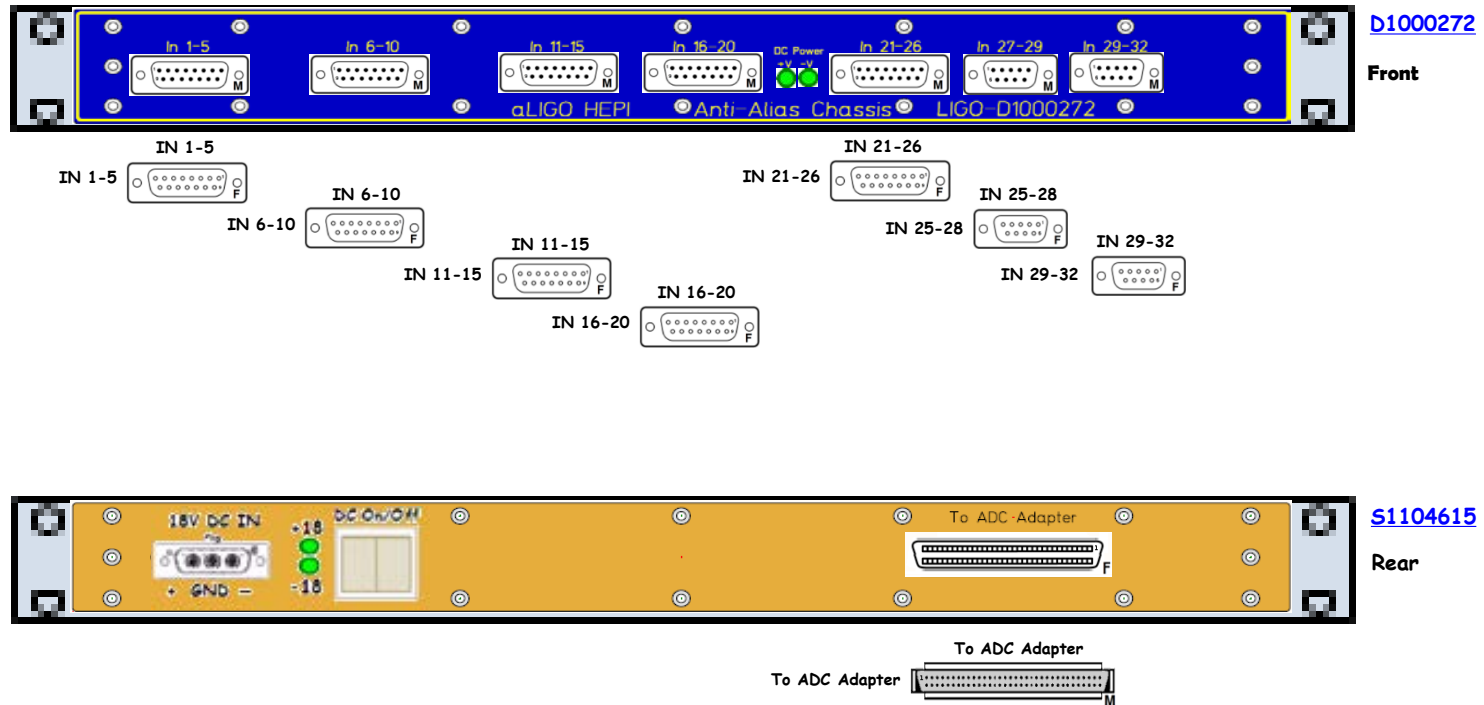

HAM3 HEPI 8-Channel Valve Driver D0900117 S0900291 ±18VDC

HAM3

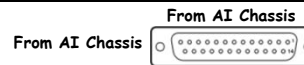
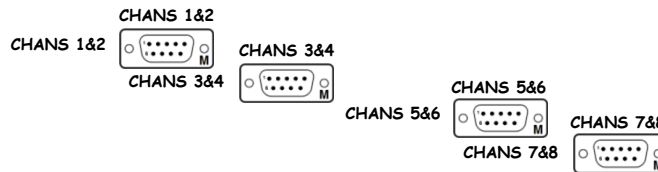
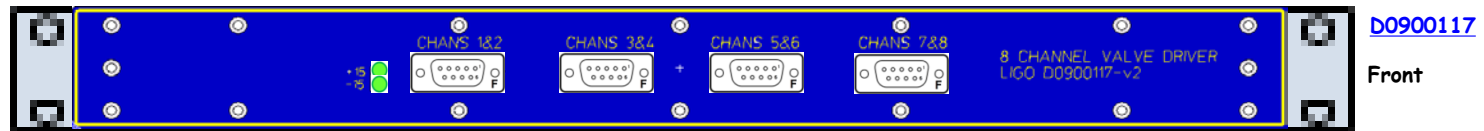

[D0900117](#) is part of [D0901338](#)



D1001715

Front

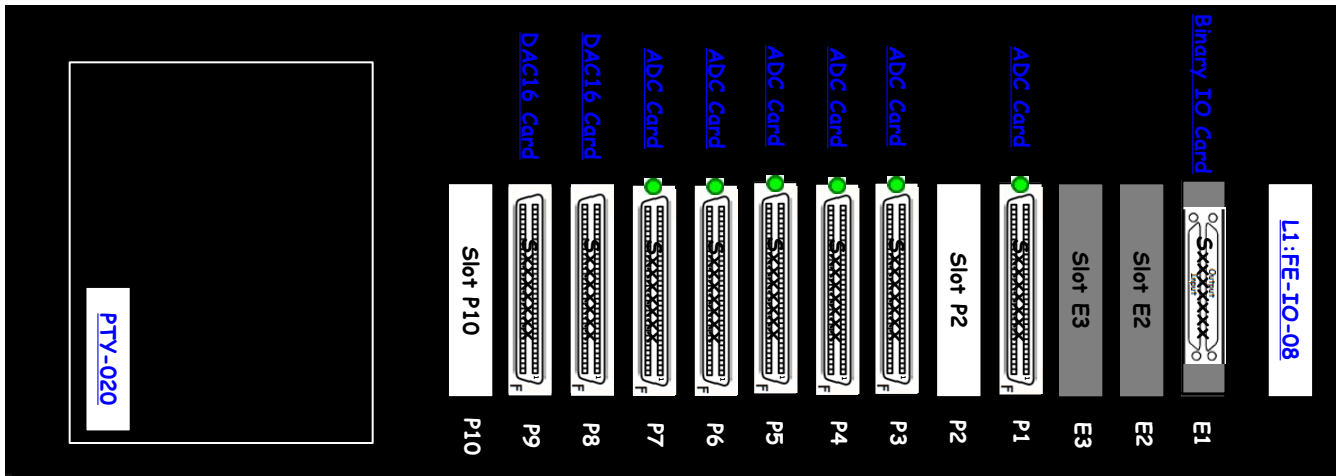

S1001145

Rear

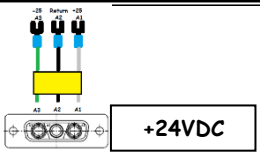
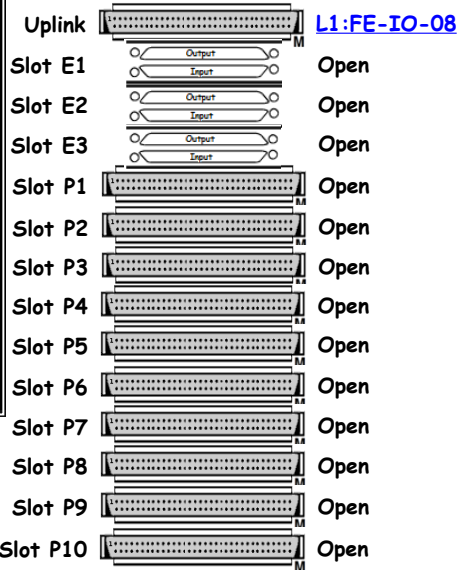

HAM4 ISI Interface Chassis Pod 1	D1002432	42	S1107866	±18VDC
HAM4 ISI Interface Chassis Pod 2	D1002432	41	S1107867	±18VDC
HAM4 ISI Interface Chassis Pod 3	D1002432	40	S1107868	±18VDC
		39		
HAM4 ISI Anti-Alias Chassis	D1000269	38	S1200313	±18VDC
HAM4 ISI Anti-Alias Chassis	D1000269	37	S1107529	±18VDC
HAM4 HEPI Anti-Image Chassis	D1100202	36	S1200319	±18VDC
HAM4 ISI Coil Driver Pod 1 and Pod 2	D0902744	35	S1103308	±24VDC
		34		
HAM4 ISI Coil Driver Pod 3	D0902744	33	S1103325	±24VDC
		32		
		31		
HAM5 ISI Interface Chassis Pod 1	D1002432	30	S1107869	±18VDC
HAM5 ISI Interface Chassis Pod 2	D1002432	29	S1107870	±18VDC
HAM5 ISI Interface Chassis Pod 3	D1002432	28	S1107871	±18VDC
		27		
HAM5 ISI Anti-Alias Chassis	D1000269	26	S1107530	±18VDC
HAM5 ISI Anti-Alias Chassis	D1000269	25	S1107531	±18VDC
HAM5 HEPI Anti-Image Chassis	D1100202	24	S1200318	±18VDC
HAM5 ISI Coil Driver Pod 1 and Pod 2	D0902744	23	S1103326	±24VDC
		22		
HAM5 ISI Coil Driver Pod 3	D0902744	21	S1103324	±24VDC
		20		
		19		
HAM4 HEPI Anti-Alias Chassis	D1000272	18	S1200310	±18VDC
		17		
HAM4 HEPI 8-Channel Valve Driver	D0900117	16	S0900266	±18VDC
HAM4 HEPI Binary Input Chassis	D1001726	15	S1101288	+18VDC
HAM4/5 HEPI Binary Output Chassis	D1001728	14	S1101323	+18VDC
		13		
HAM5 HEPI Anti-Alias Chassis	D1000272	12	S1200311	±18VDC
		11		
HAM5 HEPI 8-Channel Valve Driver	D0900117	10	S0900272	±18VDC
HAM5 HEPI Binary Input Chassis	D1001726	9	S1101289	+18VDC
		8		
		7		
		6		
		5		
		4		
l1seiham45 - I/O Extension Chassis	D1001715	3	S1001146	+24VDC
		2		
		1		

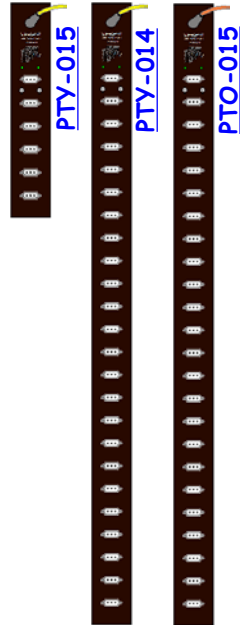

SEI-C3 is part of [D1000298](#)

Front

Rear

L1-SEI-C3 Details

SEI-C3 is part of [D1000298](#)

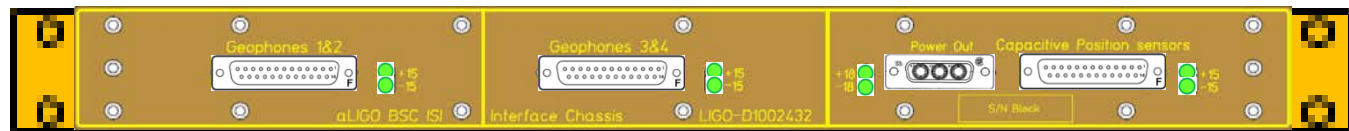

[D1002432](#)

Front

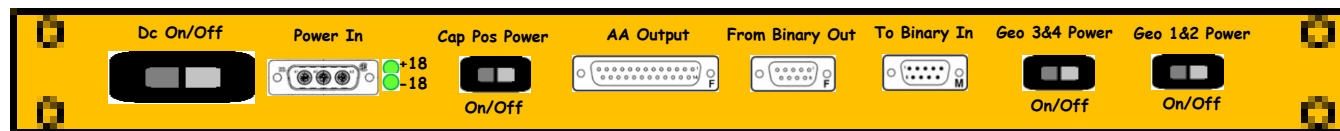
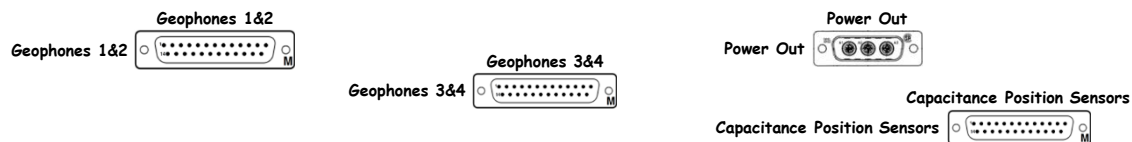

[S1107866](#)

Rear

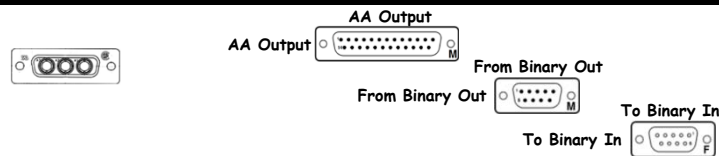

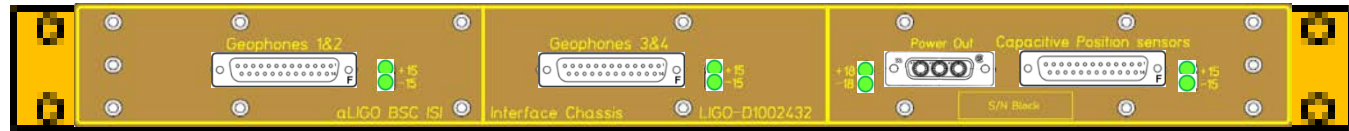

[D1002432](#)

Front

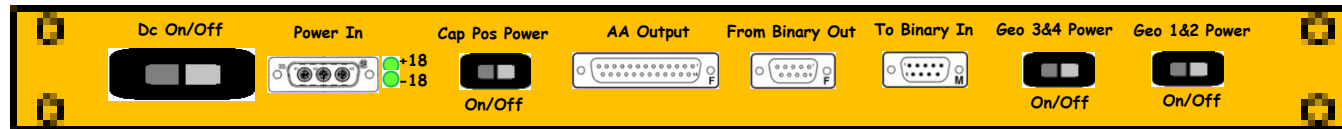
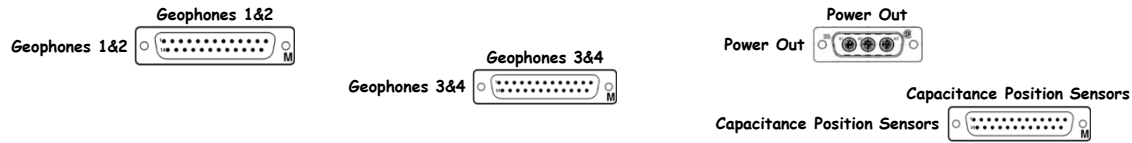

[S1107867](#)

Rear

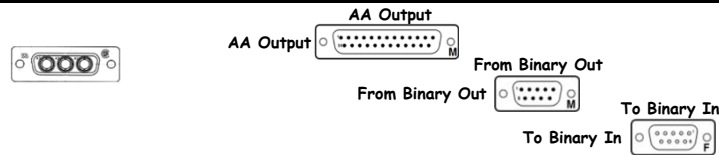

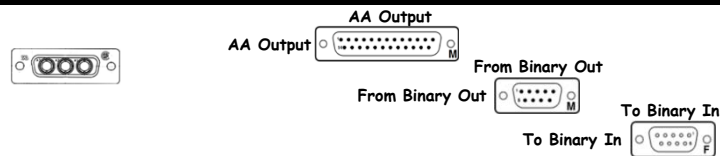
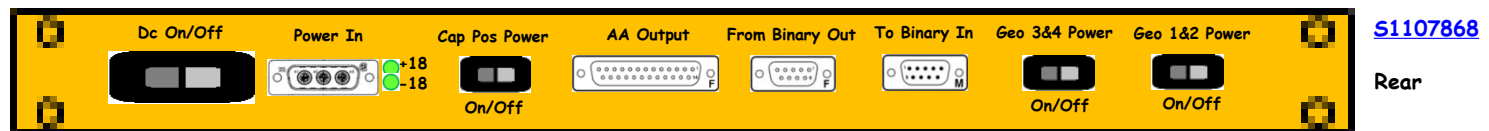
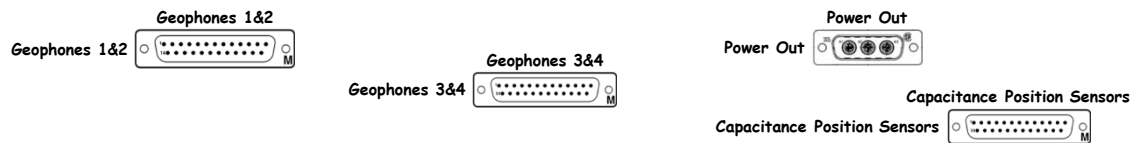

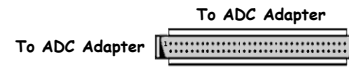
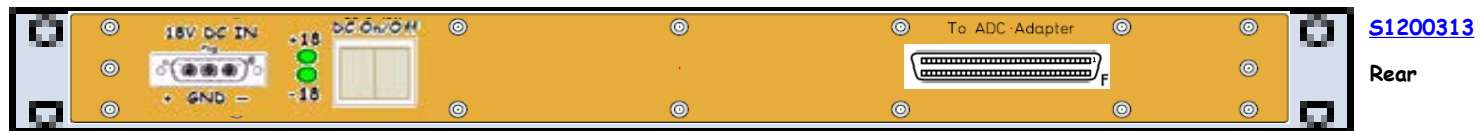
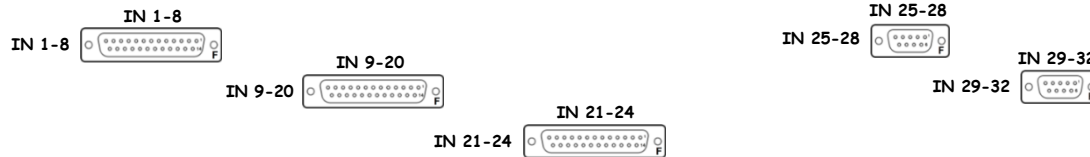

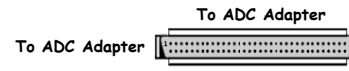
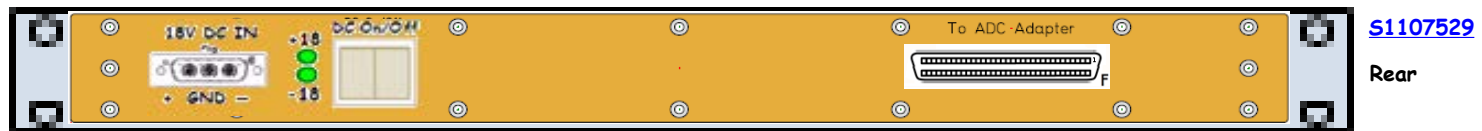
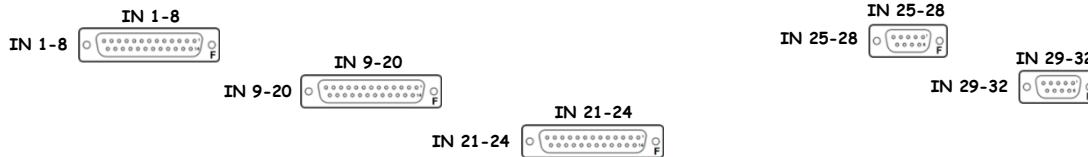

HAM4 HEPI Anti-Image Chassis D1100202 S1200319 ±18VDC

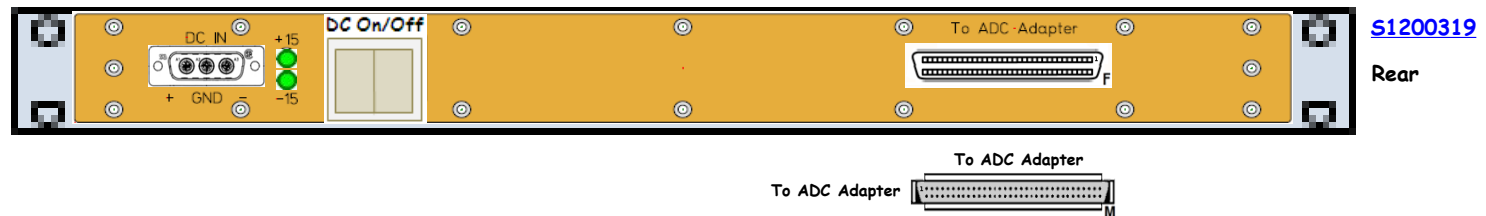
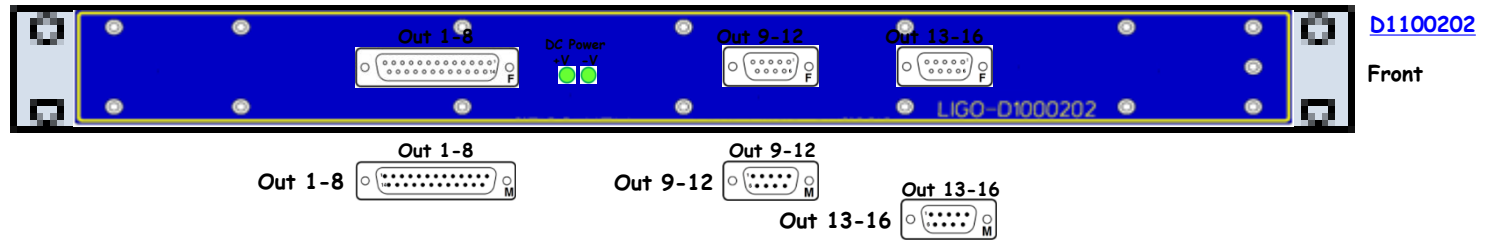

D0902744 - S1103308



<< L1-SEI-C3

HAM4 ISI Coil Driver Pod 1 and Pod 2

D0902744

S1103308

±24VDC

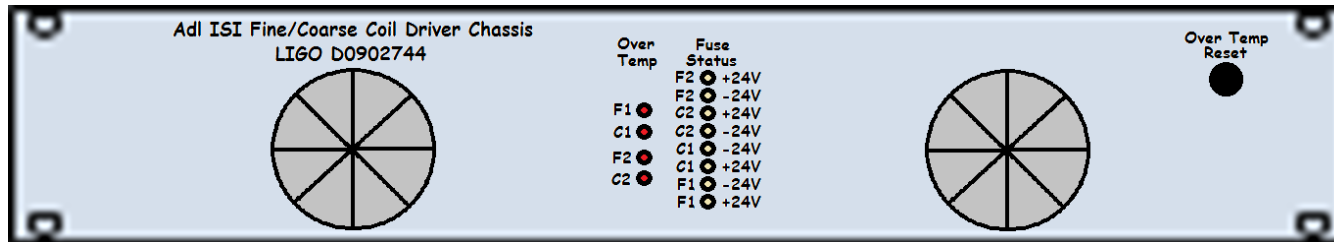

D0902744

Front

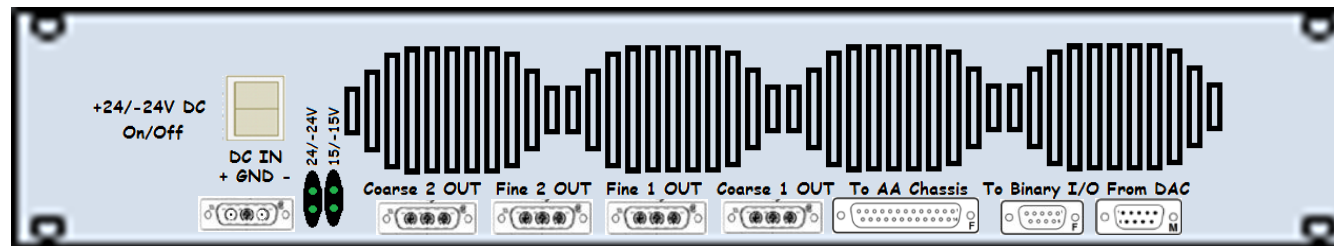

S1103308

Rear

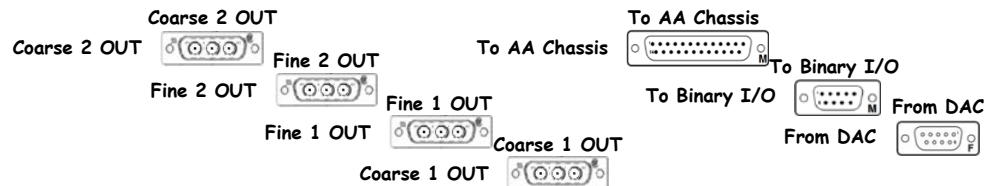

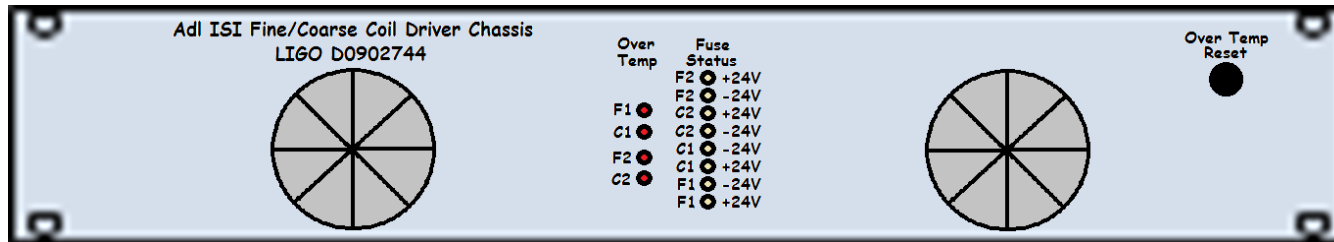

[D0902744](#)

Front

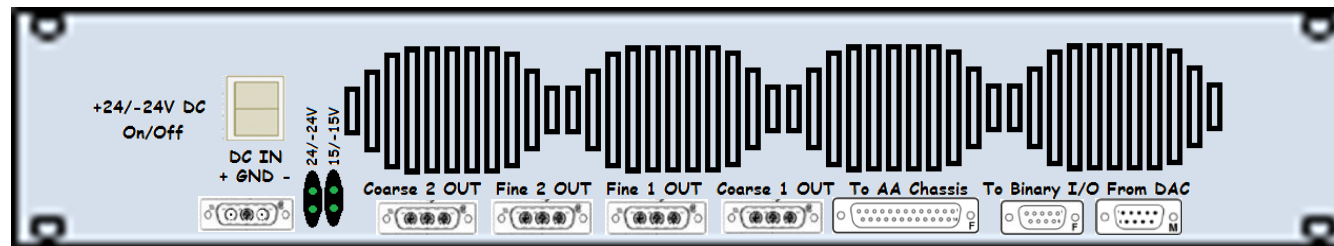

[S1103325](#)

Rear

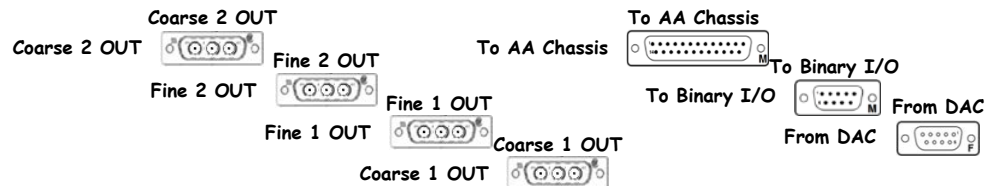

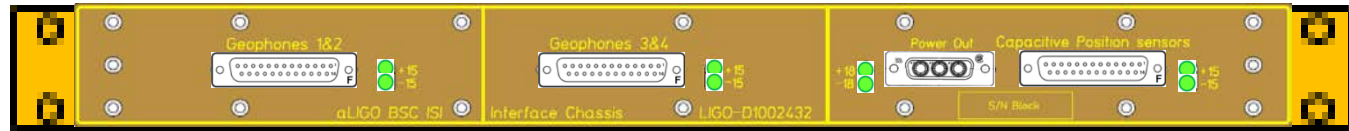

[D1002432](#)

Front

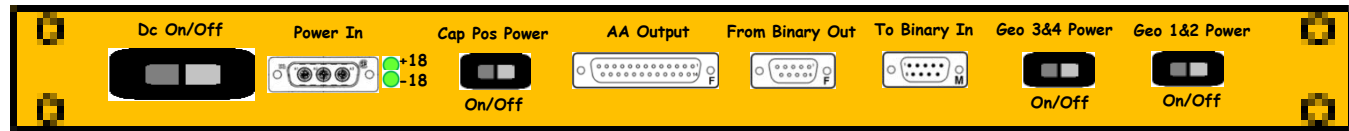
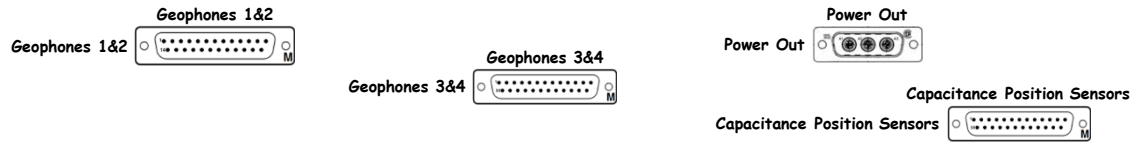

[S1107869](#)

Rear

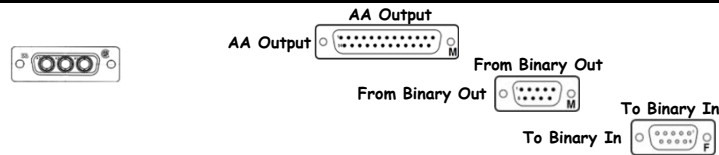

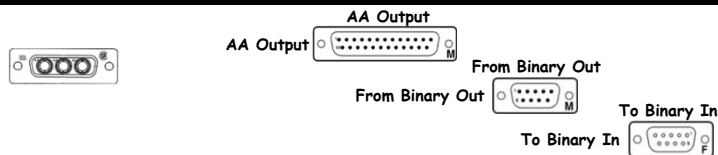
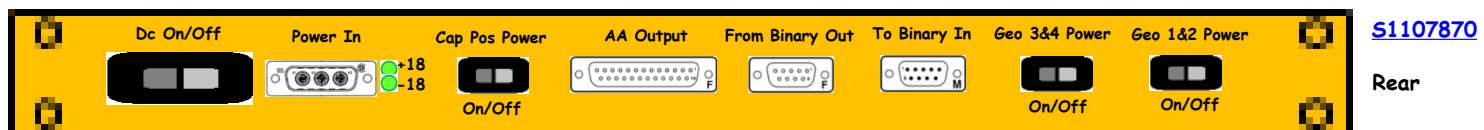
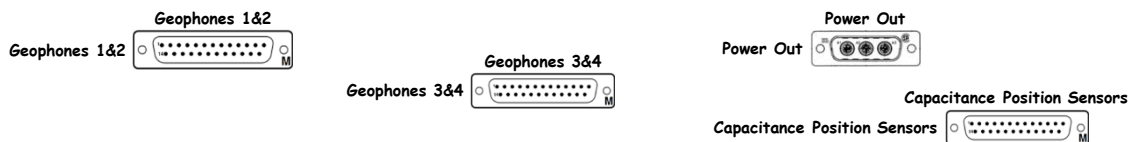

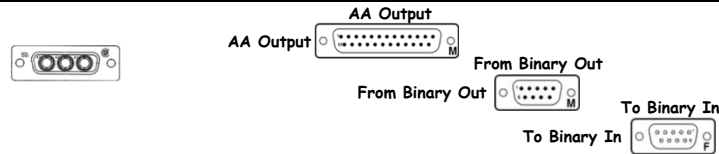
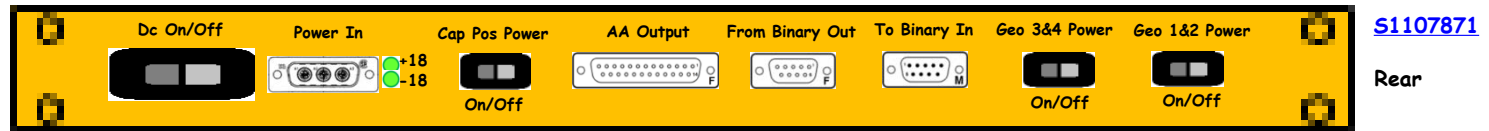
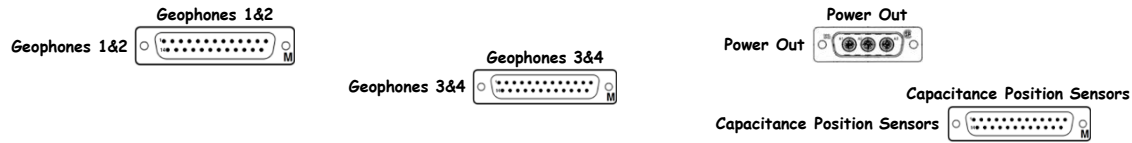
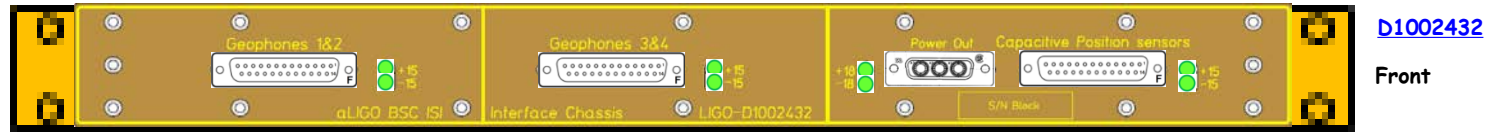

D1000269 - S1107530



<< L1-SEI-C3

HAM5 ISI Anti-Alias Chassis

D1000269

S1107530

±18VDC

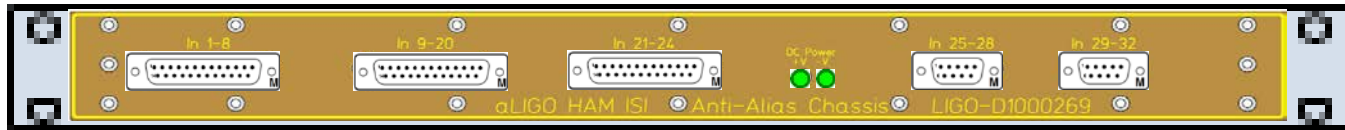

D1000269

Front

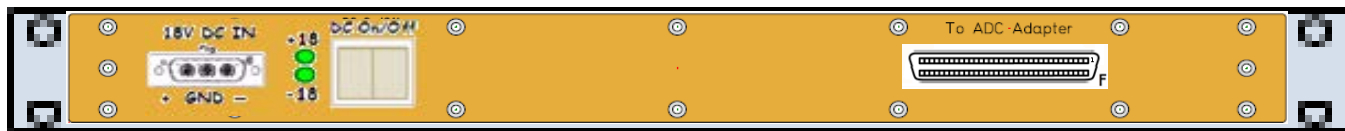
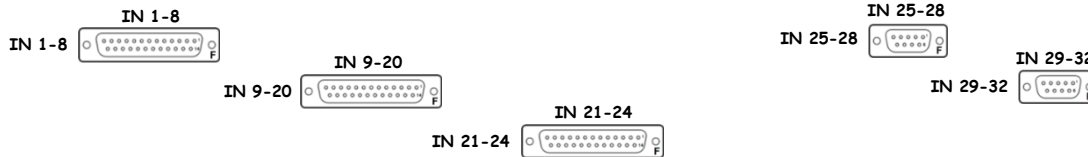

S1107530

Rear

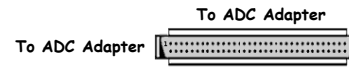

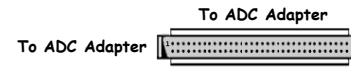
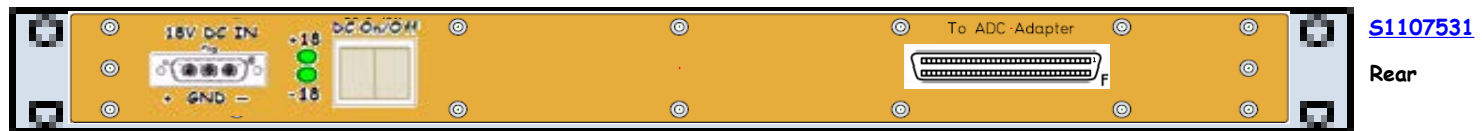
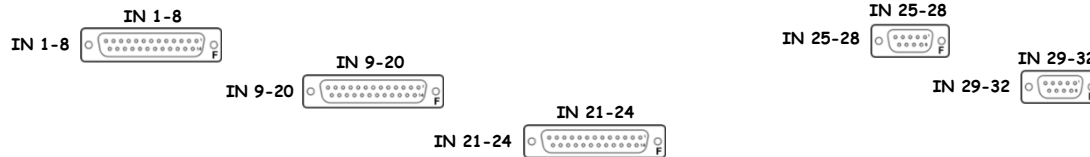

HAM5 HEPI Anti-Image Chassis D1100202 S1200318 ±18VDC

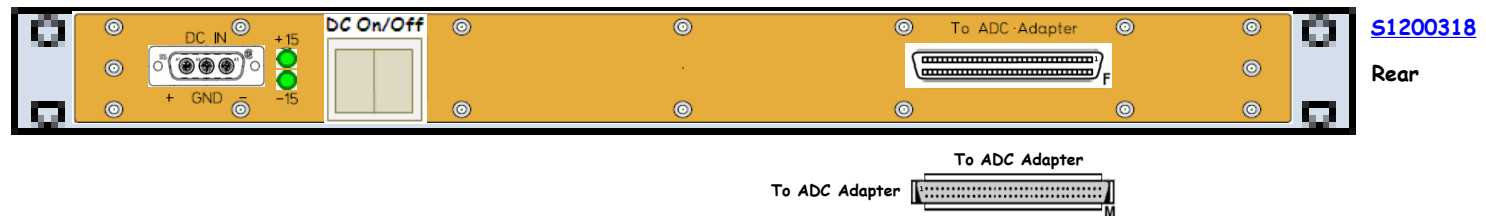
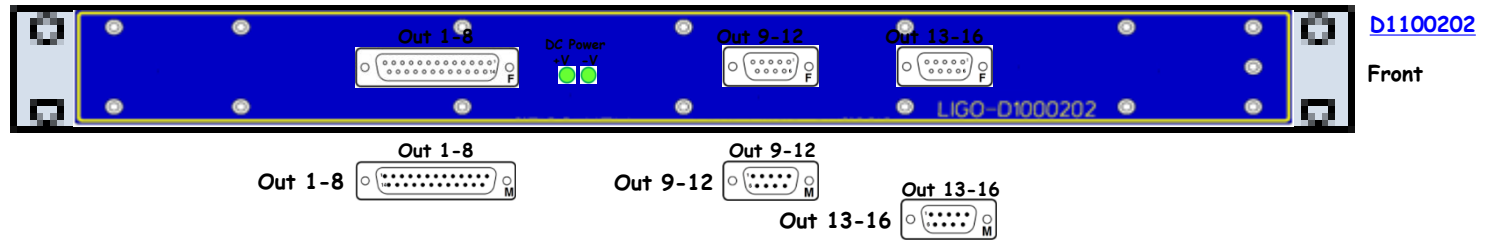

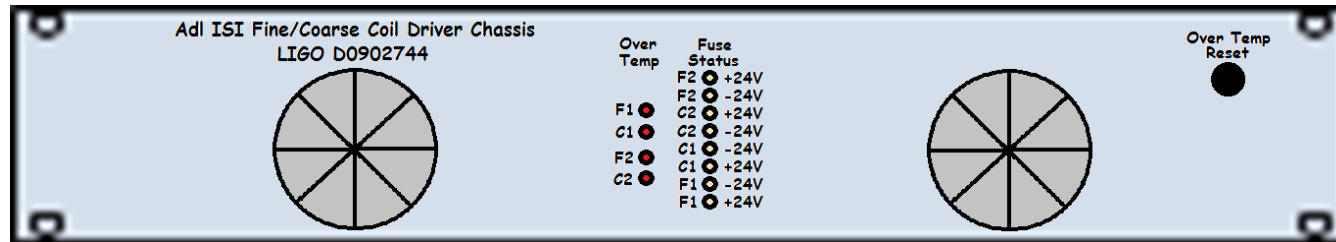

[D0902744](#)

Front

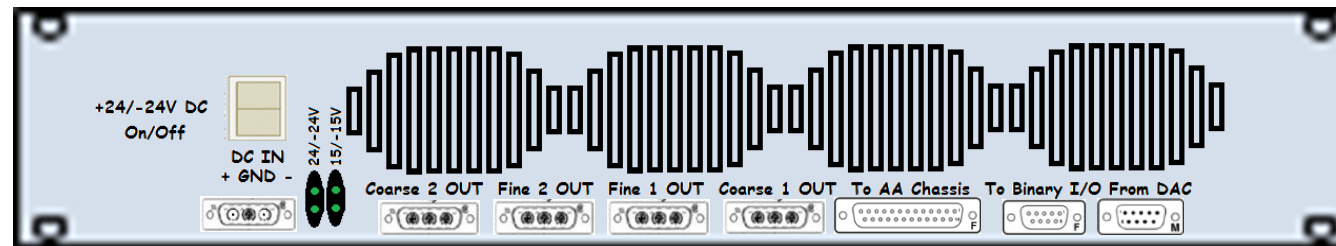

[S1103326](#)

Rear

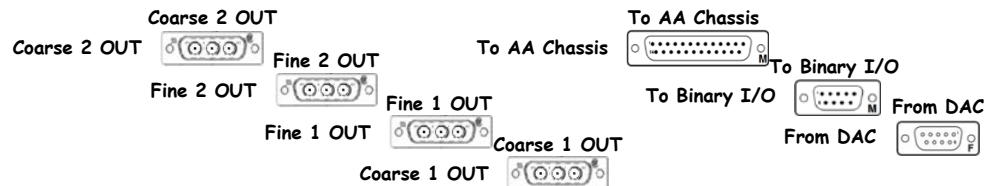

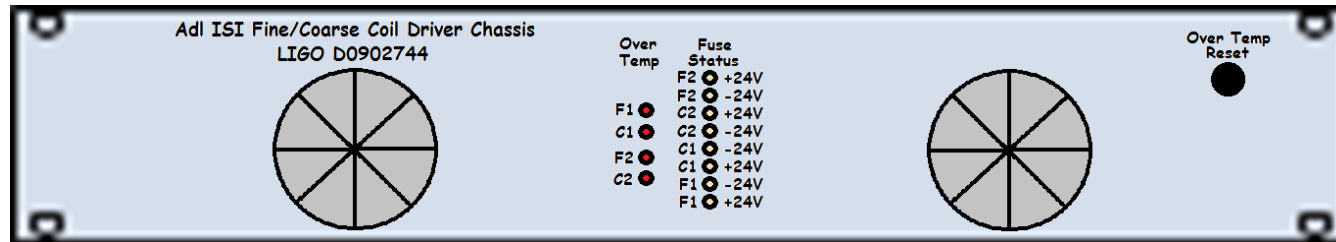

[D0902744](#)

Front

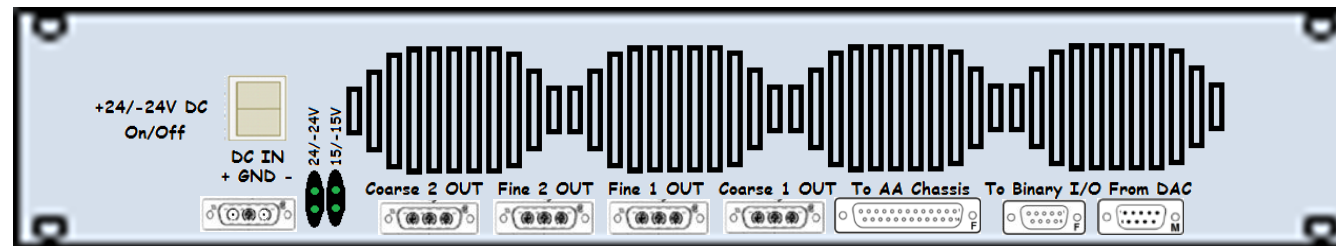

[S1103324](#)

Rear

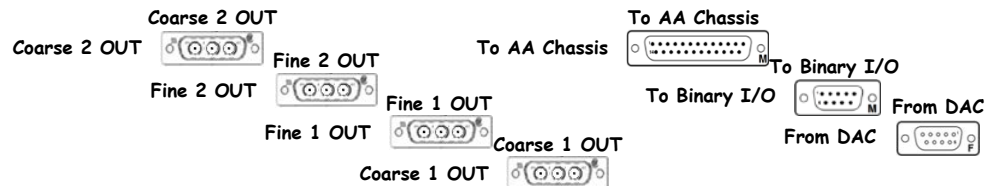

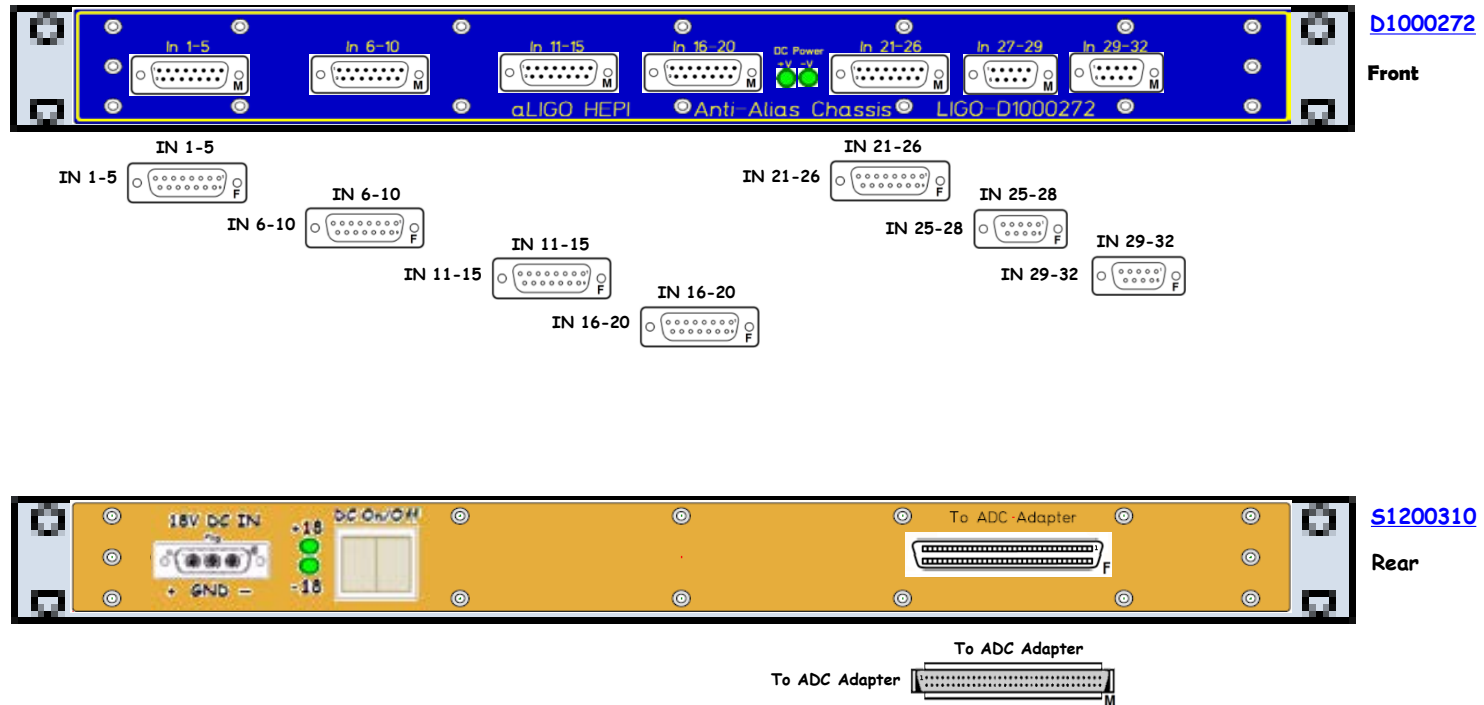

D0900117 - S0900266



<< L1-SEI-C3

HAM4 HEPI 8-Channel Valve Driver D0900117 S0900266 ±18VDC

HAM4

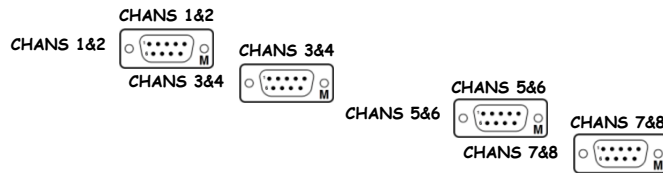
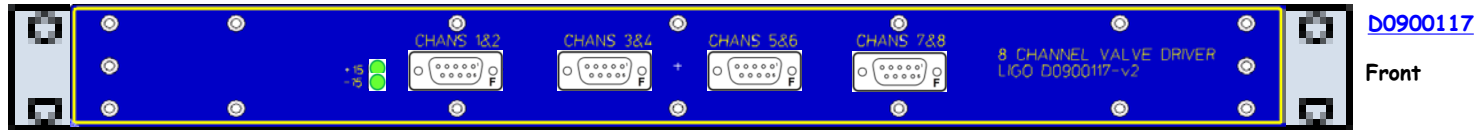

[D0900117](#) is part of [D0901338](#)

HAM4 HEPI Binary Input Chassis D1001726 S1101288 +18VDC

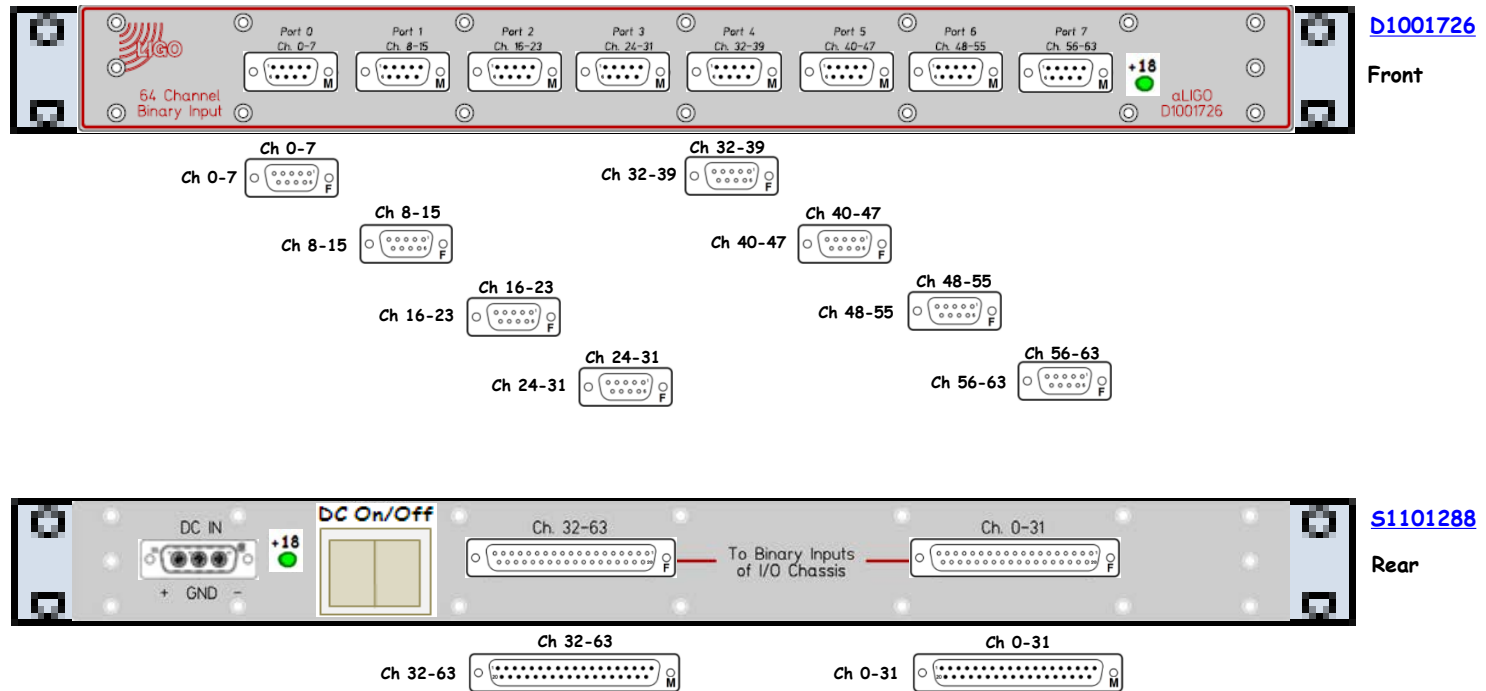

HAM4/5 HEPI Binary Output Chassis D1001728 S1101323 +18VDC

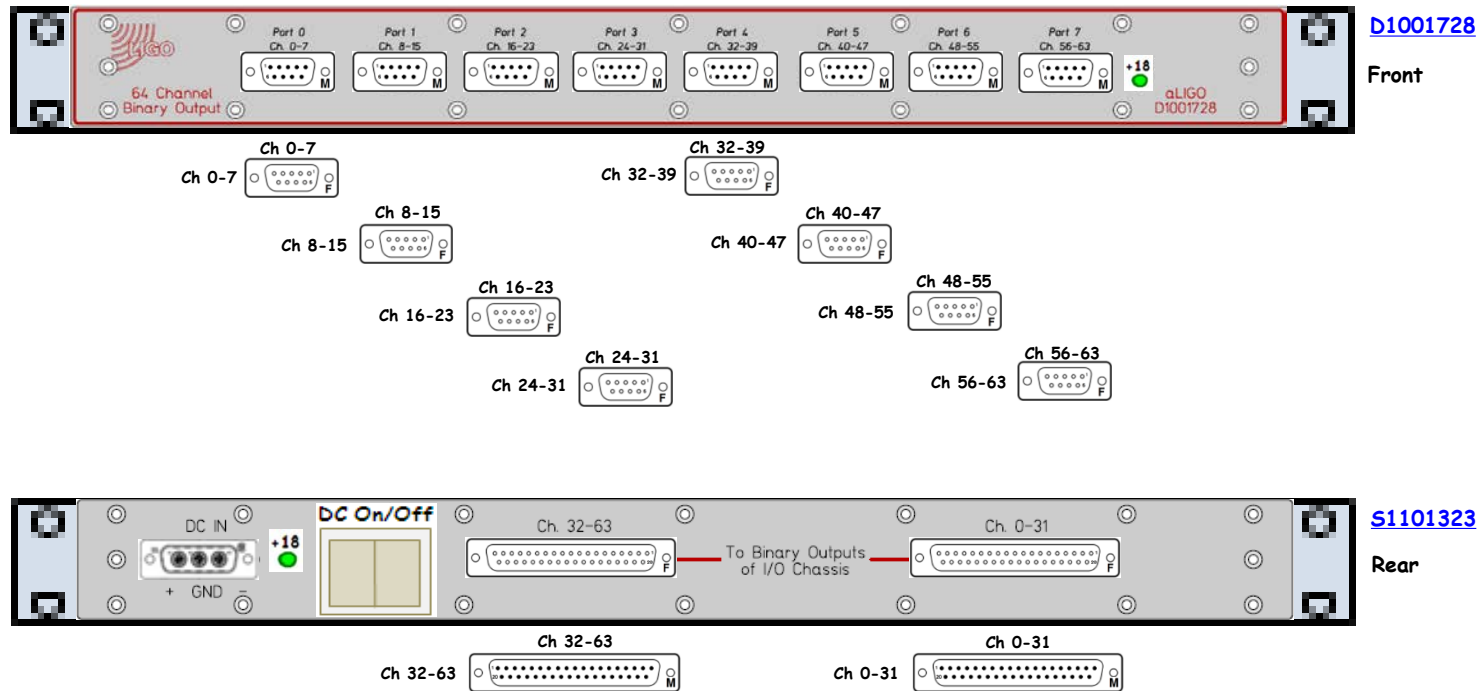

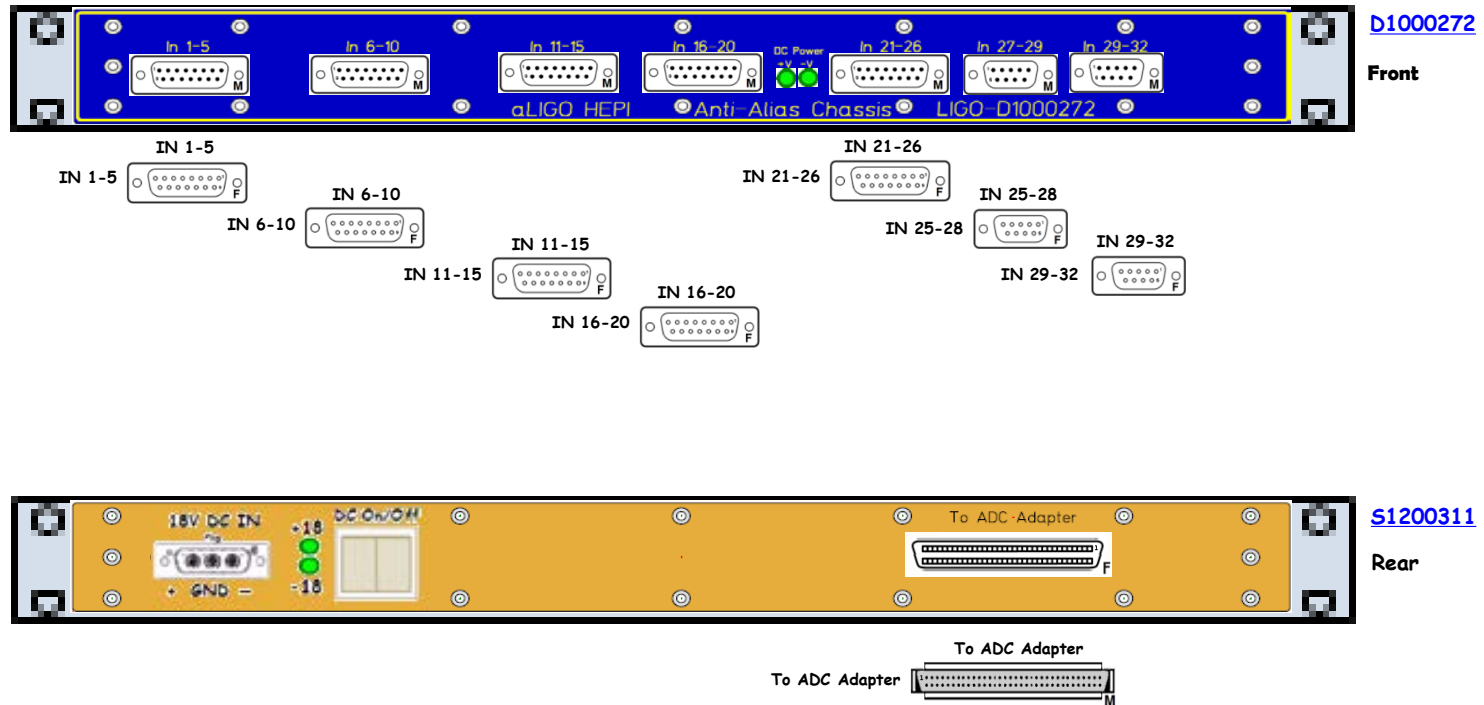

D0900117 - S0900272



<< L1-SEI-C3

HAM5 HEPI 8-Channel Valve Driver D0900117 S0900272 ±18VDC

HAM5

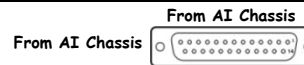
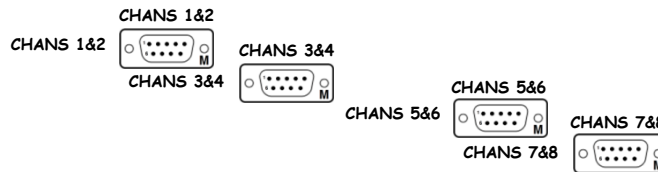
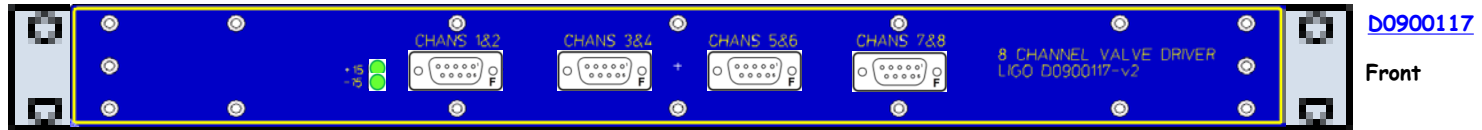

[D0900117](#) is part of [D0901338](#)

HAM5 HEPI Binary Input Chassis D1001726 S1101289 +18VDC

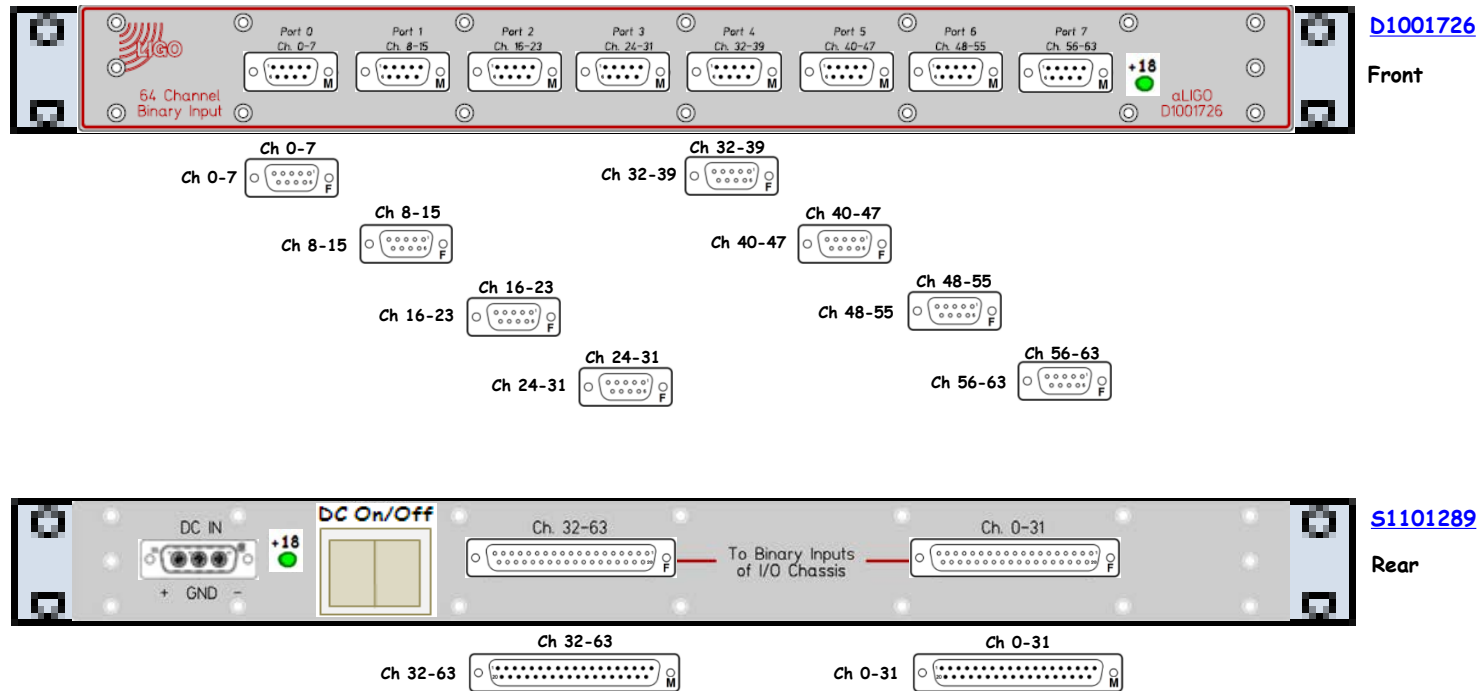



D1001715

Front

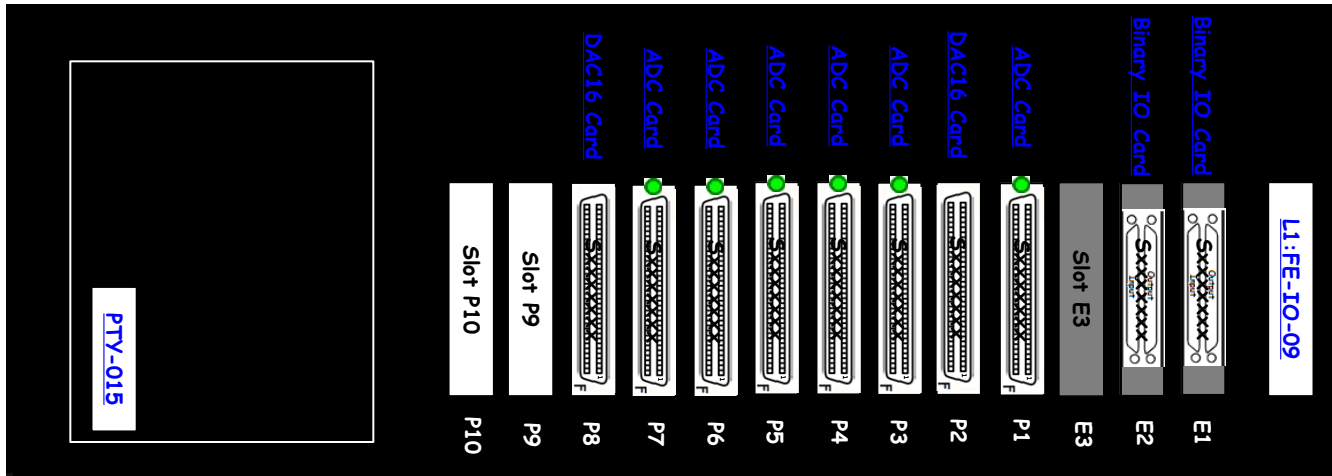

S1001146

Rear

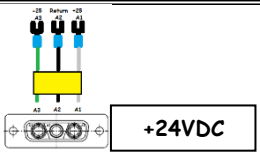
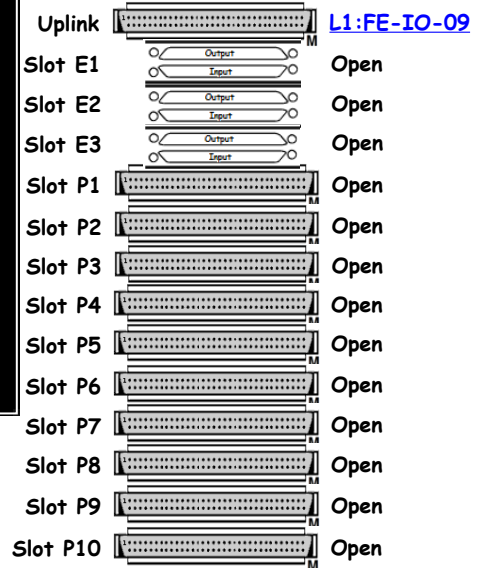

	42					
	41					
BSC1 ISI Interface Chassis Pod 1	D1002432	40	S1201326		$\pm 18\text{VDC}$	
BSC1 ISI Interface Chassis Pod 2	D1002432	39	S1201325		$\pm 18\text{VDC}$	
BSC1 ISI Interface Chassis Pod 3	D1002432	38	S1201329		$\pm 18\text{VDC}$	
	37					
	36					
BSC1 ISI Anti-Alias Chassis	D1002693	35	S1203001		$\pm 18\text{VDC}$	
BSC1 ISI Anti-Alias Chassis	D1002693	34	S1203000		$\pm 18\text{VDC}$	
	33					
BSC1 ISI Anti-Alias Chassis	D1002693	32	S1202999		$\pm 18\text{VDC}$	
	31					
BSC1 HEPI Anti-Alias Chassis	D1000272	30	S1200951		$\pm 18\text{VDC}$	
BSC1 HEPI Anti-Image Chassis	D1100202	29	S1203003		$\pm 18\text{VDC}$	
	28					
BSC1 HEPI 8-Channel Valve Driver	D0900117	27	S0900279		$\pm 18\text{VDC}$	
	26					
BSC1 HEPI Binary Input Chassis	D1001726	25	S1101295		+18VDC	
BSC1 HEPI Binary Input Chassis	D1001726	24	S1101296		+18VDC	
BSC1 HEPI Binary Output Chassis	D1001728	23	S1101327		+18VDC	
	22					
BSC1 T-240 Interface Chassis Pod 1	D1002694	21	S1201402		$\pm 18\text{VDC}$	
BSC1 T-240 Interface Chassis Pod 2	D1002694	20	S1201391		$\pm 18\text{VDC}$	
BSC1 T-240 Interface Chassis Pod 3	D1002694	19	S1201386		$\pm 18\text{VDC}$	
	18					
BSC1 STS-2 Distribution Chassis	D0900351	17	S0900137		$\pm 18\text{VDC}$	
BSC1 STS-2 Interface Chassis	D080535	16	S0900097		$\pm 18\text{VDC}$	
	15					
	14					
I1seibsc1 - I/O Extension Chassis	D1001715	12	S1001147		+24VDC	
	11					
	10					
BSC1 Anti-Image Chassis	D1000305	9	S1203007		$\pm 18\text{VDC}$	
	8					
BSC1 ISI Coil Driver Pod 1	D0902744	6	S1103328		$\pm 24\text{VDC}$	
BSC1 ISI Coil Driver Pod 2	D0902744	4	S1103322		$\pm 24\text{VDC}$	
BSC1 ISI Coil Driver Pod 3	D0902744	2	S1103311		$\pm 24\text{VDC}$	
	1					
		Front		Rear		

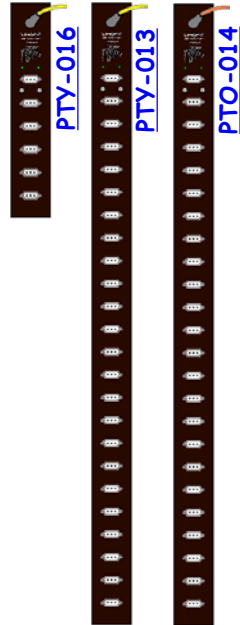

SEI-C4 is part of [D0901301](#)

L1-SEI-C4 Details

SEI-C4 is part of [D0901301](#)

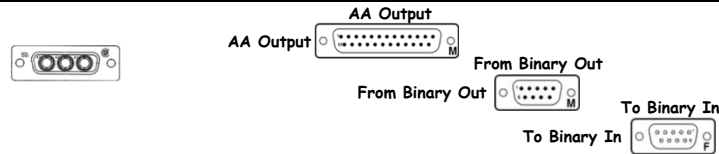
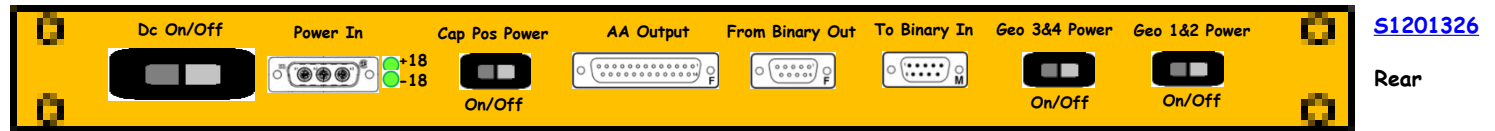
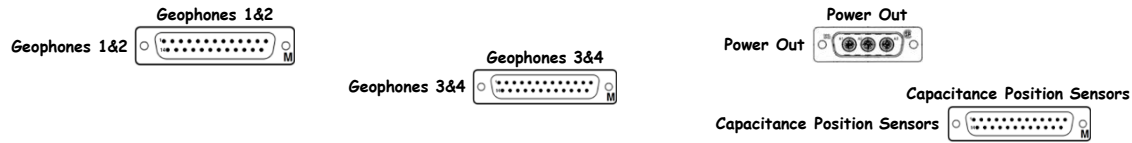

D1002432 - S1201325

BSC1 ISI Interface Chassis Pod 2 D1002432 S1201325 ±18VDC

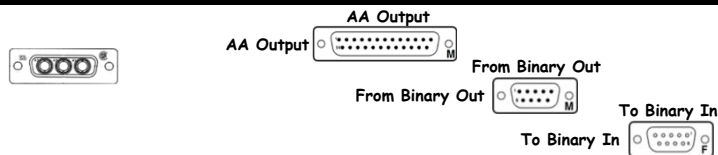
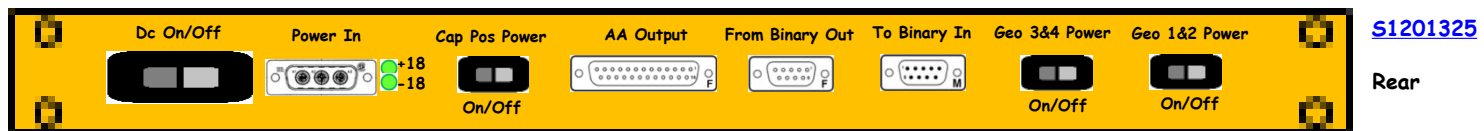
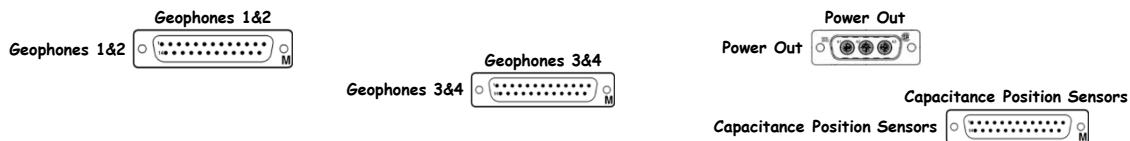
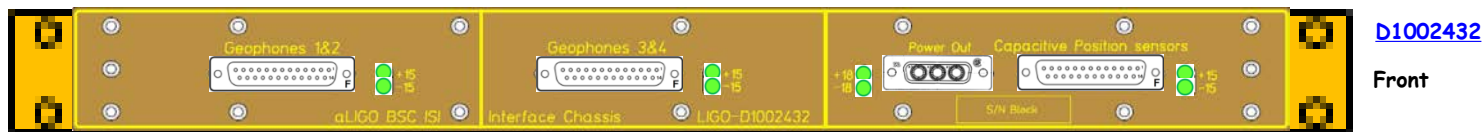

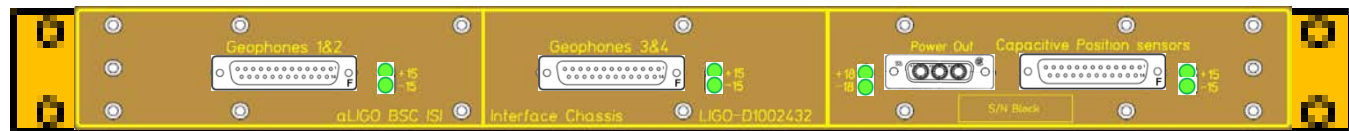

[D1002432](#)

Front

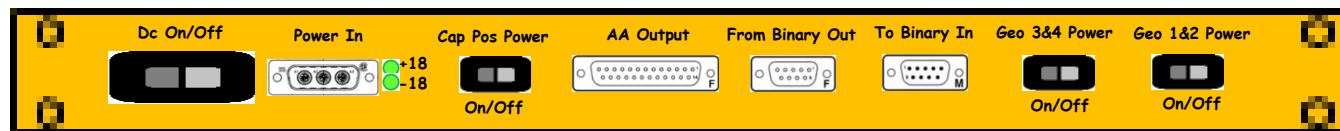
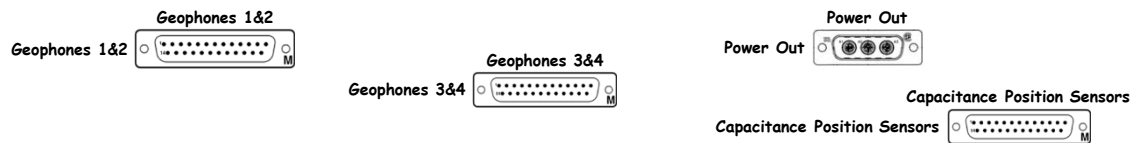

[S1201329](#)

Rear

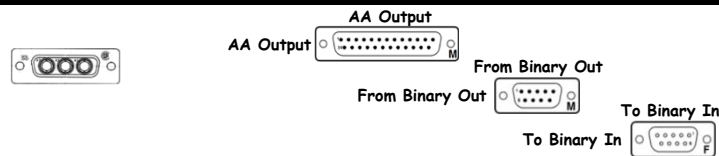

BSC1 ISI Anti-Alias Chassis D1002693 S1203001 ±18VDC

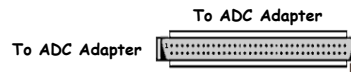
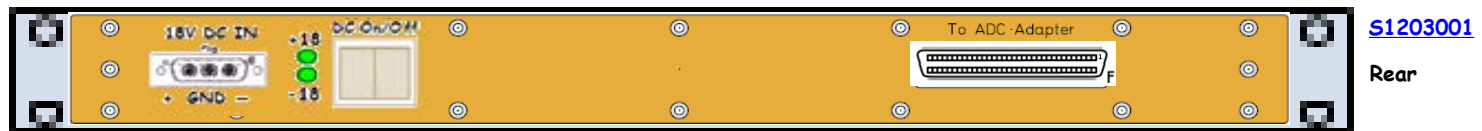
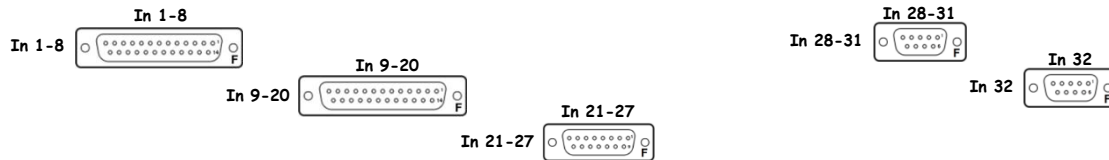
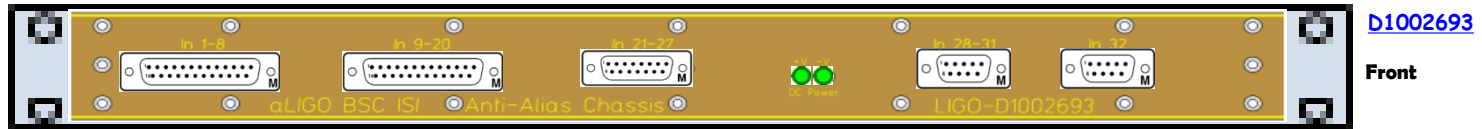

BSC1 ISI Anti-Alias Chassis D1002693 S1203000 ±18VDC

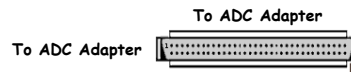
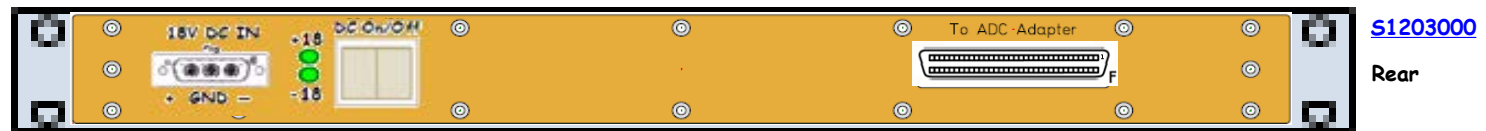
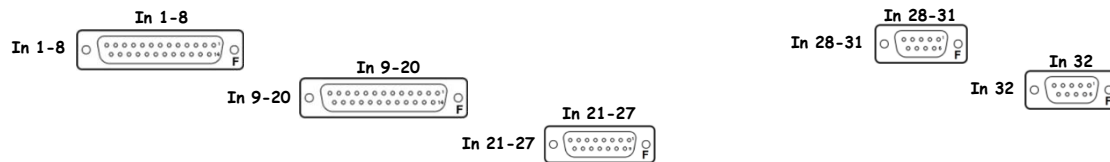
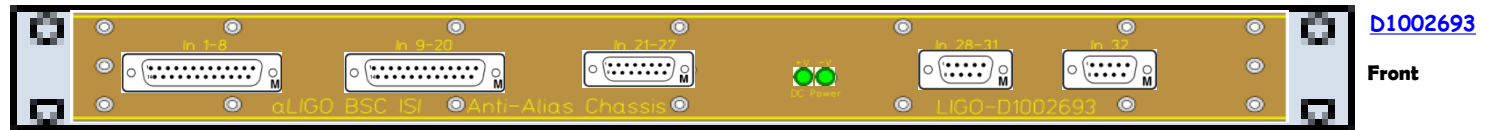

BSC1 ISI Anti-Alias Chassis D1002693 S1202999 ±18VDC

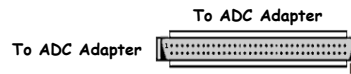
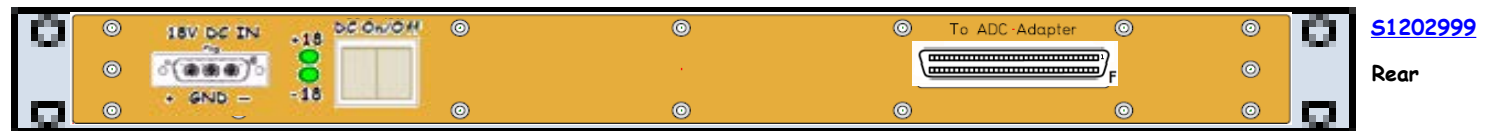
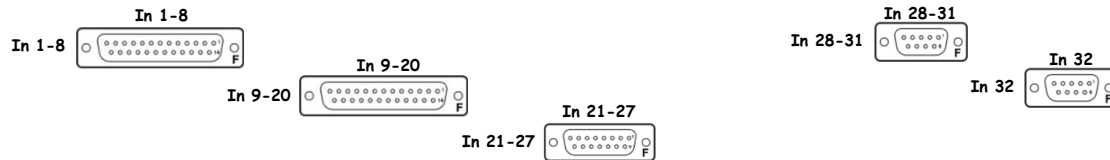
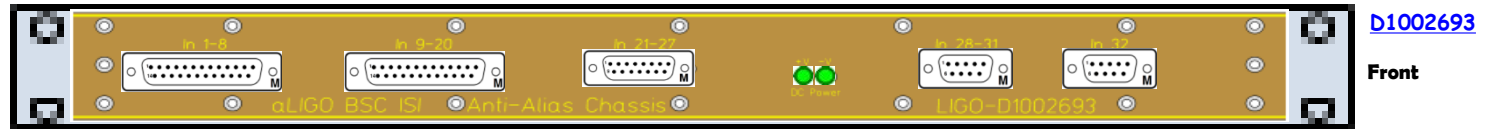

D1000272 - S1200951

BSC1 HEPI Anti-Alias Chassis D1000272 S1200951 ±18VDC

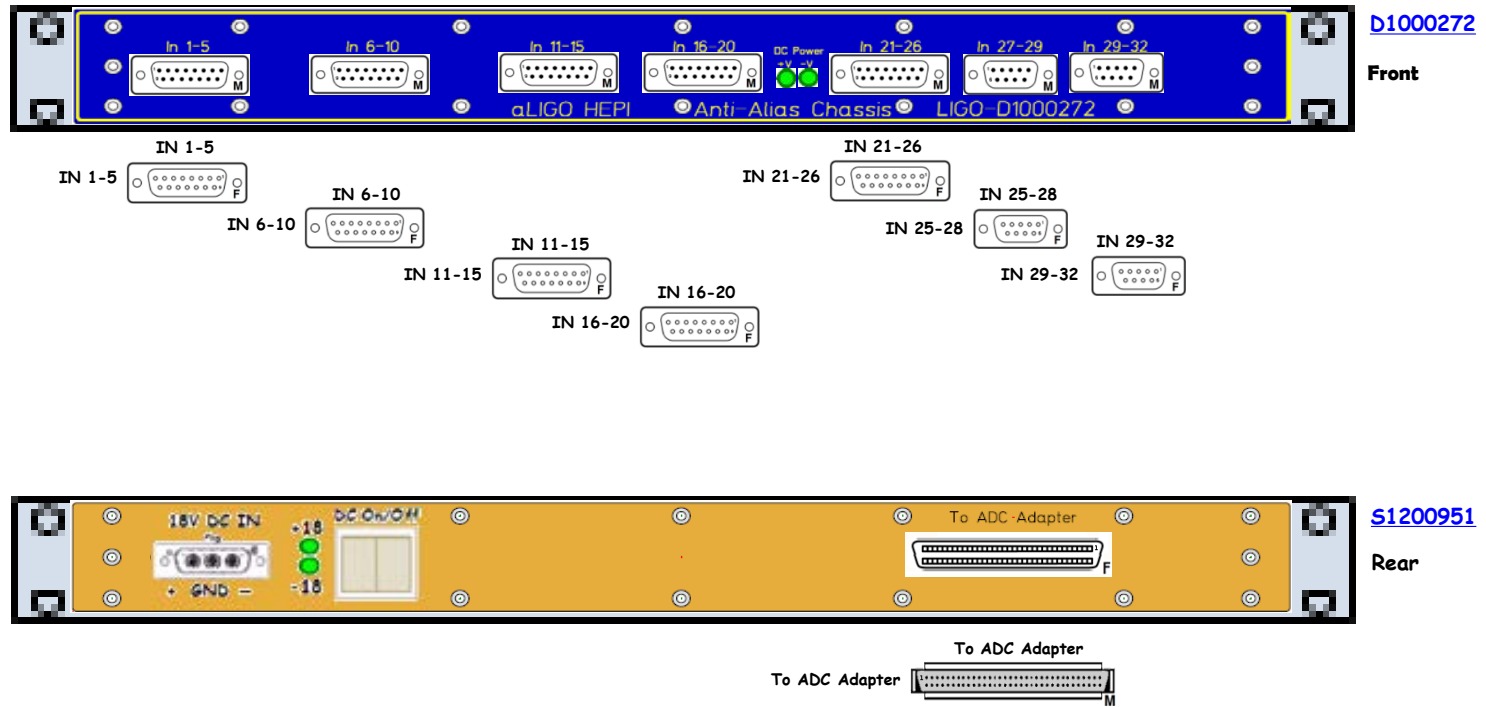

D1100202 - S1203003



<< L1-SEI-C4

BSC1 HEPI Anti-Image Chassis D1100202 S1203003 ±18VDC

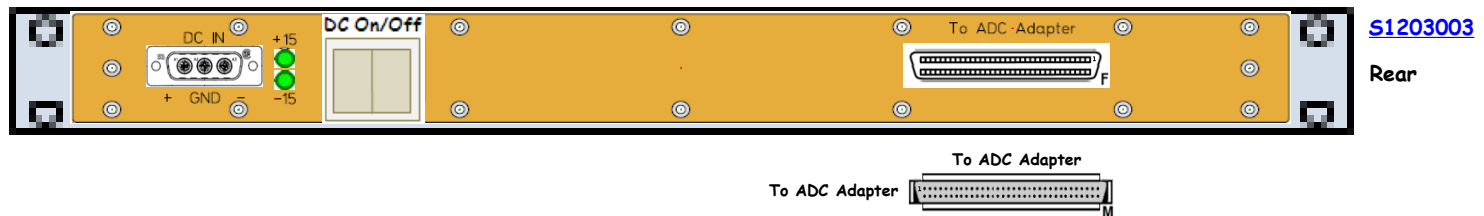
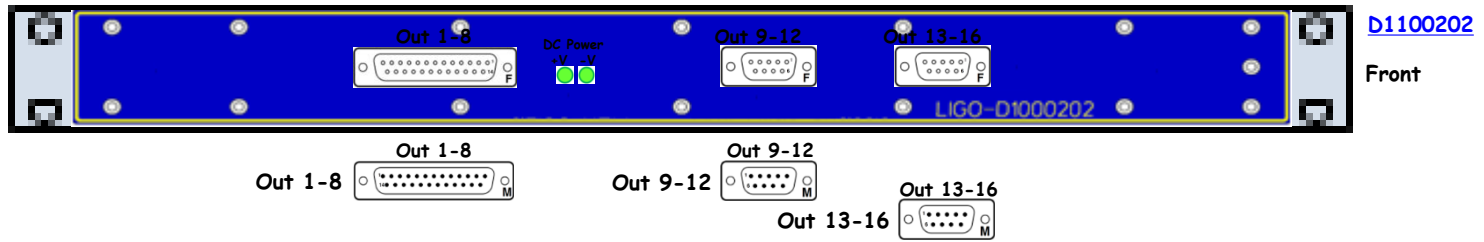

BSC1 HEPI 8-Channel Valve Driver D0900117 S0900279 ±18VDC

BSC1

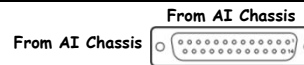
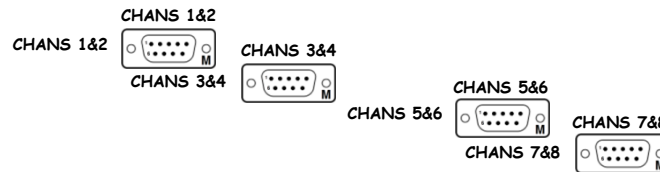
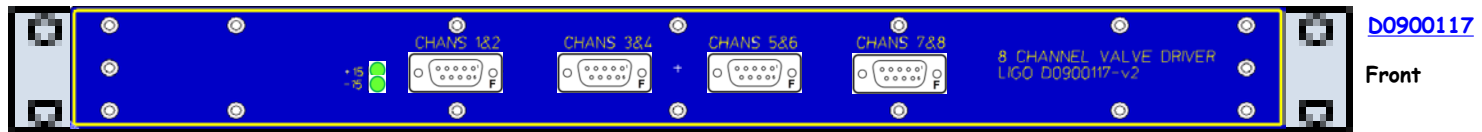

[D0900117](#) is part of [D0901338](#)

BSC1 HEPI Binary Input Chassis D1001726 S1101295 +18VDC

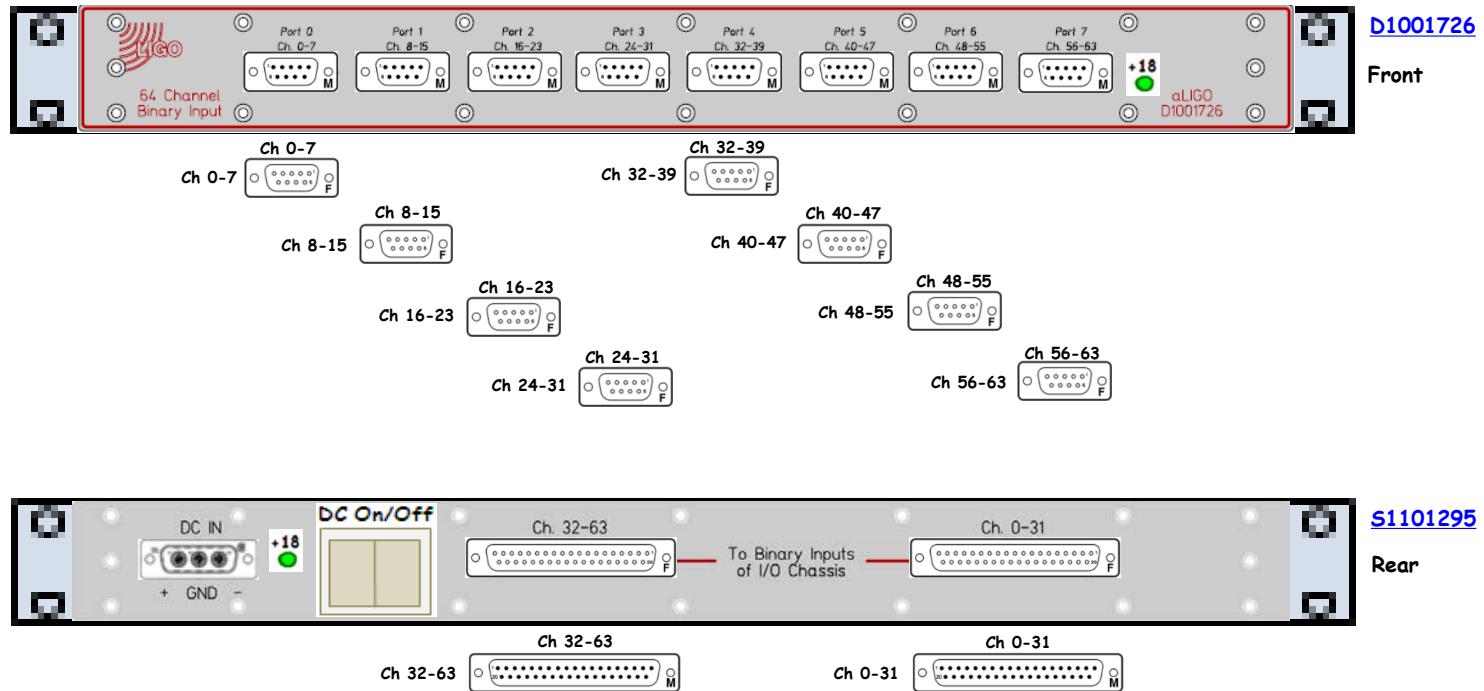

BSC1 HEPI Binary Input Chassis D1001726 S1101296 +18VDC

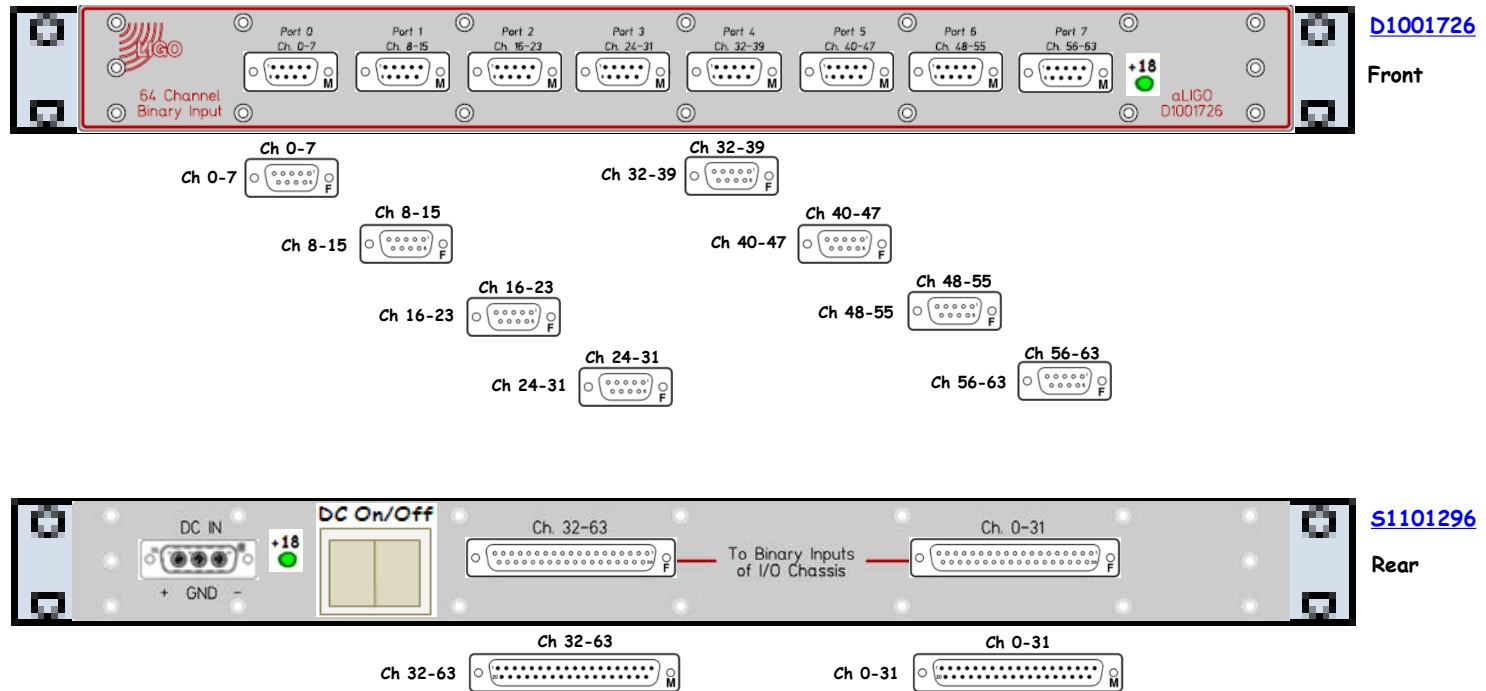

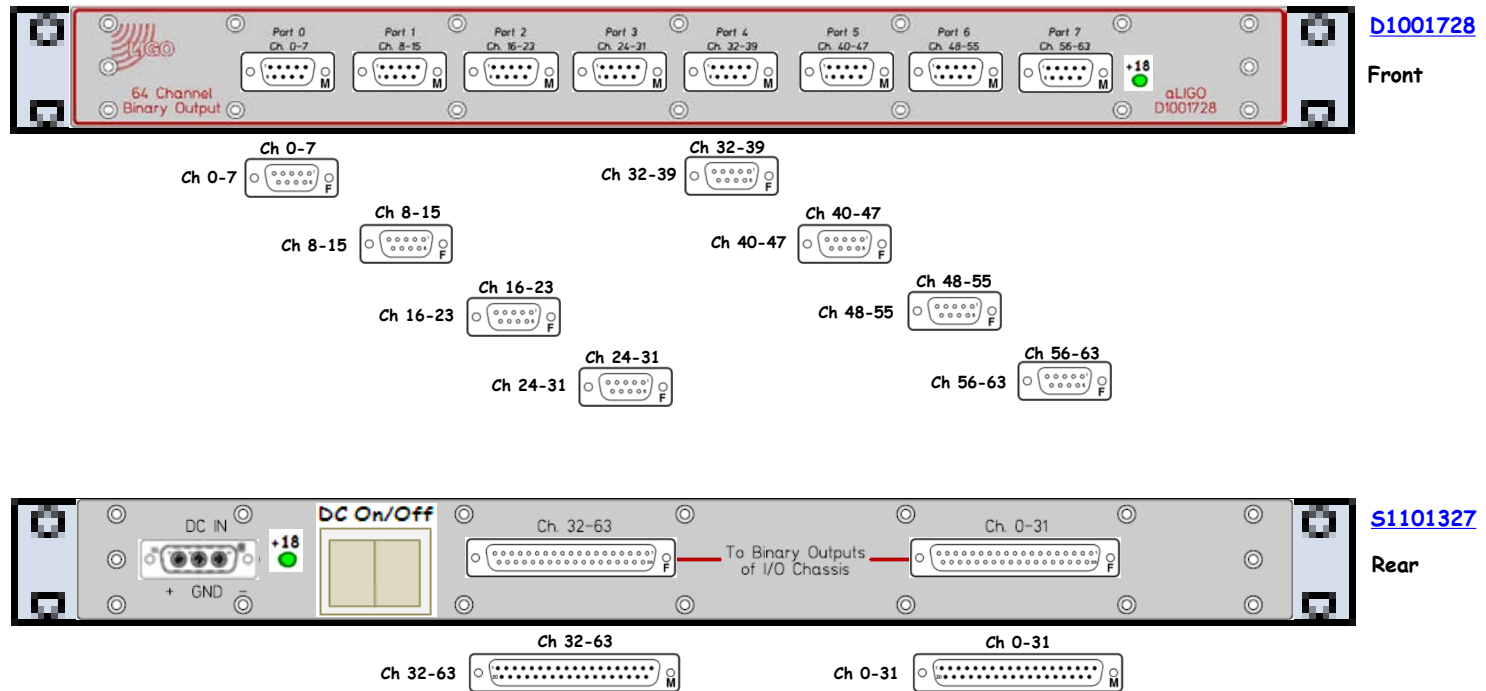

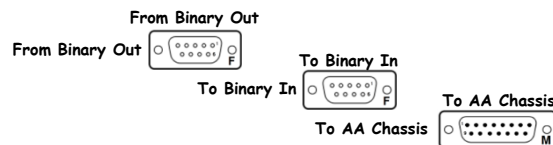

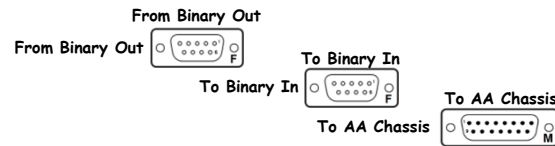
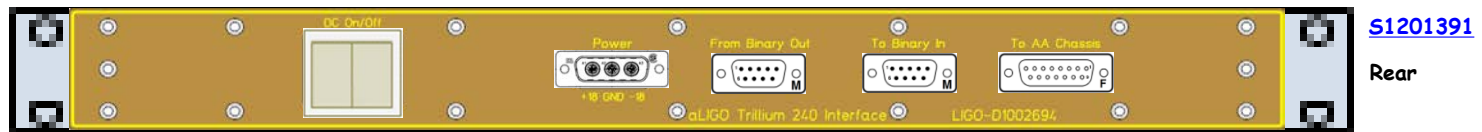

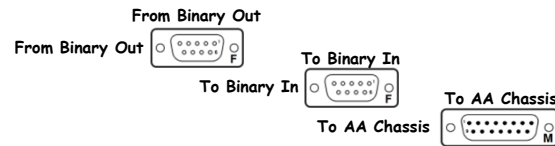
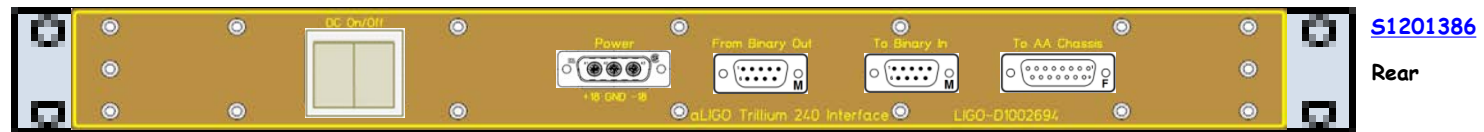

D0900351 - S0900137



<< L1-SEI-C4

BSC1 STS-2 Distribution Chassis D0900351 S0900137 ±18VDC

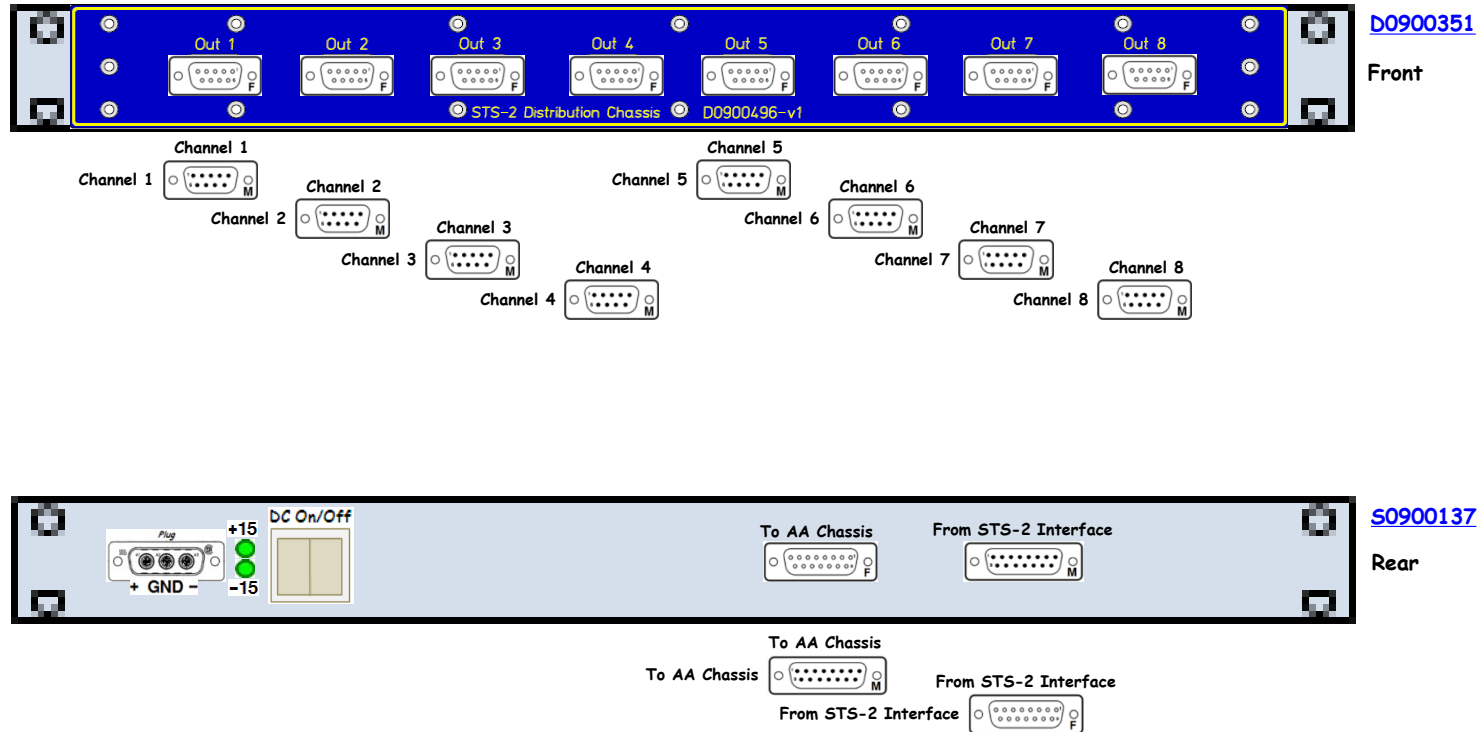

BSC1 STS-2 Interface Chassis

[D080535](#)

[S0900097](#)

±18VDC

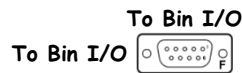
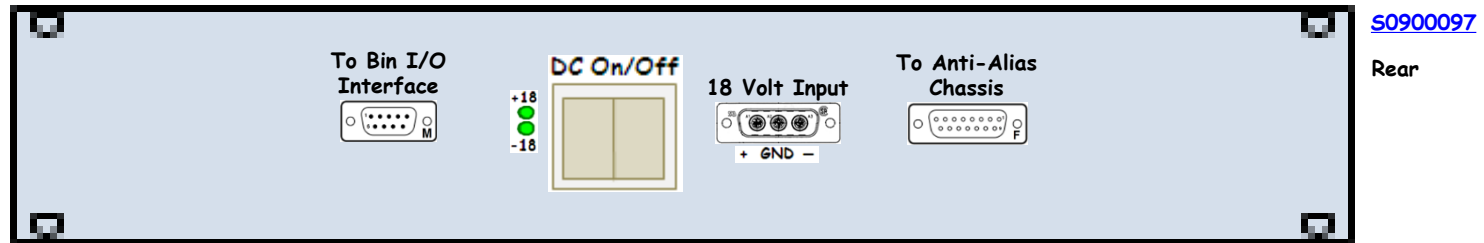
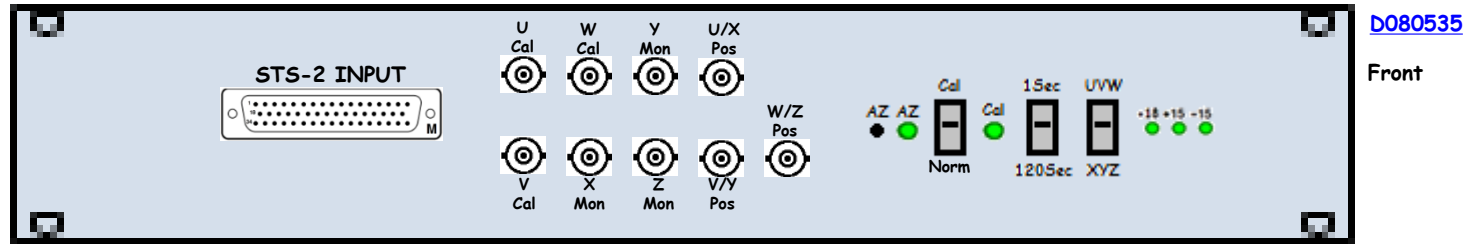



[D1001715](#)

Front

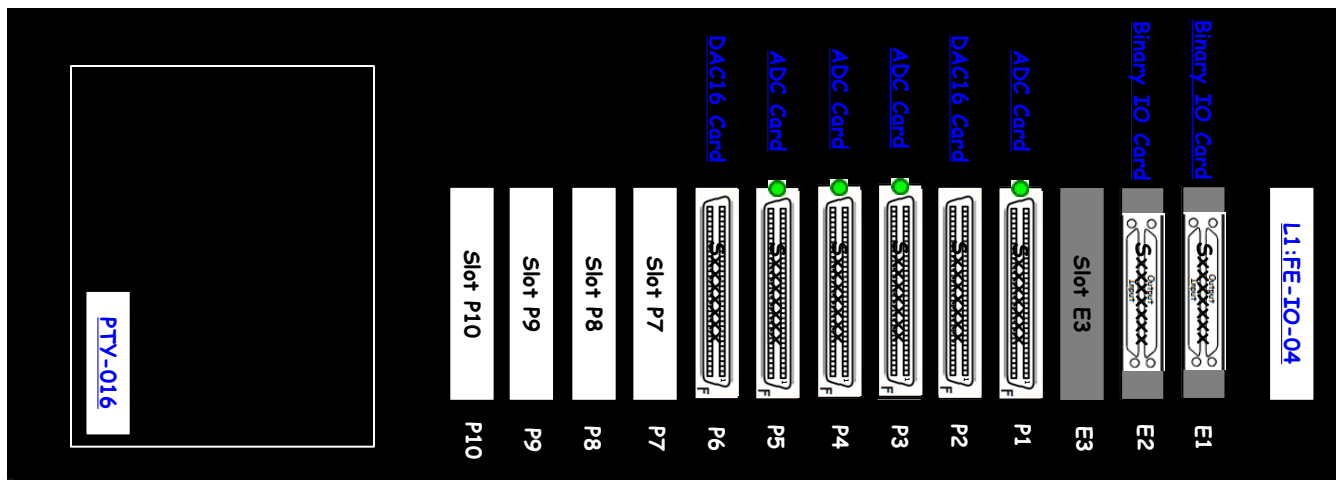

[S1001147](#)

Rear

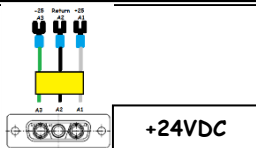
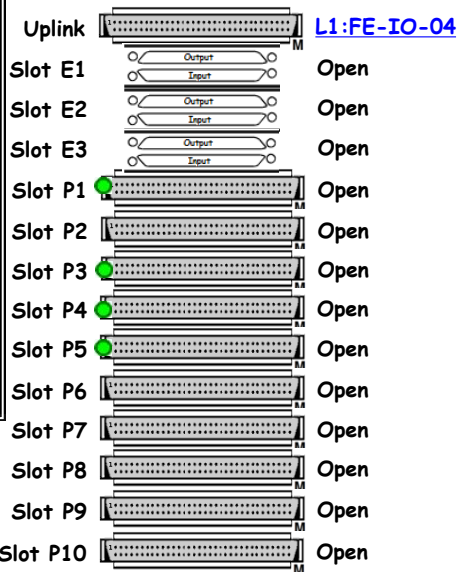

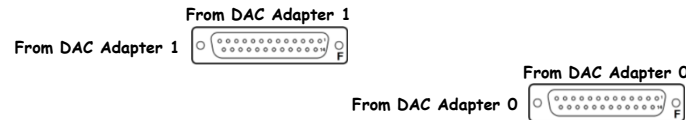
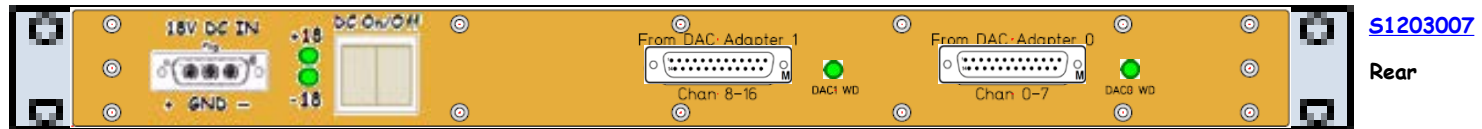
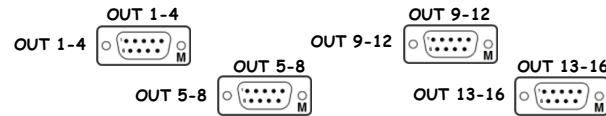
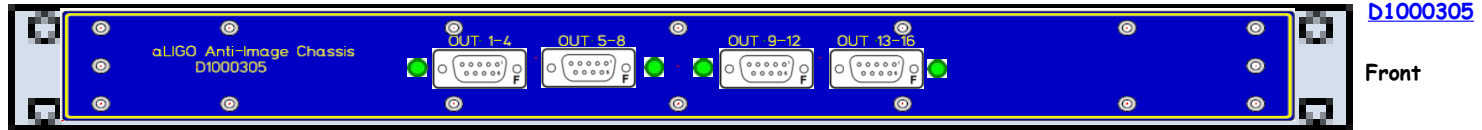

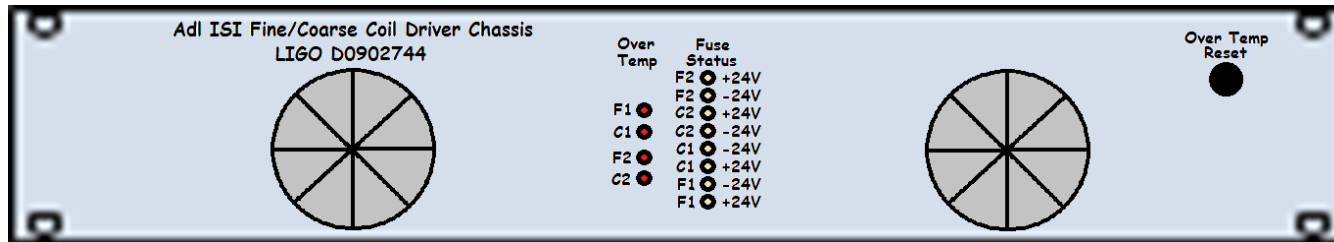

D0902744

Front

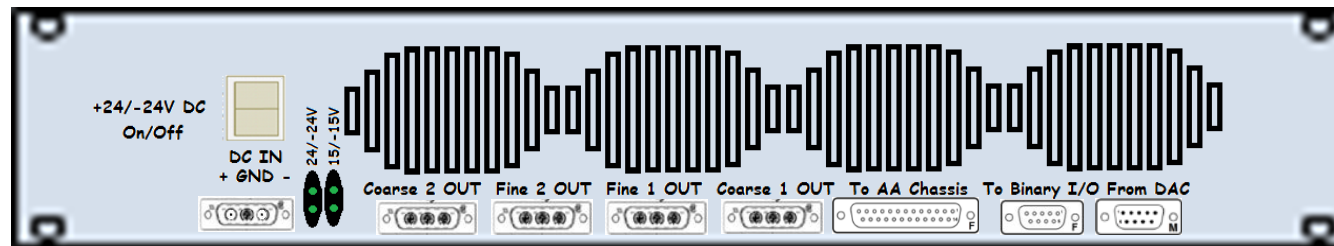

S1103328

Rear

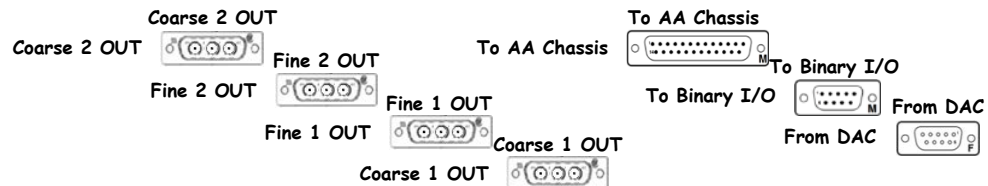

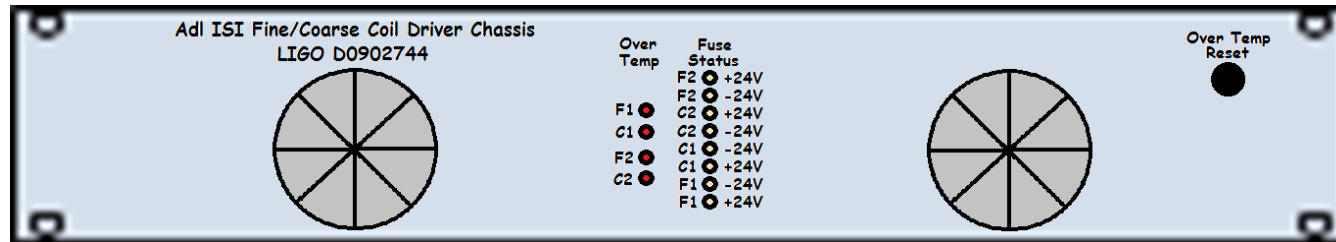

[D0902744](#)

Front

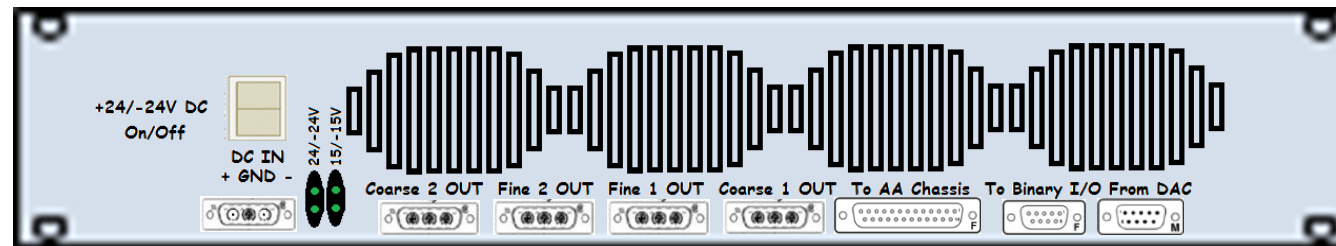

[S1103322](#)

Rear

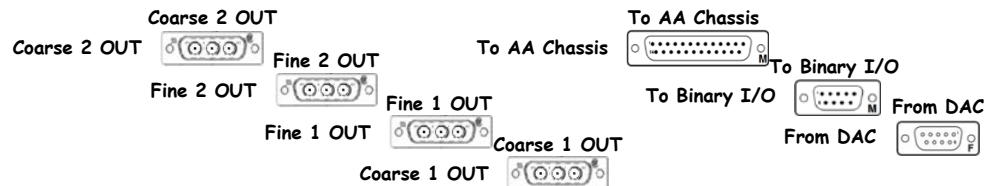

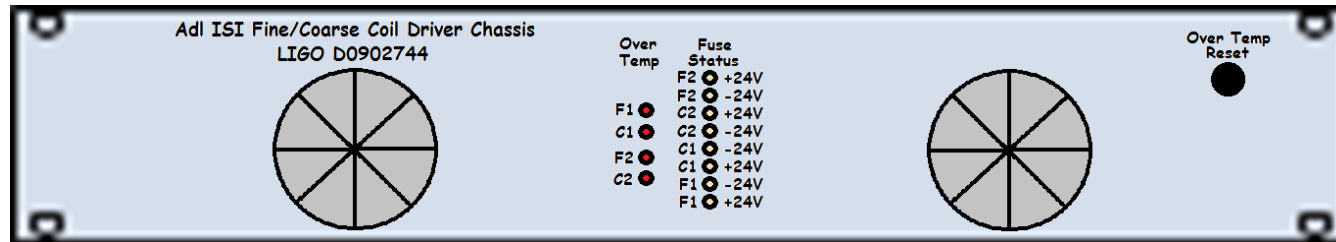

D0902744

Front

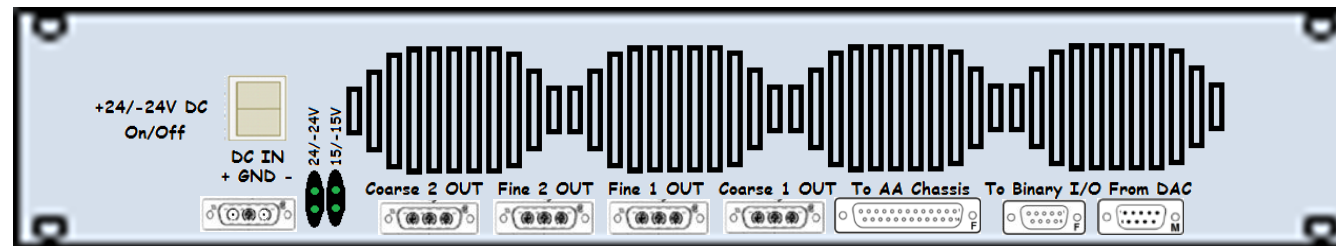

S1103311

Rear

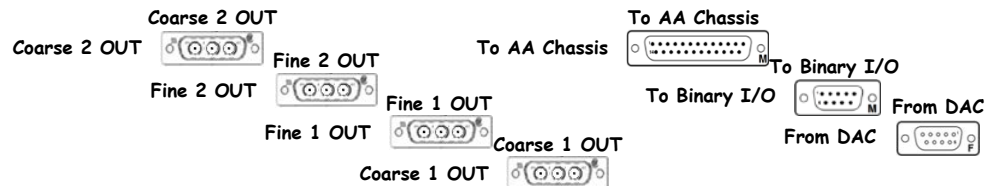

		42			
		41			
BSC2 ISI Interface Chassis Pod 1	D1002432	40	S1106357	$\pm 18\text{VDC}$	
BSC2 ISI Interface Chassis Pod 2	D1002432	39	S1200666	$\pm 18\text{VDC}$	
BSC2 ISI Interface Chassis Pod 3	D1002432	38	S1200665	$\pm 18\text{VDC}$	
		37			
		36			
BSC2 ISI Anti-Alias Chassis	D1002693	35	S1200947	$\pm 18\text{VDC}$	
BSC2 ISI Anti-Alias Chassis	D1002693	34	S1200946	$\pm 18\text{VDC}$	
		33			
BSC2 ISI Anti-Alias Chassis	D1002693	32	S1200948	$\pm 18\text{VDC}$	
		31			
BSC2 HEPI Anti-Alias Chassis	D1000272	30	S1200312	$\pm 18\text{VDC}$	
BSC2 HEPI Anti-Image Chassis	D1100202	29	S1200953	$\pm 18\text{VDC}$	
		28			
BSC2 HEPI 8-Channel Valve Driver	D0900117	27	S0900285	$\pm 18\text{VDC}$	
		26			
BSC2 HEPI Binary Input Chassis	D1001726	25	S1101291	+18VDC	
BSC2 HEPI Binary Input Chassis	D1001726	24	S1101292	+18VDC	
BSC2 HEPI Binary Output Chassis	D1001728	23	S1101325	+18VDC	
		22			
BSC2 T-240 Interface Chassis Pod 1	D1002694	21	S1104427	$\pm 18\text{VDC}$	
BSC2 T-240 Interface Chassis Pod 2	D1002694	20	S1104425	$\pm 18\text{VDC}$	
BSC2 T-240 Interface Chassis Pod 3	D1002694	19	S1104421	$\pm 18\text{VDC}$	
		18			
BSC2 STS-2 Distribution Chassis	D0900351	17	S0900132	$\pm 18\text{VDC}$	
BSC2 STS-2 Interface Chassis	D080535	16	S0900094	$\pm 18\text{VDC}$	
		15			
		14			
I1seibsc2 - I/O Extension Chassis	D1001715	12	S1001148	+24VDC	
		11			
		10			
BSC2 Anti-Image Chassis	D1000305	9	S1200955	$\pm 18\text{VDC}$	
		8			
BSC2 ISI Coil Driver Pod 1	D0902744	6	S1103305	$\pm 24\text{VDC}$	
BSC2 ISI Coil Driver Pod 2	D0902744	4	S1103337	$\pm 24\text{VDC}$	
BSC2 ISI Coil Driver Pod 3	D0902744	2	S1103353	$\pm 24\text{VDC}$	
		1			
	Front		Rear		

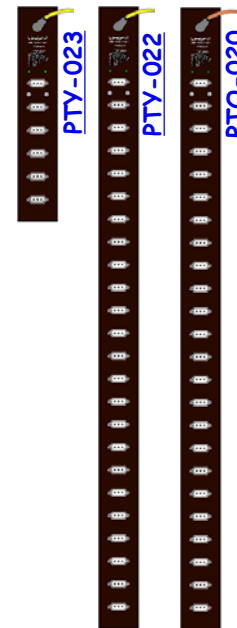

SEI-C5 is part of [D0901301](#)

L1-SEI-C5 Details

SEI-C5 is part of [D0901301](#)

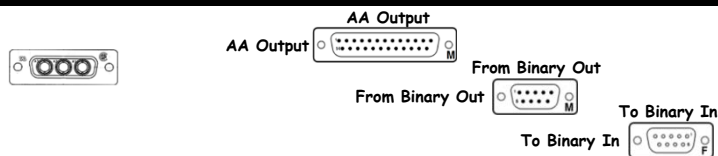
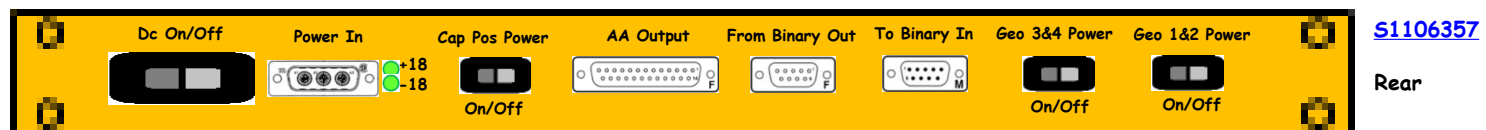
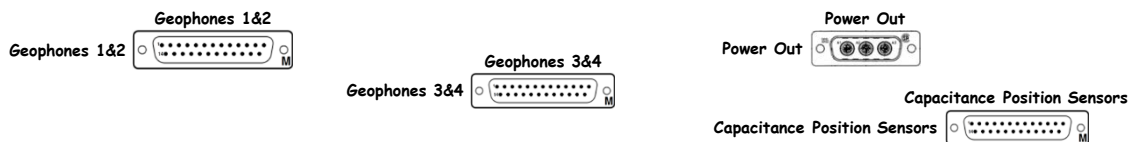

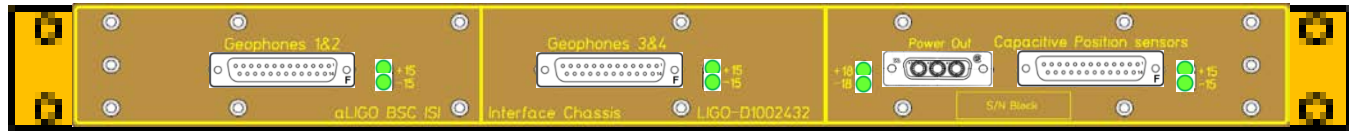

[D1002432](#)

Front

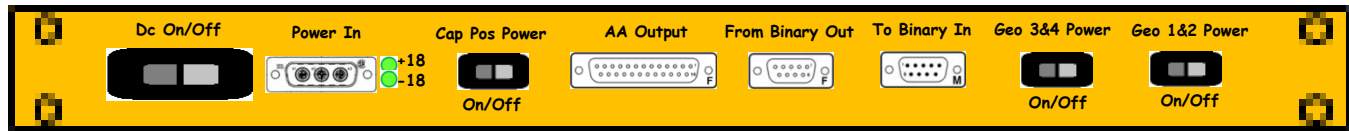
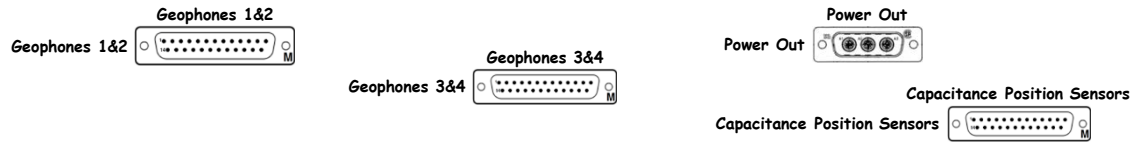

[S1200666](#)

Rear

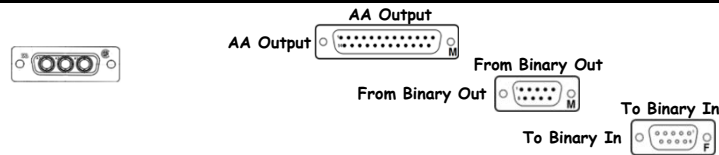

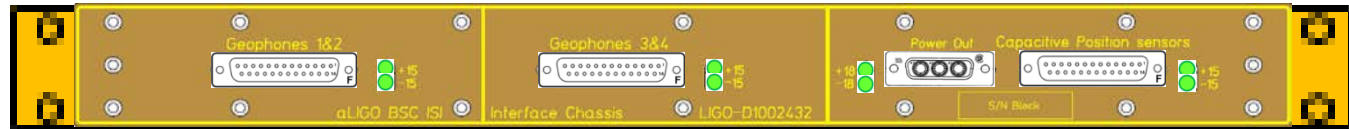

[D1002432](#)

Front

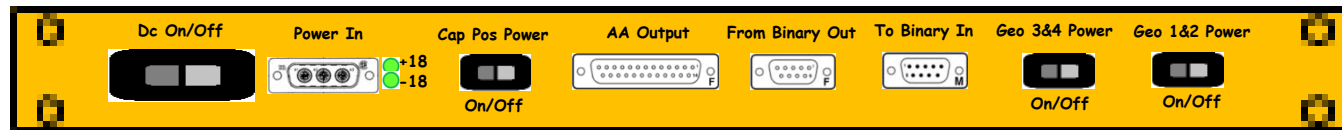
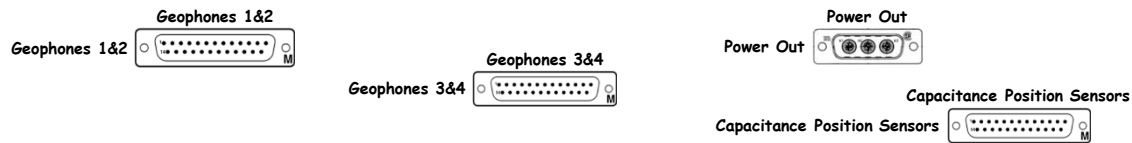

[S1200665](#)

Rear

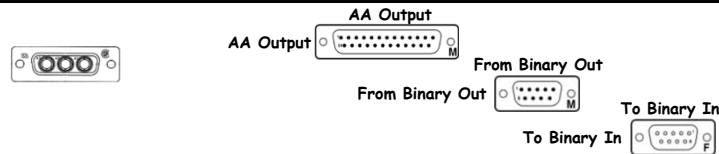

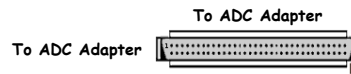
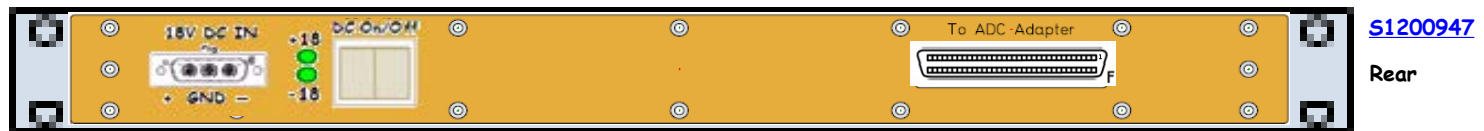
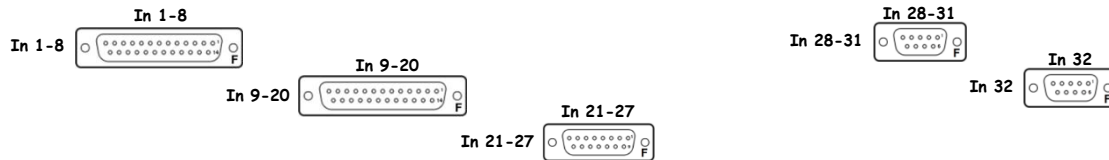
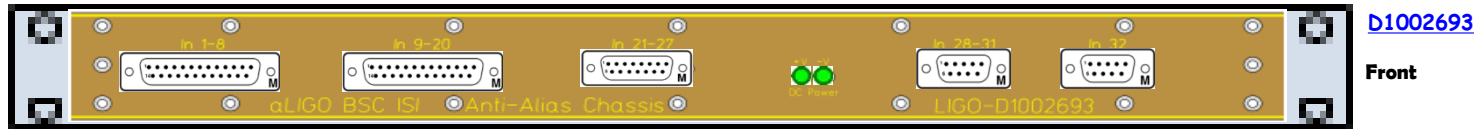

BSC2 ISI Anti-Alias Chassis D1002693 S1200946 ±18VDC

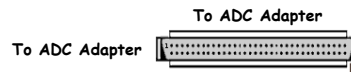
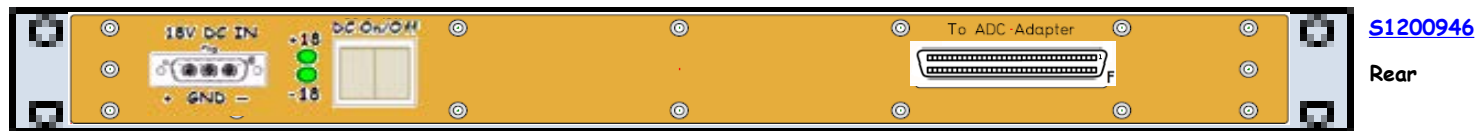
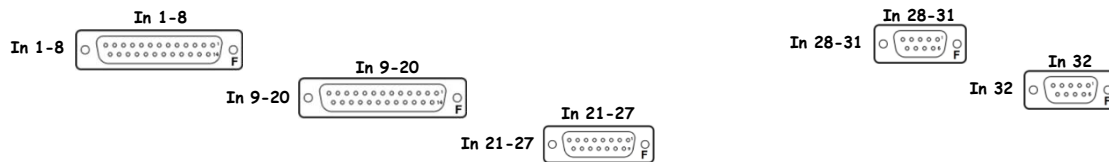
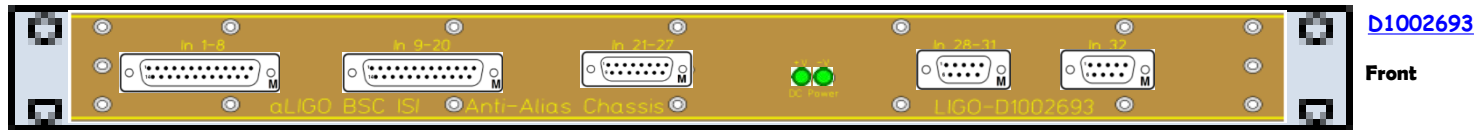

BSC2 ISI Anti-Alias Chassis D1002693 S1200948 ±18VDC

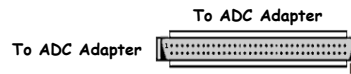
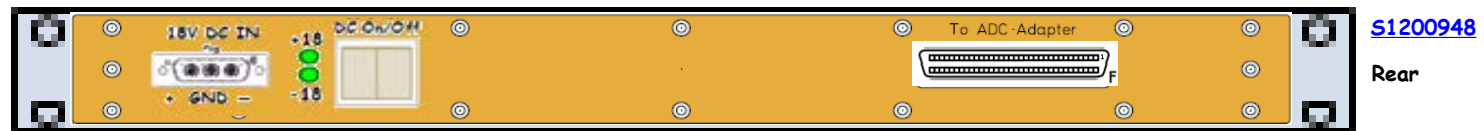
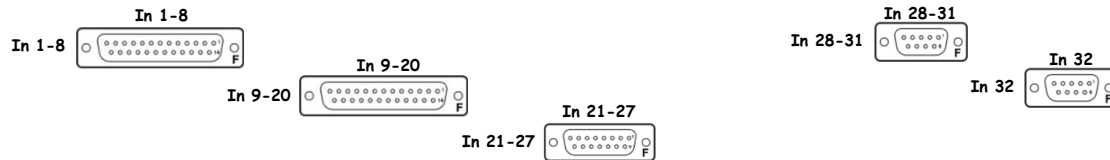
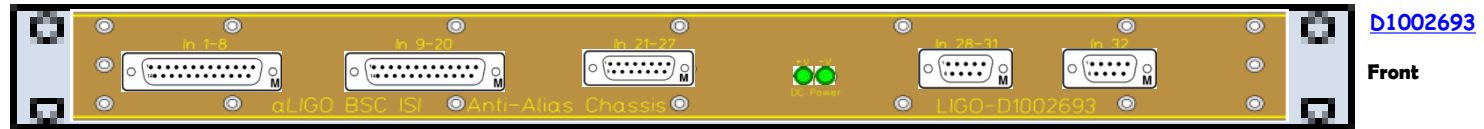

D1000272 - S1200312



<< L1-SEI-C5

BSC2 HEPI Anti-Alias Chassis D1000272 S1200312 ±18VDC

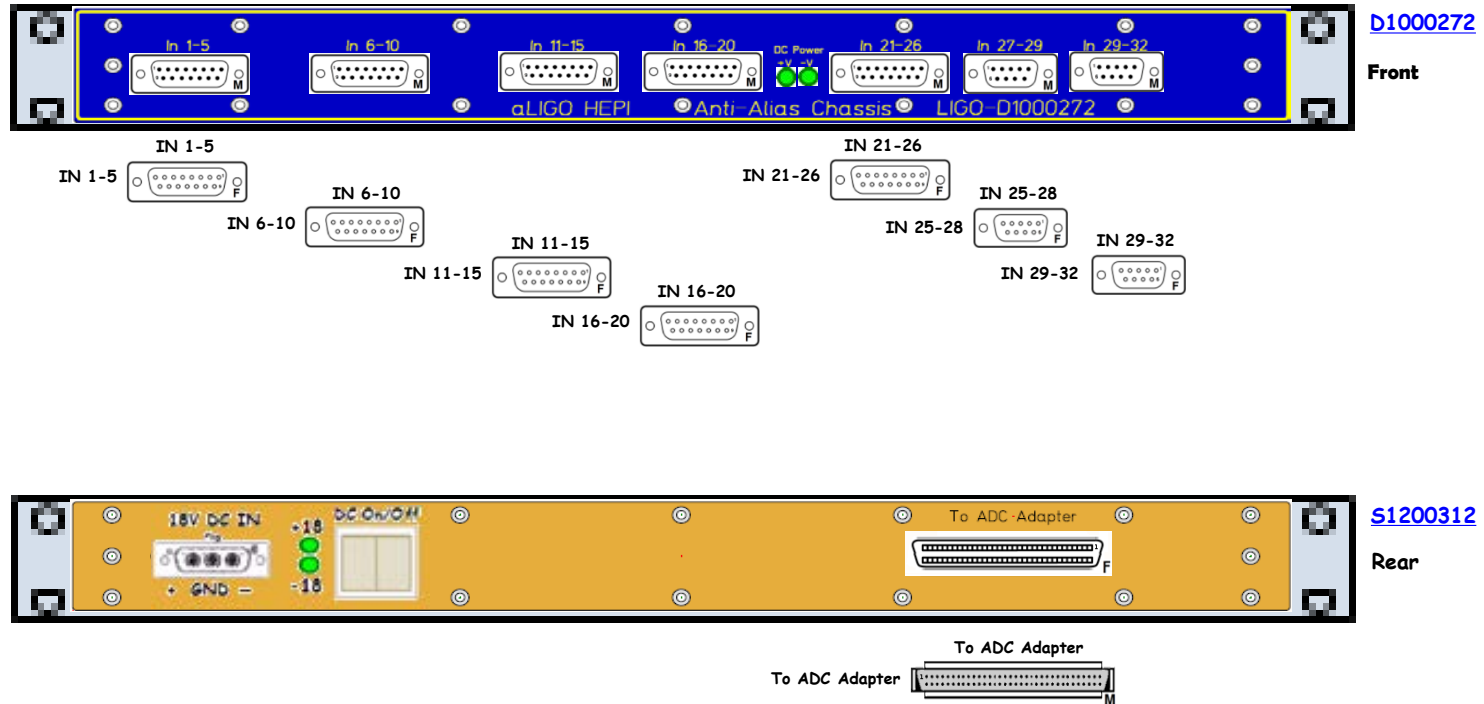

D1100202 - S1200953



<< L1-SEI-C5

BSC2 HEPI Anti-Image Chassis D1100202 S1200953 ±18VDC

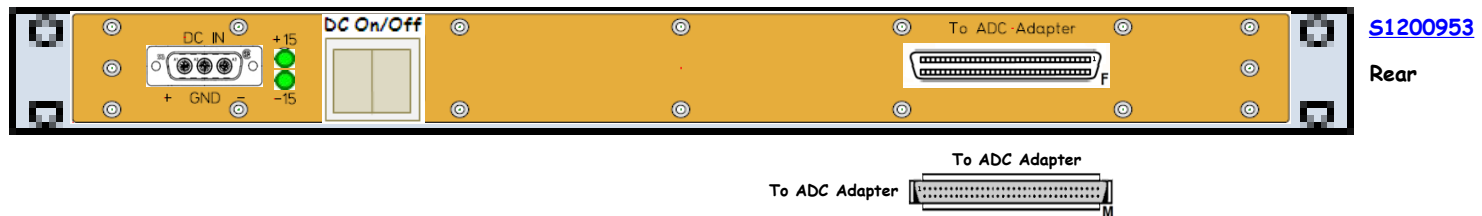
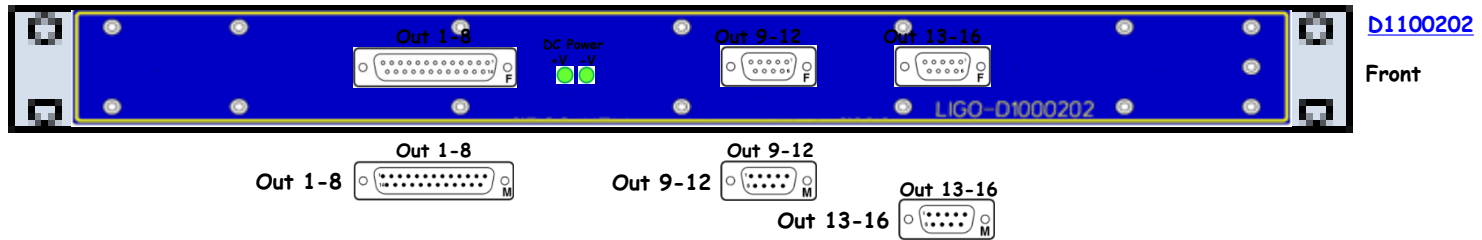

BSC2 HEPI 8-Channel Valve Driver D0900117 S0900285 ±18VDC

BSC2

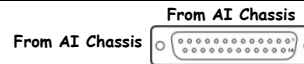
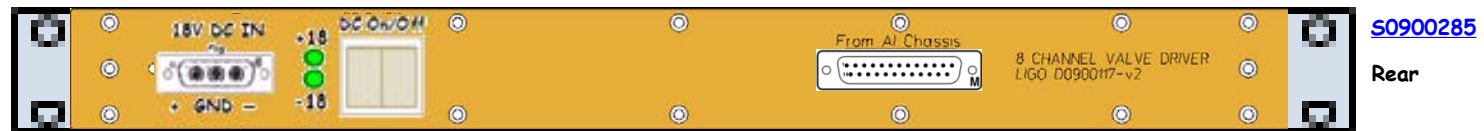
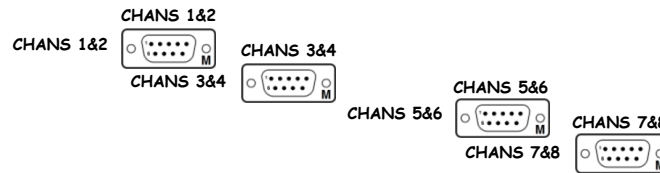
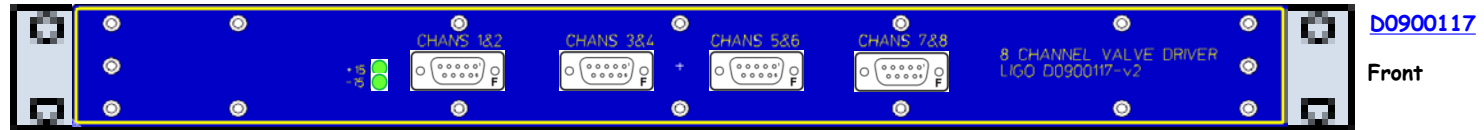

[D0900117](#) is part of [D0901338](#)

BSC2 HEPI Binary Input Chassis D1001726 S1101291 +18VDC

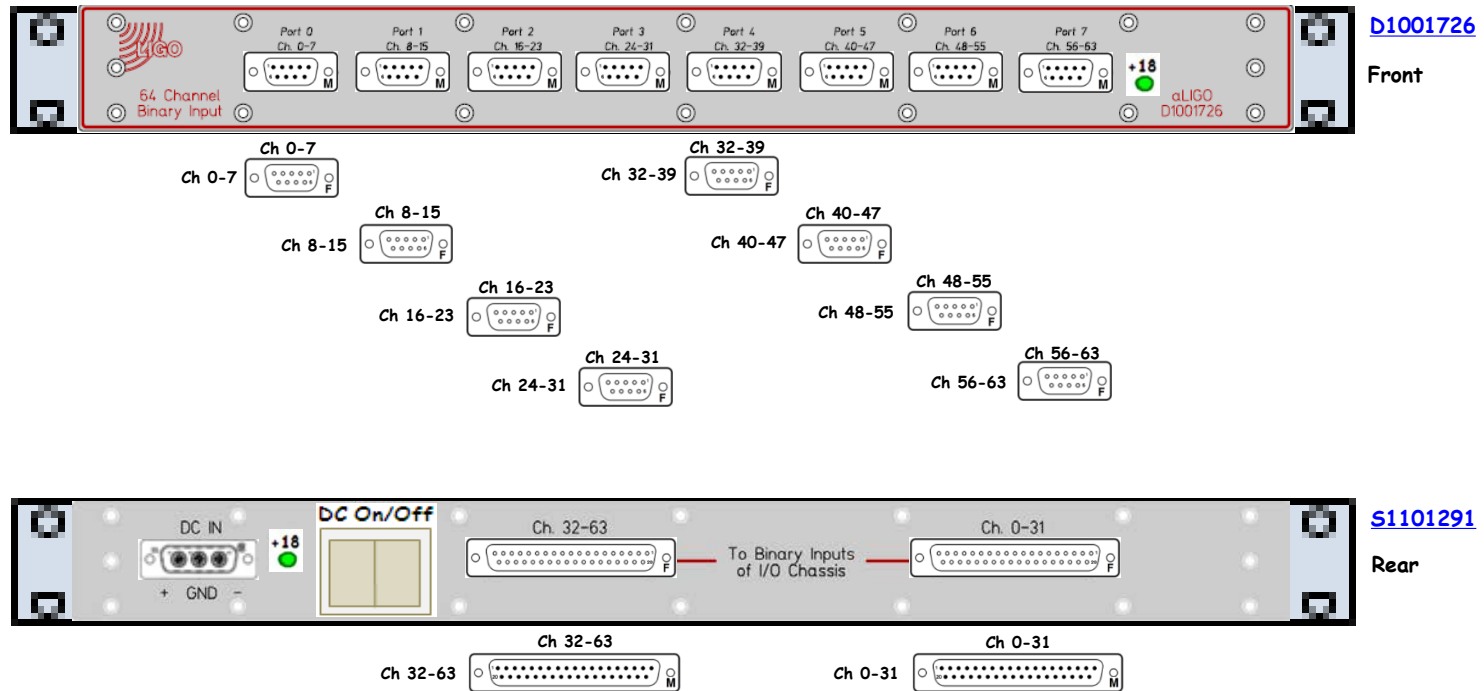

BSC2 HEPI Binary Input Chassis D1001726 S1101292 +18VDC

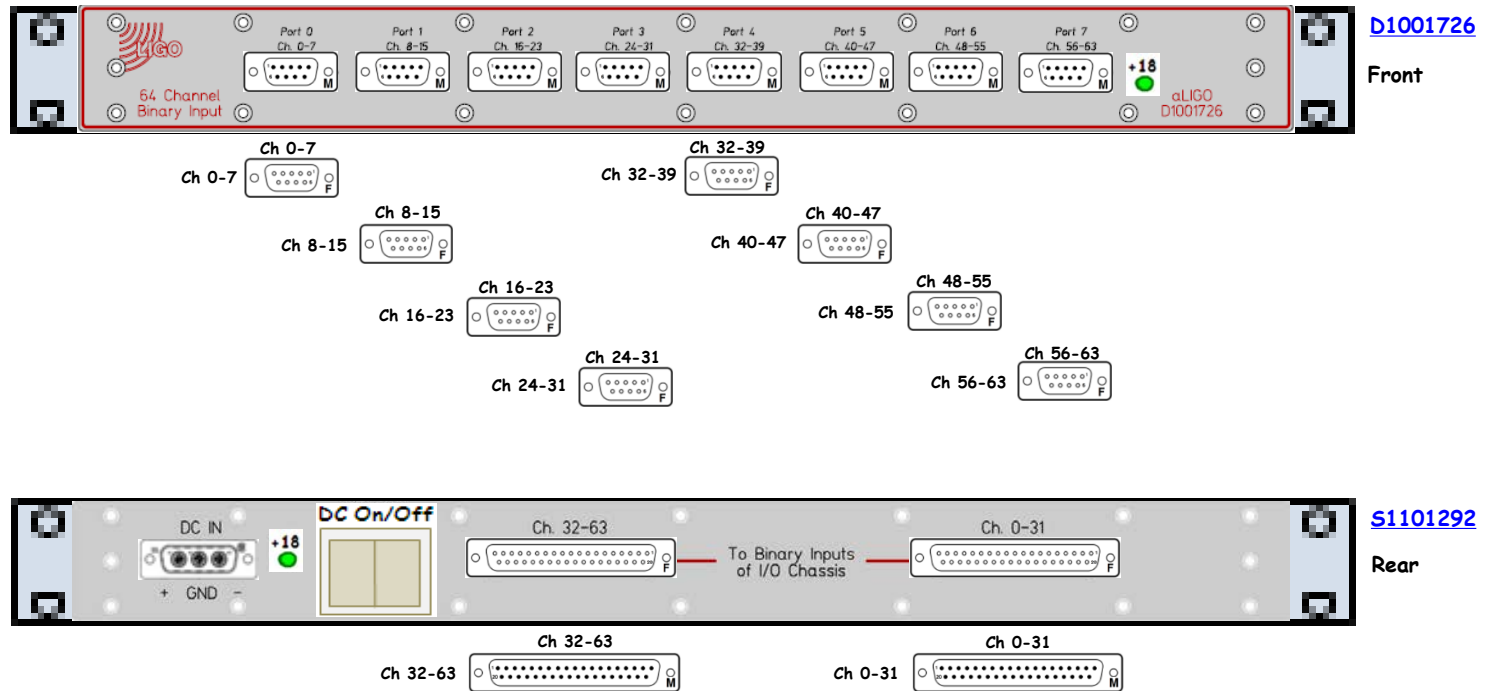

BSC2 HEPI Binary Output Chassis D1001728 S1101325 +18VDC

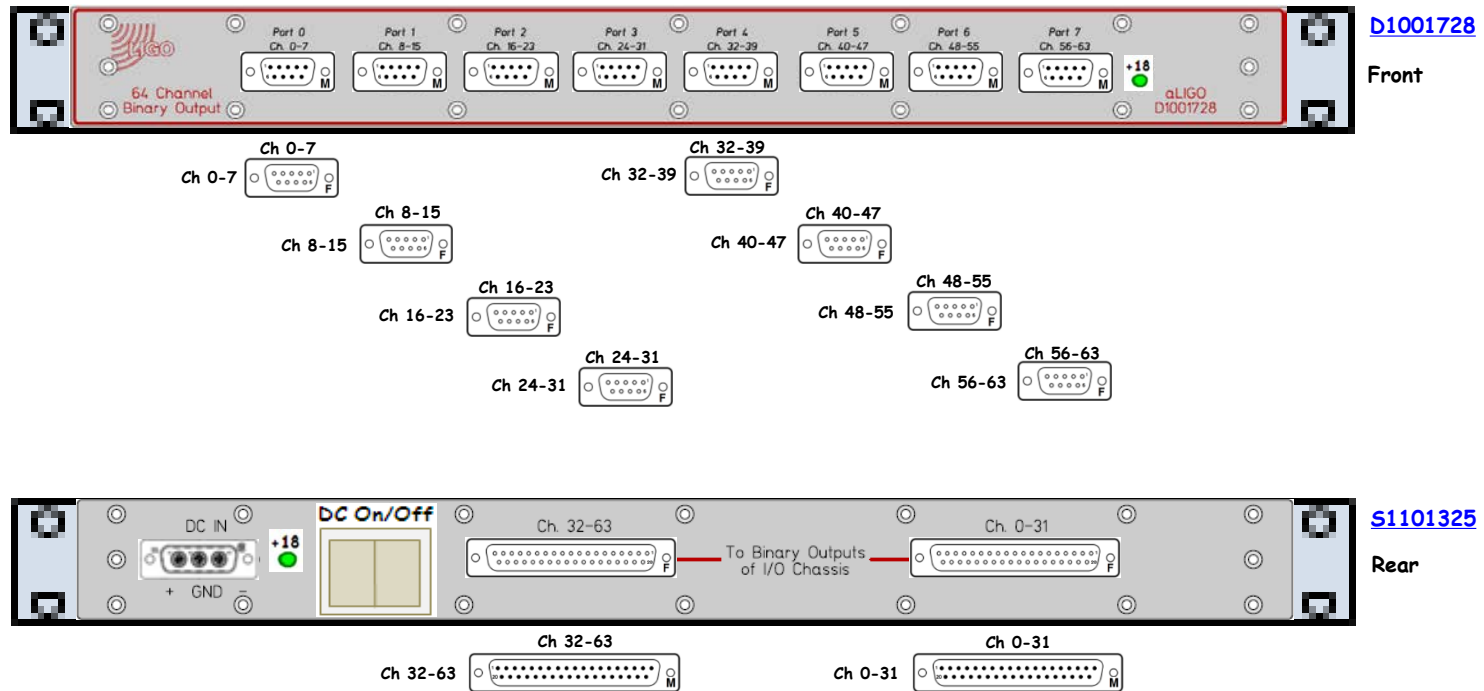

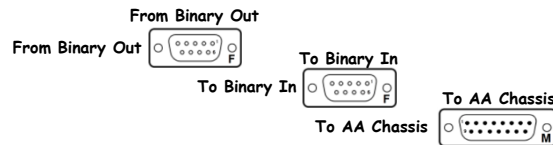
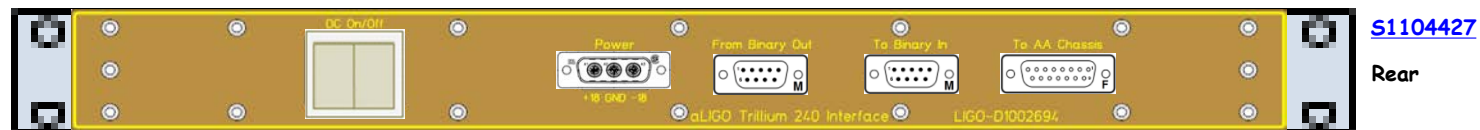
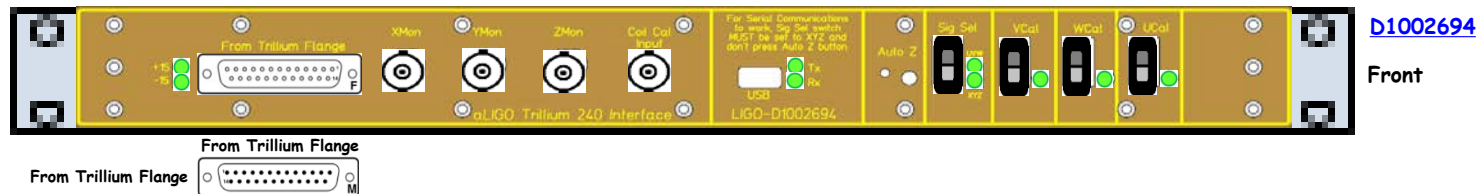

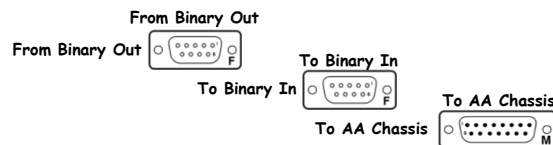
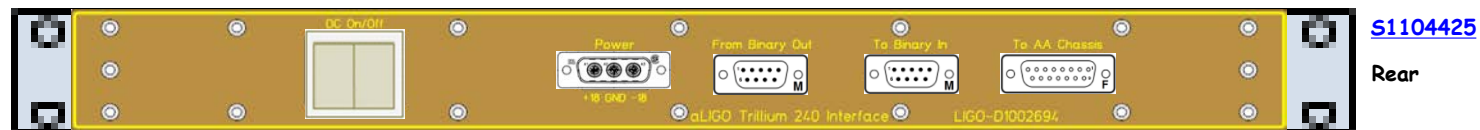
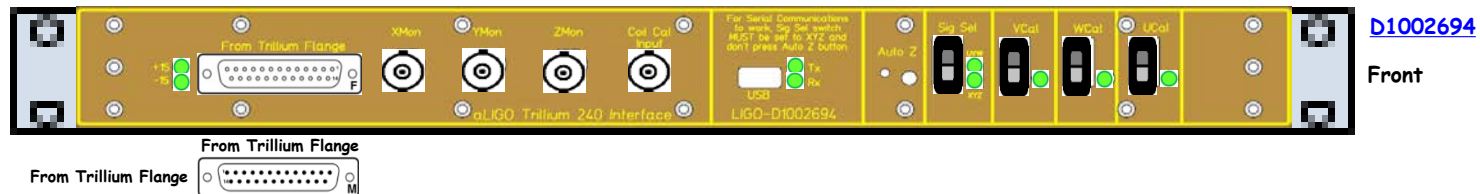

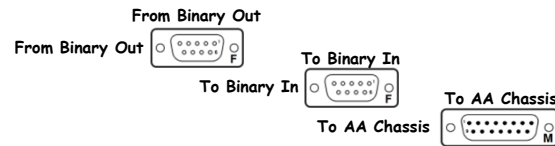
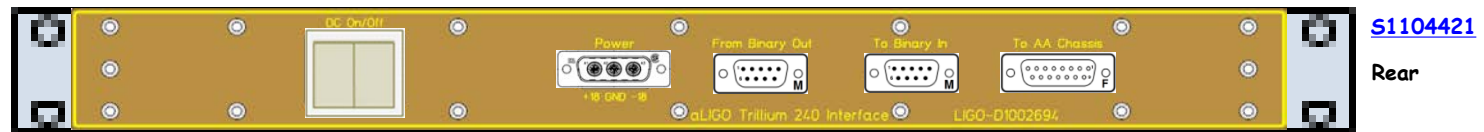

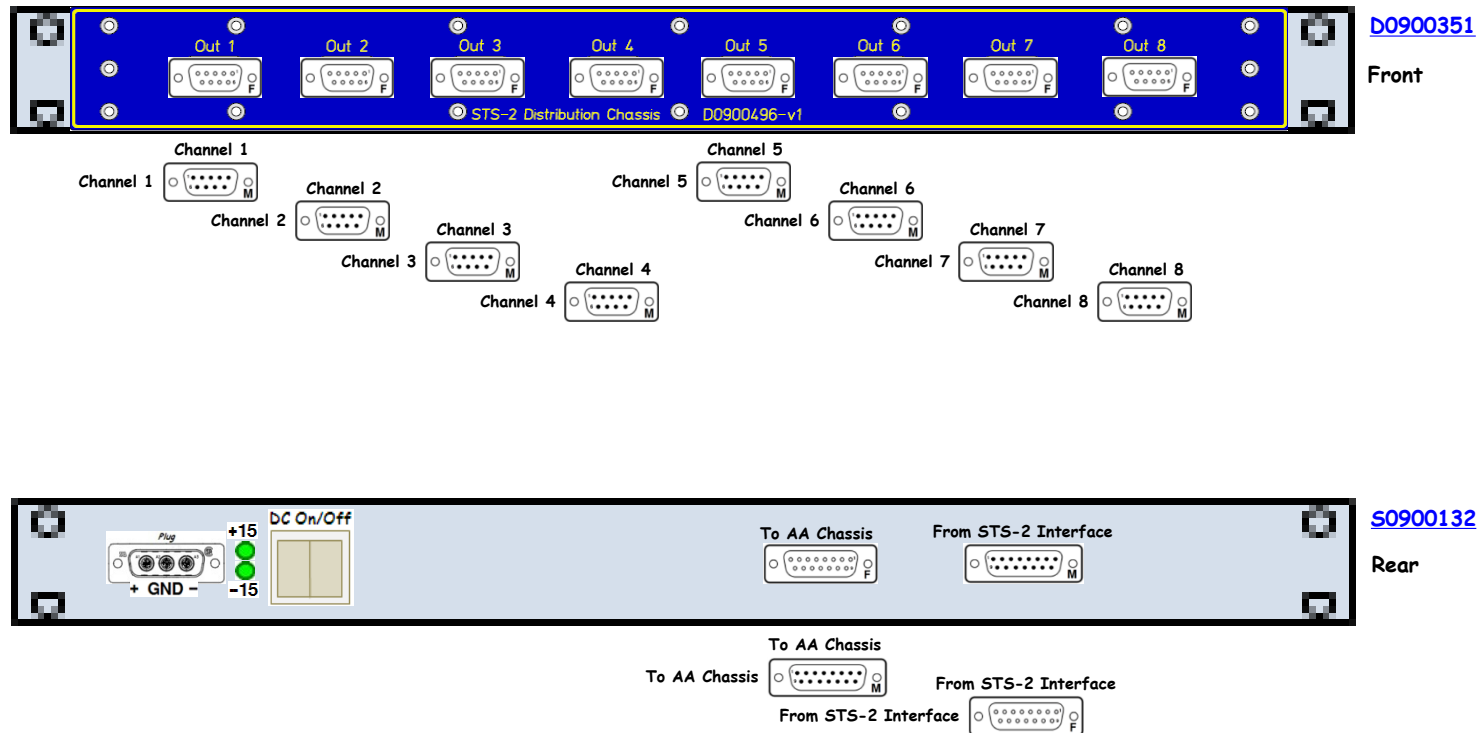

BSC2 STS-2 Interface Chassis

D080535

S0900094

±18VDC

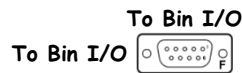
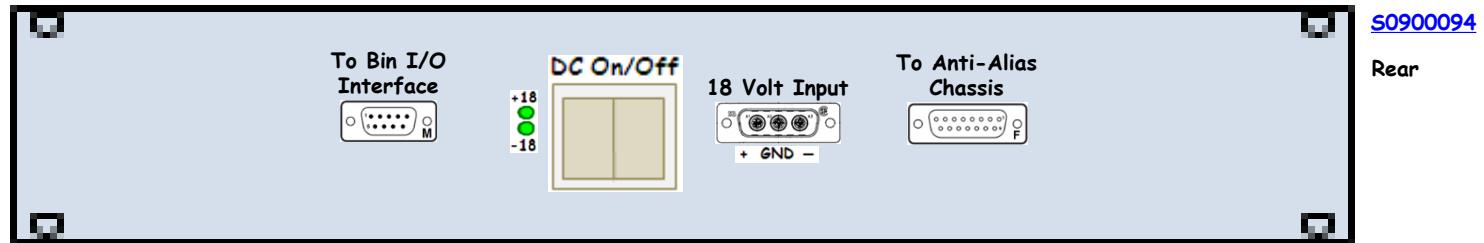
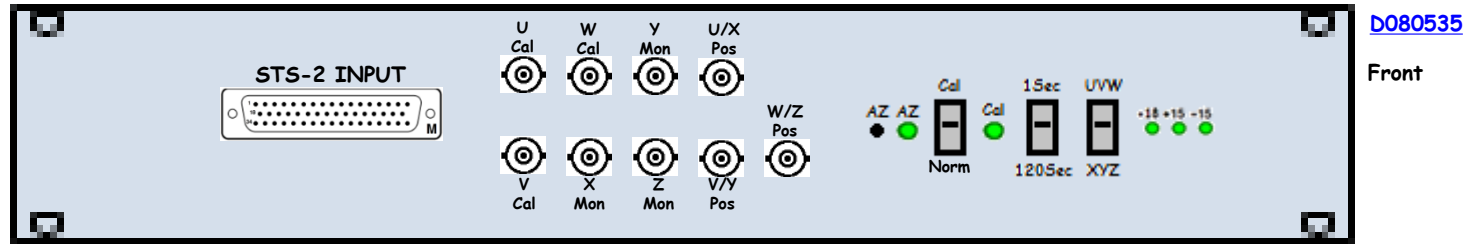



D1001715
Front

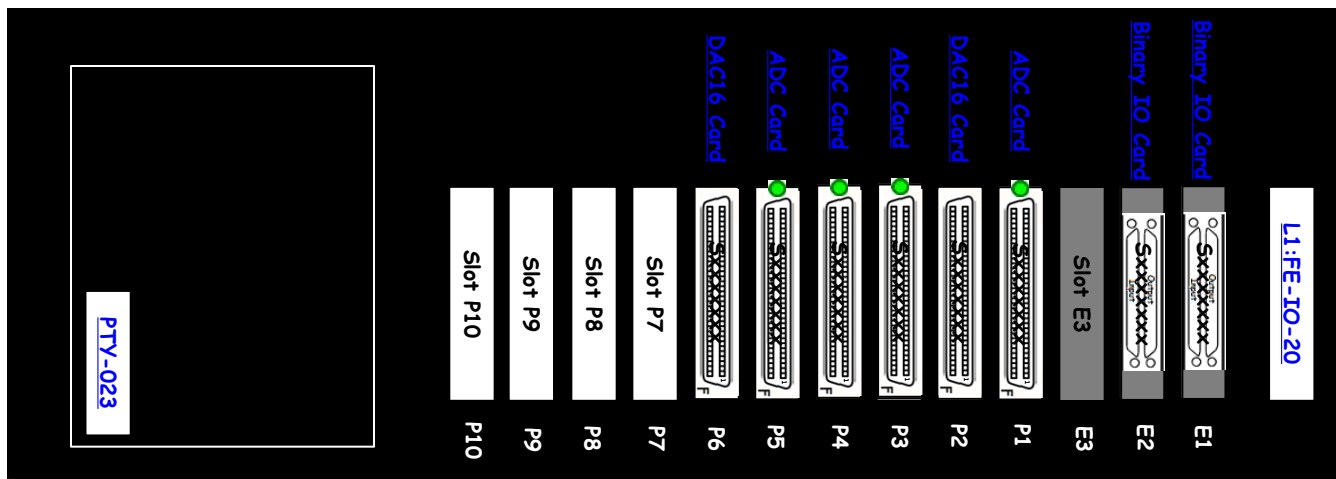

S1001148
Rear

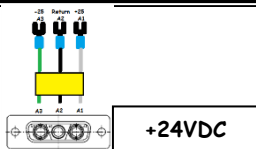
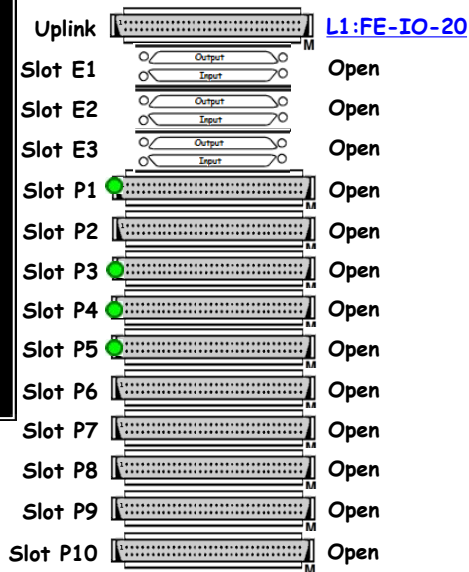

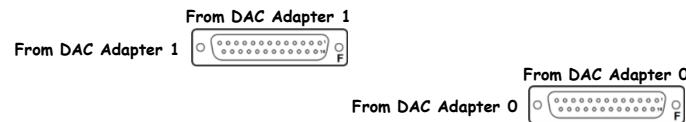
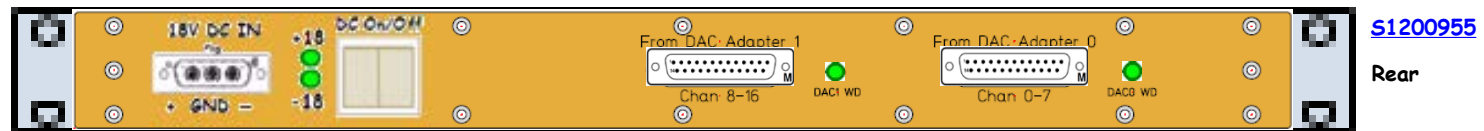
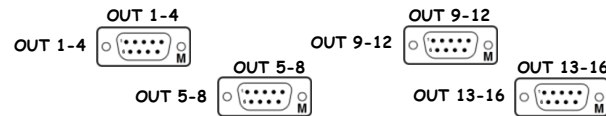
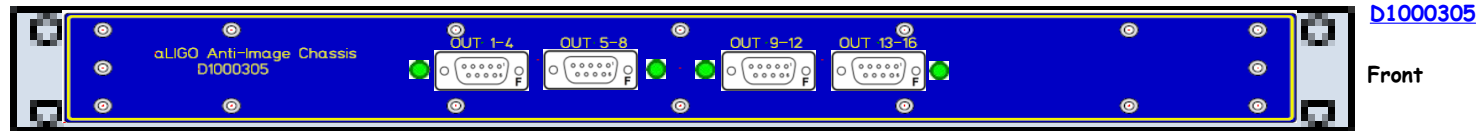

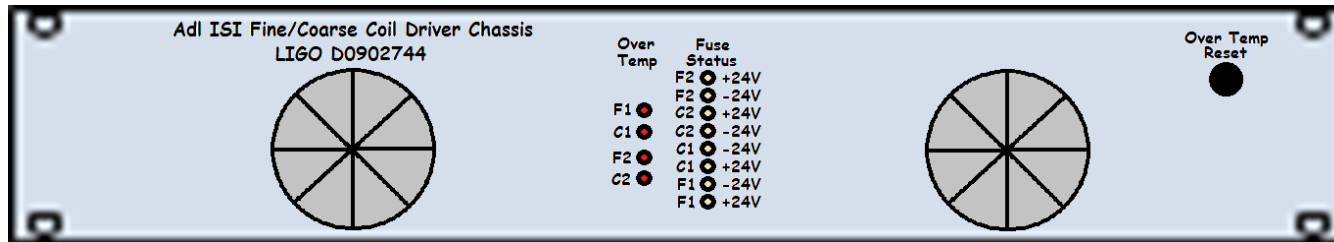

D0902744

Front

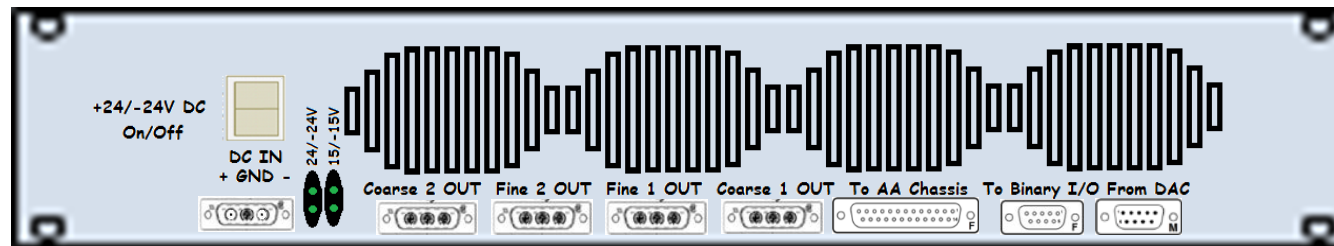

S1103305

Rear

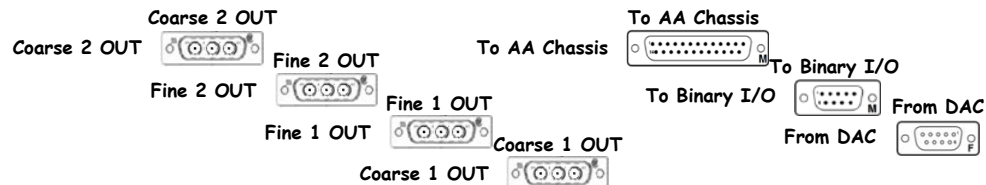

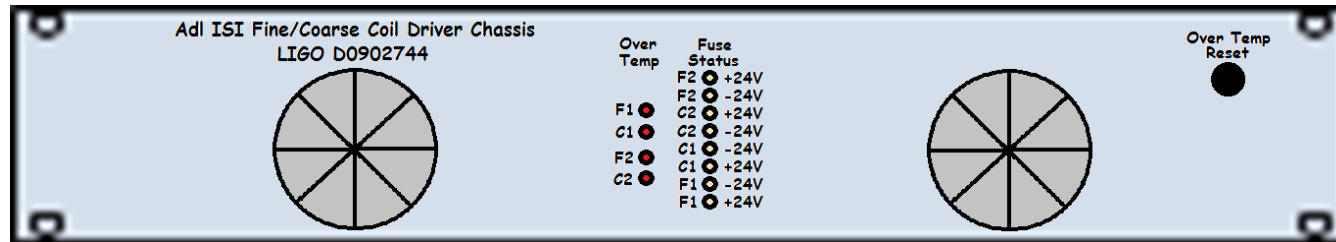

D0902744

Front

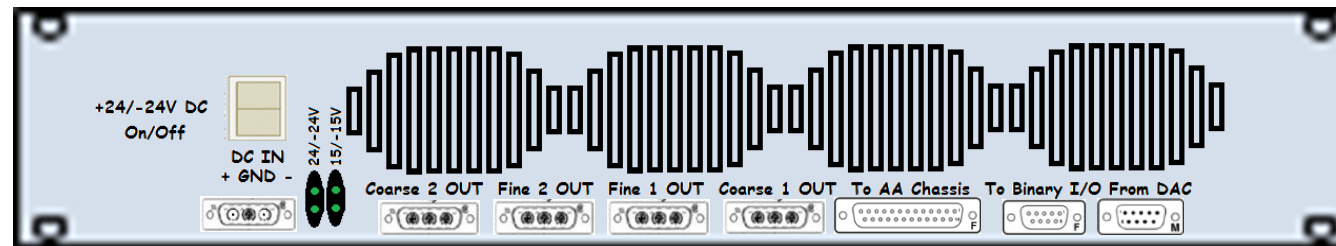

S1103337

Rear

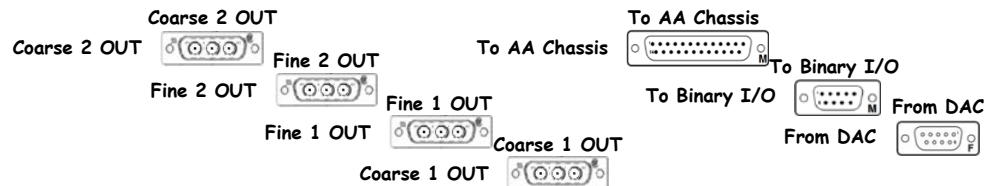

D0902744 - S1103353



<< L1-SEI-C5

BSC2 ISI Coil Driver Pod 1

D0902744

S1103353

±24VDC

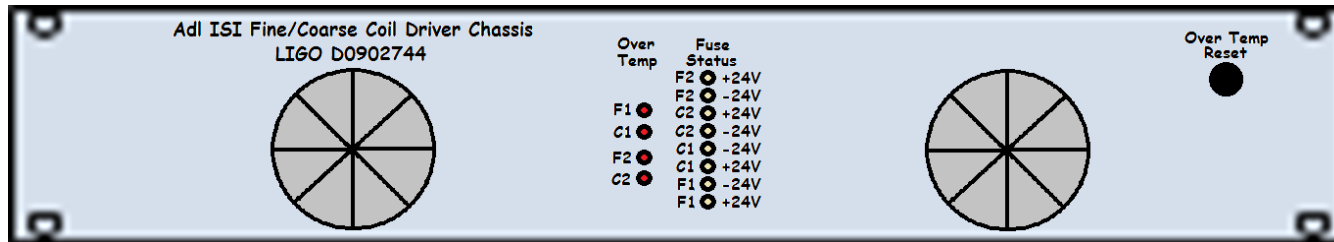

D0902744

Front

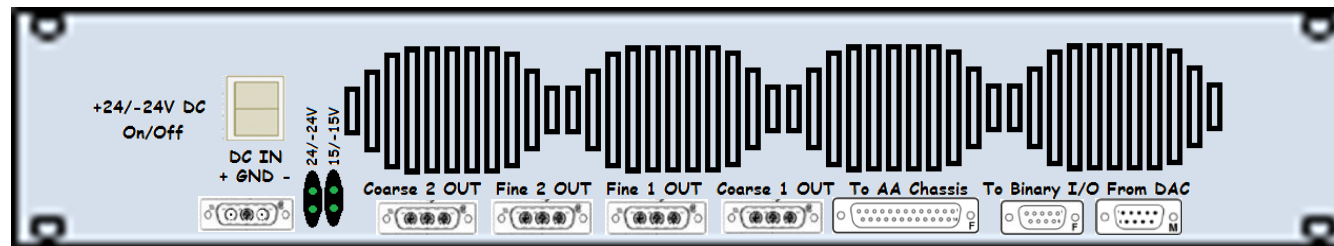

S1103353

Rear

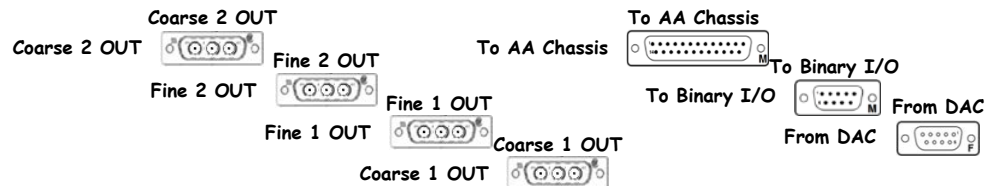

	42				
	41				
BSC3 ISI Interface Chassis Pod 1	D1002432	40	S1201323		±18VDC
BSC3 ISI Interface Chassis Pod 2	D1002432	39	S1201322		±18VDC
BSC3 ISI Interface Chassis Pod 3	D1002432	38	S1201327		±18VDC
	37				
	36				
BSC3 ISI Anti-Alias Chassis	D1002693	35	S1203102		±18VDC
BSC3 ISI Anti-Alias Chassis	D1002693	34	S1203101		±18VDC
	33				
BSC3 ISI Anti-Alias Chassis	D1002693	32	S1203100		±18VDC
	31				
BSC3 HEPI Anti-Alias Chassis	D1000272	30	S1203002		±18VDC
BSC3 HEPI Anti-Image Chassis	D1100202	29	S1203132		±18VDC
	28				
BSC3 HEPI 8-Channel Valve Driver	D0900117	27	S0900280		±18VDC
	26				
BSC3 HEPI Binary Input Chassis	D1001726	25	S1101299		+18VDC
BSC3 HEPI Binary Input Chassis	D1001726	24	S1101298		+18VDC
BSC3 HEPI Binary Output Chassis	D1001728	23	S1101328		+18VDC
	22				
BSC3 T-240 Interface Chassis Pod 1	D1002694	21	S1201892		±18VDC
BSC3 T-240 Interface Chassis Pod 2	D1002694	20	S1104429		±18VDC
BSC3 T-240 Interface Chassis Pod 3	D1002694	19	S1104428		±18VDC
	18				
BSC3 STS-2 Distribution Chassis	D0900351	17	S0900130		±18VDC
BSC3 STS-2 Interface Chassis	D080535	16	S0900092		±24VDC
	15				
	14				
I1seibsc3 - I/O Extension Chassis	D1001715	12	S1100946		+24VDC
	11				
	10				
BSC3 Anti-Image Chassis	D1000305	9	S1203269		±18VDC
	8				
BSC3 ISI Coil Driver Pod 1	D0902744	6	S1103565		±24VDC
BSC3 ISI Coil Driver Pod 2	D0902744	4	S1103315		±24VDC
BSC3 ISI Coil Driver Pod 3	D0902744	2	S1103329		±24VDC
	1				
		Front	Rear		

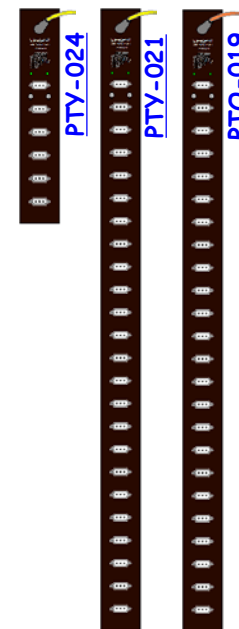

SEI-C6 is part of [D0901301](#)

L1-SEI-C6 Details

SEI-C6 is part of [D0901301](#)

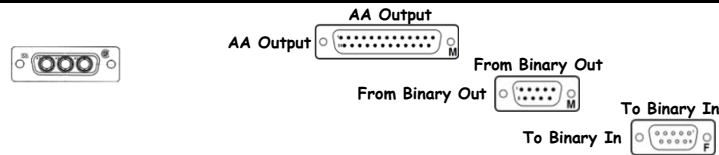
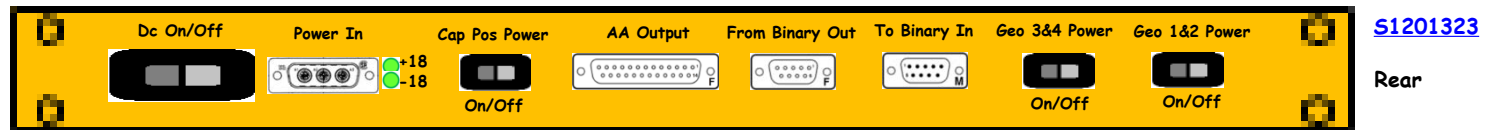
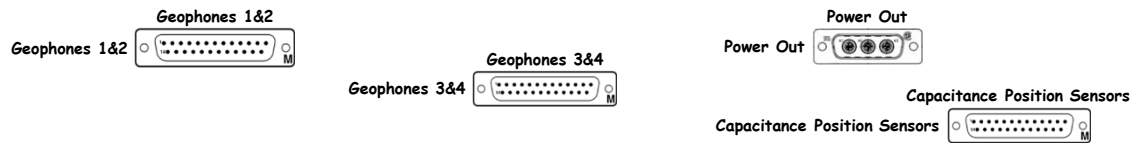
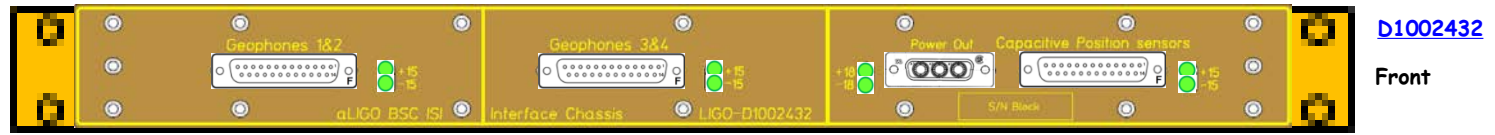

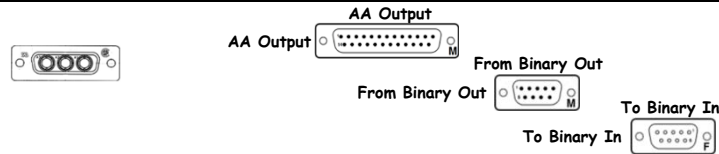
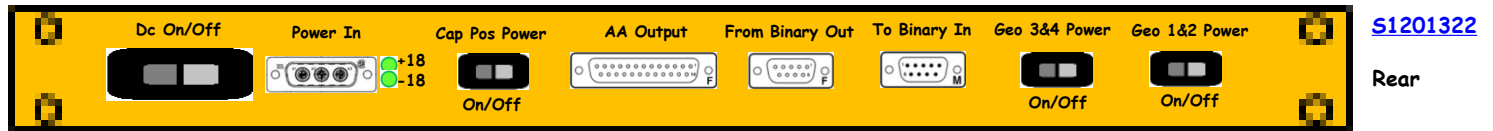
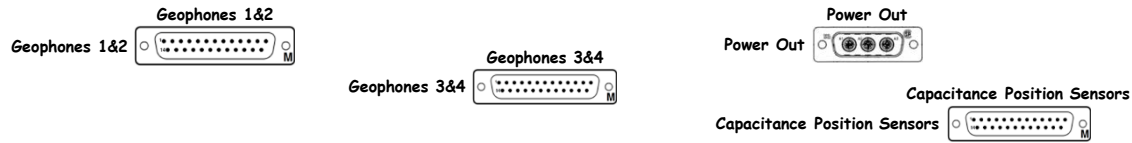

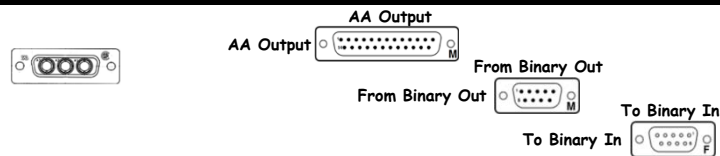
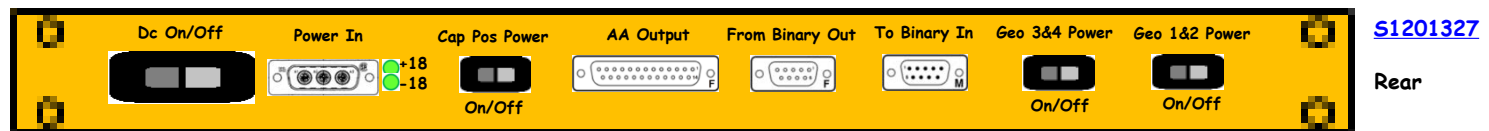
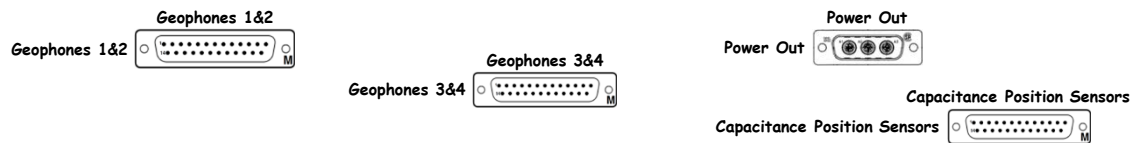

BSC3 ISI Anti-Alias Chassis D1002693 S1203102 ±18VDC

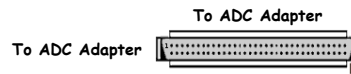
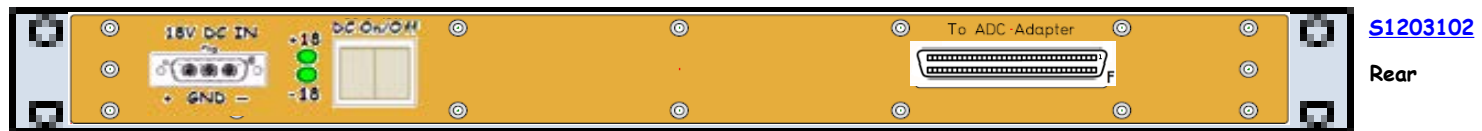
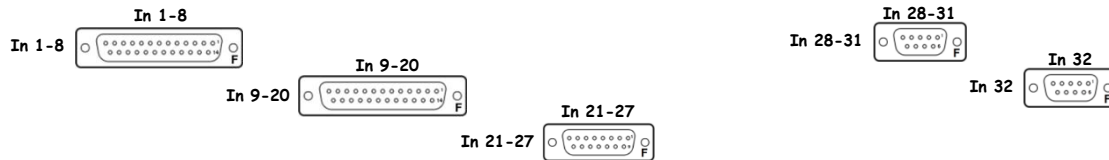
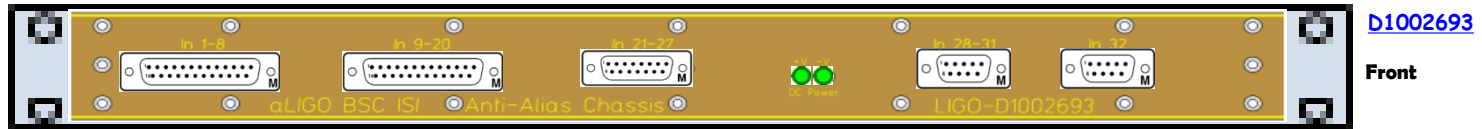

BSC3 ISI Anti-Alias Chassis D1002693 S1203101 ±18VDC

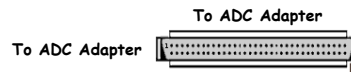
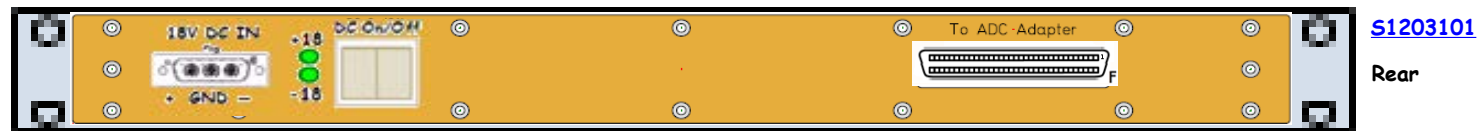
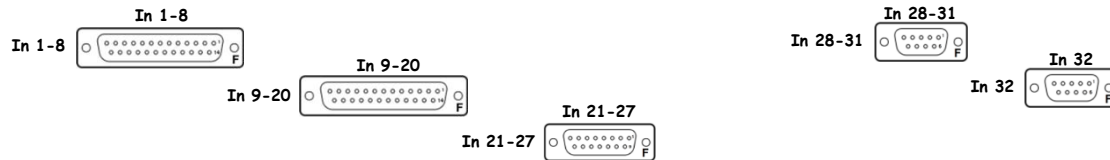
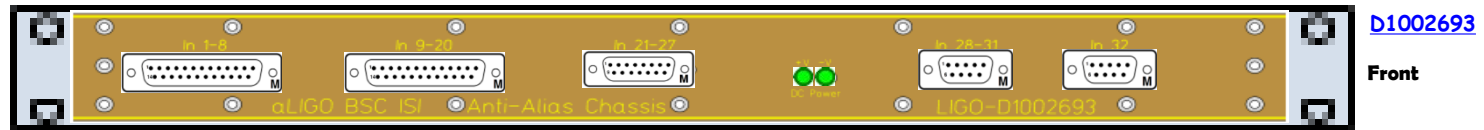

BSC3 ISI Anti-Alias Chassis D1002693 S1203100 ±18VDC

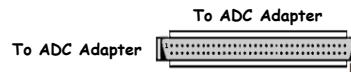
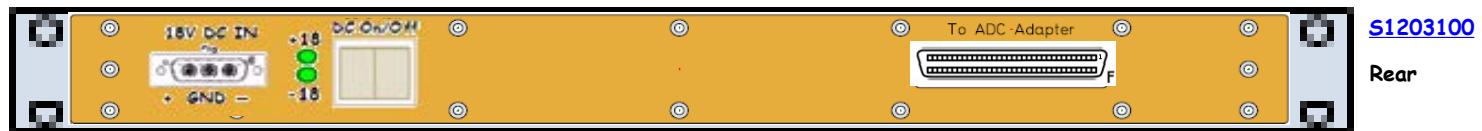
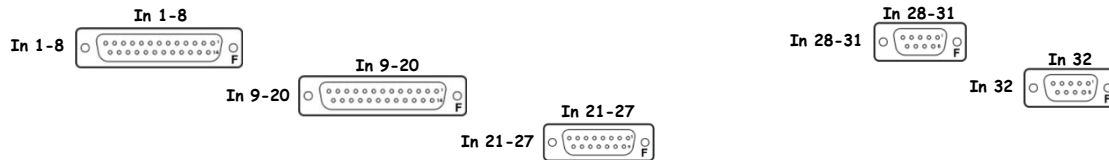
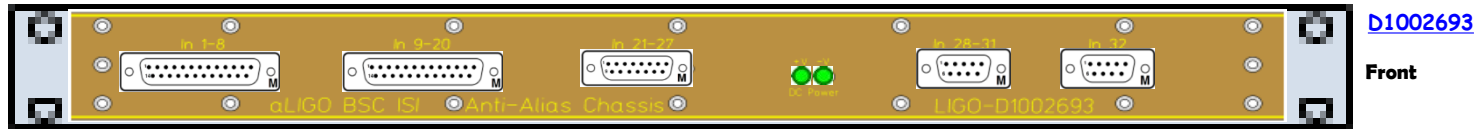

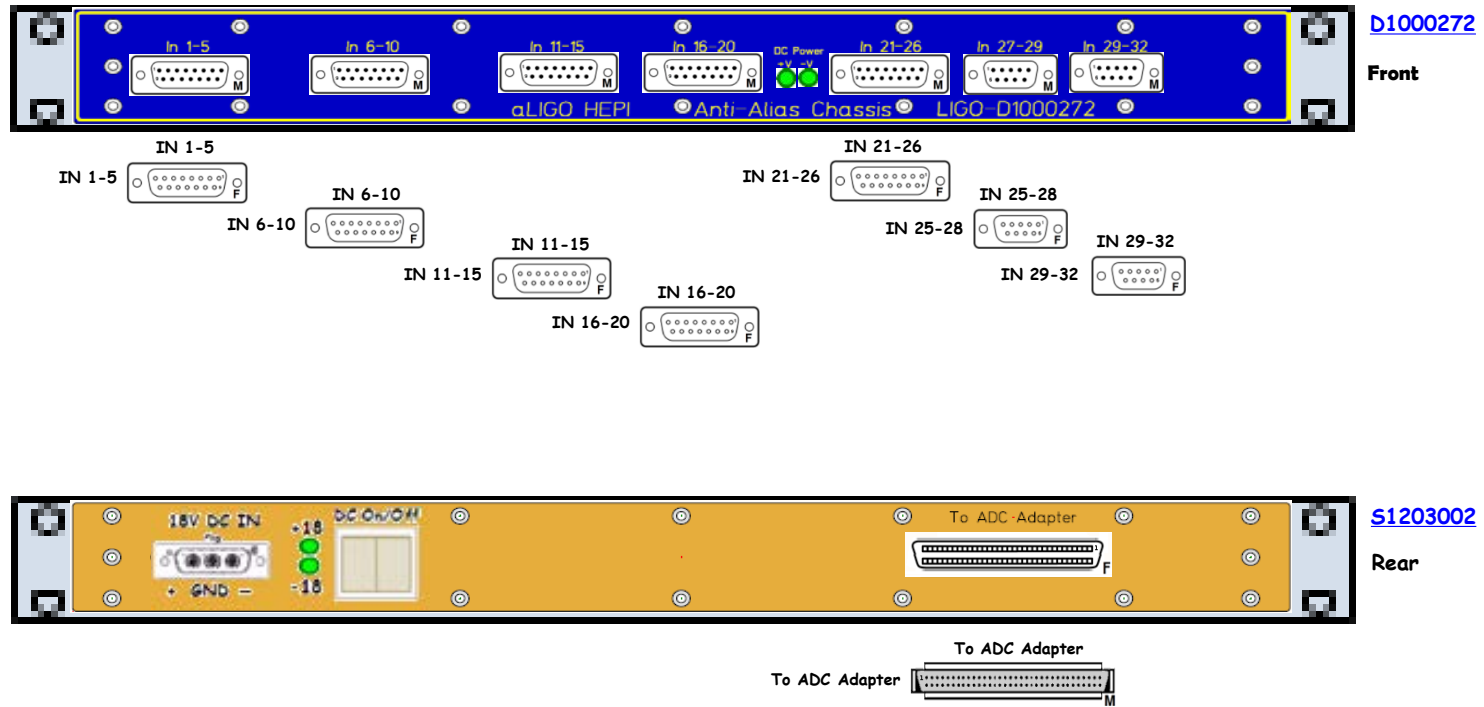

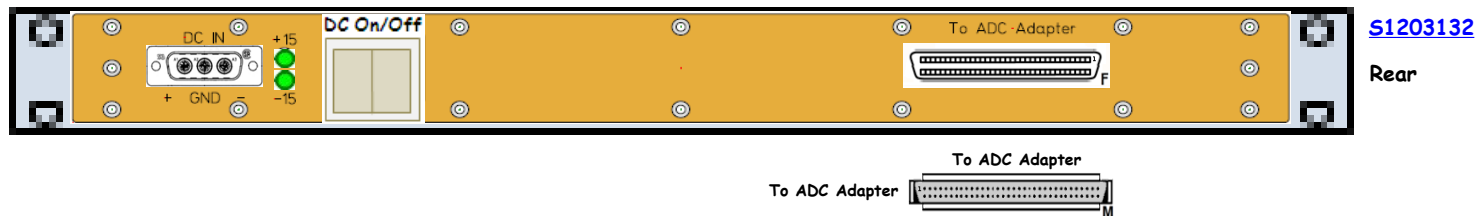
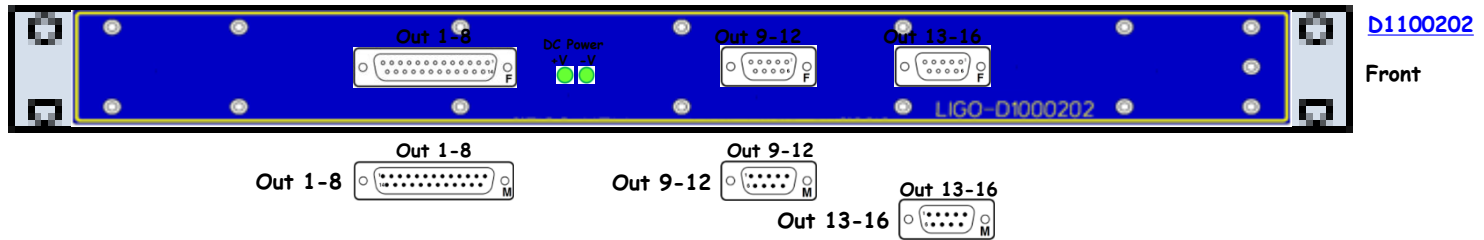

BSC3 HEPI 8-Channel Valve Driver D0900117 S0900280 ±18VDC

BSC3

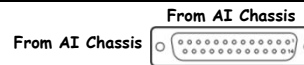
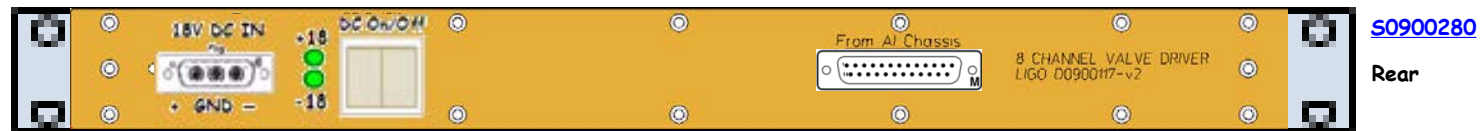
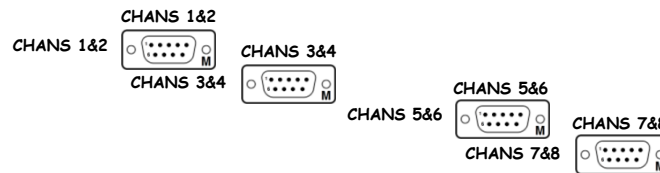
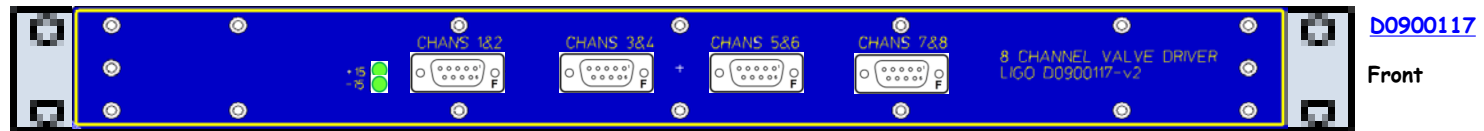

[D0900117](#) is part of [D0901338](#)

BSC3 HEPI Binary Input Chassis D1001726 S1101299 +18VDC

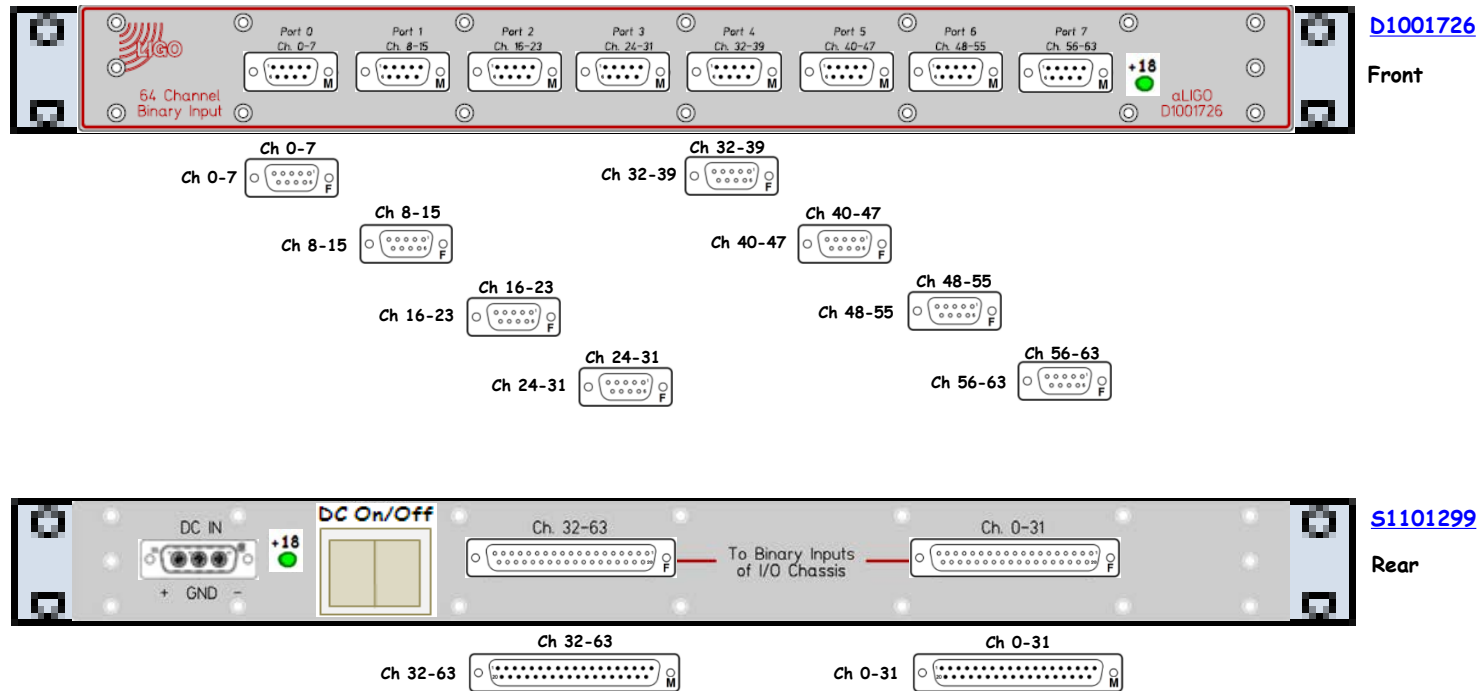

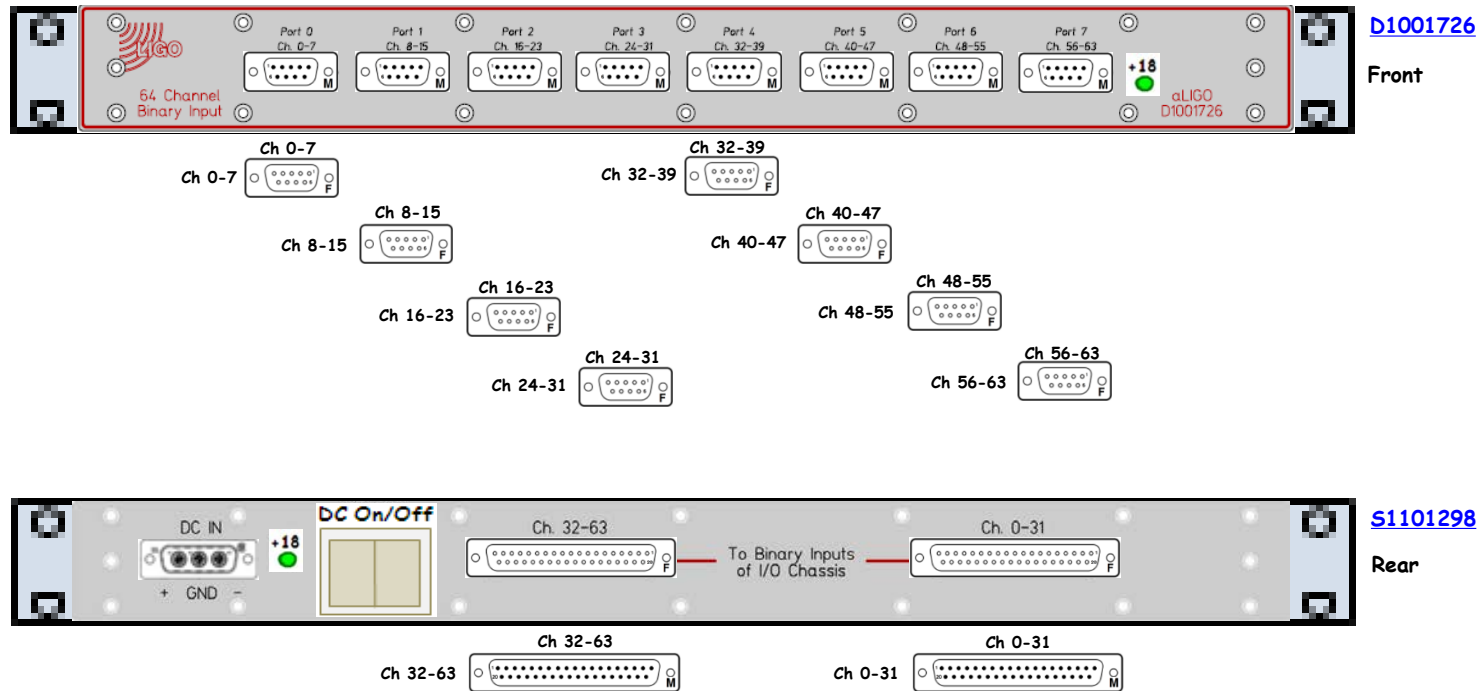

BSC3 HEPI Binary Output Chassis D1001728 S1101328 +18VDC

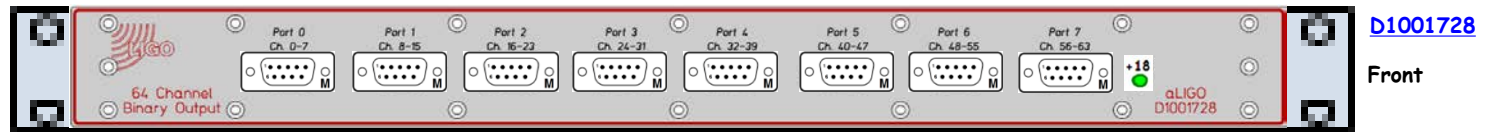

Front

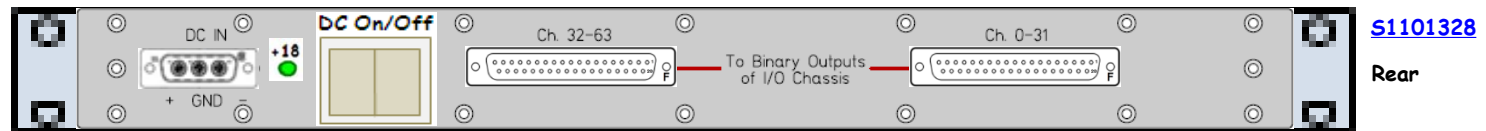
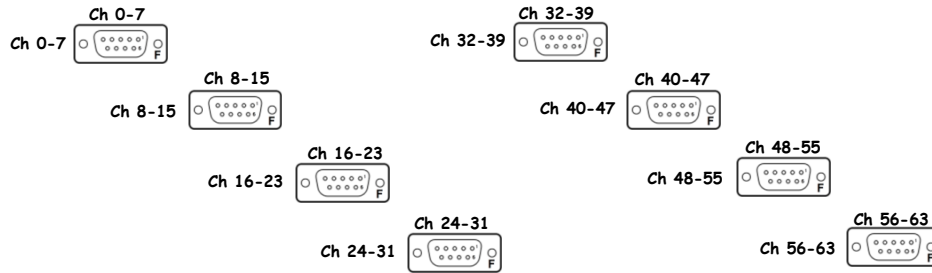

Rear



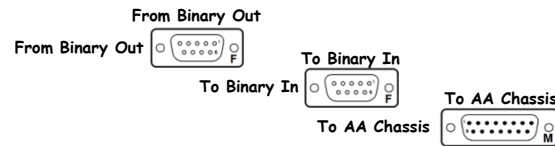
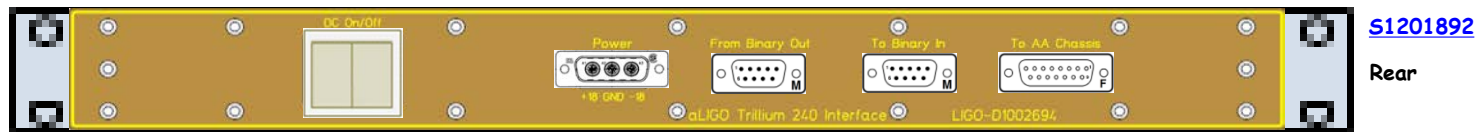

D1002694 - S1104429

BSC3 T-240 Interface Chassis Pod 2 D1002694 S1104429 ±18VDC

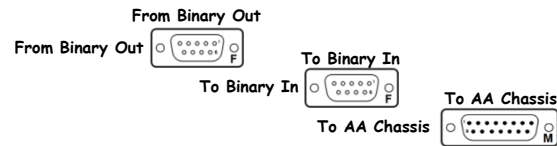
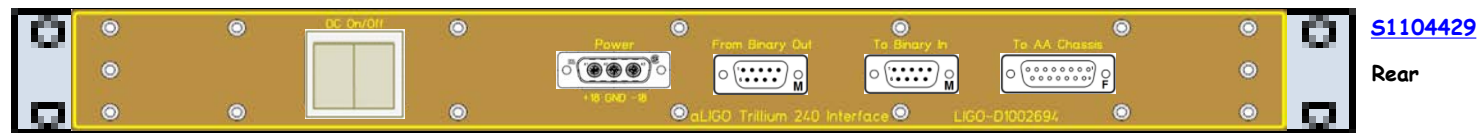

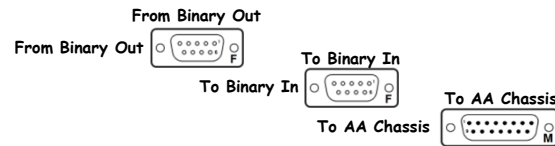
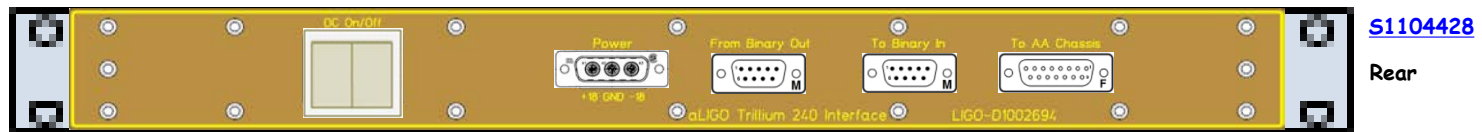

BSC3 STS-2 Distribution Chassis D0900351 S0900130 ±18VDC

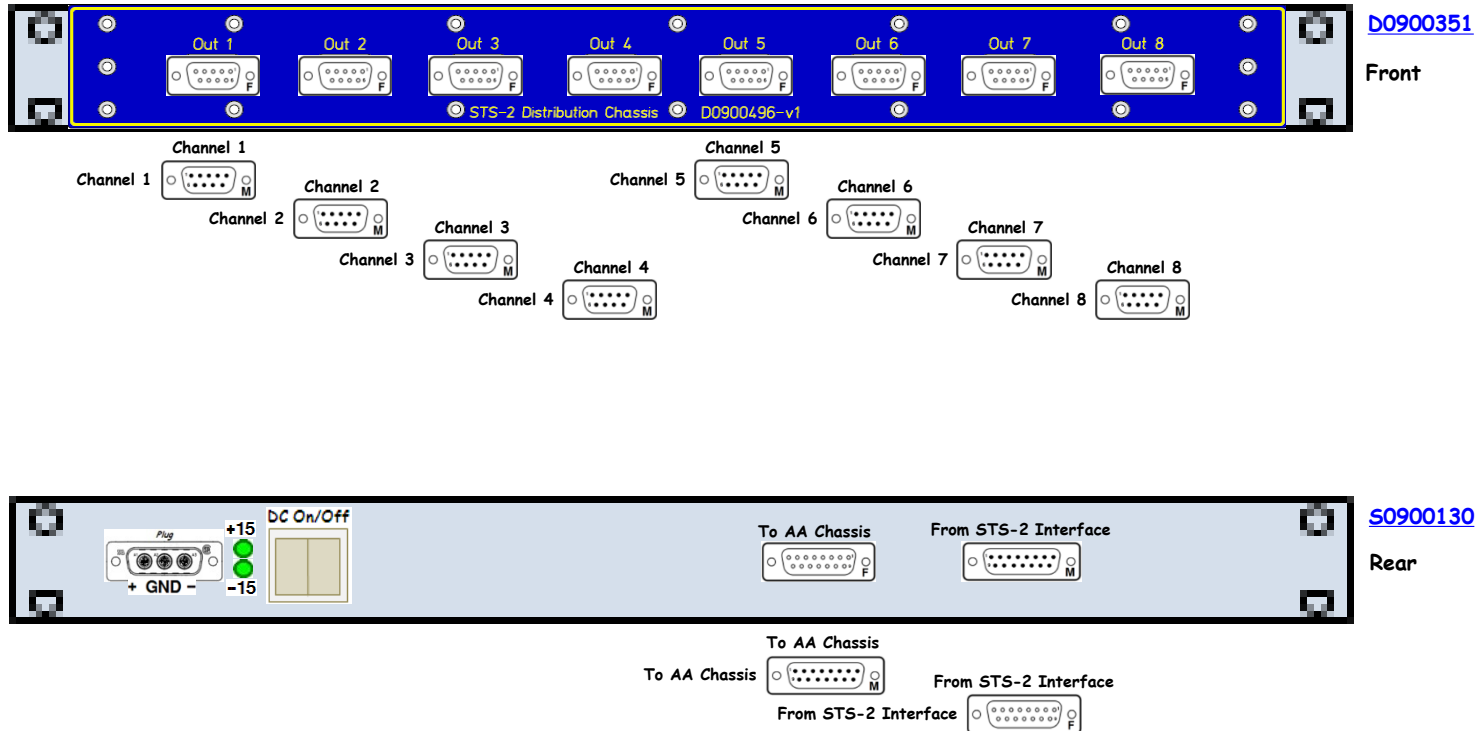

BSC3 STS-2 Interface Chassis

D080535

S0900092

±18VDC

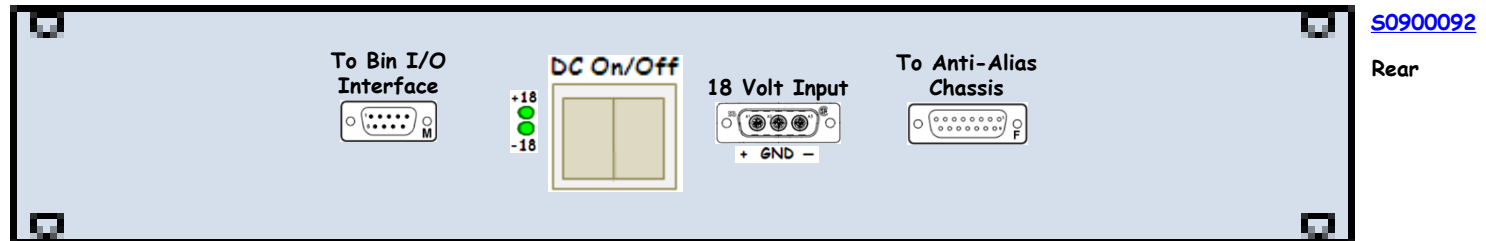
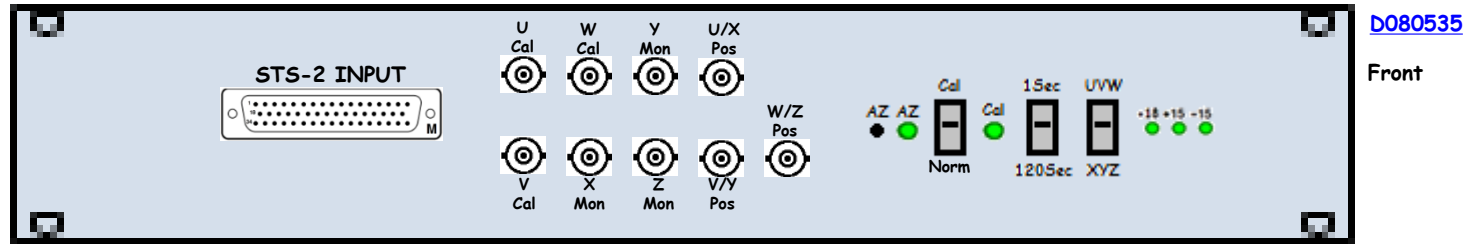

I1seibsc3 - D1001715 - S1100946

I1seibsc3 - I/O Extension Chassis

D1001715

S1100946

+24VDC



D1001715

Front

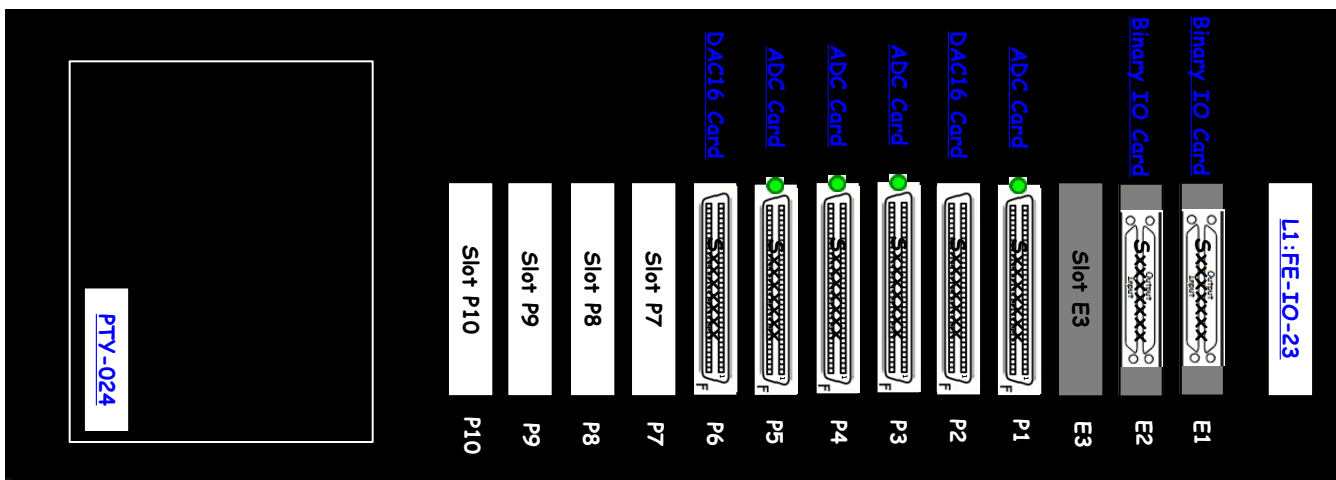

S1100946

Rear

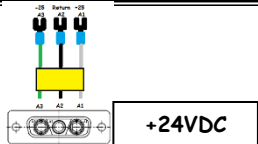
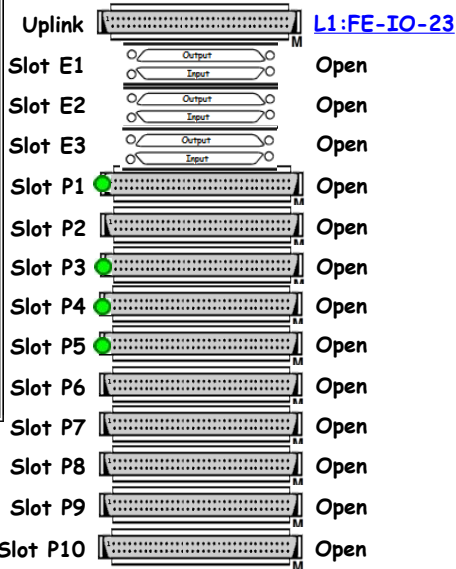

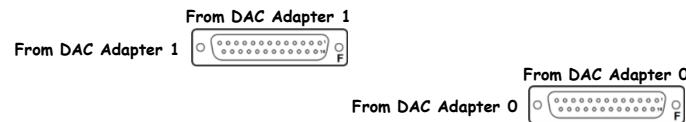
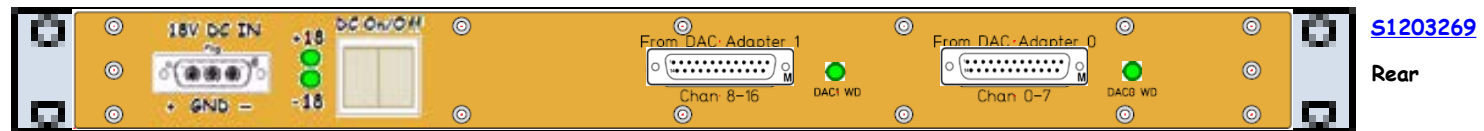
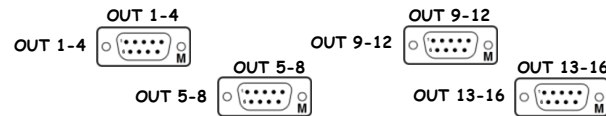
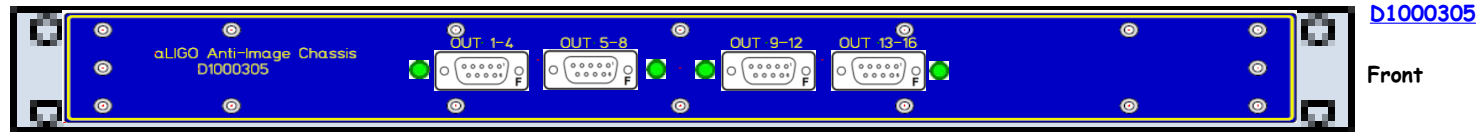

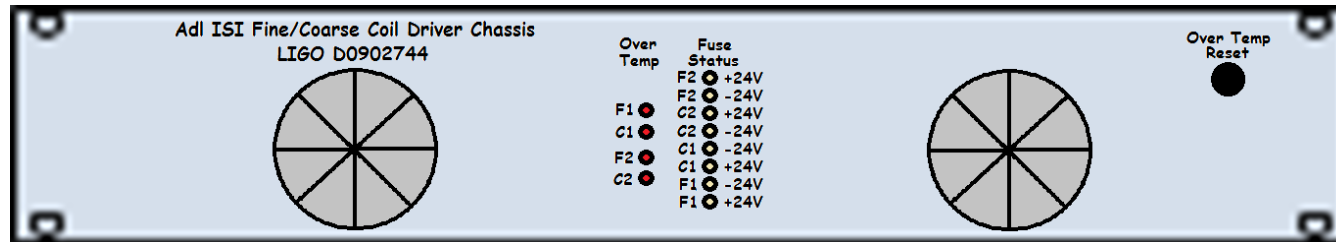

[D0902744](#)

Front

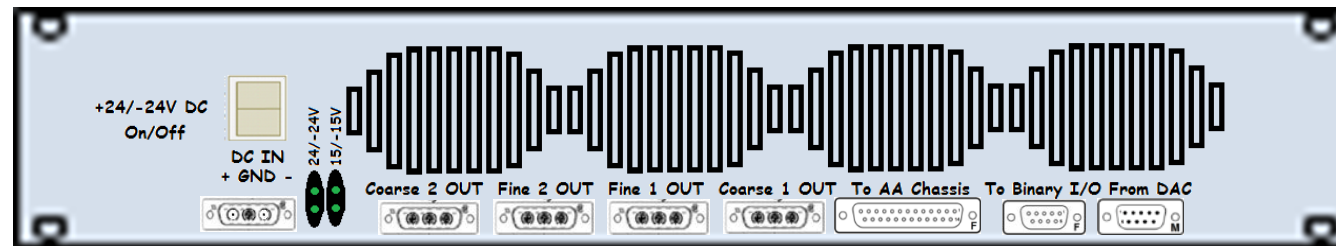

[S1103565](#)

Rear

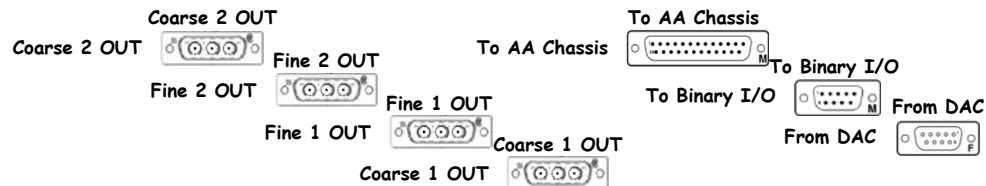

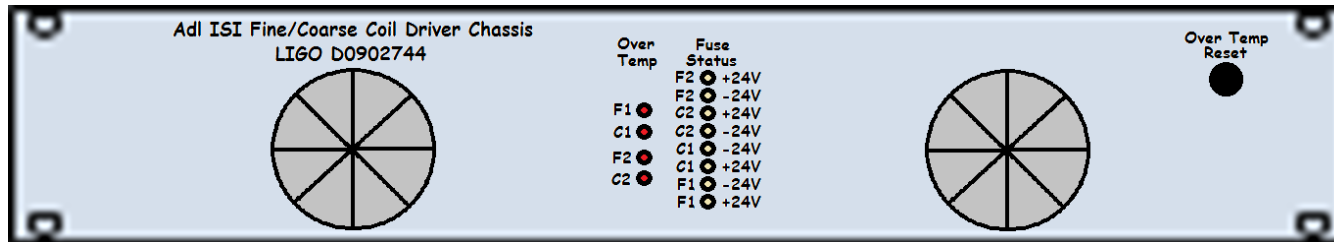

[D0902744](#)

Front

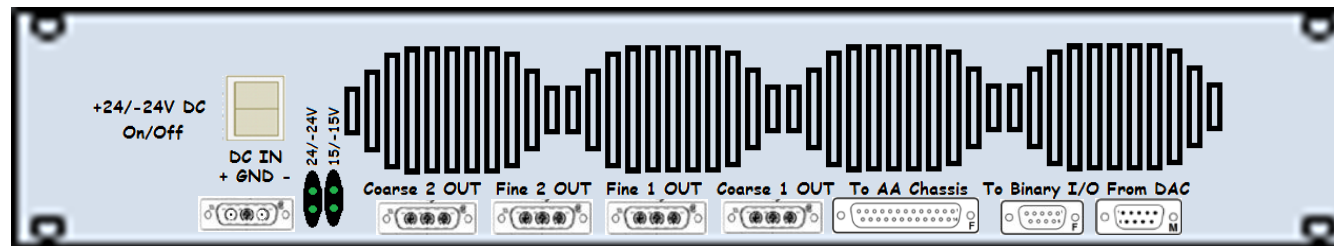

[S1103315](#)

Rear

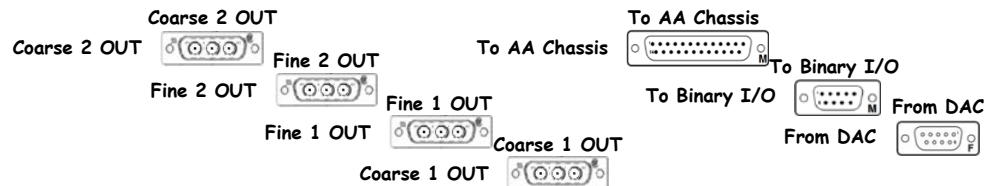

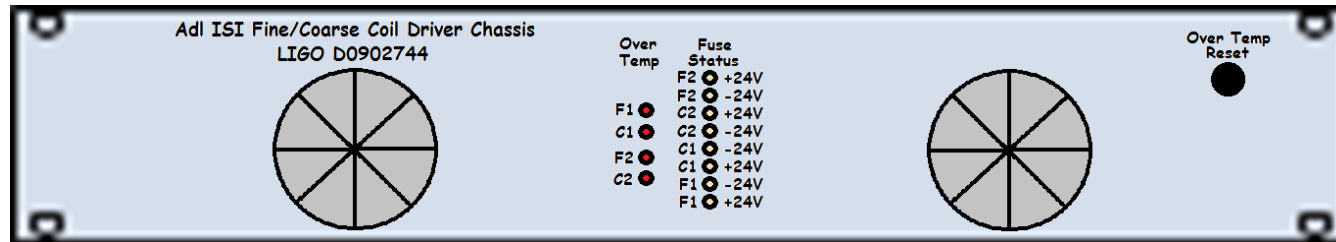

[D0902744](#)

Front

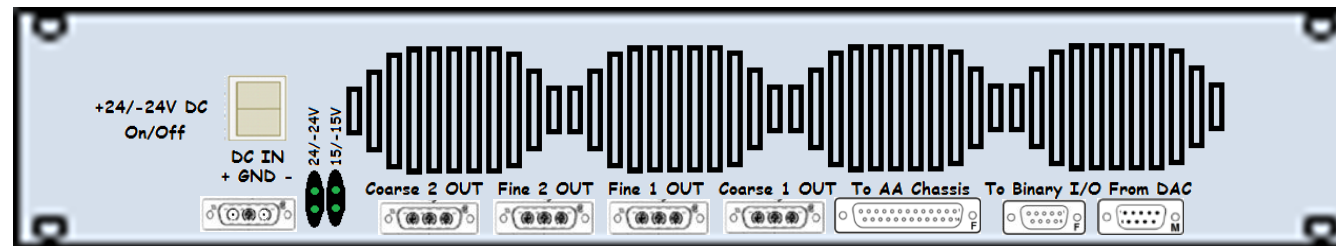

[S1103329](#)

Rear

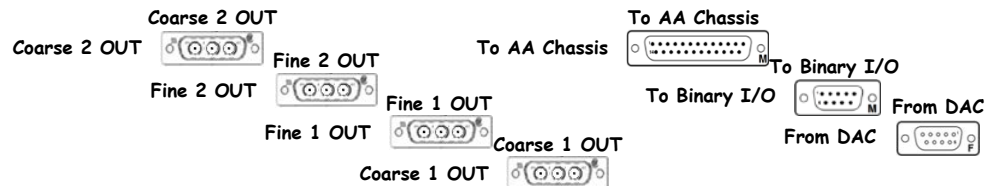

<< LLO Racks by Subsystem

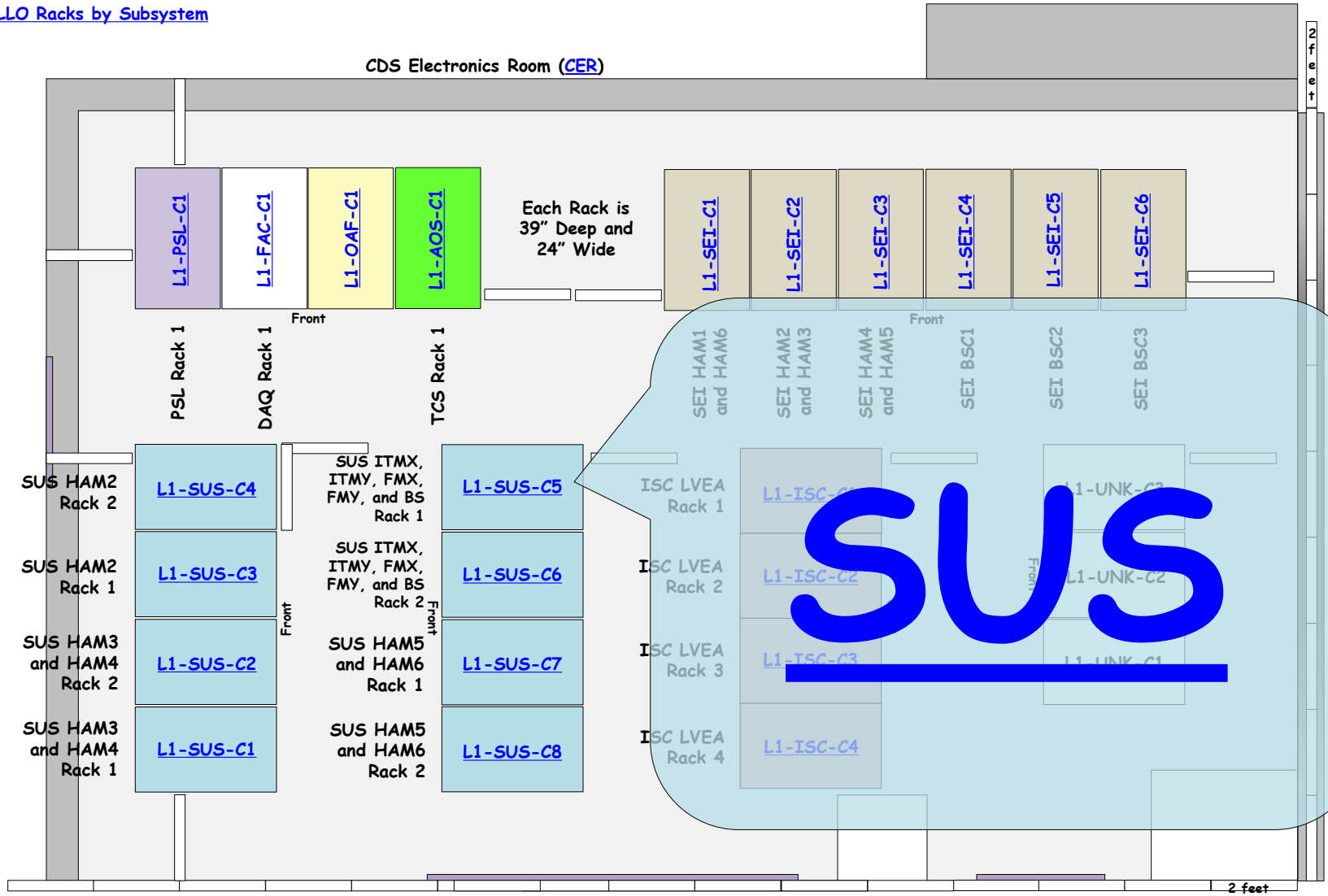

		42				
MC2-PR2 Triple Top Coil Driver Chassis	D1001242	41	S1000260	±18VDC		
MC2-PR2 Triple Top Coil Driver Chassis	D1001242	40	S1000264	±18VDC		
MC2-PR2 Triple Top Coil Driver Chassis	D1001242	39	S1000721	±18VDC		
		38				
SR2 Triple Top Coil Driver Chassis	D1001242	37	S1000722	±18VDC		
SR2 Triple Top Coil Driver Chassis	D1001242	36	S1000273	±18VDC		
		35				
FE ADC0 Anti-Alias Chassis	D0902783	34	S1001157	±18VDC		
FE ADC1 Anti-Alias Chassis	D0902783	33	S1100327	±18VDC		
		32				
FE DAC0, FE DAC1 Anti-Image Chassis	D1000305	31	S1001197	±18VDC		
FE DAC2, FE DAC3 Anti-Image Chassis	D1000305	30	S1001198	±18VDC		
		29				
MC2 Mid Triple Acq Driver Chassis	D0900006	28	S1000347	±18VDC		
MC2 Bot Triple Acq Driver Chassis	D0900006	27	S1000348	±18VDC		
PR2 Mid Triple Acq Driver Chassis	D0900006	26	S1000349	±18VDC		
		25				
FE DAC4, FE DAC5 Anti-Image Chassis	D1000305	24	S1101815	±18VDC		
		23				
PR2 Bot Triple Acq Driver Chassis	D0900006	22	S1001186	±18VDC		
SR2 Mid Triple Acq Driver Chassis	D0900006	21	S1001187	±18VDC		
SR2 Bot Triple Acq Driver Chassis	D0900006	20	S1001188	±18VDC		
		19				
BIO1 Binary Output Chassis	D1000725	18	S1101781	±18VDC		
BIO1 Binary Input Chassis	D1000726	17	S1101805	±18VDC		
BIO2 Binary Output Chassis	D1000725	16	S1101782	±18VDC		
BIO2 Binary Input Chassis	D1000726	15	S1101802	±18VDC		
		14				
		13				
		12				
		11				
		10				
		9				
		8				
		7				
		6				
		5				
		4				
		3				
		2				
		1				
Front			Rear			

L1-SUS-C1 Details

D1001242 - S1000260



<< L1-SUS-C1

MC2-PR2 Triple Top Coil Driver Chassis D1001242 S1000260 ±18VDC

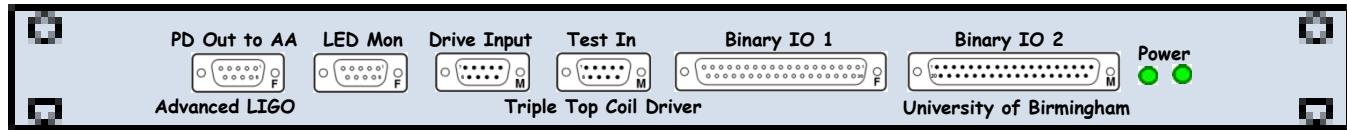

D1001242

Front

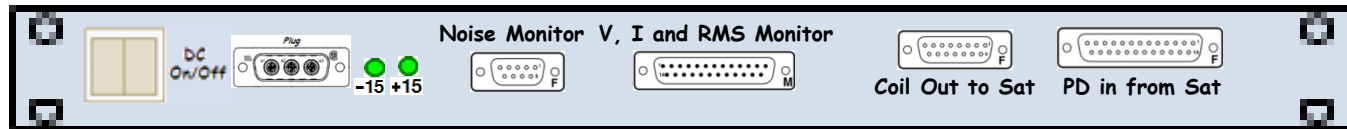
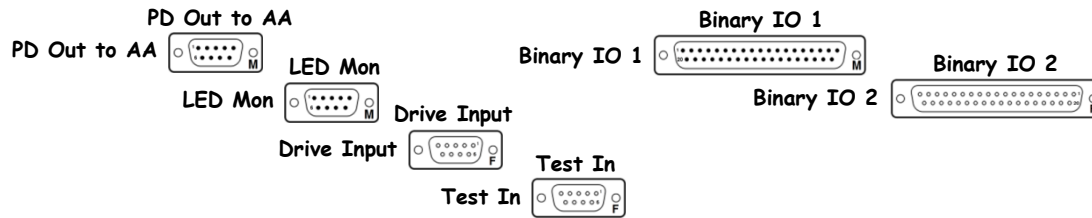

S1000260

Rear

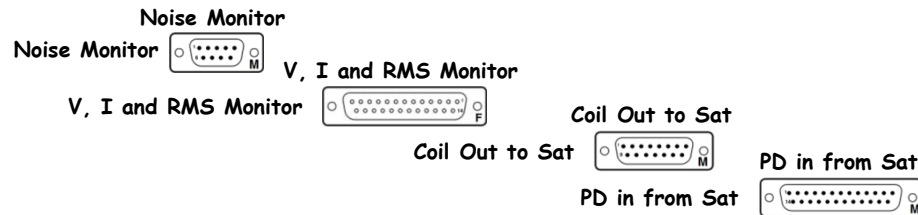

[Driver Board: D0902747](#)

[Monitor Board: D070480](#)

D1001242 - S1000264



<< L1-SUS-C1

MC2-PR2 Triple Top Coil Driver Chassis D1001242 S1000264 ±18VDC

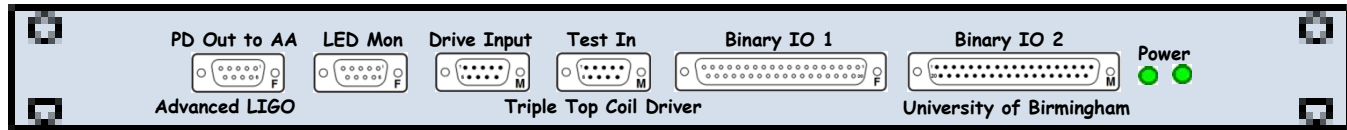

D1001242

Front

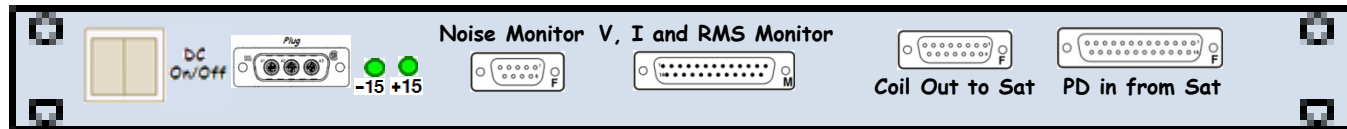
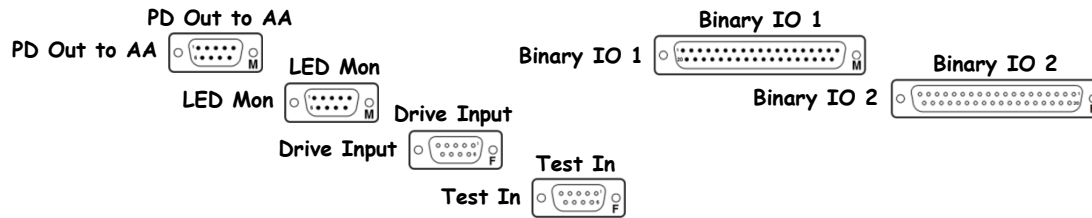

S1000264

Rear

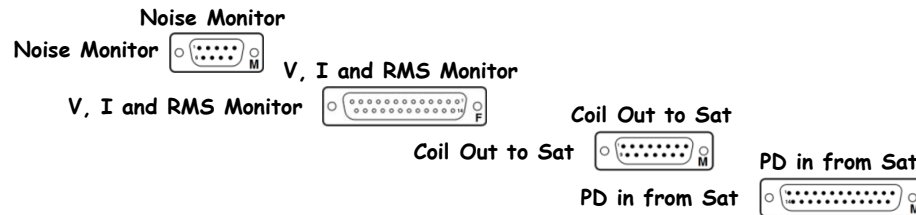

[Driver Board: D0902747](#)

[Monitor Board: D070480](#)

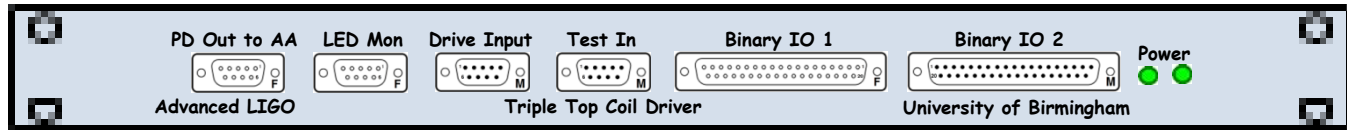

D1001242

Front

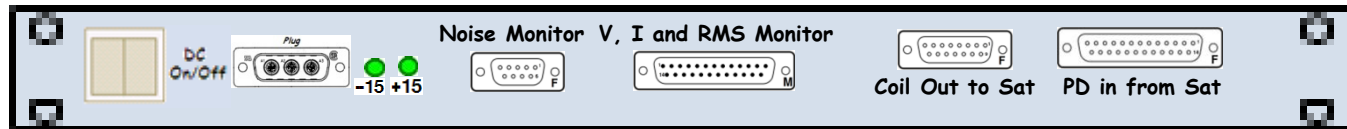
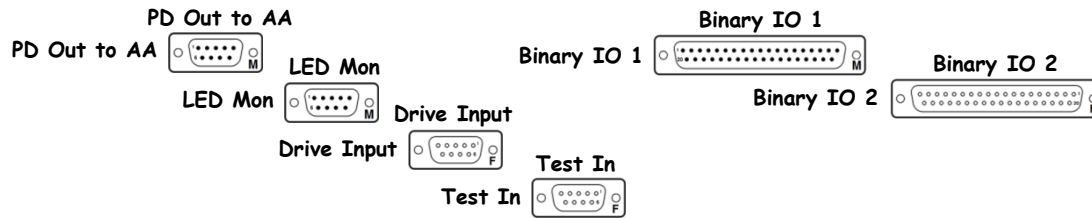

S1000721

Rear

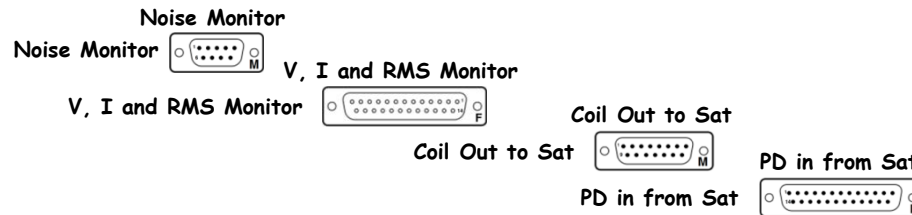

[Driver Board: D0902747](#)

[Monitor Board: D070480](#)

D1001242 - S1000722



<< L1-SUS-C1

SR2 Triple Top Coil Driver Chassis D1001242 S1000722 ±18VDC

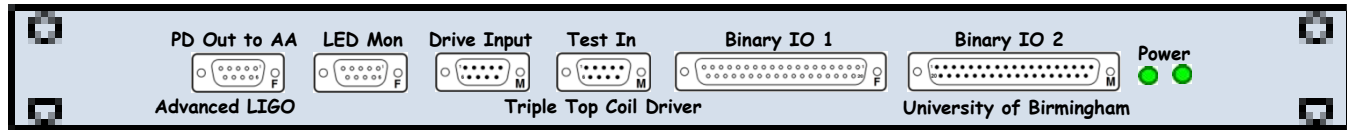

D1001242

Front

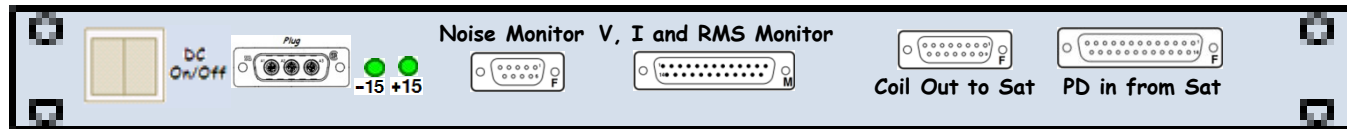
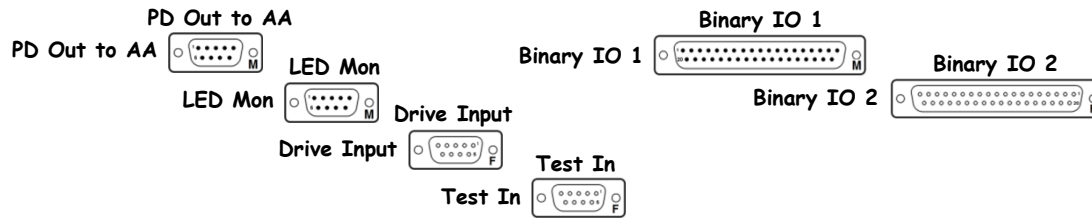

S1000722

Rear

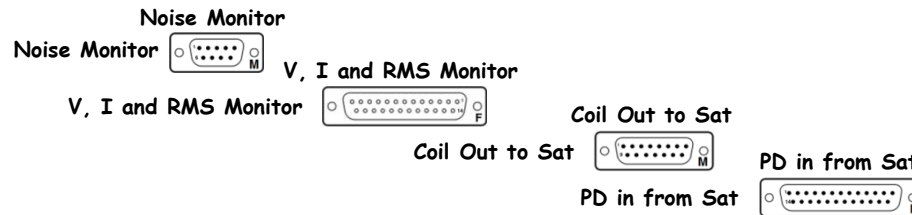

[Driver Board: D0902747](#)

[Monitor Board: D070480](#)

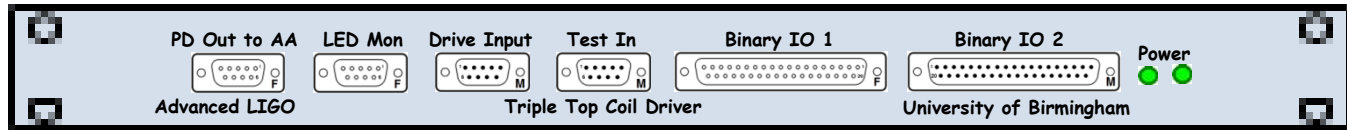

D1001242

Front

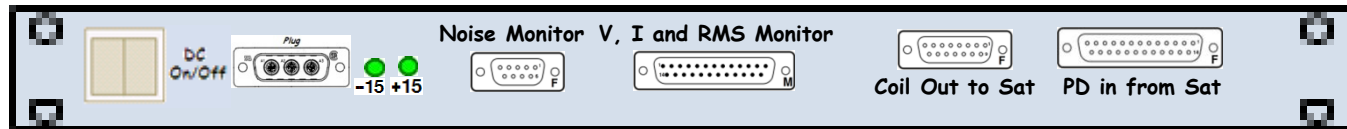
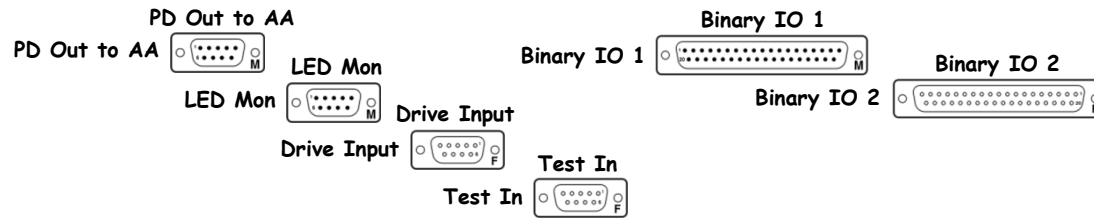

S1000273

Rear

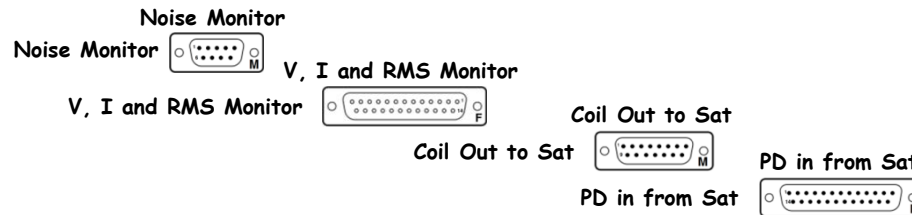

[Driver Board: D0902747](#)

[Monitor Board: D070480](#)

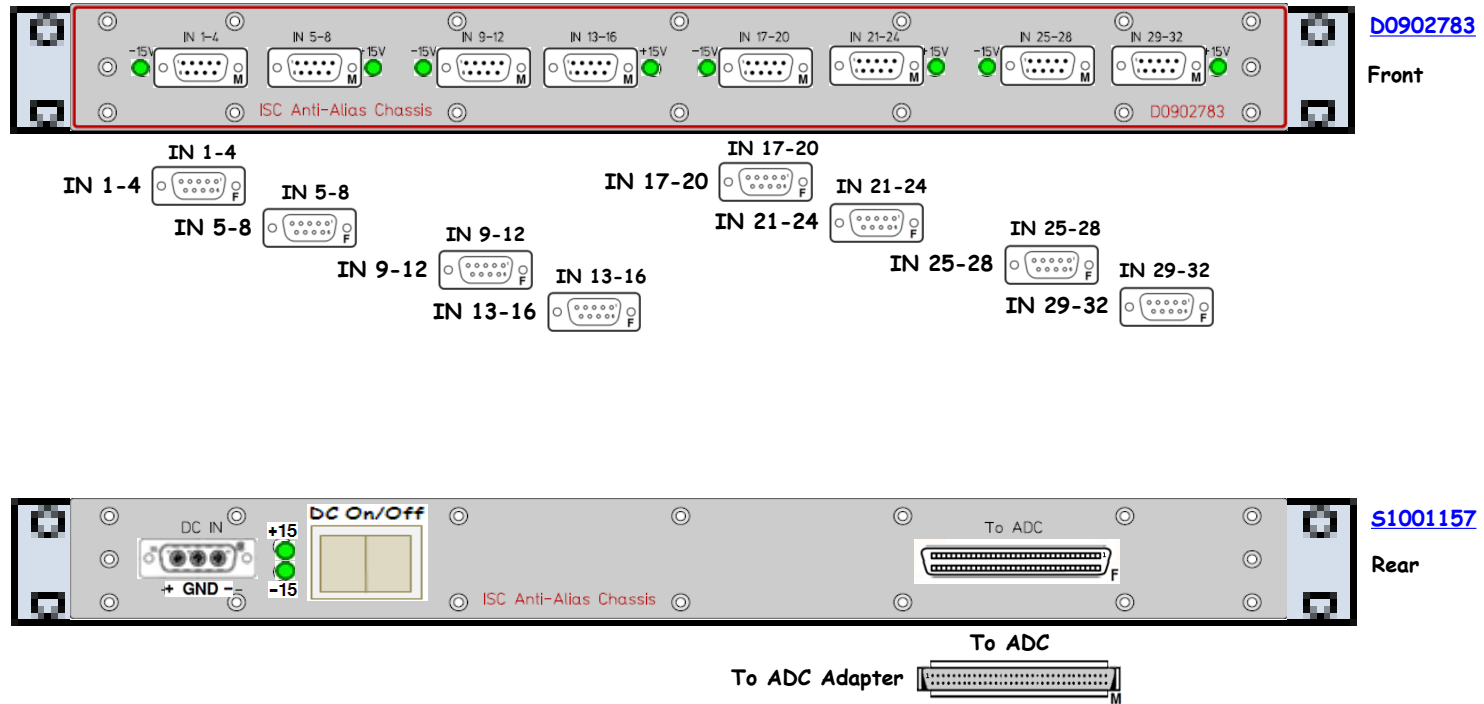

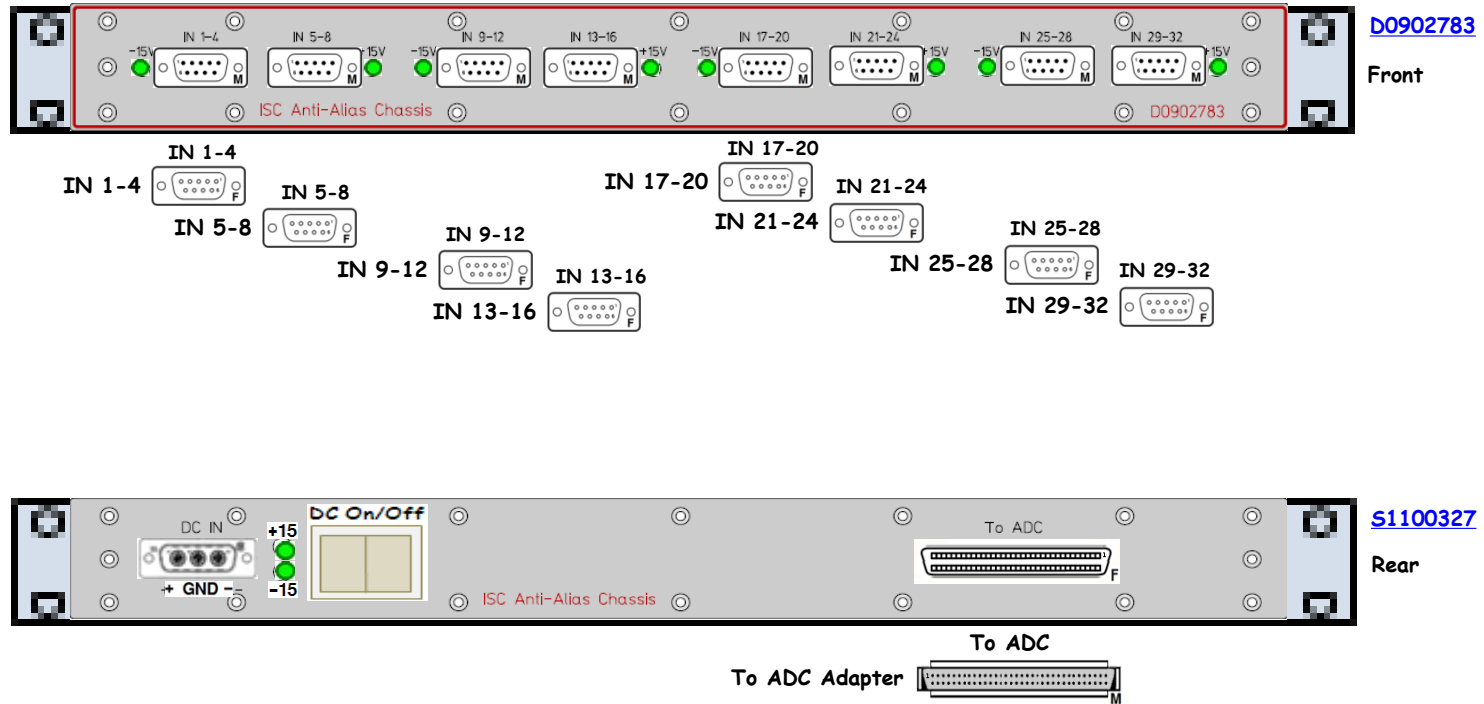

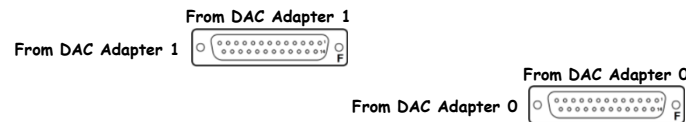
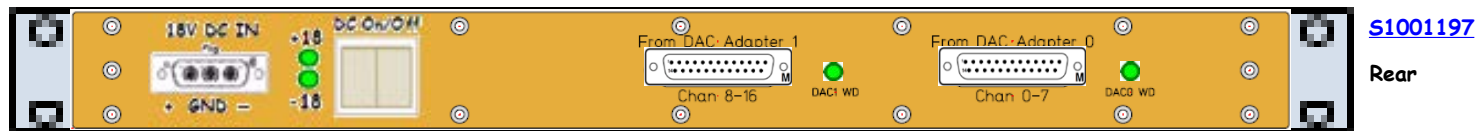
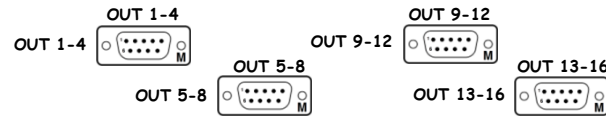
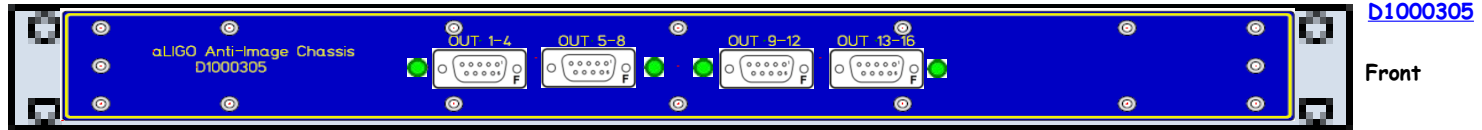

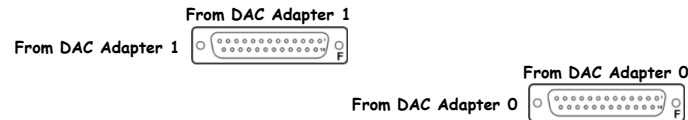
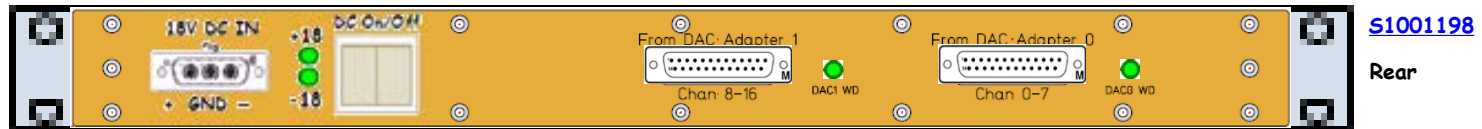
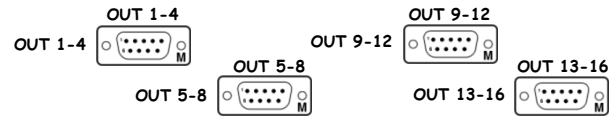
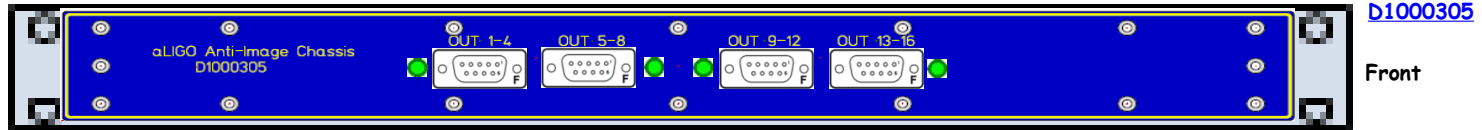

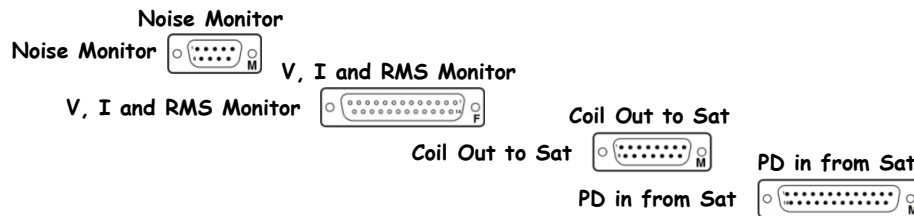
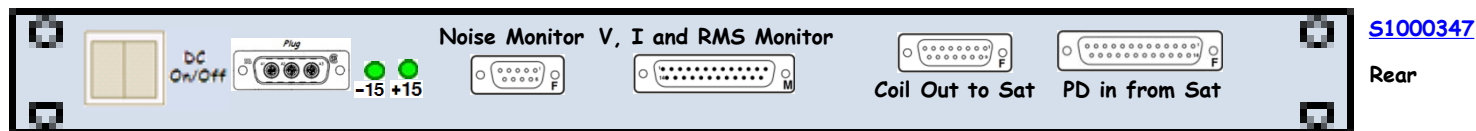
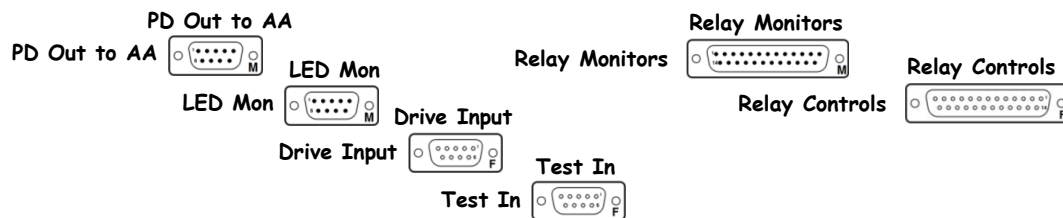
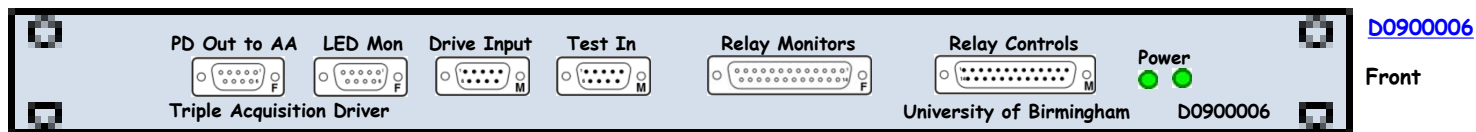

Driver Board: [D0901047](#)
 Monitor Board: [D070480](#)

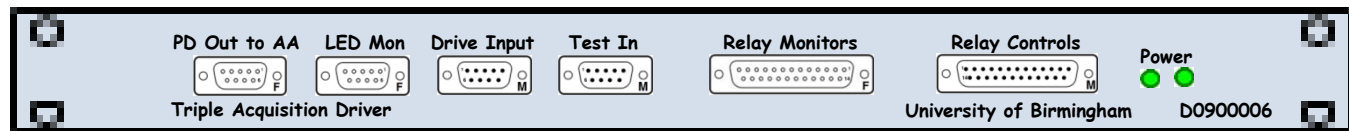

[D0900006](#)

Front

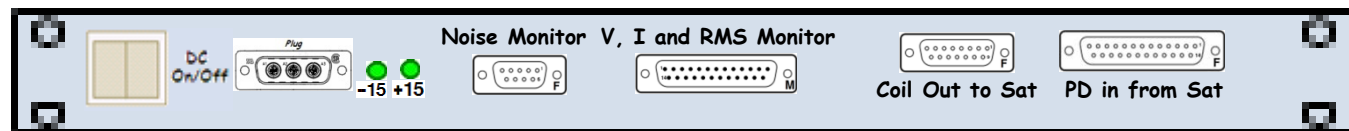
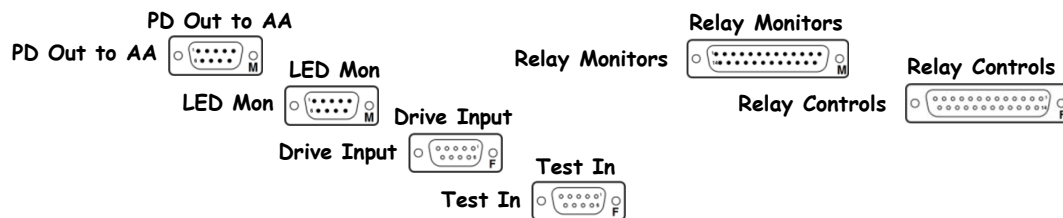

[S1000348](#)

Rear

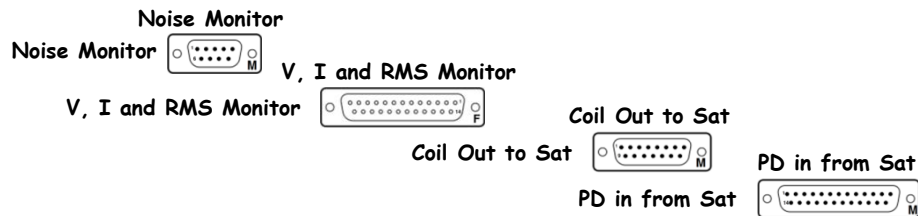

[Driver Board: D0901047](#)
[Monitor Board: D070480](#)

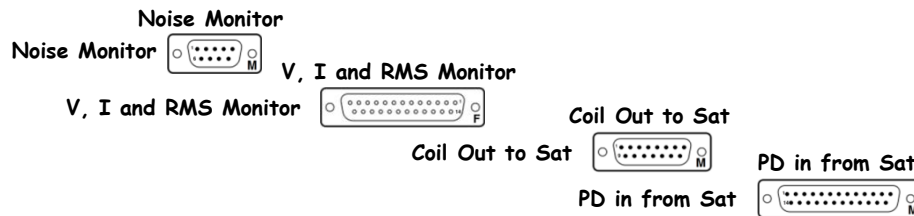
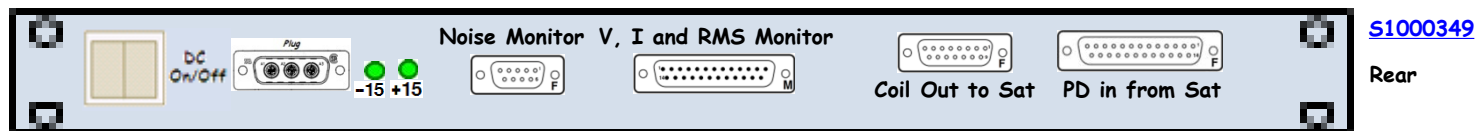
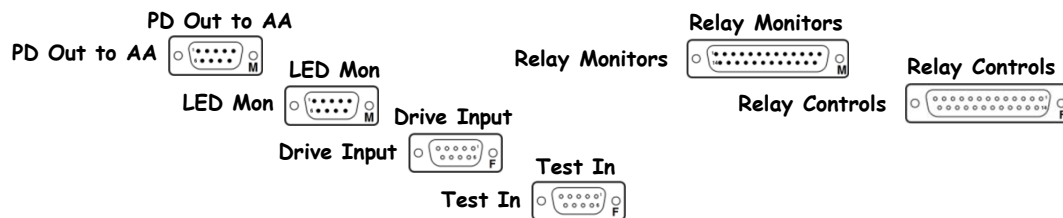
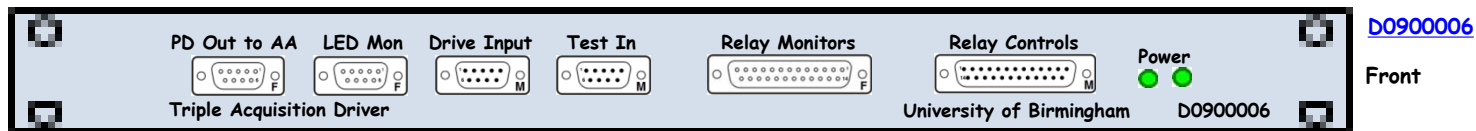

[Driver Board: D0901047](#)
[Monitor Board: D070480](#)

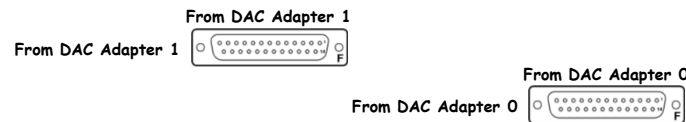
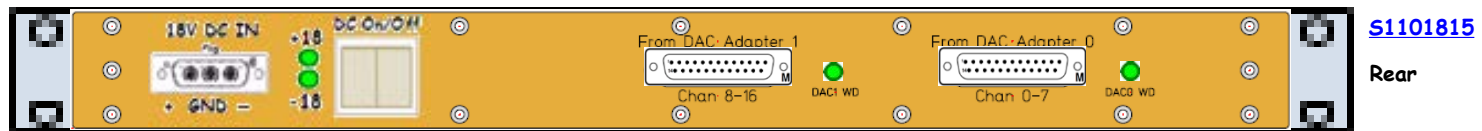
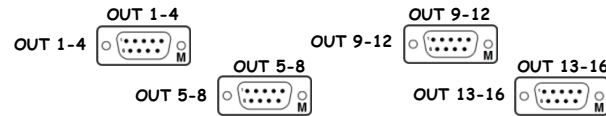
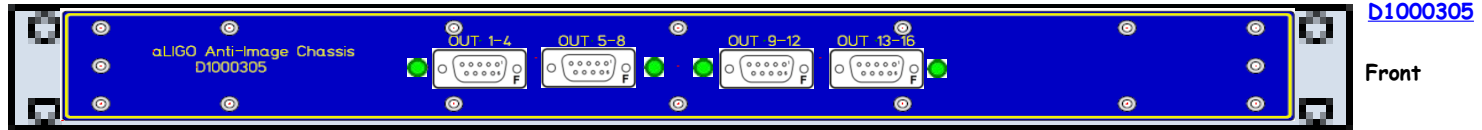

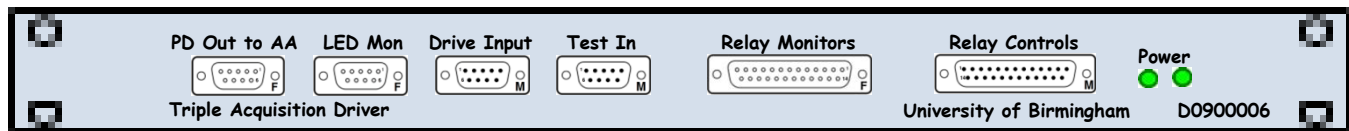

[D0900006](#)

Front

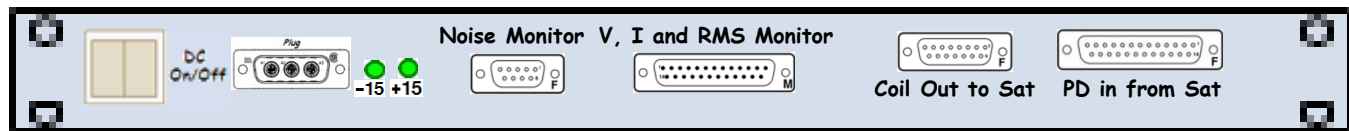
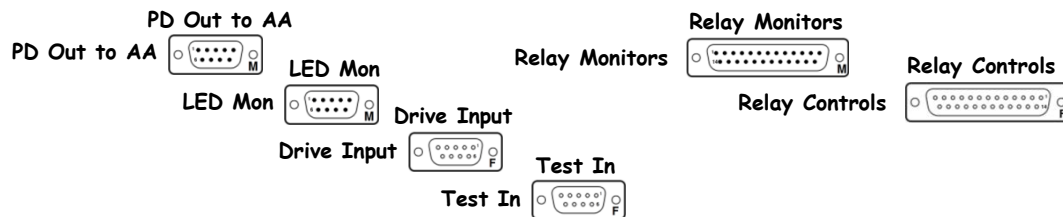

[S1001186](#)

Rear

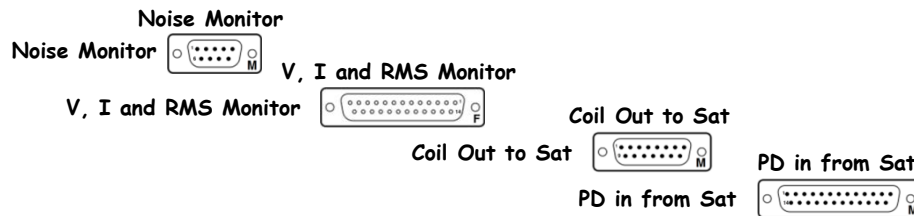

[Driver Board: D0901047](#)
[Monitor Board: D070480](#)

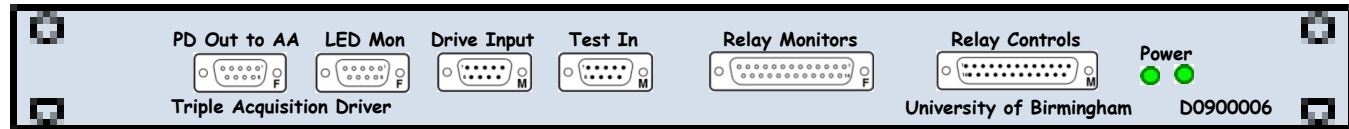

D0900006

Front

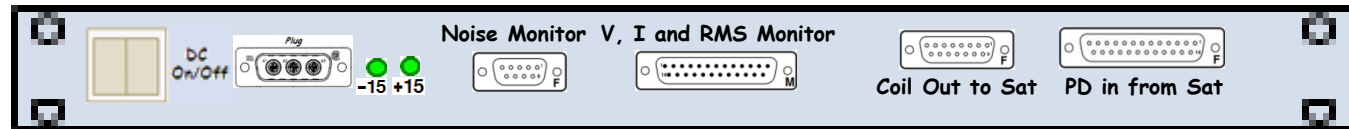
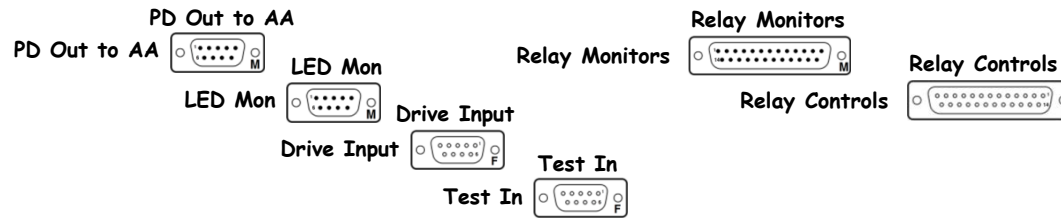

S1001187

Rear

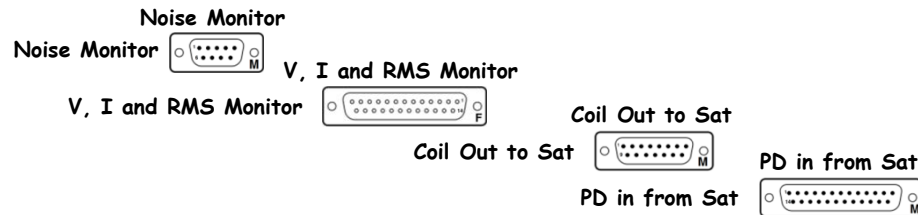

Driver Board: [D0901047](#)
Monitor Board: [D070480](#)

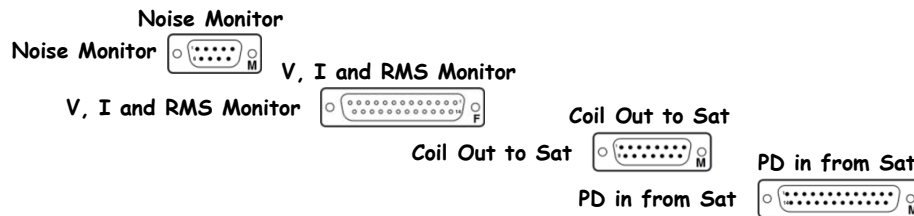
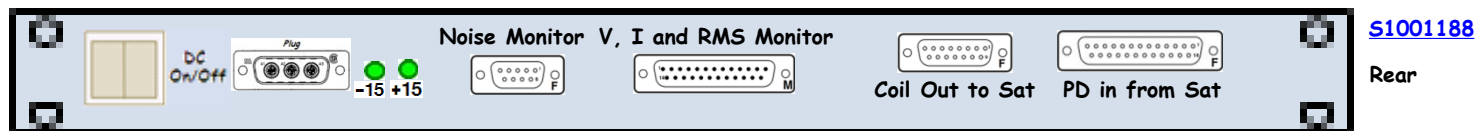
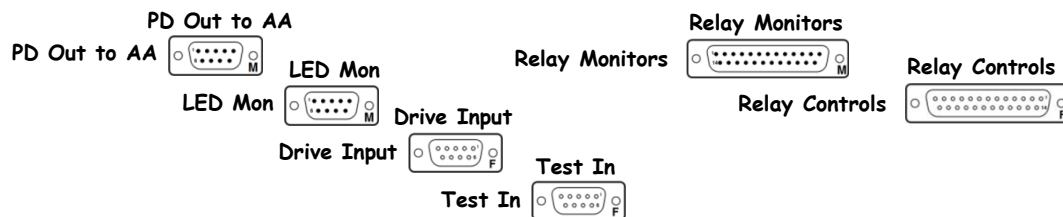
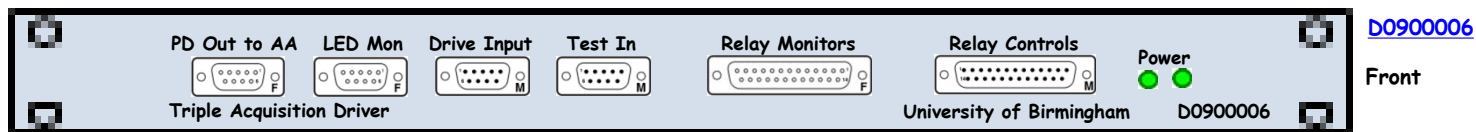

[Driver Board: D0901047](#)
[Monitor Board: D070480](#)

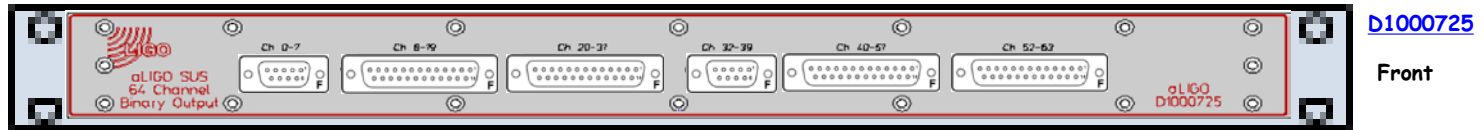

[D1000725](#)

Front

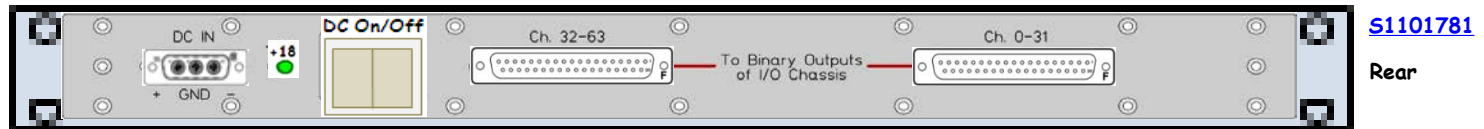
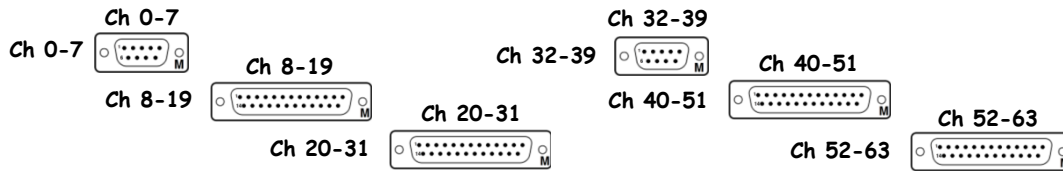

[S1101781](#)

Rear

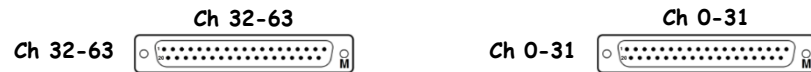

BIO1 Binary Input Chassis D1000726 S1101805 ±18VDC

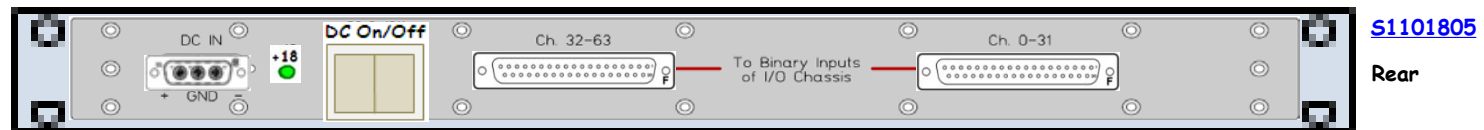
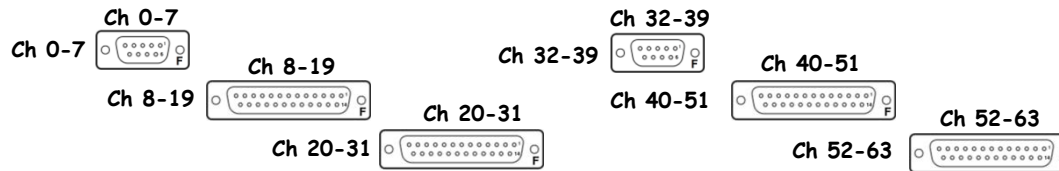
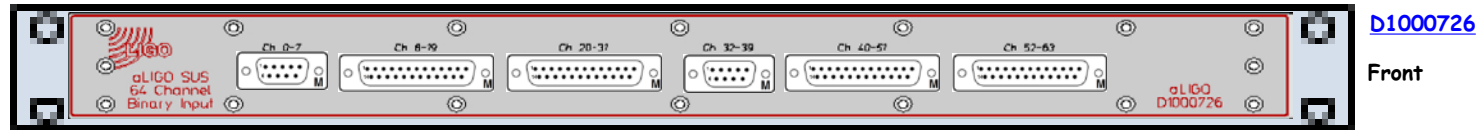

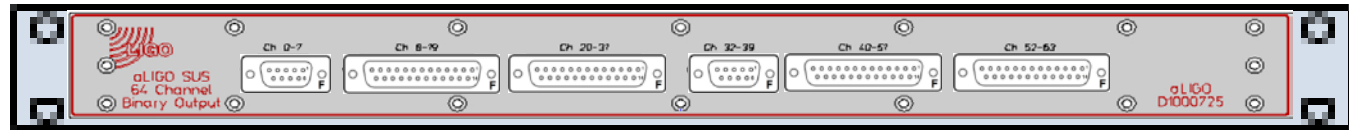

[D1000725](#)

Front

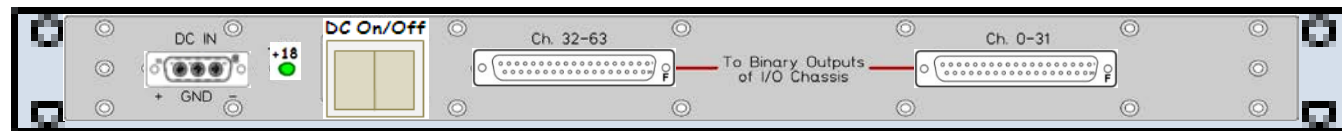
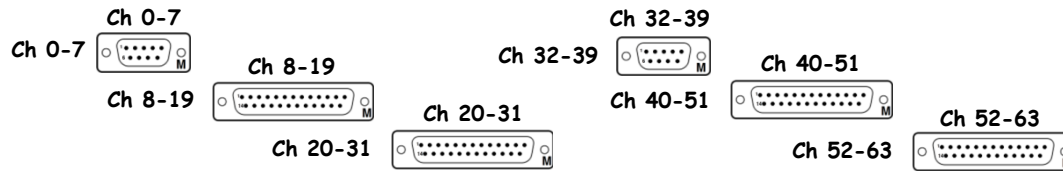

[S1101782](#)

Rear

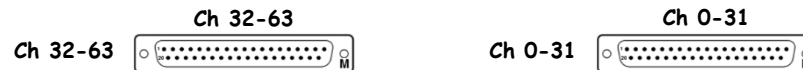

BIO2 Binary Input Chassis D1000726 S1101802 ±18VDC

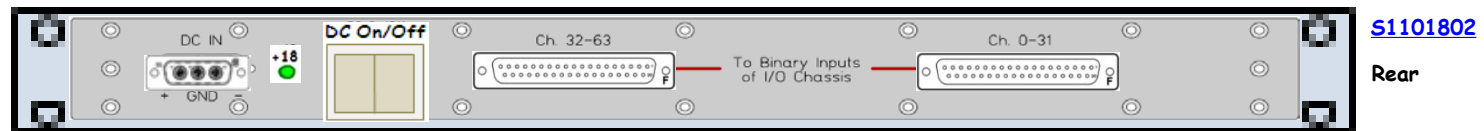
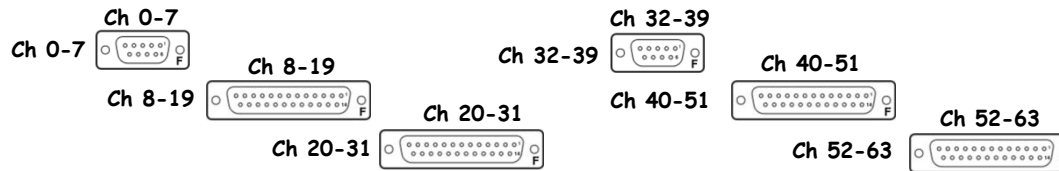
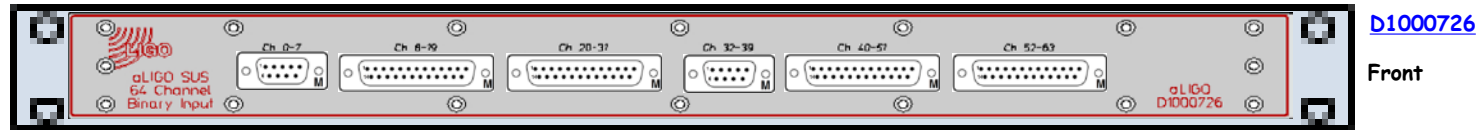

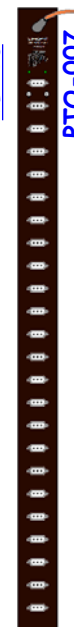
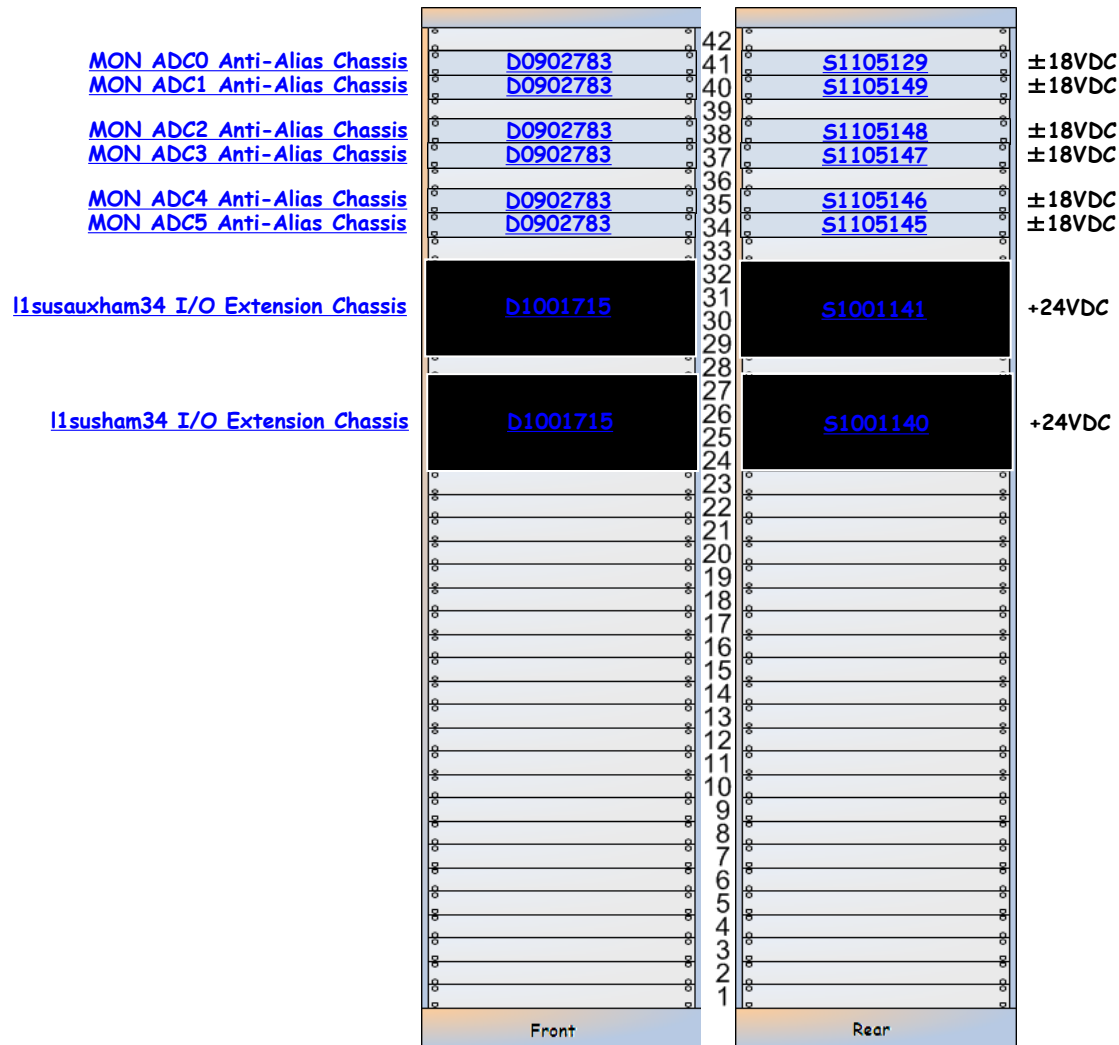

L1-SUS-C2 Details

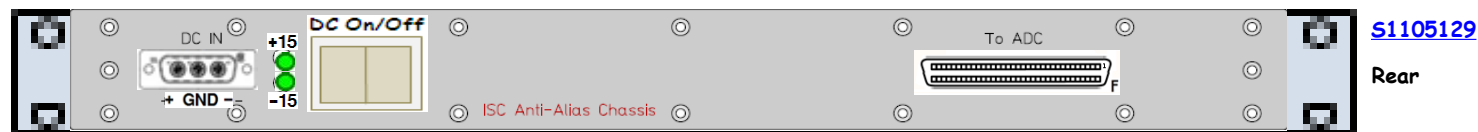
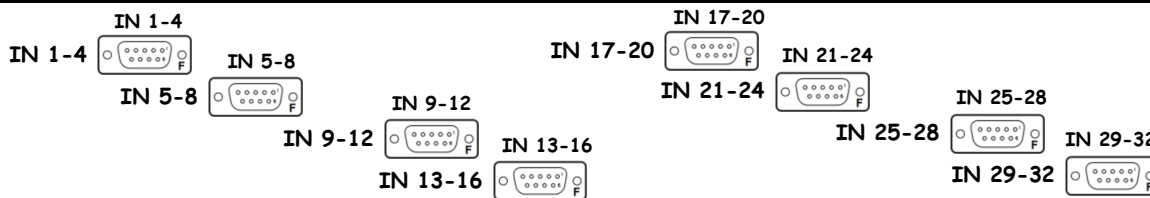
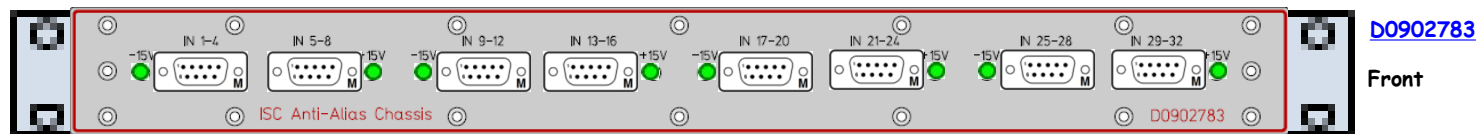

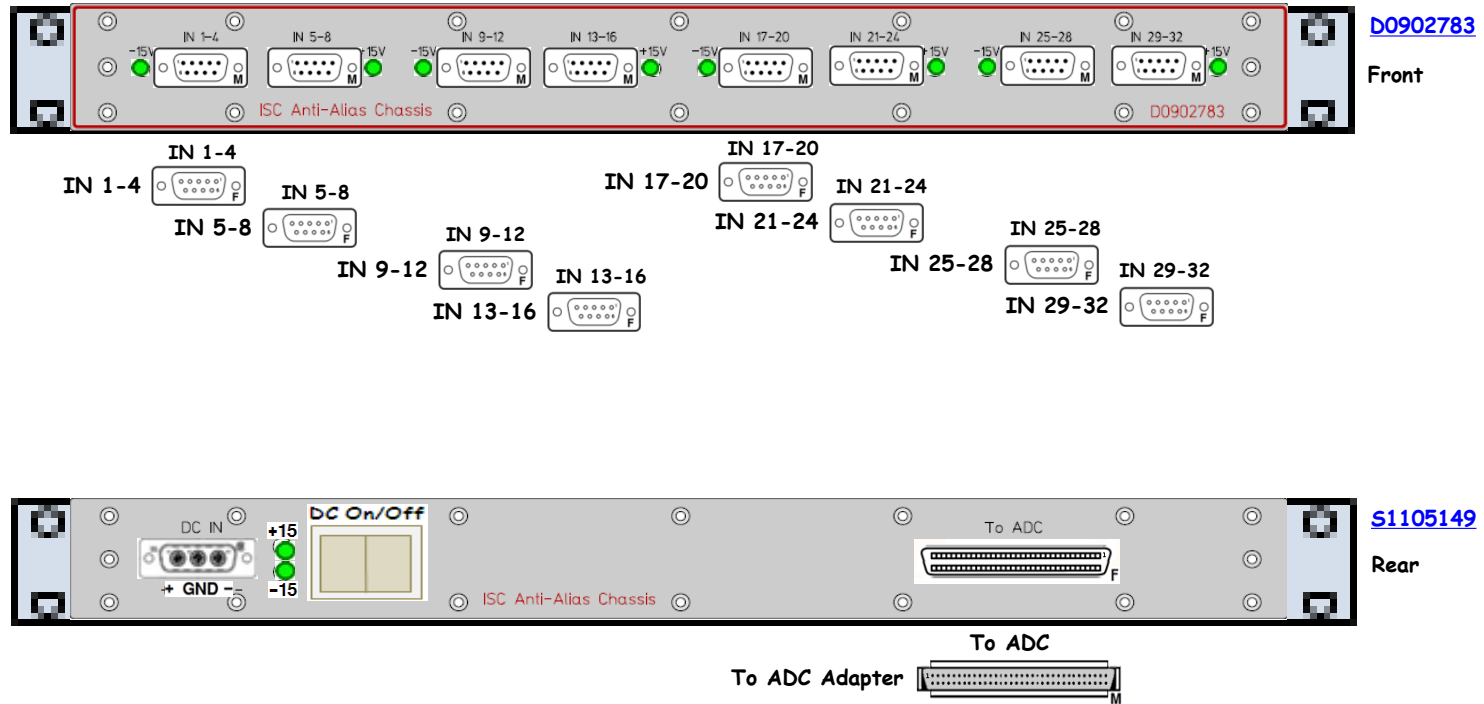

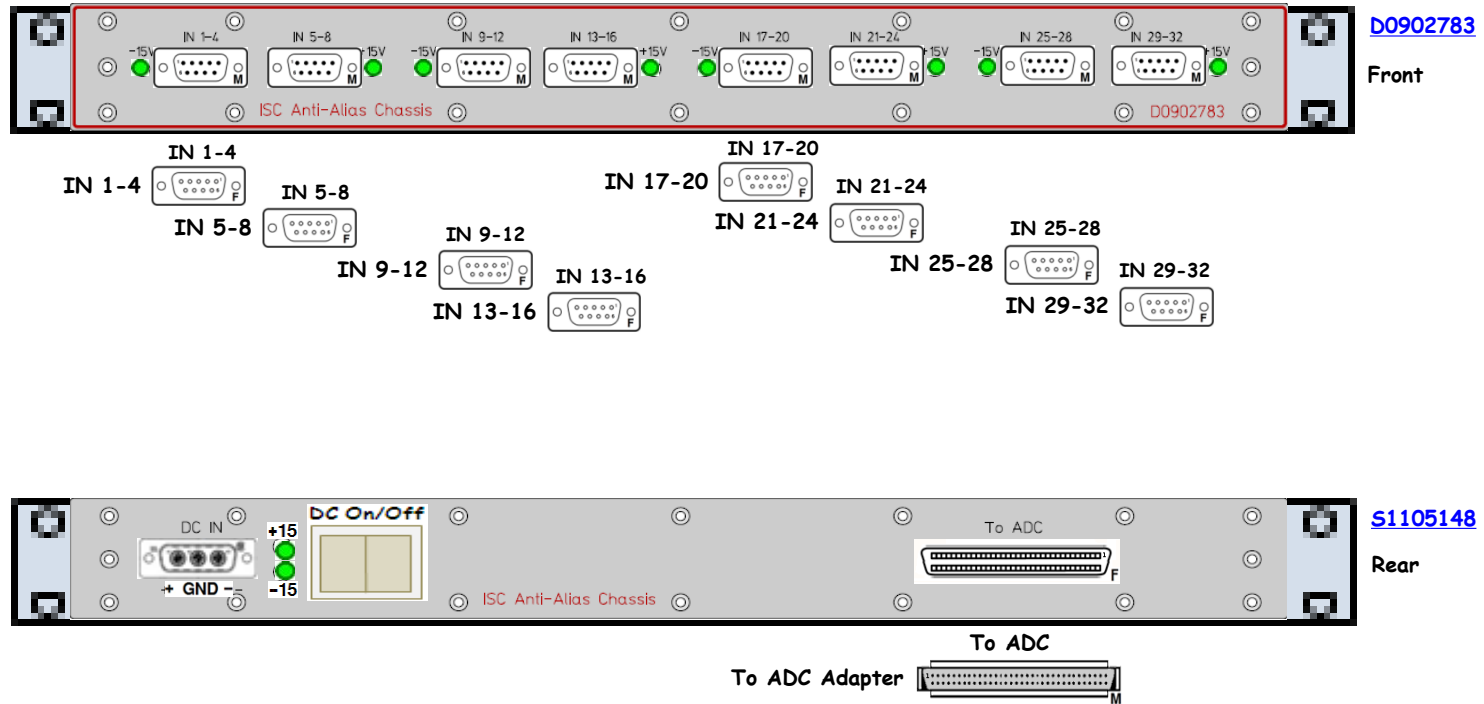

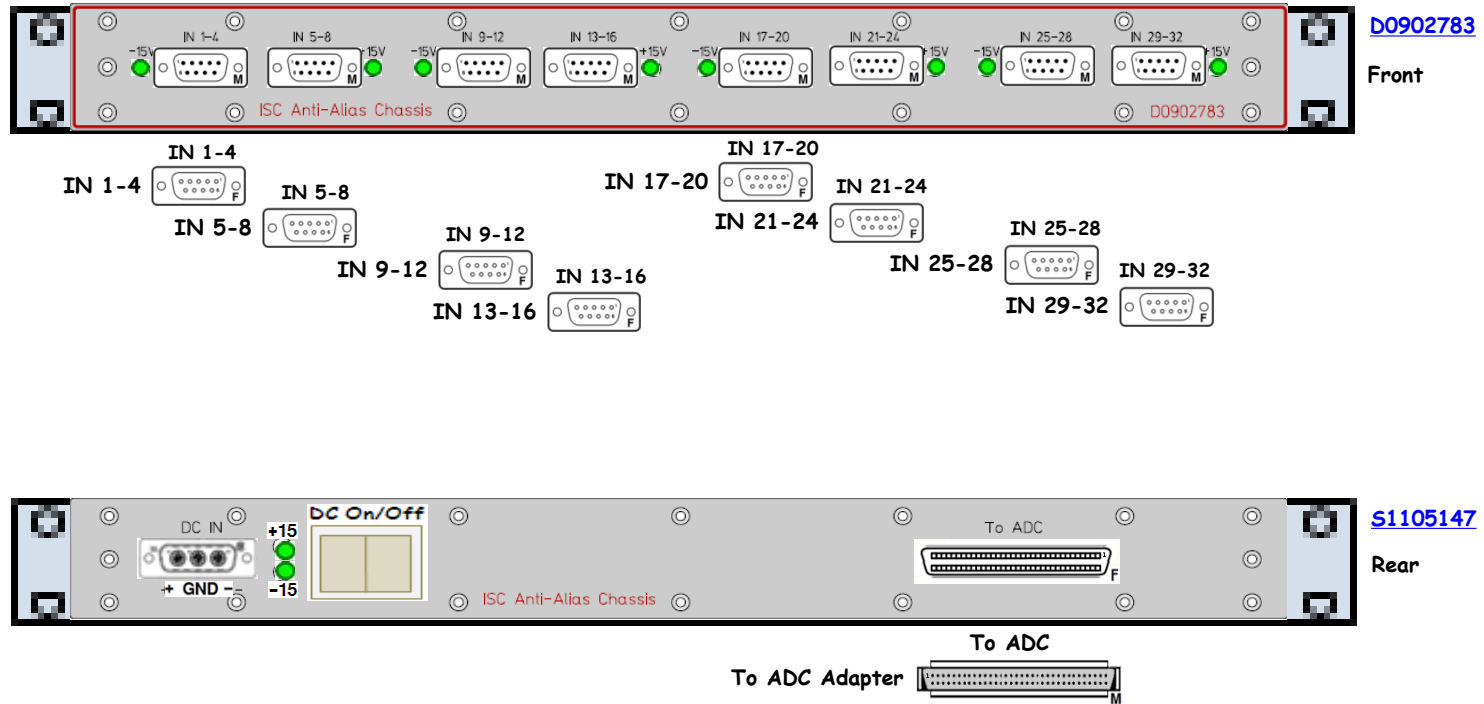

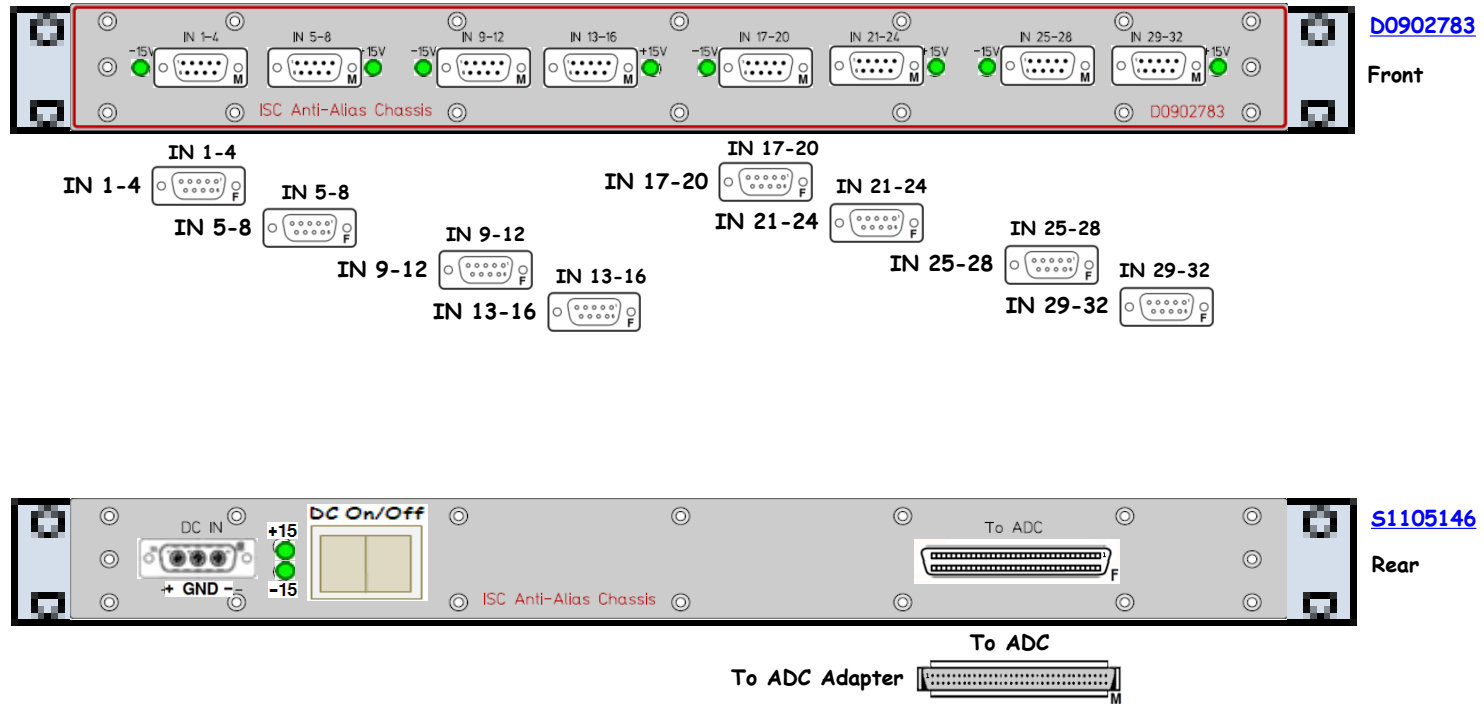

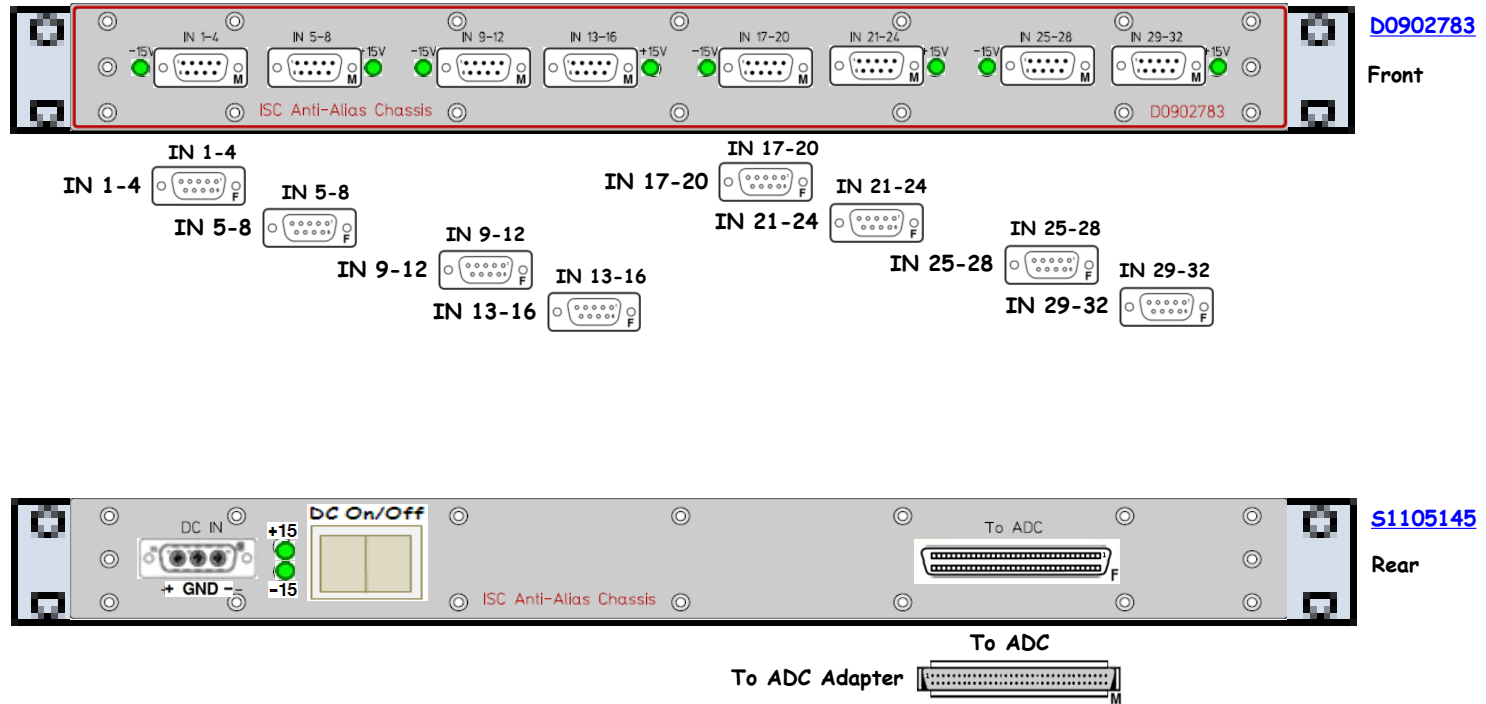



D1001715

Front

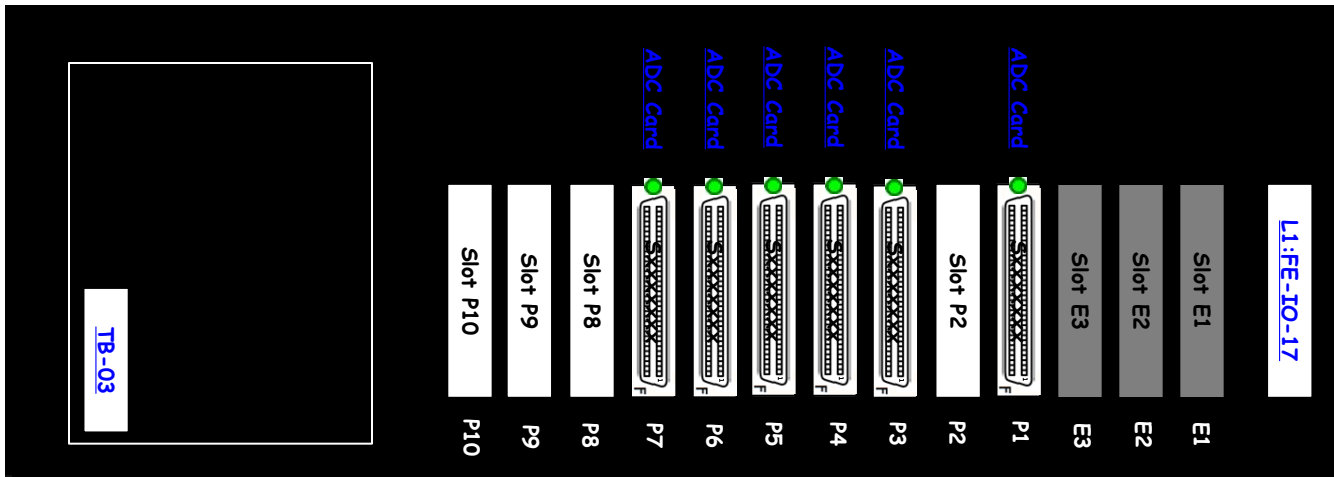

S1001141

Rear

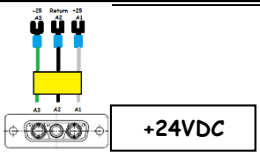
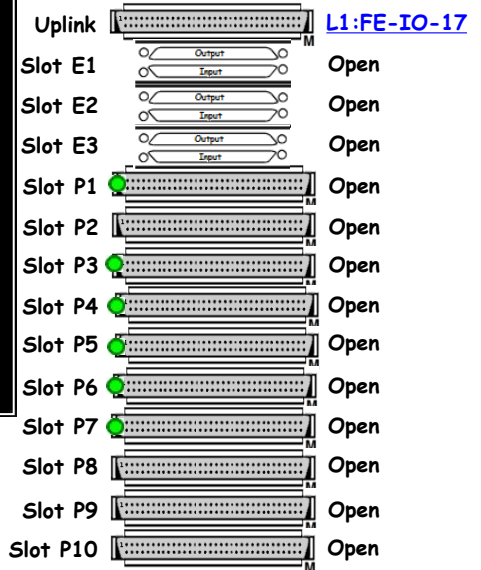



D1001715

Front

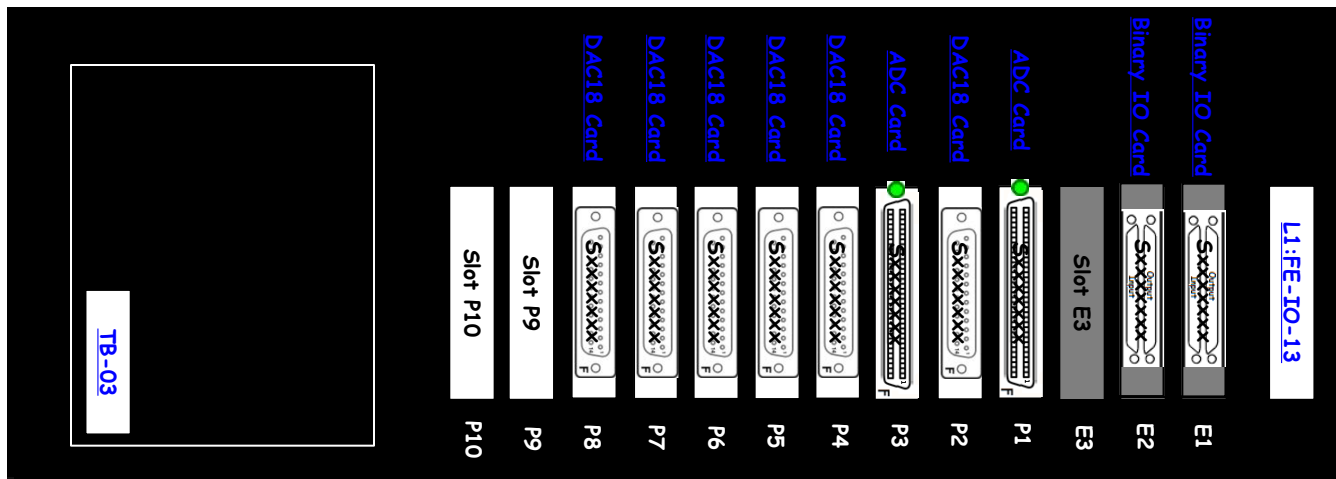

S1001140

Rear

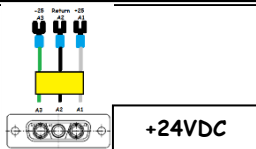
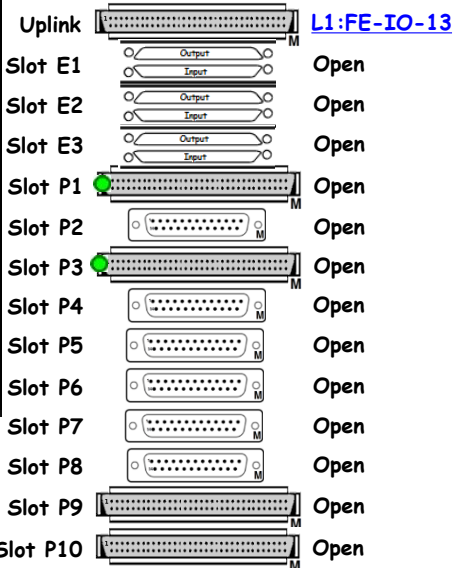

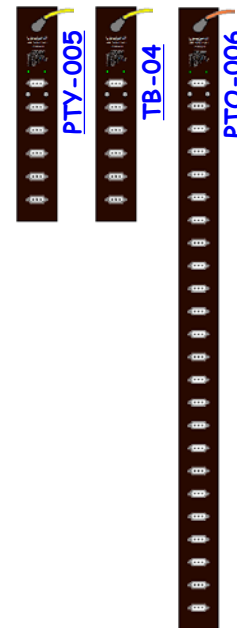
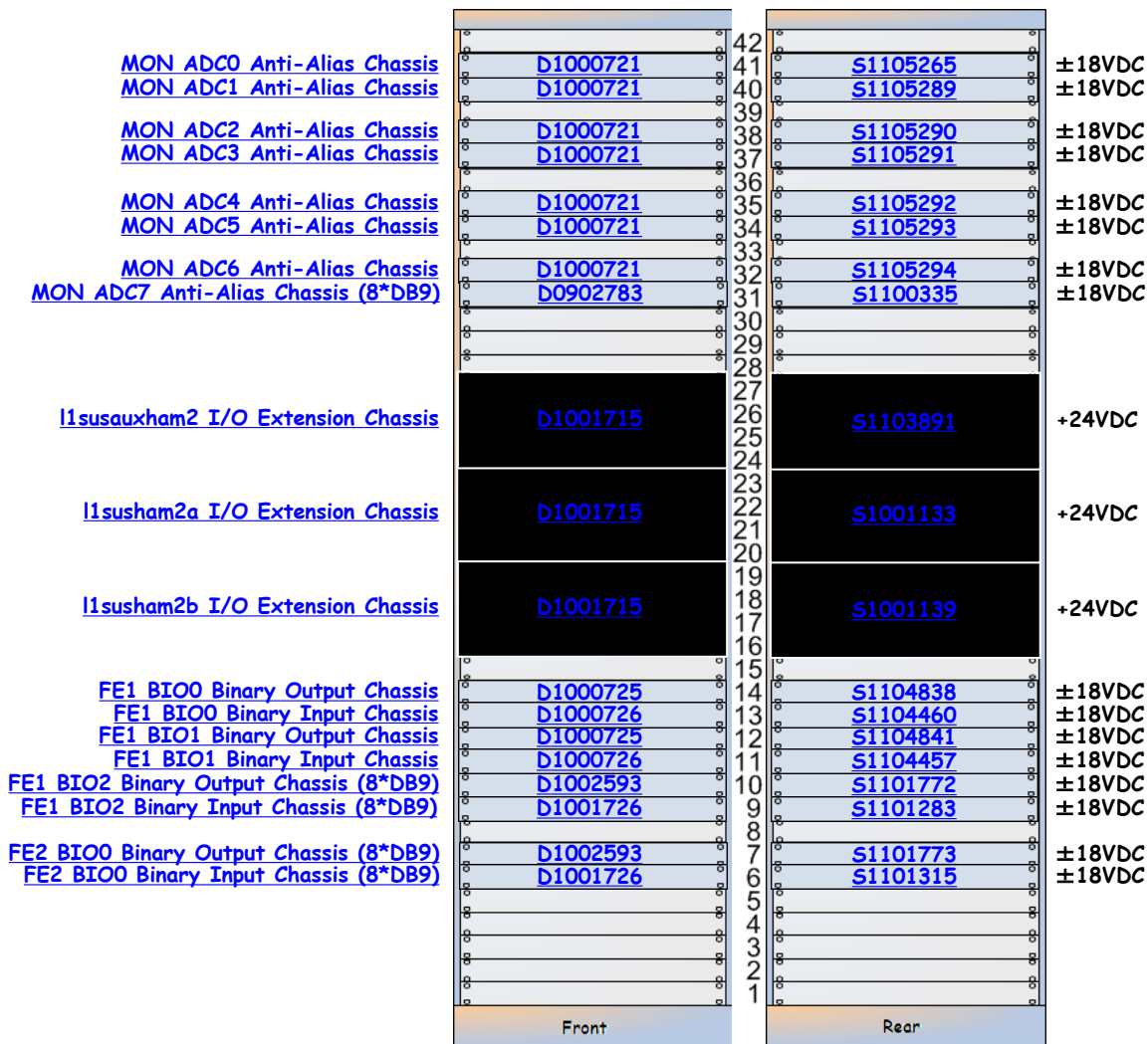

L1-SUS-C3 Details

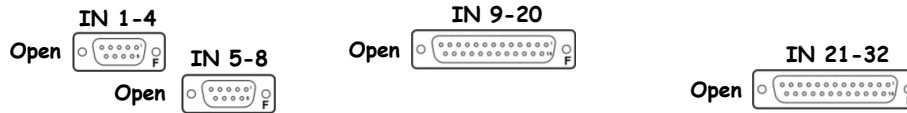

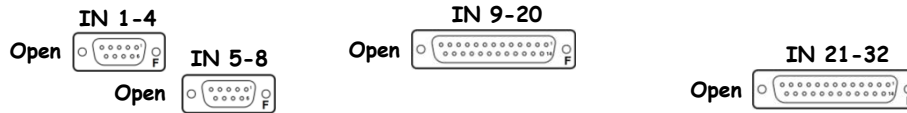

MON ADC2 Anti-Alias Chassis ±18VDC

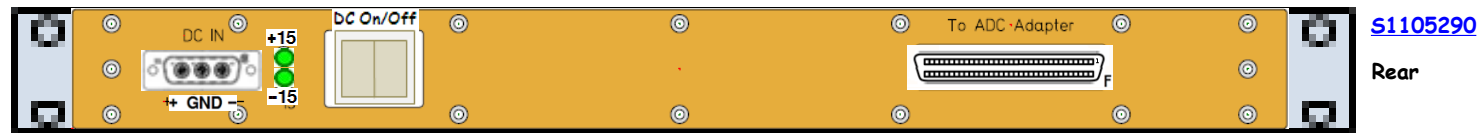
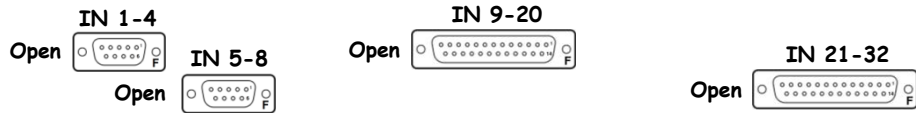
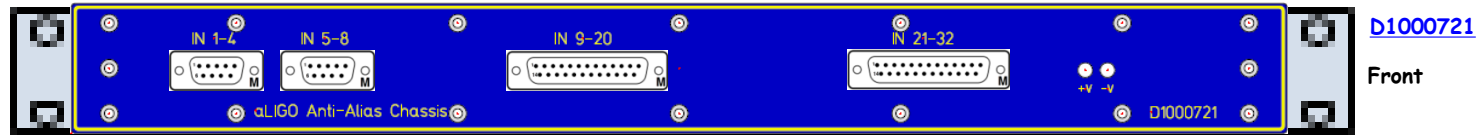

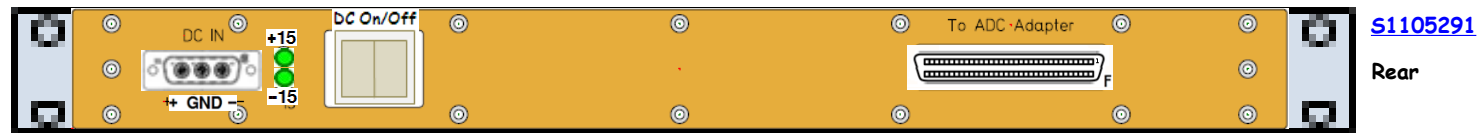
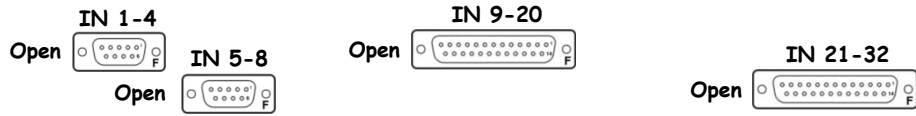
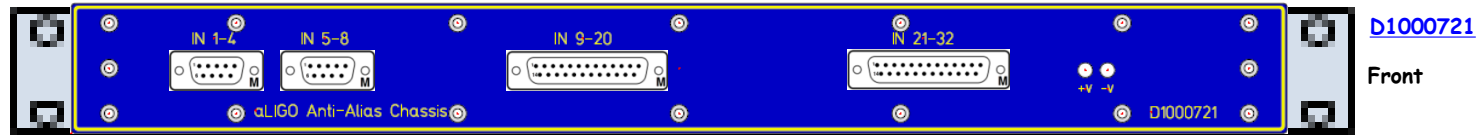

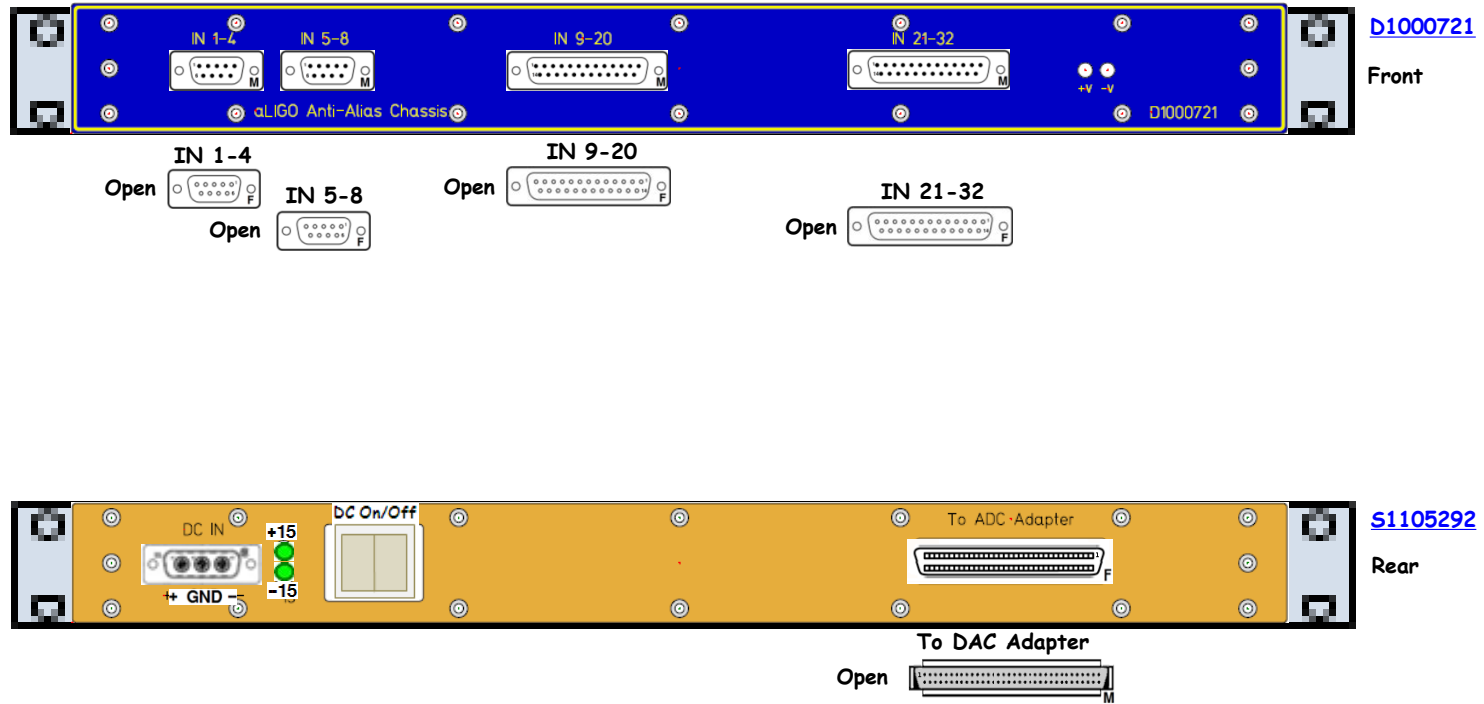

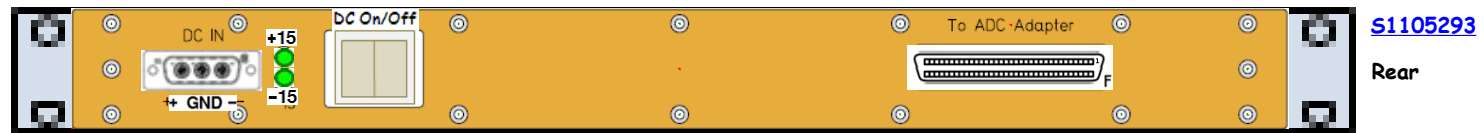
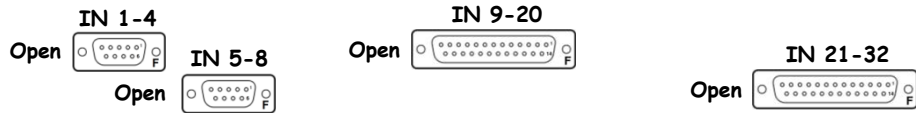
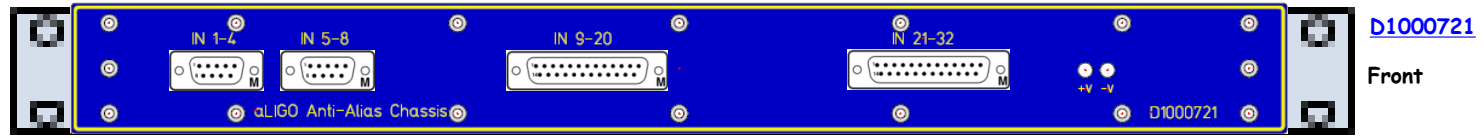

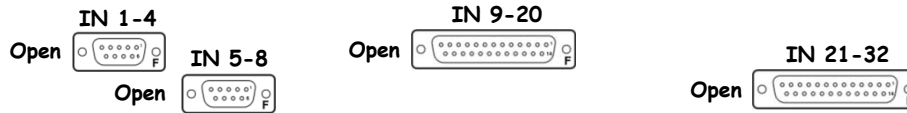

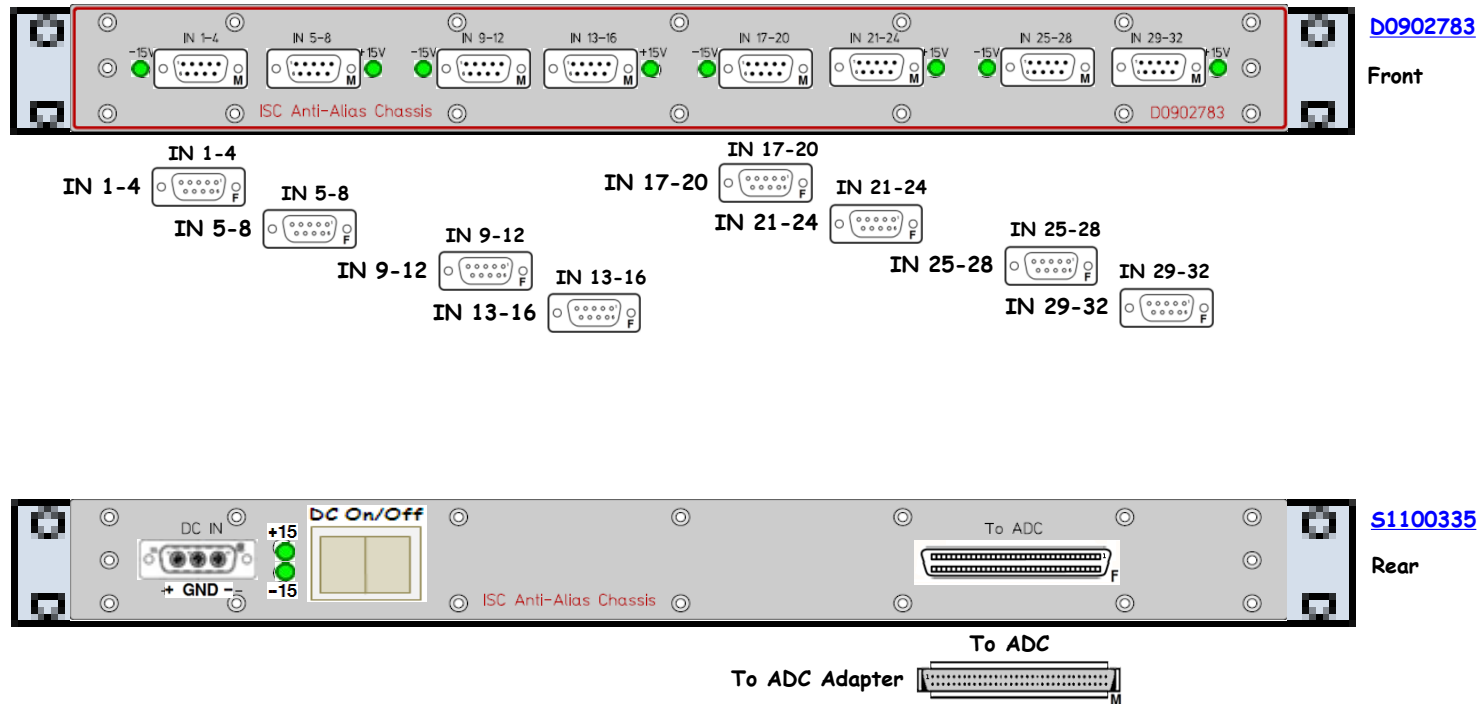



D1001715

Front

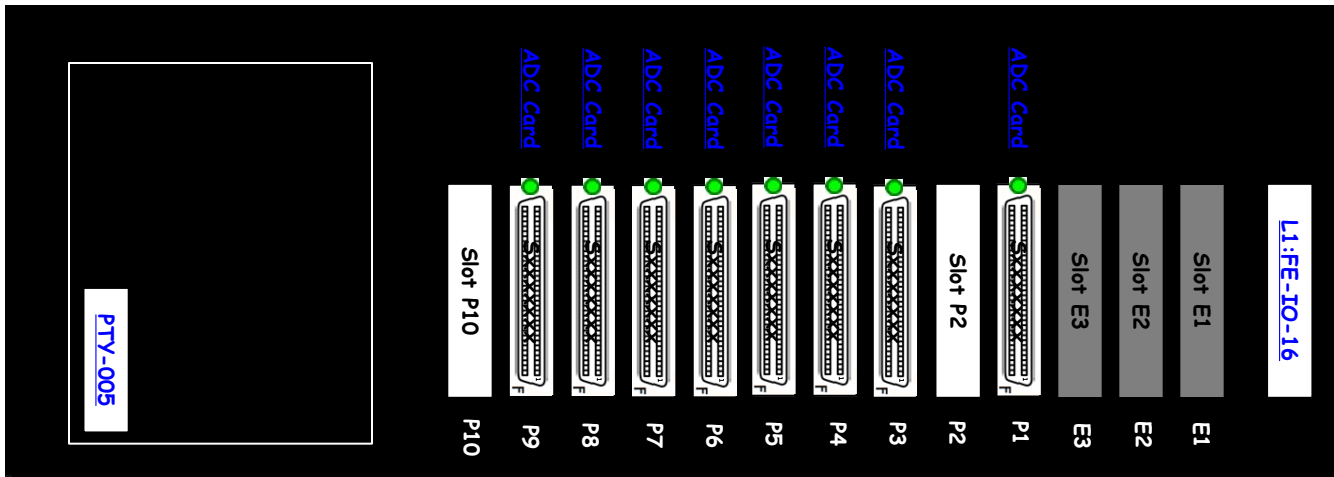

S1003891

Rear

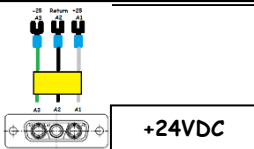
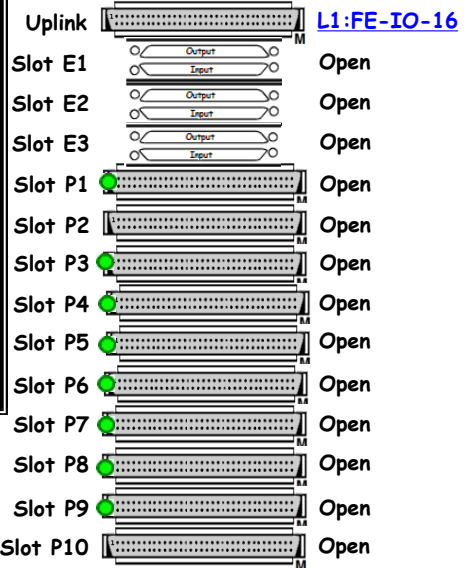



D1001715

Front

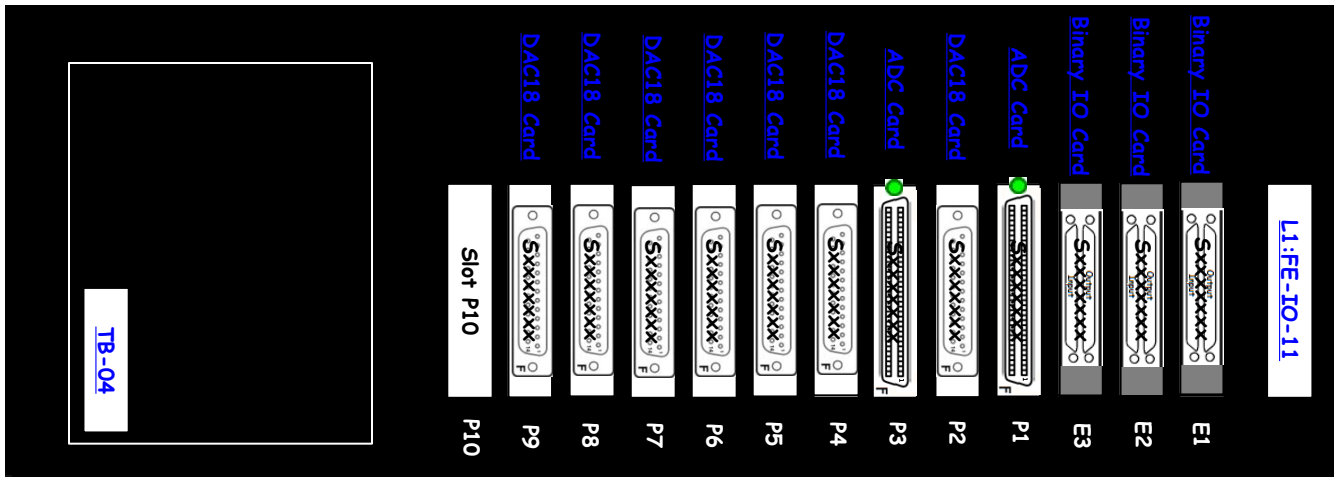

S1001133

Rear

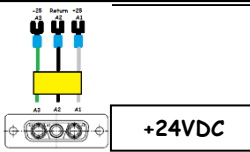
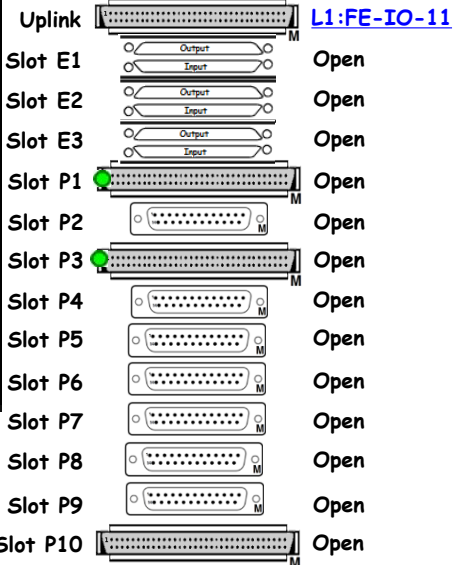

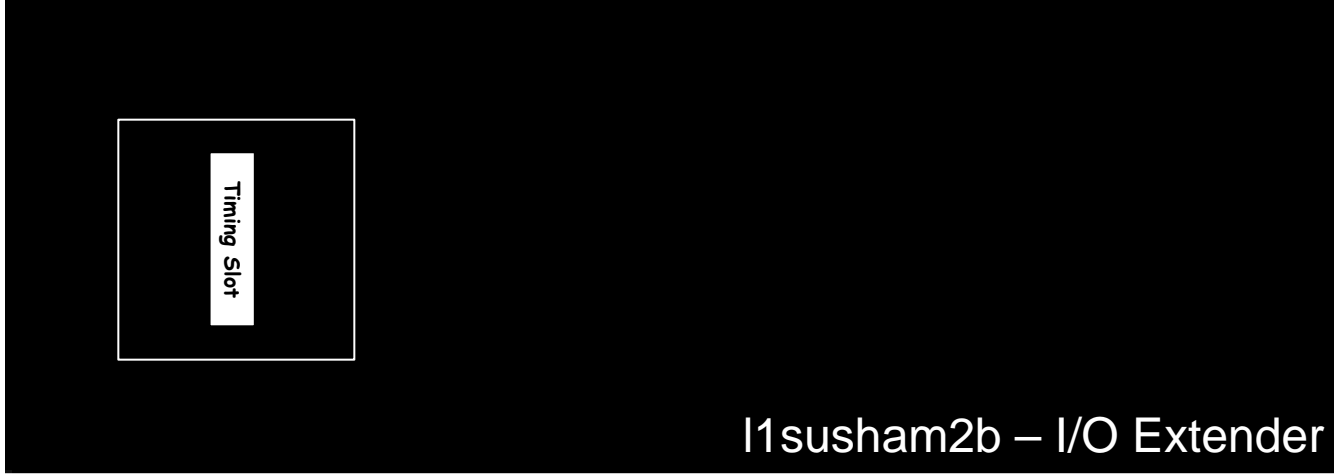

[D1001715](#)

Front

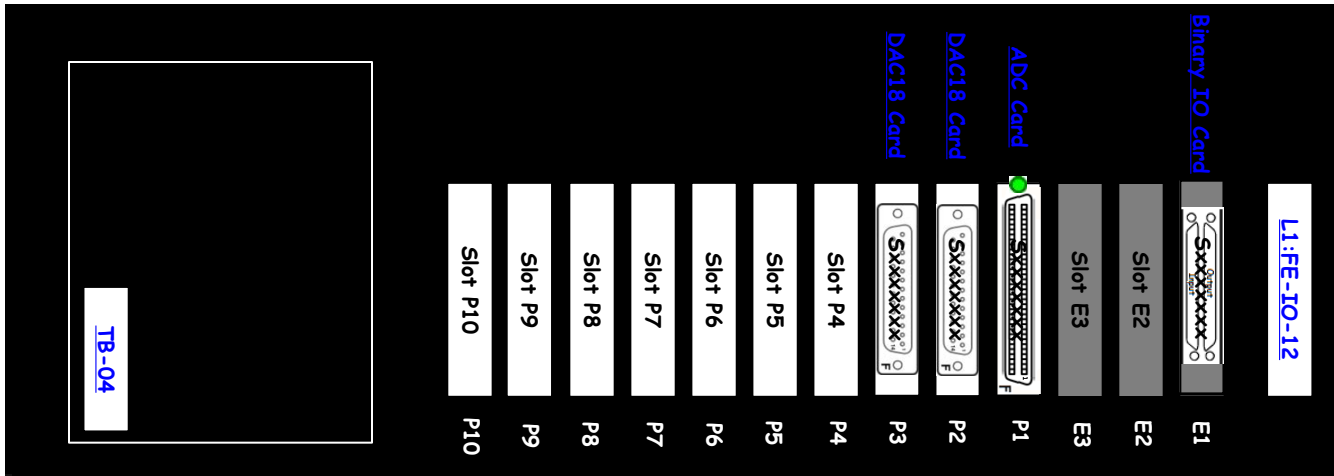

[S1001139](#)

Rear

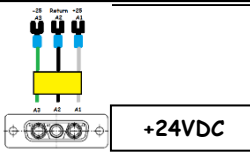
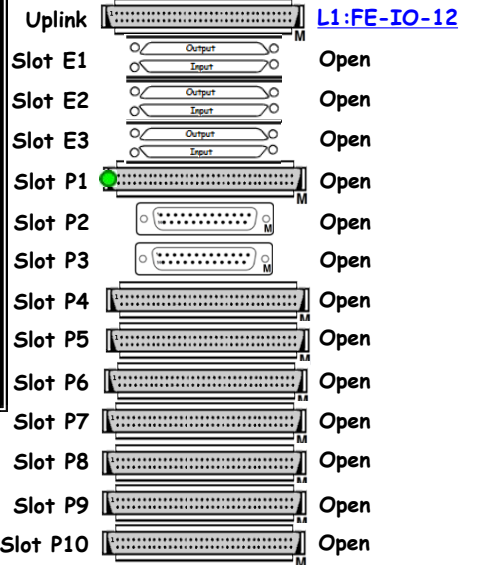

FE1 BIO0 Binary Output Chassis D1000725 S1104838 ±18VDC

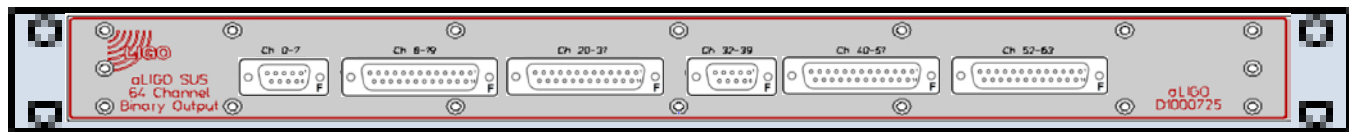

[D1000725](#)

Front

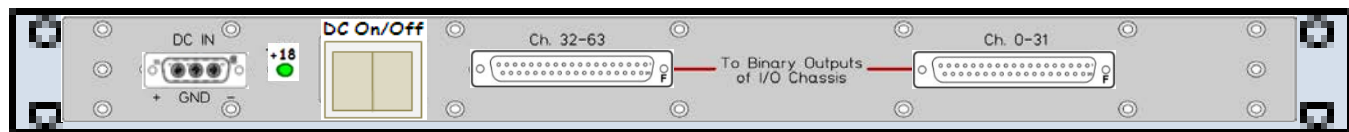
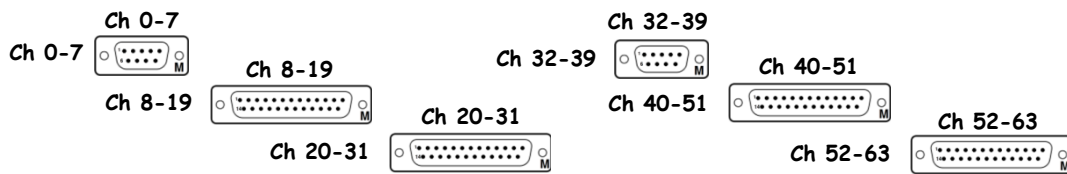

[S1104838](#)

Rear



D1000726 - S1104460



<< L1-SUS-C3

FE1 BIO0 Binary Input Chassis D1000726 S1104460 ±18VDC

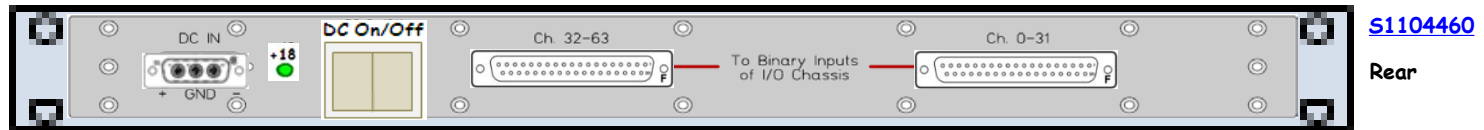
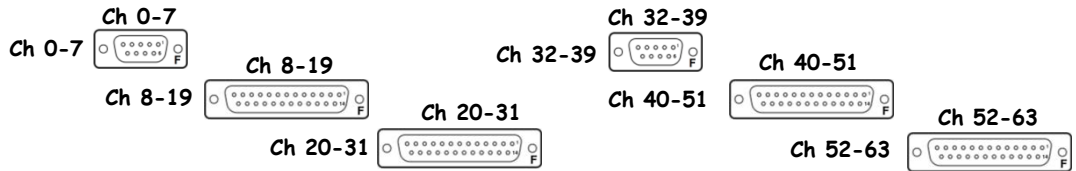
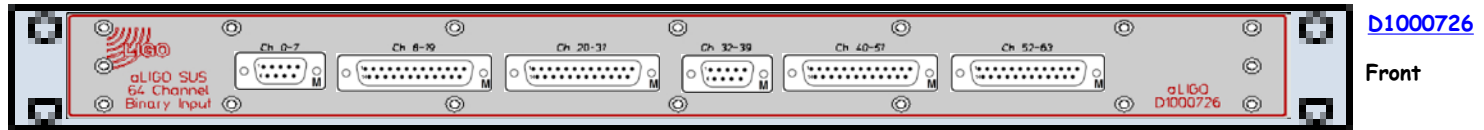

FE1 BIO1 Binary Output Chassis D1000725 S1104841 ±18VDC

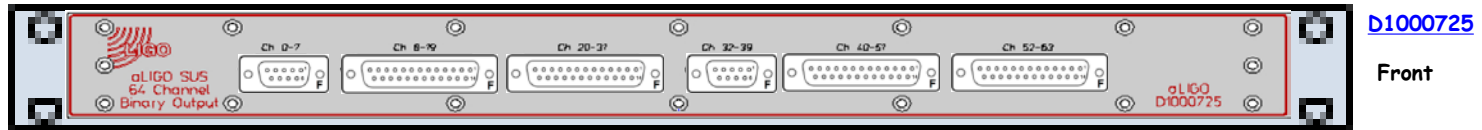

[D1000725](#)

Front

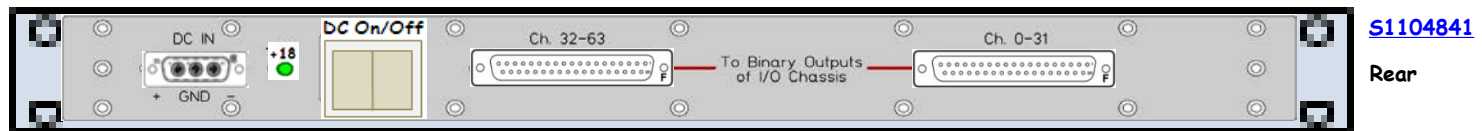
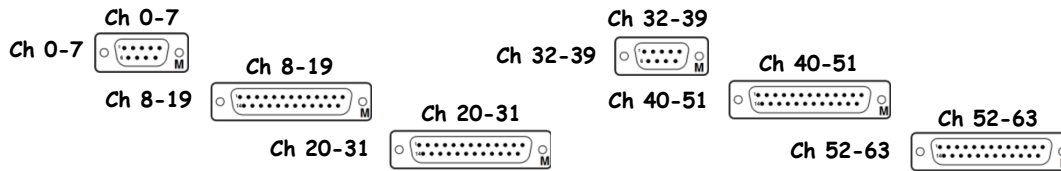

[S1104841](#)

Rear



D1000726 - S1104457



<< L1-SUS-C3

FE1 BIO1 Binary Input Chassis D1000726 S1104457 ±18VDC

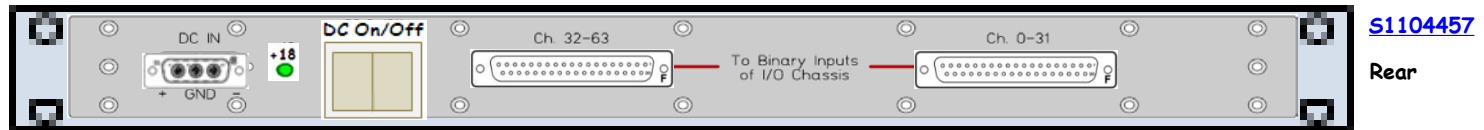
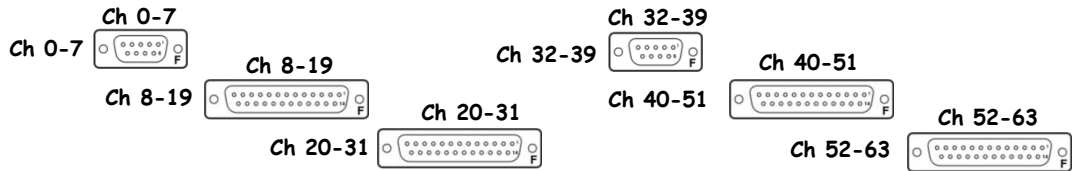
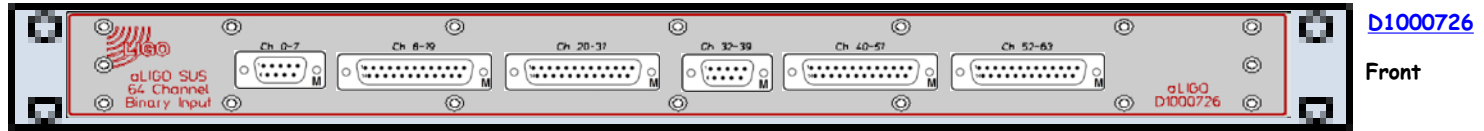

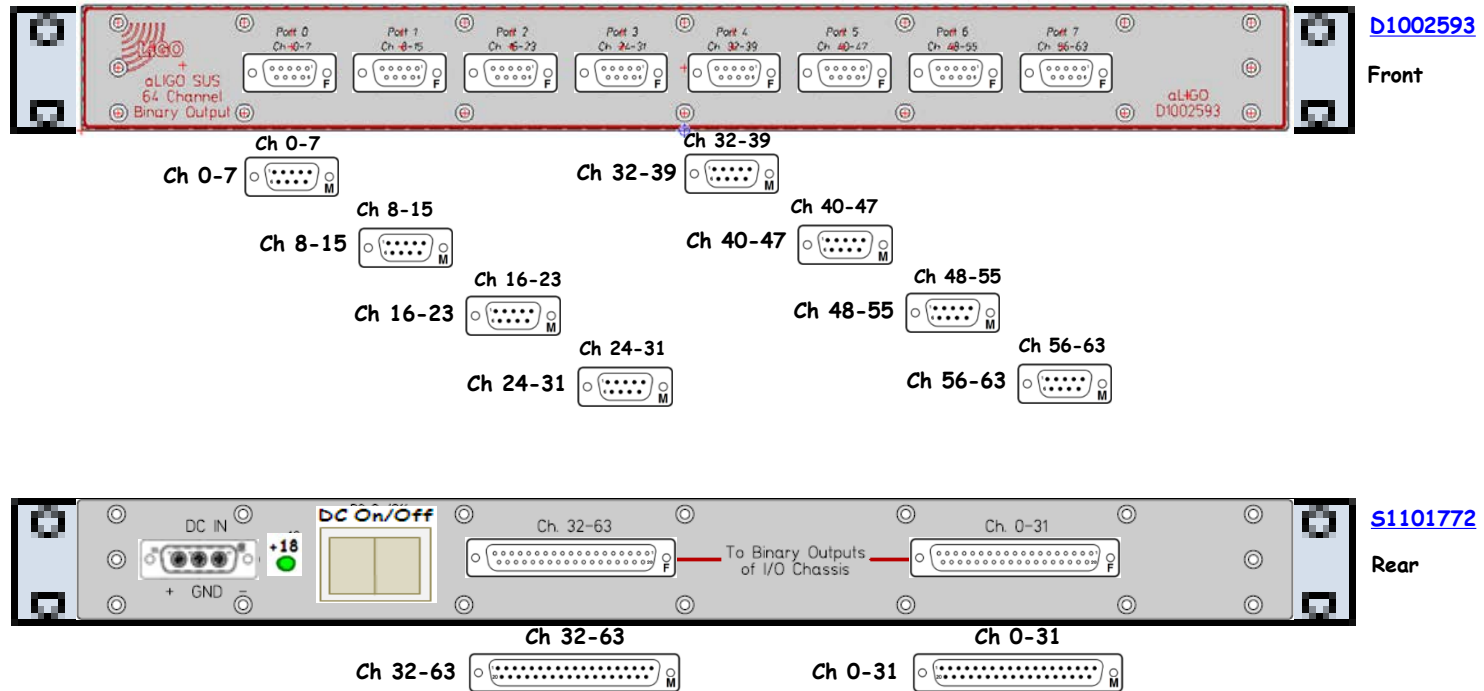

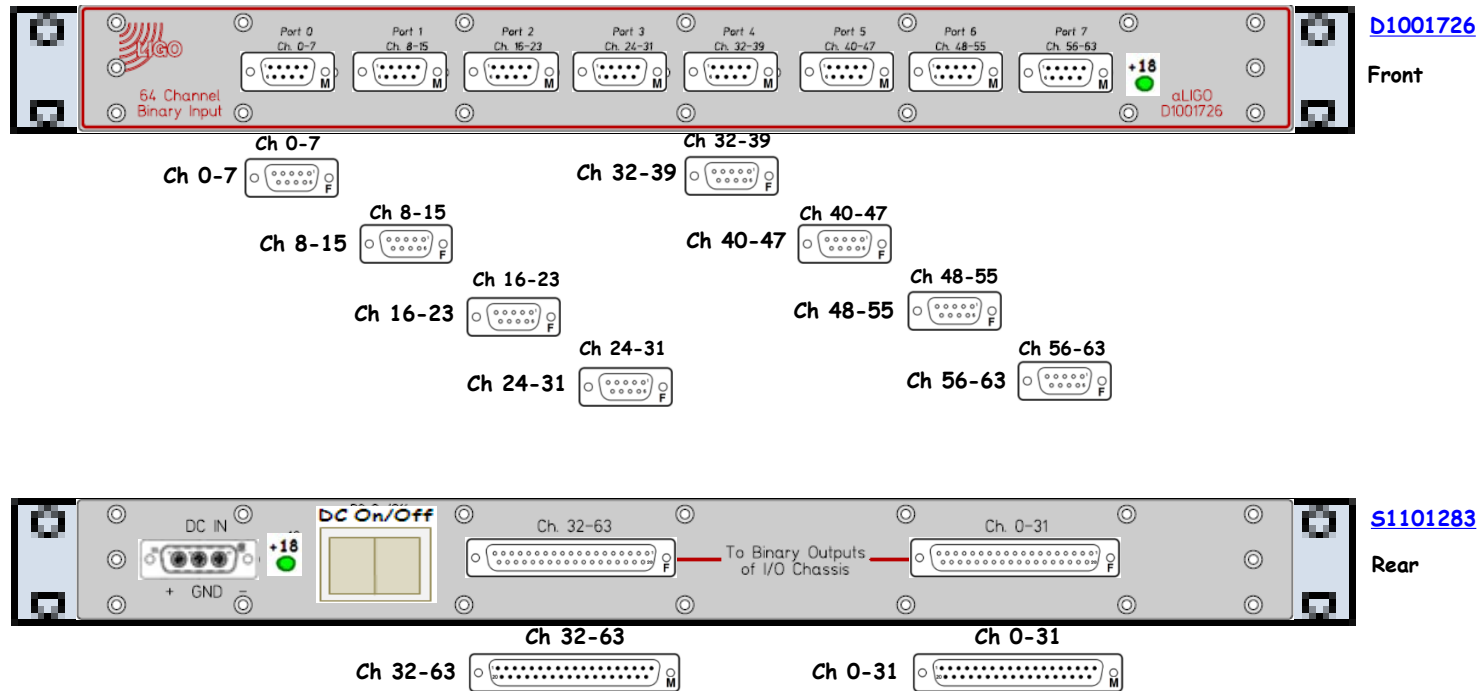

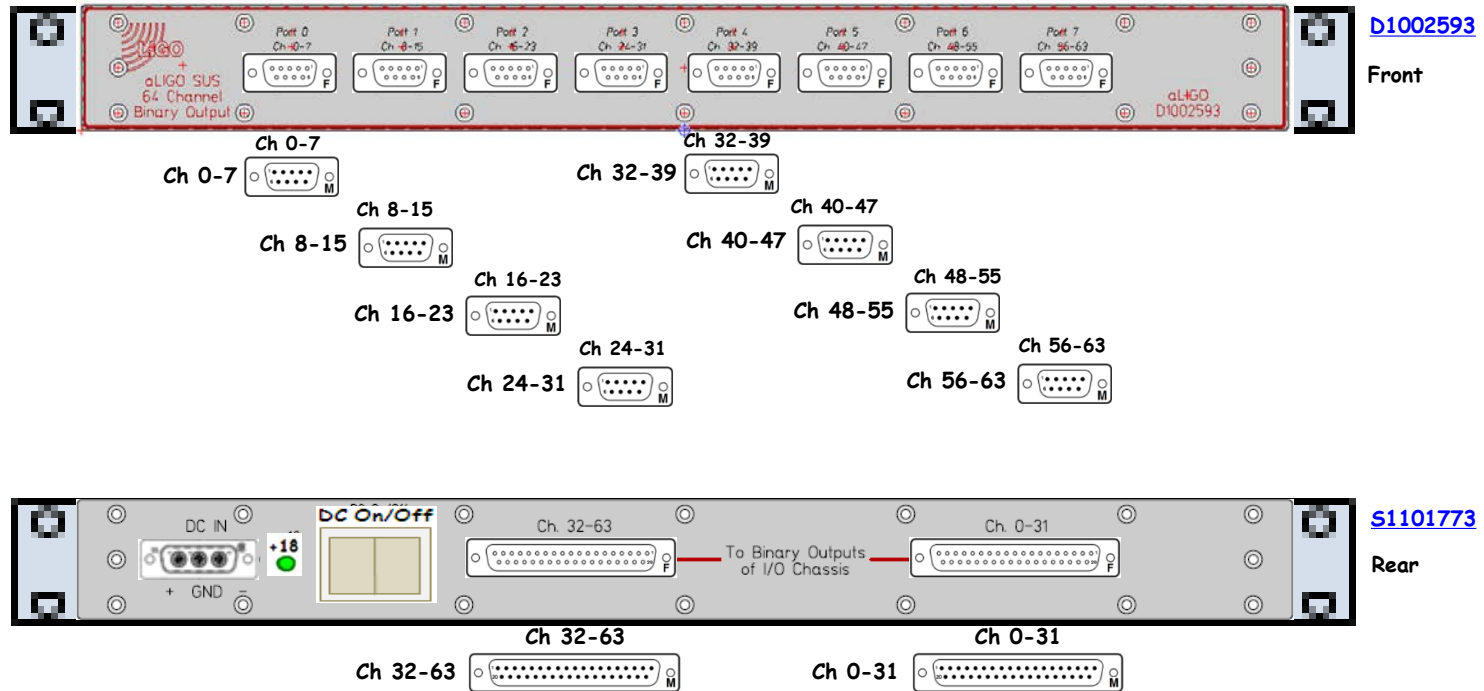

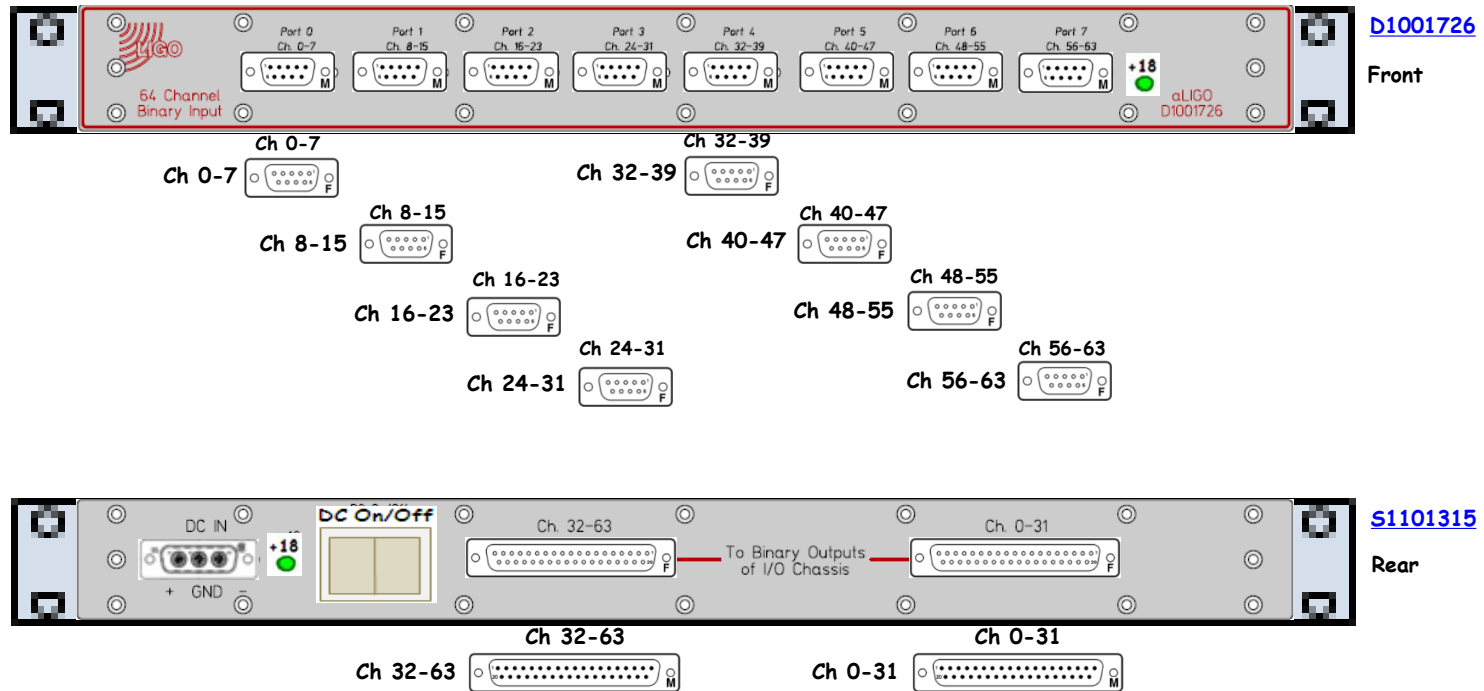

<< CER

SUS HAM2 Rack 2 (of 2) Layout ([D0902810](#)) ([S1104358](#))

		42				
MC1-MC3 Triple Top Coil Driver Chassis	D1001242	41	S1000253		± 18 VDC	
MC1-MC3 Triple Top Coil Driver Chassis	D1001242	40	S1000261		± 18 VDC	
MC1-MC3 Triple Top Coil Driver Chassis	D1001242	39	S1000262		± 18 VDC	
		38				
PRM-PR3 Triple Top Coil Driver Chassis	D1001242	37	S1000257		± 18 VDC	
PRM-PR3 Triple Top Coil Driver Chassis	D1001242	36	S1000726		± 18 VDC	
PRM-PR3 Triple Top Coil Driver Chassis	D1001242	35	S1000723		± 18 VDC	
		34				
FE1 ADC0 Anti-Alias Chassis (8*DB9)	D0902783	33	S1100332		± 18 VDC	
FE1 ADC1 Anti-Alias Chassis (8*DB9)	D0902783	32	S1100333		± 18 VDC	
		31				
FE1 DAC0, FE1 DAC1 Anti-Image Chassis	D1000305	30	S1105313		± 18 VDC	
FE1 DAC2, FE1 DAC3 Anti-Image Chassis	D1000305	29	S1001200		± 18 VDC	
		28				
MC1 Mid Triple Acq Driver Chassis	D0900006	27	S1001112		± 18 VDC	
MC1 Bot Triple Acq Driver Chassis	D0900006	26	S1000352		± 18 VDC	
MC3 Mid Triple Acq Driver Chassis	D0900006	25	S1000353		± 18 VDC	
MC3 Bot Triple Acq Driver Chassis	D0900006	24	S1000354		± 18 VDC	
		23				
FE1 DAC4, FE1 DAC5 Anti-Image Chassis	D1000305	22	S1104363		± 18 VDC	
FE1 DAC6 Anti-Image Chassis	D1000305	21	S1101806		± 18 VDC	
		20				
PRM Mid Triple Acq Driver Chassis	D0900006	19	S1001103		± 18 VDC	
PRM Bot Triple Acq Driver Chassis	D0900006	18	S1001191		± 18 VDC	
PR3 Mid Triple Acq Driver Chassis	D0900006	17	S1001192		± 18 VDC	
PR3 Bot Triple Acq Driver Chassis	D0900006	16	S1001193		± 18 VDC	
		15				
SM1 8-Channel Coil Driver Chassis	D1100687	14	S1200590		± 18 VDC	
SM2 8-Channel Coil Driver Chassis	D1100687	13	S1200589		± 18 VDC	
		12				
FE2 ADC0 Anti-Alias Chassis	D0902783	11	S1200818		± 18 VDC	
FE2 DAC0 Anti-Image Chassis	D1000305	10	S1101807		± 18 VDC	
		9				
PMMT1 8-Channel Coil Driver Chassis	D1100687	8	S1200585		± 18 VDC	
PMMT2 8-Channel Coil Driver Chassis	D1100687	7	S1200617		± 18 VDC	
		6				
		5				
		4				
		3				
		2				
		1				
	Front		Rear			



L1-SUS-C4 Details

D1001242 - S1000253



<< L1-SUS-C4

MC1-MC3 Triple Top Coil Driver Chassis D1001242 S1000253 ±18VDC

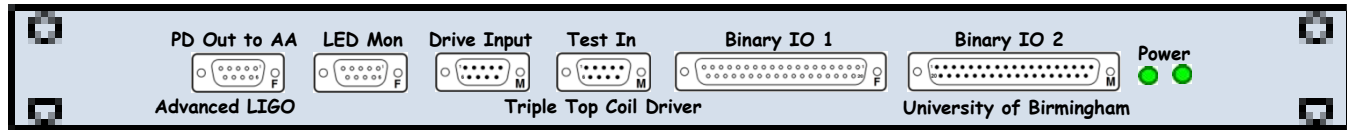

D1001242

Front

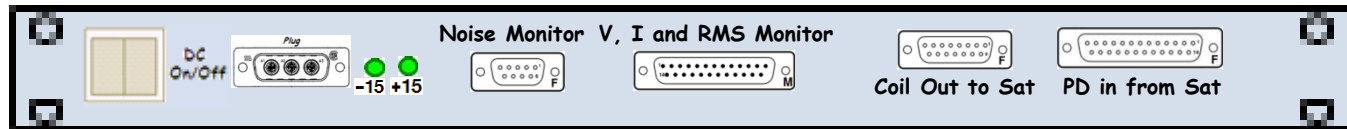
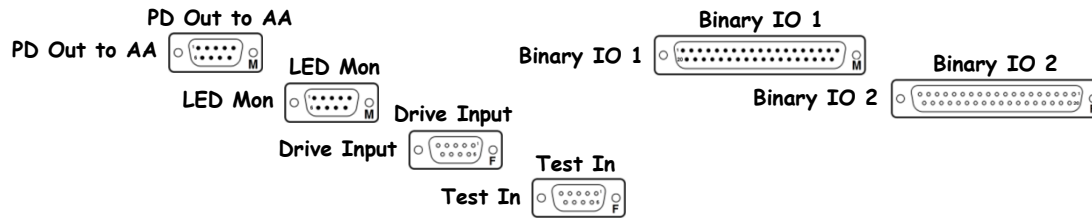

S1000253

Rear

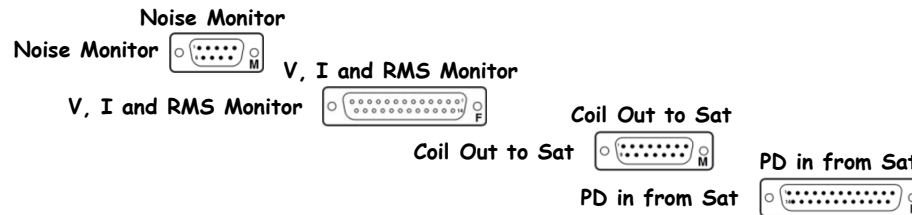

[Driver Board: D0902747](#)

[Monitor Board: D070480](#)

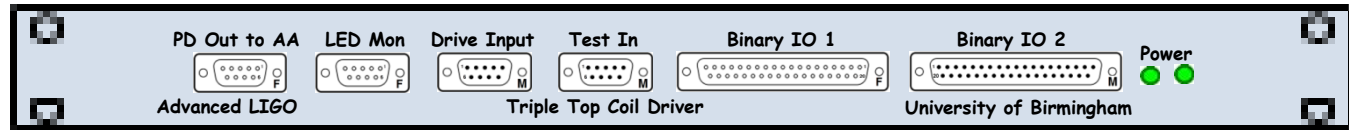

D1001242

Front

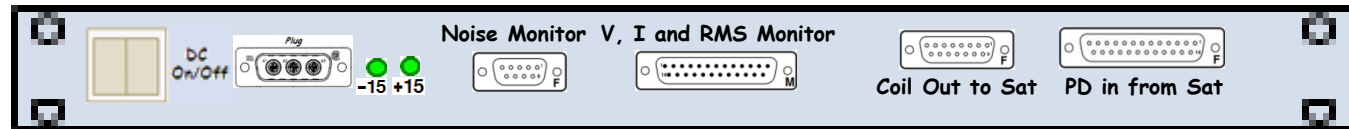
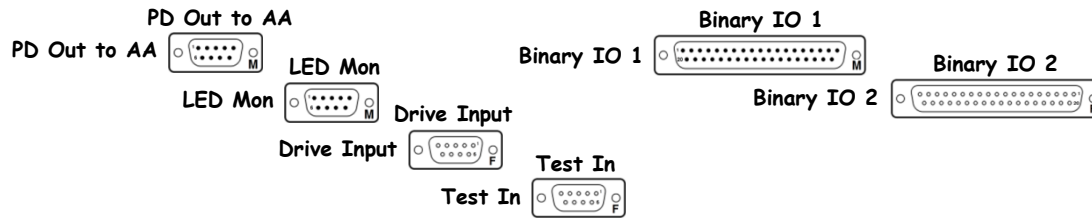

S1000261

Rear

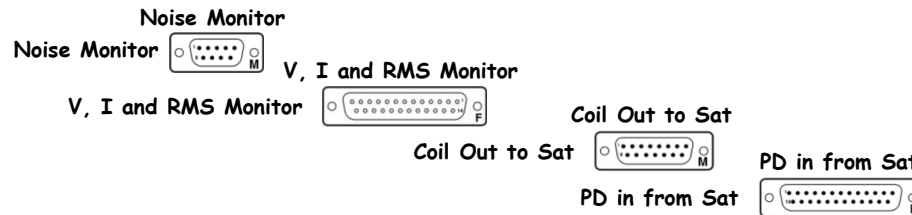

Driver Board: [D0902747](#)

Monitor Board: [D070480](#)

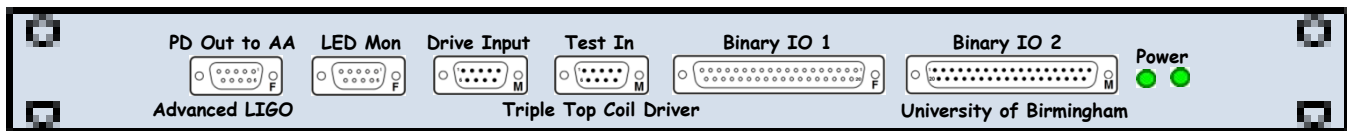

D1001242

Front

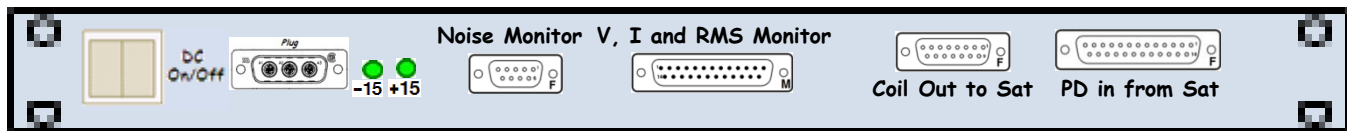
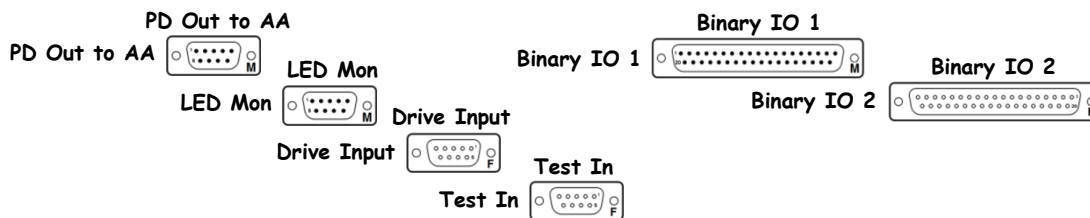

S1000262

Rear

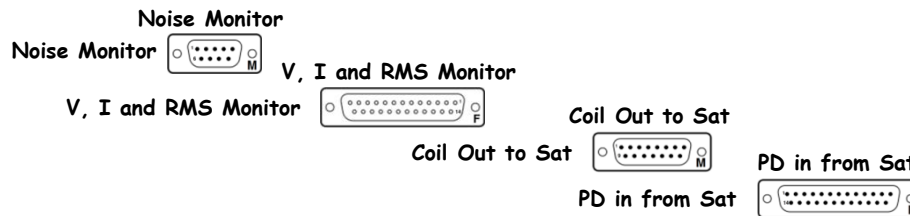

[Driver Board: D0902747](#)

[Monitor Board: D070480](#)

D1001242 - S1000257



<< L1-SUS-C4

PRM-PR3 Triple Top Coil Driver Chassis D1001242 S1000257 ±18VDC

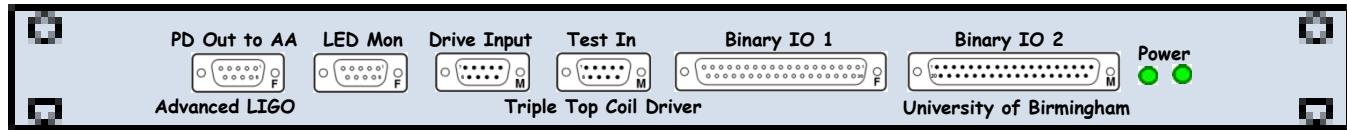

D1001242

Front

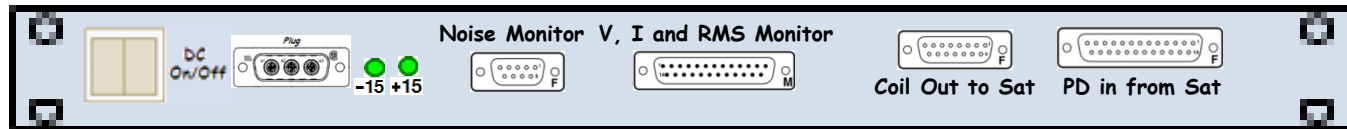
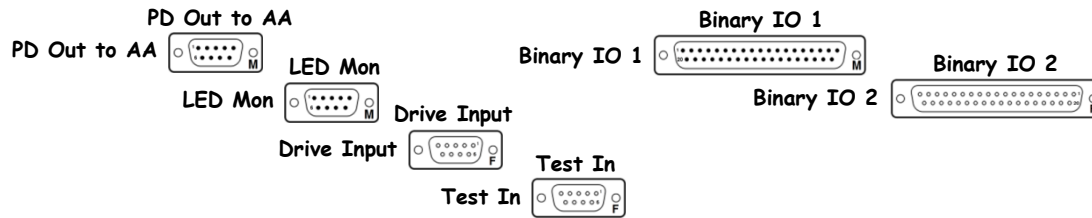

S1000257

Rear

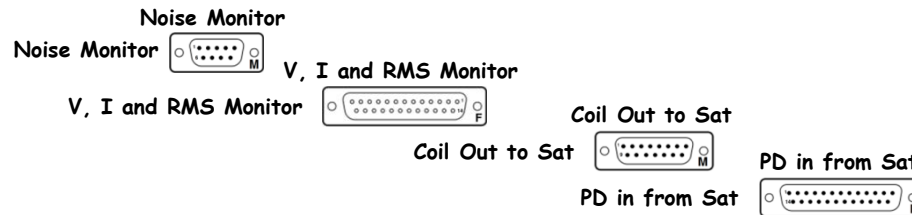

[Driver Board: D0902747](#)

[Monitor Board: D070480](#)

D1001242 - S1000726



<< L1-SUS-C4

PRM-PR3 Triple Top Coil Driver Chassis D1001242 S1000726 ±18VDC

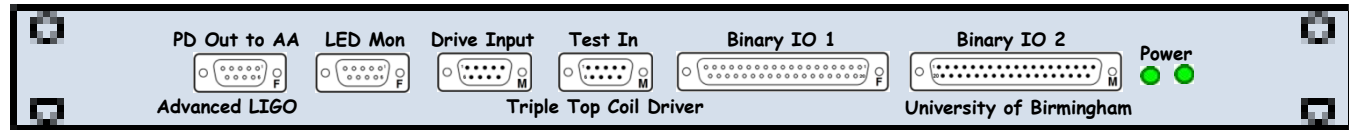

D1001242

Front

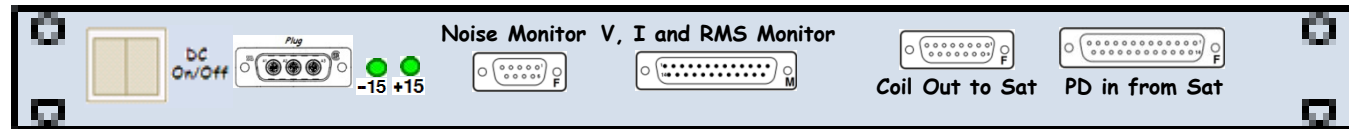
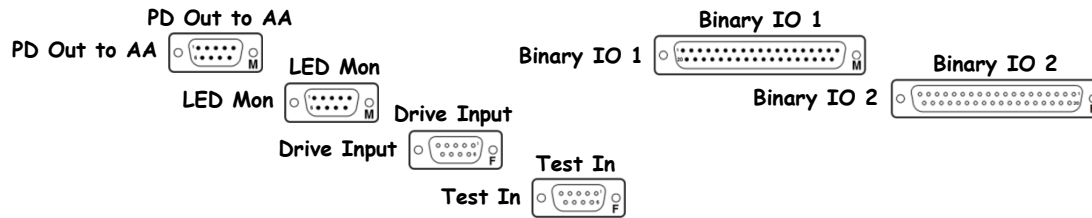

S1000726

Rear

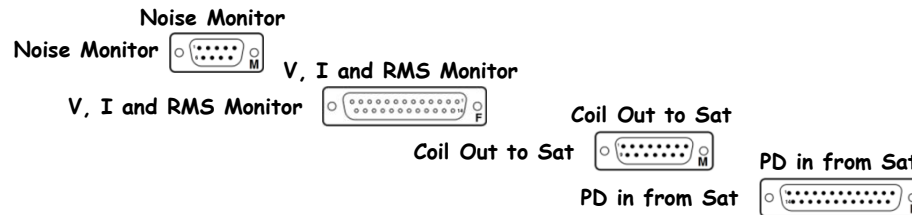

[Driver Board: D0902747](#)

[Monitor Board: D070480](#)

D1001242 - S1000723



<< L1-SUS-C4

PRM-PR3 Triple Top Coil Driver Chassis D1001242 S1000723 ±18VDC

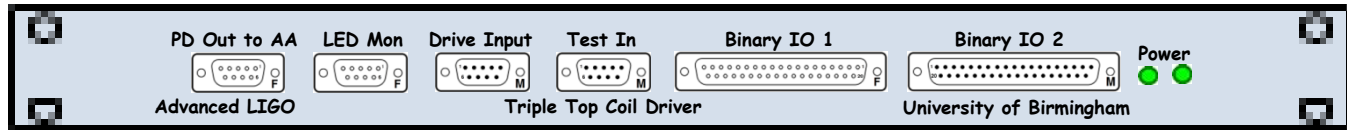

D1001242

Front

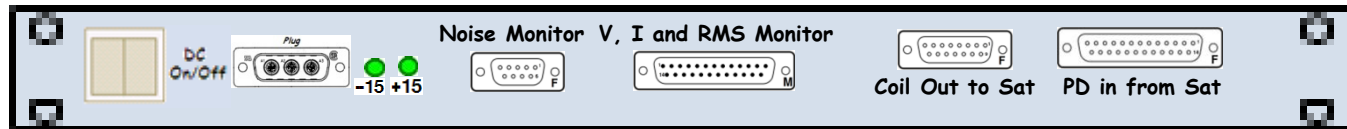
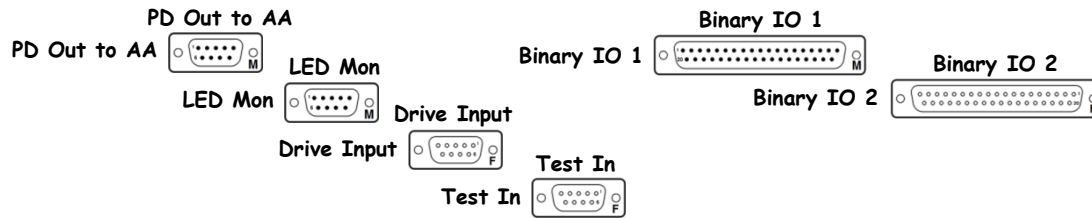

S1000723

Rear

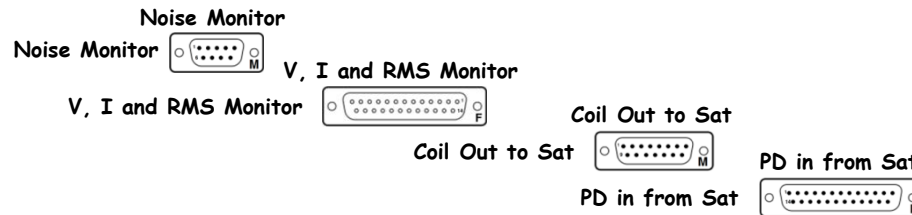

[Driver Board: D0902747](#)

[Monitor Board: D070480](#)

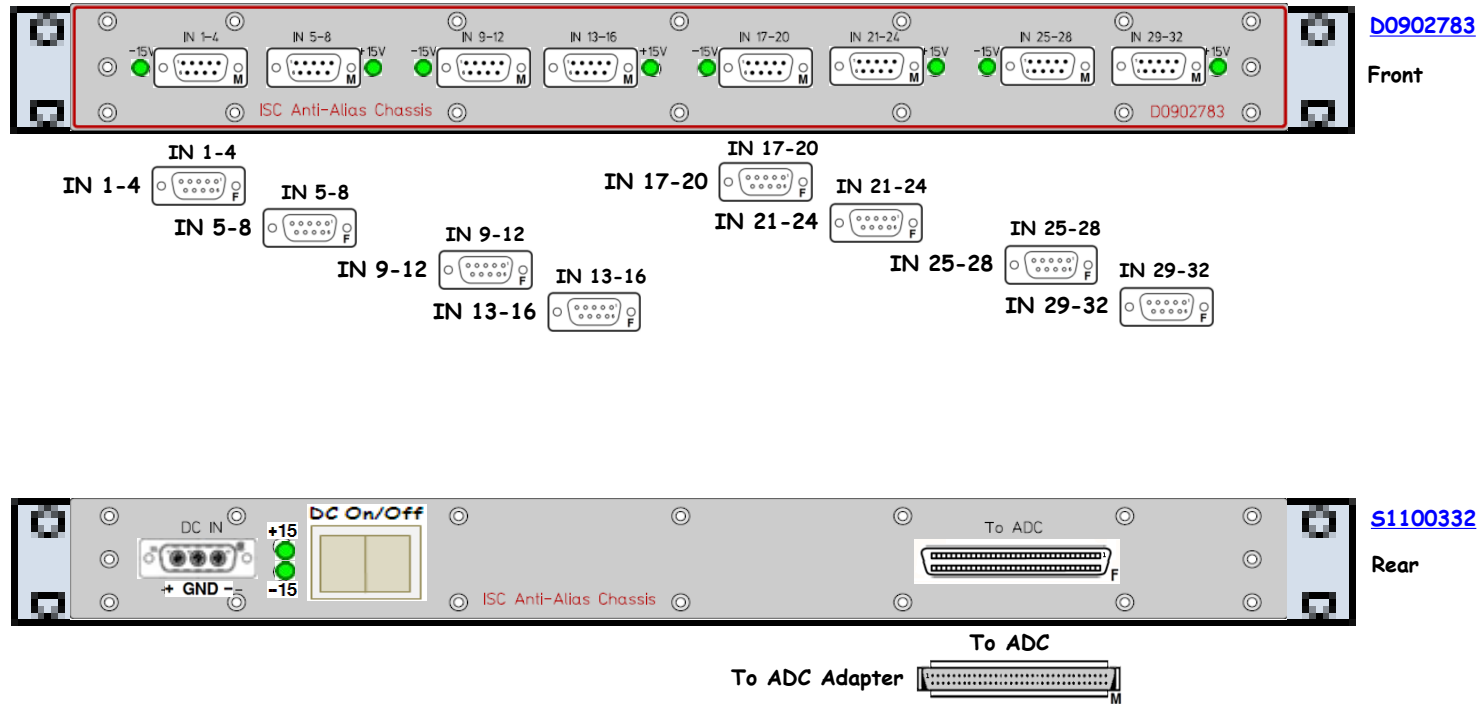

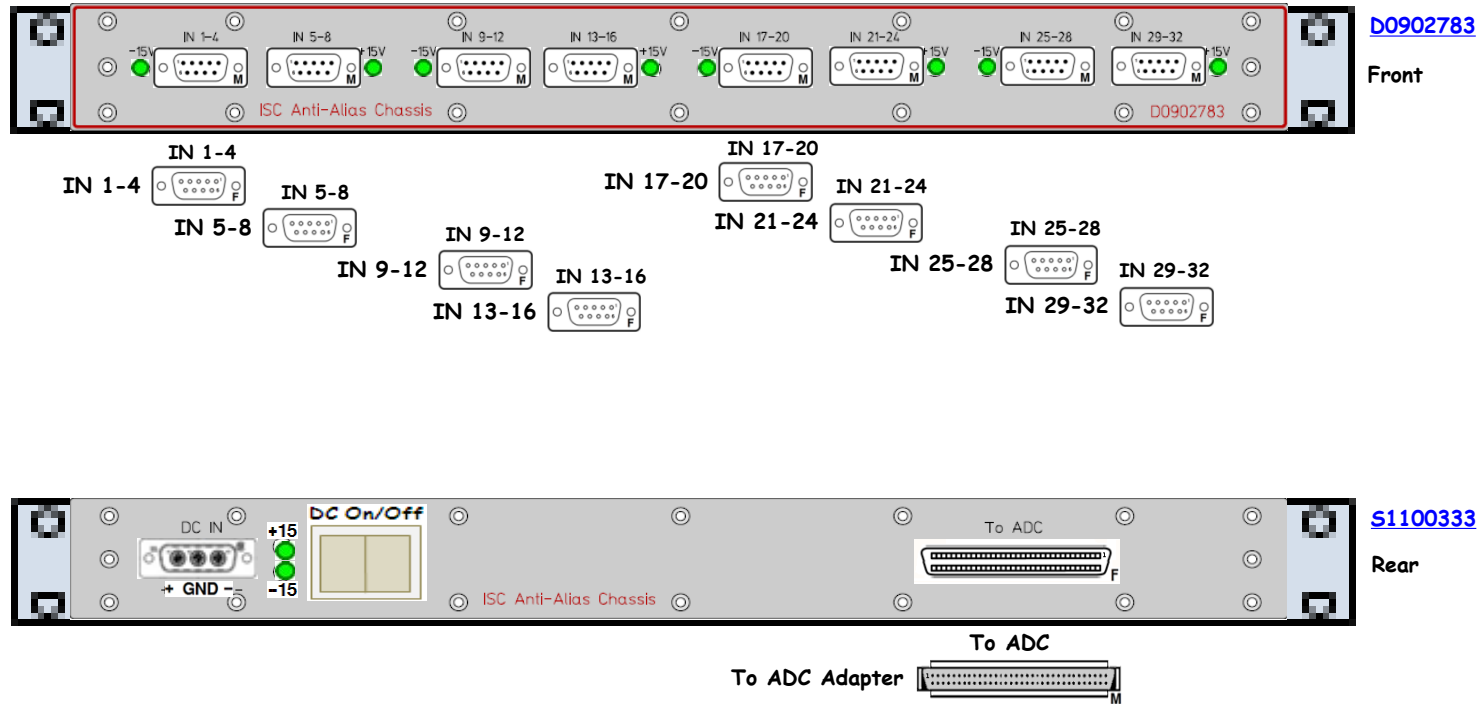

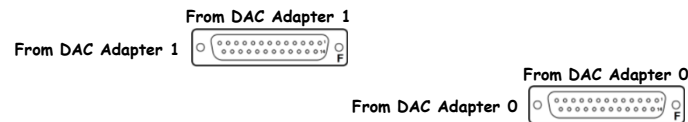
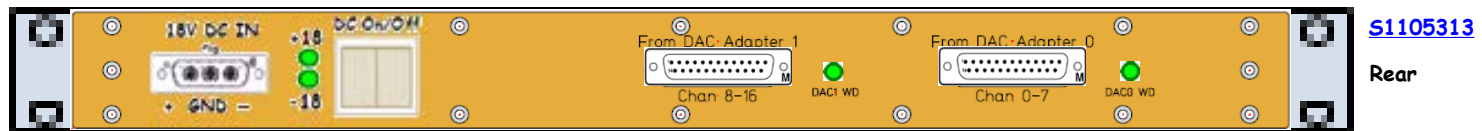
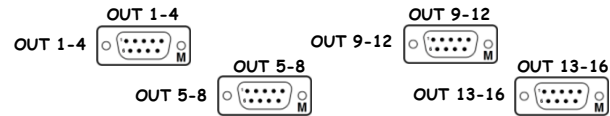
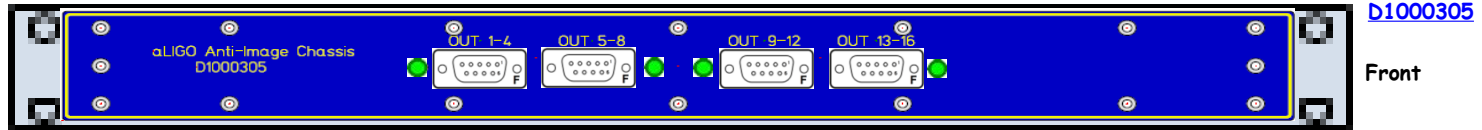

D1000305 - S1001200



<< L1-SUS-C4

FE1 DAC2, FE1 DAC3 Anti-Image Chassis ±18VDC

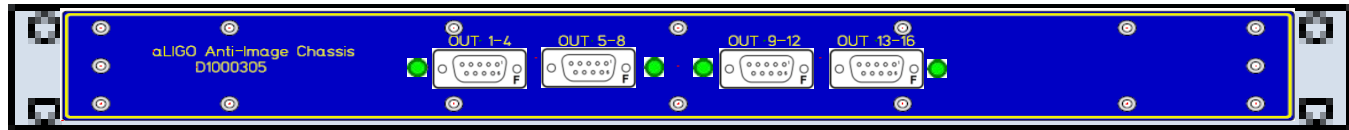

[D1000305](#)

Front

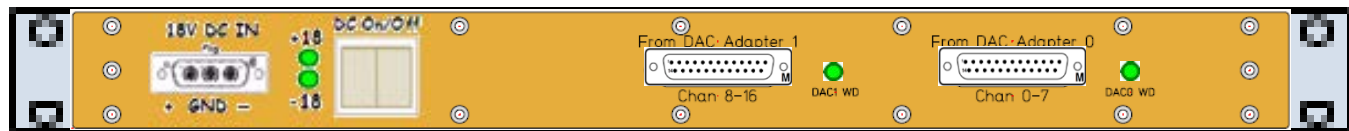
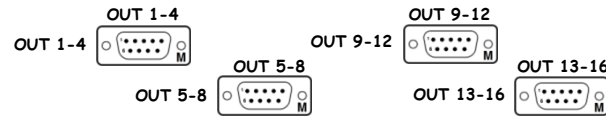

[S1001200](#)

Rear

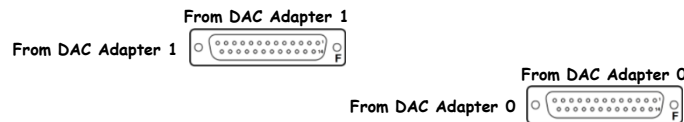

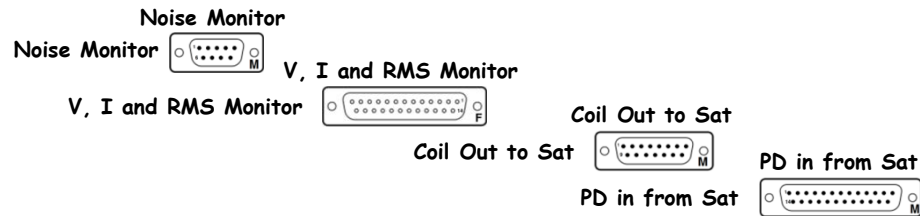
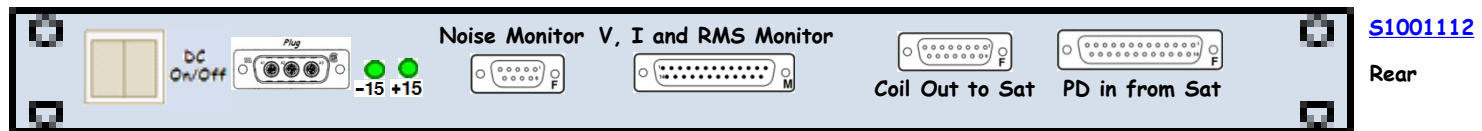
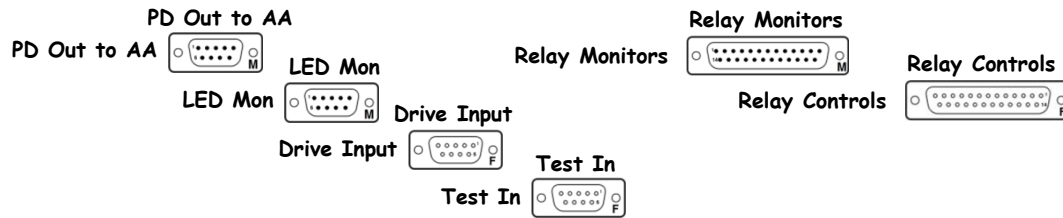
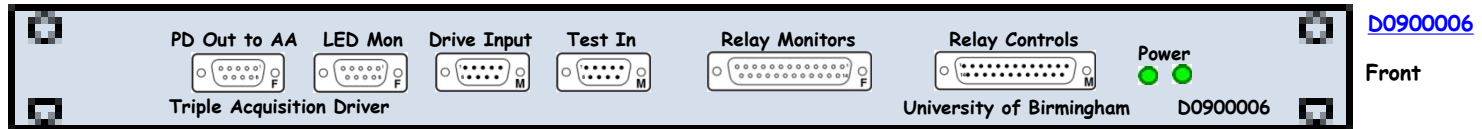

[Driver Board: D0901047](#)
[Monitor Board: D070480](#)

MC1 Bot Triple Acq Driver Chassis D0900006 S1000352 ±18VDC

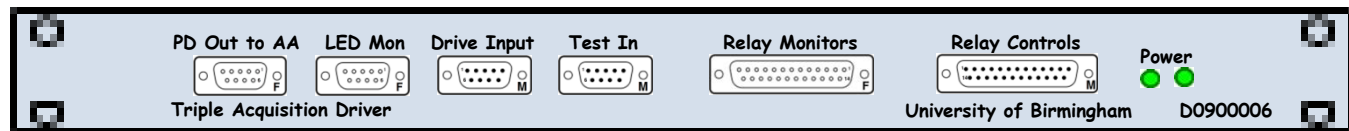

D0900006

Front

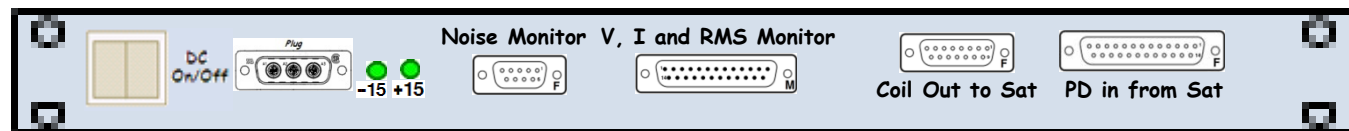
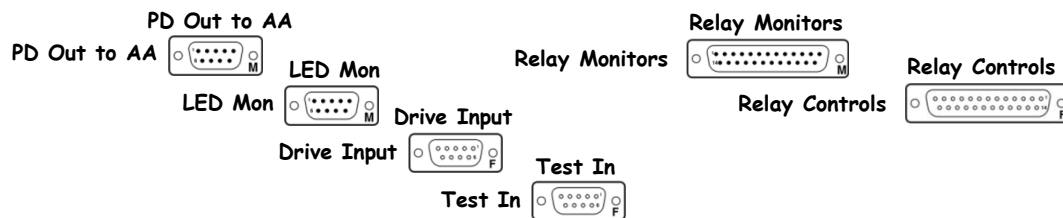

S1000352

Rear

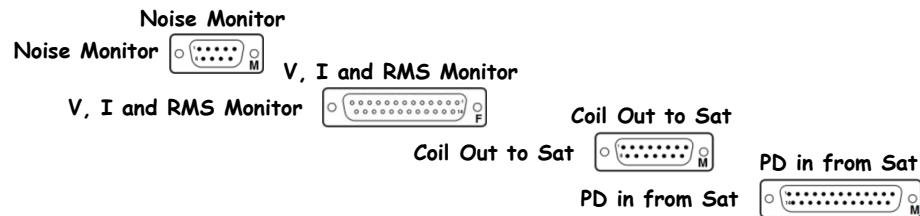

Driver Board: [D0901047](#)
 Monitor Board: [D070480](#)

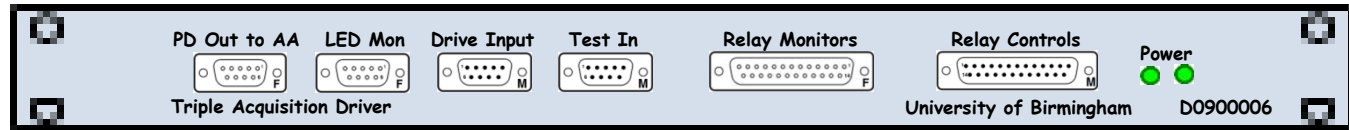

D0900006

Front

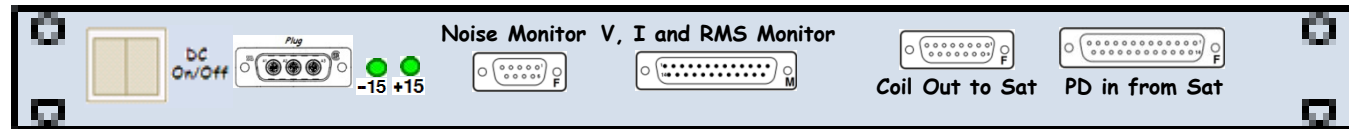
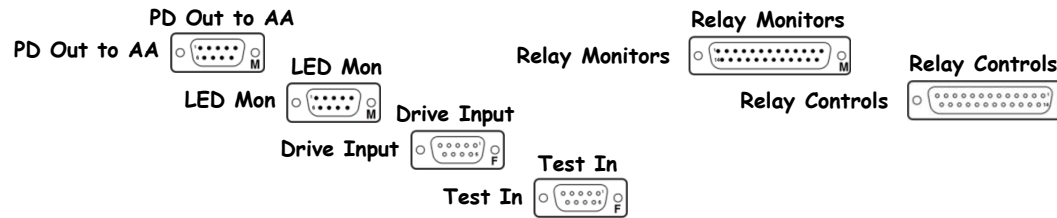

S1000353

Rear

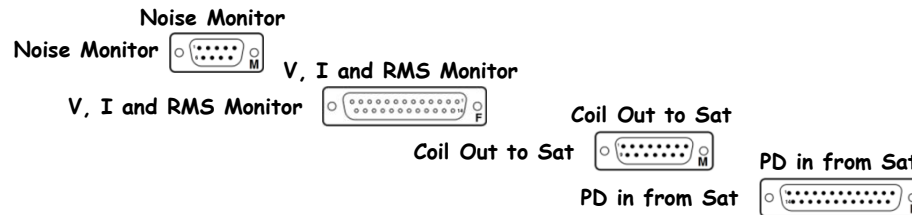

Driver Board: [D0901047](#)
Monitor Board: [D070480](#)

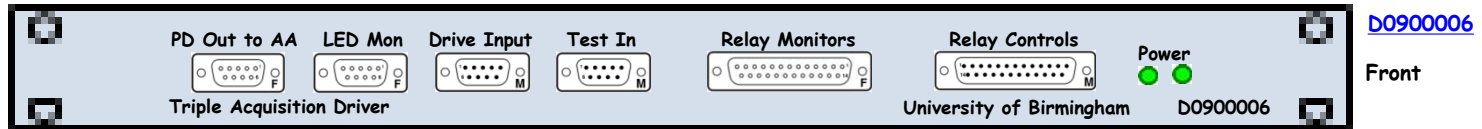

Front

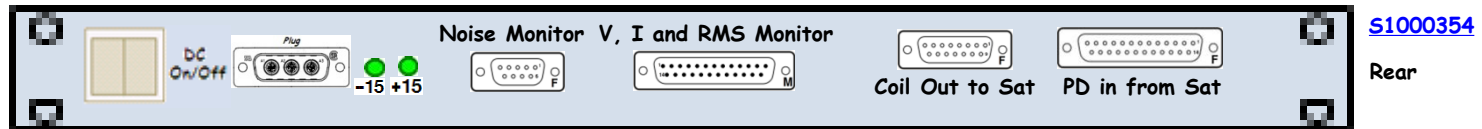
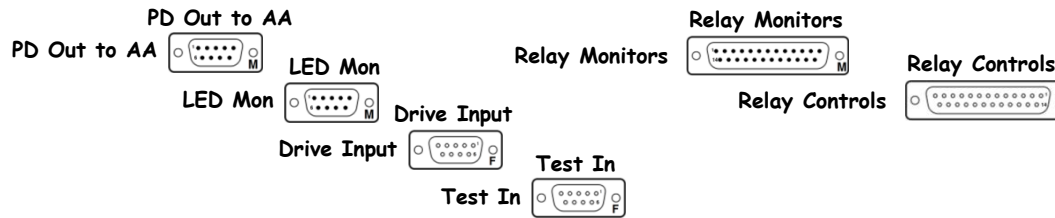

Rear

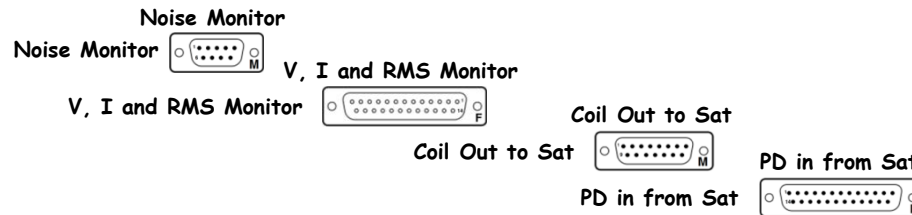

[Driver Board: D0901047](#)
[Monitor Board: D070480](#)

D1000305 - S1104363



<< L1-SUS-C4

FE1 DAC4, FE1 DAC5 Anti-Image Chassis ±18VDC

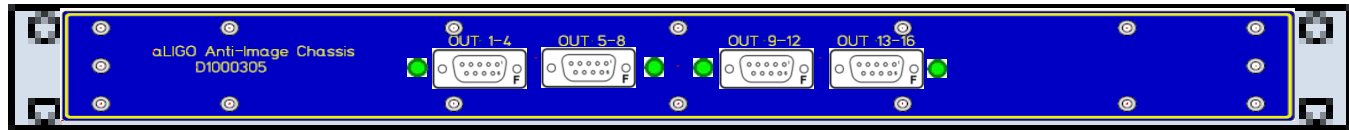

[D1000305](#)

Front

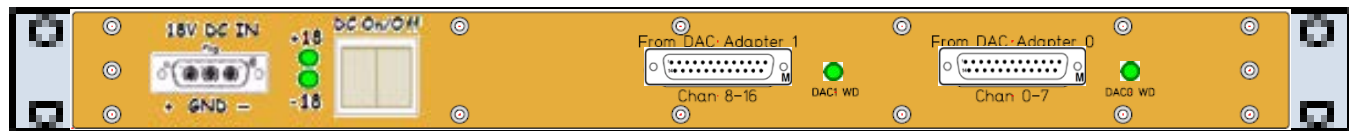
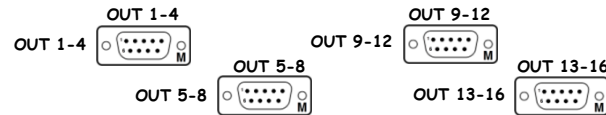

[S1104363](#)

Rear

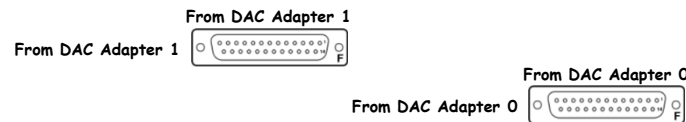

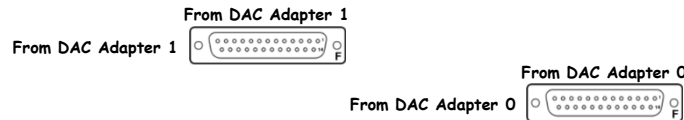
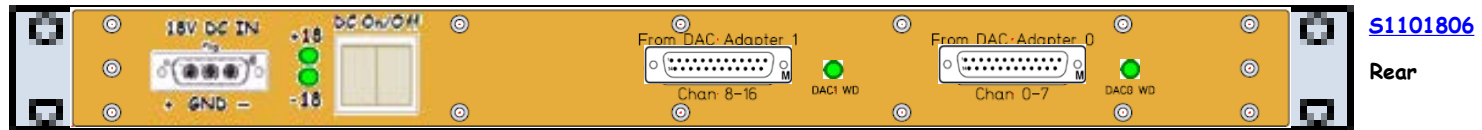
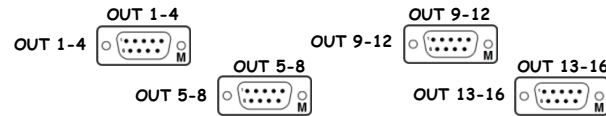
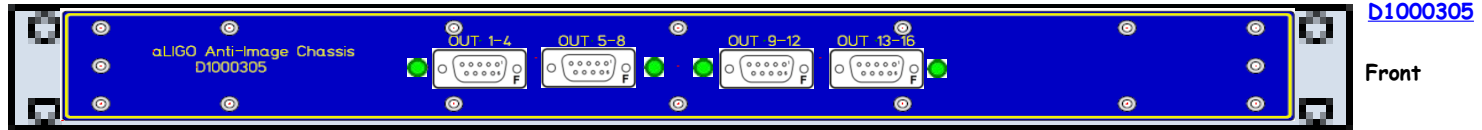

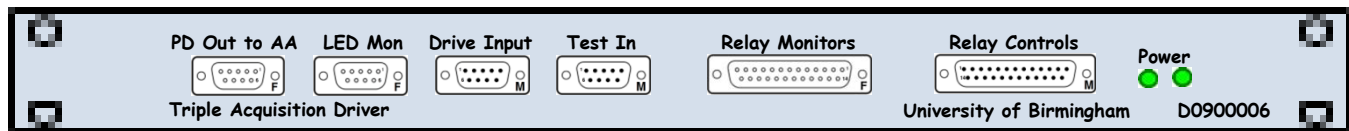

[D0900006](#)

Front

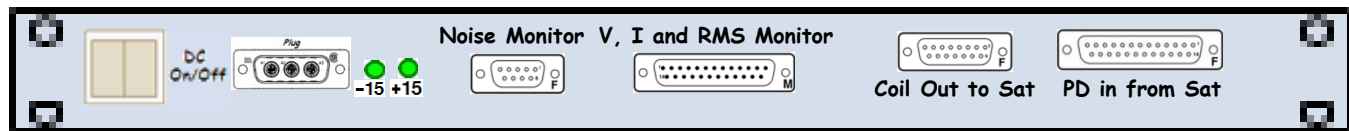
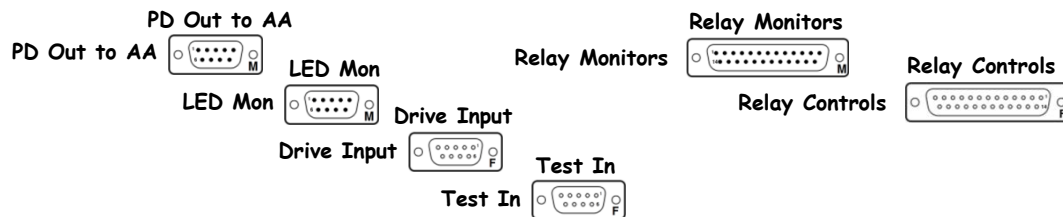

[S1001103](#)

Rear

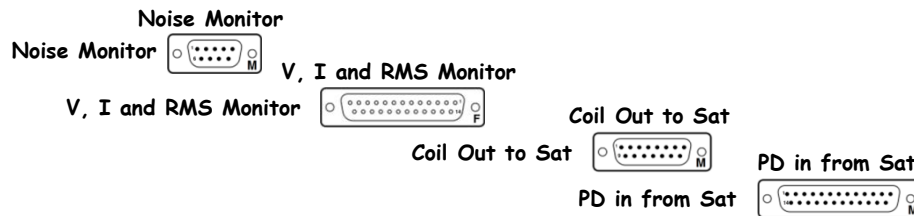

[Driver Board: D0901047](#)
[Monitor Board: D070480](#)

PRM Bot Triple Acq Driver Chassis D0900006 S1001191 ±18VDC

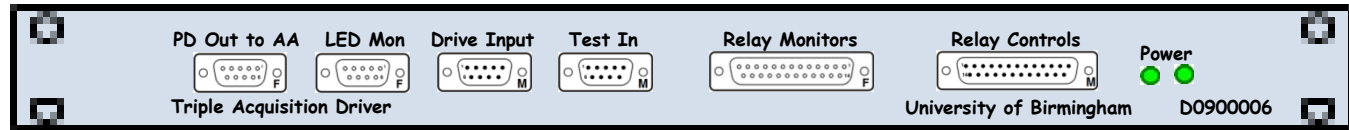

D0900006

Front

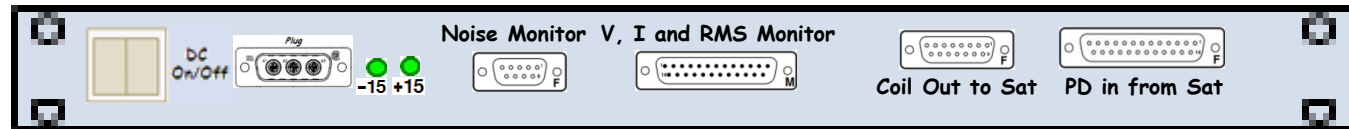
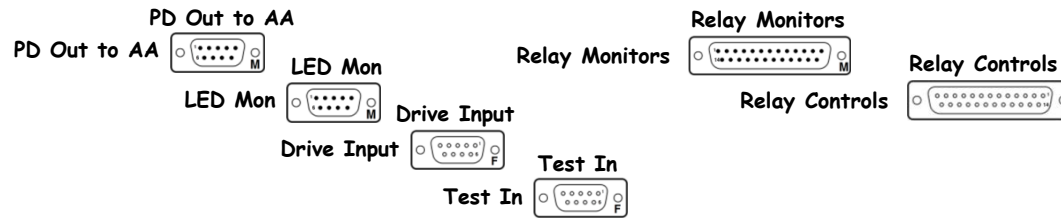

S1001191

Rear

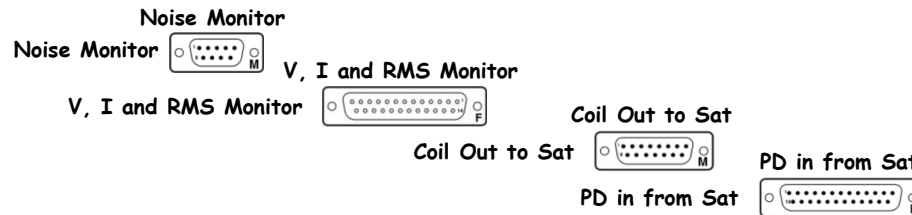

Driver Board: [D0901047](#)
Monitor Board: [D070480](#)

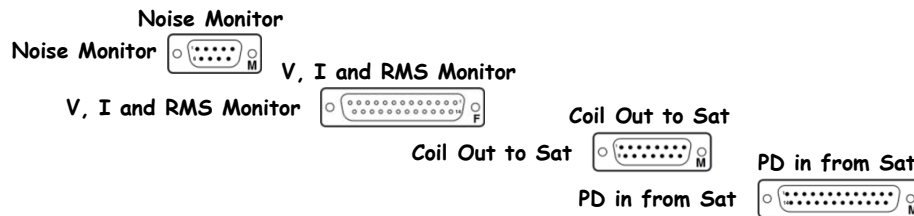
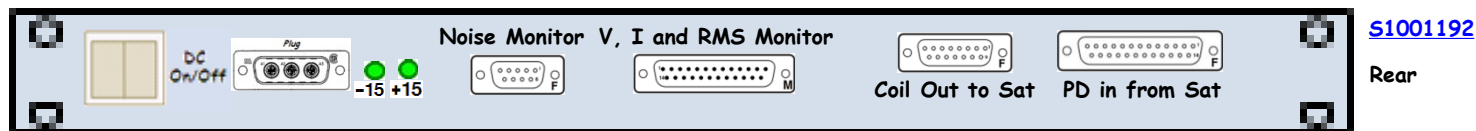
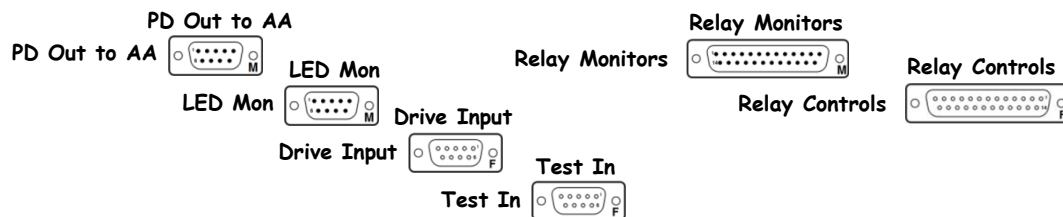
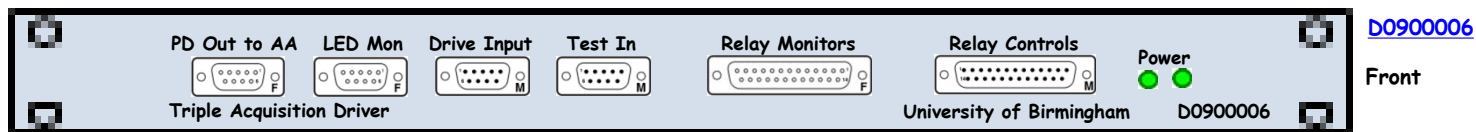

[Driver Board: D0901047](#)
[Monitor Board: D070480](#)

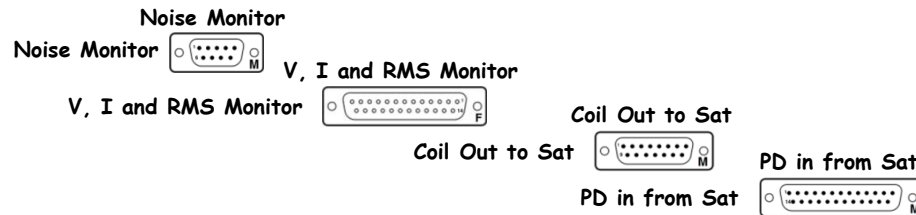
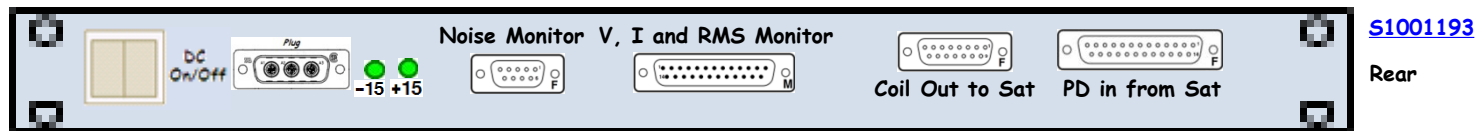
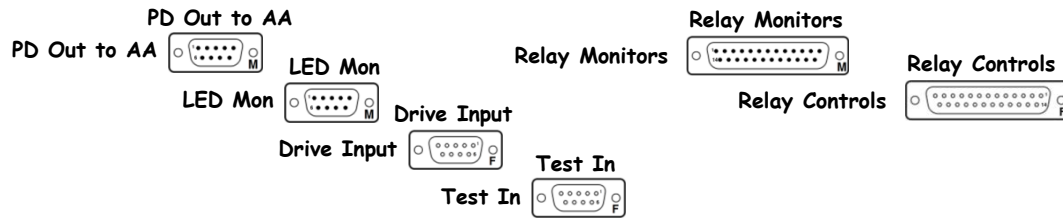
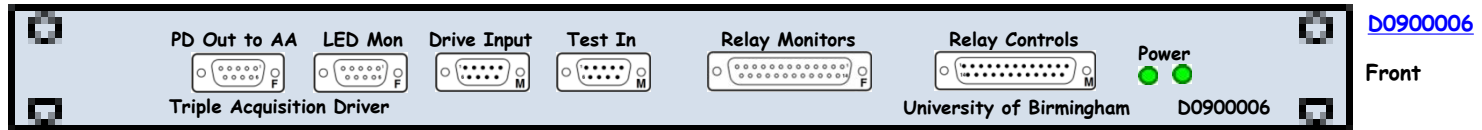

[Driver Board: D0901047](#)
[Monitor Board: D070480](#)

D1100687 - S1200590

SM1 8-Channel Coil Driver Chassis D1100687 S1200590 ±18VDC

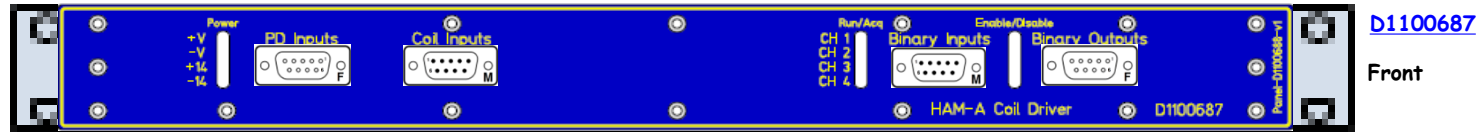

D1100687

Front

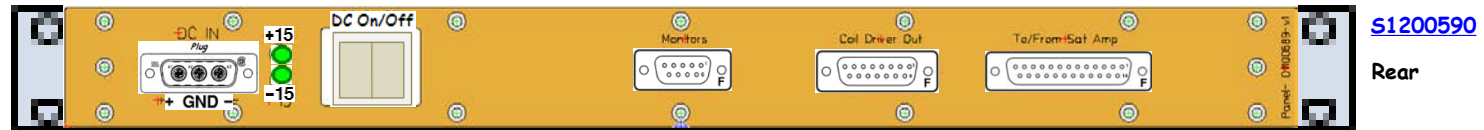

S1200590

Rear

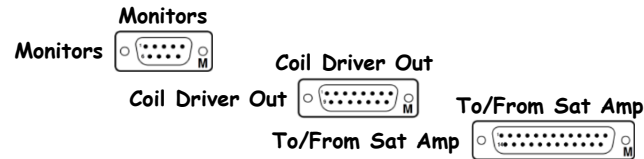

D1100687 - S1200589

SM2 8-Channel Coil Driver Chassis D1100687 S1200589 ±18VDC

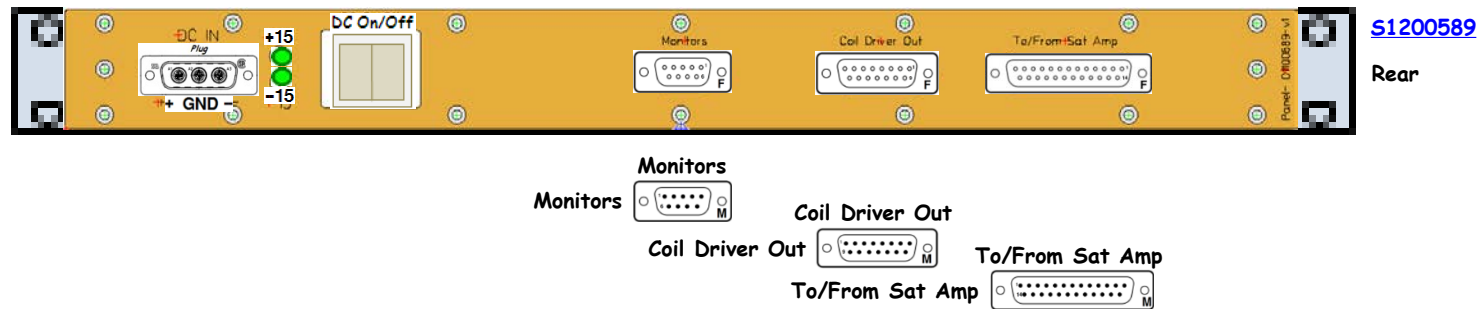
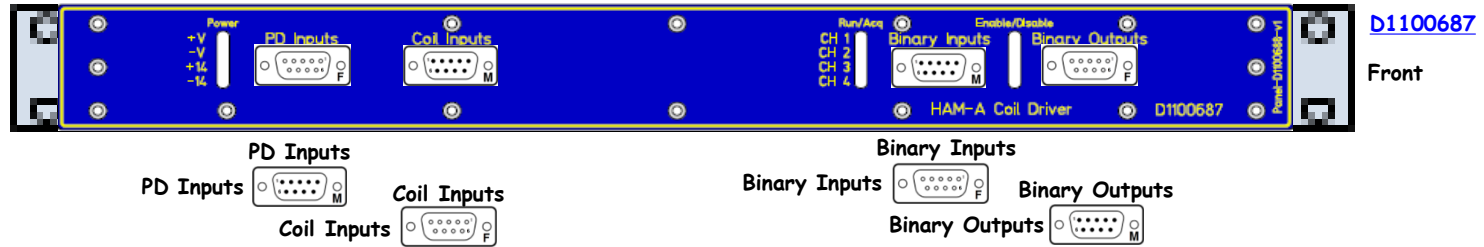

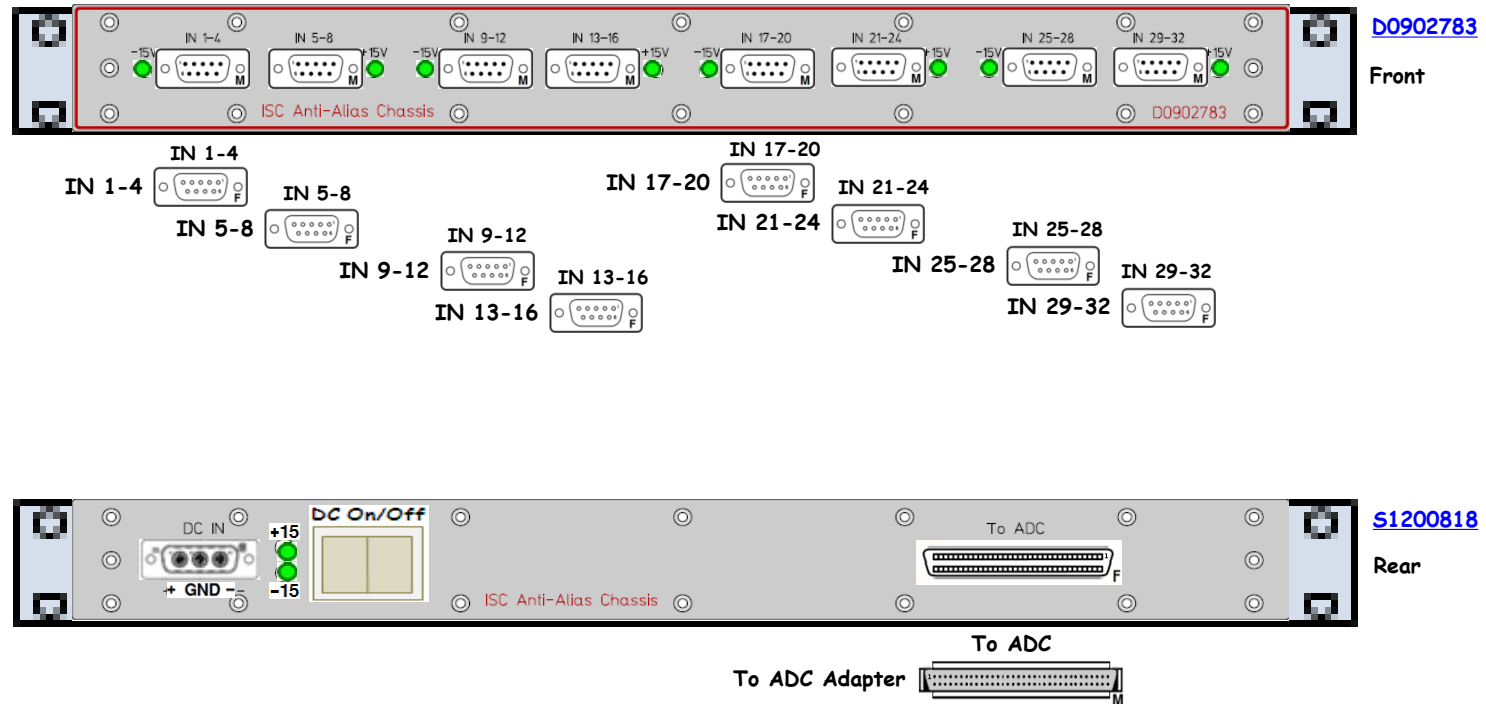

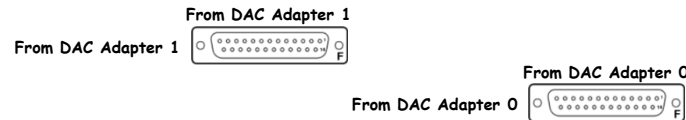
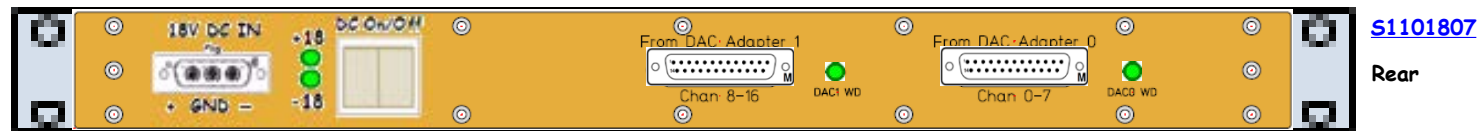
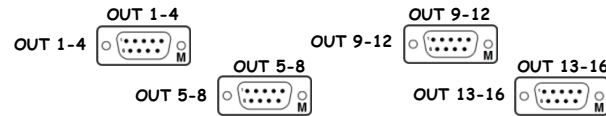
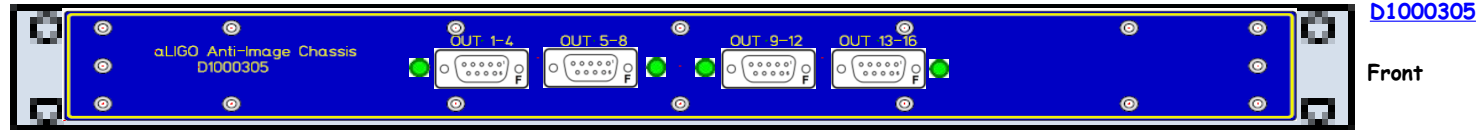

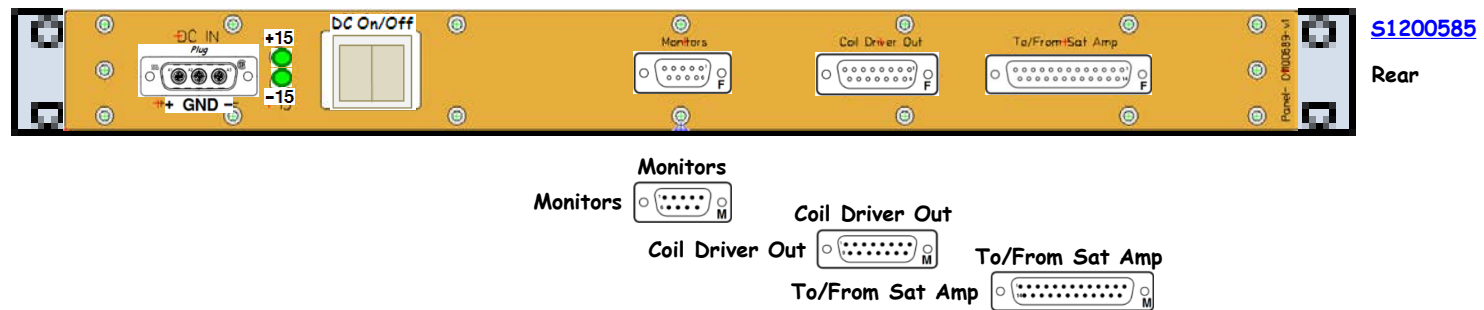
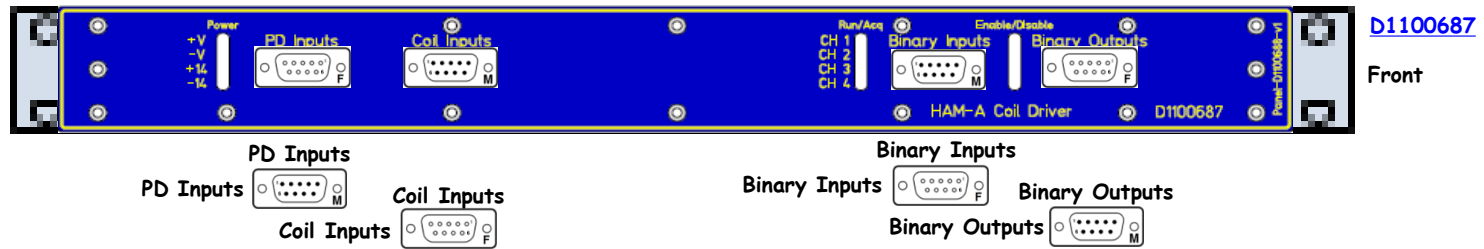

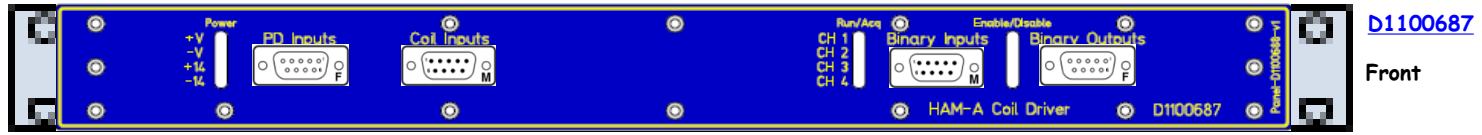

D1100687

Front

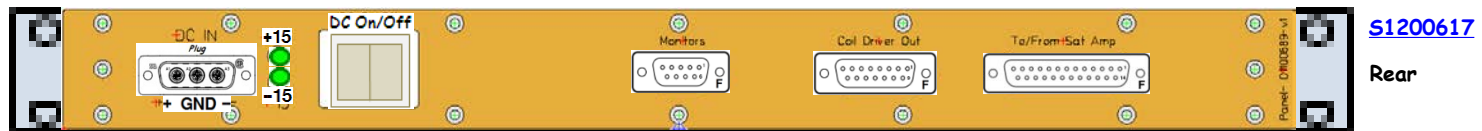

S1200617

Rear

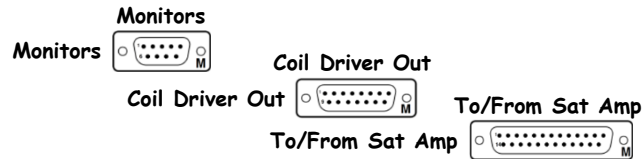

L1-SUS-C5 - S1105375

<< CER

SUS ITMX, ITMY, and BS Rack 1 (of 2) Layout (D1100022) (S1105375)

		42			
ITMY Quad Top Coil Driver Chassis	D1001782	41	S1000435	±18VDC	
ITMY Quad Top Coil Driver Chassis	D1001782	40	S1000380	±18VDC	
ITMY Quad Top Coil Driver Chassis	D1001782	39	S1000372	±18VDC	
		38			
ITMX Quad Top Coil Driver Chassis	D1001782	37	S1000377	±18VDC	
ITMX Quad Top Coil Driver Chassis	D1001782	36	S1000379	±18VDC	
ITMX Quad Top Coil Driver Chassis	D1001782	35	S1000370	±18VDC	
		34			
ITMY UIM Coil Driver Chassis	D0902668	33	S0900313	±18VDC	
ITMX UIM Coil Driver Chassis	D0902668	32	S0900311	±18VDC	
ITMY PUM Coil Driver Chassis	D1100303	31	S1101562	±18VDC	
ITMX PUM Coil Driver Chassis	D1100303	30	S1101561	±18VDC	
		29			
BS Triple Top Coil Driver Chassis	D1001242	28	S1000265	±18VDC	
BS Triple Top Coil Driver Chassis	D1001242	27	S1000258	±18VDC	
BS Mid Triple Acq Driver Chassis	D0900006	26	S1001110	±18VDC	
		25			
		24			
l1subsc123 I/O Extension Chassis	D1001715	23	S1001143	+24VDC	
		22			
		21			
		20			
		19			
		18			
		17			
		16			
		15			
		14			
l1susauxbsc123 I/O Extension Chassis	D1001715	13	S1103888	+24VDC	
		12			
		11			
		10			
		9			
		8			
		7			
		6			
		5			
		4			
		3			
		2			
		1			
	Front		Rear		

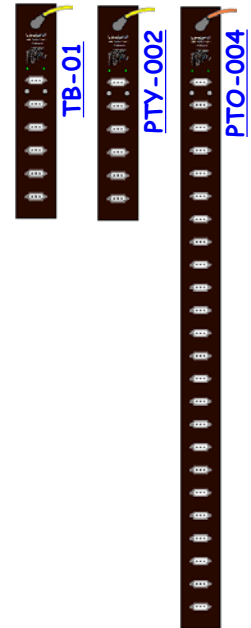

L1-SUS-C5 Details

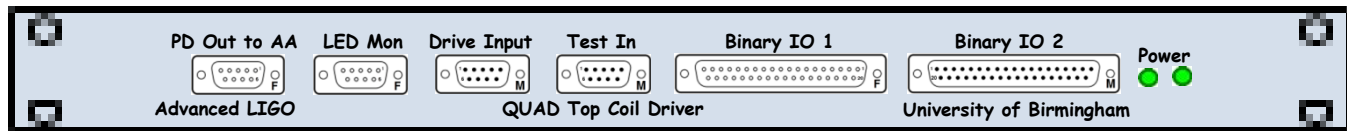

D1001782

Front

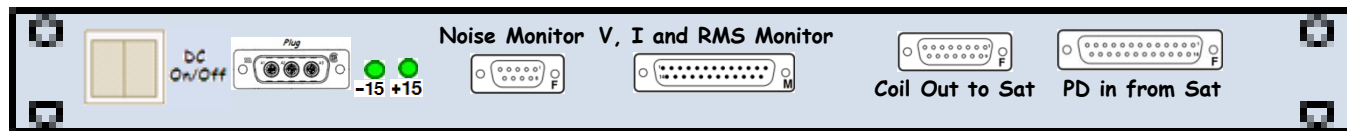
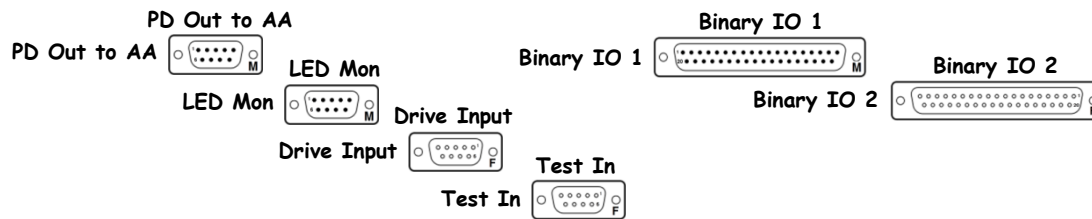

S1000435

Rear

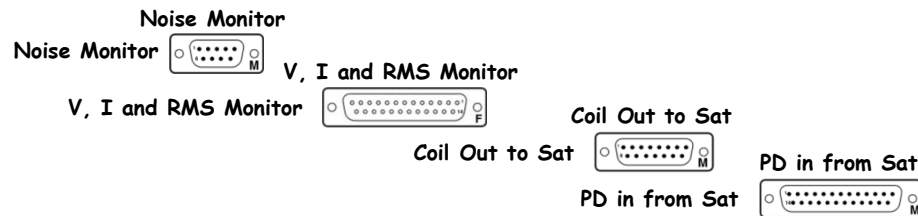

[Driver Board: D0902747](#)

[Monitor Board: D070480](#)

D1001782 - S1000380



<< L1-SUS-C5

ITMY Quad Top Coil Driver Chassis D1001782 S1000380 ±18VDC

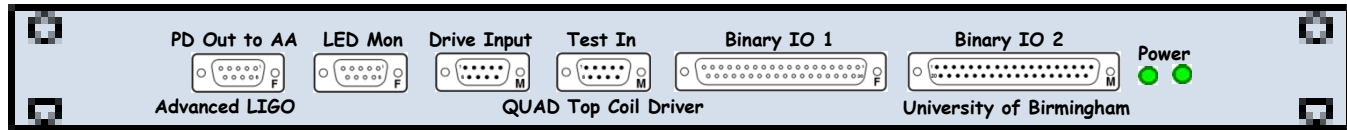

D1001782

Front

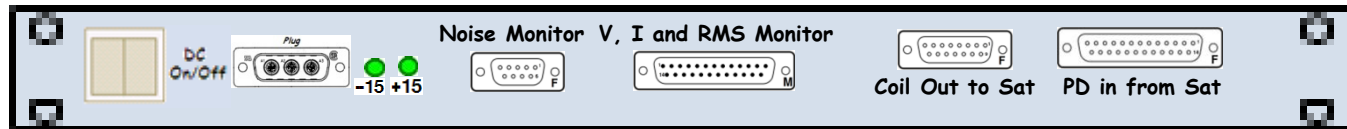
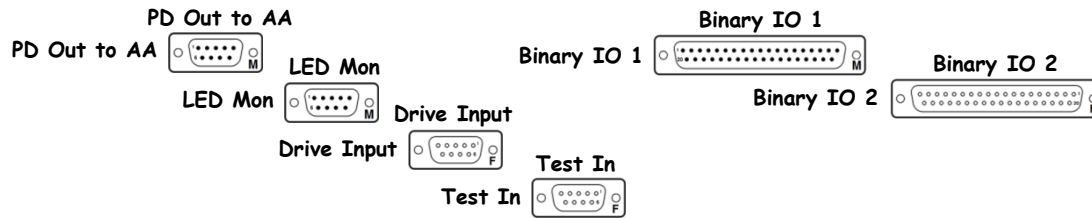

S1000380

Rear

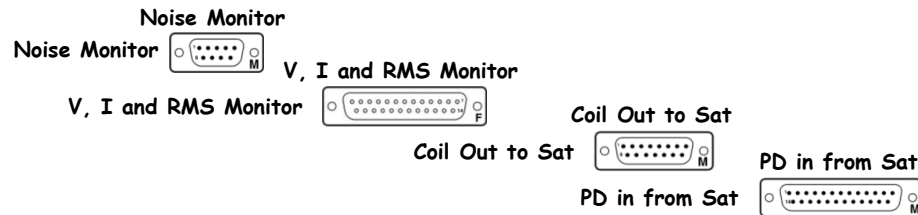

[Driver Board: D0902747](#)

[Monitor Board: D070480](#)

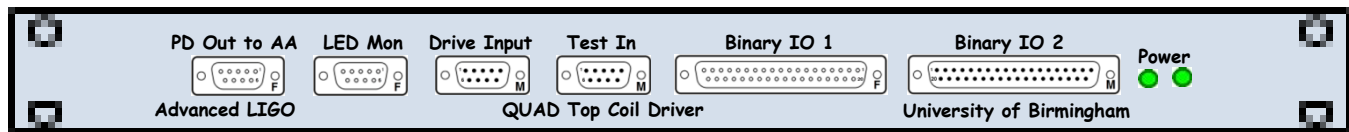

D1001782

Front

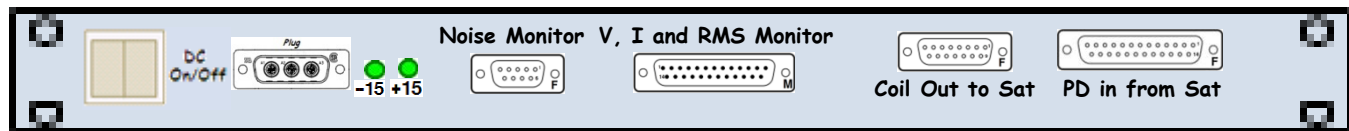
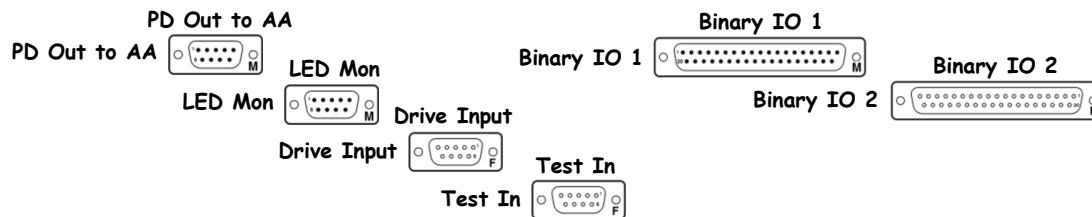

S1000372

Rear

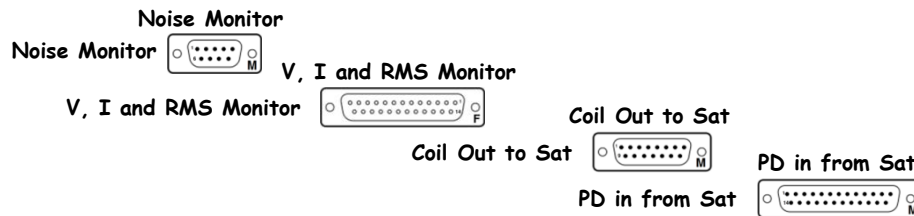

[Driver Board: D0902747](#)

[Monitor Board: D070480](#)

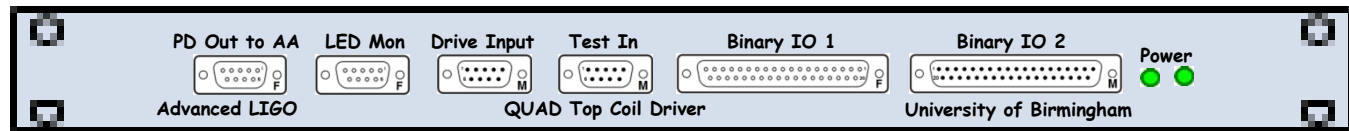

D1001782

Front

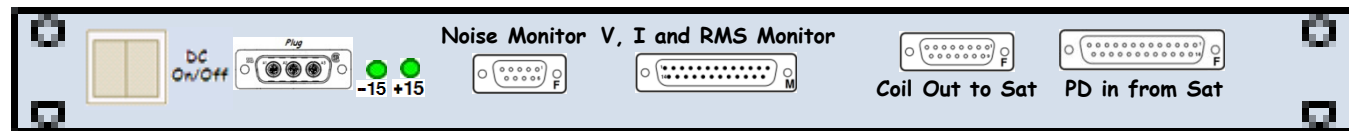
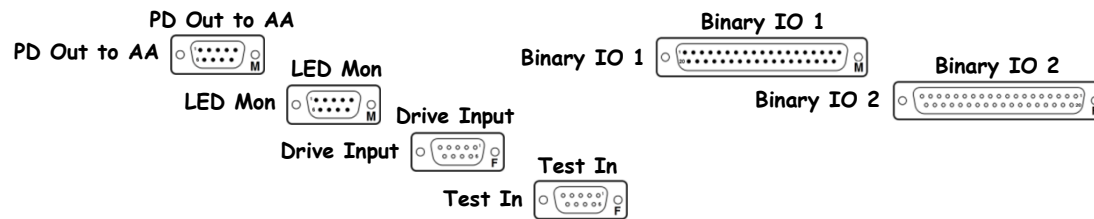

S1000377

Rear

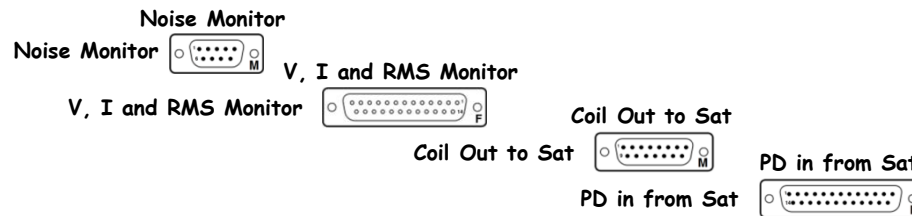

[Driver Board: D0902747](#)

[Monitor Board: D070480](#)

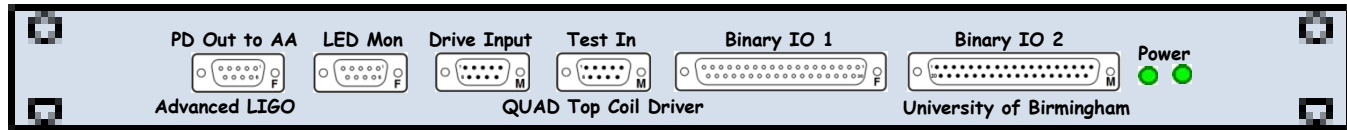

D1001782

Front

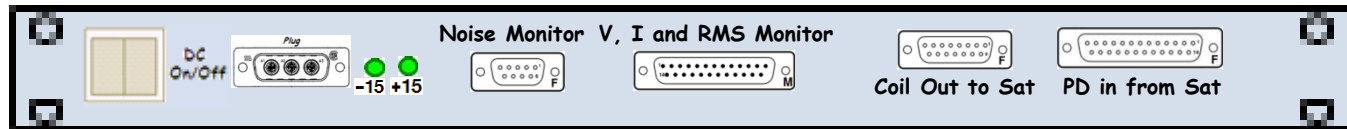
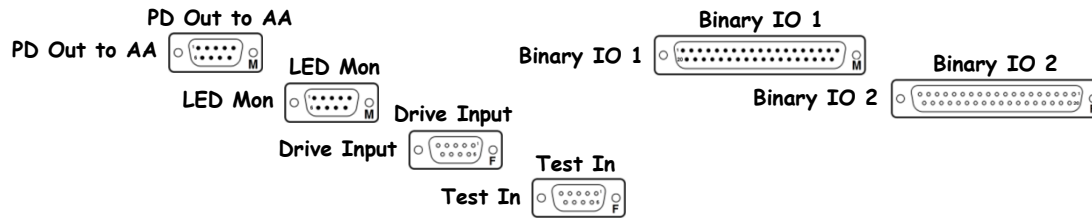

S1000379

Rear

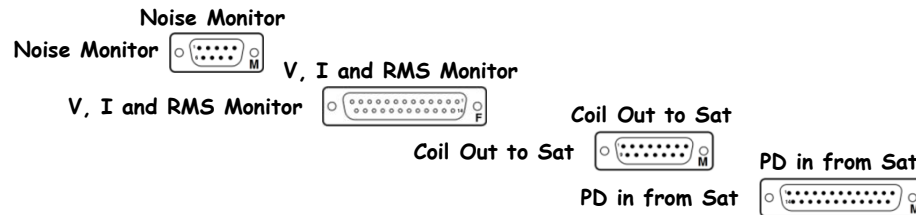

[Driver Board: D0902747](#)

[Monitor Board: D070480](#)

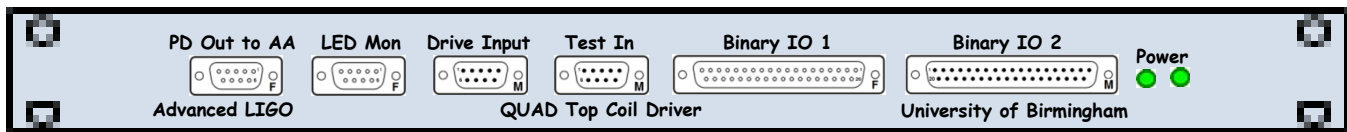

D1001782

Front

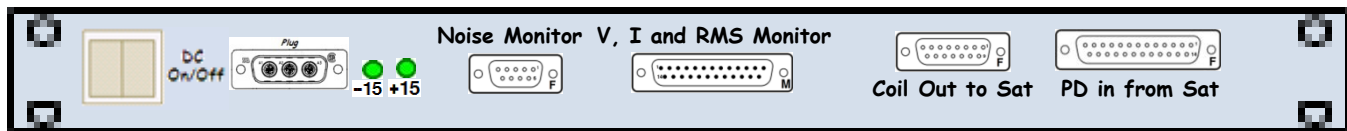
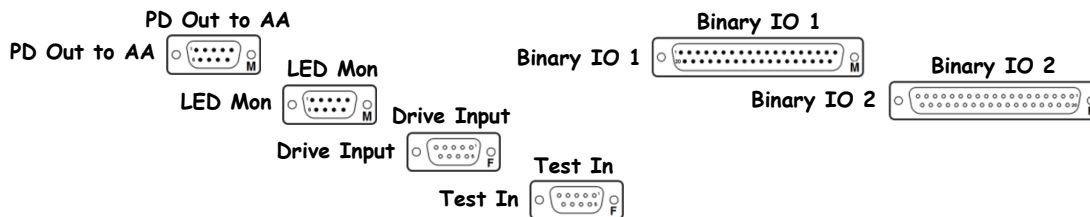

S1000370

Rear

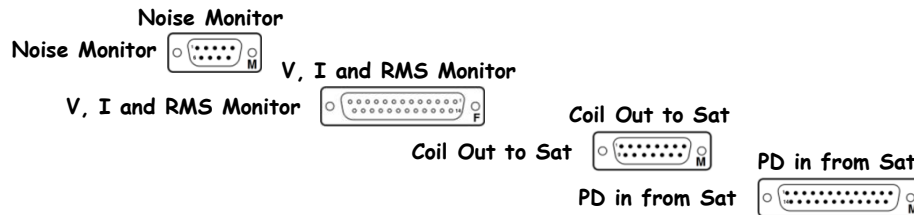

[Driver Board: D0902747](#)
[Monitor Board: D070480](#)

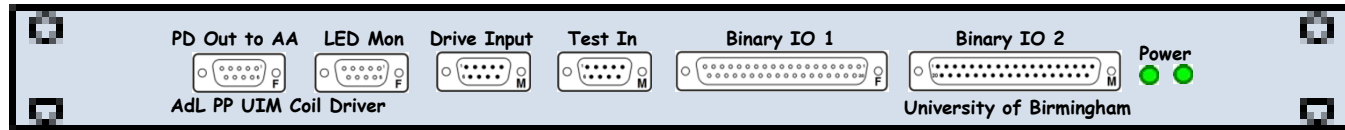

[D070481](#)
[D070480](#)
Front

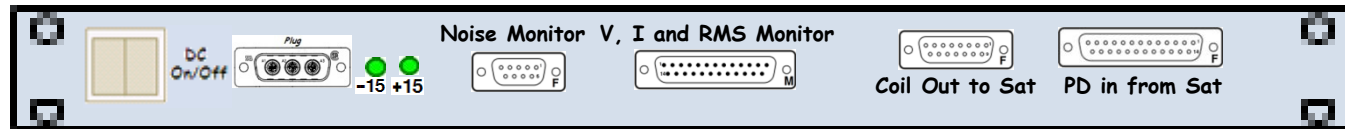
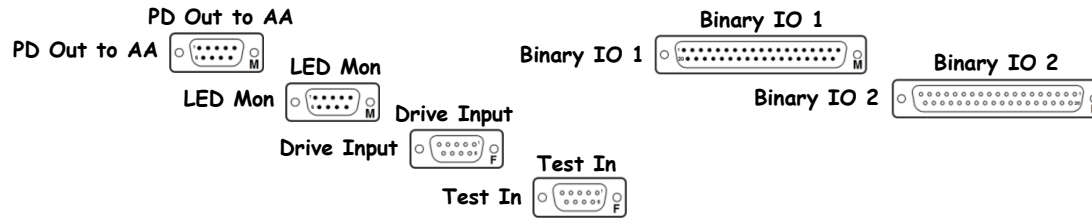

[S0900313](#)
Rear

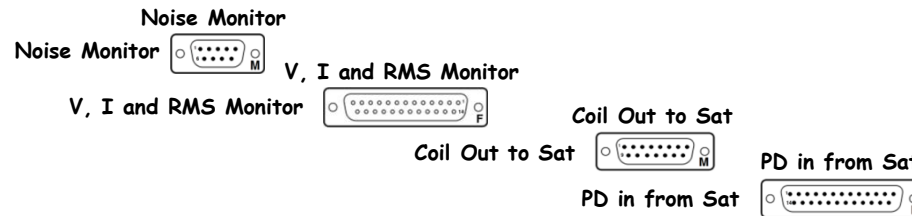

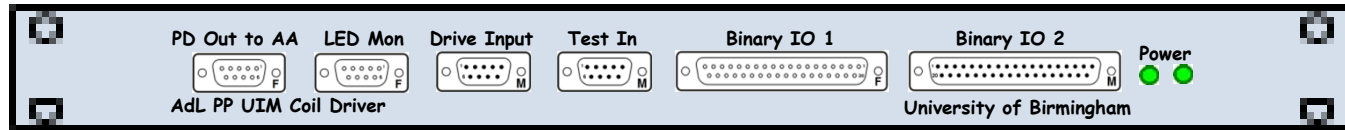

[D070481](#)
[D070480](#)
Front

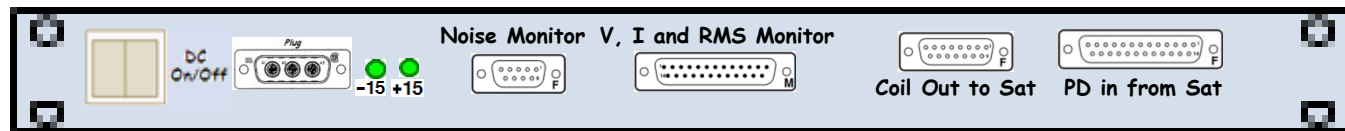
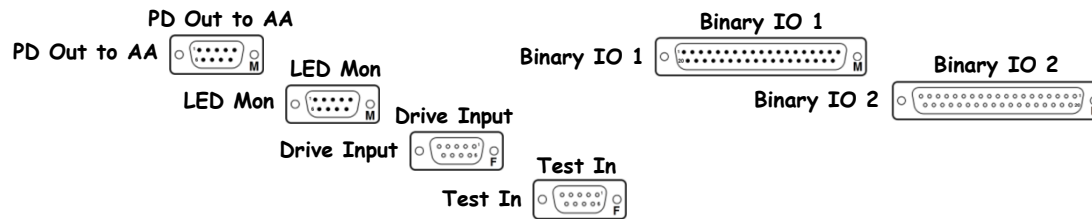

[S0900311](#)
Rear

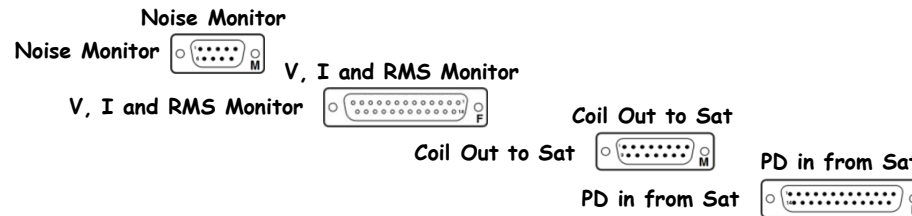

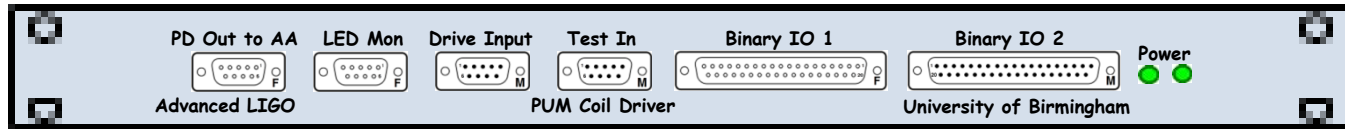

[D070483](#)
[D070480](#)
 Front

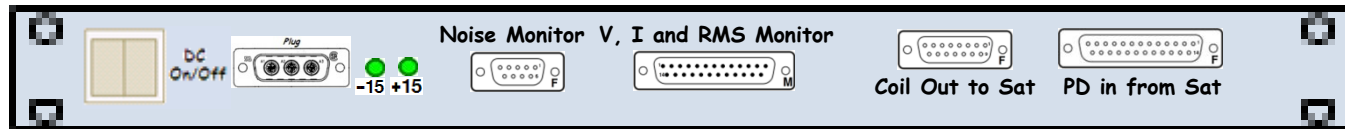
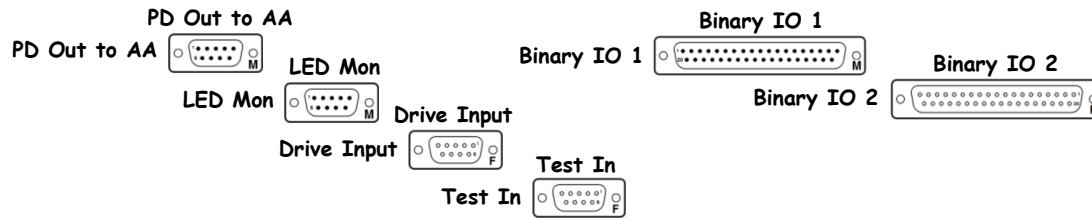

[S1101562](#)
 Rear

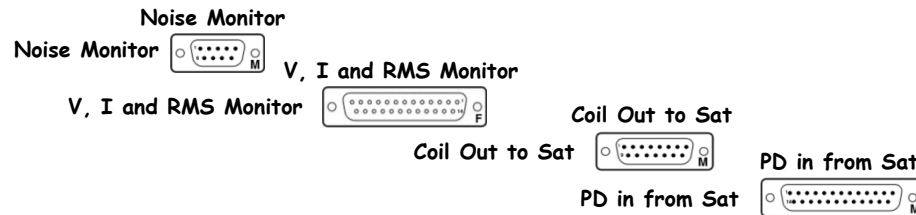

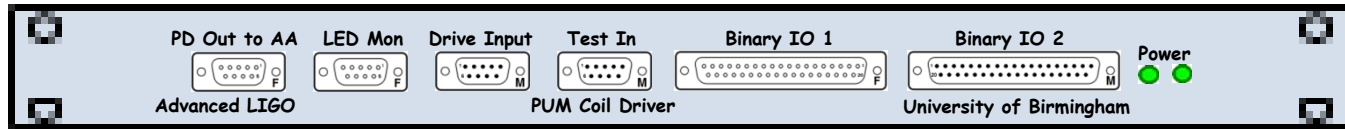

[D070483](#)
[D070480](#)
Front

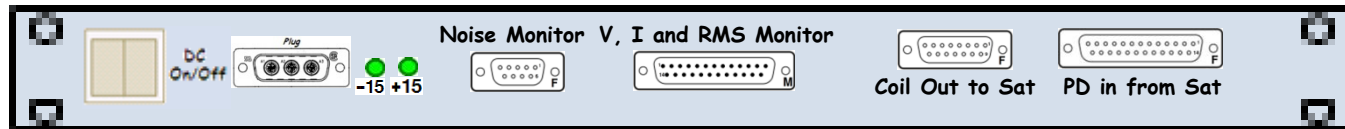
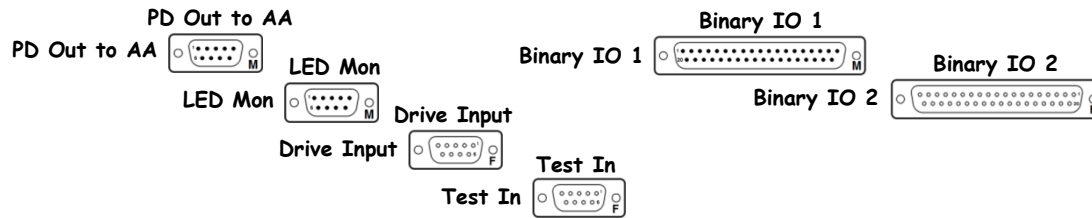

[S1101561](#)
Rear

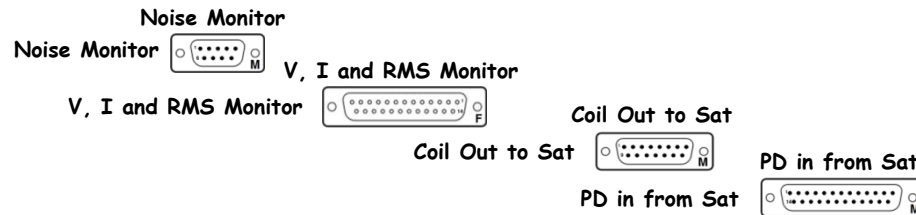

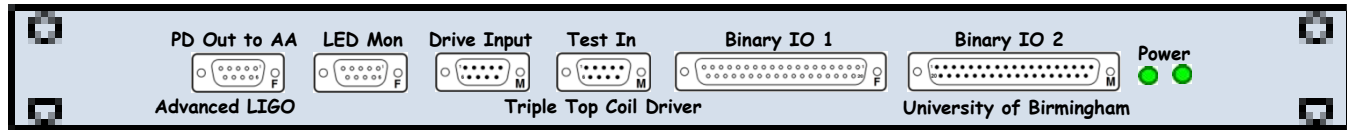

D1001242

Front

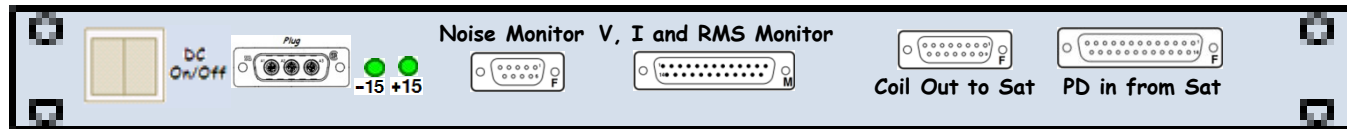
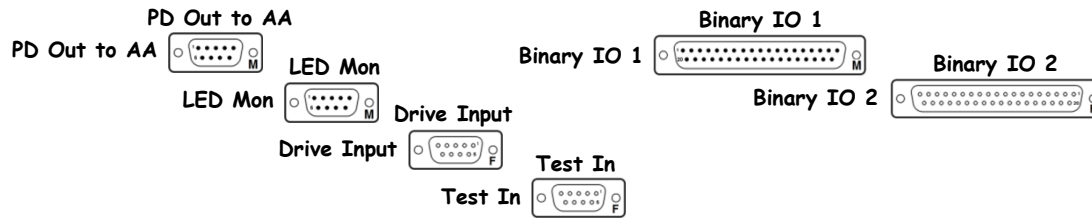

S1000265

Rear

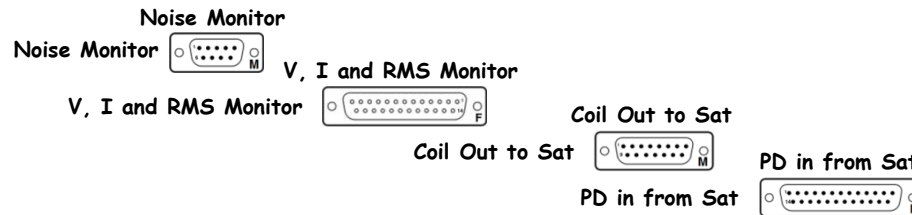

[Driver Board: D0902747](#)

[Monitor Board: D070480](#)

D1001242 - S1000258



<< L1-SUS-C5

BS Triple Top Coil Driver Chassis D1001242 S1000258 ±18VDC

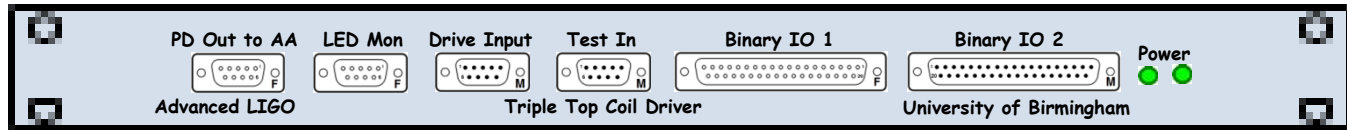

D1001242

Front

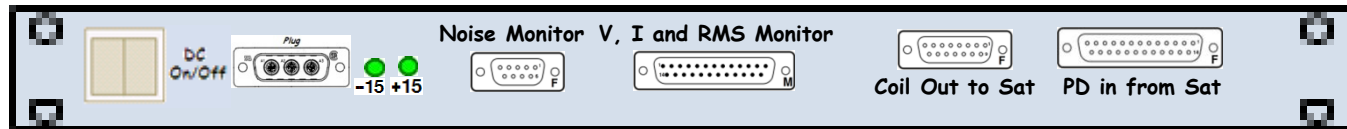
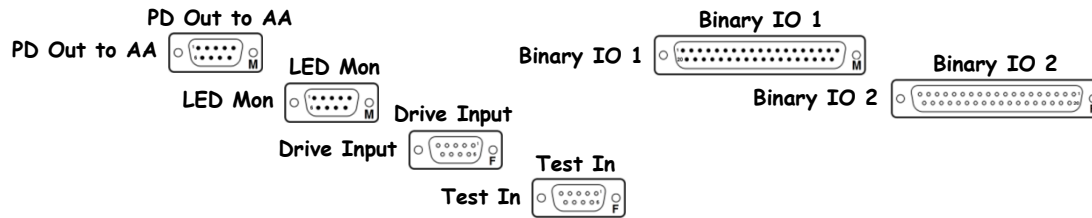

S1000258

Rear

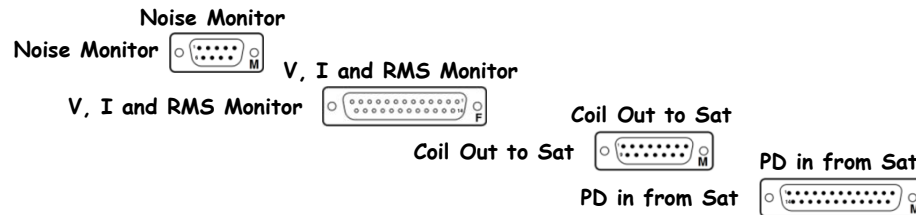

[Driver Board: D0902747](#)

[Monitor Board: D070480](#)

This number is actually correct. The DocDB part number is erroneously D090006 because it got assigned before the Wizards decided there would be 5 digits, and they won't fix it. I've asked.

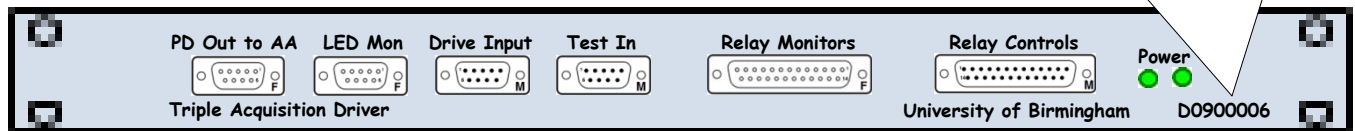

[D0900006](#)

Front

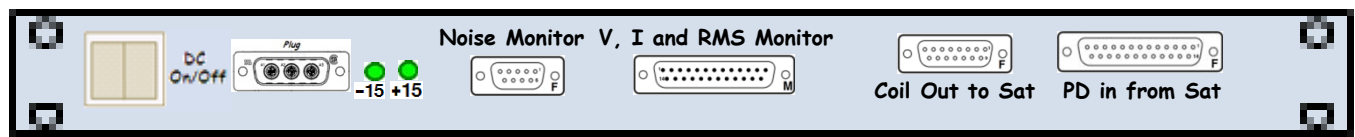
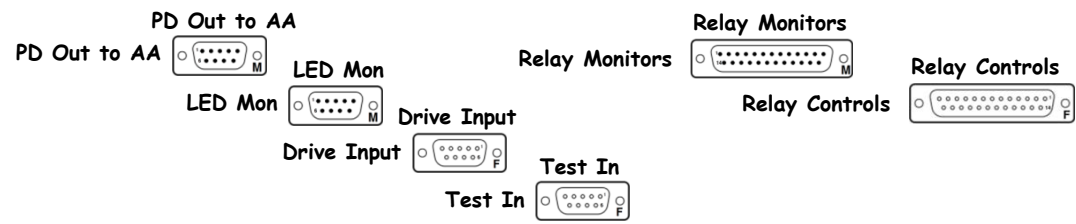

[S1001110](#)

Rear

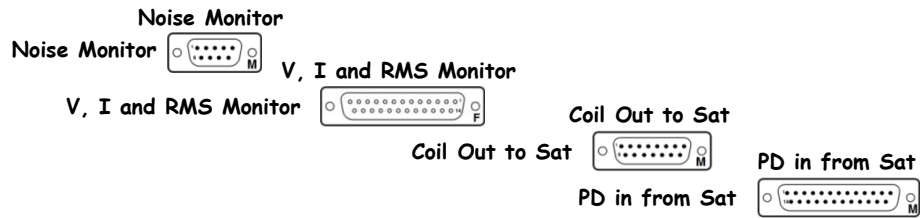

[Driver Board: D0901047](#)
[Monitor Board: D070480](#)



D1001715

Front

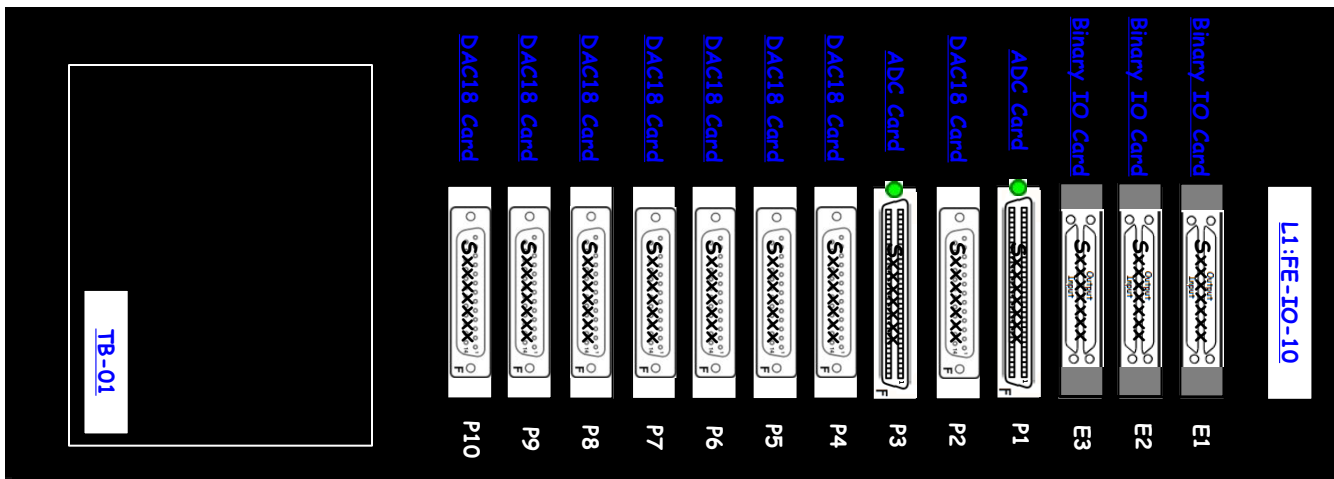

S1001143

Rear

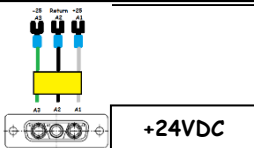
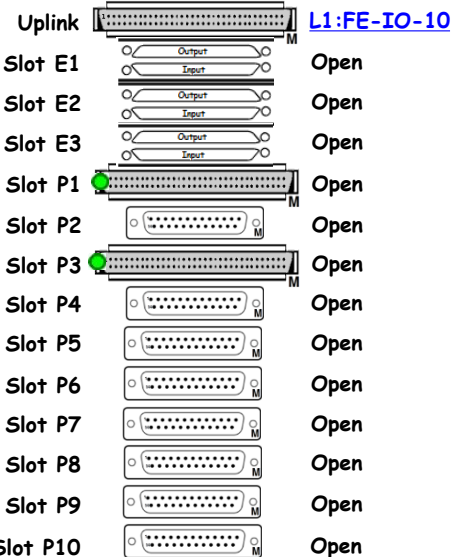

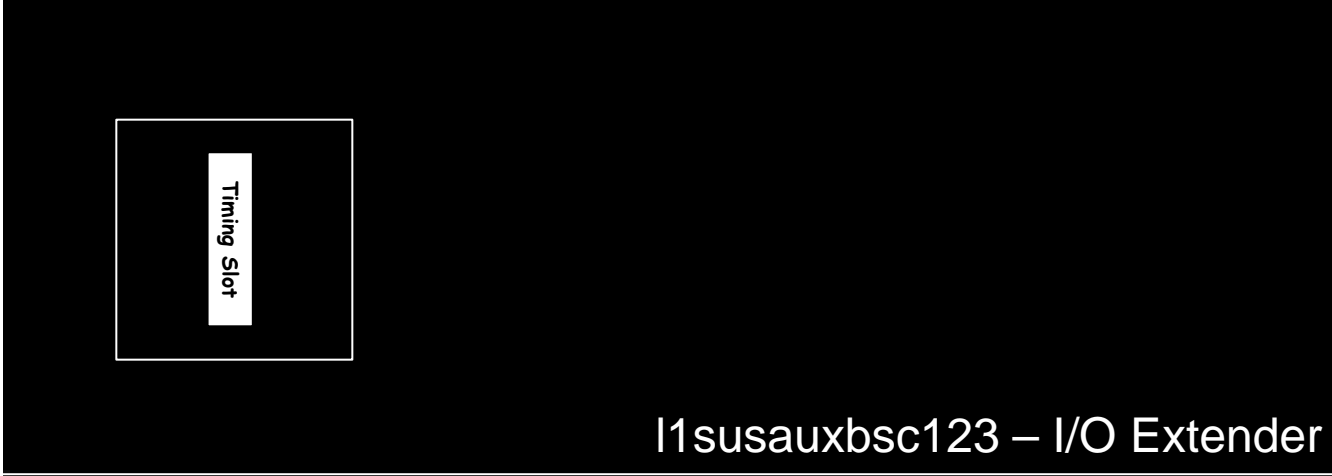

D1001715

Front

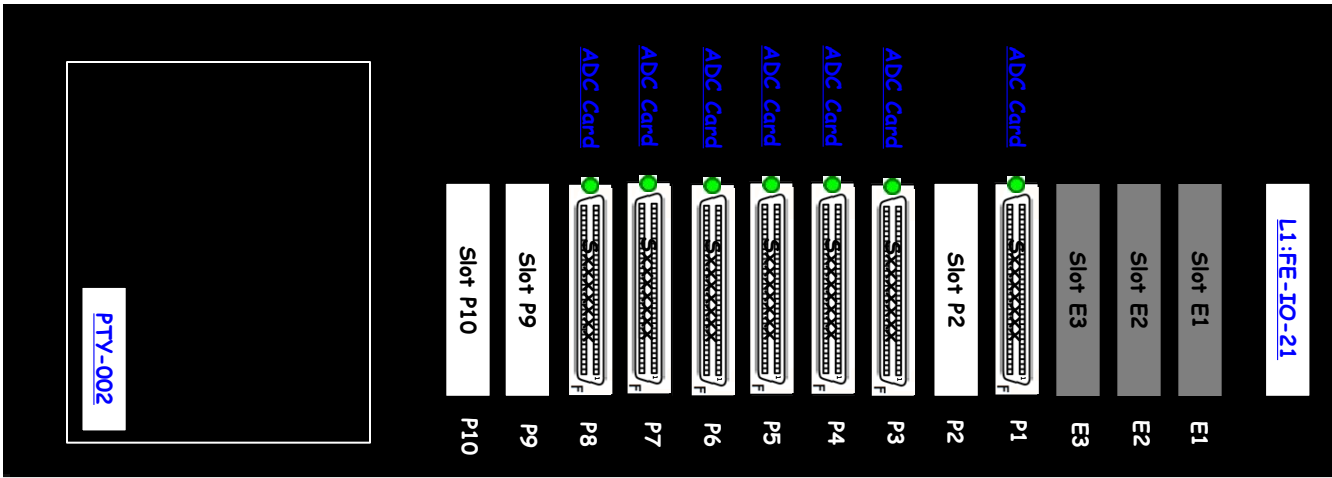

S1103888

Rear

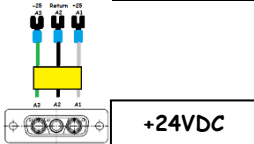
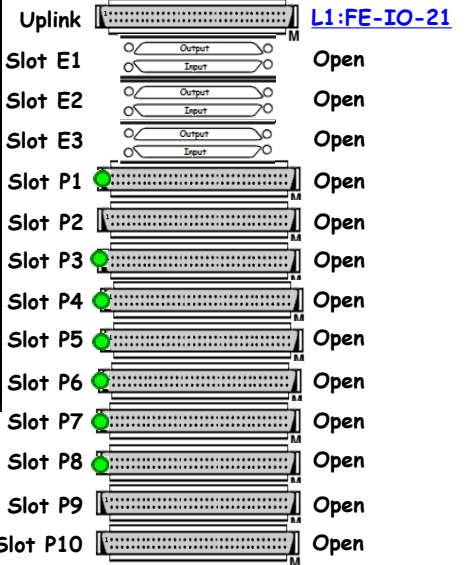

L1-SUS-C6 Details

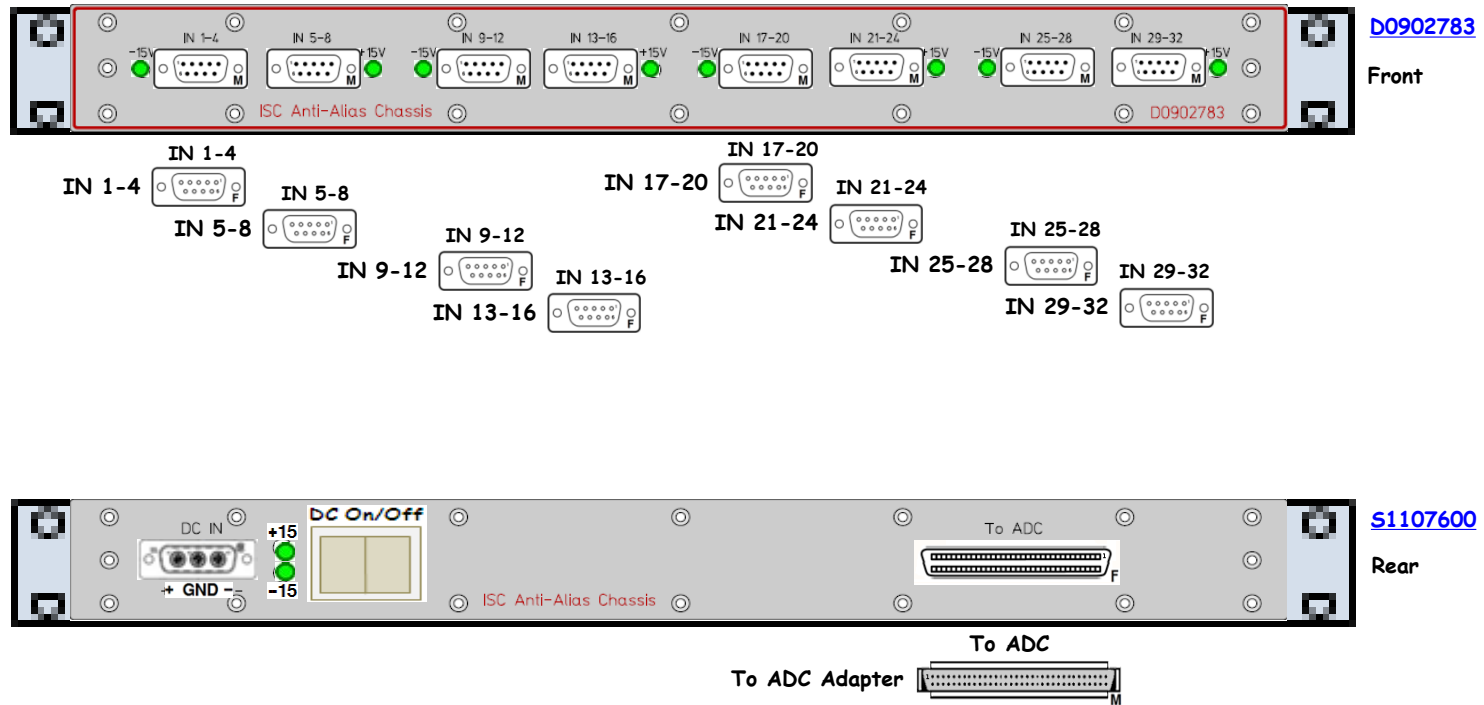

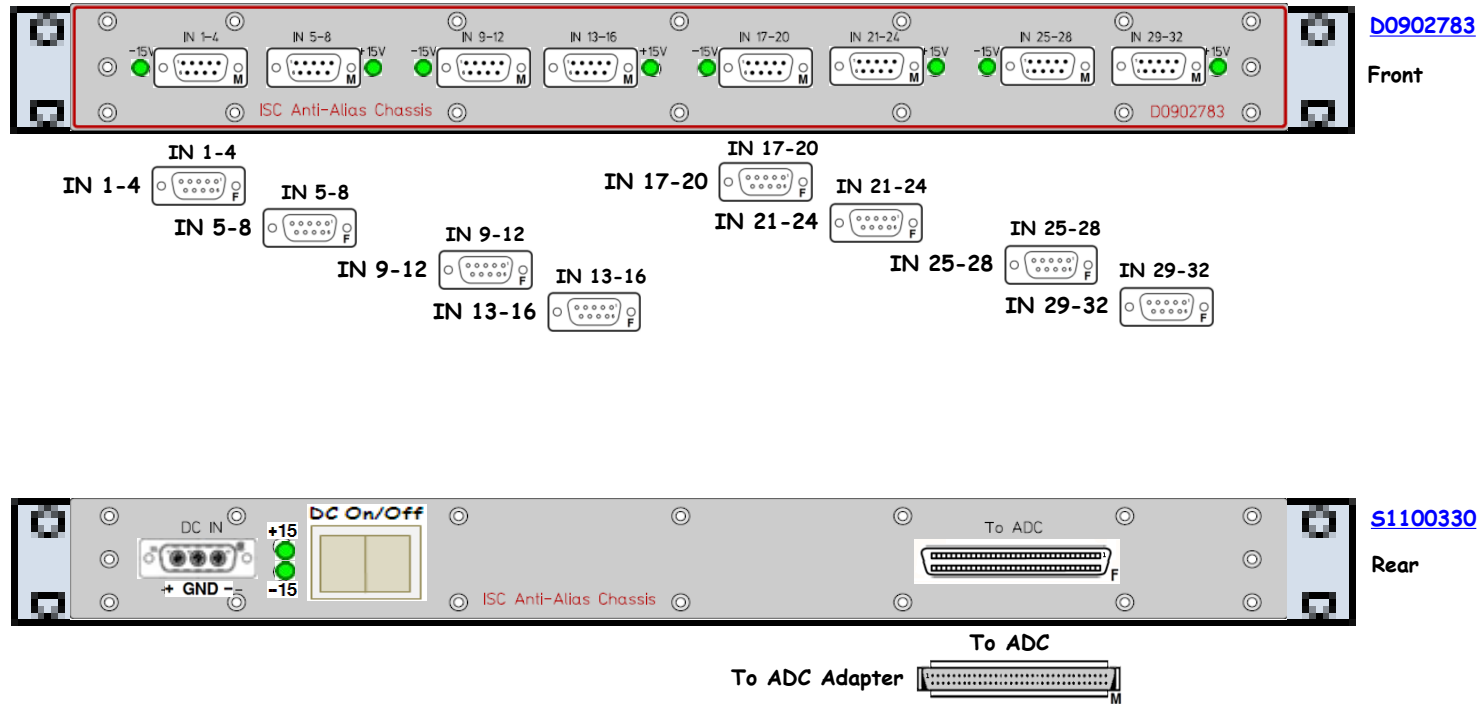

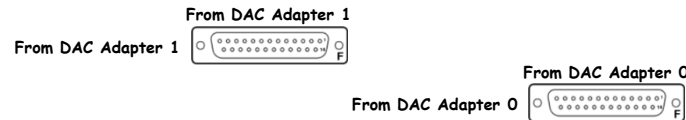
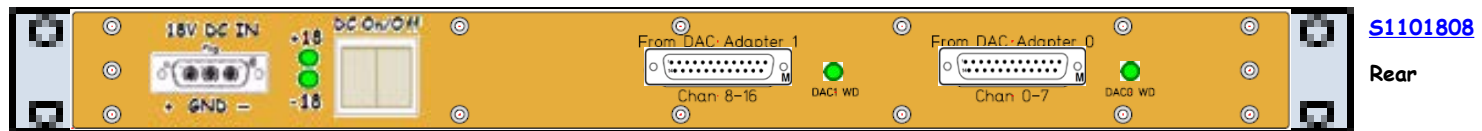
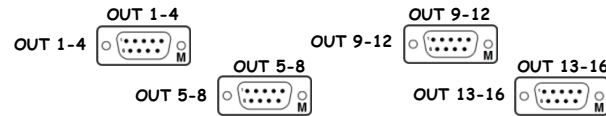
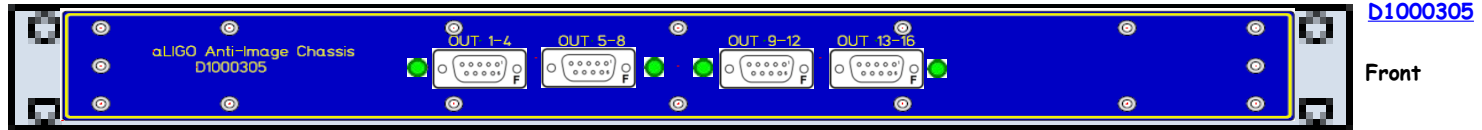

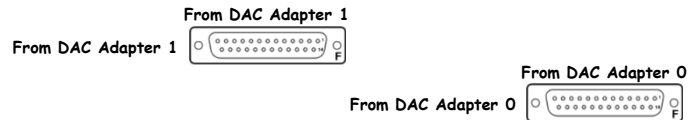
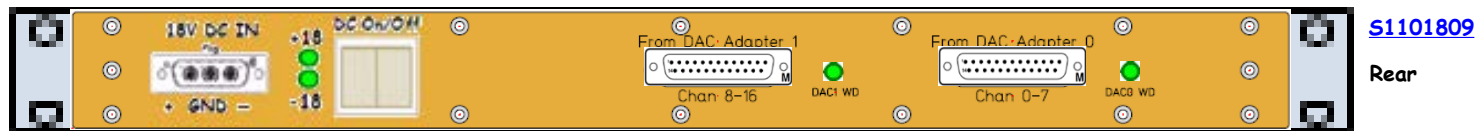
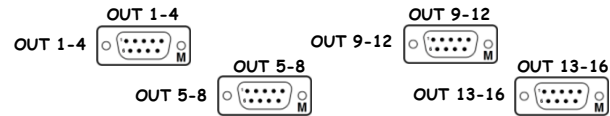
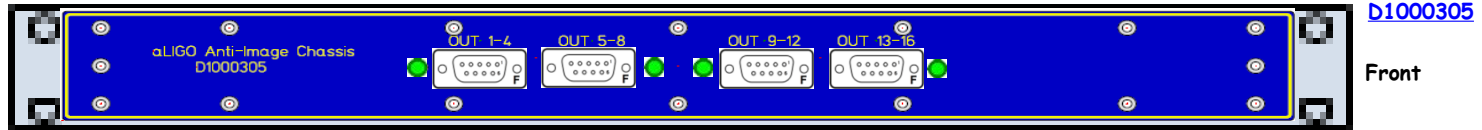

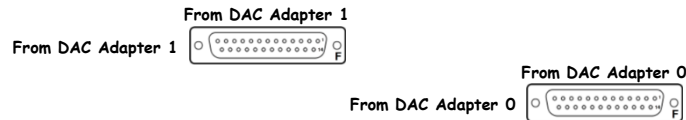
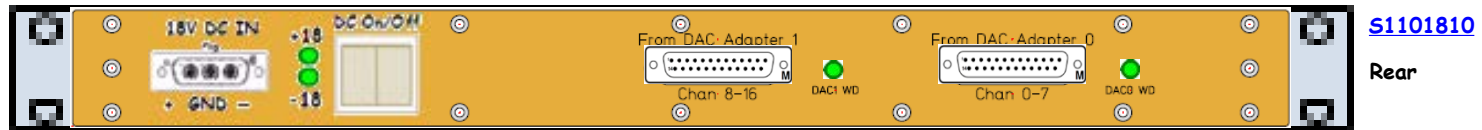
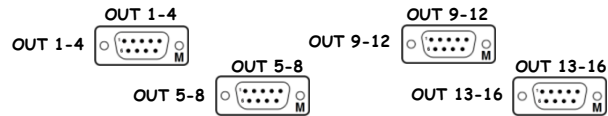
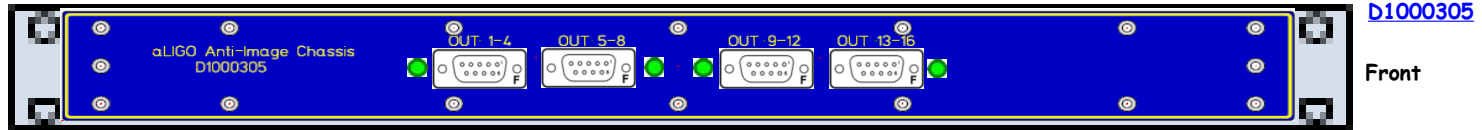

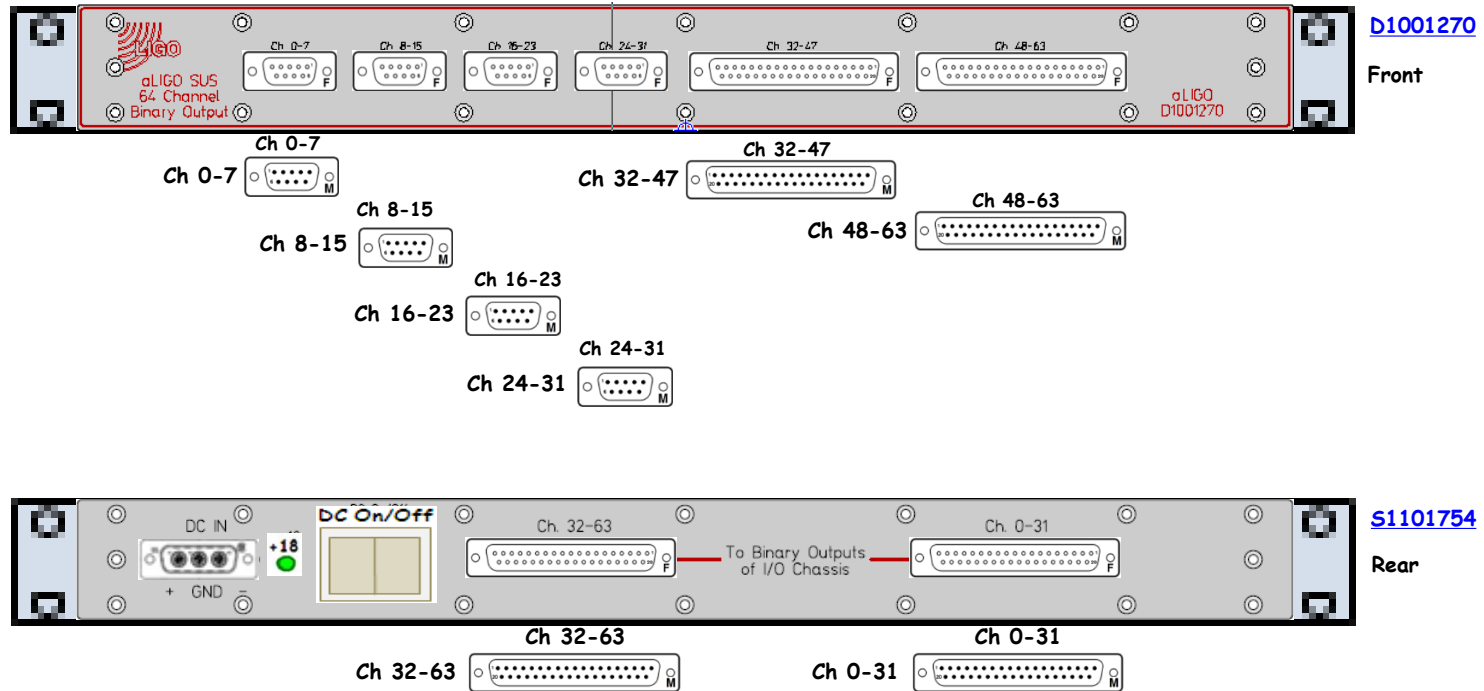

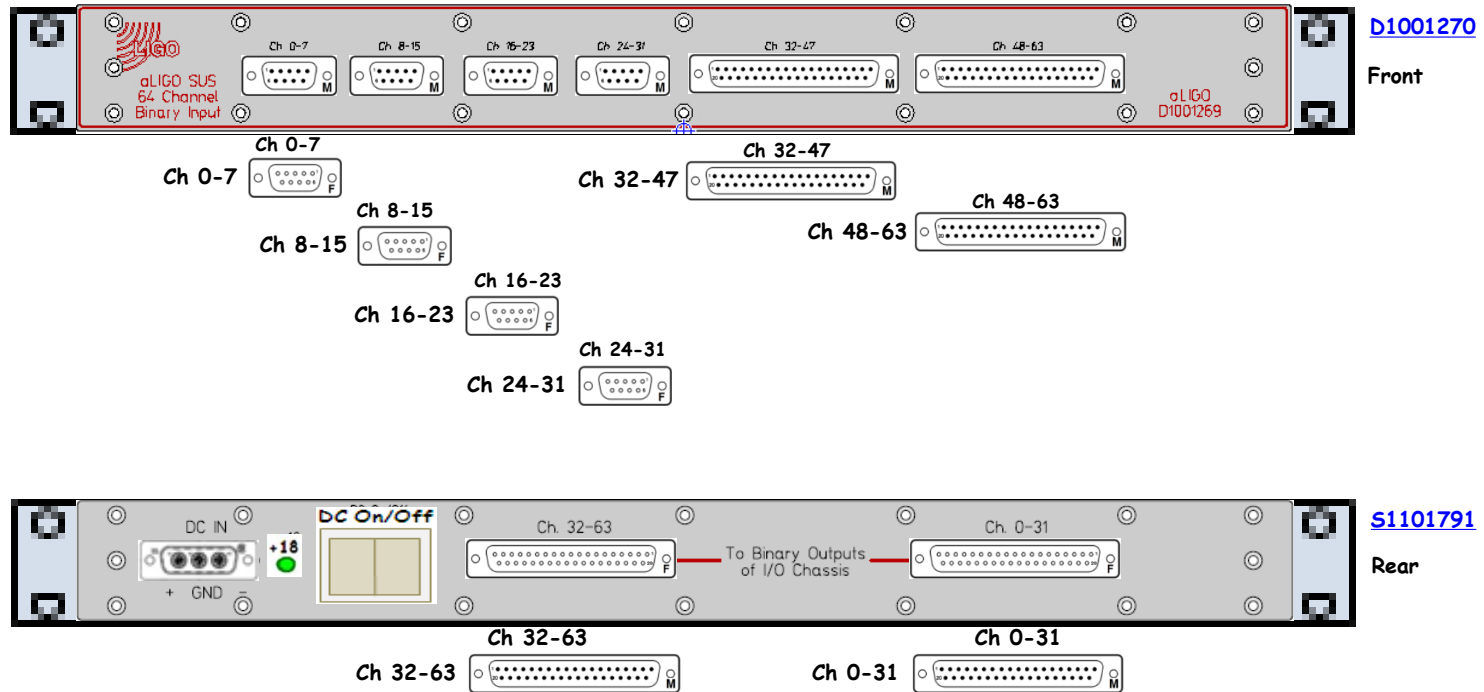

D1001270

Front

S1101791

Rear

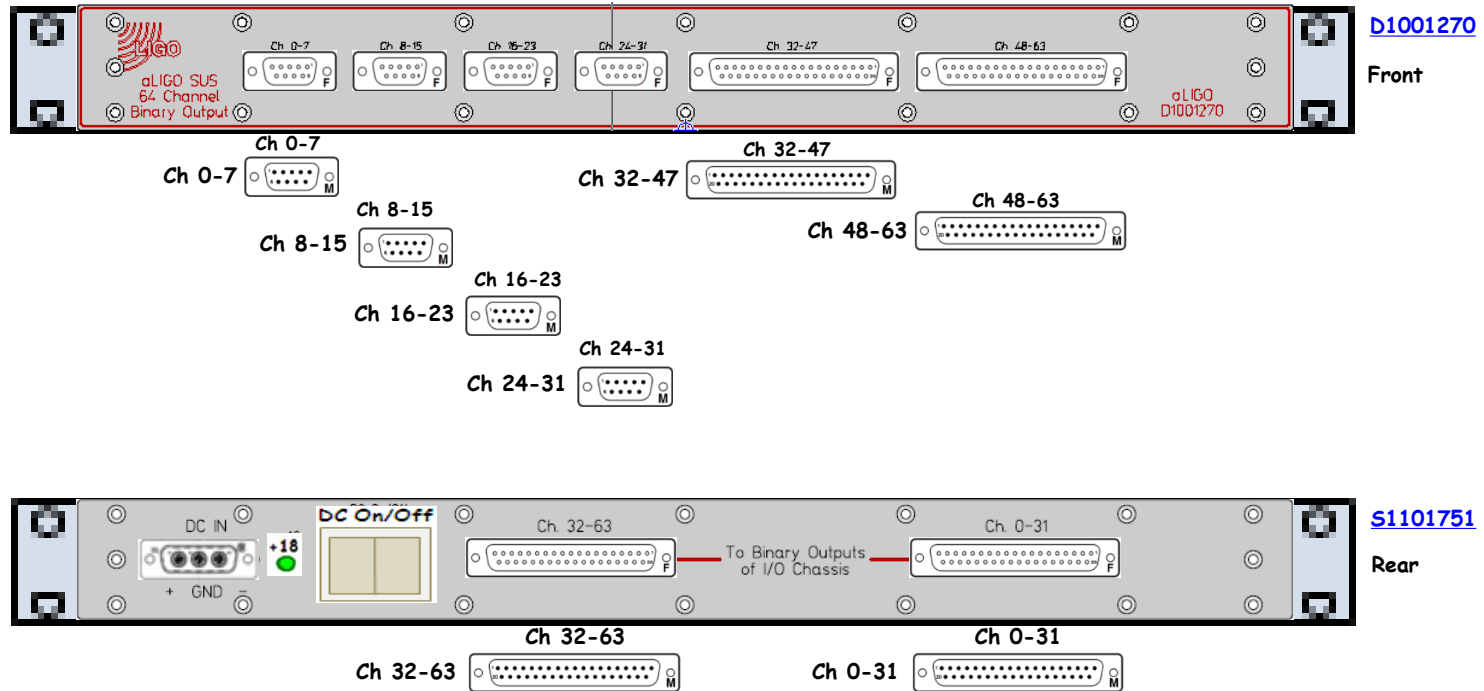

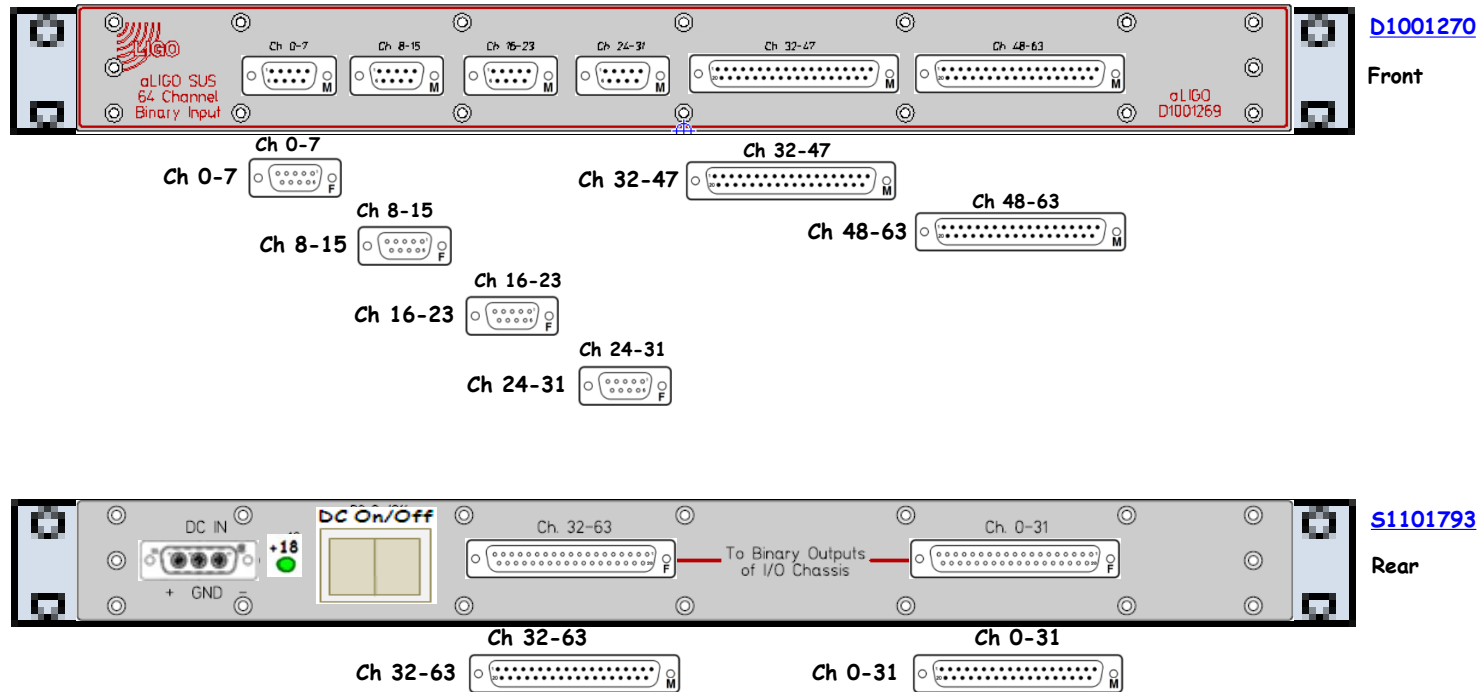

Binary Output Chassis D1000725 S1101783 ±18VDC

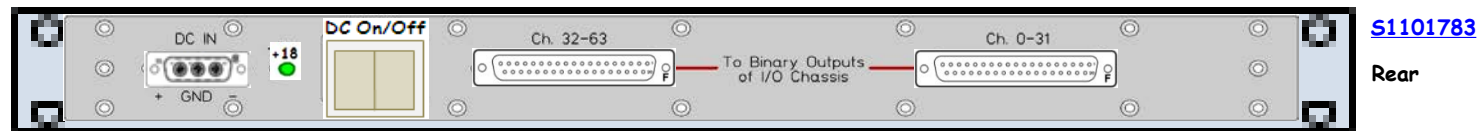
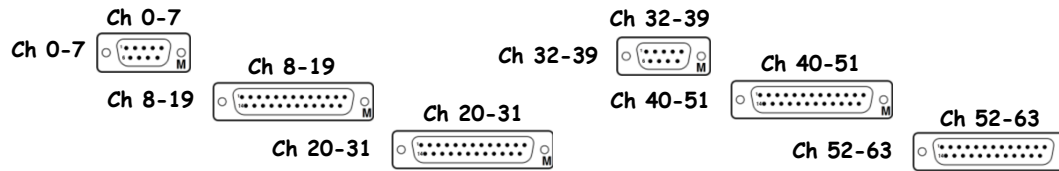
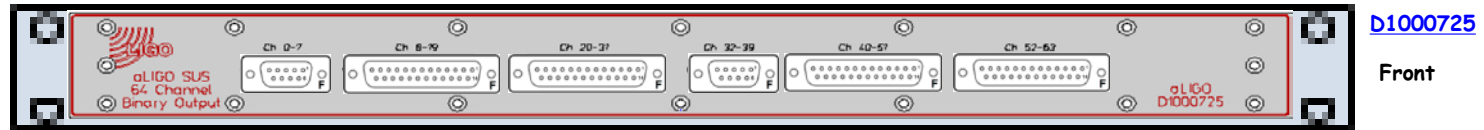

Binary Input Chassis D1000726 S1101803 ±18VDC

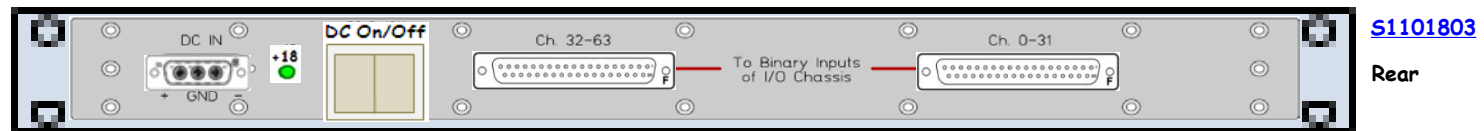
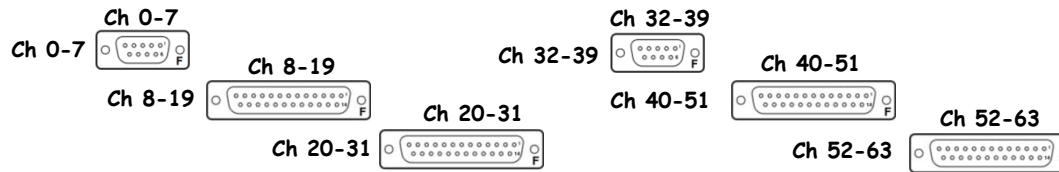
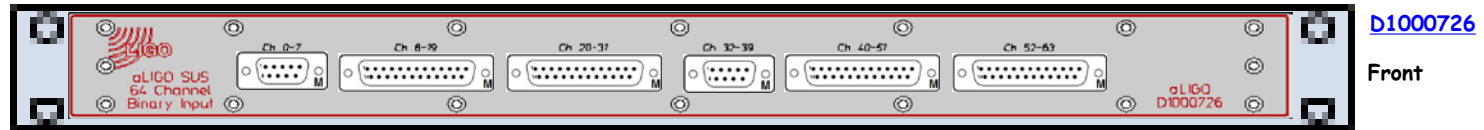

D1000726

Front

S1101803

Rear

D1100815 is an AI, which means it has **OUTPUTS**, not **INPUTS**. The labels are incorrect.

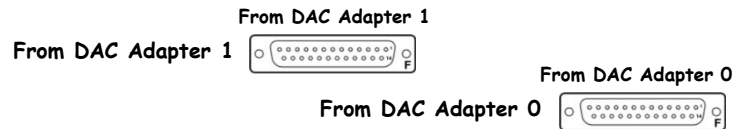
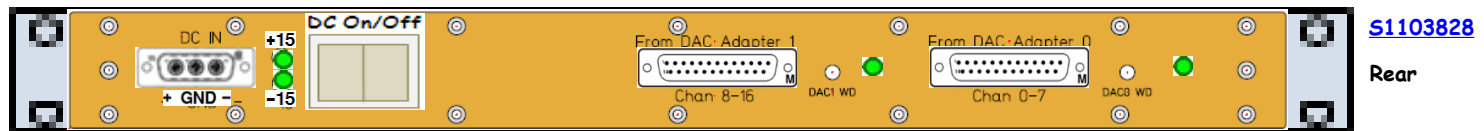
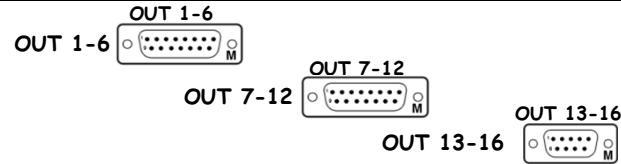
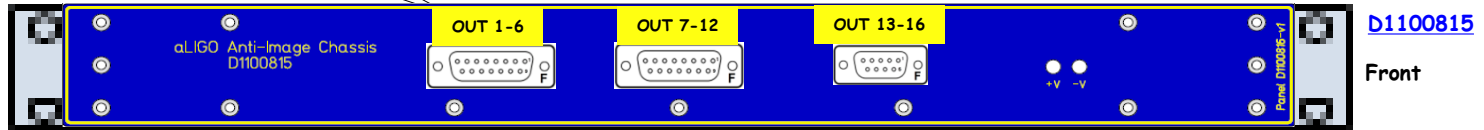

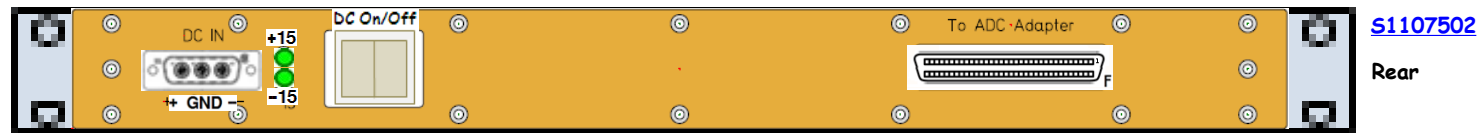
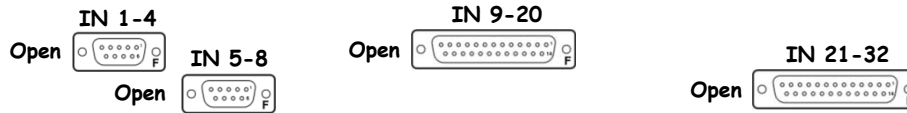

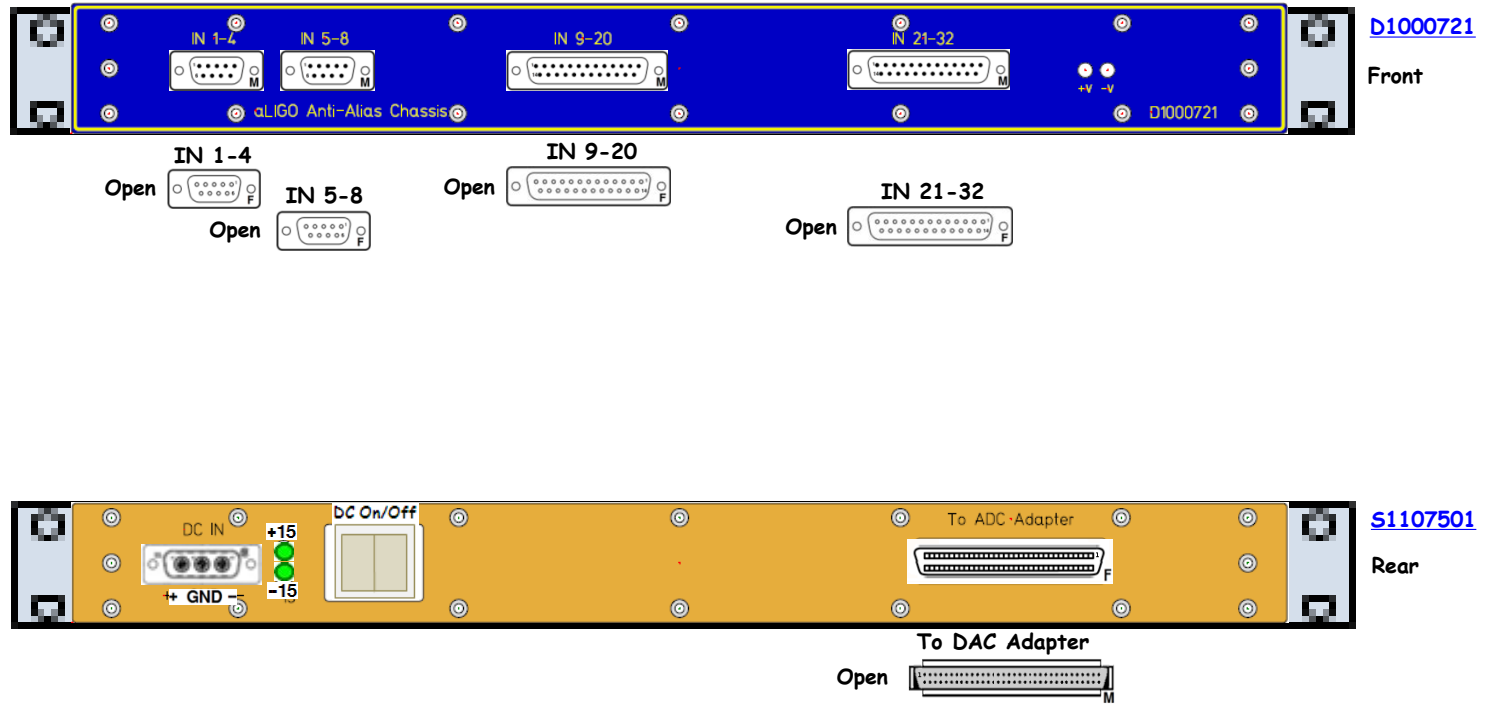

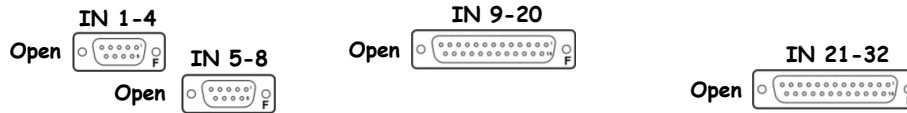

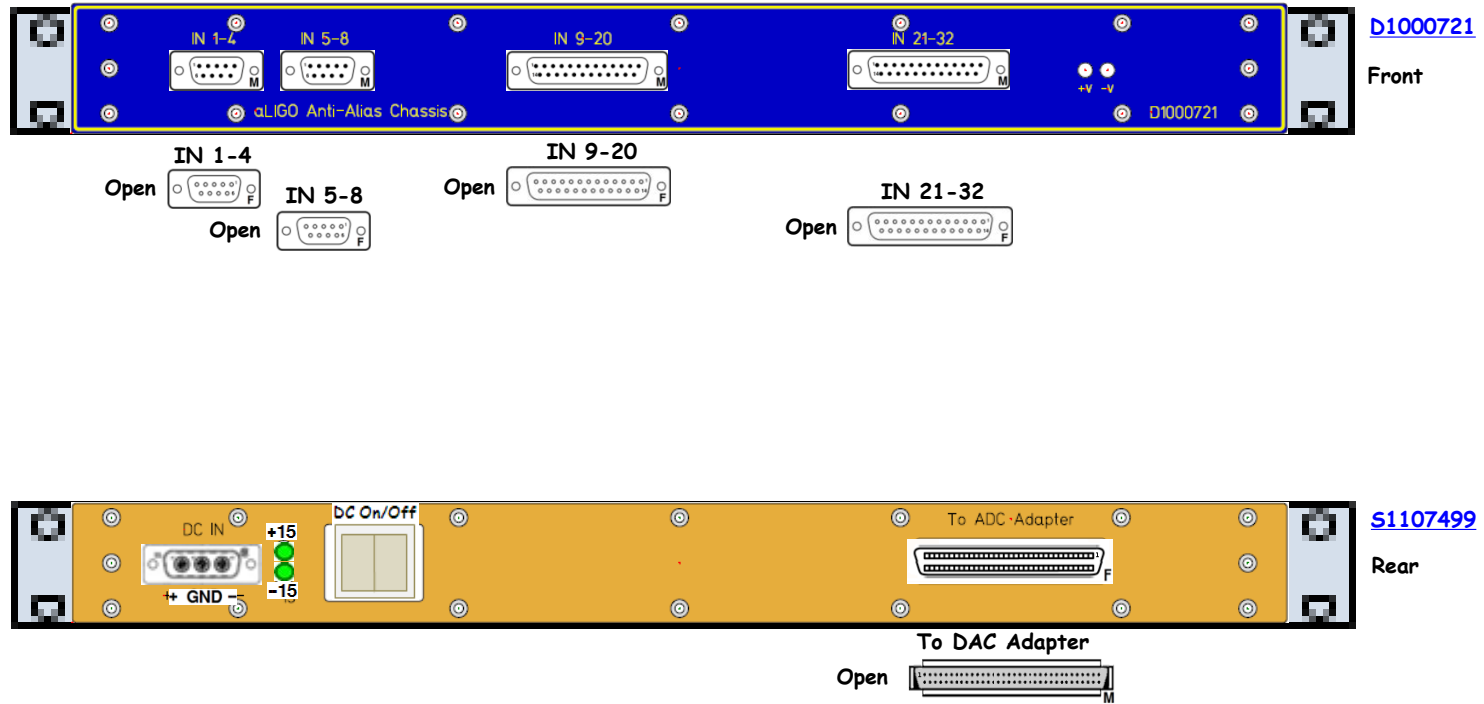

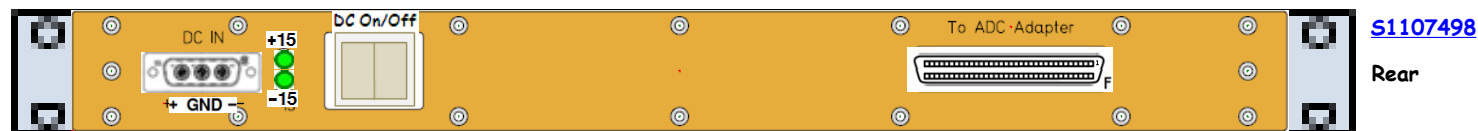
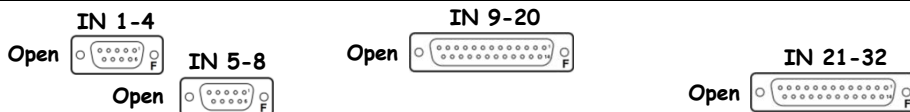
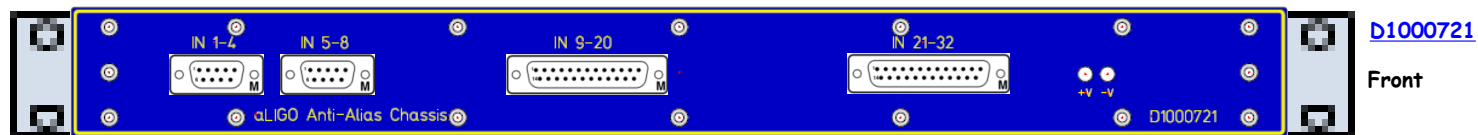

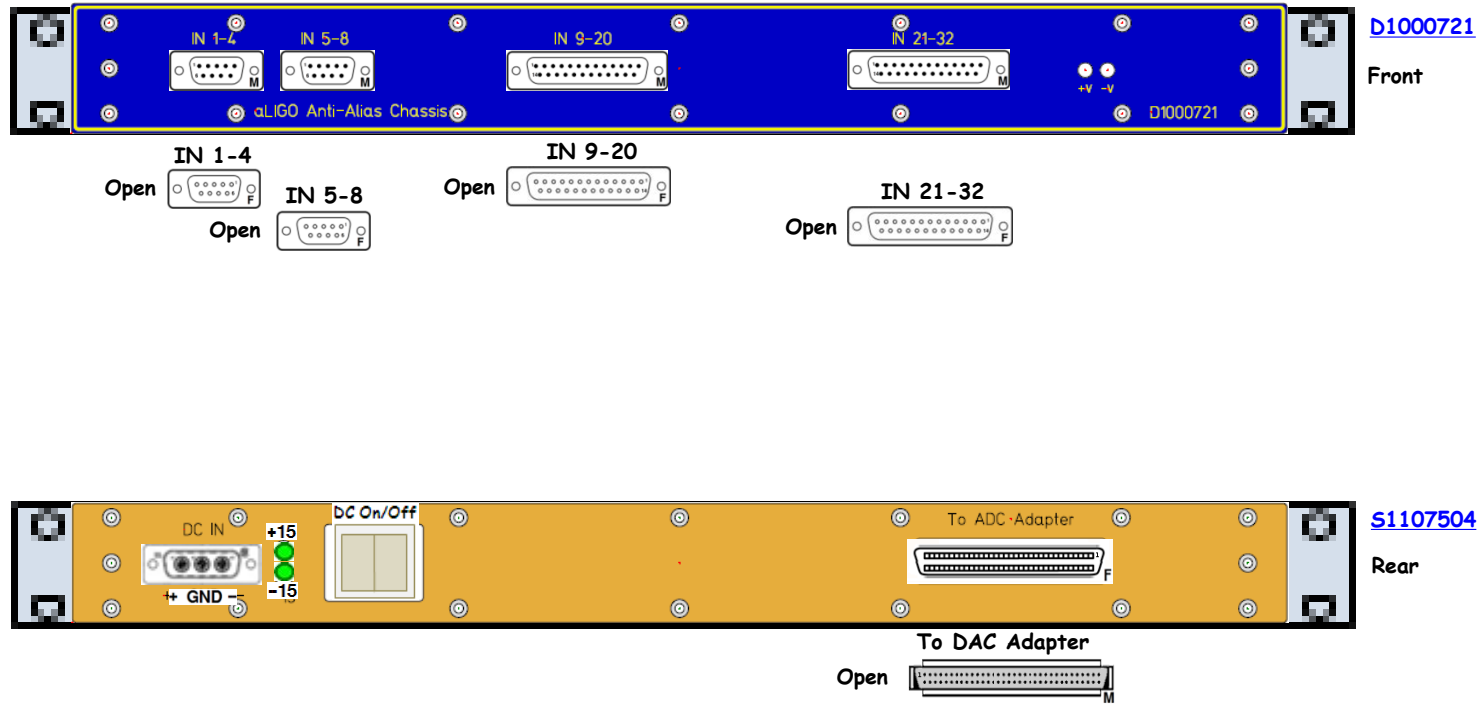

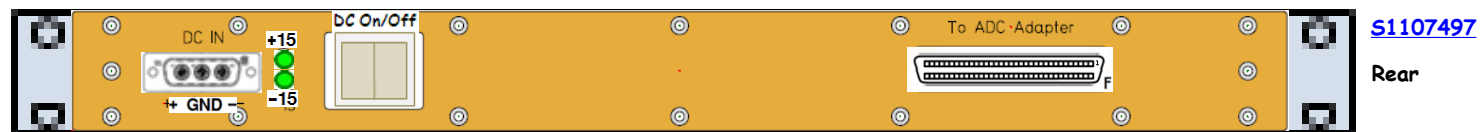
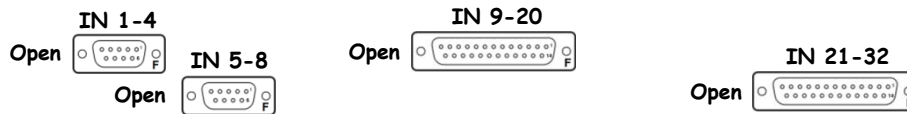

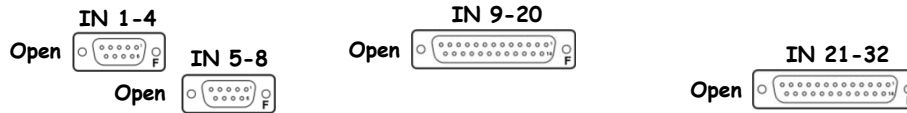

		42			
SR3-SRM Triple Top Coil Driver Chassis	D1001242	41	S1000255		±18VDC
SR3-SRM Triple Top Coil Driver Chassis	D1001242	40	S1000268		±18VDC
SR3-SRM Triple Top Coil Driver Chassis	D1001242	39	S1100254		±18VDC
		38			
OMC Triple Top Coil Driver Chassis	D1100304	37	S1101565		±18VDC
OMC Triple Top Coil Driver Chassis	D1100304	36	S1101567		±18VDC
		35			
FE ADC0 Anti-Alias Chassis	D0902783	34	S1001149		±18VDC
FE ADC1 Anti-Alias Chassis	D0902783	33	S1100328		±18VDC
		32			
FE DAC0, FE DAC1 Anti-Image Chassis	D1000305	31	S1101812		±18VDC
FE DAC2, FE DAC3 Anti-Image Chassis	D1000305	30	S1101813		±18VDC
		29			
SR3 Mid Triple Acq Driver Chassis	D0900006	28	S1001190		±18VDC
SR3 Bot Triple Acq Driver Chassis	D0900006	27	S1001105		±18VDC
SRM Mid Triple Acq Driver Chassis	D0900006	26	S1001189		±18VDC
		25			
FE DAC4 Anti-Image Chassis	D1000305	24	S1101814		±18VDC
		23			
SRM Bot Triple Acq Driver Chassis	D0900006	22	S1001106		±18VDC
		21			
Binary Output Chassis	D1000725	20	S1201244		±18VDC
Binary Input Chassis	D1000726	19	S1201497		±18VDC
Binary Output Chassis (8*DB9)	D1002593	18	S1101774		±18VDC
Binary Input Chassis (8*DB9)	D1001726	17	S1101316		±18VDC
		16			
		15			
		14			
		13			
		12			
		11			
		10			
		9			
		8			
		7			
		6			
		5			
		4			
		3			
		2			
		1			
	Front		Rear		



PTO-002

L1-SUS-C7 Details

D1001242 - S1000255



<< L1-SUS-C7

SR3-SRM Triple Top Coil Driver Chassis D1001242 S1000255 ±18VDC

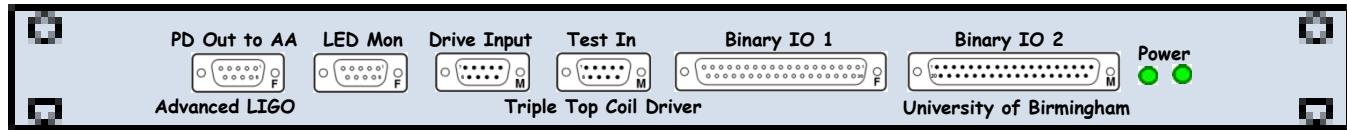

D1001242

Front

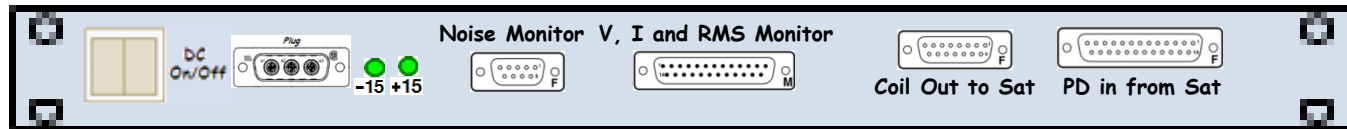
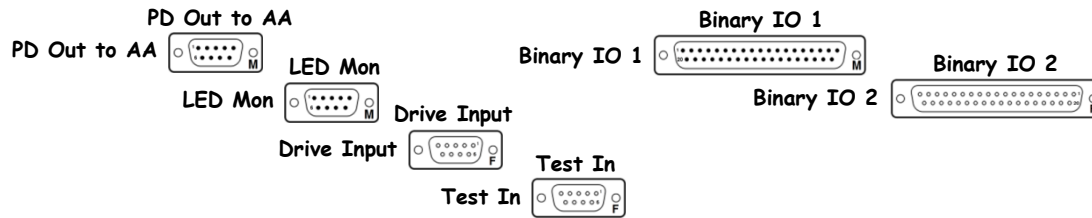

S1000255

Rear

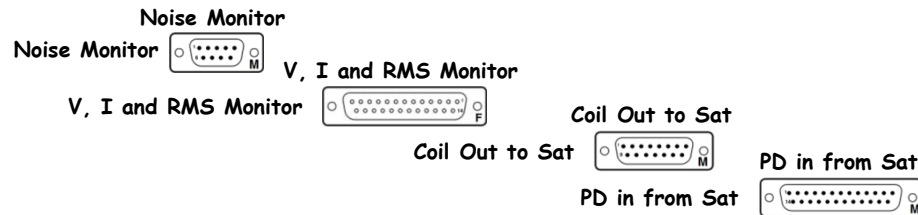

[Driver Board: D0902747](#)

[Monitor Board: D070480](#)

D1001242 - S1000268



<< L1-SUS-C7

SR3-SRM Triple Top Coil Driver Chassis D1001242 S1000268 ±18VDC

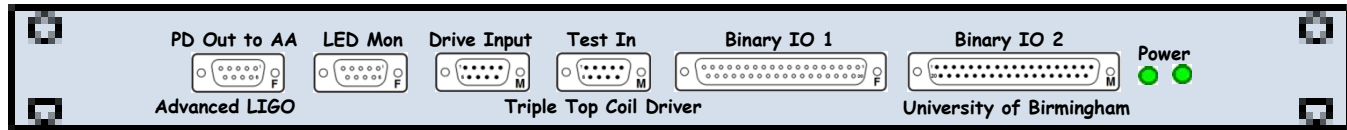

D1001242

Front

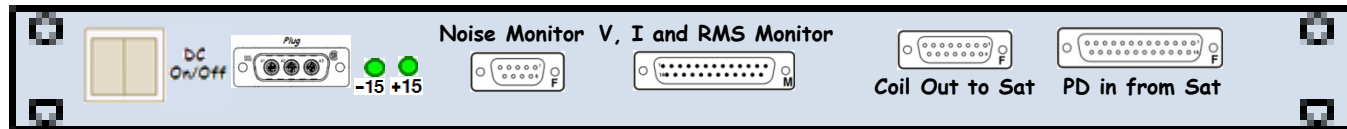
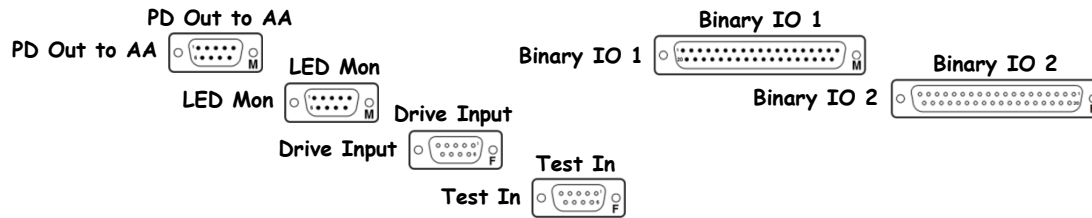

S1000268

Rear

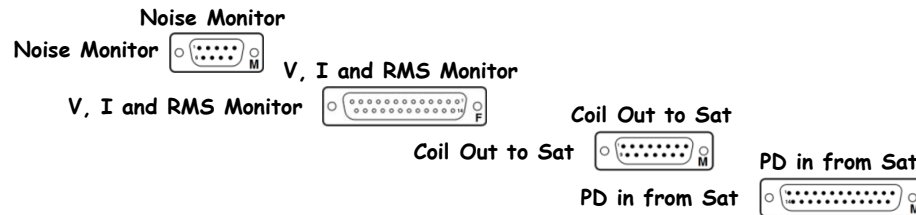

[Driver Board: D0902747](#)

[Monitor Board: D070480](#)

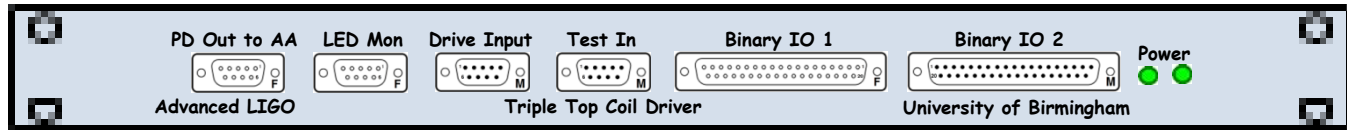

D1001242

Front

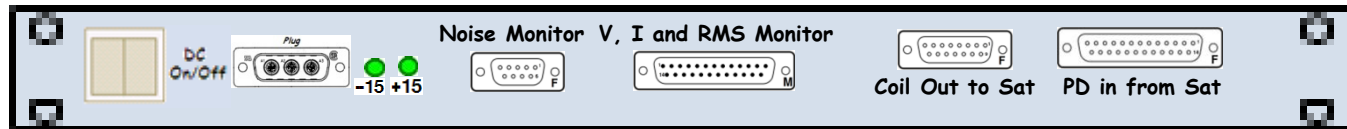
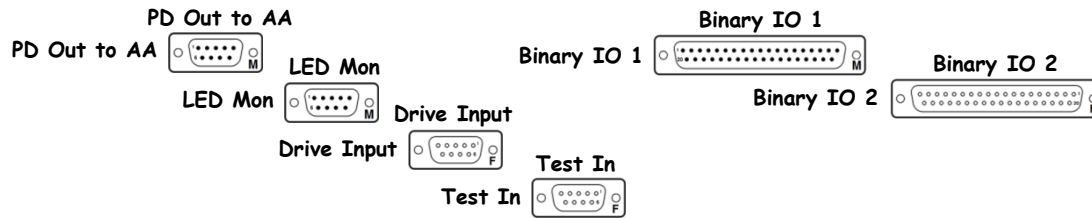

S1100254

Rear

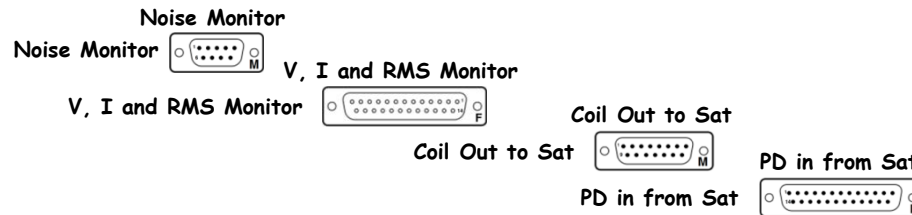

[Driver Board: D0902747](#)

[Monitor Board: D070480](#)

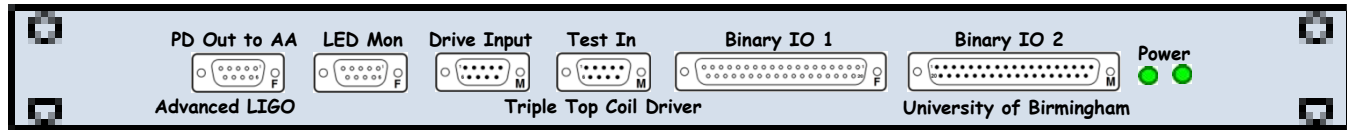

D1100304

Front

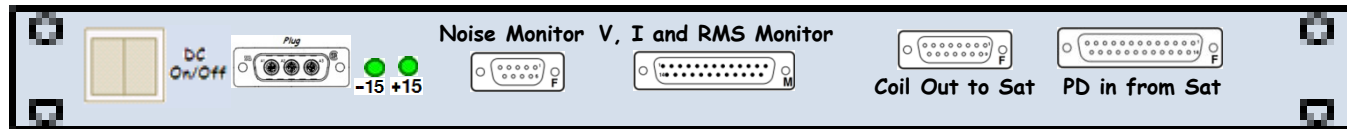
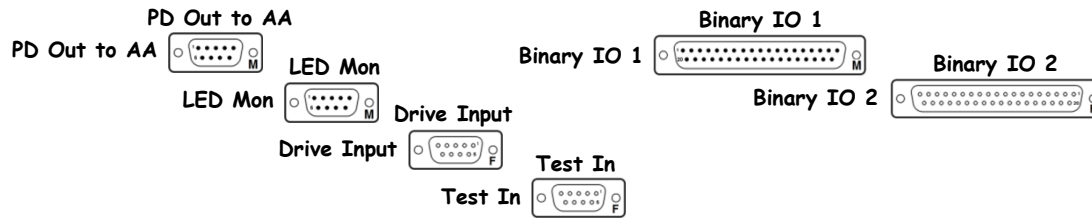

S1101565

Rear

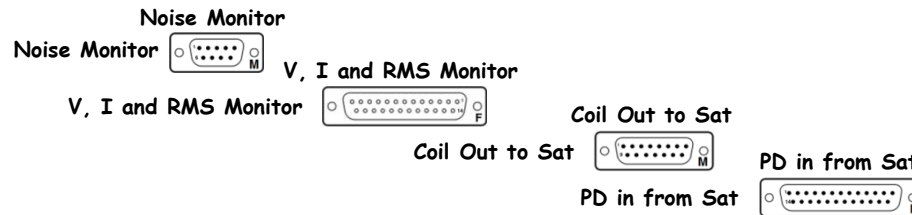

[Driver Board: D0902747](#)

[Monitor Board: D070480](#)

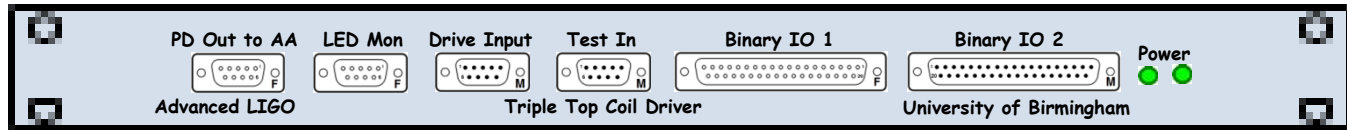

D1100304

Front

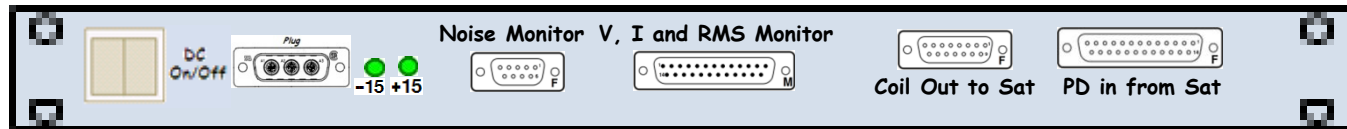
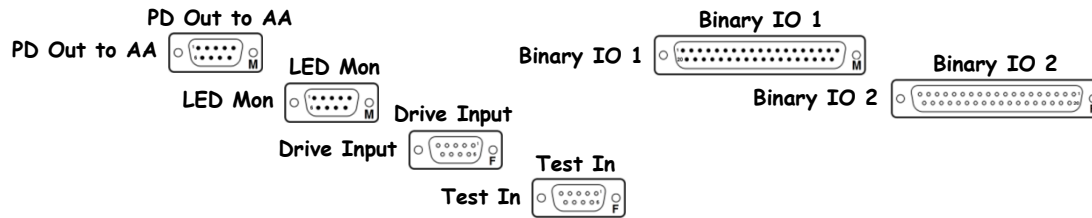

S1101567

Rear

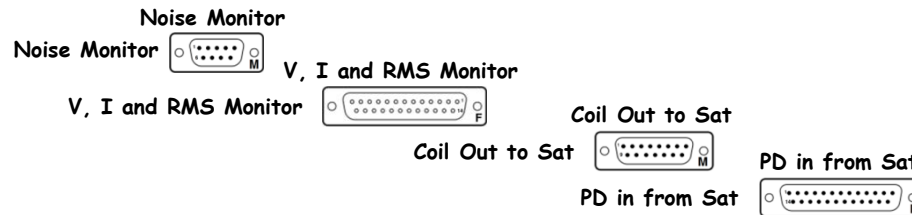

[Driver Board: D0902747](#)

[Monitor Board: D070480](#)

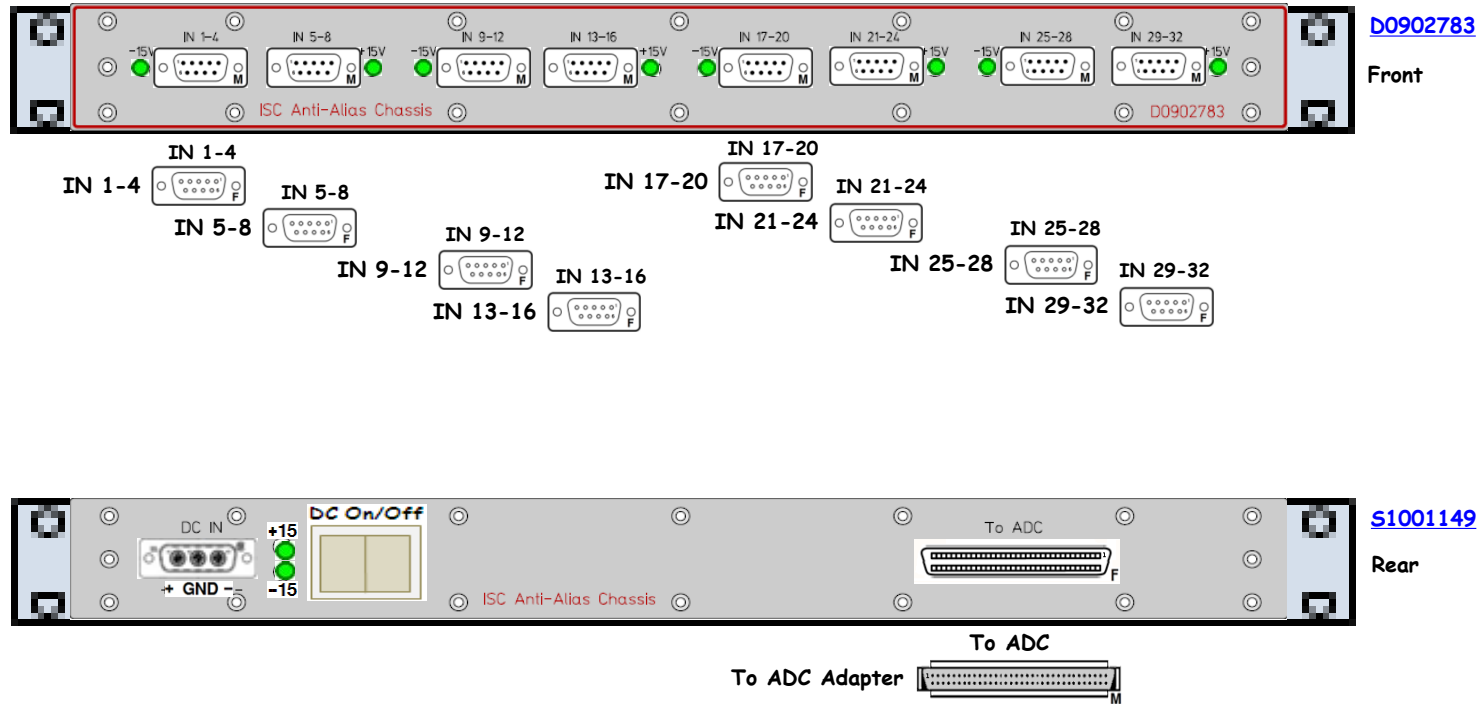

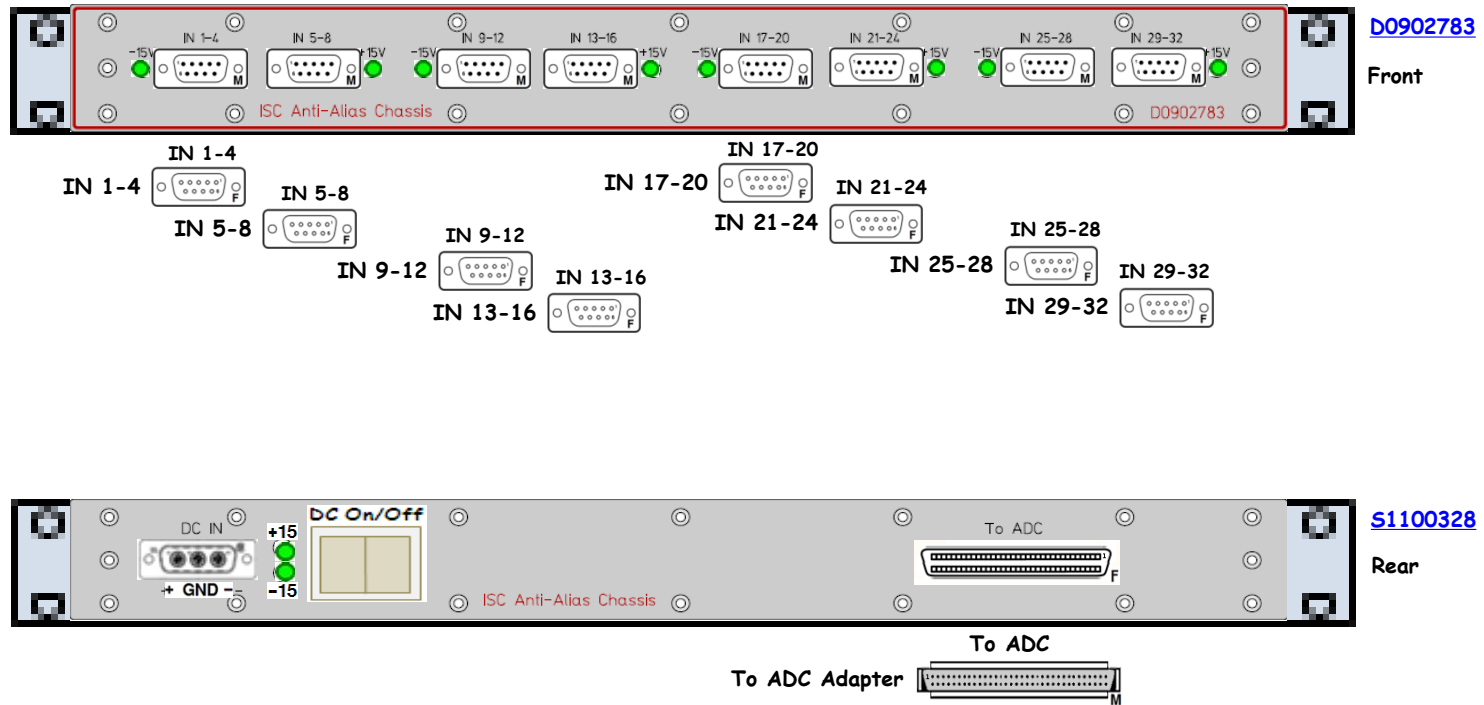

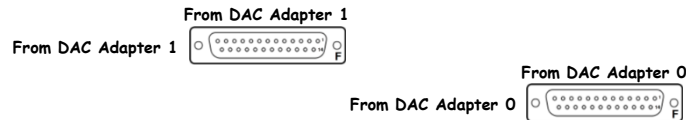
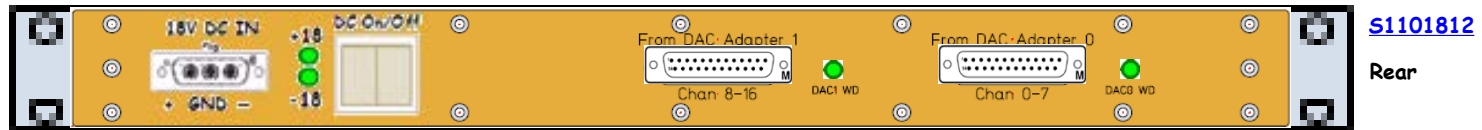
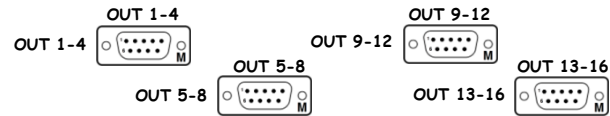
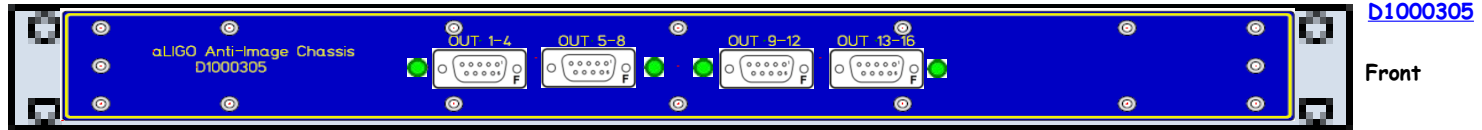

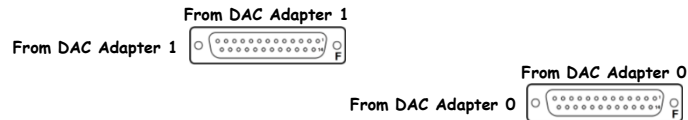
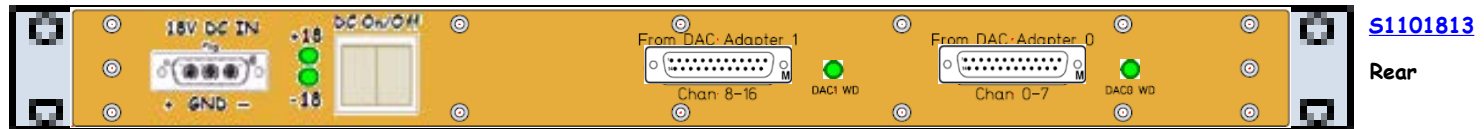
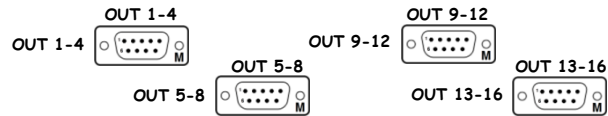
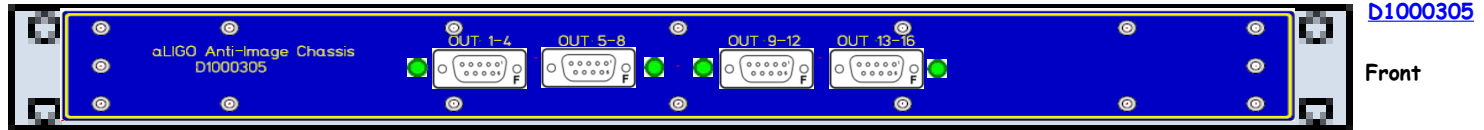

SR3 Mid Triple Acq Driver Chassis D0900006 S1001190 ±18VDC

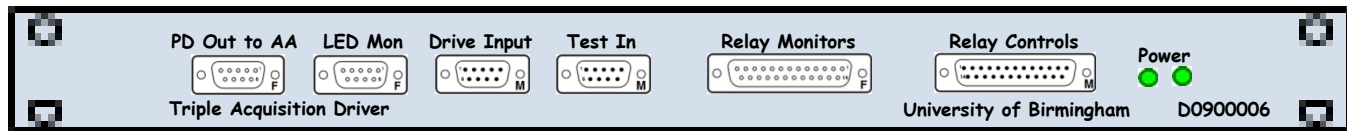

[D0900006](#)

Front

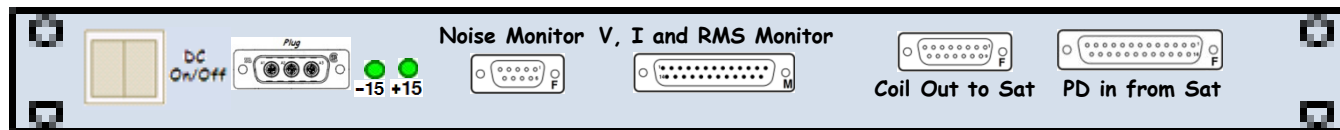
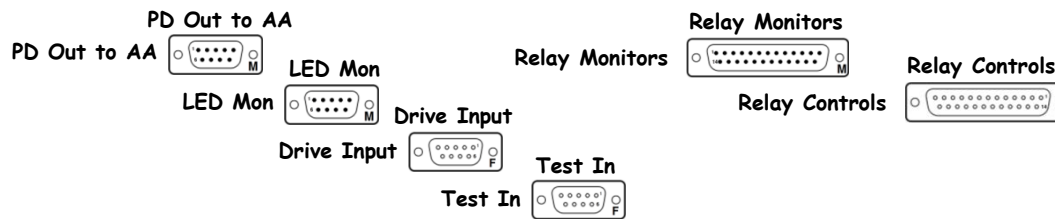

[S1001190](#)

Rear

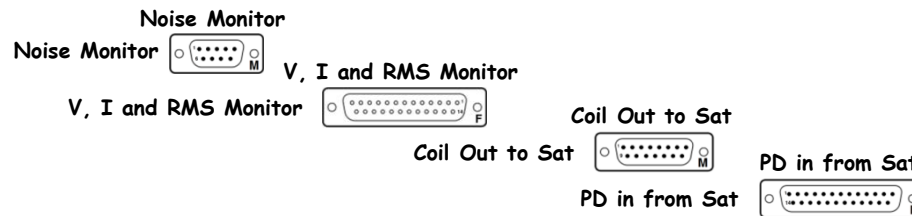

[Driver Board: D0901047](#)
[Monitor Board: D070480](#)

SR3 Bot Triple Acq Driver Chassis D0900006 S1001105 ±18VDC

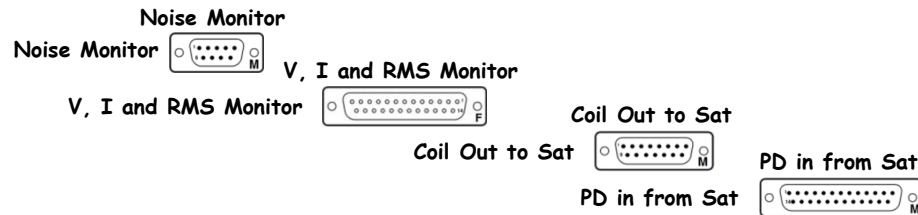
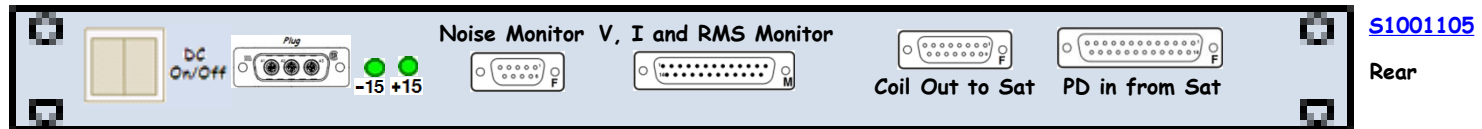
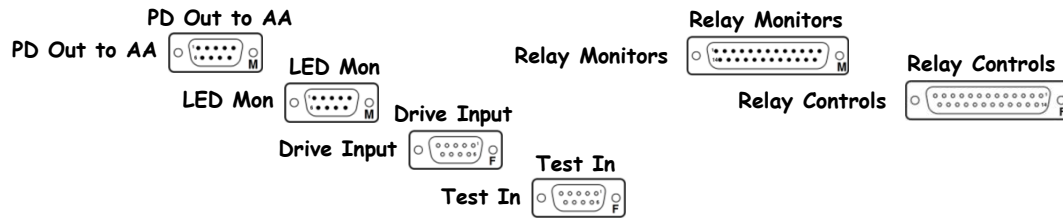
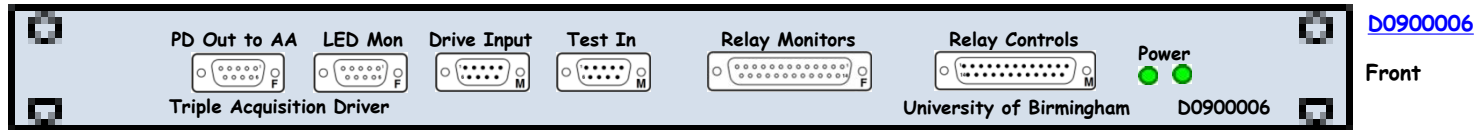

[Driver Board: D0901047](#)
[Monitor Board: D070480](#)

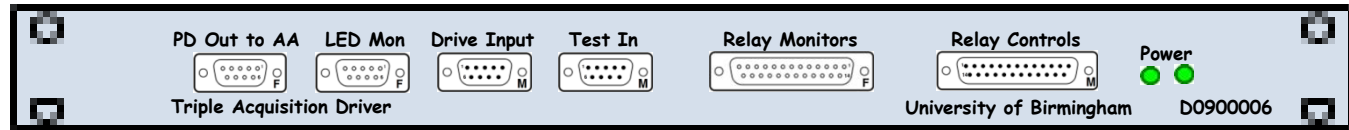

[D0900006](#)

Front

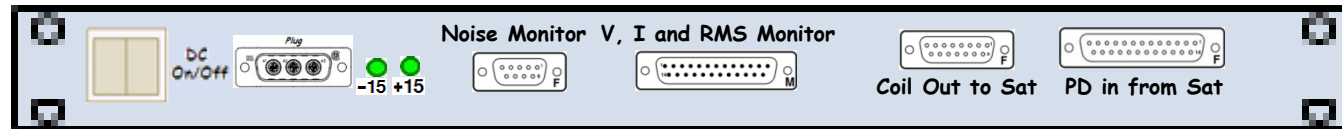
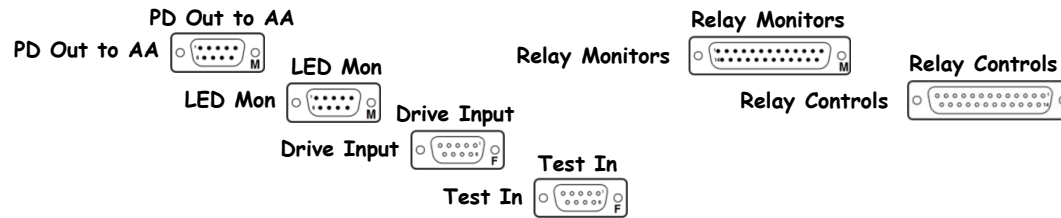

[S1001189](#)

Rear

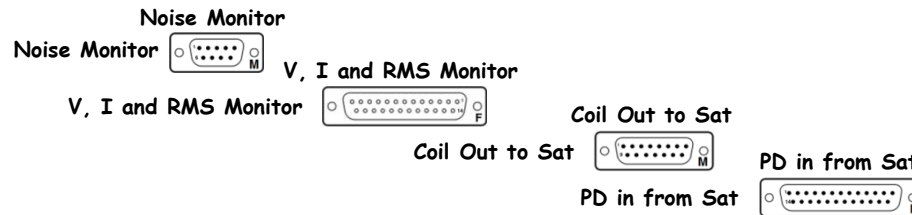

[Driver Board: D0901047](#)
[Monitor Board: D070480](#)

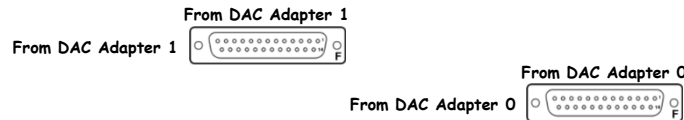
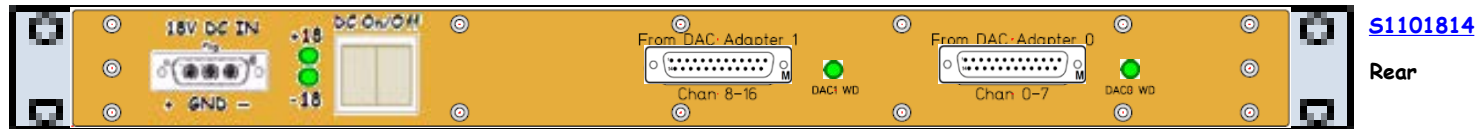
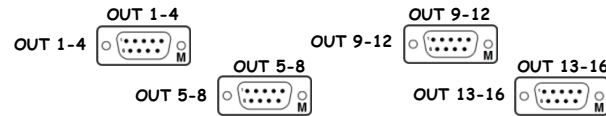
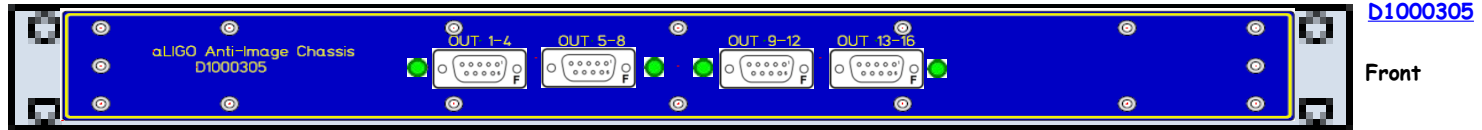

SRM Bot Triple Acq Driver Chassis D0900006 S1001106 ±18VDC

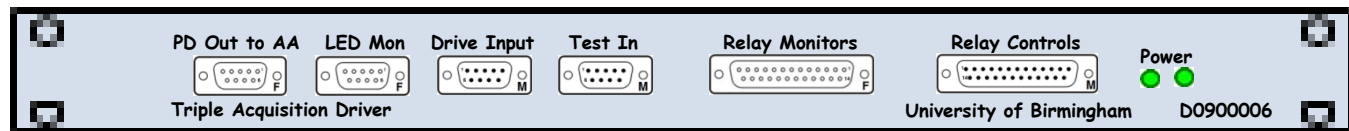

[D0900006](#)

Front

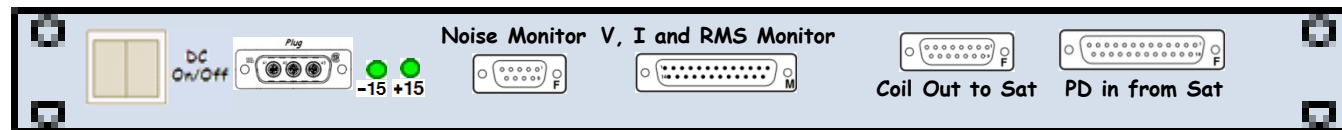
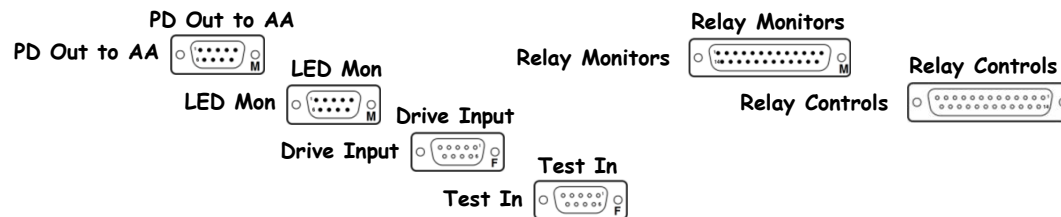

[S1001106](#)

Rear

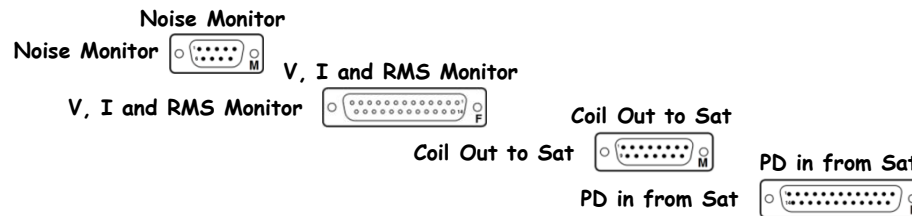

[Driver Board: D0901047](#)
[Monitor Board: D070480](#)

D1000725 - S1201244



<< L1-SUS-C7

Binary Output Chassis D1000725 S1201244 ±18VDC

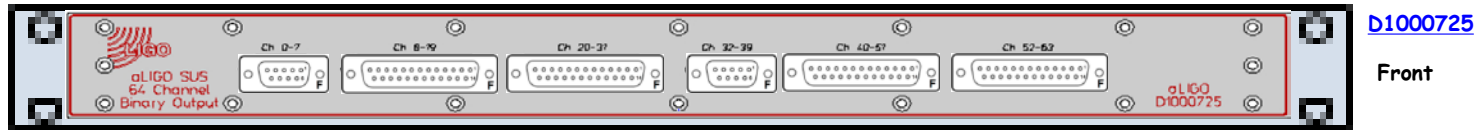

D1000725

Front

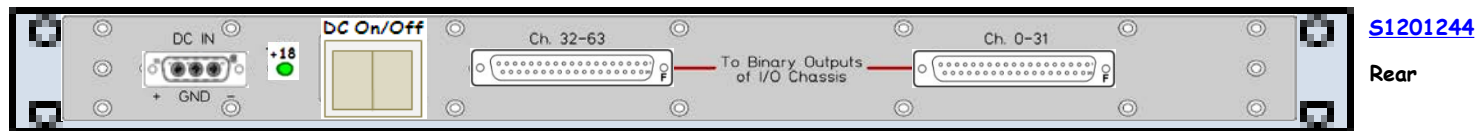
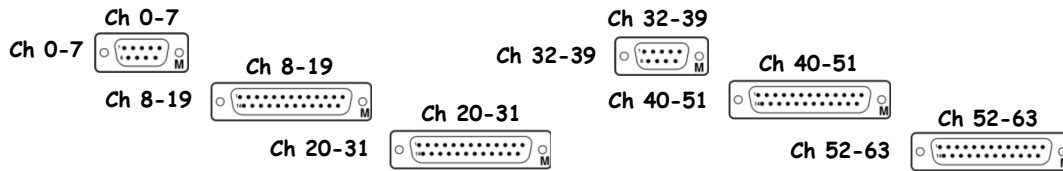

S1201244

Rear



Binary Input Chassis D1000726 S1201497 ±18VDC

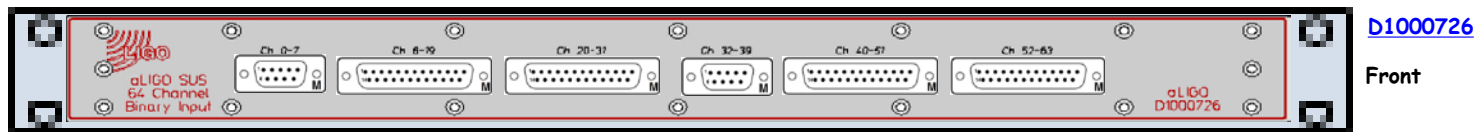

D1000726

Front

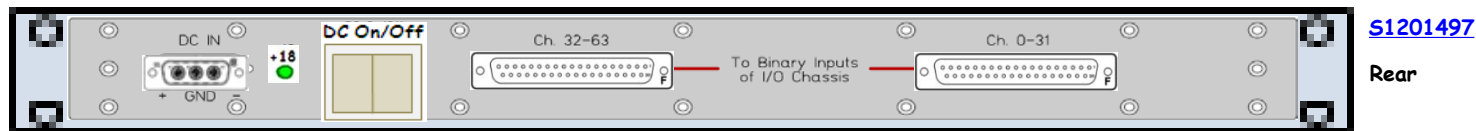
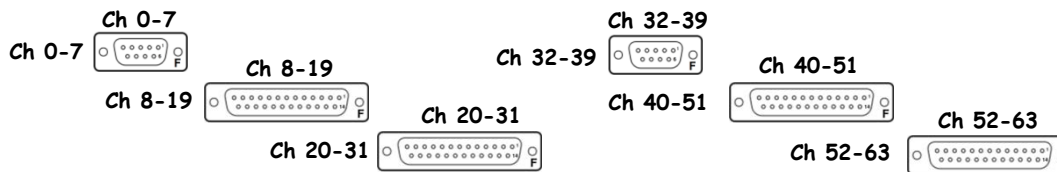

S1201497

Rear



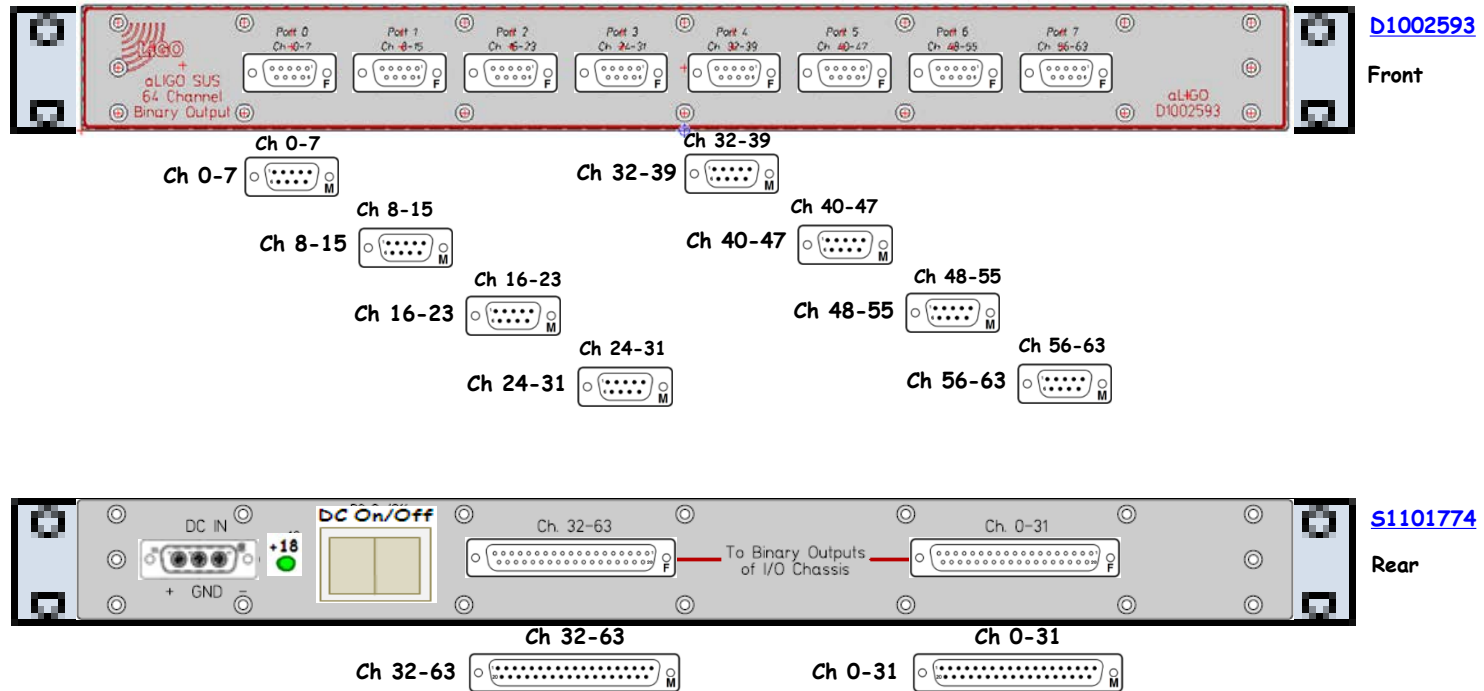

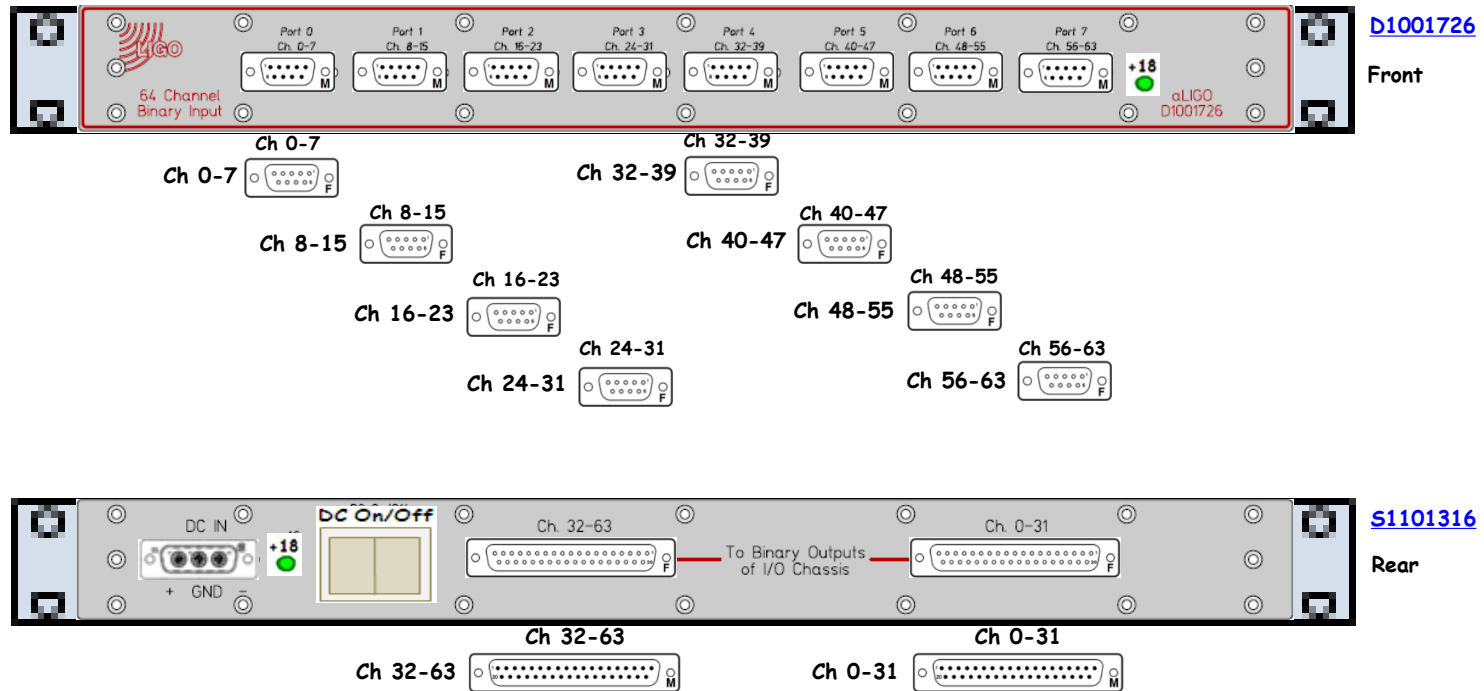

L1-SUS-C8 Details

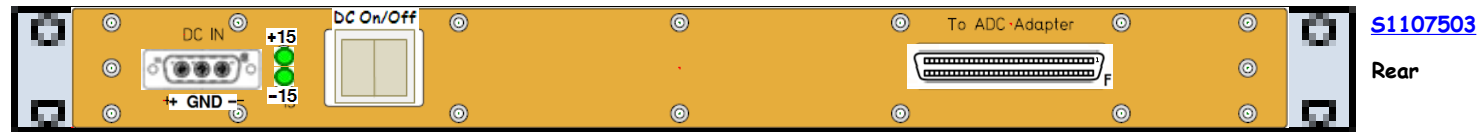
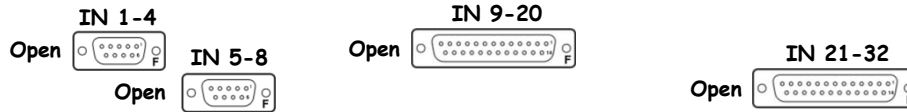
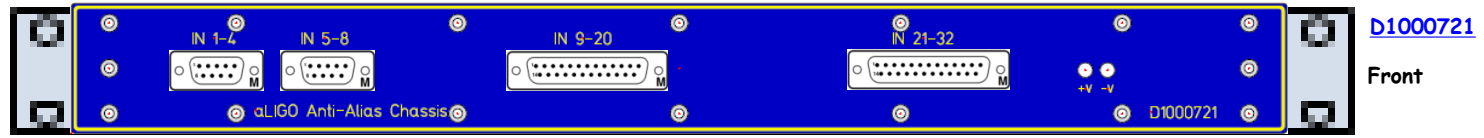

MON ADC1 Anti-Alias Chassis ±18VDC

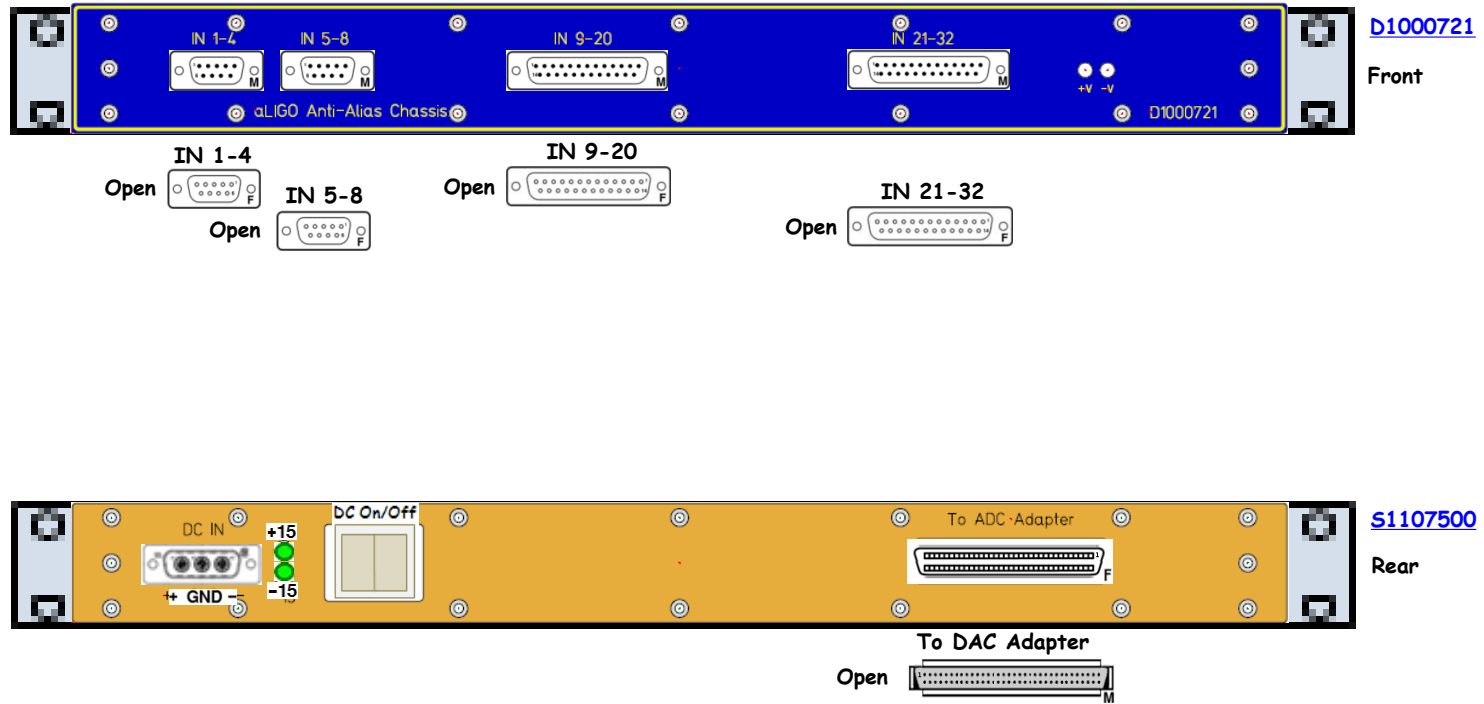

MON ADC2 Anti-Alias Chassis ±18VDC

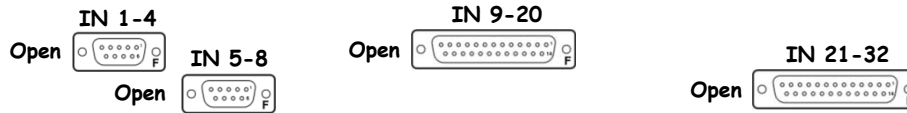

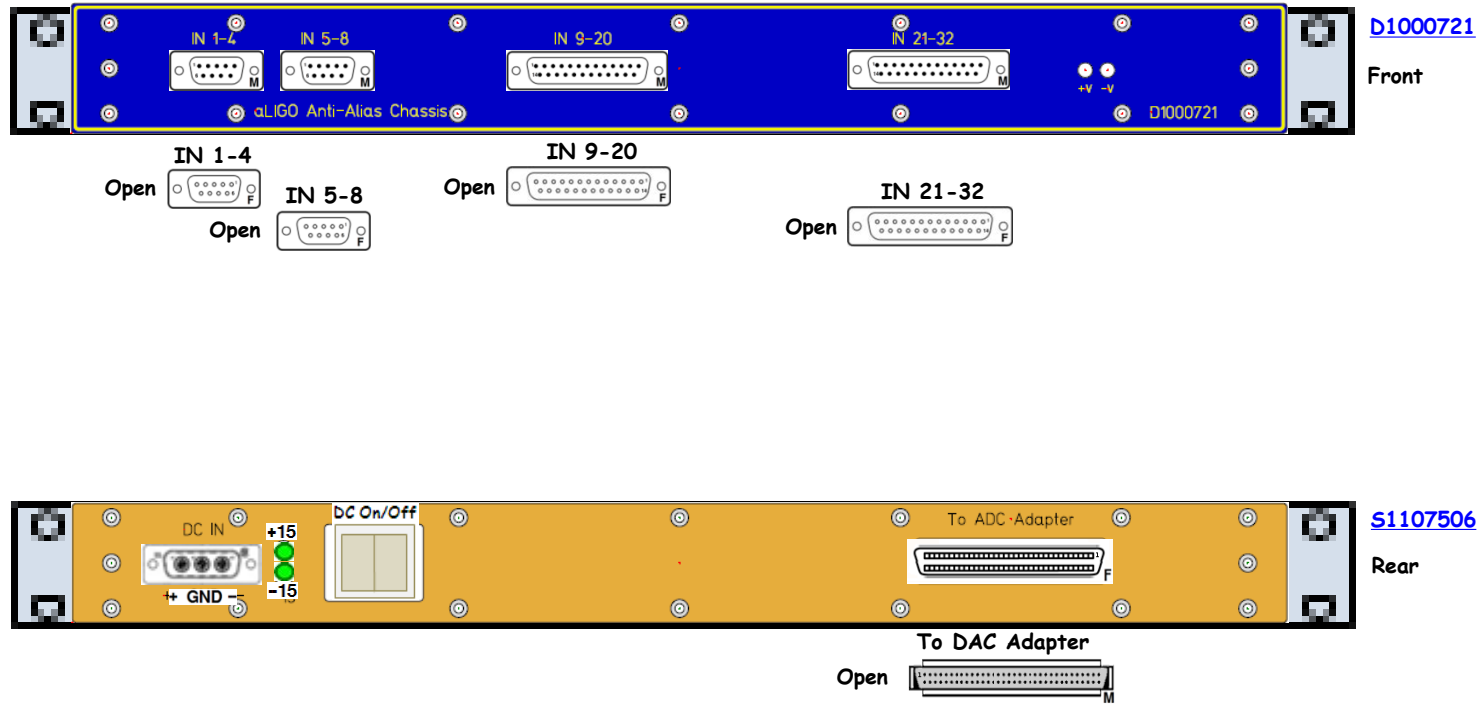

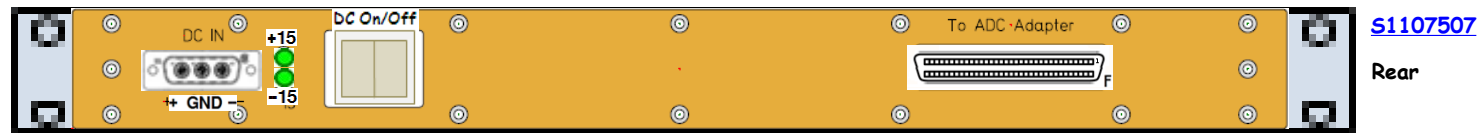
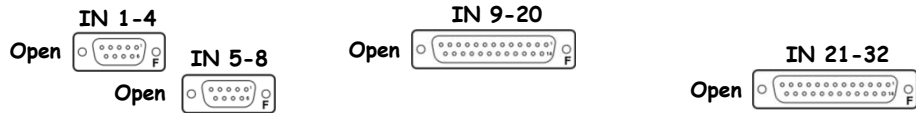
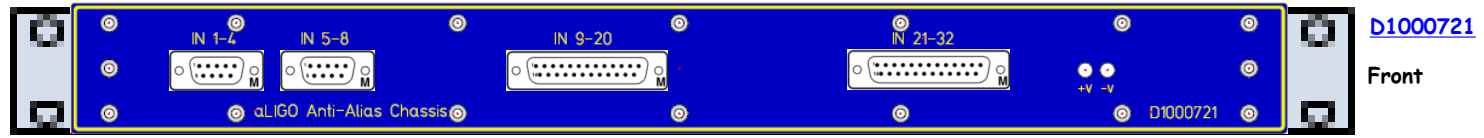

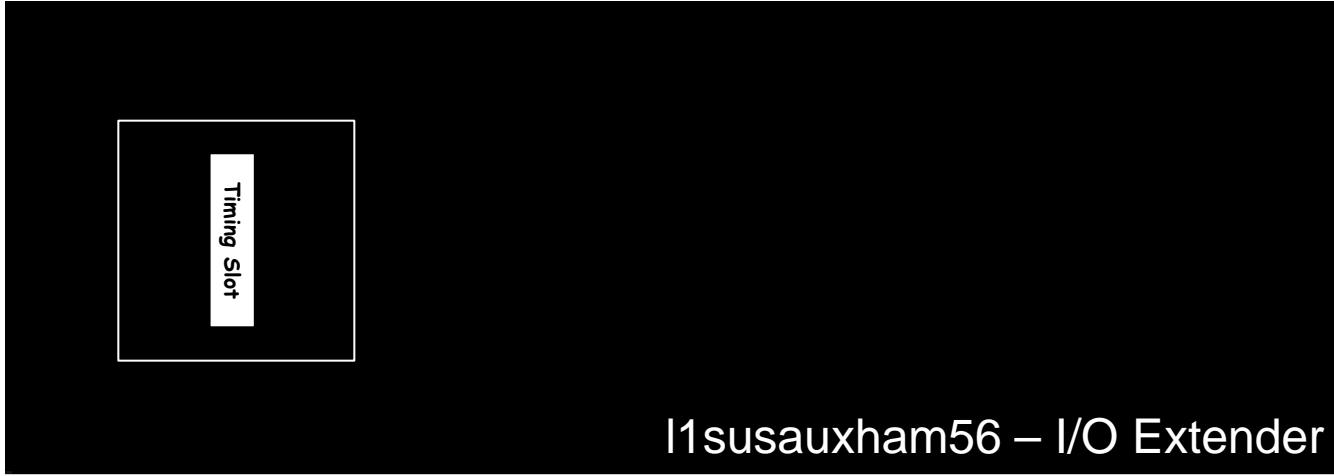

D1001715

Front

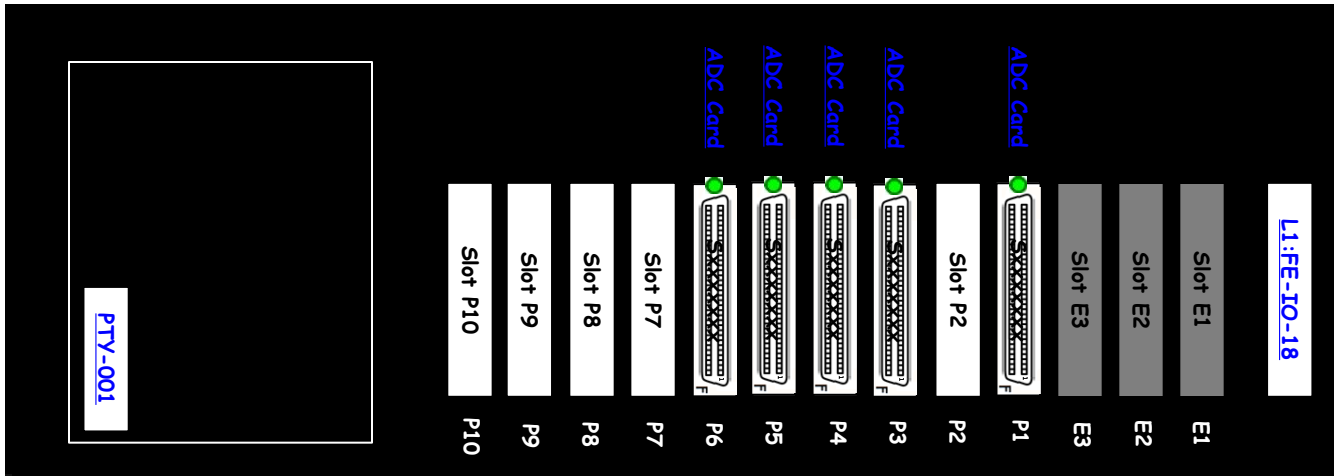

S1103889

Rear

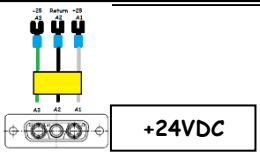
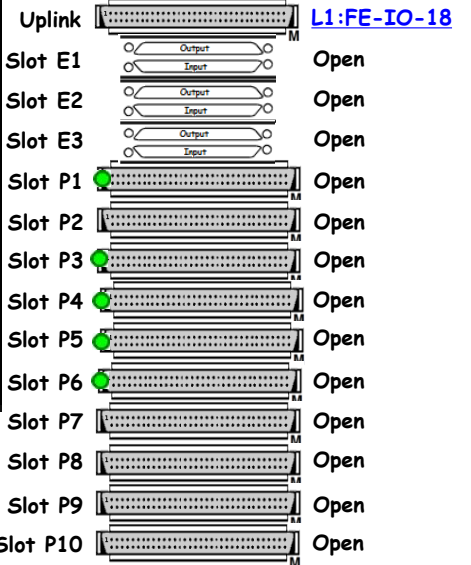

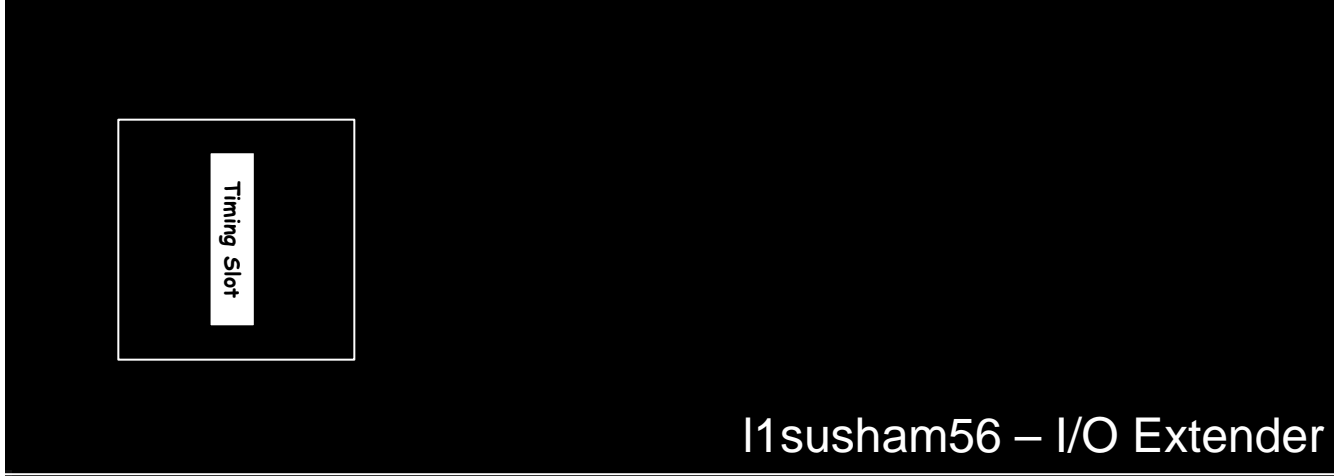

D1001715

Front

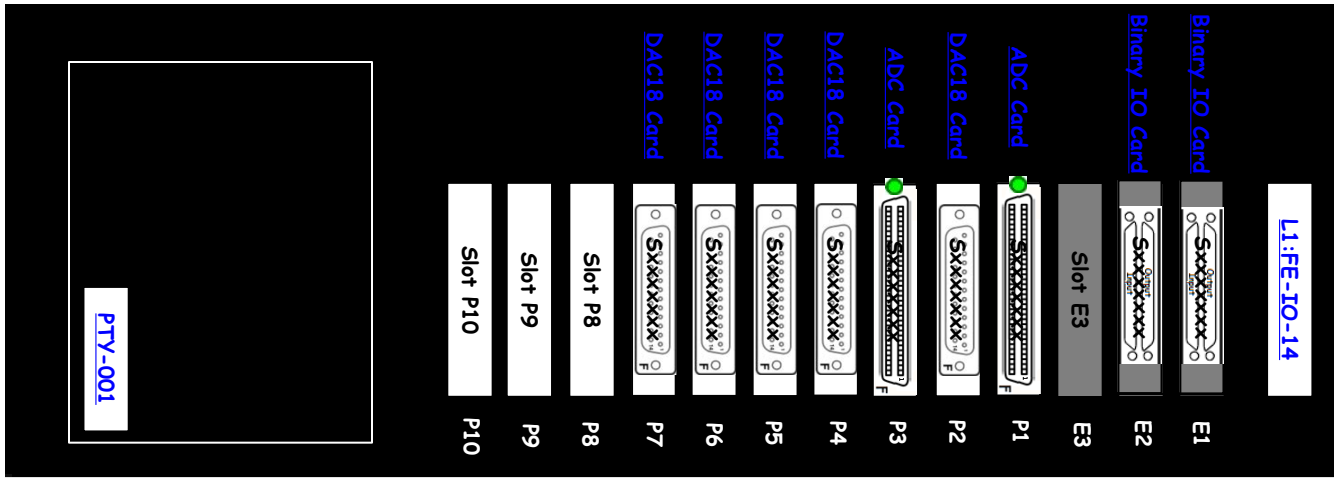

S1001142

Rear

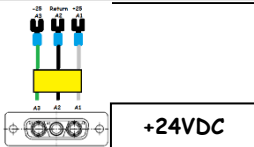
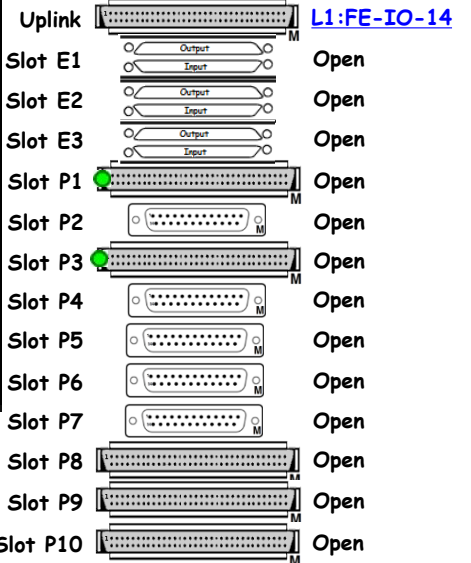

[<< LLO Corner Station](#)

[<< LLO Racks by AREA](#)

[<< LLO CDS Components](#)

LVEA

17 Field Racks are in the LVEA, including the Vacuum Racks.
See [D1003141](#)) at LLO and [D1002704](#) at LHO.

LVEA Access Points

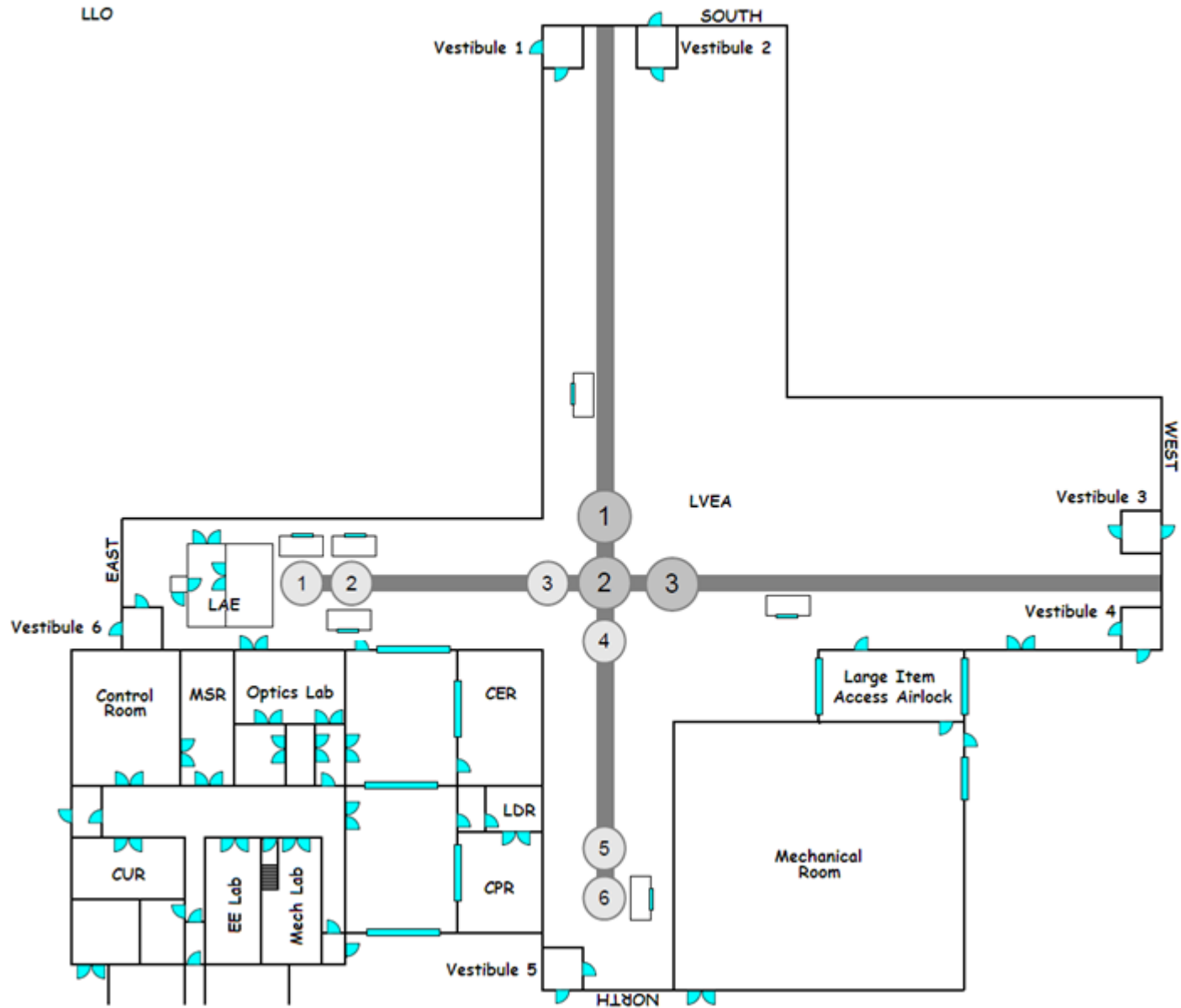

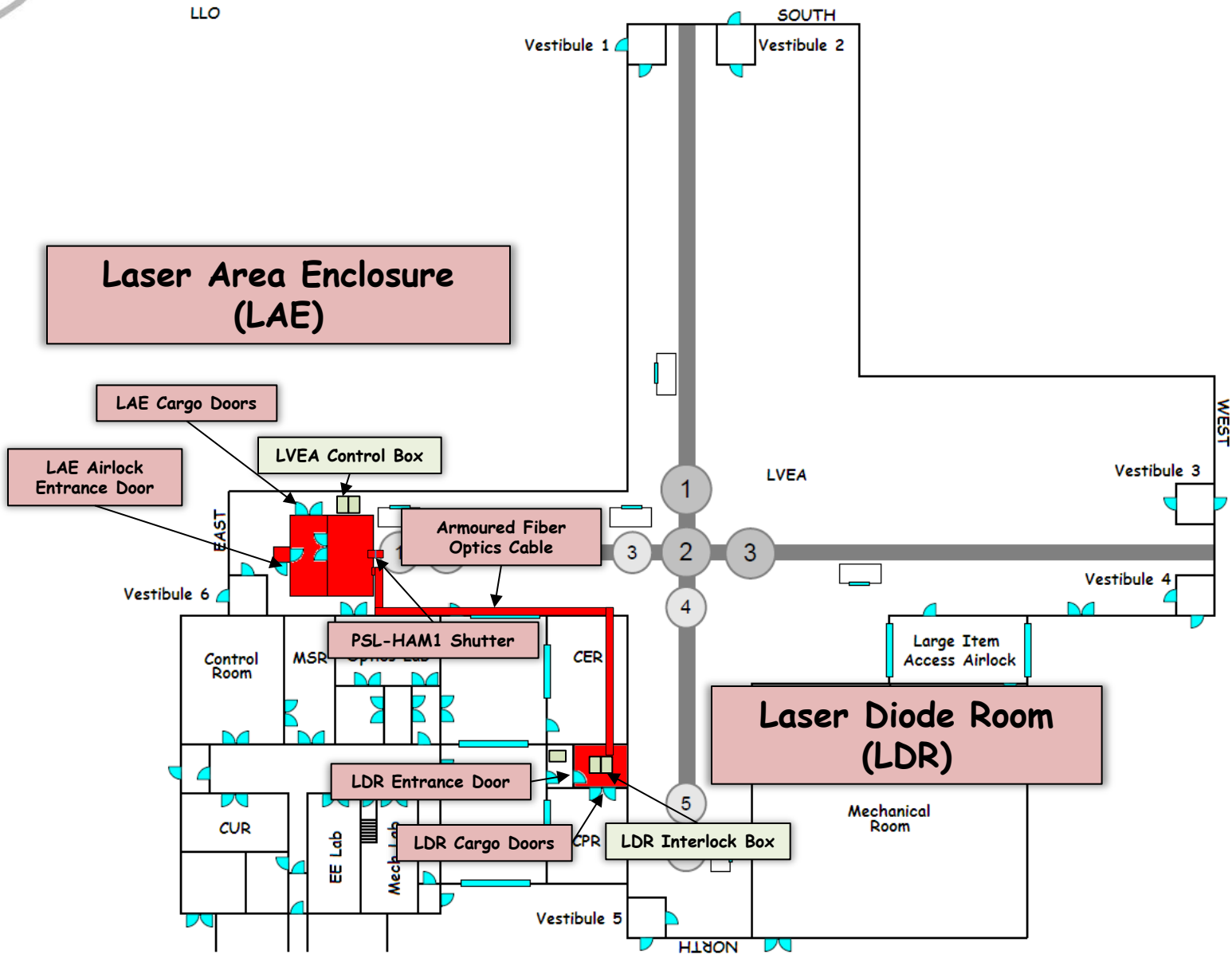

18 Field Racks are in the LVEA, including the Vacuum Racks.
See [D1003141](#)) at LLO and [D1002704](#) at LHO.

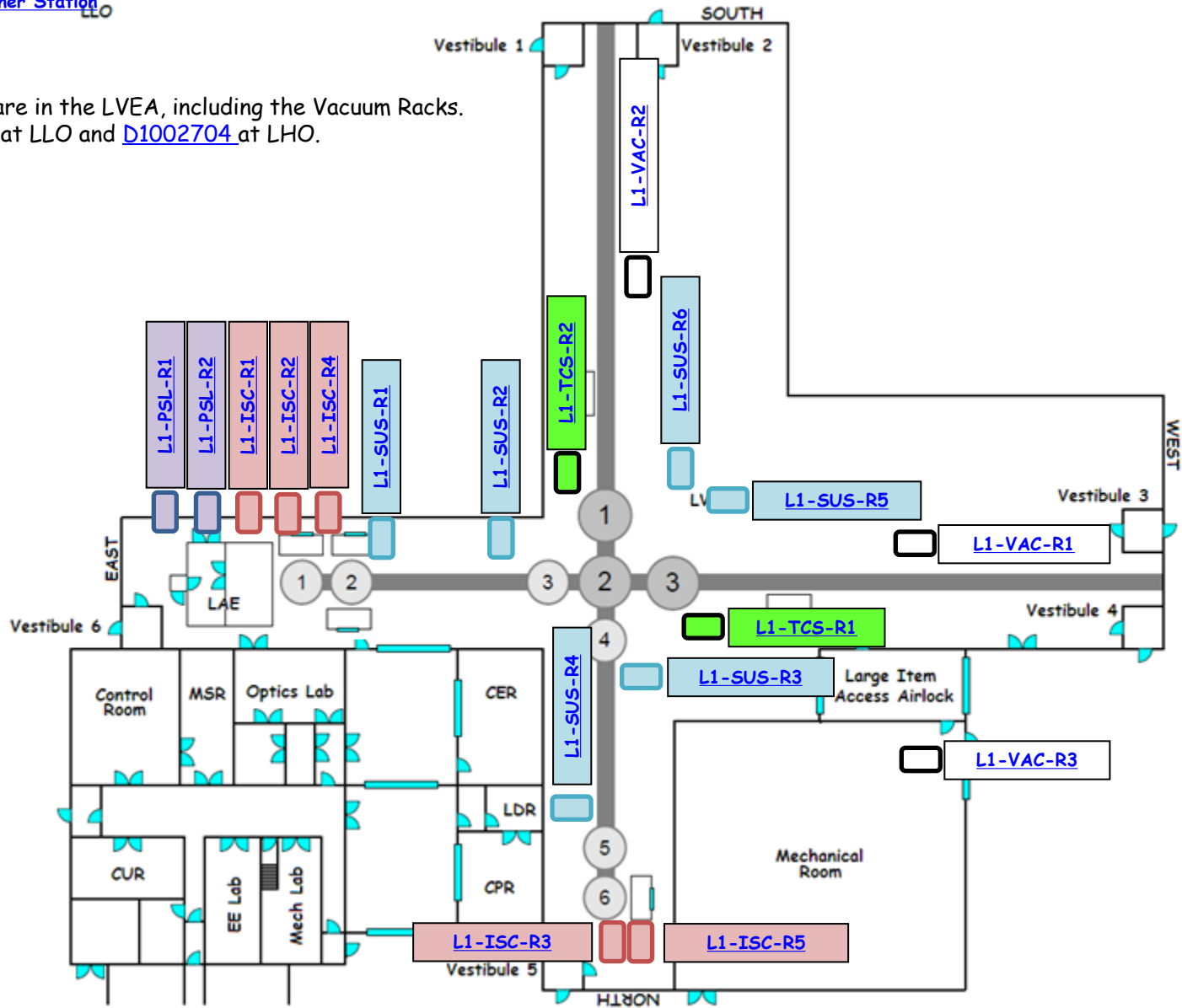

[<< LLO Racks by AREA](#)

[<< LLO Racks by Subsystems](#)

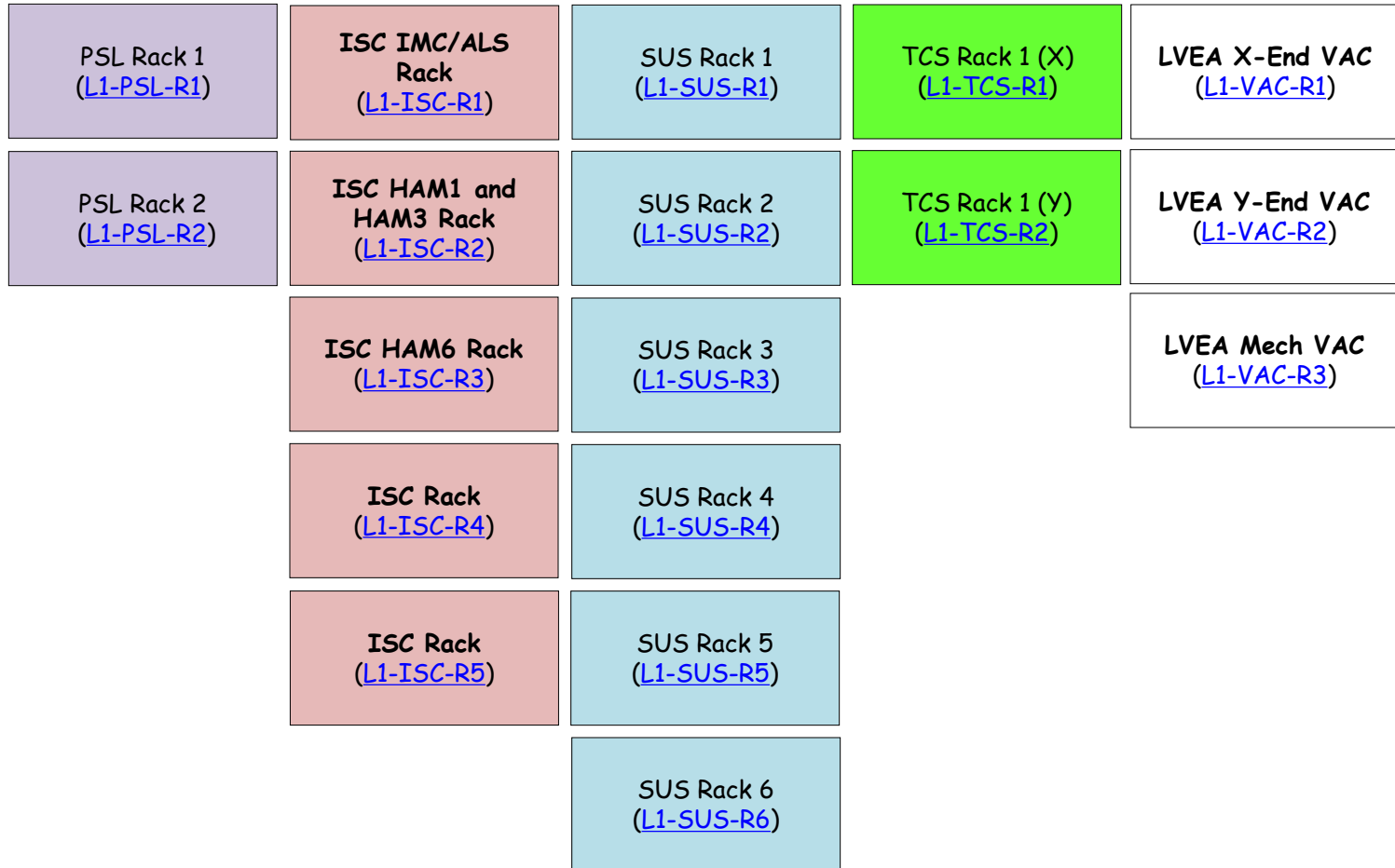

18 Field Racks are in the LVEA, including the Vacuum Racks.
See [D1003141](#)) at LLO and [D1002704](#) at LHO.

Tables are named in [E1200808](#).

Tables Patch Panels are listed in [E1200613](#).

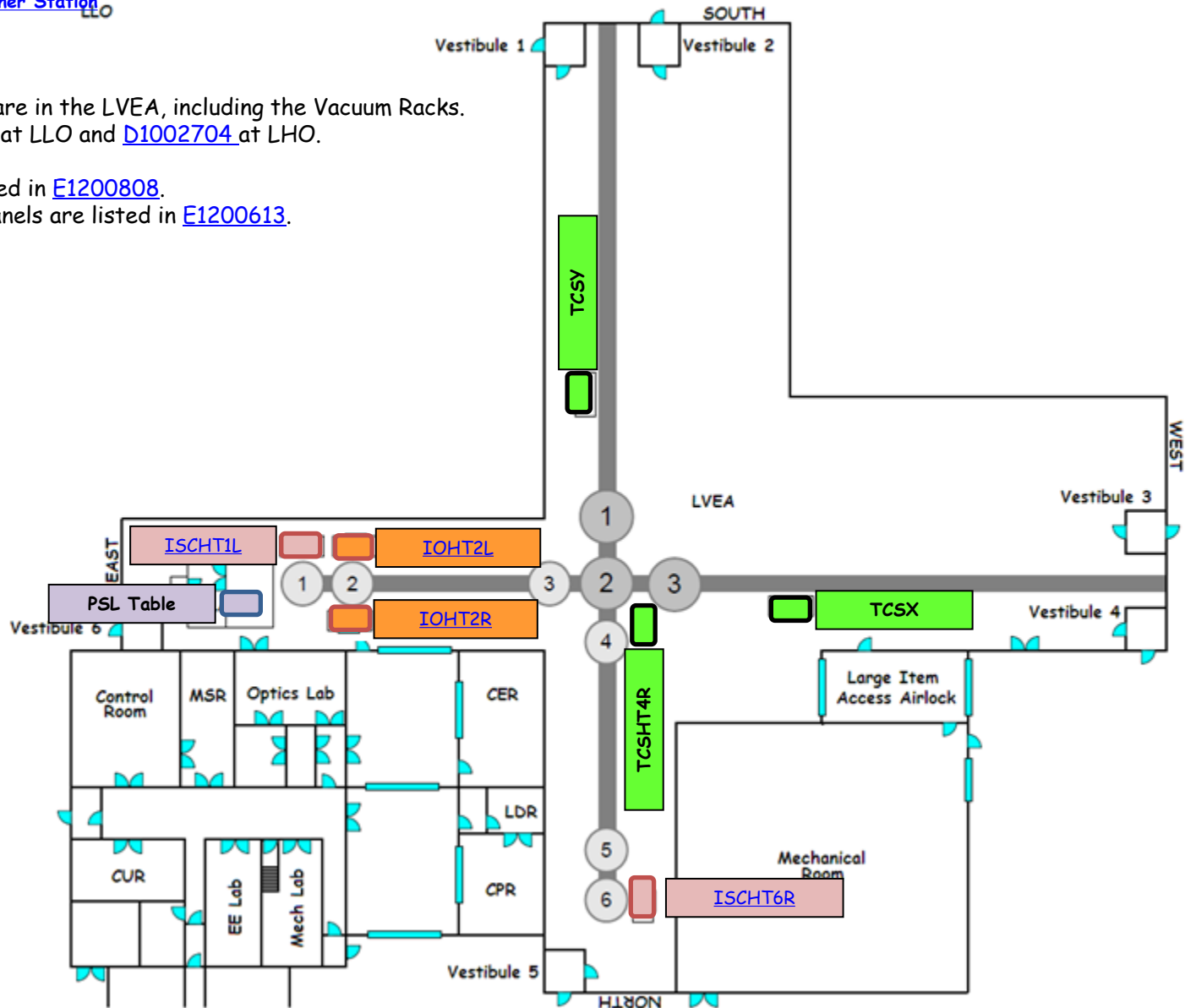

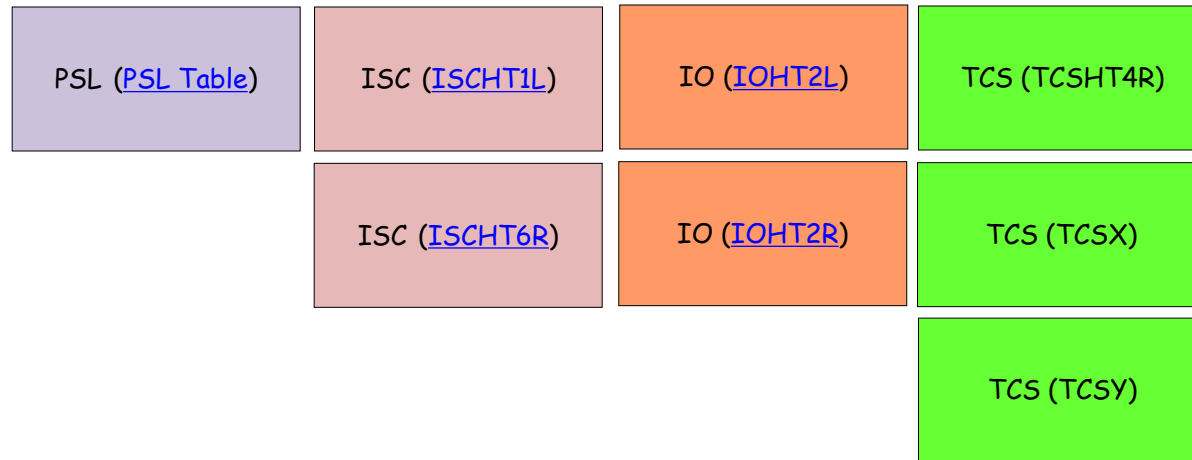

3' X 5' Table Layout ([D1200973](#))

4' X 8' Table Layout ([D1201022](#))

PSL Rack 1 Layout (Dxxxxxxx)

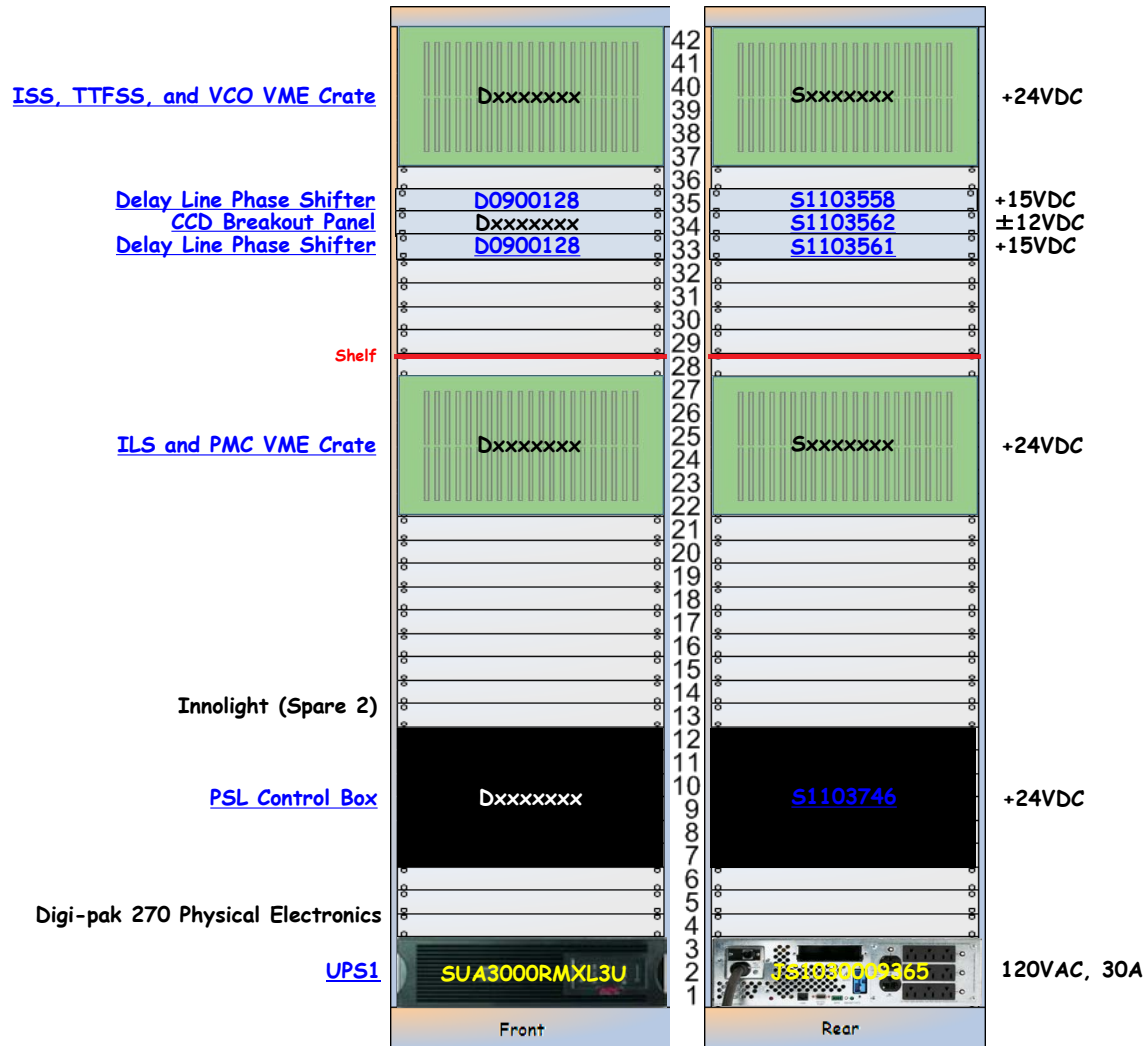

L1-PSL-R1 Details

ISS, TTFSS, and VCO VME Crate

<< [L1-PSL-R1](#)

ISS, TTFSS, and VCO VME Crate

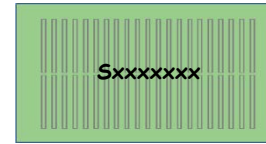
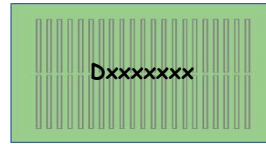

+24VDC

[S1103557](#)

[S1103554](#)

[S1103263](#)

[S1103555](#)

VME Crate

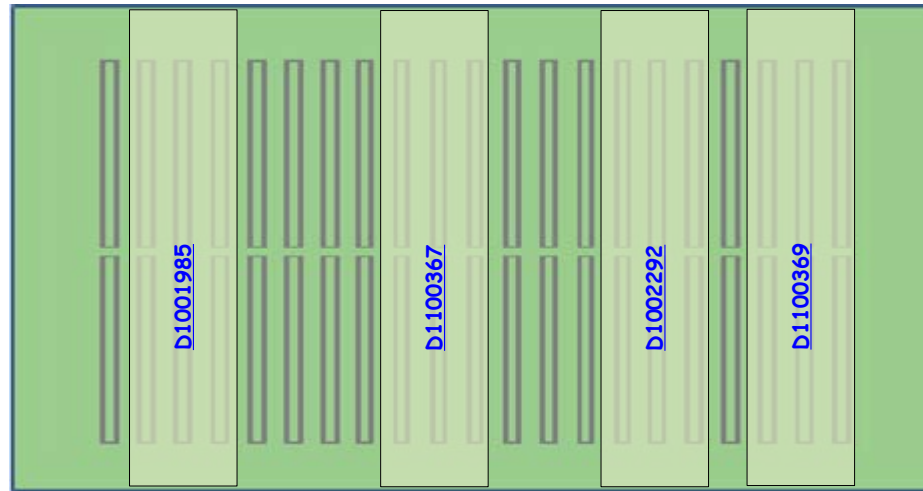

VME Crate
Front

Intensity Stabilization
Servo Module

TTFSS Field Box

Monitoring Field Box Module

PSL VCO Field Box

D0900128 - S1103558



<< L1-PSL-R1

Delay Line Phase Shifter +15VDC

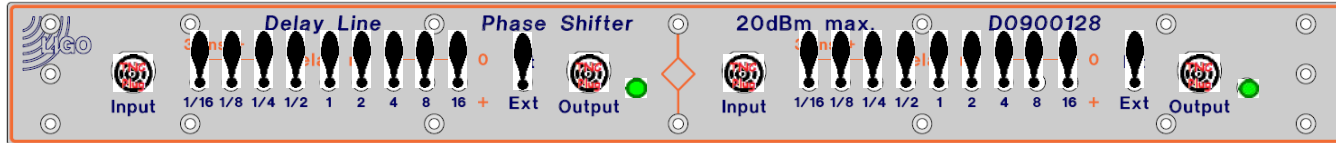

D0900128

Front

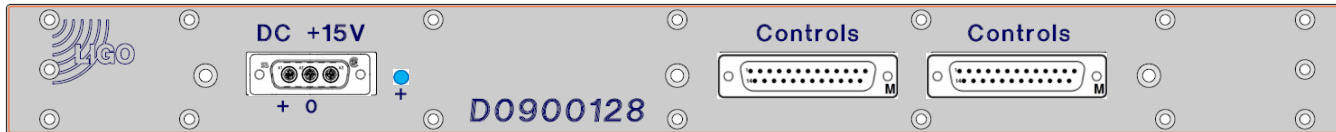

S1103558

Rear

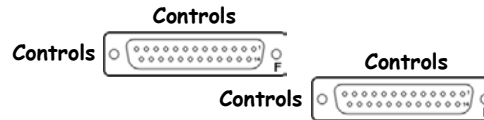

<< L1-PSL-R1

CCD Breakout Panel D1100115 S1103562 ±12VDC

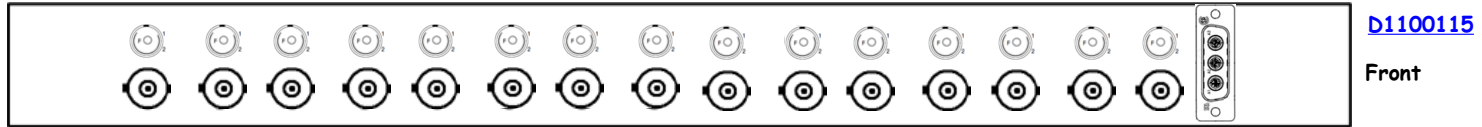

±12VDC

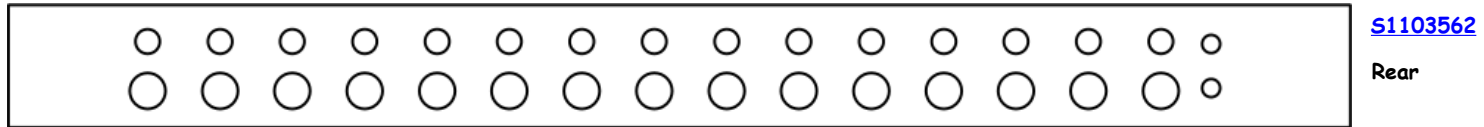

<< L1-PSL-R1

Delay Line Phase Shifter +15VDC

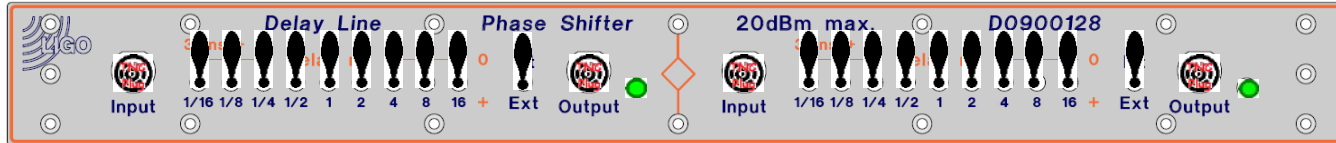

D0900128

Front

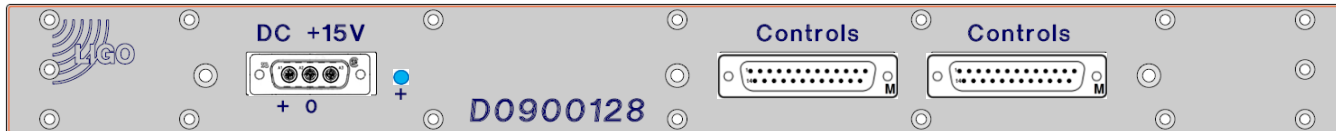

S1103561

Rear

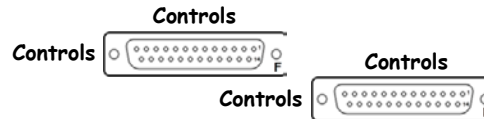

<< L1-PSL-R1

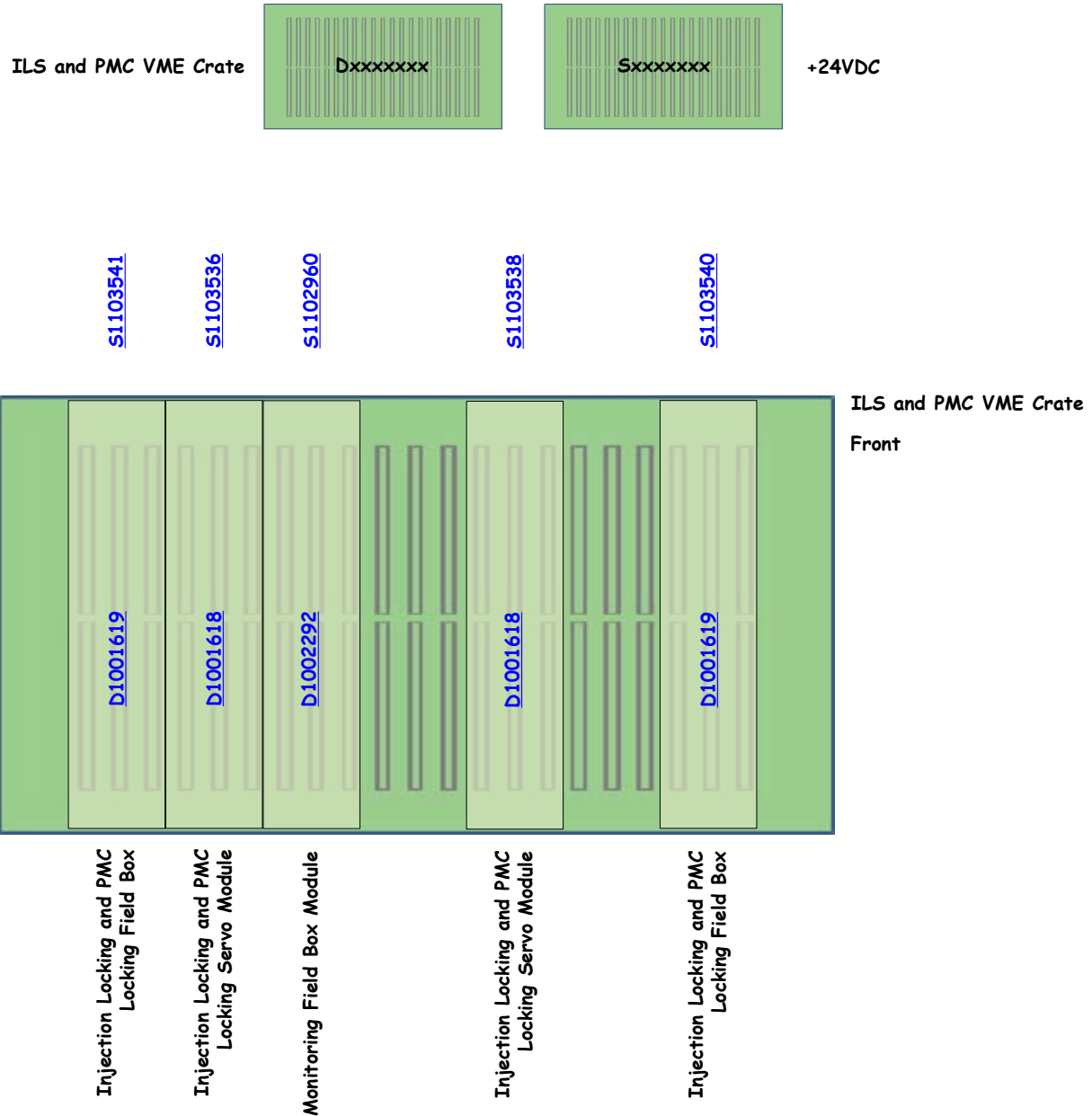

[<< L1-PSL-R1](#)

PSL Control Box

Dxxxxxxx

[S1103746](#)

+24VDC

PSL Control Box

[S1103746](#)

Front

<< L1-PSL-R1

UPS1

SUA3000RMXL3U

JS1030009365

120VAC, 30A



NEMA L5-30P

Camera Power Supplies ...

Panasonic 990 - LVEA1
Panasonic 990 - LVEA2

Agilent E4400B Signal Generator
IFR 2023A Signal Generator

Shelf

Tektronix TDS220

Stanford Research DS345
IFR 2023A Signal Generator

Shelf

Control
Shelf

Diagnostics Breadboard
(DBB) 0208 Crate



Diagnostics Breadboard (DBB) 0208

Shelf

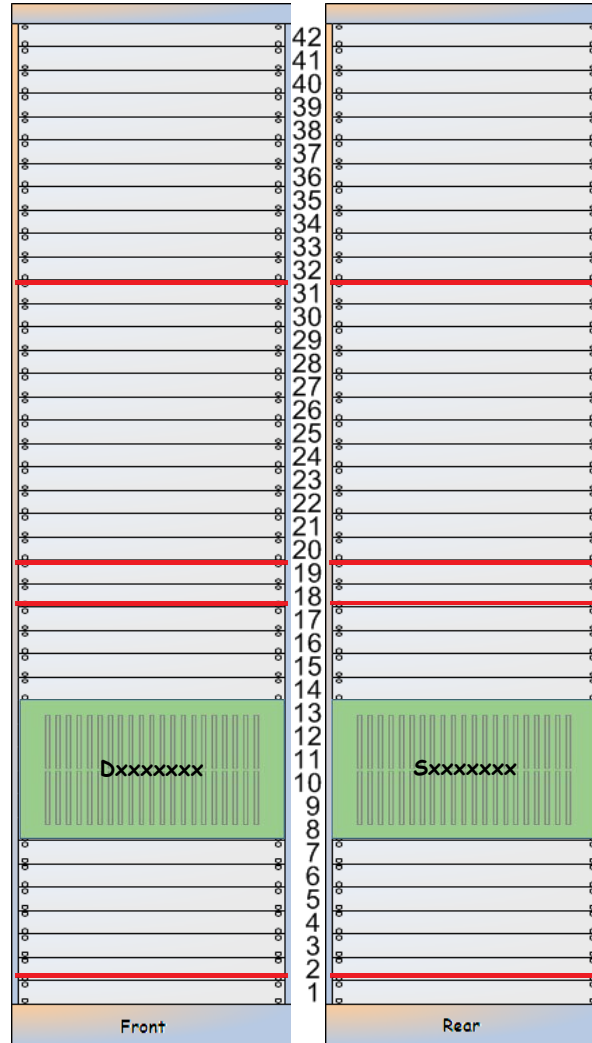

35.5MHz, 14.6dBm
80MHz, 32dBm

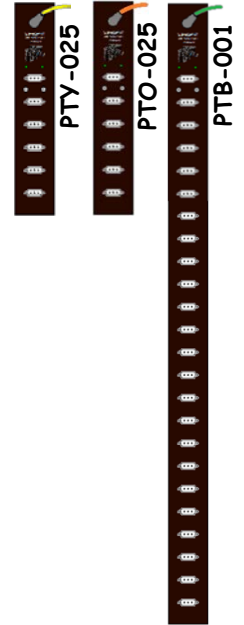

+ -19VDC, + -9VDC

CP5 Connector:
Pin 1: -19VDC
Pin 2: -9VDC
Pin 3: Ground
Pin 4: +9VDC
Pin 5: +19VDC

Front

Rear

<< L1-PSL-R2

Diagnostics Breadboard
(DBB) VME Crate

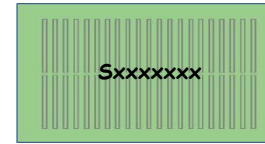
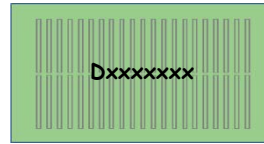

+24VDC

[S1103544](#)

[S1103546](#)

[S1103548](#)

[S1103550](#)

[S1103551](#)

Diagnostics Breadboard
(DBB) VME Crate

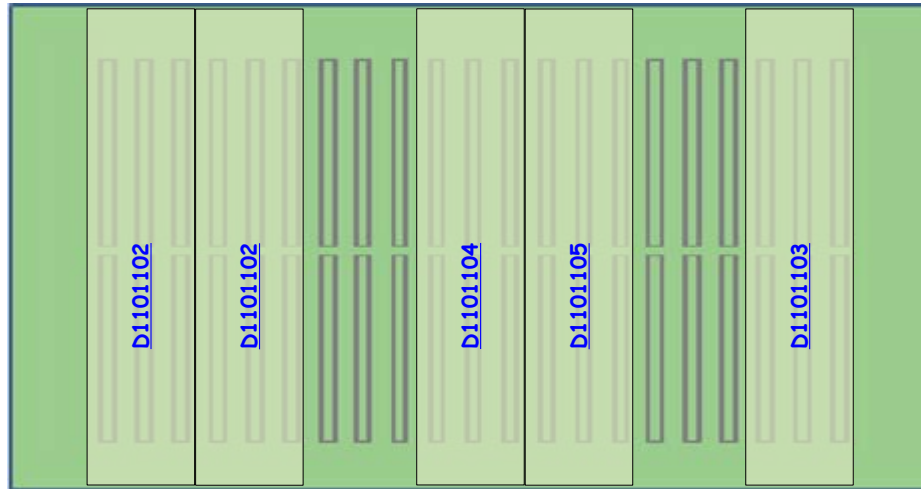

Diagnostics Breadboard
(DBB) VME Crate
Front

PSL Diagnostics Breadboard
High Voltage Module

PSL Diagnostics Breadboard
Field Box

PSL Diagnostics Breadboard
Demodulator Module

PSL Diagnostics Breadboard
Miscellaneous Module

PSL Diagnostics Breadboard
Calibration Module

[D1101102](#)

[D1101102](#)

[D1101104](#)

[D1101105](#)

[D1101103](#)

IOHT2L is part of [E1201099](#).

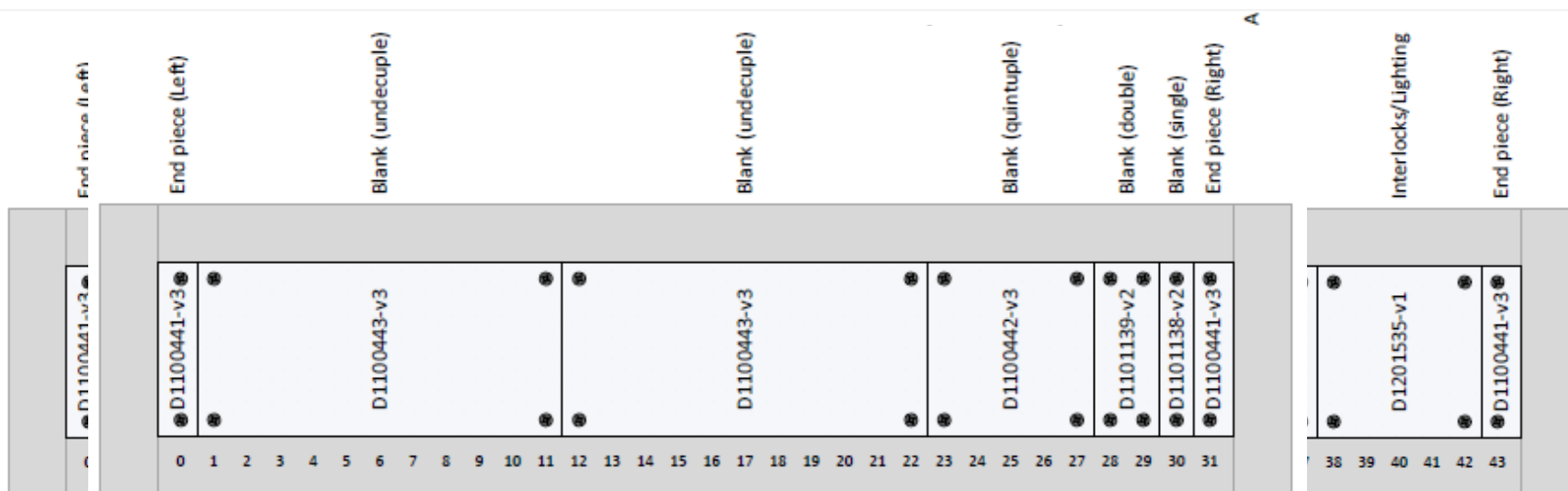

Left Side

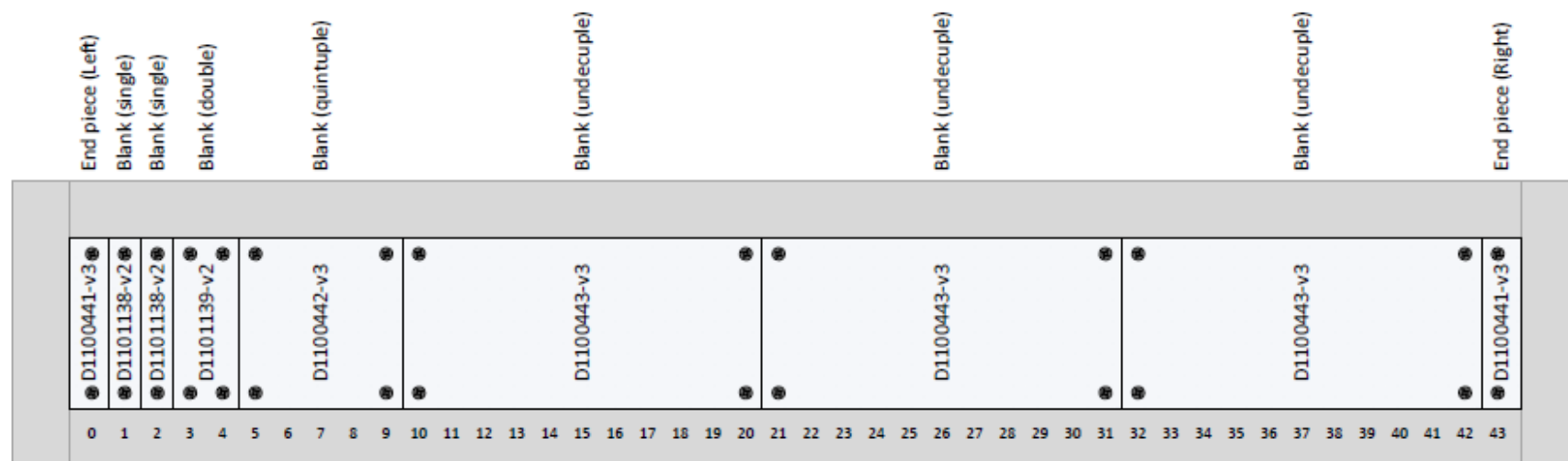

Right Side

IOHT2R is part of [E1201099](#).

L1-IOHT2R Panel Layout

<< [LVEA Tables](#)

IOHT2R Panel Layout ([D1201530](#))

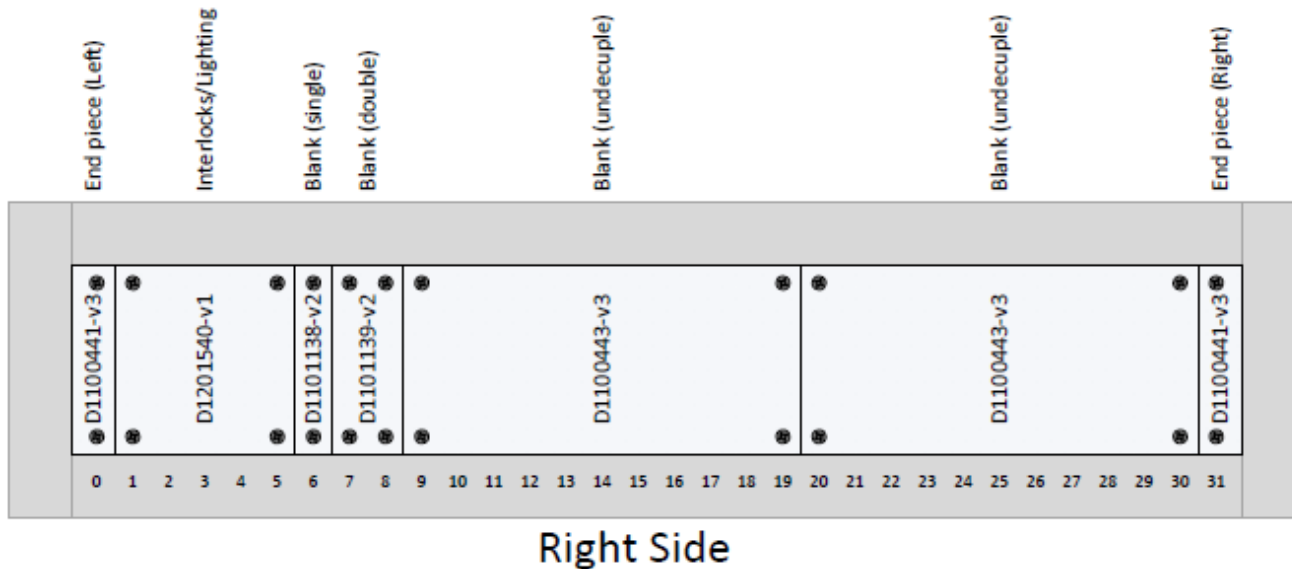



L1-ISCHT1L Table Layout

[<< LVEA Tables](#)

ISCHT1L Table Layout ([D1201499](#)) (Sxxxxxxx)

ISCHT1L is part of [E1201099](#).

L1-ISCHT1L Panel Layout

<< LVEA Tables

ISCHT1L Panel Layout (D1201331)

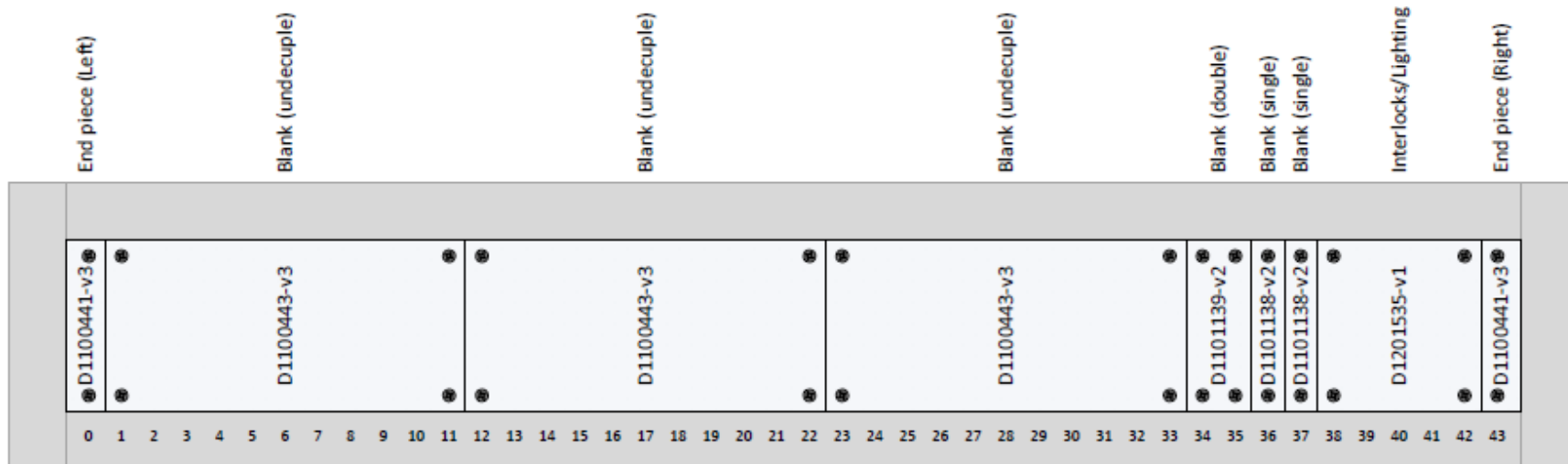

Left Side

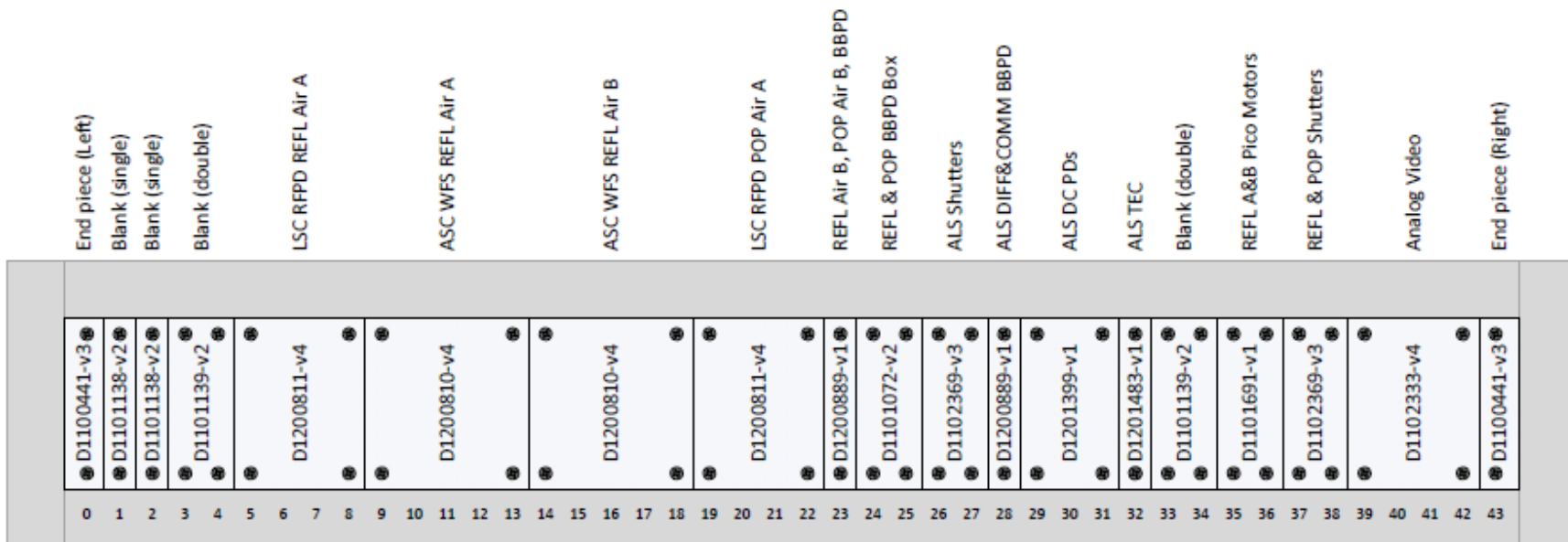

Right Side



L1-ISCHT6R Table Layout

[<< LVEA Tables](#)

ISCHT6R Table Layout ([D1201500](#)) (Sxxxxxxx)

ISCHT6R is part of [E1201099](#).

L1-ISCHT6R Panel Layout

[<< LVEA Tables](#)

ISCHT6R Panel Layout ([D1201496](#))

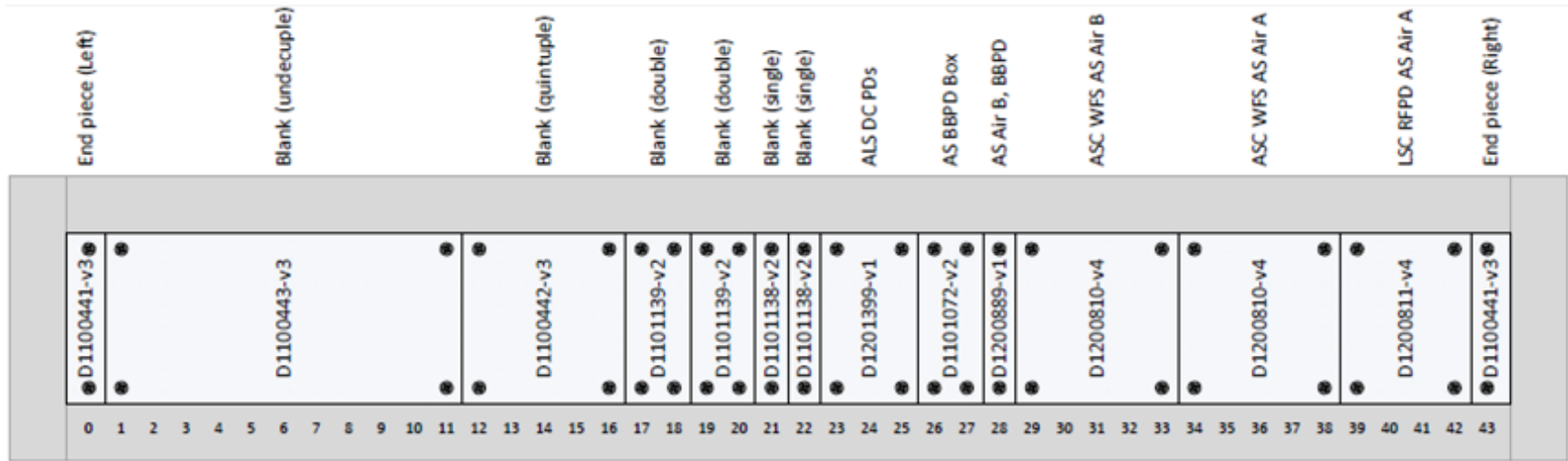

Left Side

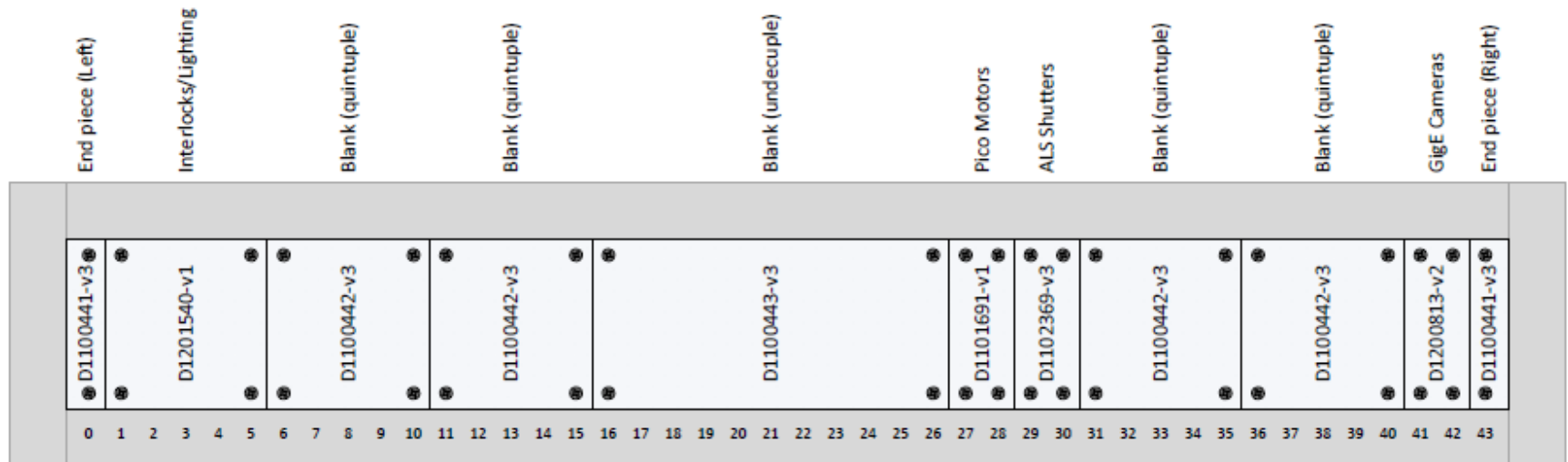

Right Side

L1-ISCBT4R Table Layout



[<< LVEA Tables](#)

ISCHT6R Table Layout ([D1201498](#)) (Sxxxxxxx)

ISCHT6R is part of [E1201099](#).

L1-ISCBT4R Panel Layout

<< LVEA Tables

ISCBT4R Panel Layout ([D1201495](#))

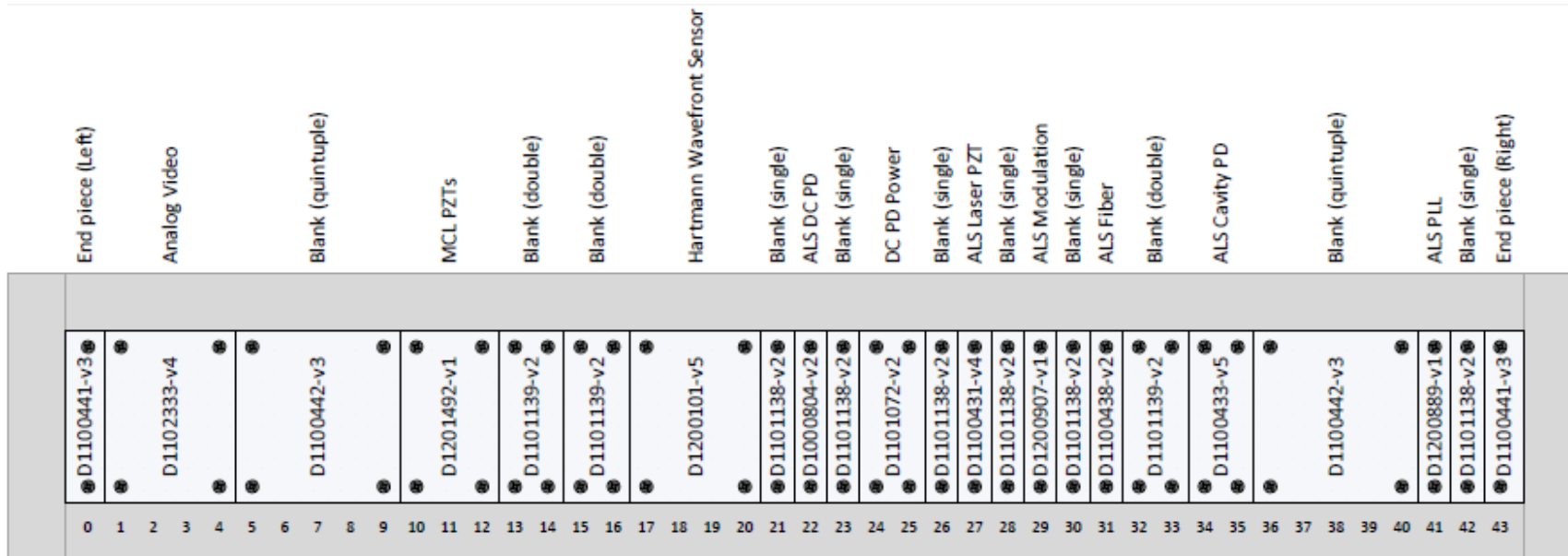

Left Side

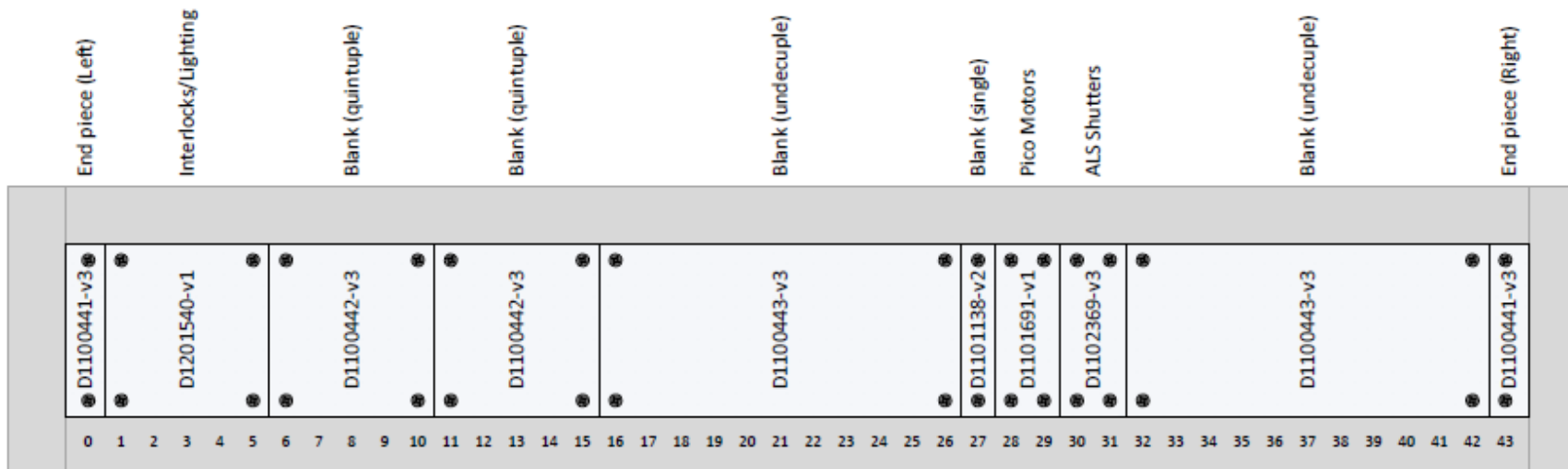

Right Side



L1-ISCBT5L Table Layout

[<< LVEA Tables](#)

ISCHT6R Table Layout ([D1201497](#)) (Sxxxxxxx)

ISCHT6R is part of [E1201099](#).

L1-ISCBT5L Panel Layout

<< LVEA Tables

ISCBT5L Panel Layout ([D1101126](#))

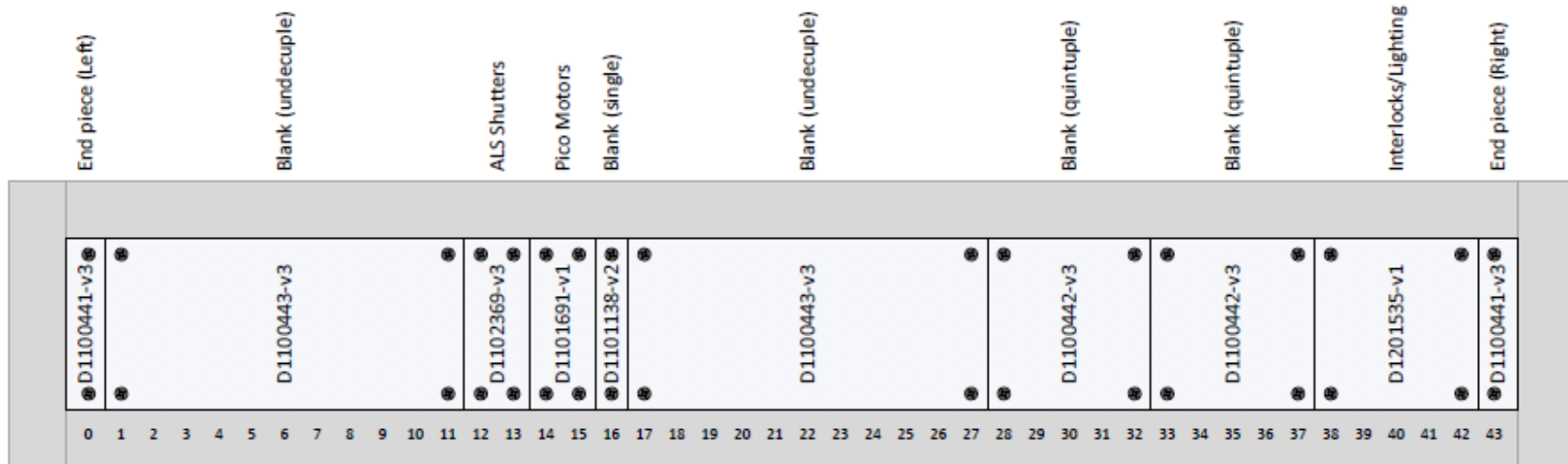

Left Side

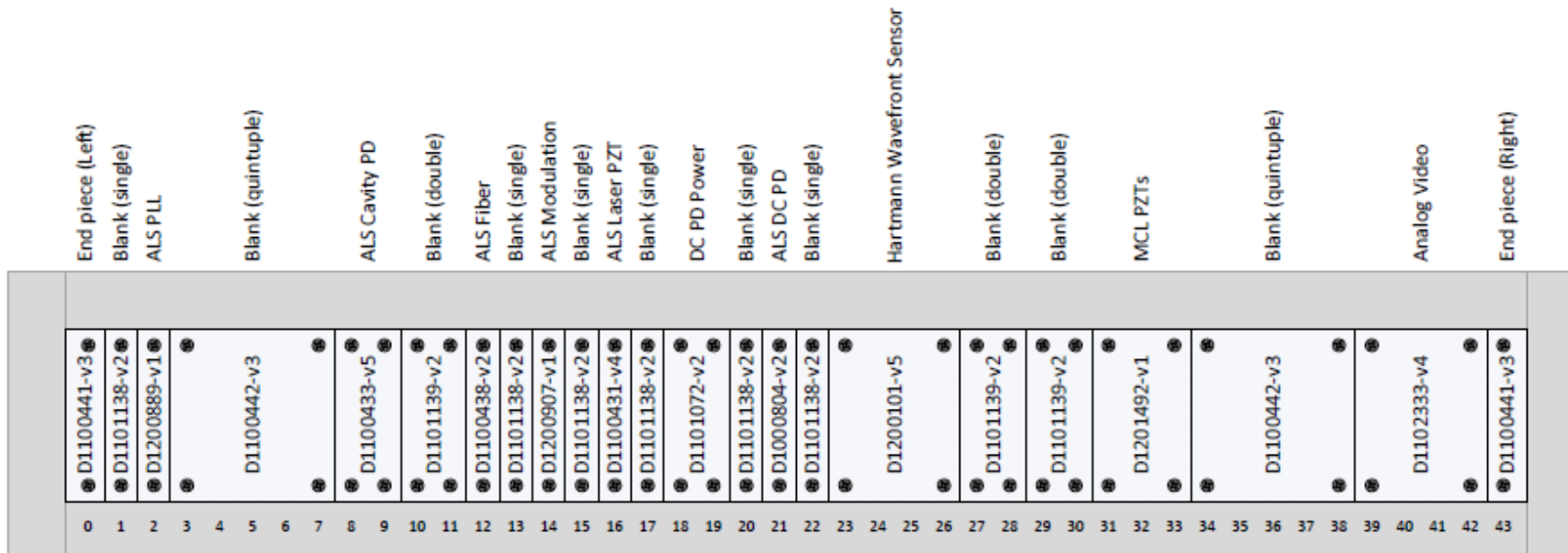

Right Side



[PSL Table](#)

End Blank Panel



[D1100441](#)

Single Blank Panel



[D1101138](#)

Double Blank Panel



[D1101139](#)

Quintuple Blank Panel

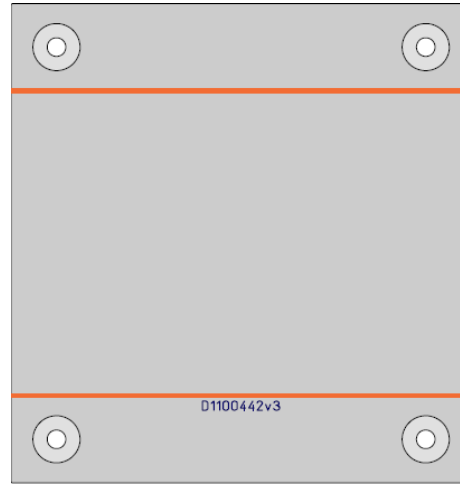

[D1100442](#)

Undecuple Blank Panel

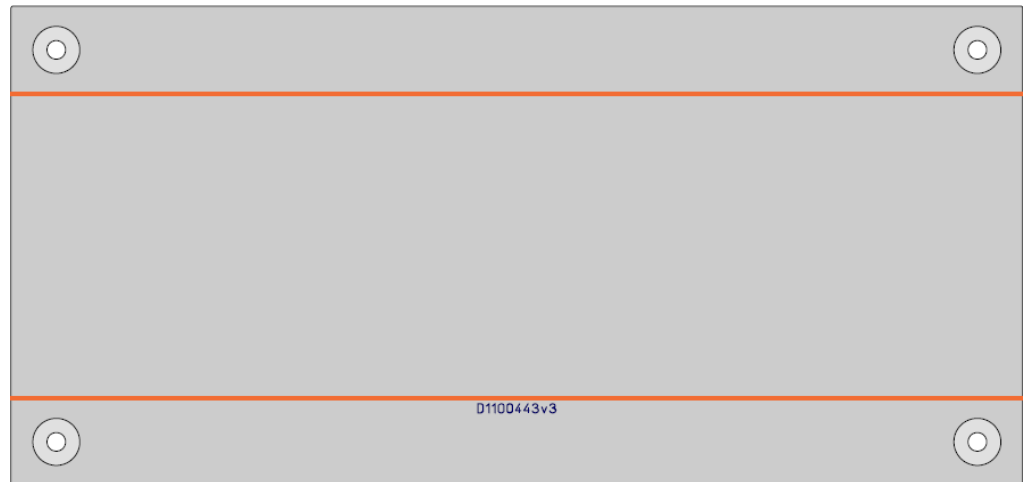

[D1100443](#)

Flipper Mirrors,
Sensor Patch Panel

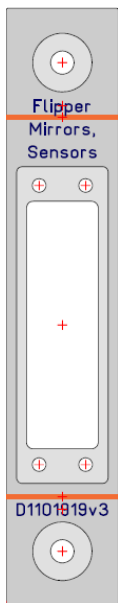

[D1101919](#)

DC Power Patch Panel

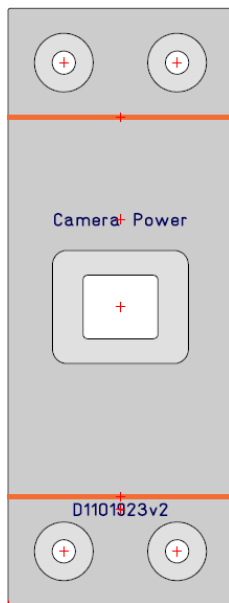

[D1101923](#)

LC Duplex Patch Panel RTD Sensors Patch Panel



[D1101924](#)

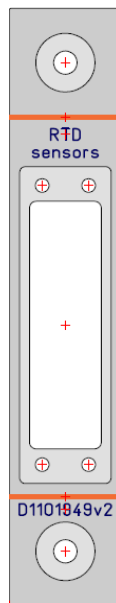

[D1101949](#)

Delrin Insert
for DB25

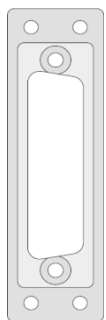

[D1101690](#)

Picomotor
Breakout Front

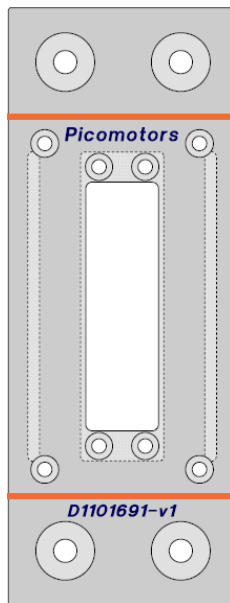

[D1101691](#)

Picomotor
Breakout Rear

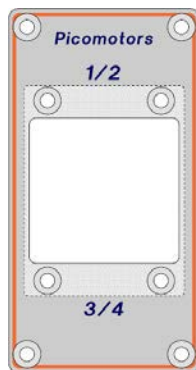

[D1101692](#)

Picomotor
Breakout Side



[D1101693](#)

Delrin Insert
for 2 X DB9

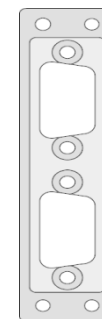

[D1101669](#)

**Delrin Insert
for DB25**

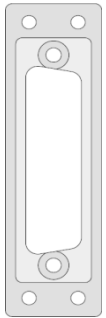

[D1101690](#)

**Delrin Insert
for 2 X DB9(V)**

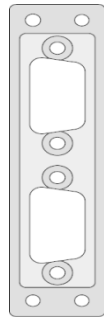

[D1101669](#)

**Delrin Insert
for 2 X DB9(H)**

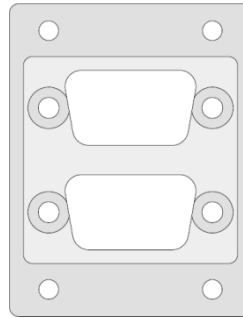

[D1101699](#)

Shutter Logic D1102312 Sxxxxxxx +24VDC

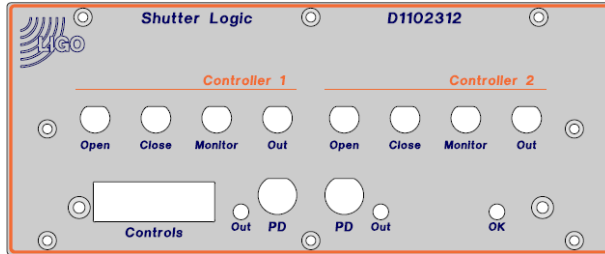

D1102312
Front

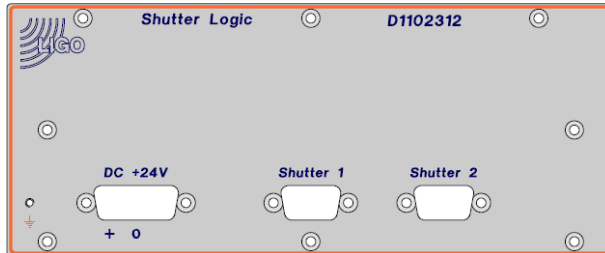

Sxxxxxxx
Rear

D1200136 - Sxxxxxxx



<< LVEA Racks

ALS Fiber Distribution Chassis +-17VDC, +-24VDC

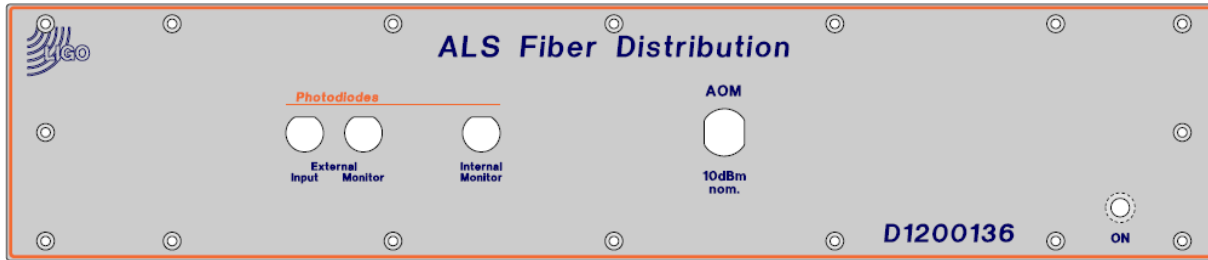

[D1200136](#)
Front

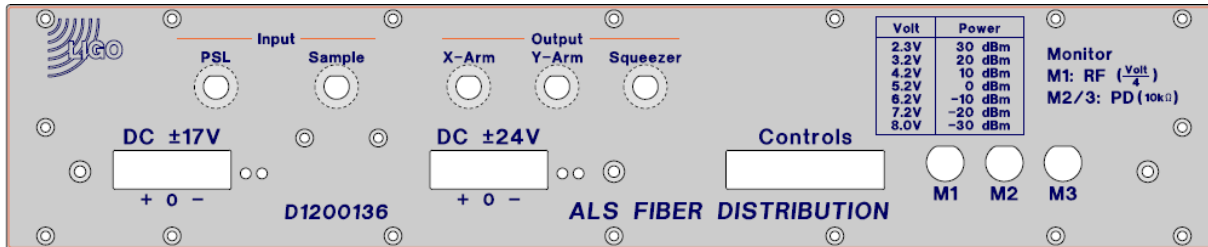

Sxxxxxxx
Rear



- RF Patch Panel 10
- RF Patch Panel 11
- RF Patch Panel 12
- 24.078 MHz Distribution Amplifier
- 79.4 MHz VCO (ALS)
- Dual DSUB Breakout Panel
- 158.8 MHz Frequency Doubler
- 158.8 / 79.4 MHz 2-Channel PF Discriminator
- 79.4 MHz VCO (ALS)
- 79.4 MHz VCO (PSL)
- 158.8 MHz Frequency Doubler
- 24.078 MHz Dual Delay Line
- 24.078 MHz 2-Channel Demodulator
- Mode Cleaner Servo
- LSC Demod Concentrator 1
- ASC Demod Concentrator 1
- LSC RFPD Interface
- WFS RFPD Interface
- ISC Whitening Chassis (ASC IMC WFS A 24MHz)
- WFS I/Q Demodulator (ASC IMC WFS A 24MHz)
- WFS Demodulator Patch Panel
- WFS I/Q Demodulator (ASC IMC WFS B 24MHz)
- ISC Whitening Chassis (ASC IMC WFS A 24MHz)
- Differential to Single-Ended Receiver

Dxxxxxxx	42	Sxxxxxxx	No Power
Dxxxxxxx	41	Sxxxxxxx	No Power
Dxxxxxxx	40	Sxxxxxxx	No Power
Dxxxxxxx	39	Sxxxxxxx	No Power
Dxxxxxxx	38	Sxxxxxxx	No Power
D1000124	37	S1000673	±17VDC, ±24VDC
D0900605	36	S1200576	±17VDC, ±24VDC
D1201450	35	Sxxxxxxx	±15VDC
D1002178	34	S1000740	±17VDC, ±24VDC
D1002476	33	S1000766	±17VDC, ±24VDC
D0900605	32	S1200575	±17VDC, ±24VDC
D0900605	31	S1200580	±17VDC, ±24VDC
D1002178	30	S1000739	±17VDC, ±24VDC
D0900128	29	S1103423	+15VDC
D1000181	28	S1000788	±17VDC, ±24VDC
D0901781	27	S1102629	±17VDC, ±24VDC
D1100691	26	S1104005	±18VDC
D1100696	25	S1103984	No Power
D1102079	24	S1200449	±18VDC
D1101906	23	S1200429	±15VDC
D1002559	22	S1101612	±15VDC
D0902796	21	S1000991	±15VDC
D1100905	20	Sxxxxxxx	No Power
D0902796	19	S1001024	±15VDC
D1002559	18	S1101571	±15VDC
D1100482	17	S1202844	±15VDC
	16		
	15		
	14		
	13		
	12		
	11		
	10		
	9		
	8		
	7		
	6		
	5		
	4		
	3		
	2		
	1		
Front		Rear	

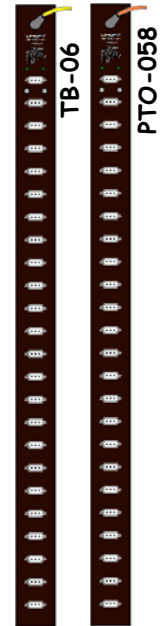

L1-ISC-R1 Details

RF Patch Panel 10

<< [L1-ISC-R1](#)

RF Patch Panel 10

Dxxxxxxx

Sxxxxxxx

No Power

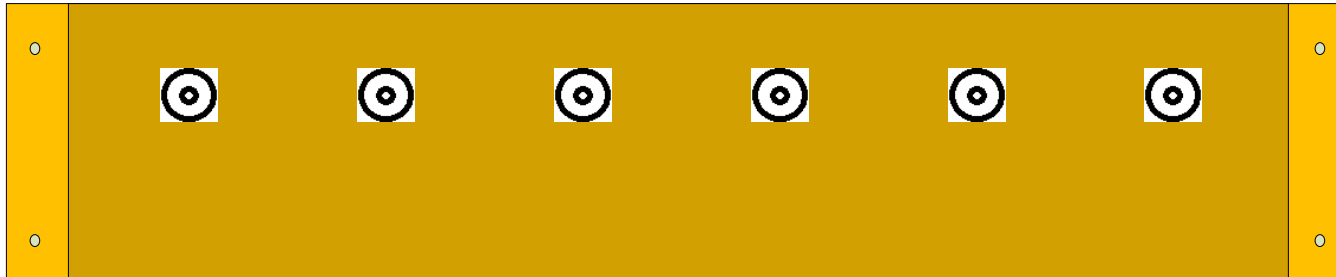

Dxxxxxxx

Front

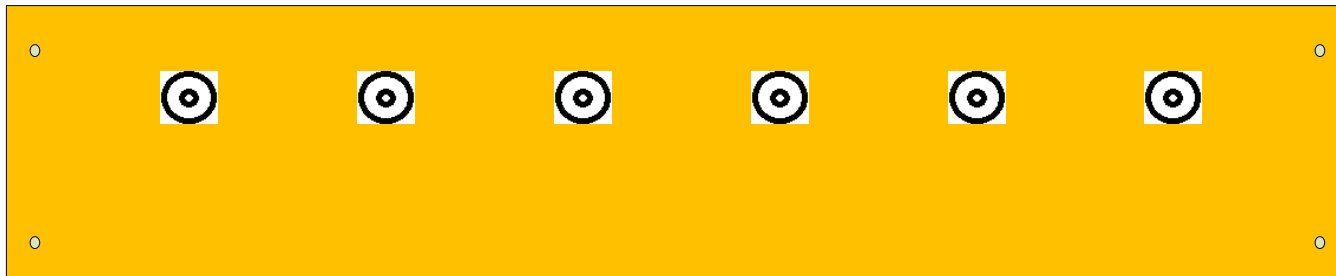

Sxxxxxxx

Rear

<< [L1-ISC-R1](#)

RF Patch Panel 11

Dxxxxxxx

Sxxxxxxx

No Power

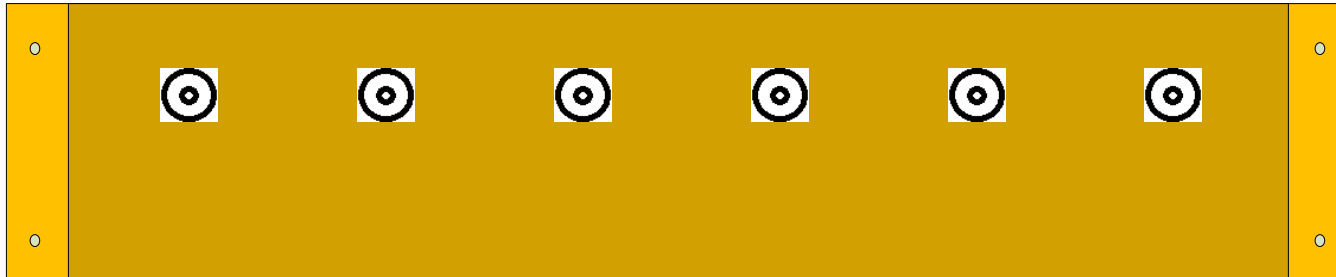

Dxxxxxxx

Front

RF Power Splitter for PSL VCO: [E1200894](#)

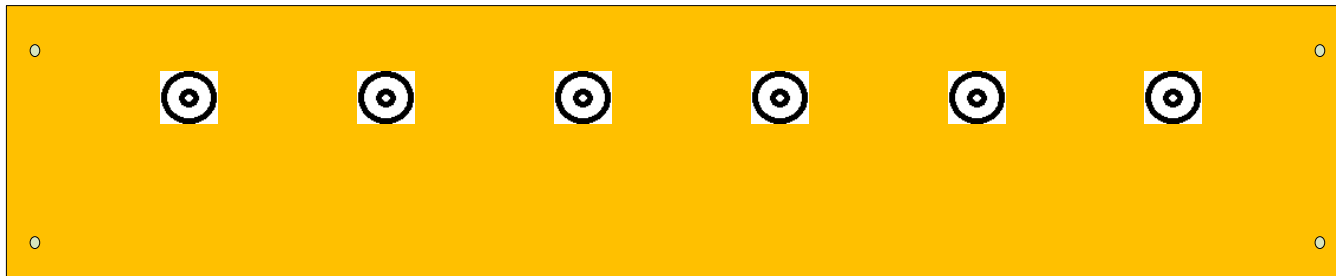

Sxxxxxxx

Rear

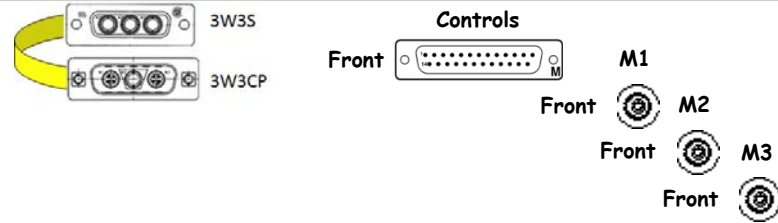
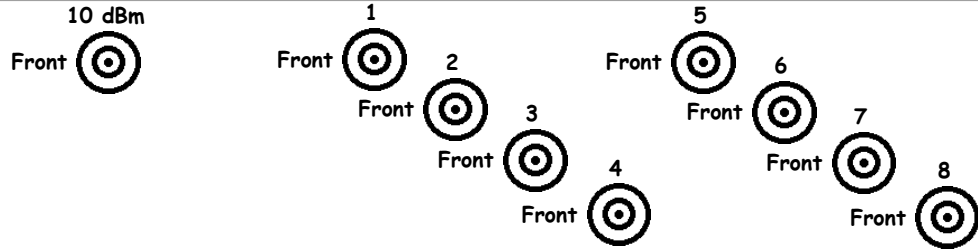
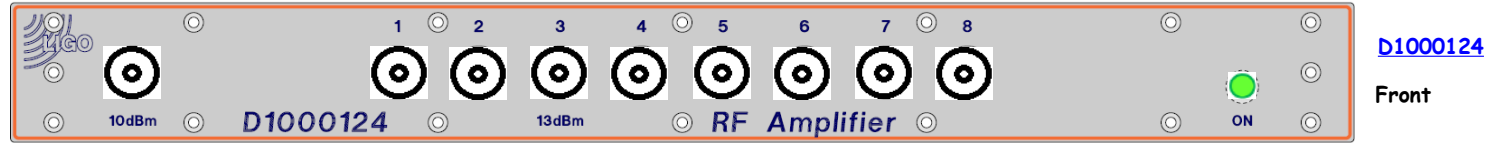

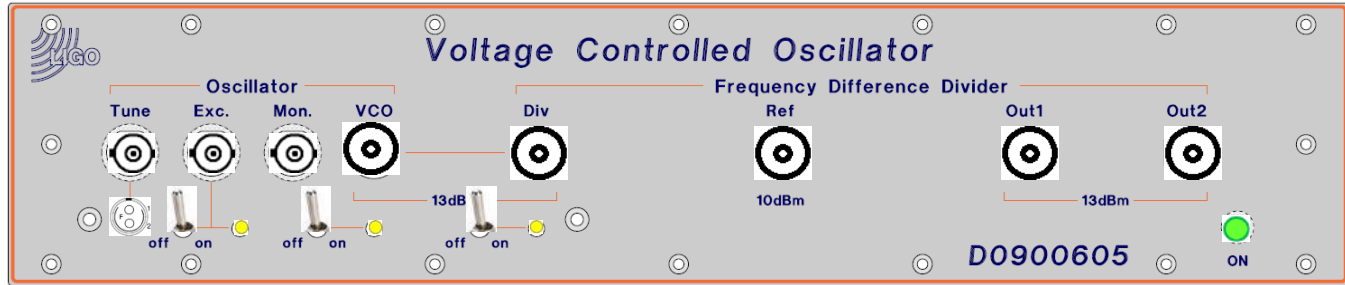

D0900605

Front

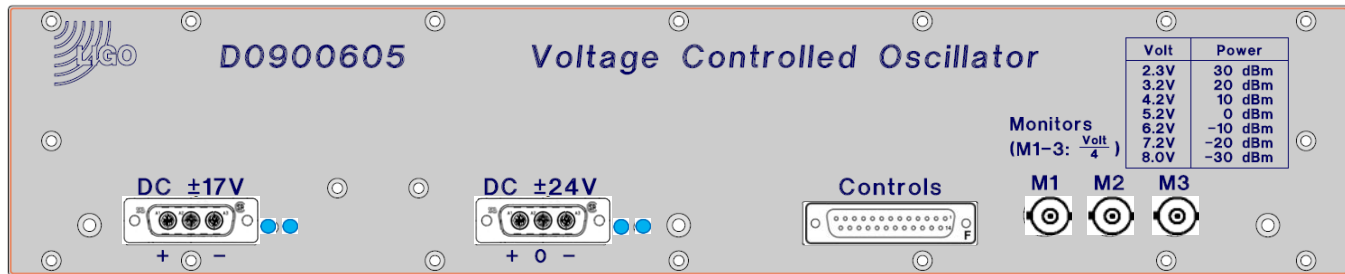

S1200576

Rear

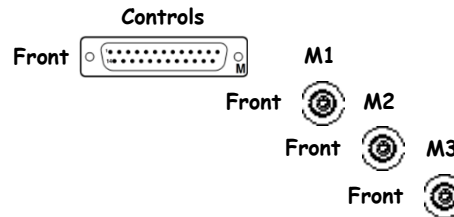
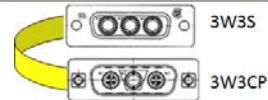

D1201450 - Sxxxxxxx

<< L1-ISC-R1

Dual DSUB Breakout Panel D1201450 Sxxxxxxx ±17VDC, ±24VDC

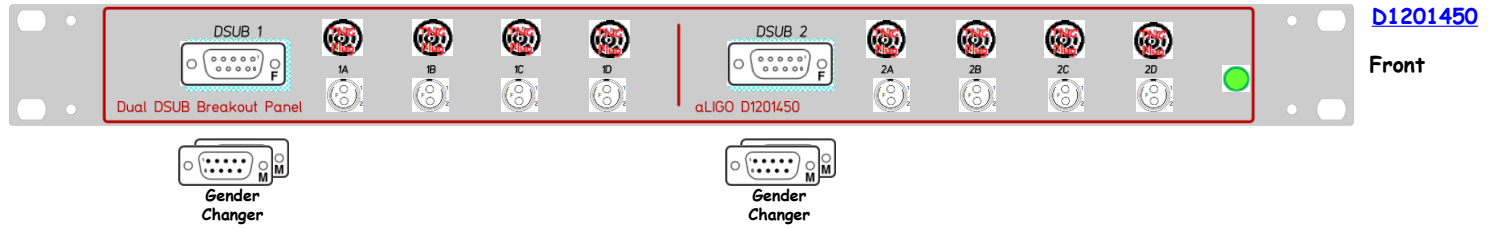

Sxxxxxxx

Rear

D1002178 - S1000740



<< L1-ISC-R1

24.078 MHz Distribution Amplifier

D1002178

S1000740

±17VDC, ±24VDC

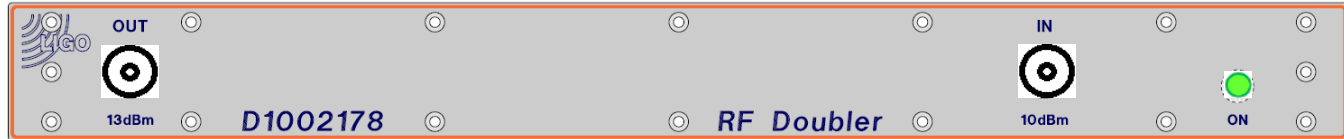

D1002178

Front

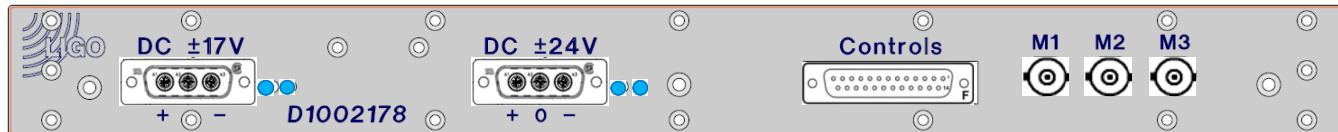

S1000740

Rear

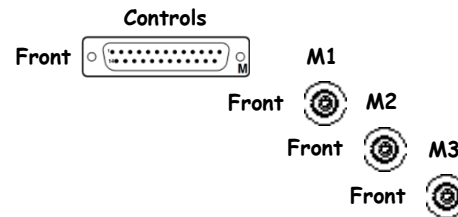
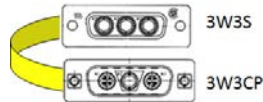

D1002476 - S1000766



<< L1-ISC-R1

158.8 / 79.4 MHz 2-Channel PF Discriminator

D1002476

S1000766

±17VDC, ±24VDC

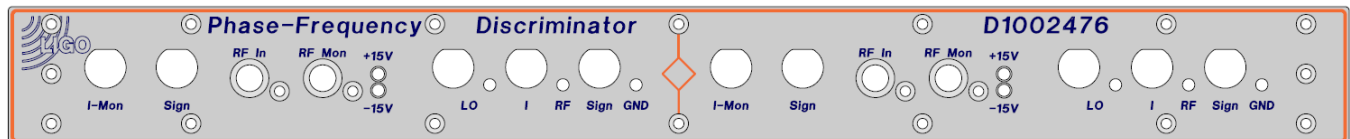

D1002476

Front

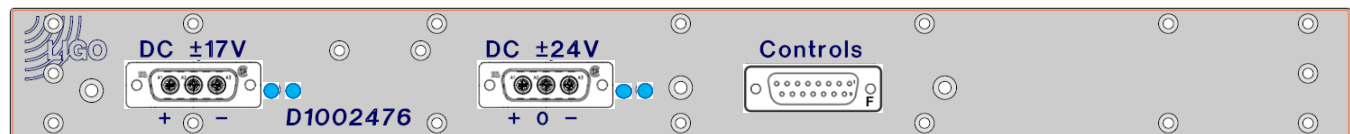

S1000766

Rear

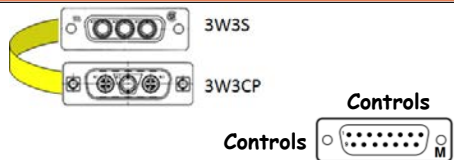

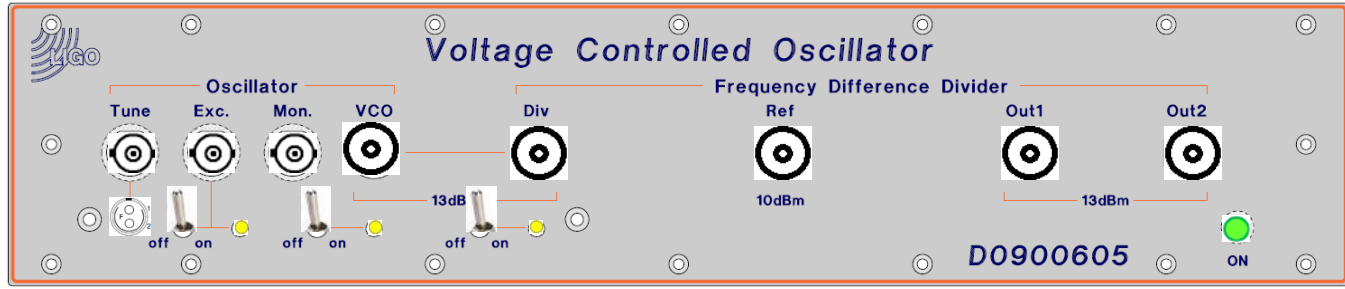

D0900605

Front

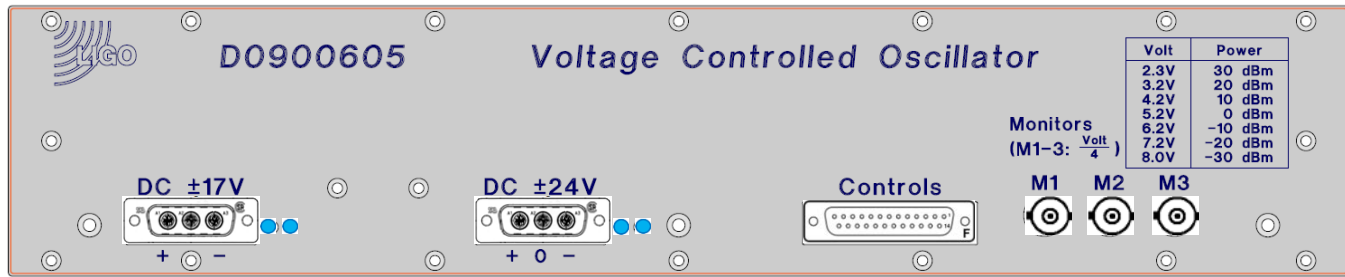

S1200575

Rear

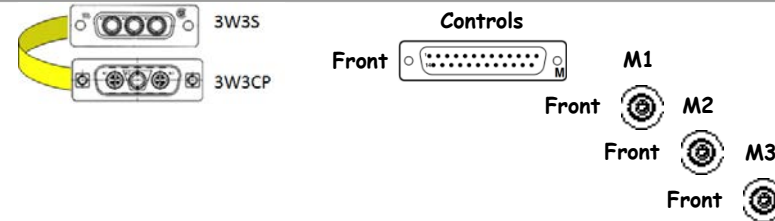

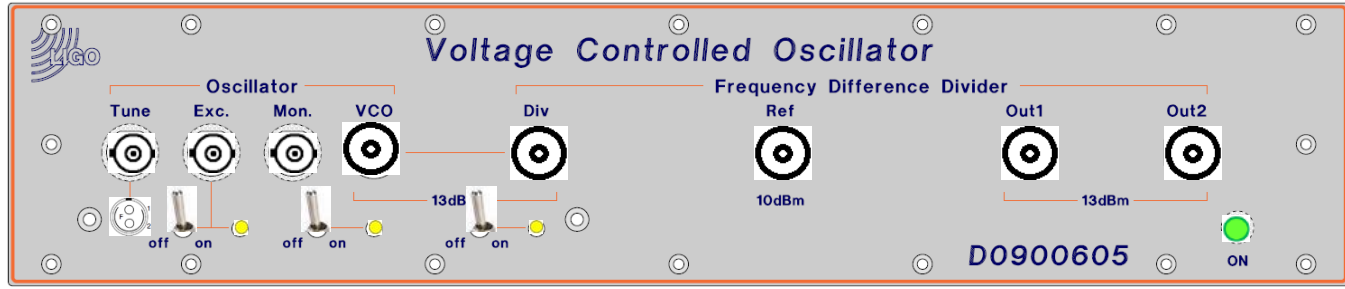

D0900605

Front

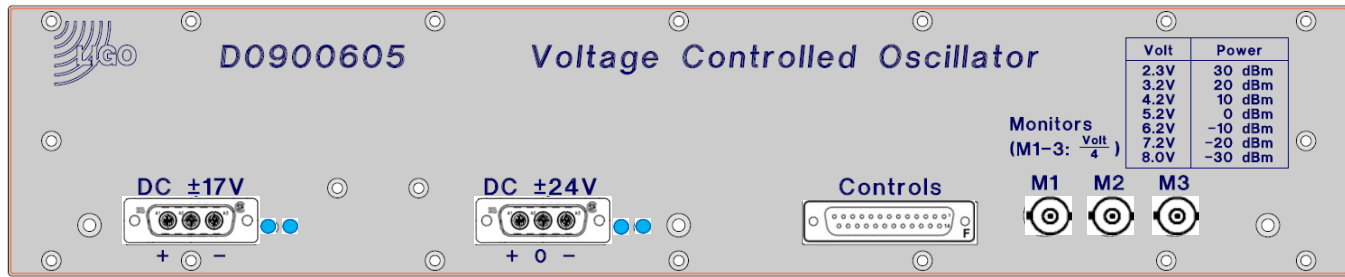

S1200580

Rear

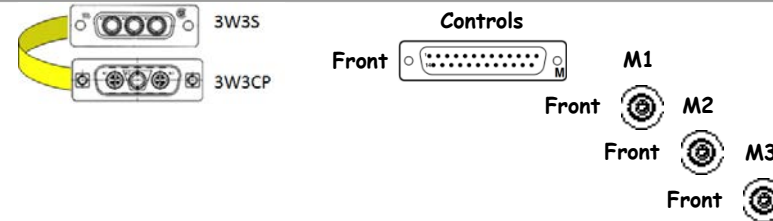

D1002178 - S1000739



<< L1-ISC-R1

24.078 MHz Distribution Amplifier

D1002178

S1000739

±17VDC, ±24VDC

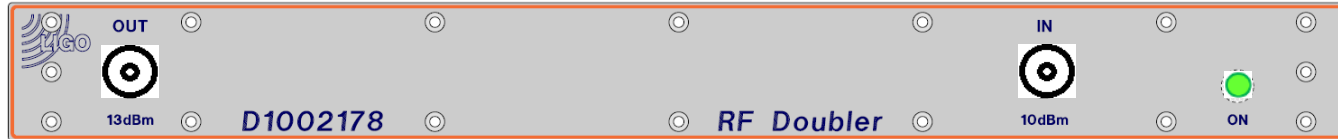

D1002178

Front

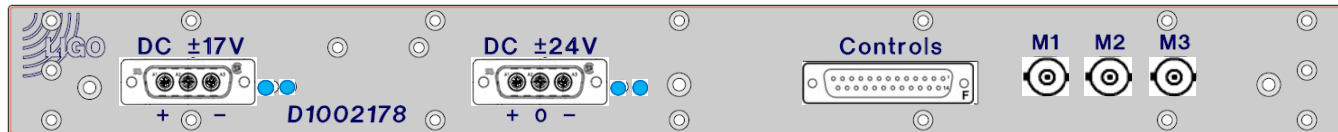

S1000739

Rear

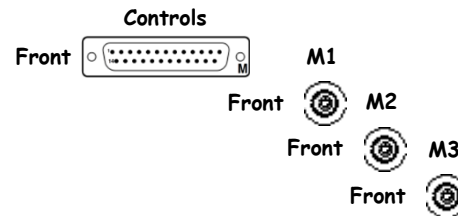
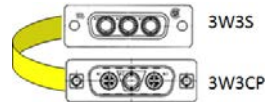

D0900128 - S1103423



<< L1-ISC-R1

24.078 MHz Dual Delay Line +15VDC

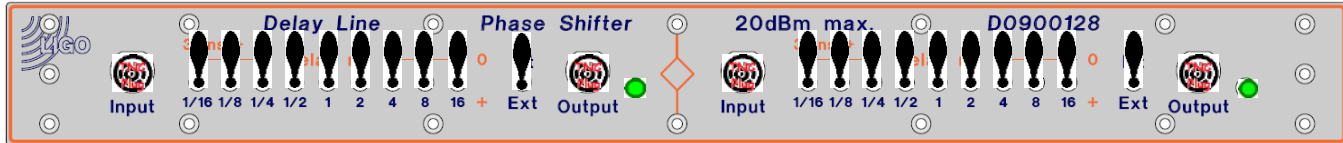

D0900128

Front

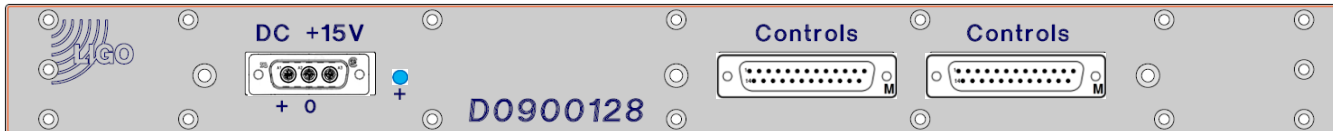

S1103423

Rear

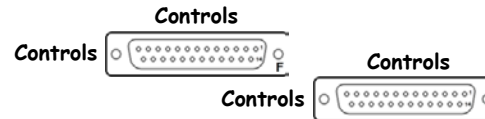

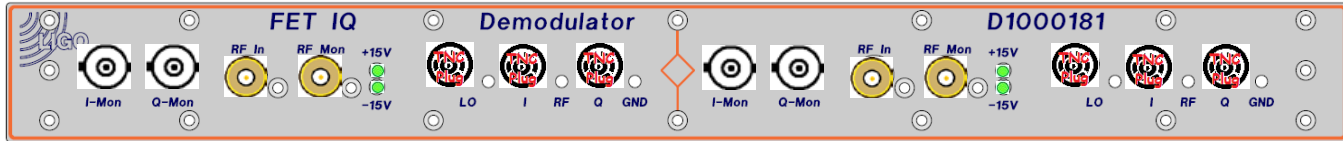

D1000181

Front

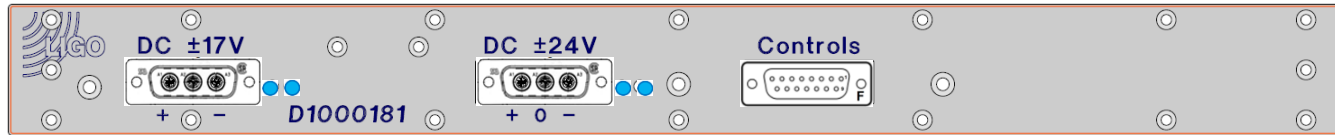

S1000788

Rear

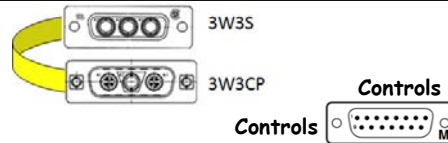

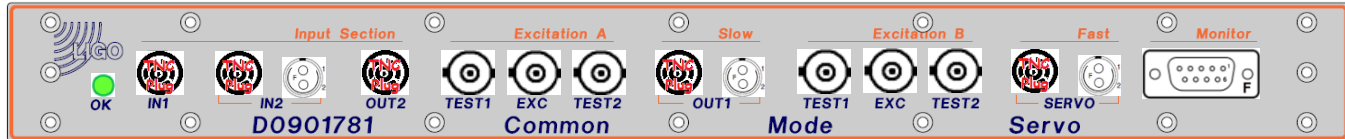

D0901781

Front

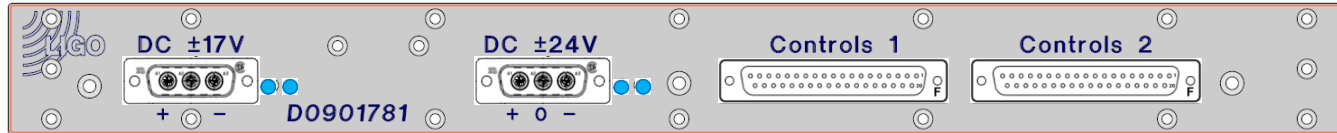

S1102629

Rear

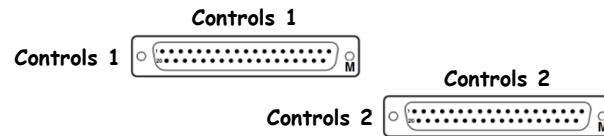
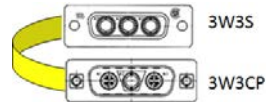

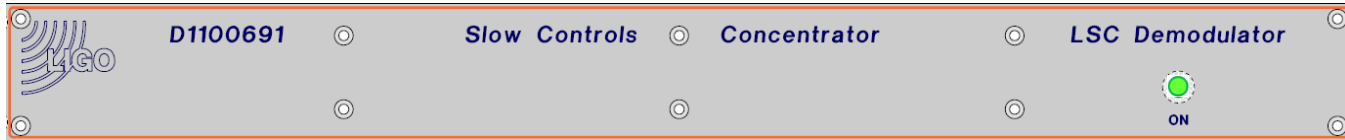

[D1100691](#)

Front

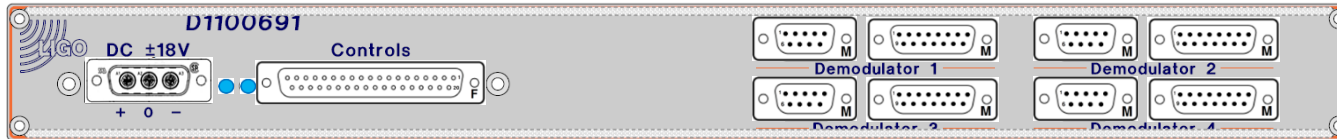

[S1104005](#)

Rear

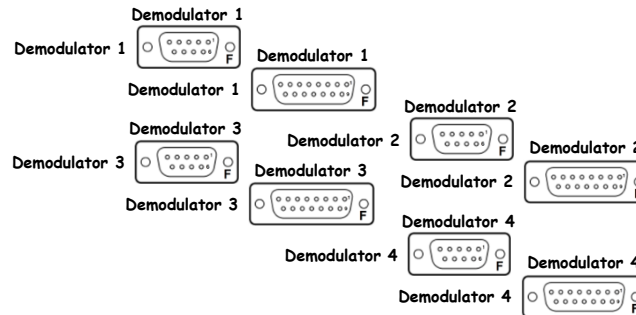
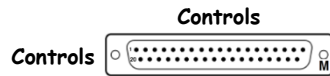

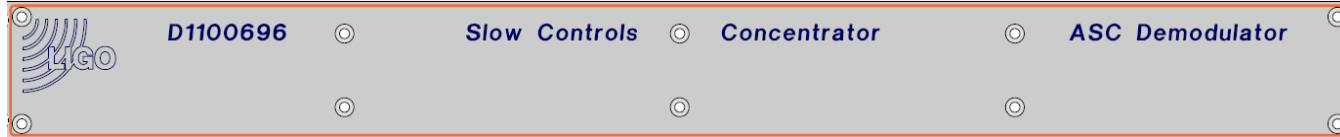

D1100696

Front

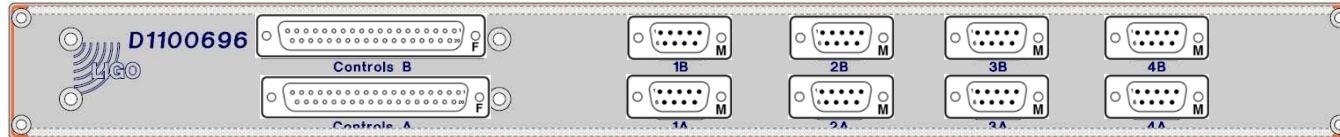

S1103984

Rear

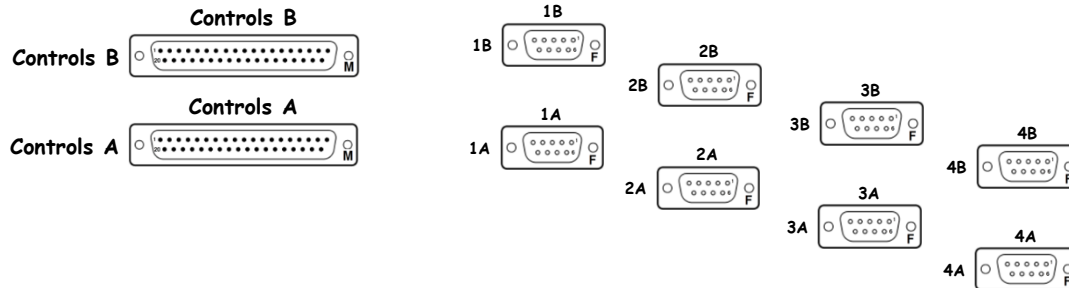

D1102079 - Sxxxxxxx



<< L1-ISC-R1

LSC RFPD Interface ±18VDC

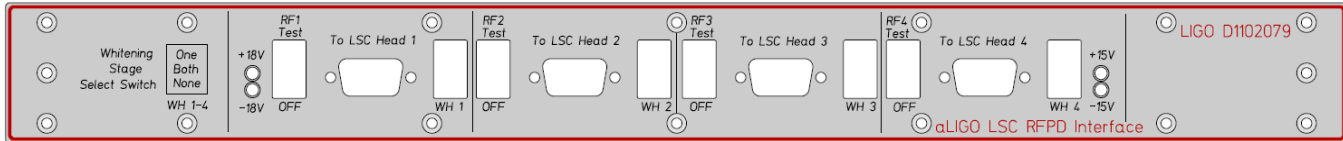

D1102079

Front

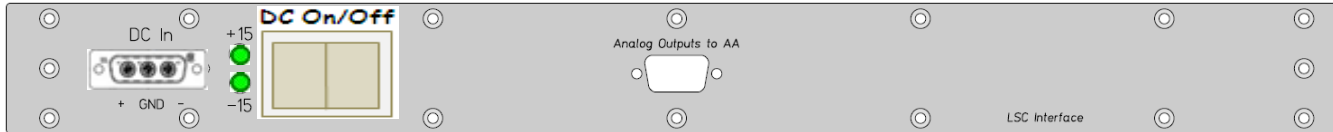

Sxxxxxxx

Rear

<< L1-ISC-R1

WFS RFPD Interface ±15VDC

D1101905



D1101906

Front

D1101908

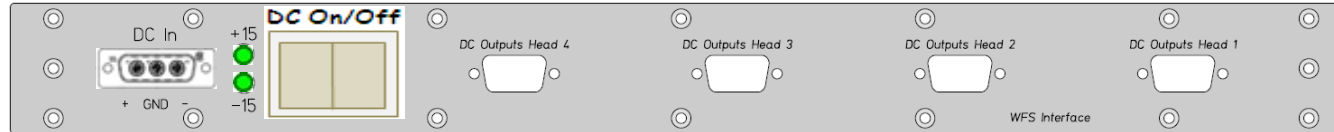

Sxxxxxxx

Rear

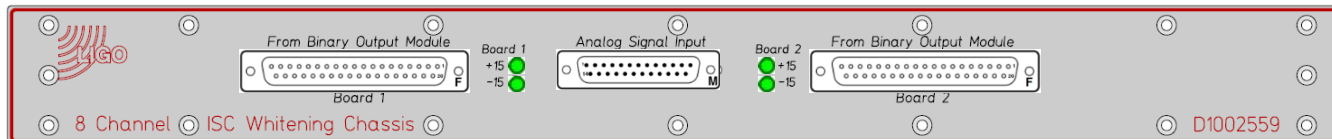

D1002559

Front

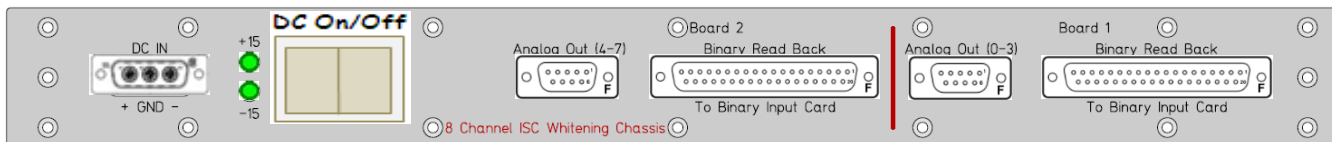
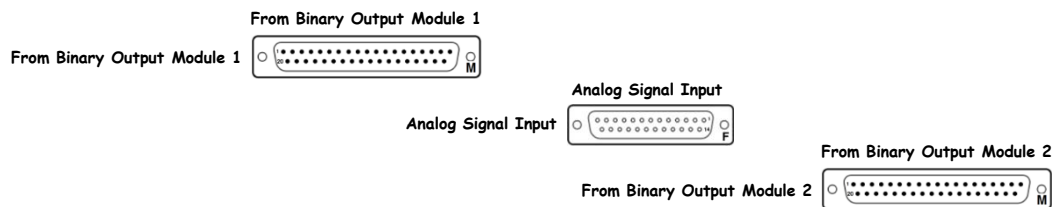

S1101612

Rear

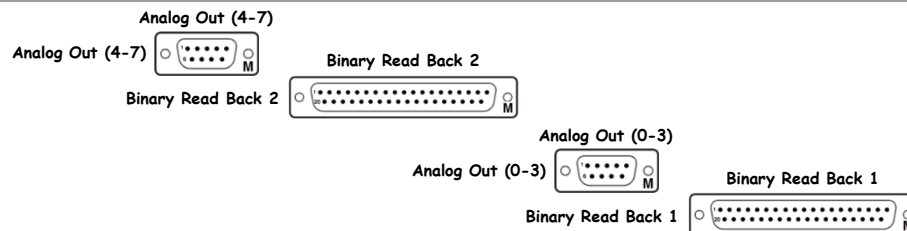

<< L1-ISC-R1 ISC Whitening Chassis (ASC IMC WFS_A 24MHz) D0902796 S1000991 ±15VDC

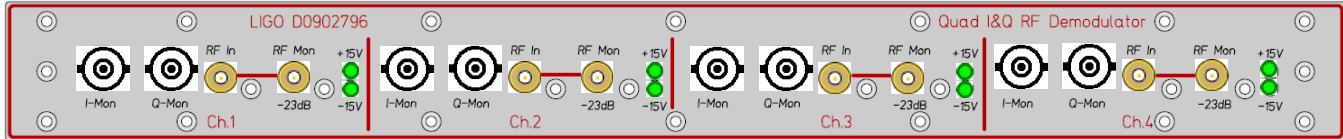

D0902796

Front

D1002032

LSC

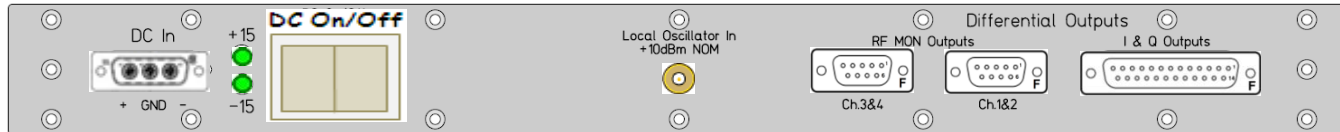

Sxxxxxxx

Rear

RF Mon Out Ch 3&4

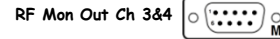

RF Mon Out Ch 3&4

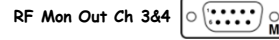

I & Q Outputs



D1002031

WFS

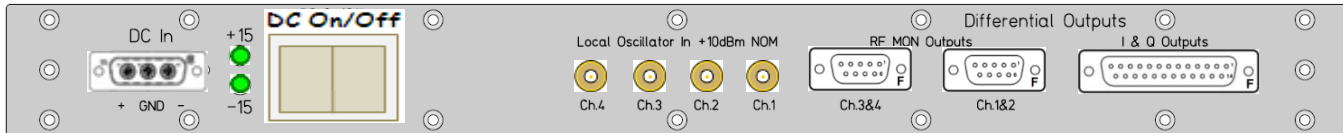

Sxxxxxxx

Rear

RF Mon Out Ch 3&4

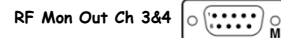

RF Mon Out Ch 3&4

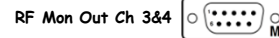

I & Q Outputs



<< L1-ISC-R1

WFS Demodulator Patch Panel

D1100905

Sxxxxxxx

No Power

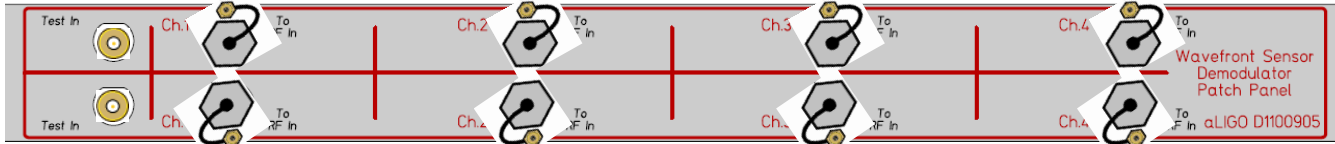

D1100905

Front



Sxxxxxxx

Rear

<< [L1-ISC-R1](#) ISC Whitening Chassis (ASC IMC WFS_B 24MHz) D0902796 S1001024 ±15VDC

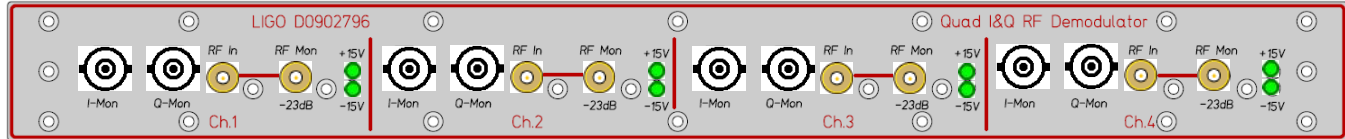

[D0902796](#)

Front

[D1002032](#)

LSC

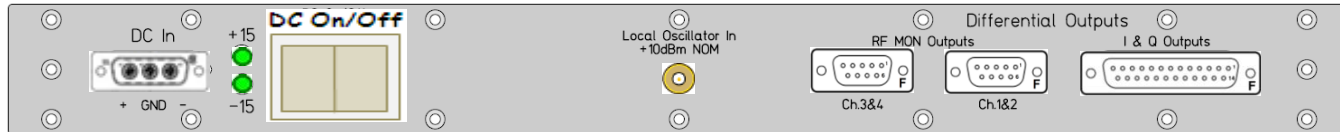

Sxxxxxxx

Rear

RF Mon Out Ch 3&4

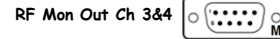

RF Mon Out Ch 3&4

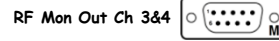

I & Q Outputs



[D1002031](#)

WFS

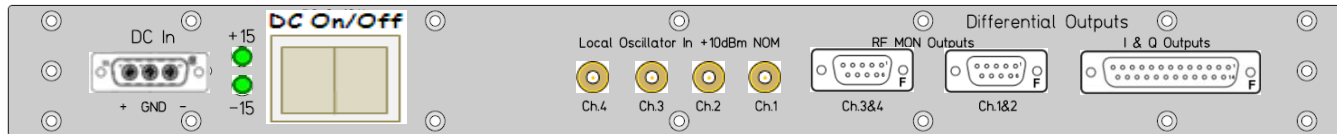

Sxxxxxxx

Rear

RF Mon Out Ch 3&4

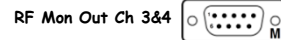

RF Mon Out Ch 3&4

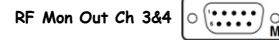

I & Q Outputs



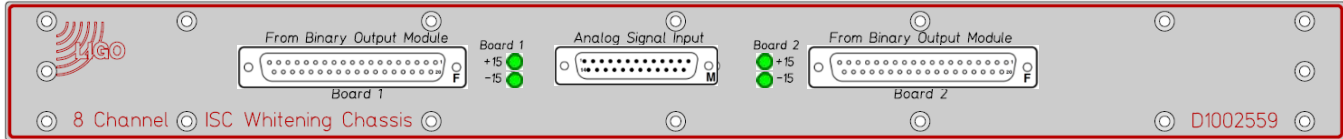

D1002559

Front

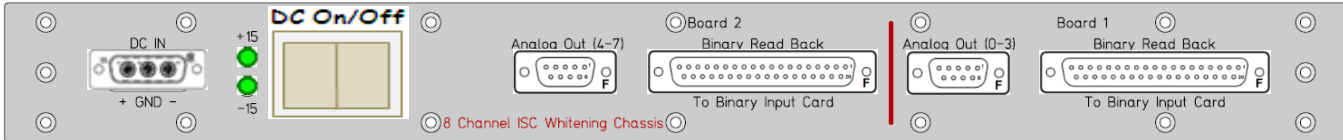
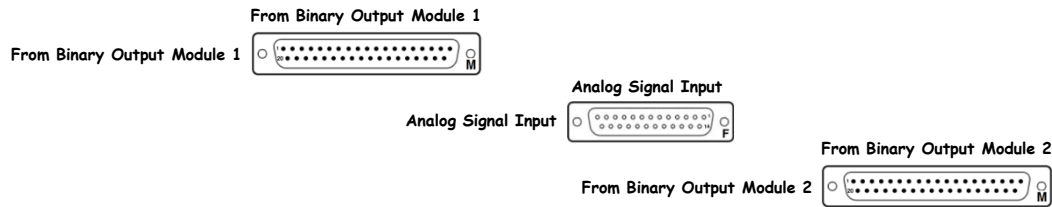

S1101571

Rear

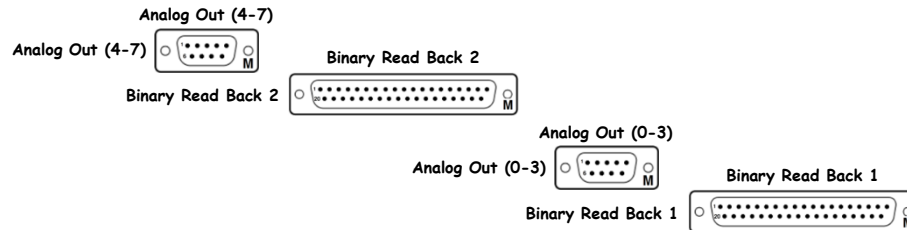

D1100482 - S1202844



<< [L1-ISC-R1](#)

Differential to Single-Ended Receiver

[D1100482](#)

[S1202844](#)

±15VDC

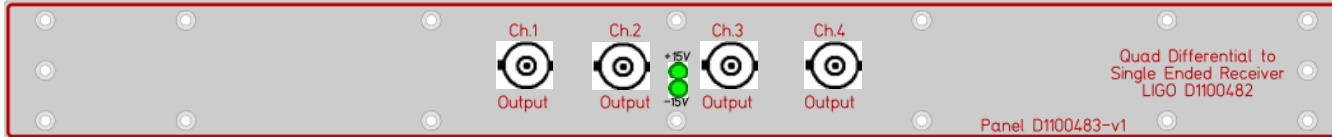

[D1100482](#)

Front



[S1202844](#)

Rear



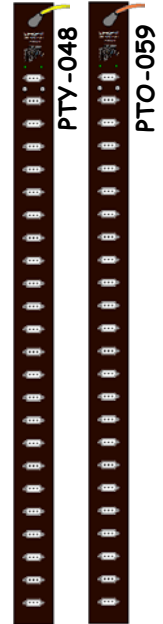

- RF Patch Panel 13
- RF Patch Panel 14
- 45 MHz Distribution Amplifier
- 9.099/8.684 MHz Distribution Amplifier
- 9.099/8.684 MHz Dual Delay Line
- 9.099/8.684 MHz 2-Channel Demodulator
- ISC Whitening (LSC POPAIR A 9&45, LSC REFLAIR A 45)
- LSC I/Q Demodulator (LSC POPAIR A 9&45, LSC REFLAIR A 45)
- LSC Demodulator Patch Panel
- LSC I/Q Demodulator (LSC POPAIR B 18&90, LSC REFLAIR B 27&135)
- ISC Whitening (LSC POPAIR B 18&90, LSC REFLAIR B 27&135)
- LSC I/Q Demodulator (LSC POP, LSC REFL)
- LSC Demodulator Patch Panel
- ISC Whitening (LSC POP, LSC REFL)
- ISC Whitening (ASC REFLAIR A 9MHz)
- WFS I/Q Demodulator (ASC REFLAIR A 9MHz)
- WFS Demodulator Patch Panel
- WFS I/Q Demodulator (ASC REFLAIR A 45MHz)
- ISC Whitening (ASC REFLAIR A 45MHz)
- ISC Whitening (ASC REFLAIR B 9MHz)
- WFS I/Q Demodulator (ASC REFLAIR B 9MHz)
- WFS Demodulator Patch Panel
- WFS I/Q Demodulator (ASC REFLAIR B 45MHz)
- ISC Whitening (ASC REFLAIR B 45MHz)
- WFS I/Q Demodulator (Spare AIR to VAC)
- WFS Demodulator Patch Panel
- ISC Whitening (Spare AIR to VAC)

Dxxxxxxx	42	Sxxxxxxx
Dxxxxxxx	41	Sxxxxxxx
Dxxxxxxx	40	Sxxxxxxx
D1000124	39	S1000665
D1000124	38	S1000658
D0900128	37	S1103416
	36	
D1000181	35	S1000784
	34	S1000784
D1002559	33	S1101620
	32	S1101620
D0902796	31	S1001004
D1100956	30	S1001004
D0902796	29	Sxxxxxxx
	28	S1001007
D1002559	27	S1101624
	26	S1101624
D0902796	25	S1001012
D1100956	24	S1001012
D1002559	23	Sxxxxxxx
	22	S1101625
D1002559	21	S1101596
	20	S1101596
D0902796	19	S1001030
D1100905	18	S1001030
D0902796	17	Sxxxxxxx
	16	S1000986
D1002559	15	S1101623
	14	S1101623
D1002559	13	S1101623
	12	S1101621
D0902796	11	S1101621
D1100905	10	S1001010
D0902796	9	S1001010
	8	Sxxxxxxx
	7	S1001006
D1002559	6	S1101609
	5	S1101609
D0902796	4	S1001019
D1100905	3	S1001019
D1002559	2	Sxxxxxxx
	1	S1101597

- No Power
- No Power
- ±17VDC, ±24VDC
- ±17VDC, ±24VDC
- +15VDC
- ±17VDC, ±24VDC
- ±15VDC
- ±15VDC
- No Power
- ±15VDC
- ±15VDC
- ±15VDC
- No Power
- ±15VDC
- ±15VDC
- ±15VDC
- No Power
- ±15VDC
- ±15VDC
- No Power
- ±15VDC

Front

Rear

L1-ISC-R2 Details

RF Patch Panel 13

Dxxxxxxx

Sxxxxxxx

No Power

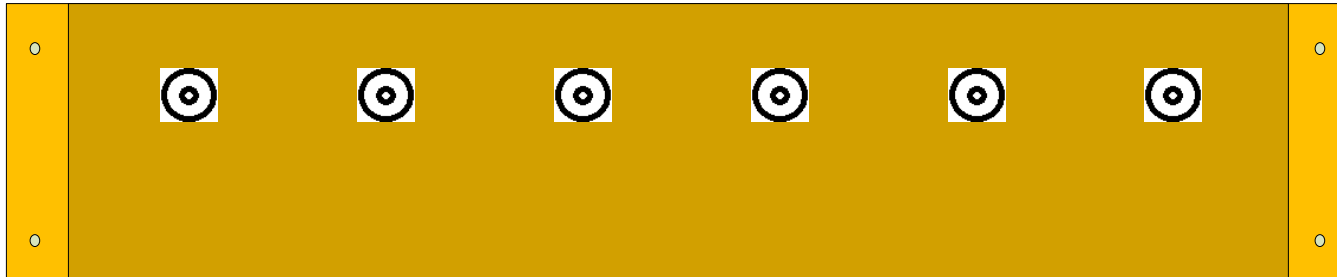

Dxxxxxxx

Front

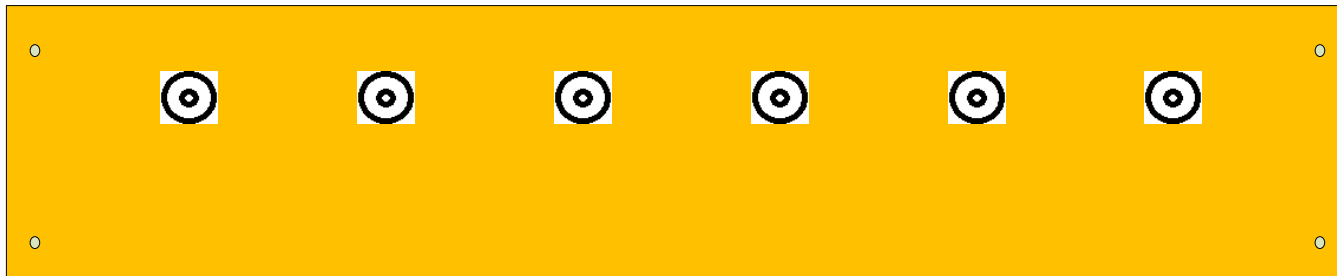

Sxxxxxxx

Rear

RF Patch Panel 14

Dxxxxxxx

Sxxxxxxx

No Power

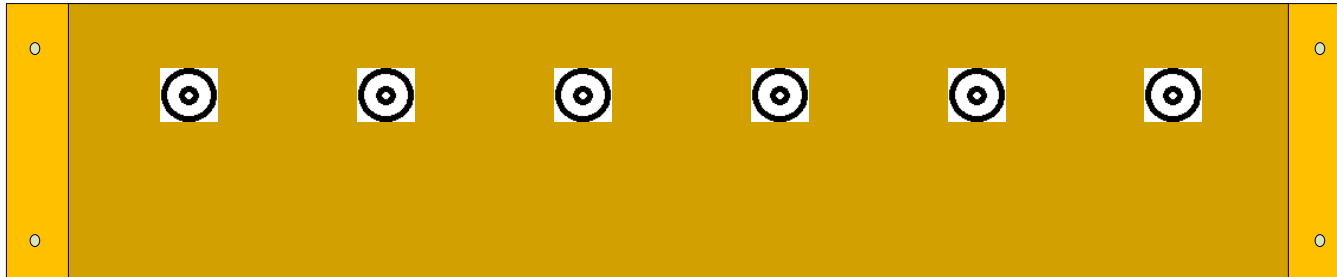

Dxxxxxxx

Front

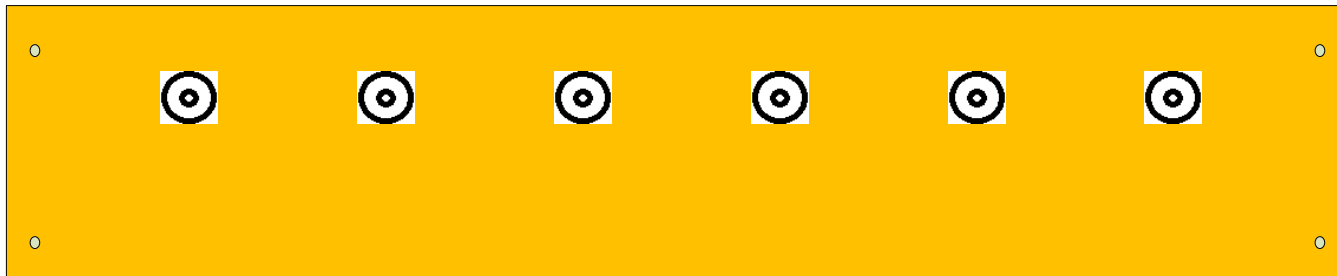

Sxxxxxxx

Rear

45 MHz Distribution Amplifier D1000124 S1000665 ±17VDC, ±24VDC

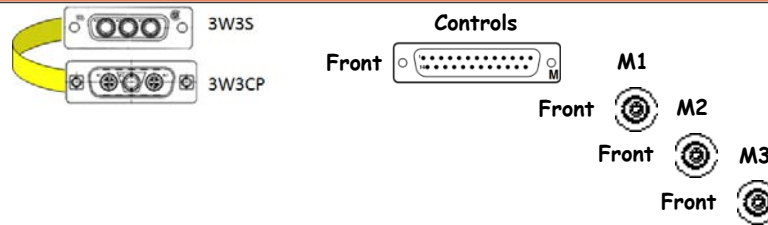
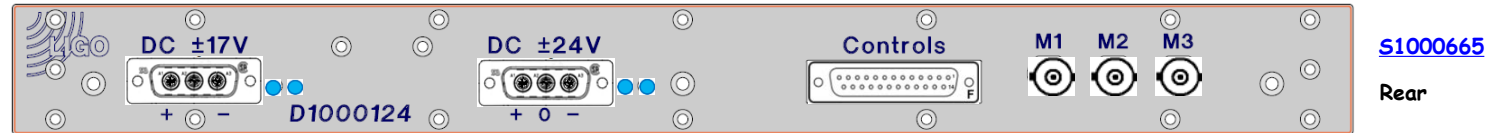
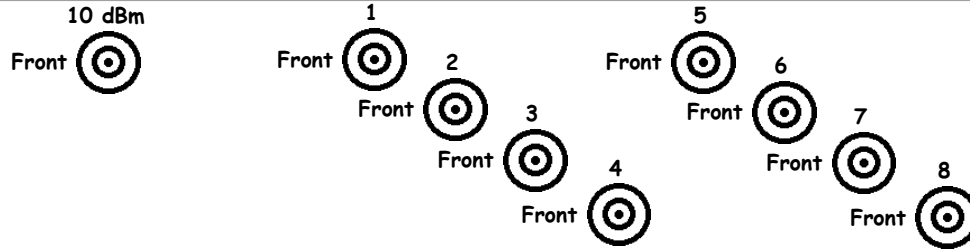
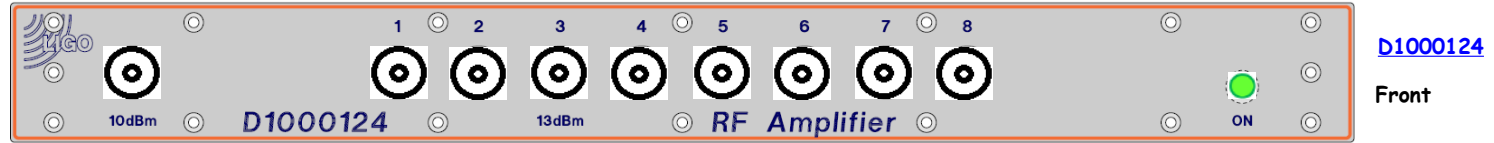

D1000124
Front

S1000665
Rear

9.099/8.684 MHz Distribution Amplifier D1000124 S1000658 ±17VDC, ±24VDC

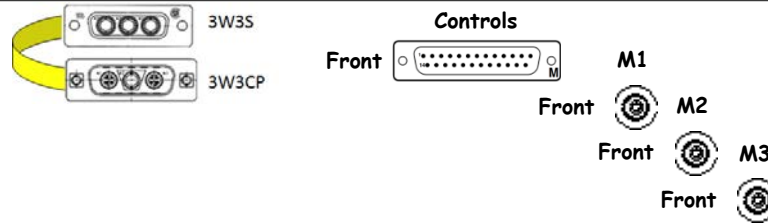
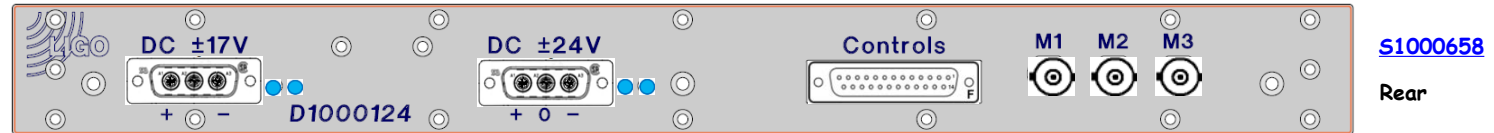
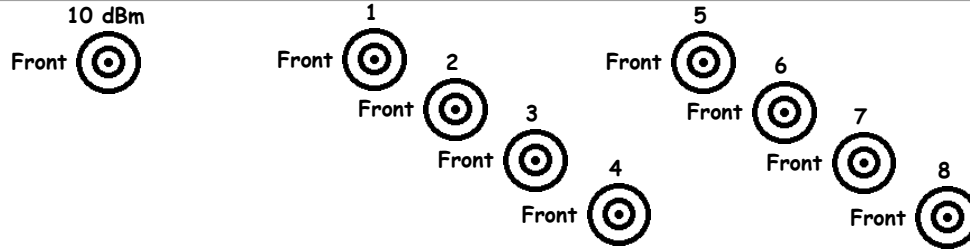
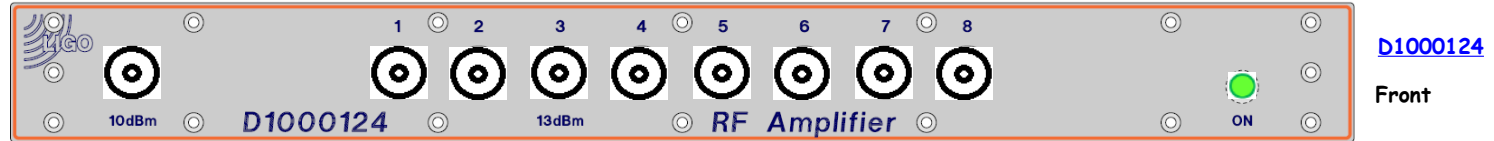

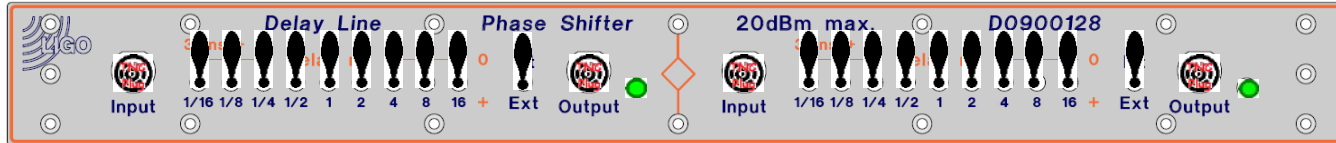

D0900128

Front

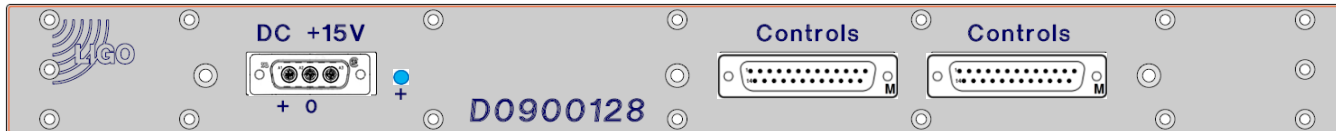

S1103416

Rear

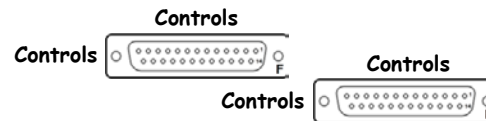

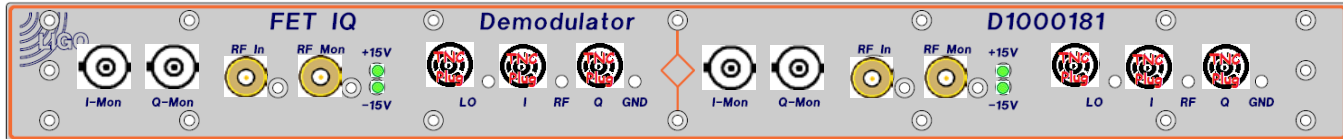

D1000181

Front

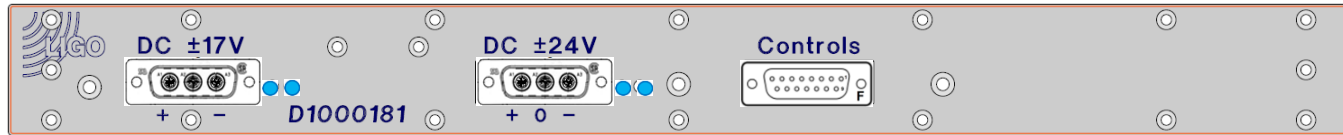

S1000784

Rear

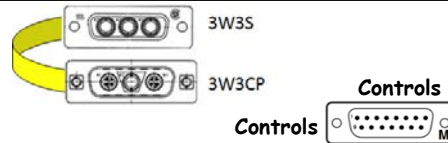

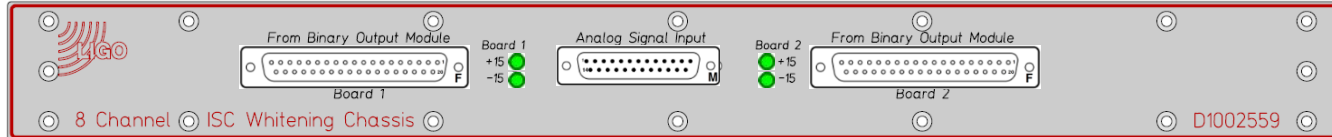

D1002559

Front

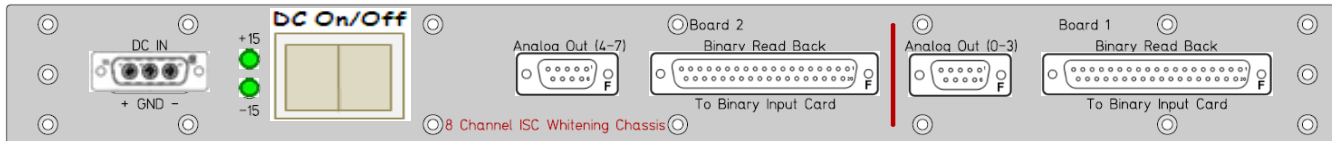
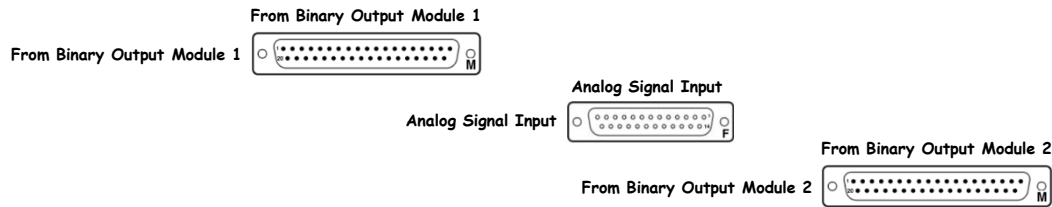

S1101620

Rear

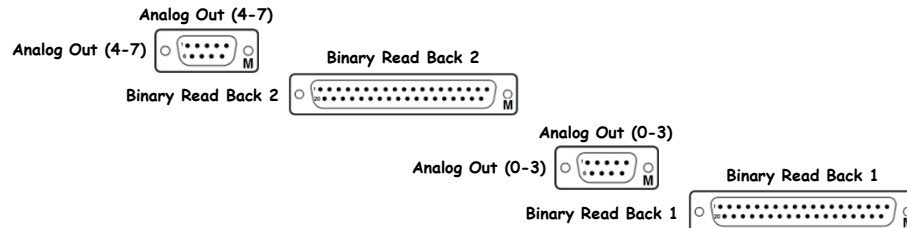

D0902796 - S1001004

LIGO

<< [L1-ISC-R2](#)

LSC I/Q Demodulator (LSC POPAIR A 9&45, LSC REFLAIR A 45)

[D0902796](#)

[S1001004](#)

±15VDC

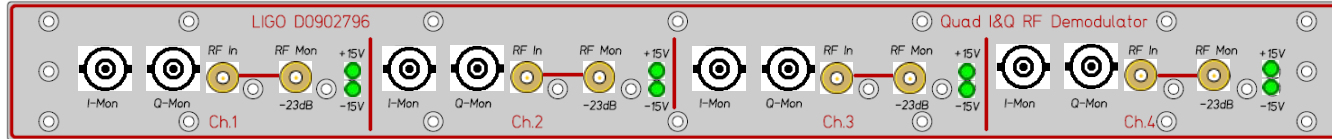

[D0902796](#)

Front

[D1002032](#)

LSC

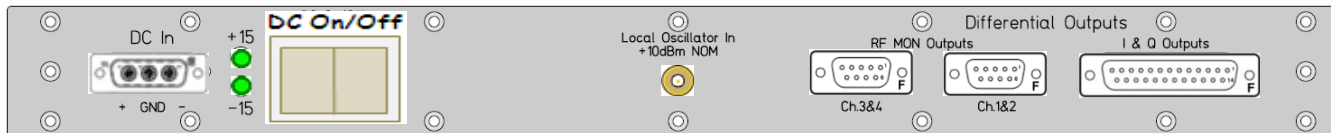

[S1001004](#)

Rear

RF Mon Out Ch 3&4

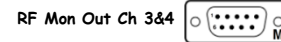

RF Mon Out Ch 3&4

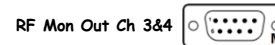

I & Q Outputs



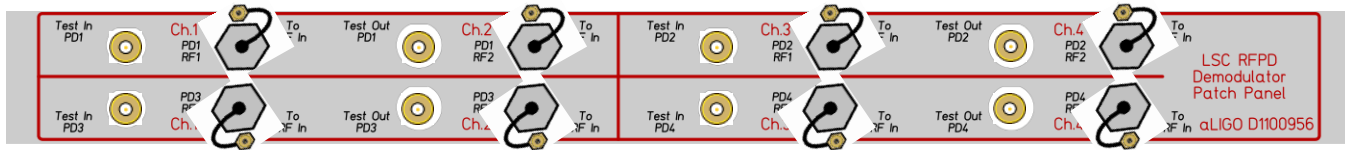

[D1100956](#)

Front



Sxxxxxxx

Rear

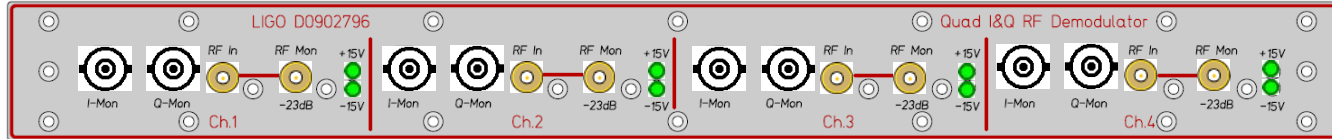

D0902796

Front

D1002032

LSC

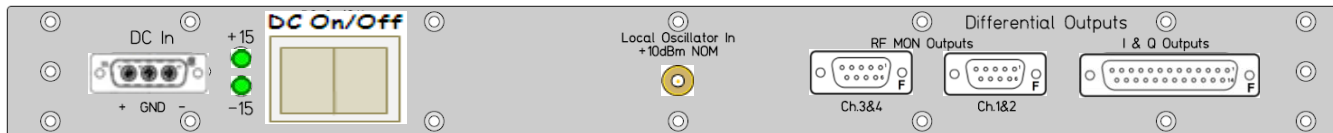

S1001007

Rear

RF Mon Out Ch 3&4

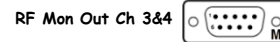

RF Mon Out Ch 3&4

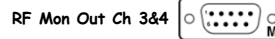

I & Q Outputs



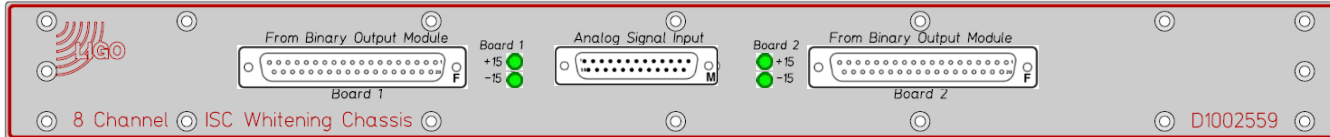

D1002559

Front

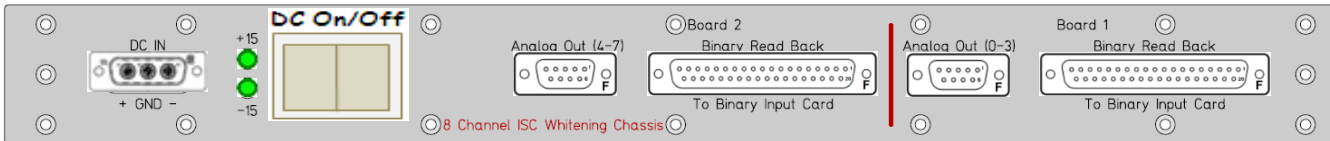
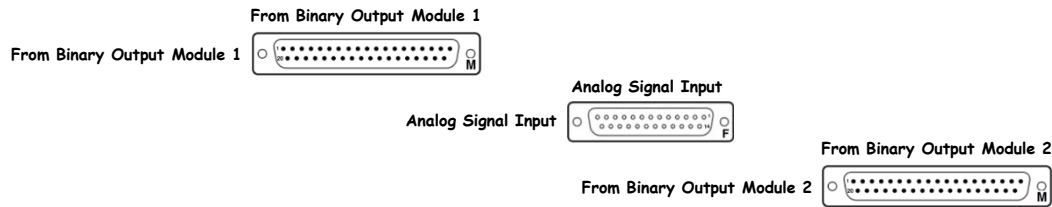

S1101624

Rear

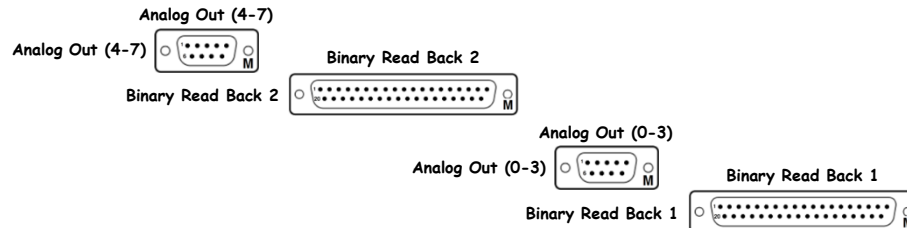

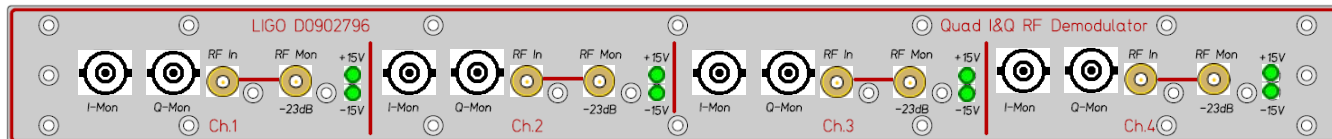

D0902796

Front

D1002032

LSC

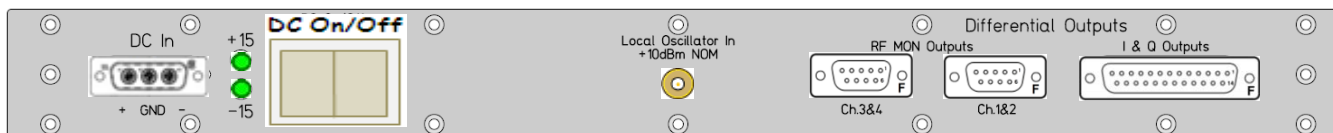

S1001012

Rear

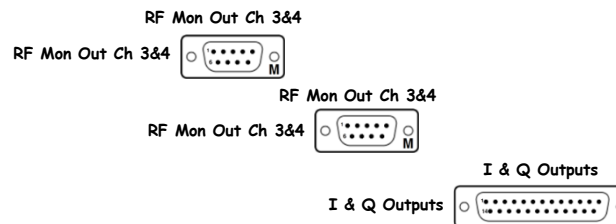

<< L1-ISC-R2

LSC Demodulator Patch Panel No Power

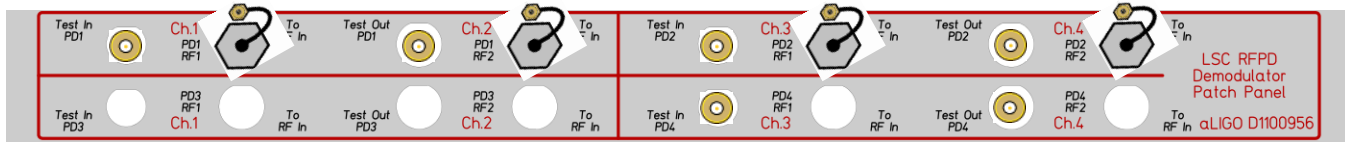

[D1100956](#)

Front



Sxxxxxxx

Rear

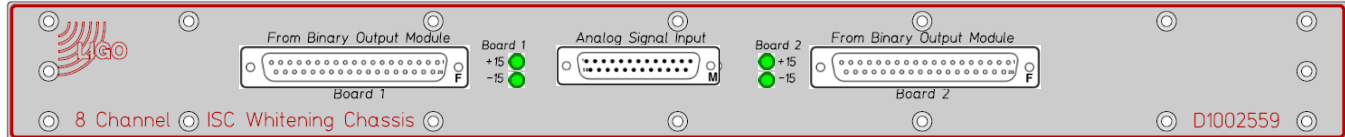

[D1002559](#)

Front

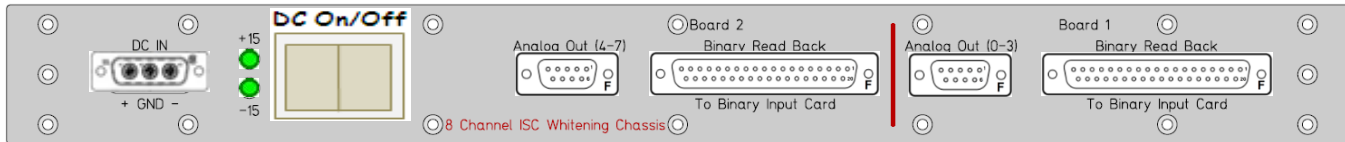
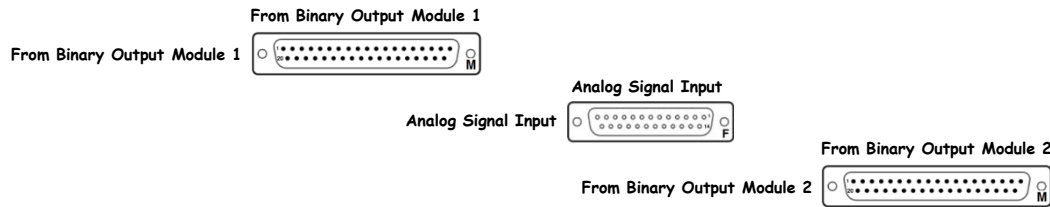

[S1101625](#)

Rear

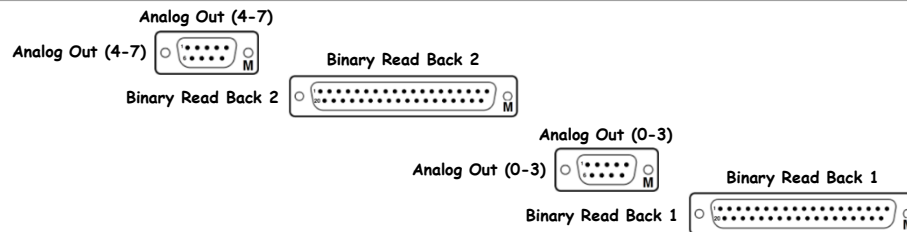

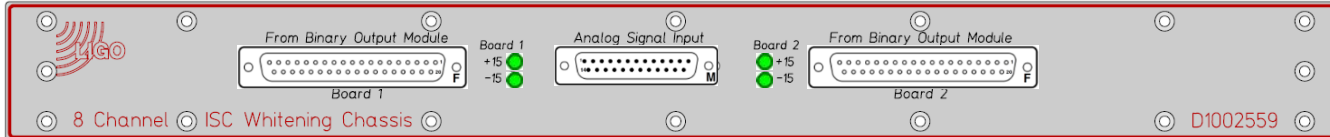

[D1002559](#)

Front

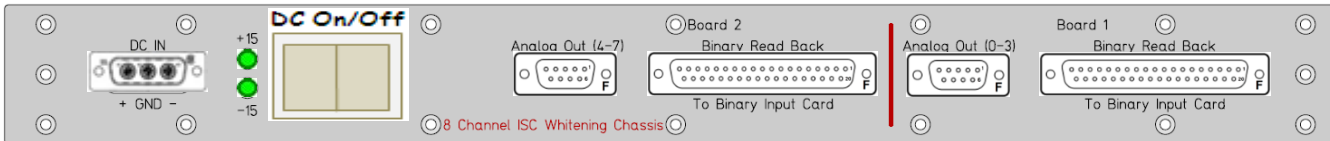
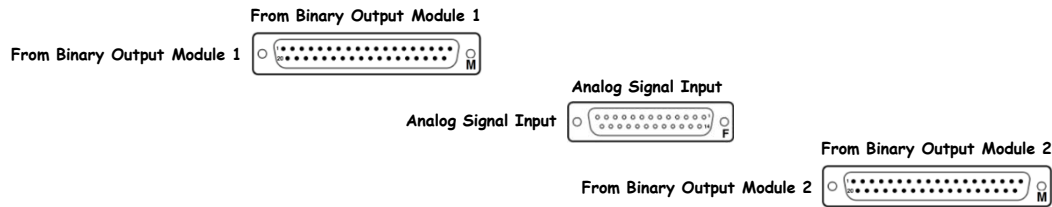

[S1101596](#)

Rear

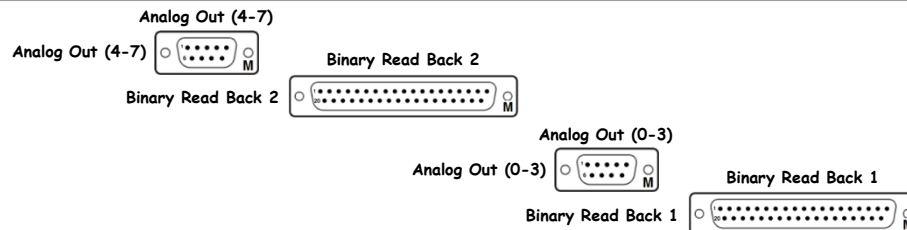

D0902796 - S1001030



<< L1-ISC-R2

WFS I/Q Demodulator (ASC REFLAIR A 9MHz)

D0902796

S1001030

±15VDC

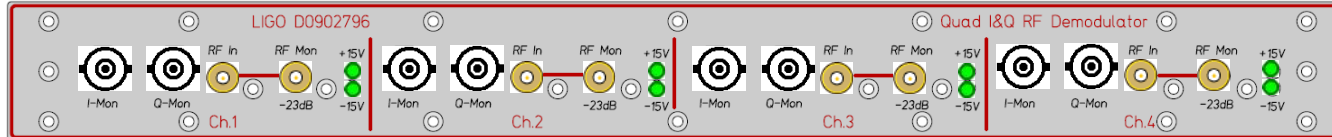

D0902796

Front

D1002031

WFS

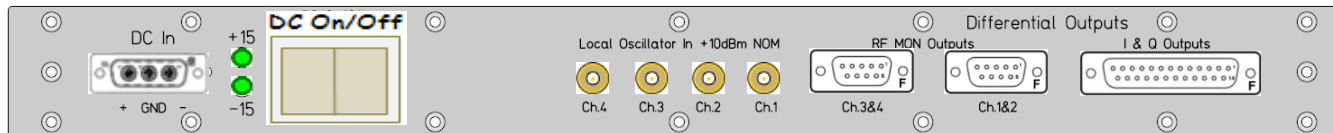

S1001030

Rear

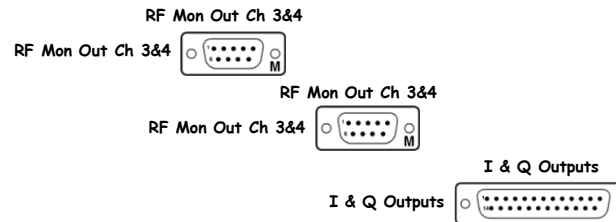

<< L1-ISC-R2

WFS Demodulator Patch Panel No Power

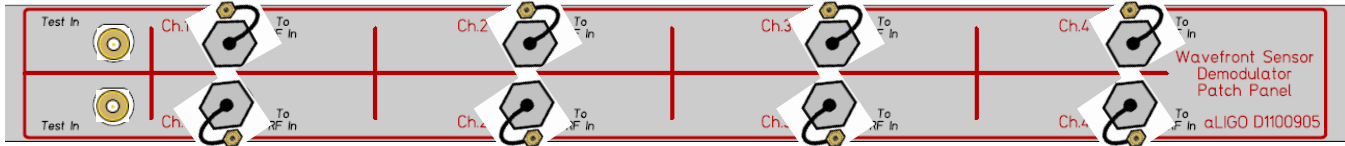

[D1100905](#)

Front



Sxxxxxxx

Rear

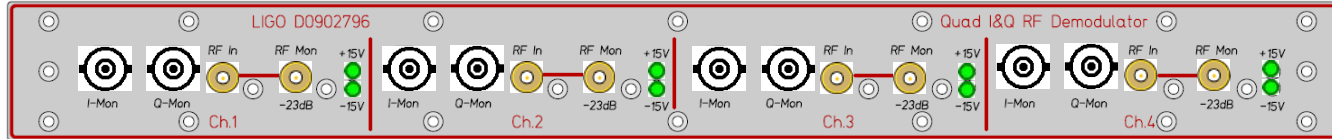

D0902796

Front

D1002031

WFS

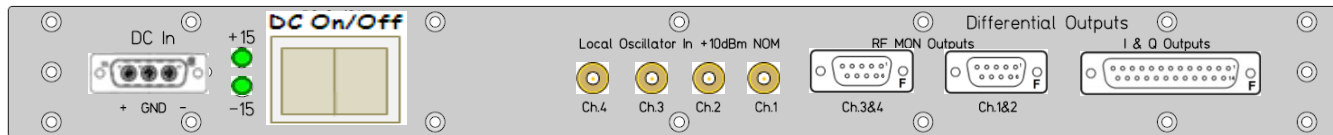

S1000986

Rear

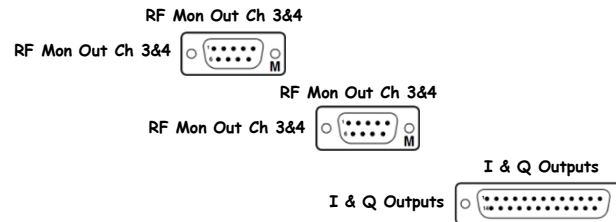

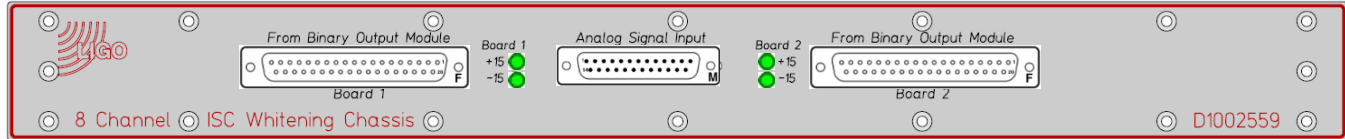

D1002559

Front

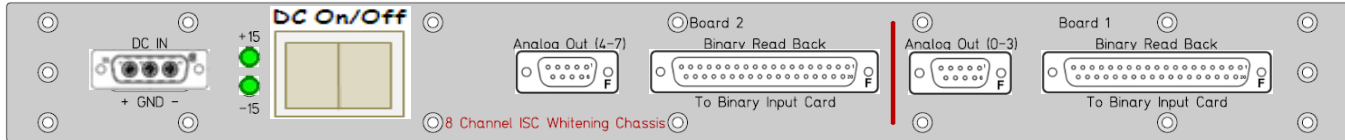
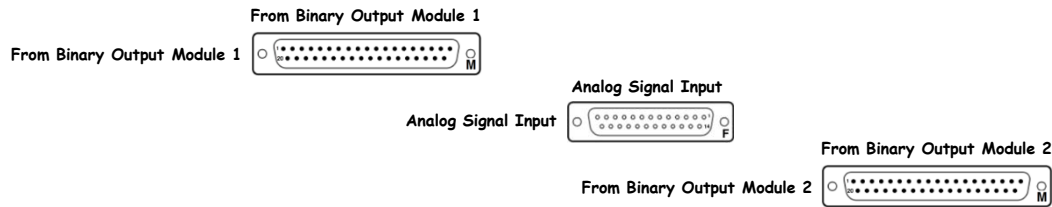

S1101623

Rear

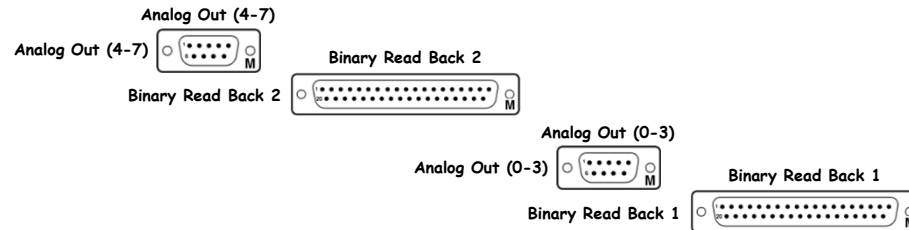

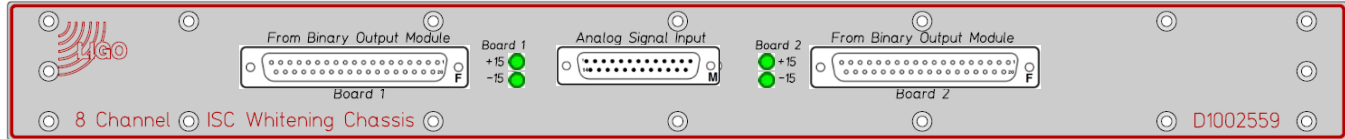

[D1002559](#)

Front

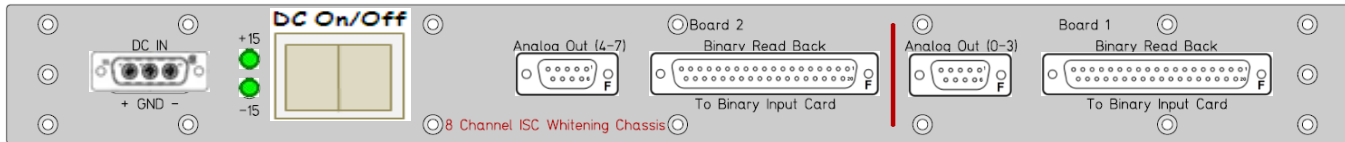
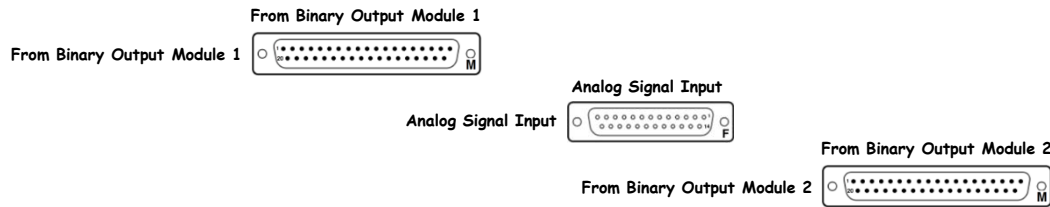

[S1101621](#)

Rear

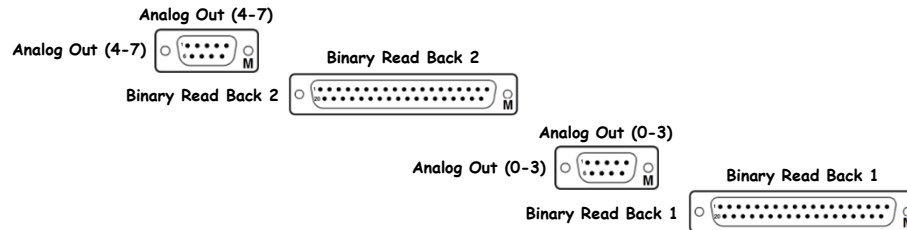

D0902796 - S1001010



<< L1-ISC-R2

WFS I/Q Demodulator (ASC REFLAIR B 9MHz)

D0902796

S1001010

±15VDC

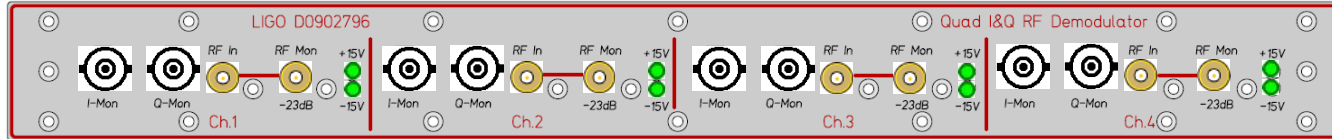

D0902796

Front

D1002031

WFS

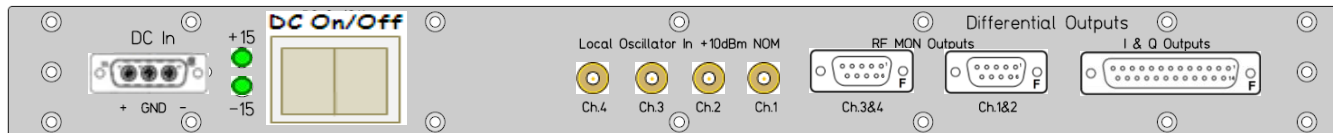

S1001010

Rear

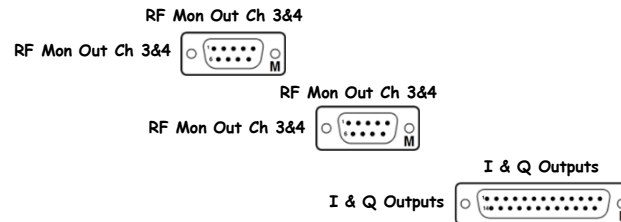

<< L1-ISC-R2

WFS Demodulator Patch Panel No Power

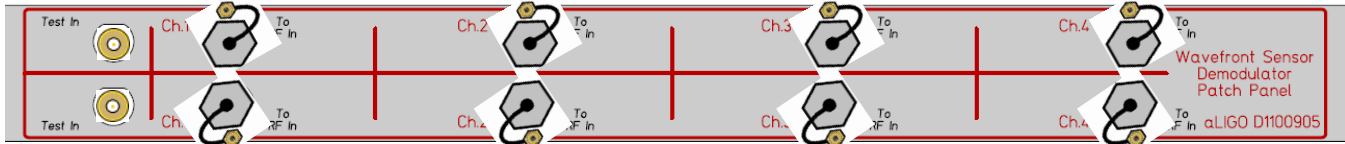

[D1100905](#)

Front



Sxxxxxxx

Rear

D0902796 - S1001006

LIGO

<< L1-ISC-R2

WFS I/Q Demodulator (ASC REFLAIR B 45MHz)

D0902796

S1001006

±15VDC

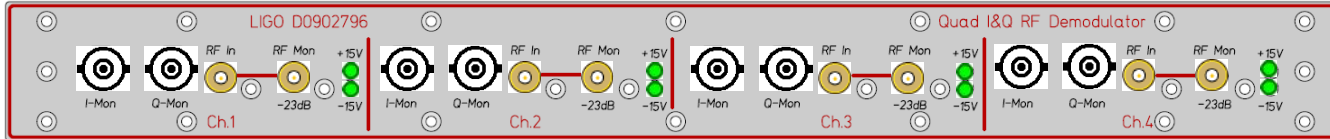

D0902796

Front

D1002031

WFS

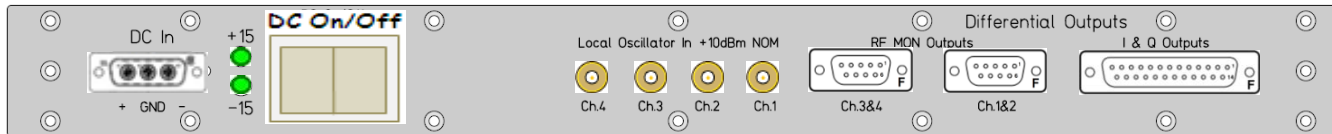

S1001006

Rear

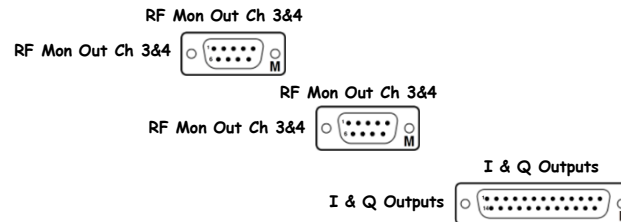

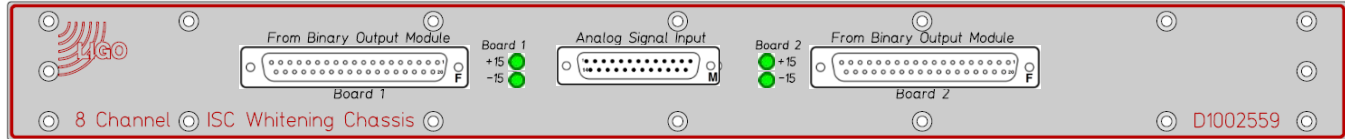

[D1002559](#)

Front

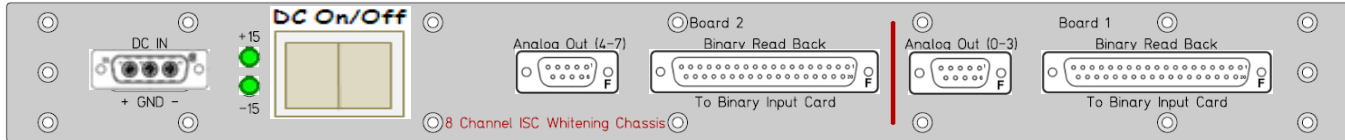
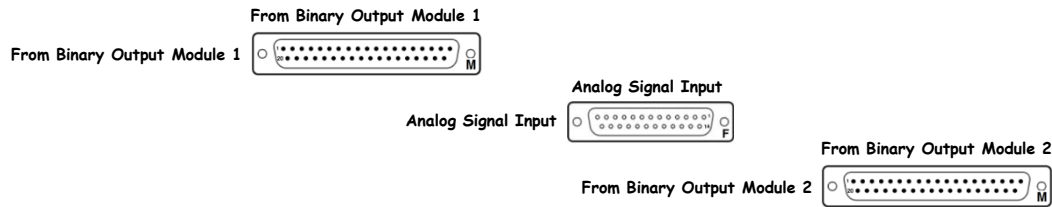

[S1101609](#)

Rear

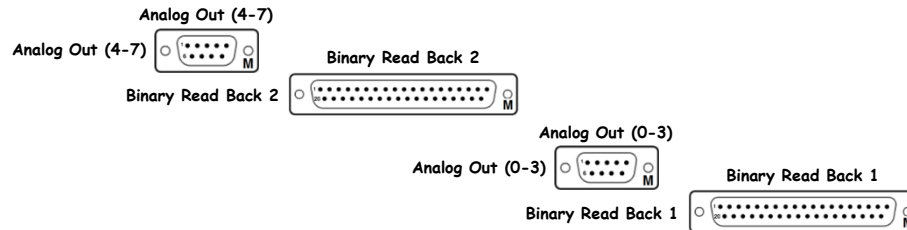

D0902796 - S1001019



<< L1-ISC-R2

WFS I/Q Demodulator (Spare AIR to VAC)

D0902796

S1001019

±15VDC

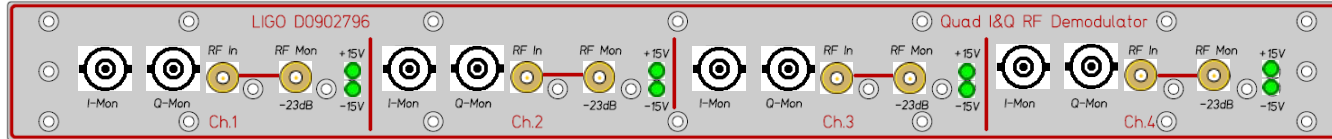

D0902796

Front

D1002031

WFS

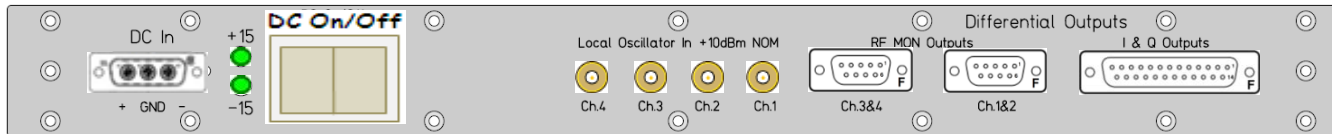

S1001019

Rear

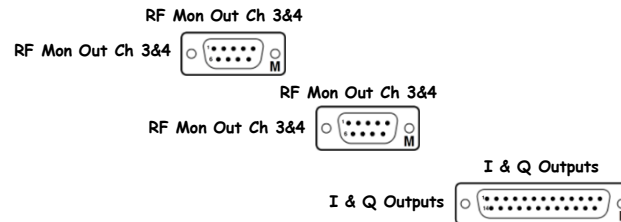

<< L1-ISC-R2

WFS Demodulator Patch Panel No Power

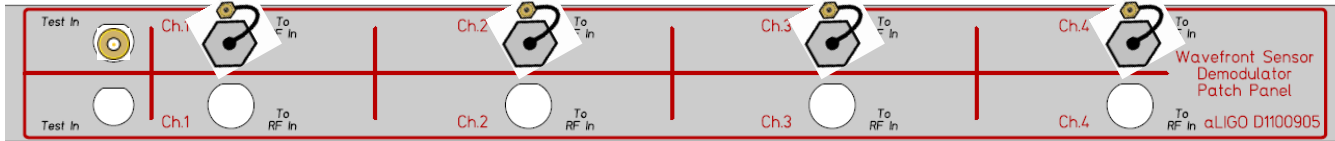

D1100905

Front



Sxxxxxxx

Rear

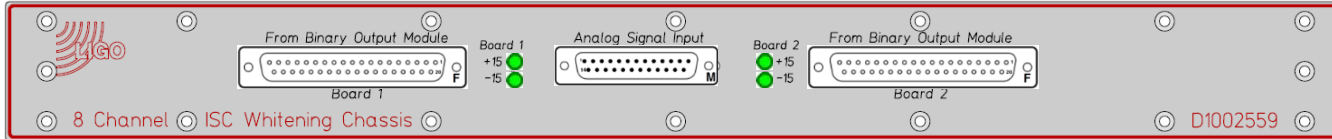

[D1002559](#)

Front

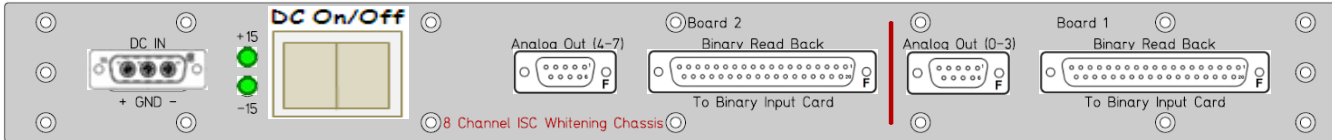
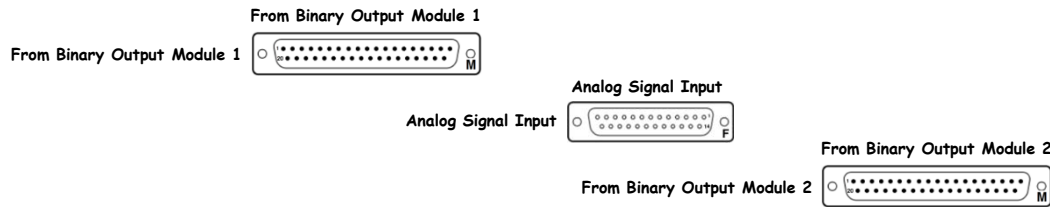

[S1101597](#)

Rear

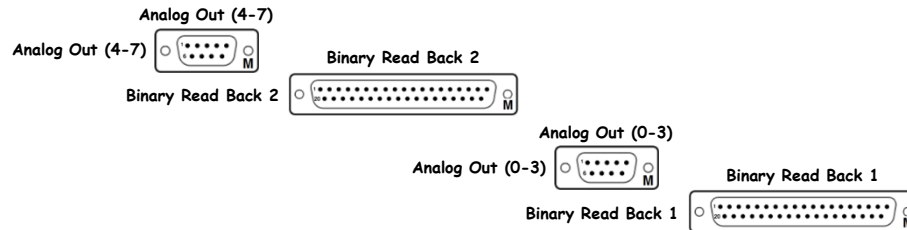

L1-ISC-R3

ISC HAM6 Rack Layout (D1001426)

D1200757
Sequencer

S1202561

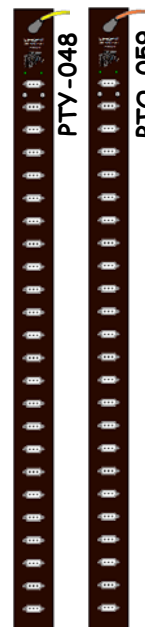

- RF Patch Panel 15
- RF Patch Panel 16
- 9.099/8.684 MHz Distribution Amplifier
- 36 MHz Distribution Amplifier
- 45 MHz Distribution Amplifier
- ISC Whitening (ASC ASAIR A 36MHz)
- WFS I/Q Demodulator (ASC ASAIR A 36MHz)
- WFS Demodulator Patch Panel
- WFS I/Q Demodulator (ASC ASAIR A 45MHz)
- ISC Whitening (ASC ASAIR A 45MHz)
- ISC Whitening (Spare AIR to VAC)
- WFS I/Q Demodulator (Spare AIR to VAC)
- WFS Demodulator Patch Panel
- ISC Whitening (ASC ASAIR B 36MHz)
- WFS I/Q Demodulator (ASC ASAIR B 36MHz)
- WFS Demodulator Patch Panel
- WFS I/Q Demodulator (ASC ASAIR B 45MHz)
- ISC Whitening (ASC ASAIR B 45MHz)
- ISC Whitening (LSC ASAIR A 45, B 18, B 90MHz)
- LSC I/Q Demodulator (LSC ASAIR A 45, B 18, B 90MHz)
- WFS Demodulator Patch Panel

Dxxxxxxx	42	Sxxxxxxx	No Power
Dxxxxxxx	41	Sxxxxxxx	No Power
Dxxxxxxx	40	Sxxxxxxx	No Power
D1000124	39	S1000659	±17VDC, ±24VDC
D1000124	38	S1000663	±17VDC, ±24VDC
D1000124	37	S1000666	±17VDC, ±24VDC
D1000124	36	S1101588	±15VDC
D1002559	35	S1001033	±15VDC
D0902796	34	Sxxxxxxx	No Power
D1100905	33	S1001027	±15VDC
D0902796	32	S1101575	±15VDC
D1002559	31	S1101589	±15VDC
D1002559	30	S1000983	±15VDC
D0902796	29	Sxxxxxxx	No Power
D1100905	28	S1000973	±15VDC
D0902796	27	S1101610	±15VDC
D1002559	26	Sxxxxxxx	±15VDC
D1002559	25	Sxxxxxxx	±15VDC
D1002559	24	Sxxxxxxx	No Power
D0902796	23	S1000988	±15VDC
D1100905	22	Sxxxxxxx	No Power
D1002559	21	S1000973	±15VDC
D0902796	20	S1101598	±15VDC
D1100905	19	Sxxxxxxx	±15VDC
D0902796	18	Sxxxxxxx	No Power
D1100905	17	Sxxxxxxx	No Power
D0902796	16	S1000973	±15VDC
D1100905	15	S1101610	±15VDC
D0902796	14	Sxxxxxxx	±15VDC
D1100905	13	Sxxxxxxx	±15VDC
D0902796	12	Sxxxxxxx	No Power
D1100905	11	Sxxxxxxx	No Power
D0902796	10	Sxxxxxxx	±15VDC
D1100905	9	Sxxxxxxx	±15VDC
D0902796	8	S1001001	±15VDC
D1100905	7	Sxxxxxxx	No Power
	6		
	5		
	4		
	3		
	2		
	1		

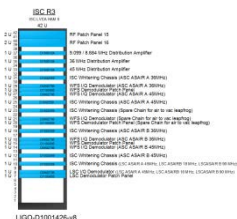

LIGO-D1001426.a8

L1-ISC-R3 Details

RF Patch Panel 15

Dxxxxxxx

Sxxxxxxx

No Power

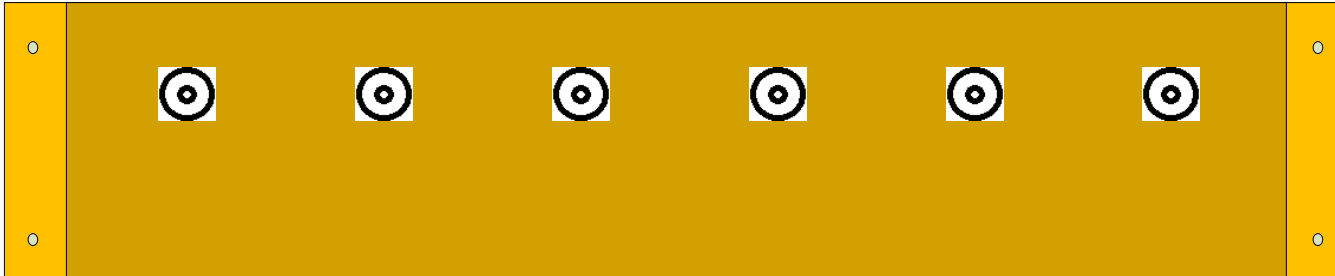

Dxxxxxxx

Front

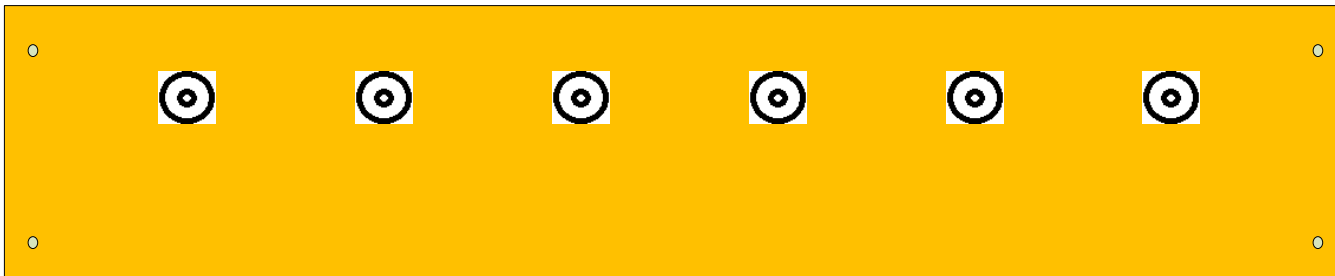

Sxxxxxxx

Rear

RF Patch Panel 16

Dxxxxxxx

Sxxxxxxx

No Power

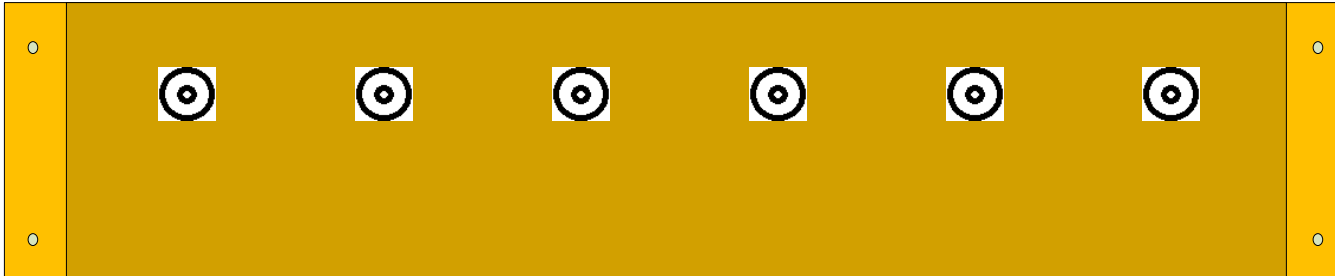

Dxxxxxxx

Front

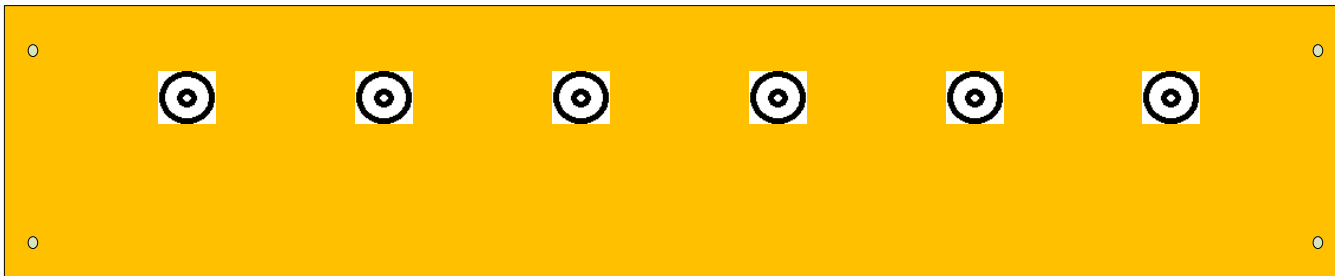

Sxxxxxxx

Rear

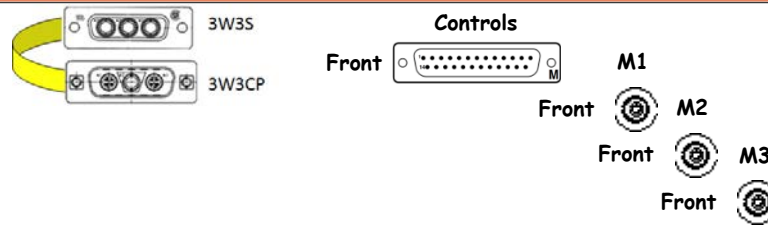
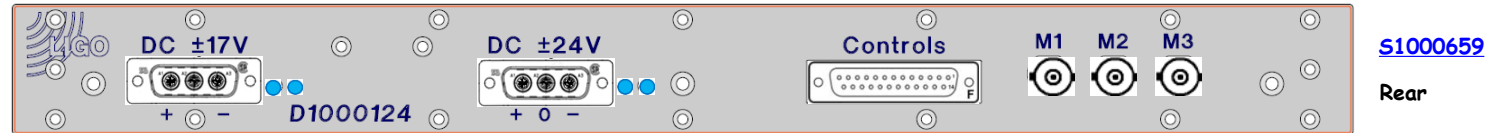
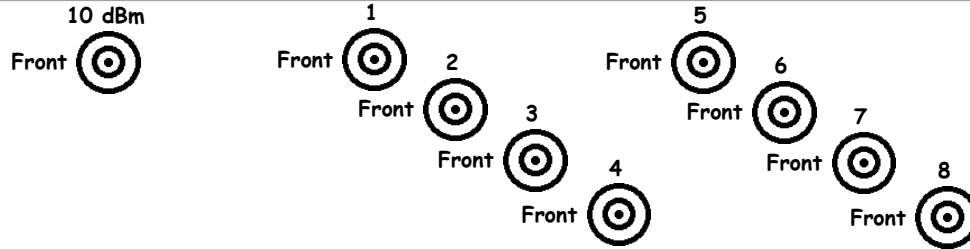
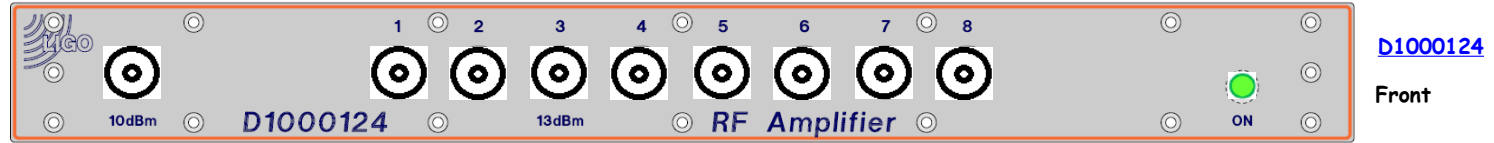

36 MHz Distribution Amplifier D1000124 S1000663 ±17VDC, ±24VDC

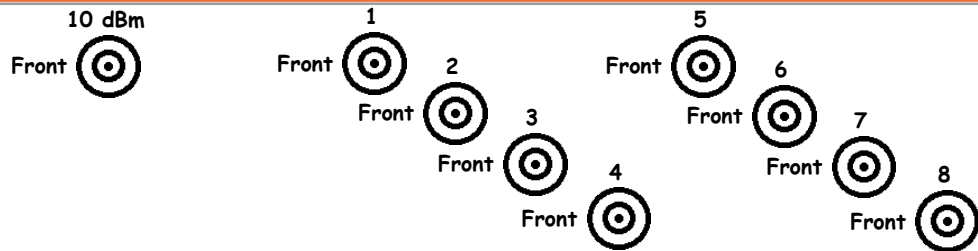
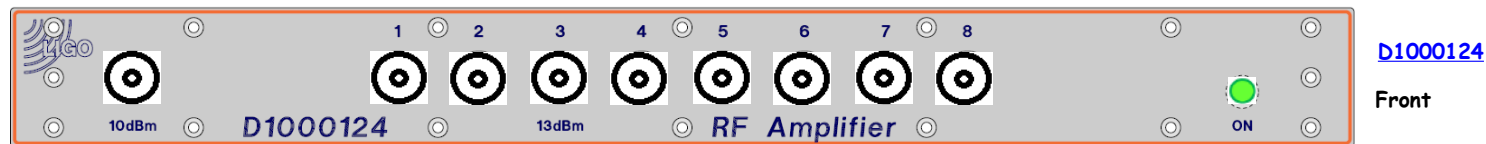

45 MHz Distribution Amplifier D1000124 S1000666 ±17VDC, ±24VDC

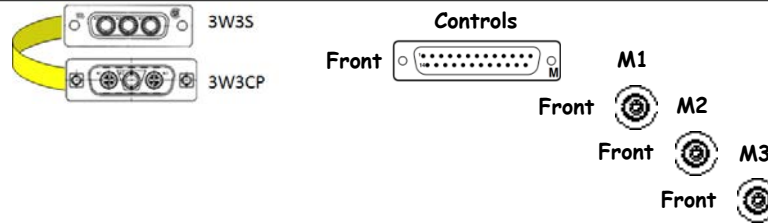
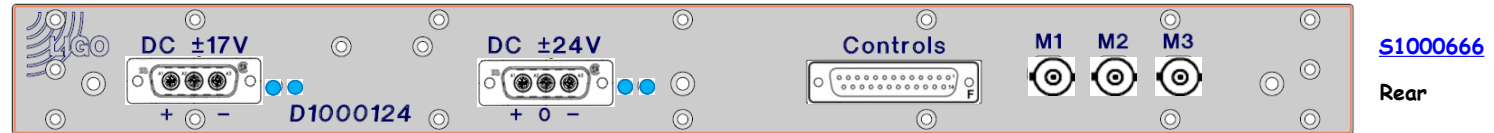
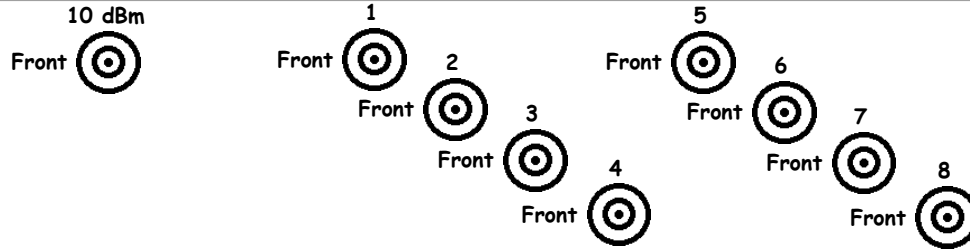
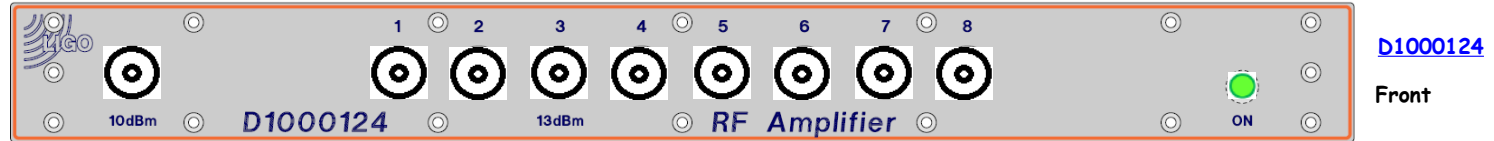

D1000124
Front

S1000666
Rear

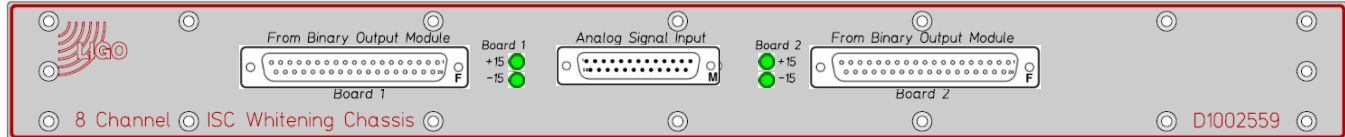

[D1002559](#)

Front

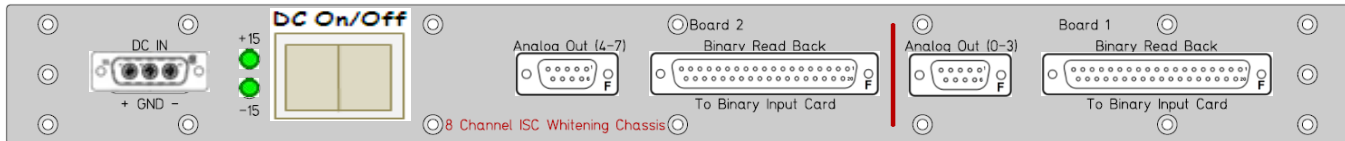
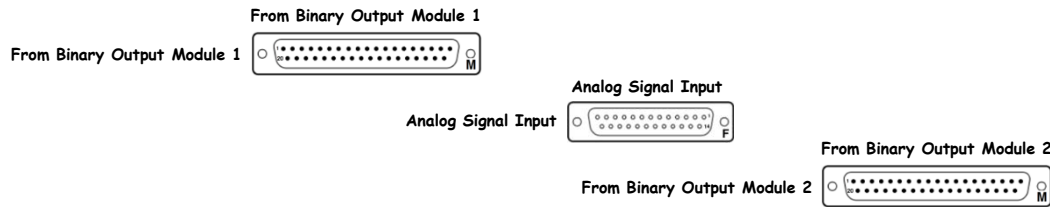

[S1101588](#)

Rear

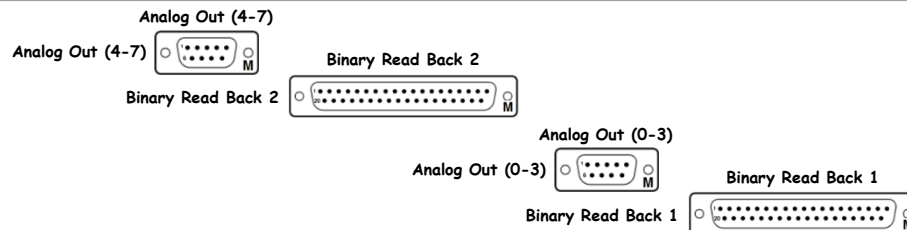

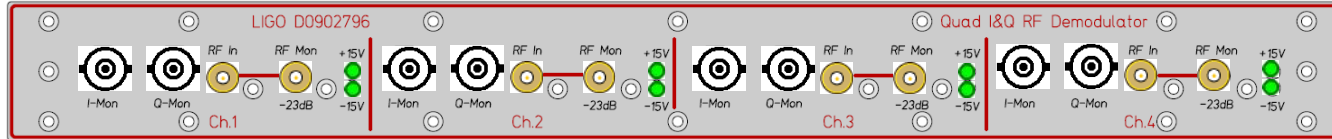

[D0902796](#)

Front

[D1002032](#)

LSC

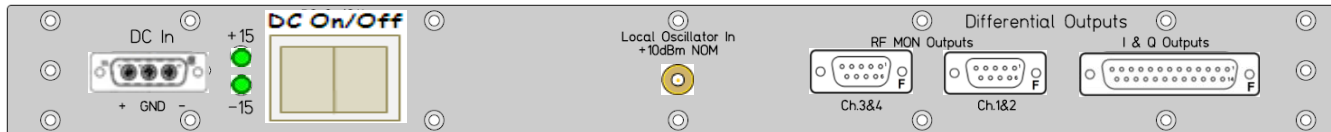

[S1001033](#)

Rear

RF Mon Out Ch 3&4

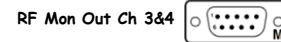

RF Mon Out Ch 3&4

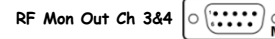

I & Q Outputs



<< L1-ISC-R3

WFS Demodulator Patch Panel No Power

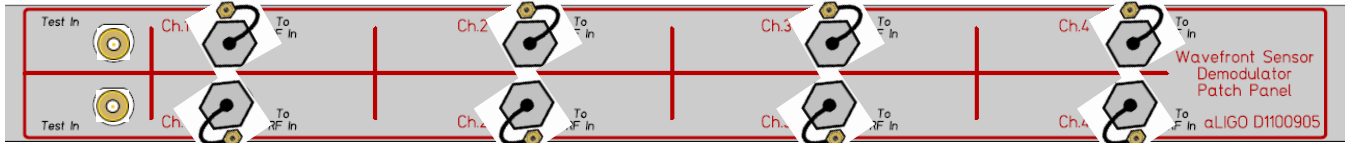

[D1100905](#)

Front



Sxxxxxxx

Rear

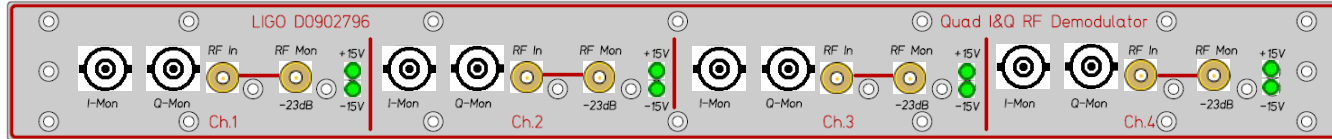

[D0902796](#)

Front

[D1002032](#)

LSC

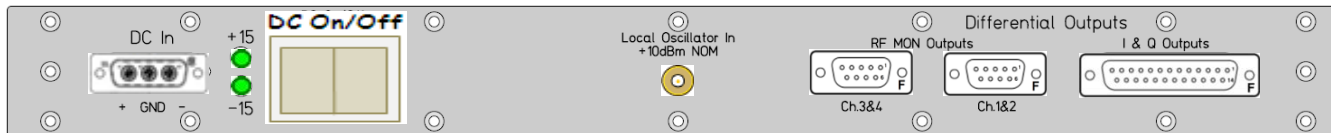

[S1001027](#)

Rear

RF Mon Out Ch 3&4

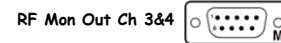

RF Mon Out Ch 3&4

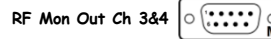

I & Q Outputs



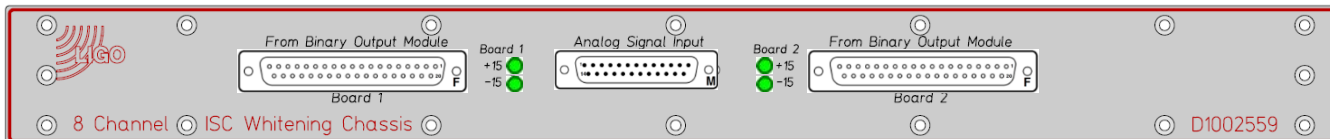

[D1002559](#)

Front

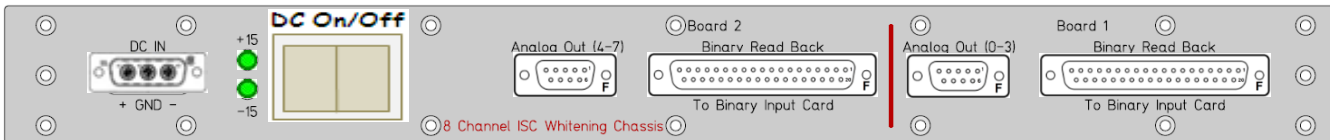
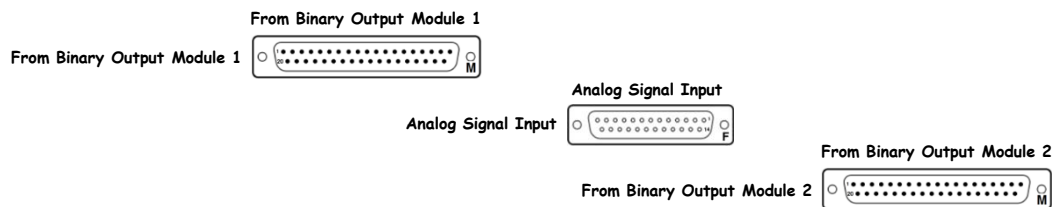

[S1101575](#)

Rear

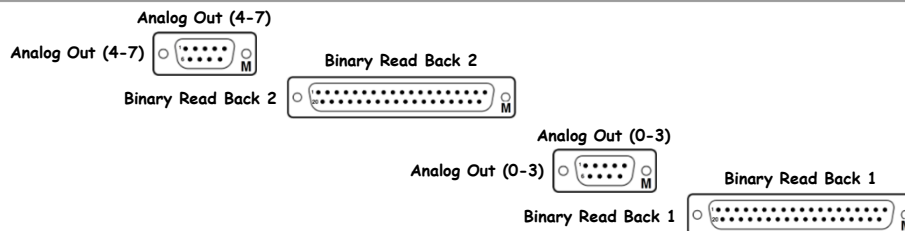

ISC Whitening (Spare AIR to VAC) D1002559 S1101589 ±15VDC

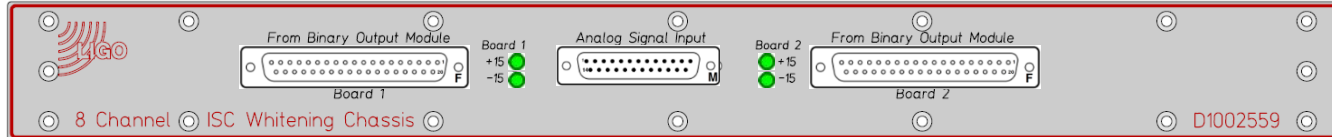

[D1002559](#)

Front

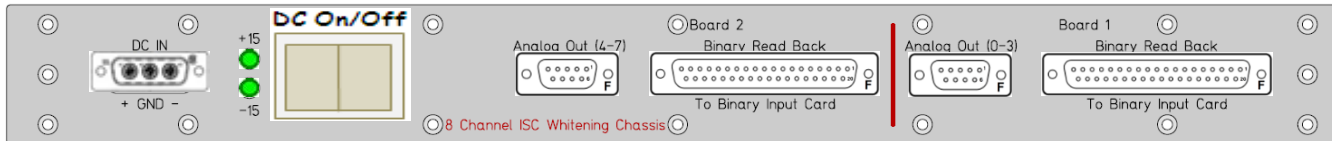
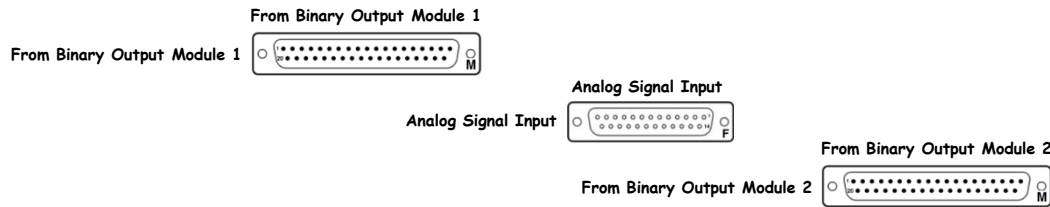

[S1101589](#)

Rear

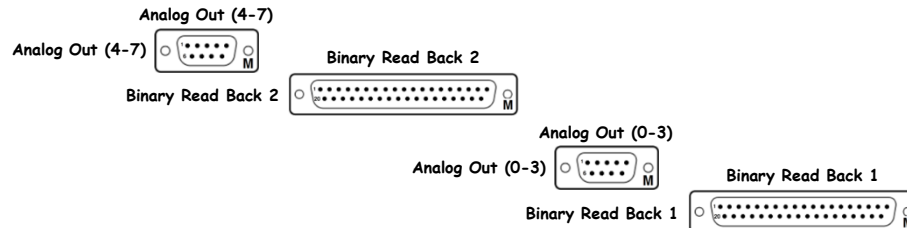

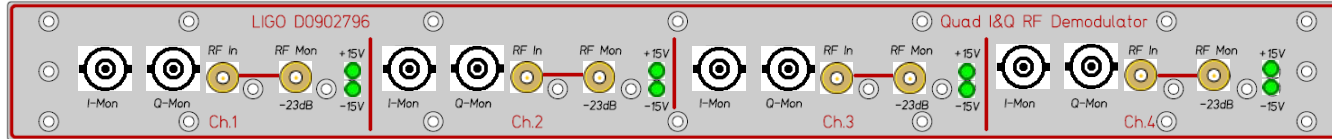

[D0902796](#)

Front

[D1002032](#)

LSC

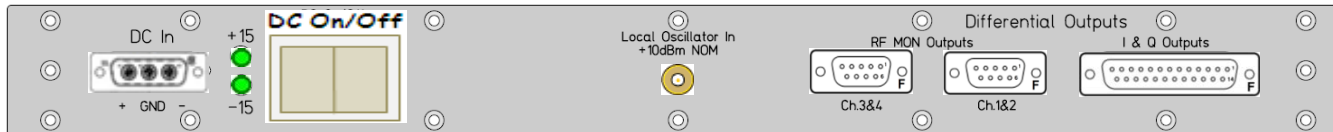

[S1000983](#)

Rear

RF Mon Out Ch 3&4

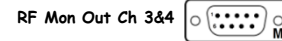

RF Mon Out Ch 3&4

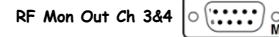

I & Q Outputs



<< L1-ISC-R3

WFS Demodulator Patch Panel No Power

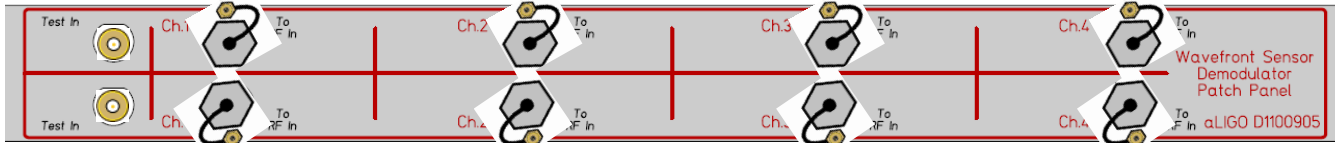

[D1100905](#)

Front



Sxxxxxxx

Rear

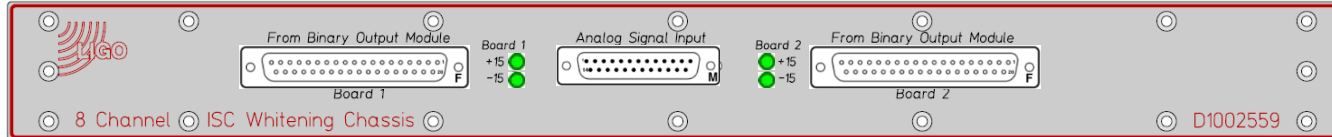

[D1002559](#)

Front

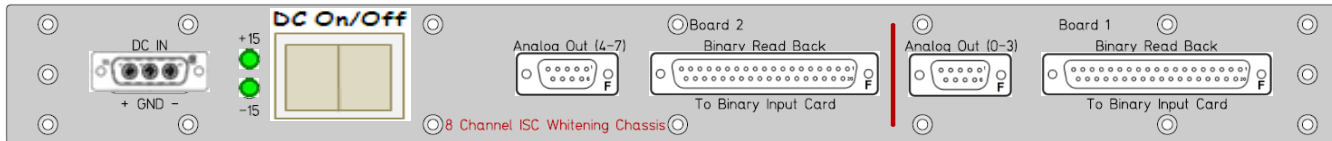
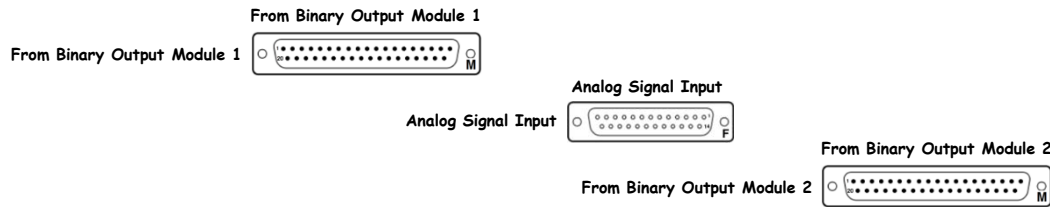

[S1101598](#)

Rear

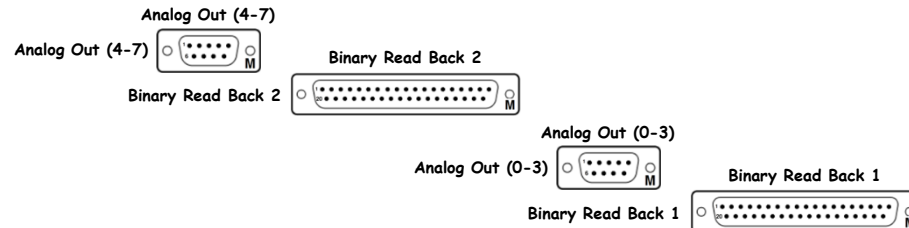

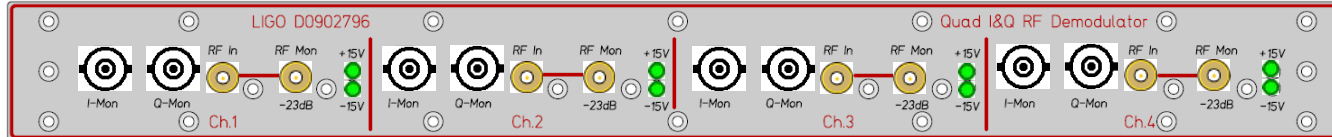

[D0902796](#)

Front

[D1002032](#)

LSC

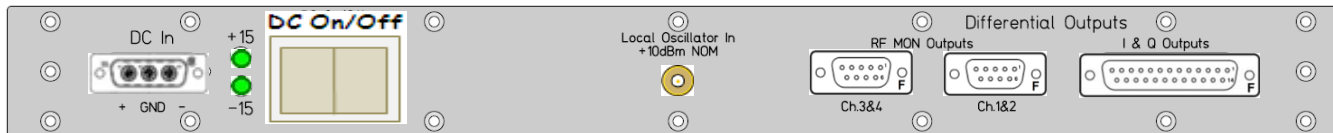

[S1000988](#)

Rear

RF Mon Out Ch 3&4

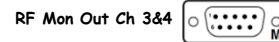

RF Mon Out Ch 3&4

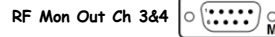

I & Q Outputs



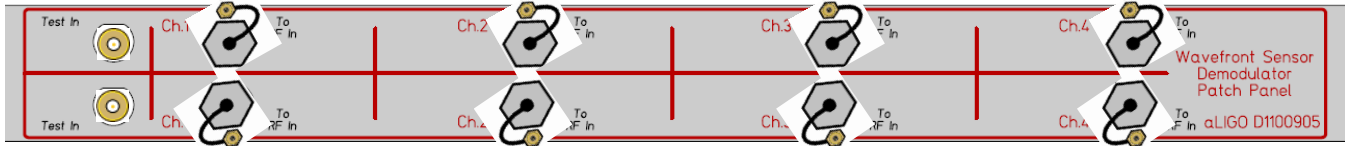

[D1100905](#)

Front



Sxxxxxxx

Rear

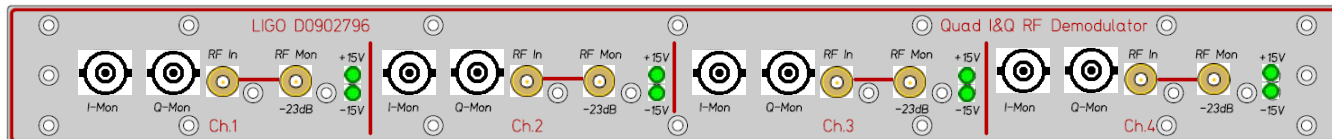

[D0902796](#)

Front

[D1002032](#)

LSC

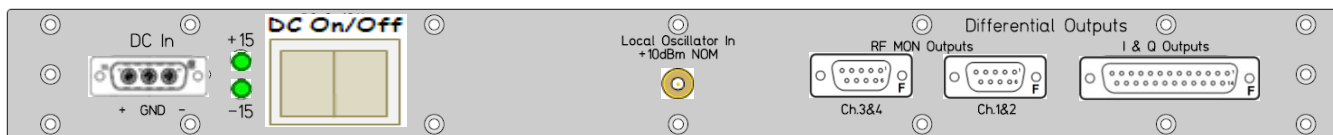

[S1000973](#)

Rear

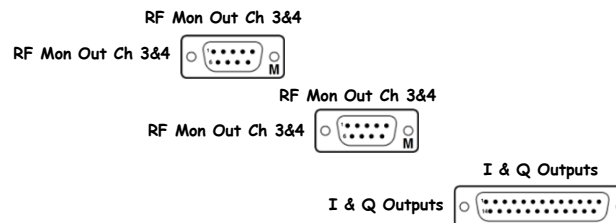

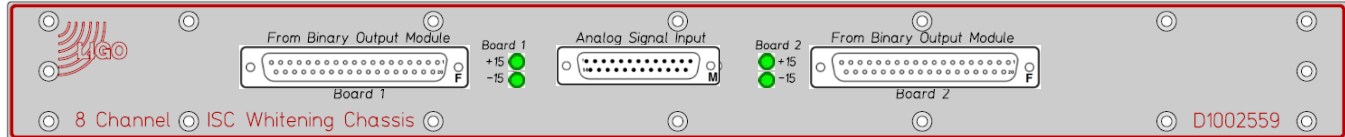

D1002559

Front

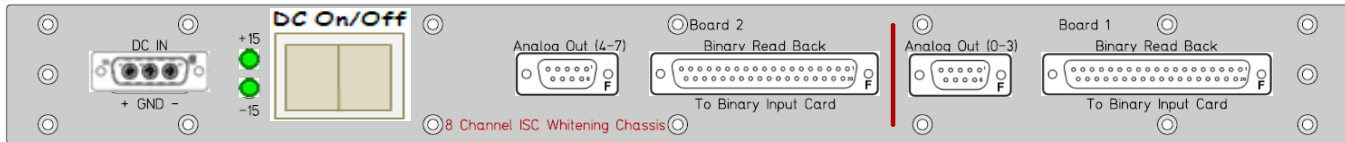
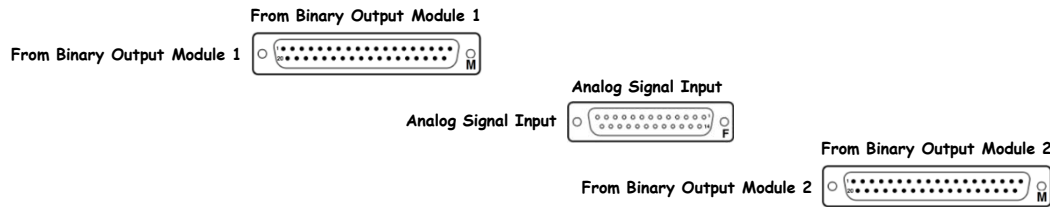

S1101610

Rear

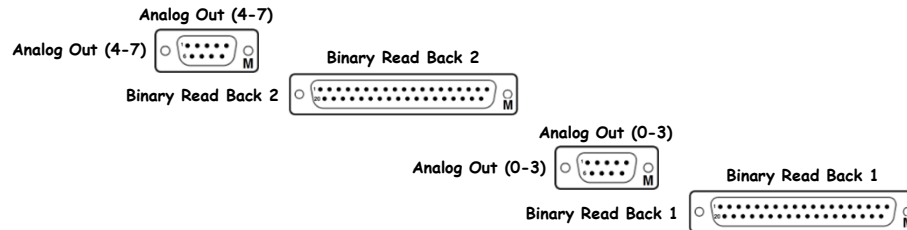

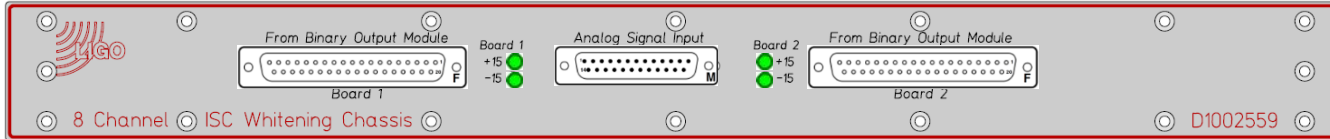

D1002559

Front

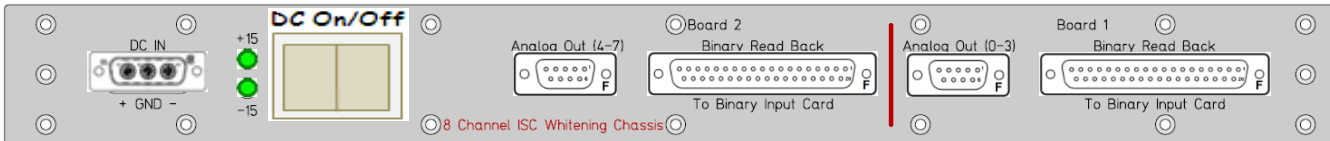
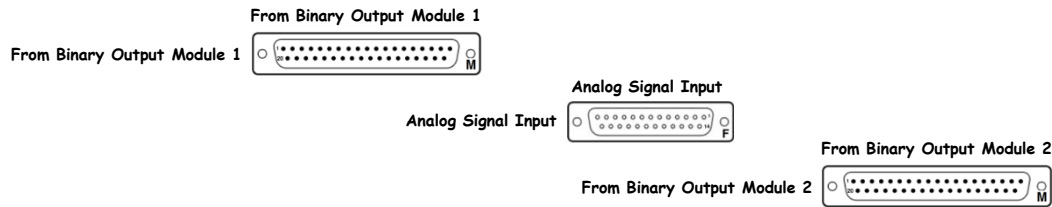

Sxxxxxxx

Rear

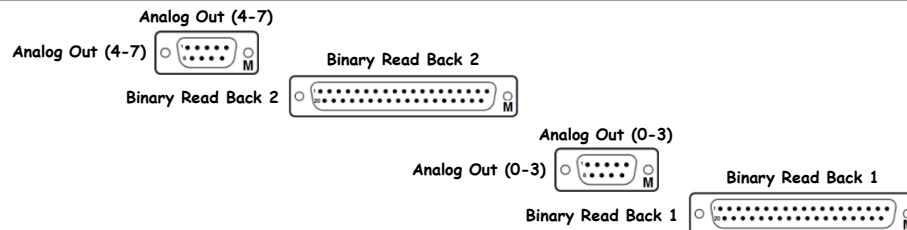

D0902796 - S1001001

LIGO

<< [L1-ISC-R3](#)

LSC I/Q Demodulator (LSC ASAIR A 45, B 18, B 90MHz) D0902796 S1001001 ±15VDC

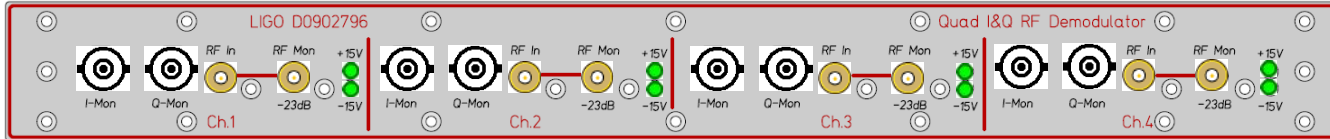

[D0902796](#)

Front

[D1002032](#)

LSC

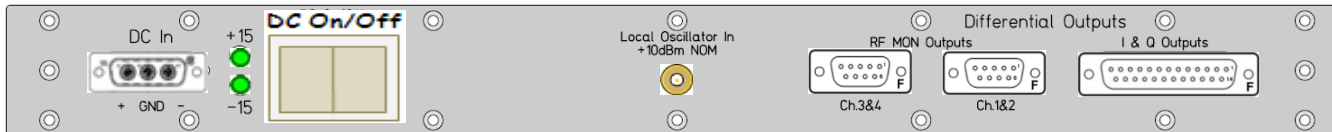

[S1001001](#)

Rear

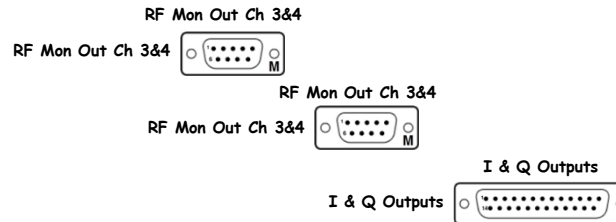

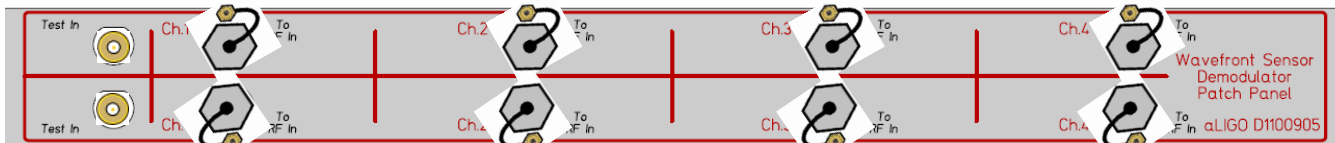

[D1100905](#)

Front



Sxxxxxxx

Rear



[LSC Demod Concentrator 2](#)
[LSC Demod Concentrator 3](#)
[ASC Demod Concentrator 2](#)
[ASC Demod Concentrator 3](#)
[LSC RFPD Interface](#)
[WFS RFPD Interface](#)

ALS Fiber Distribution

[ISC Whitening Chassis \(IM4 TRANS/ISS QPD\)](#)
 Dual QPD Transimpedance Amp (IM4 TRANS/ISS QPD)

[ISC Whitening Chassis \(MC2 TRANS/-\)](#)
 Dual QPD Transimpedance Amp (MC2 TRANS/-)

[ISC Whitening Chassis \(POP_A/POP_B\)](#)
 Dual QPD Transimpedance Amp (POP_A/POP_B)

SUS Satellite Amp (HAM1 Tip/Tilt)

[Auxiliary Signals Concentrator 1](#)

[Auxiliary Signals Concentrator 3](#)

[Common Mode Servo](#)

ISC Whitening Filter Controller

D1100691	42	S1104007	±18VDC
D1100691	41	S1104006	±18VDC
D1100696	40	S1103987	No Power
D1100696	39	S1103985	No Power
D1102079	38	S1200323	±18VDC
D1101906	37	S1200428	±15VDC
D1200136	36		
D1200136	35	S1202531	±17VDC, ±24VDC
D1002559	34		
D1002481	33		
D1002559	32	S1101599	±15VDC
D1002481	31	S1102824	??
D1002559	30		
D1002481	29	S1101611	±15VDC
D1002481	28	S1102812	??
D1002559	27		
D1002481	26	S1101586	±15VDC
D1002481	25	S1102814	??
D1002818	24		
D1002818	23	S1200172	??
D1002818	22		
D1102065	21		
D1102065	20	S1200550	±17VDC
D1102065	19		
D1102065	18		
D1102065	17	S1200549	±17VDC
D0901781	16		
D0901781	15	S1102623	±17VDC, ±24VDC
D1101741	14		
D1101741	13		
D1101741	12		
D1101741	11		
D1101741	10		
D1101741	9		
D1101741	8		
D1101741	7		
D1101741	6		
D1101741	5		
D1101741	4		
D1101741	3		
D1101741	2		
D1101741	1	S1201333	??

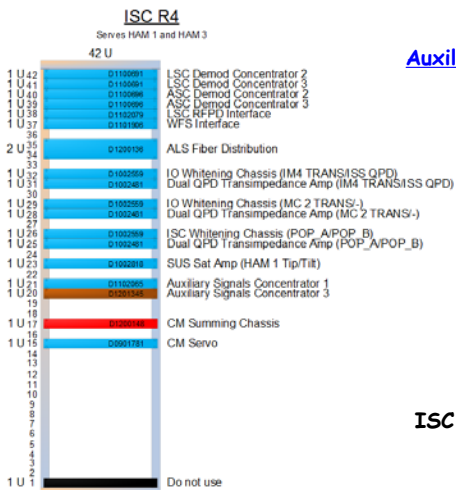

LIGO-D1101904-v7

L1-ISC-R4 Details

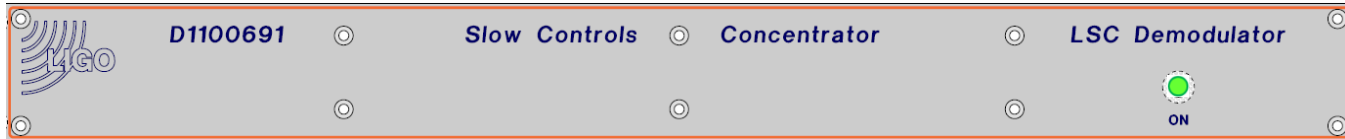

[D1100691](#)

Front

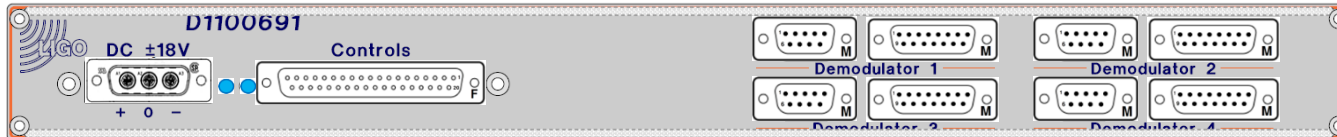

[S1104007](#)

Rear

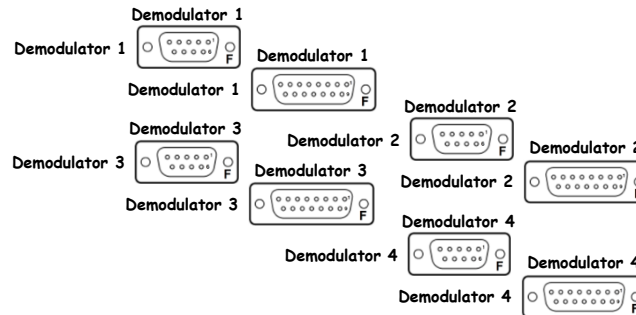
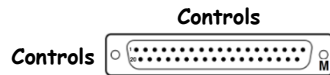

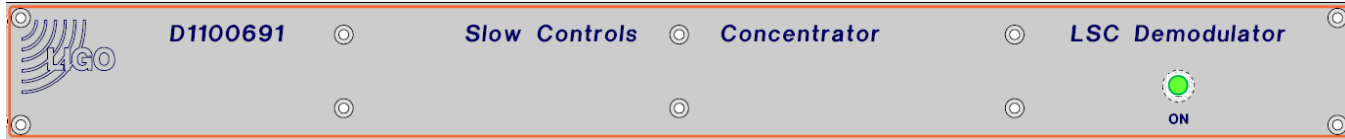

[D1100691](#)

Front

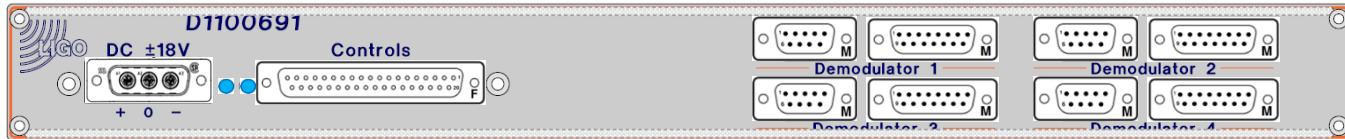

[S1104006](#)

Rear

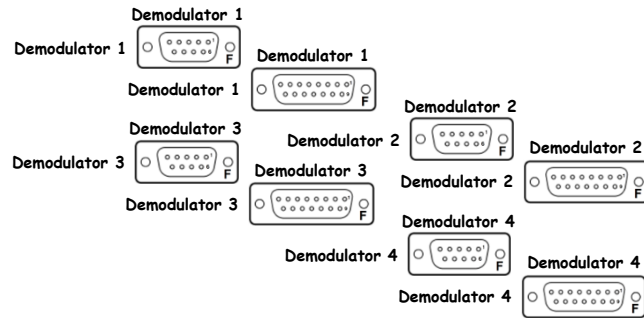
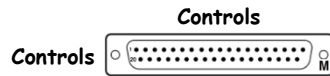

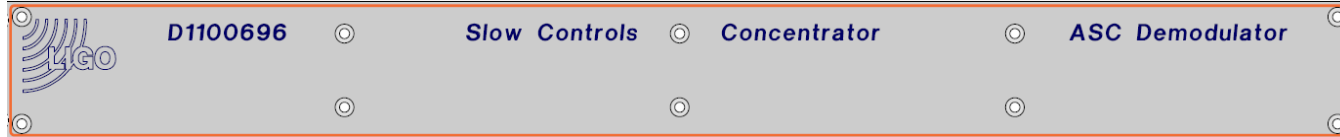

[D1100696](#)

Front

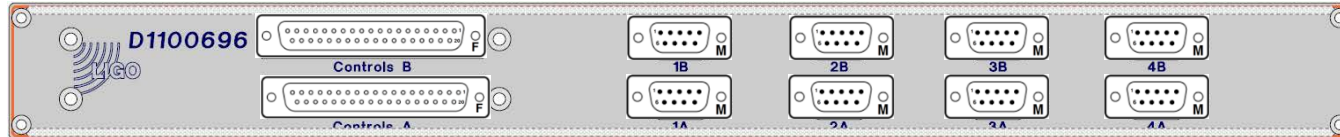

[S1103987](#)

Rear

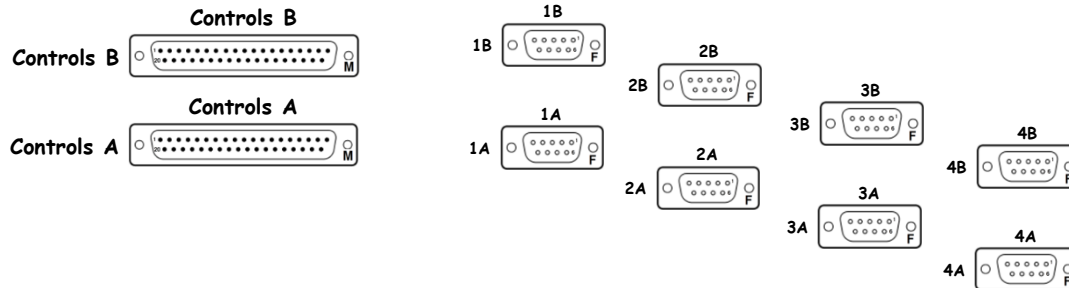

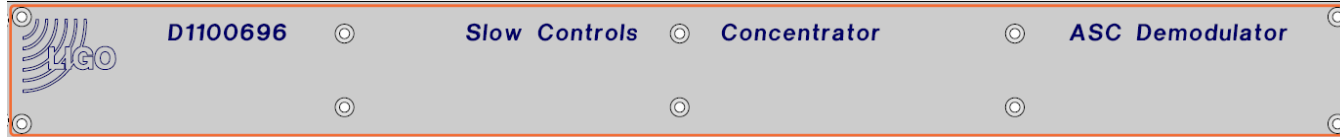

[D1100696](#)

Front

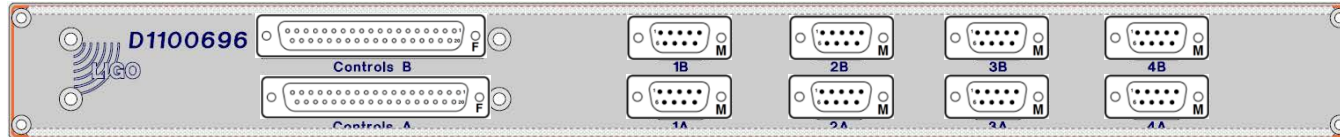

[S1103985](#)

Rear

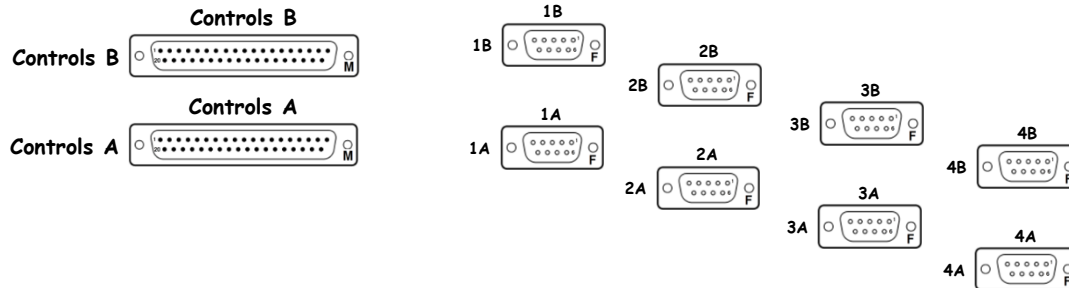

D1102079 - S1200323



<< L1-ISC-R4

LSC RFPD Interface ±18VDC

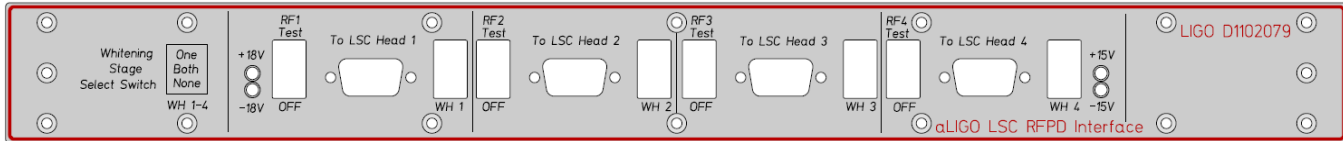

[D1102079](#)

Front

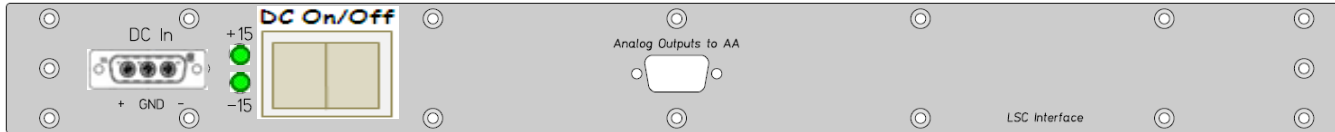

[S1200323](#)

Rear

D1101905



D1101906

Front

D1101908

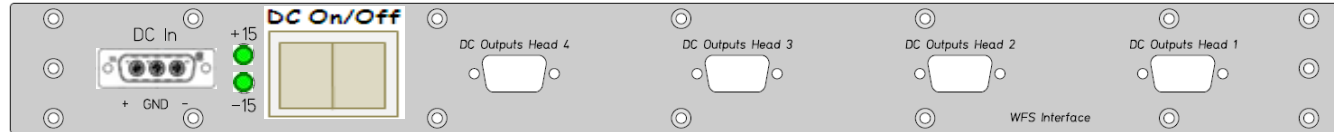

S1200428

Rear

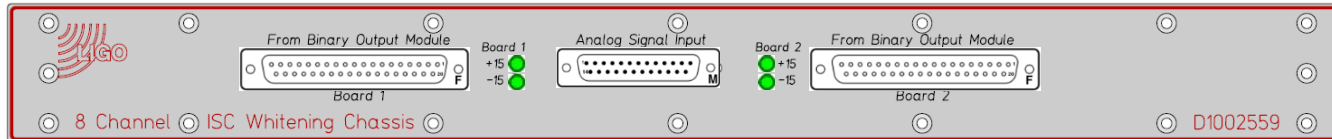

D1002559

Front

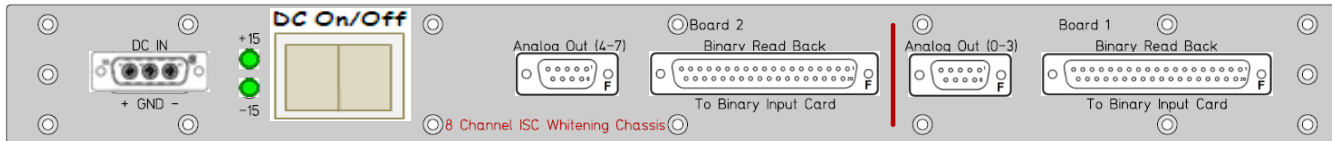
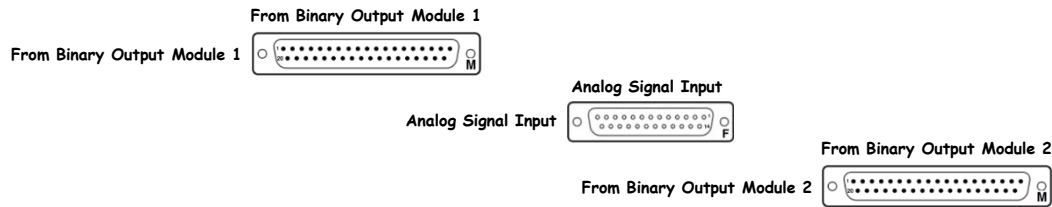

S1101599

Rear

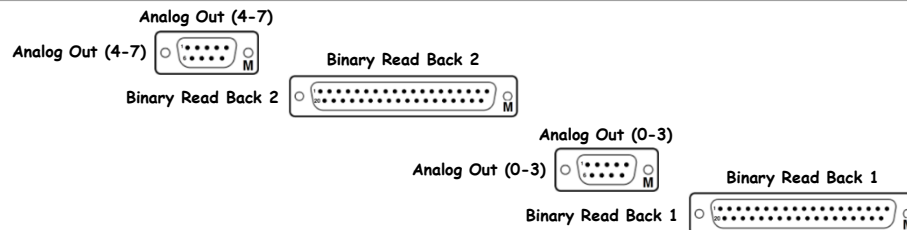

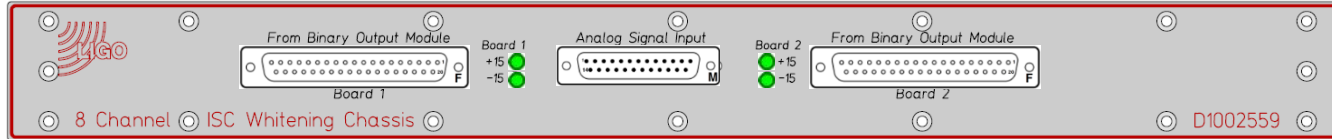

D1002559

Front

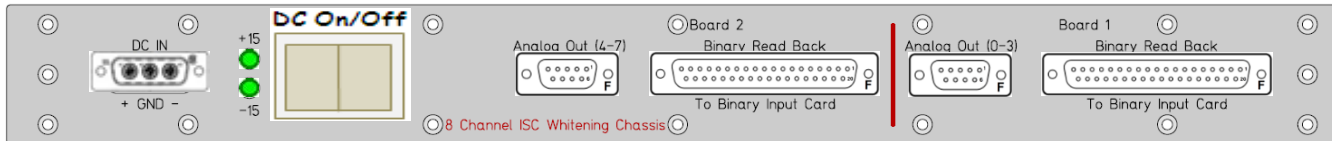
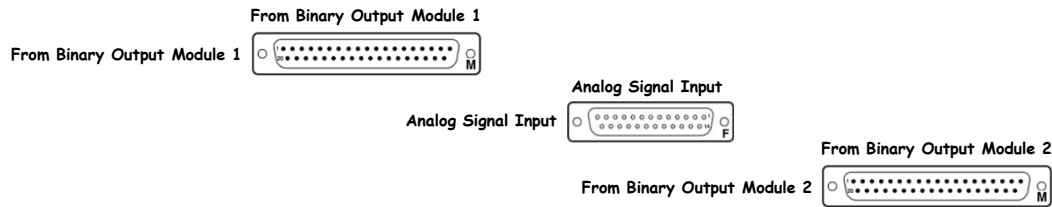

S1101611

Rear

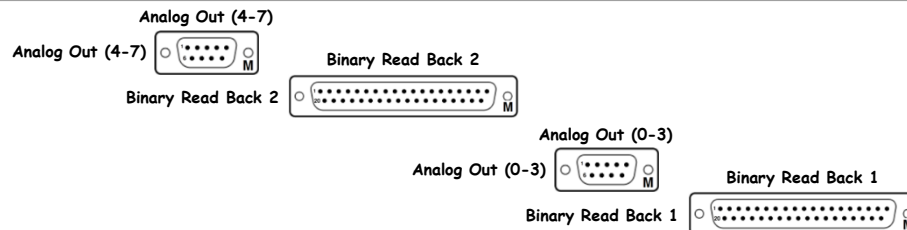

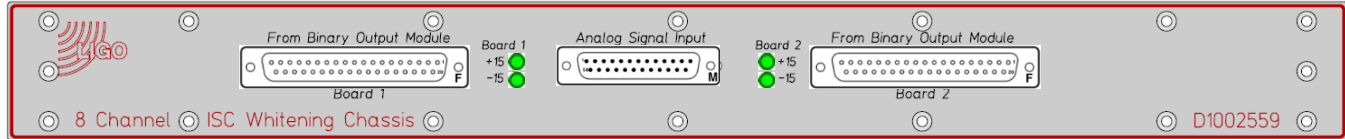

D1002559

Front

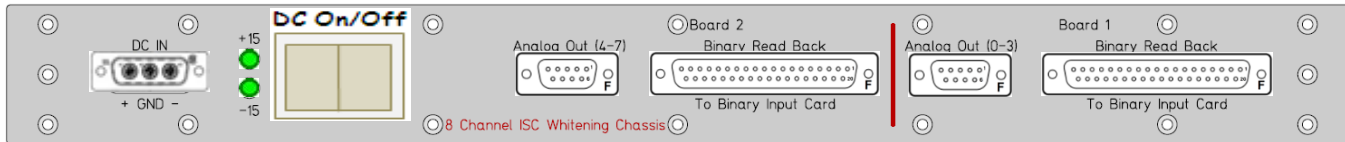
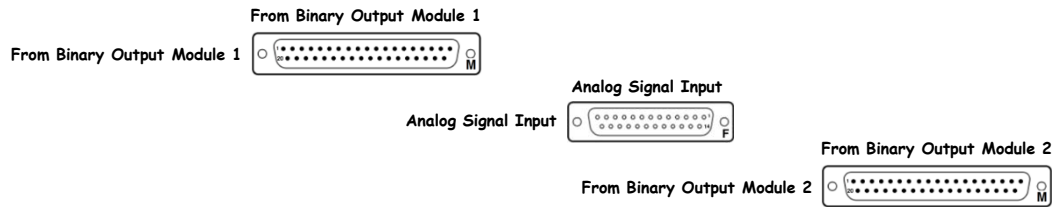

S1101586

Rear

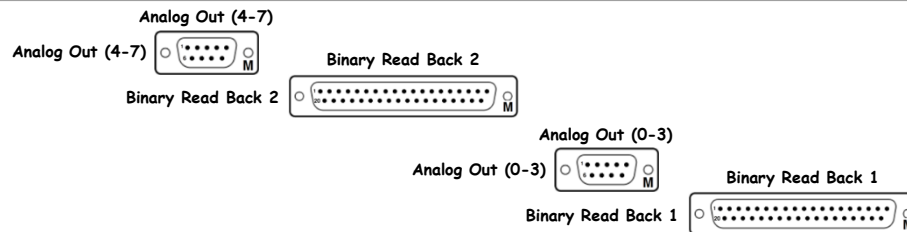

D1102065 - S1200550



<< L1-ISC-R4

Auxiliary Signals Concentrator 1 D1102065 S1200550 ±17VDC

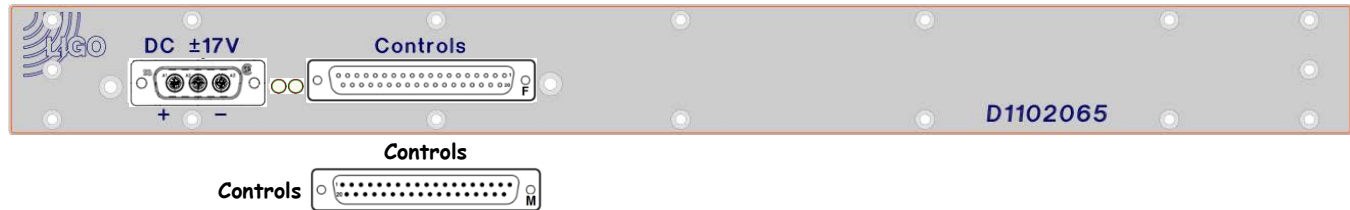

D1102065 - S1200549



<< L1-ISC-R4

Auxiliary Signals Concentrator 3 D1102065 S1200549 ±17VDC

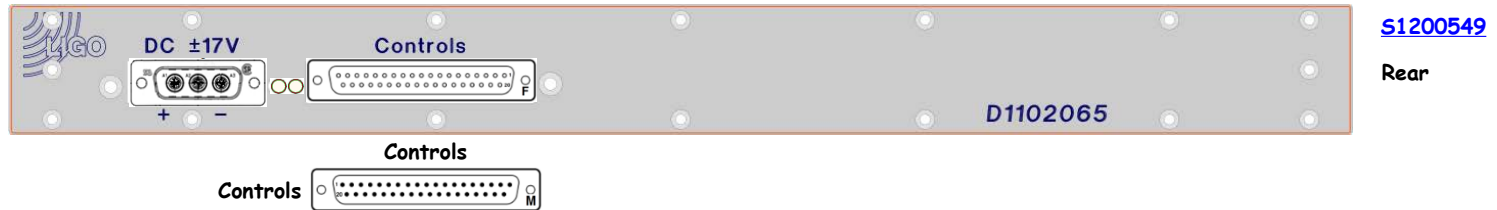
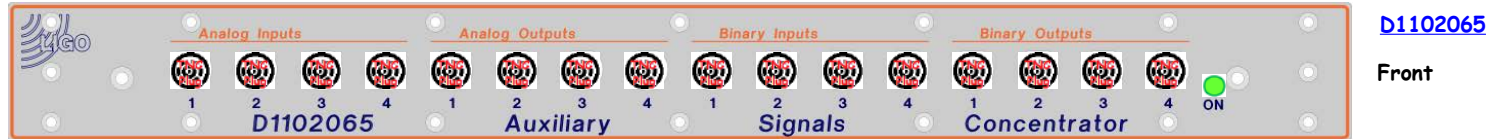

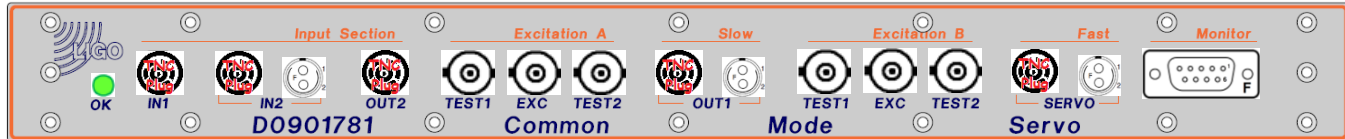

D0901781

Front

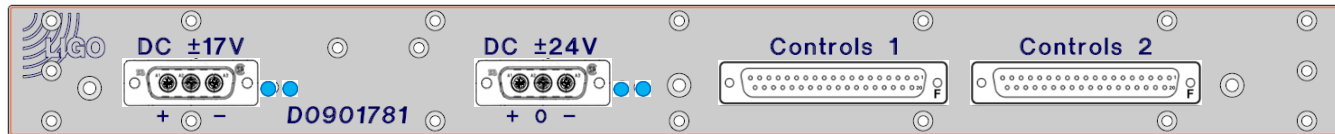

S1102623

Rear

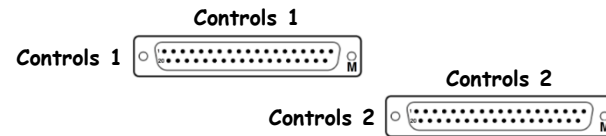
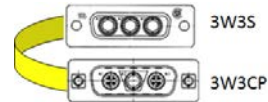

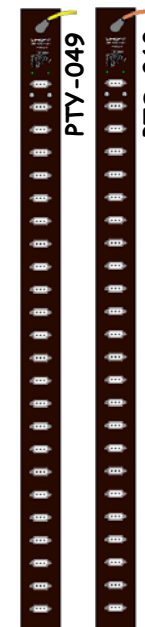

[LSC Demod Concentrator 4](#)
[ASC Demod Concentrator 4](#)
[ASC Demod Concentrator 5](#)

[LSC RFPD Interface](#)

[WFS RFPD Interface](#)

[SUS Satellite Amp \(HAM1 Tip/Tilt\)](#)

[SUS Satellite Amp \(HAM1 Tip/Tilt\)](#)

[Dual QPD Transimpedance Amp \(ASC OMC R A&B\)](#)

[ISC Whitening Chassis \(ASC OMC R A&B\)](#)

[Dual QPD Transimpedance Amp \(ASC AS C\)](#)

[ISC Whitening Chassis \(ASC AS C\)](#)

	42			
	41			
	40			
	39			
	38			
	37			
	36	D1100691	S1104008	±18VDC
	35	D1100696	S1103983	No Power
	34	D1100696	S1103986	No Power
	33			
	32	D1102079	S1200463	±18VDC
	31			
	30	D1101906	S1200443	±15VDC
	29			
	28	D1002818	S1105381	??
	27			
	26	D1002818	S1200168	??
	25			
	24	D1002481	S1102830	??
	23			
	22	D1002559	S1101608	±15VDC
	21			
	20	D1002481	S1102834	??
	19			
	18	D1002559	S1101164	±15VDC
	17			
	16			
	15			
	14			
	13			
	12			
	11			
	10			
	9			
	8			
	7			
	6			
	5			
	4			
	3			
	2			
	1			
		Front	Rear	

Perforated Shelf

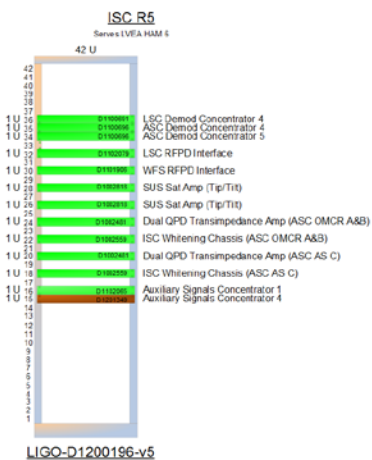

L1-ISC-R5 Details

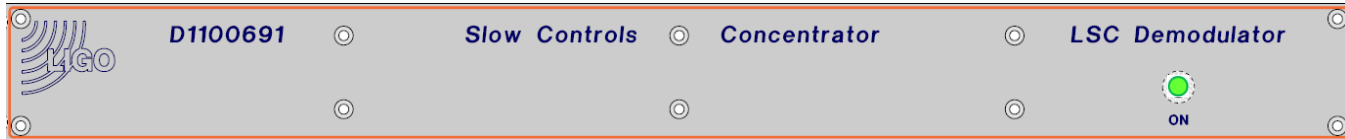

[D1100691](#)

Front

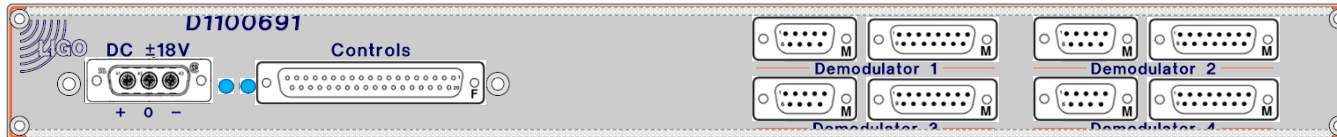

[S1104008](#)

Rear

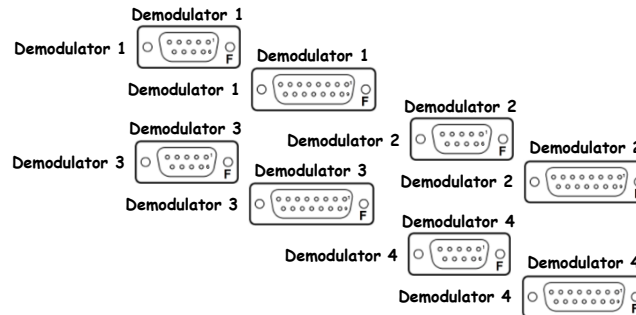
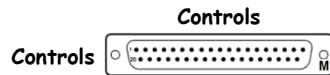

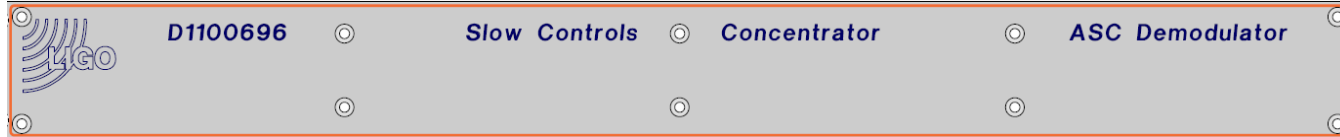

D1100696

Front

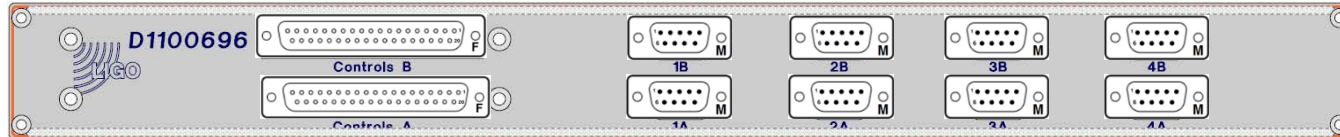

S1103983

Rear

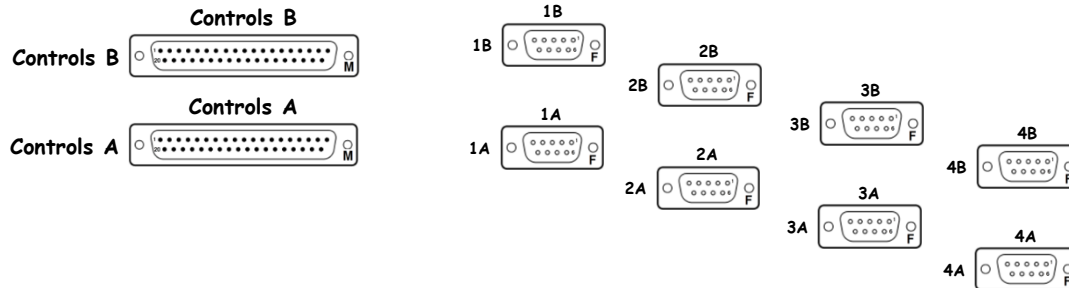

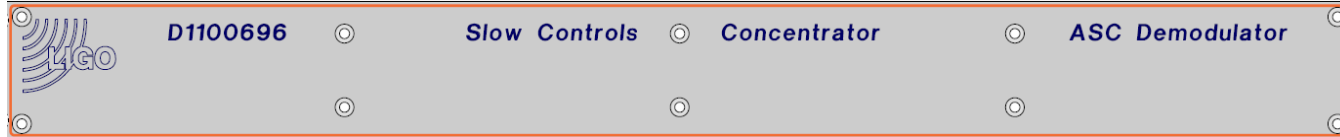

D1100696

Front

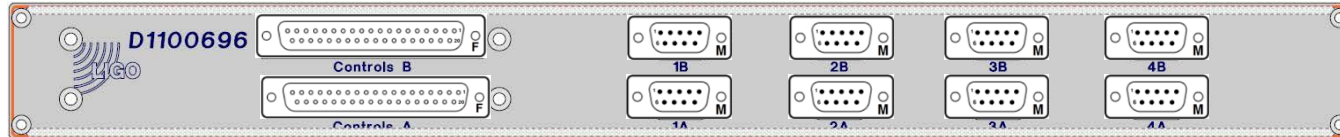

S1103986

Rear

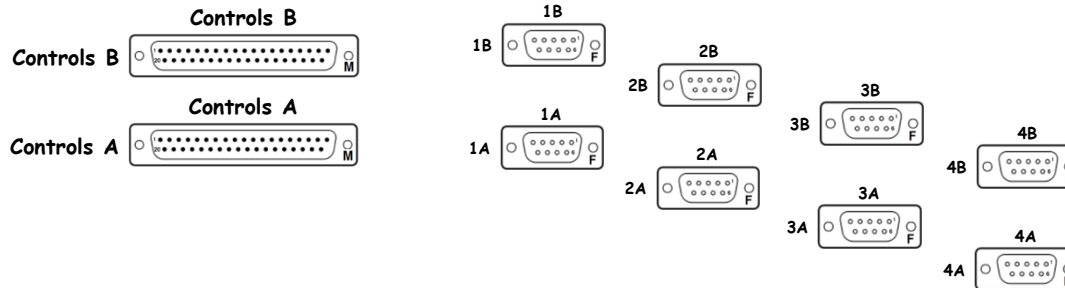

D1102079 - S1200463



<< L1-ISC-R5

LSC RFPD Interface D1102079 S1200463 ±18VDC

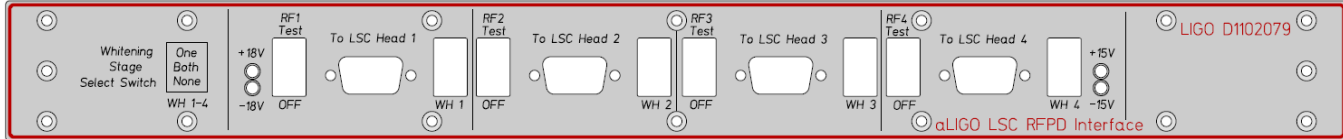

D1102079

Front

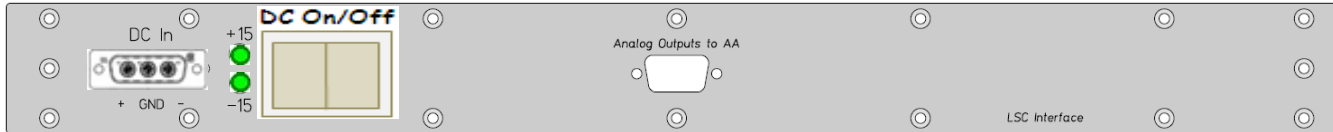

S1200463

Rear

D1101905



D1101906

Front

D1101908

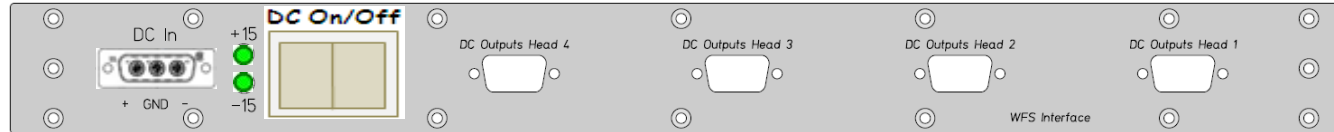

S1200443

Rear

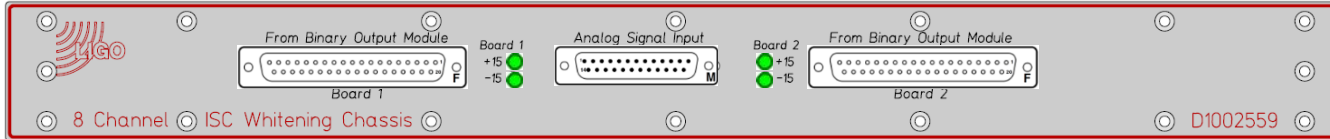

D1002559

Front

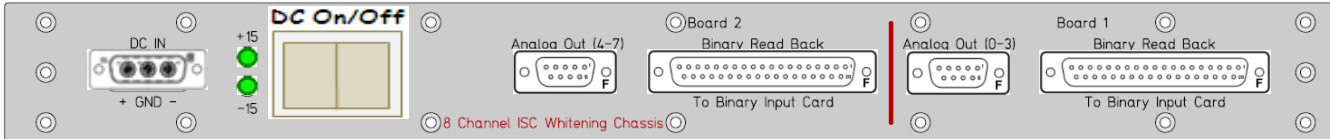
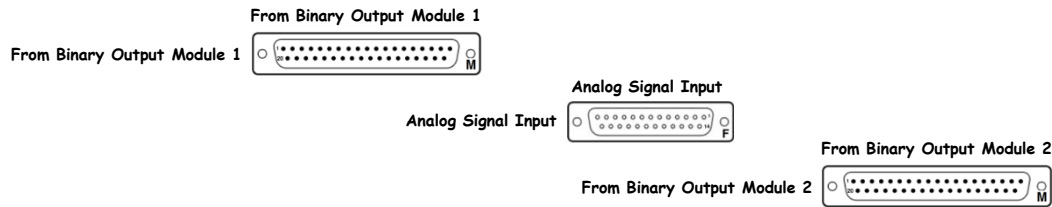

S1101608

Rear

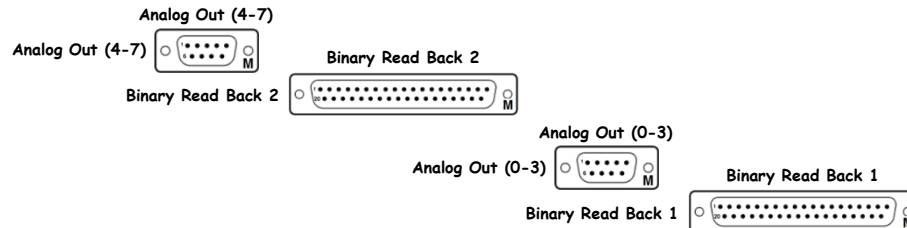

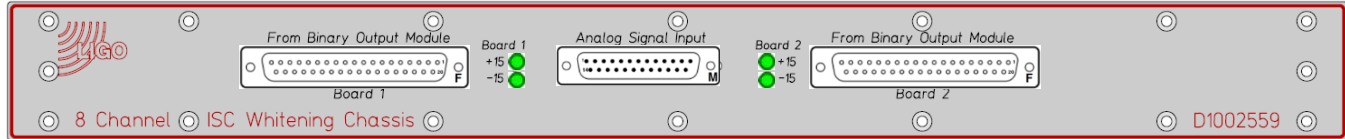

D1002559

Front

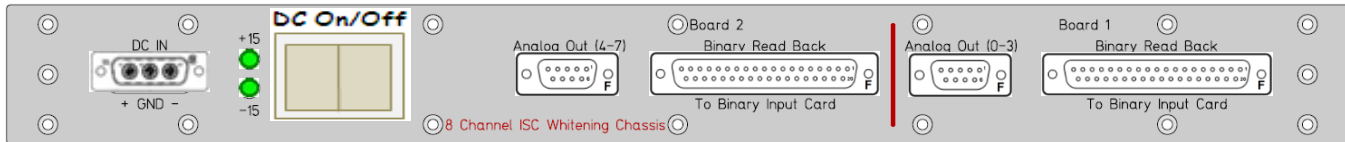
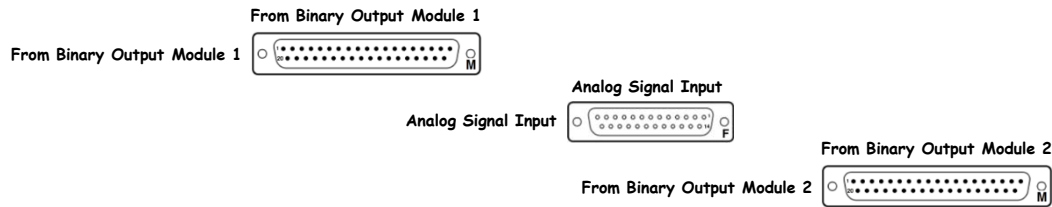

S1101164

Rear

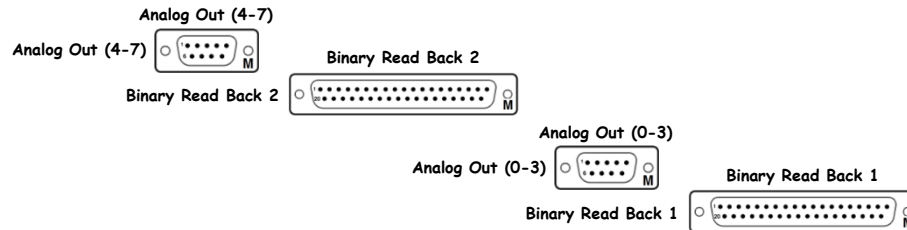

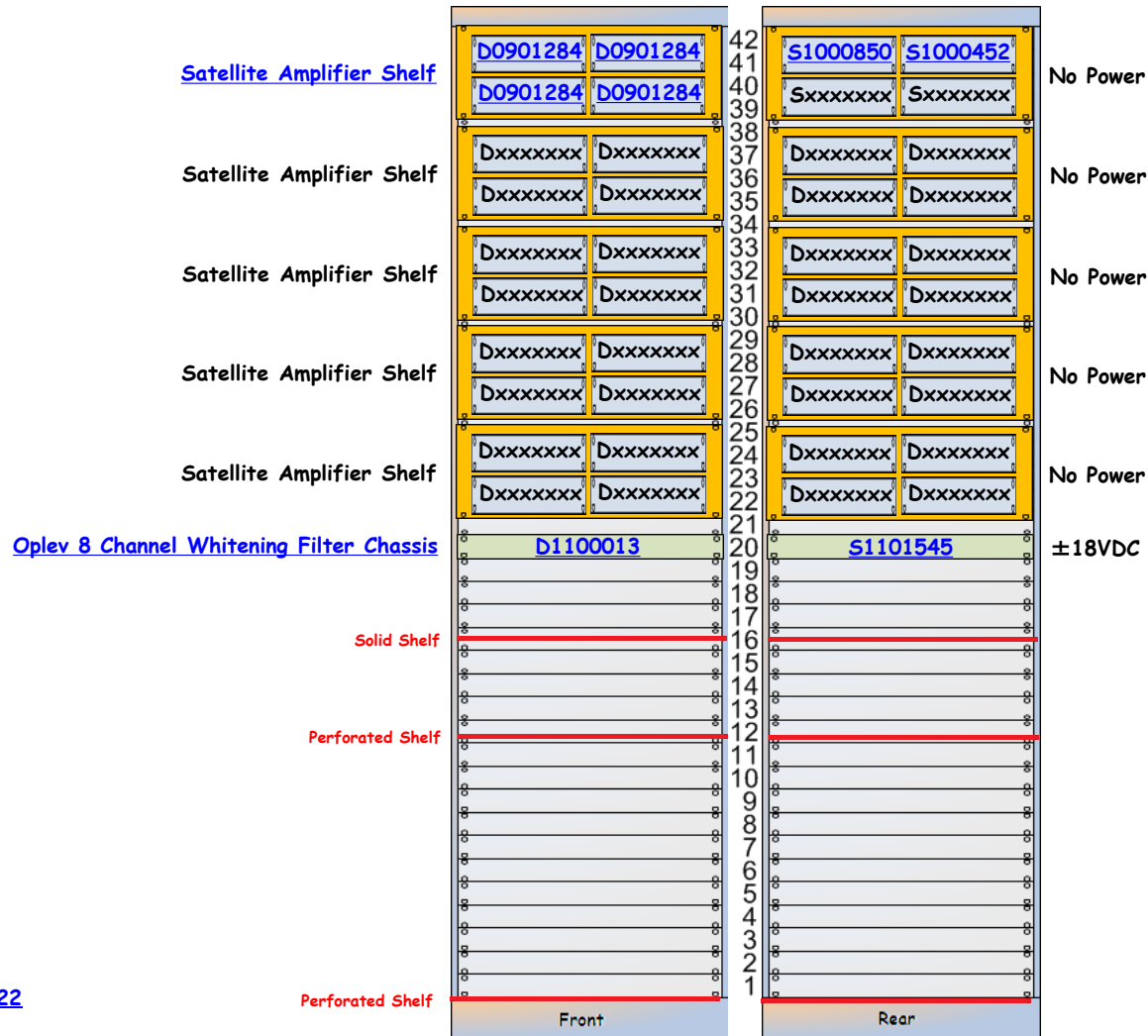

PTO-023

<< L1-SUS-R1

Satellite Amplifier Shelf

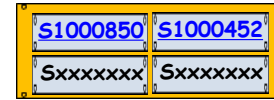
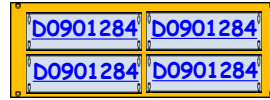

No Power

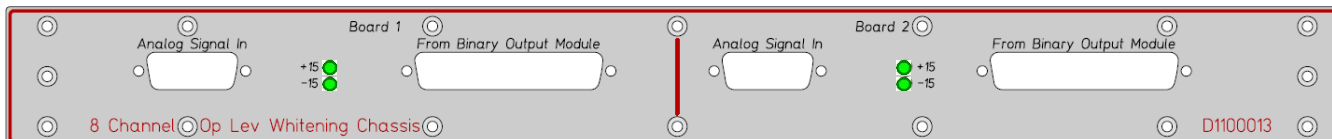

[D1100013](#)

Front

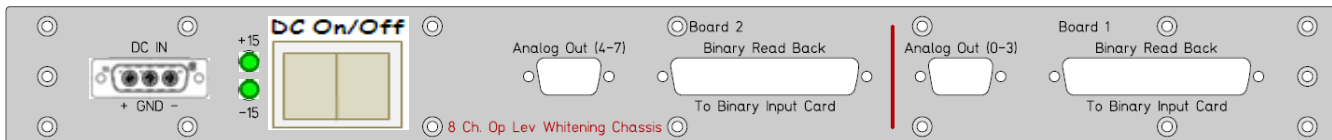
[S1101545](#)

Rear

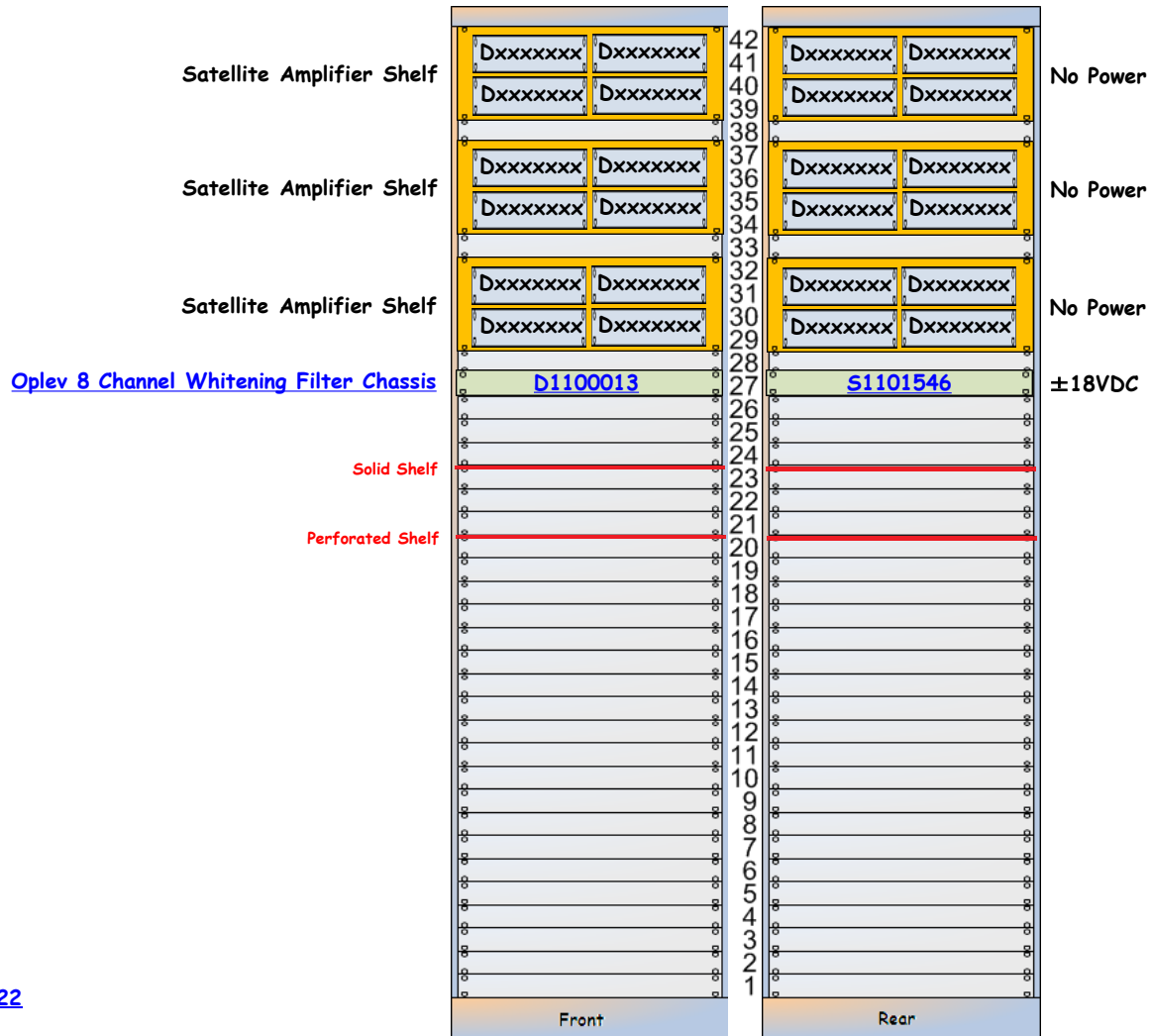

SUS-R2 is part of [D1100022](#)

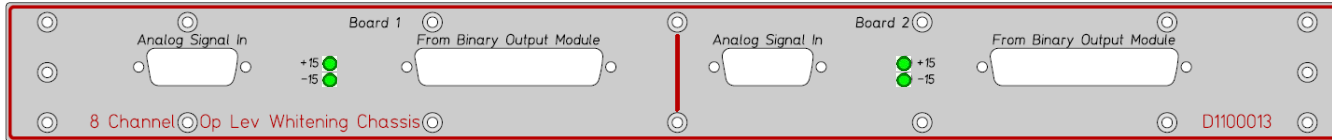

[D1100013](#)

Front

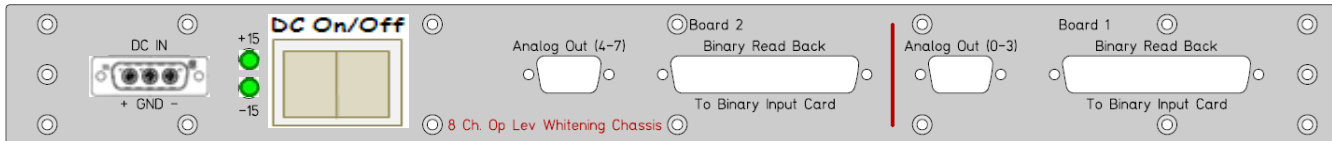
[S1101546](#)

Rear

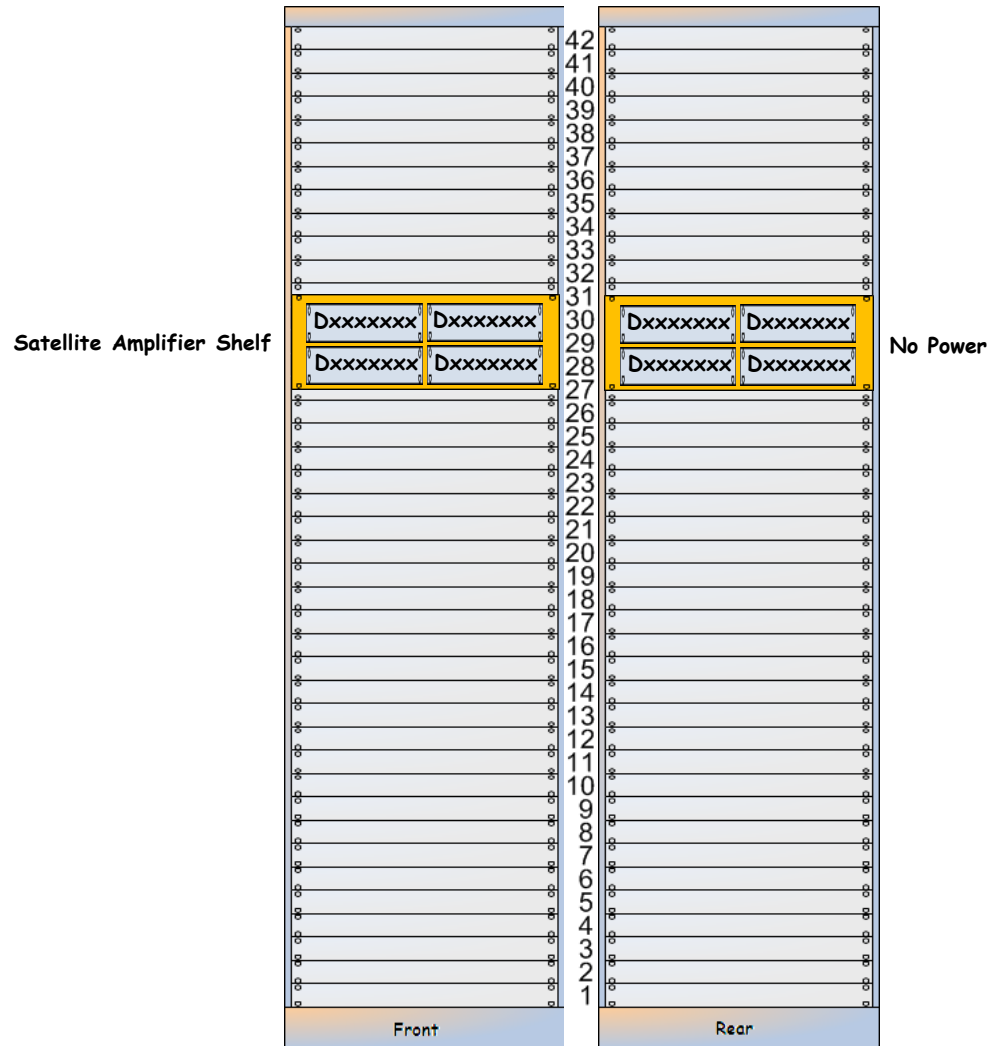

SUS-R3 is part of [D1100022](#)



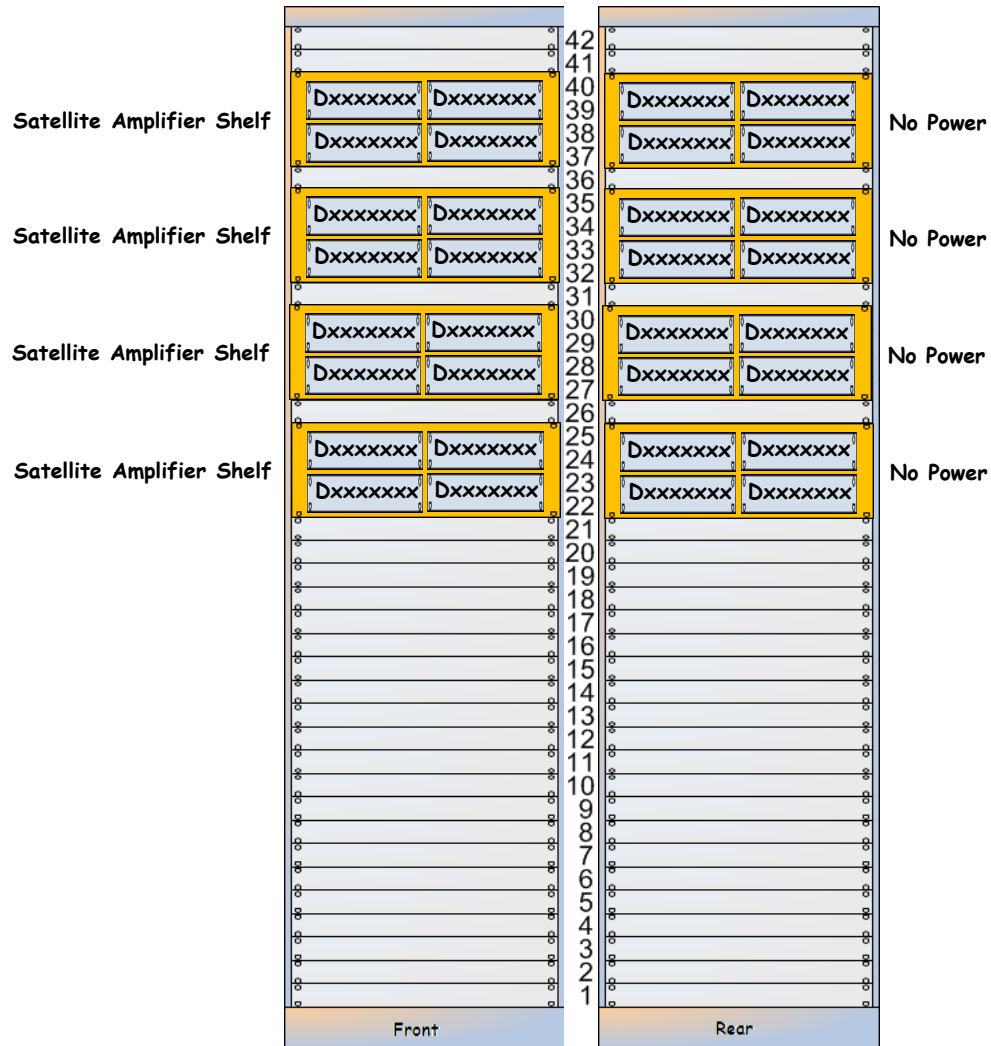

SUS-R4 is part of [D1100022](#)

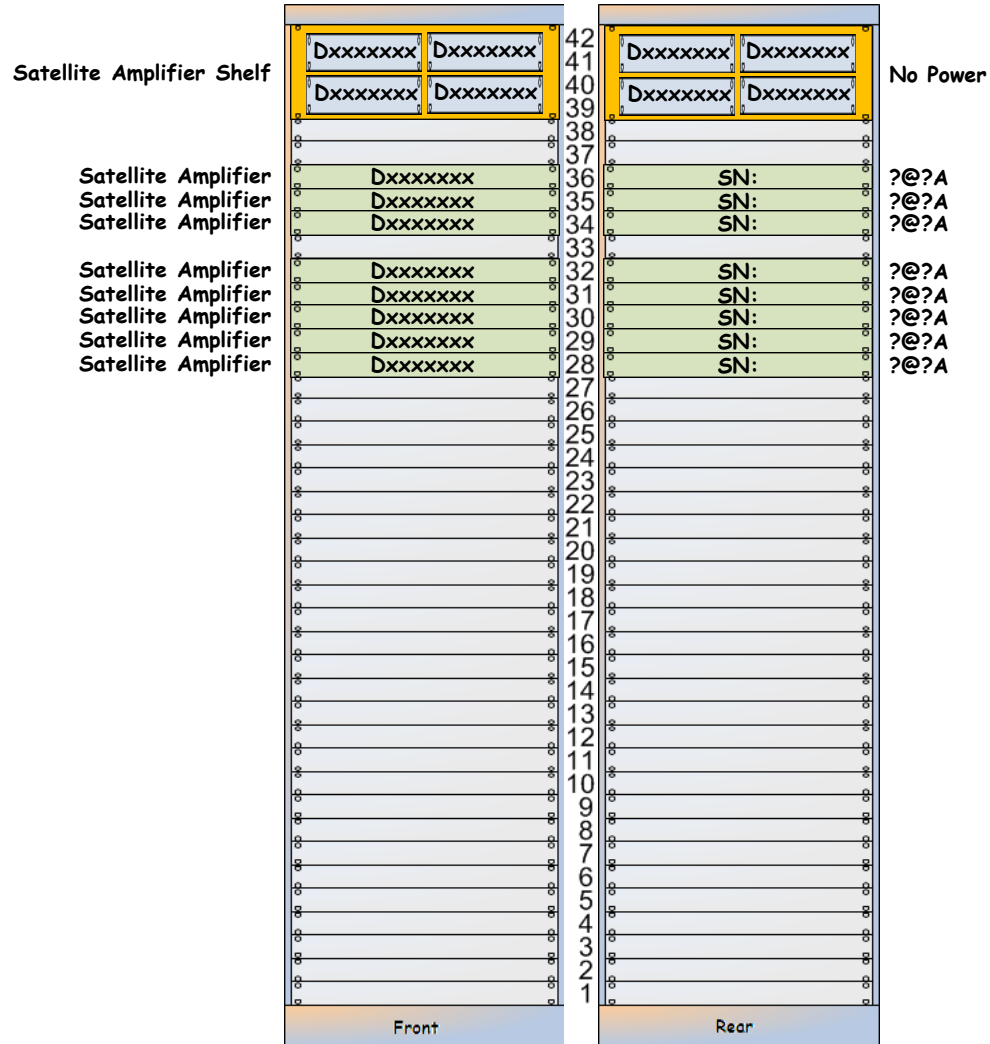

SUS-R5 is part of [D1100022](#)

SUS-R5 is part of [D1001725](#)



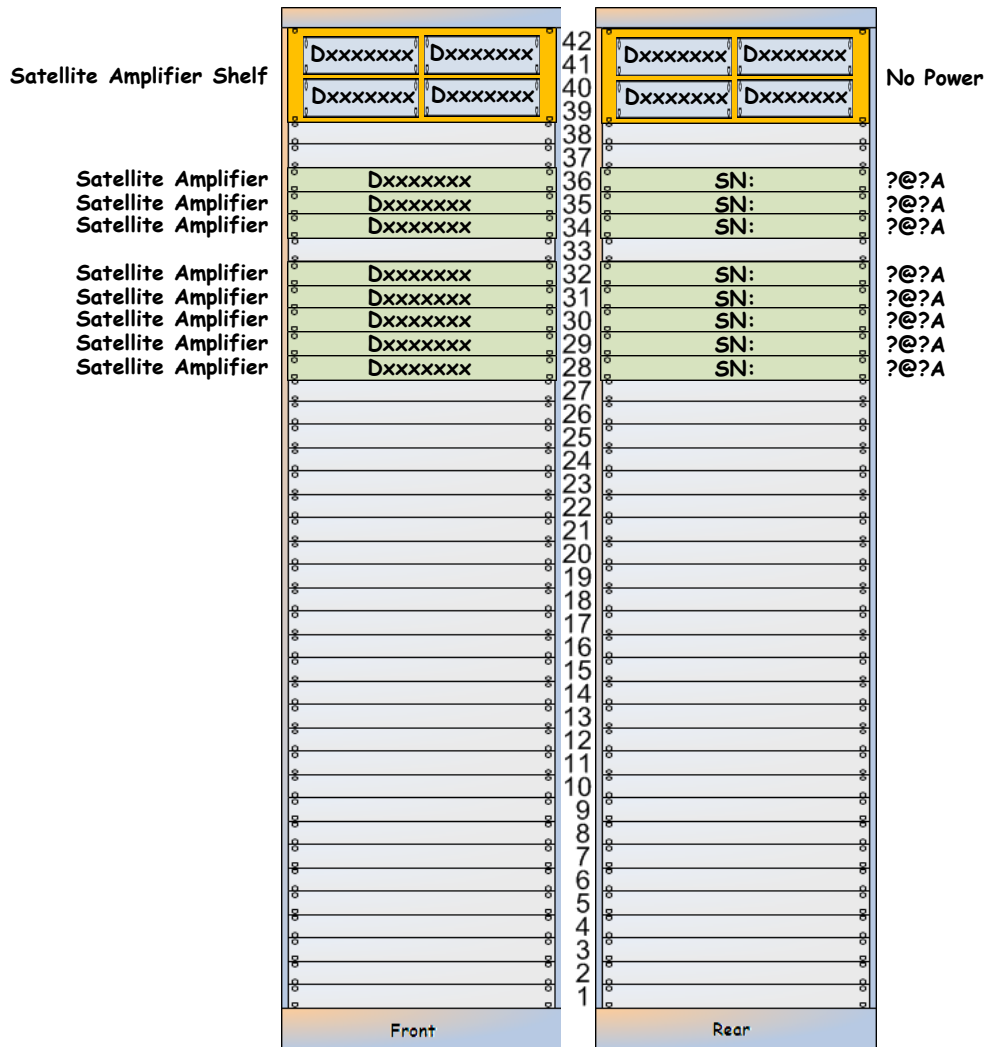

SUS-R6 is part of [D1100022](#)

SUS-R6 is part of [D1001725](#)



ITM: Hartmann Sensor Power Supply

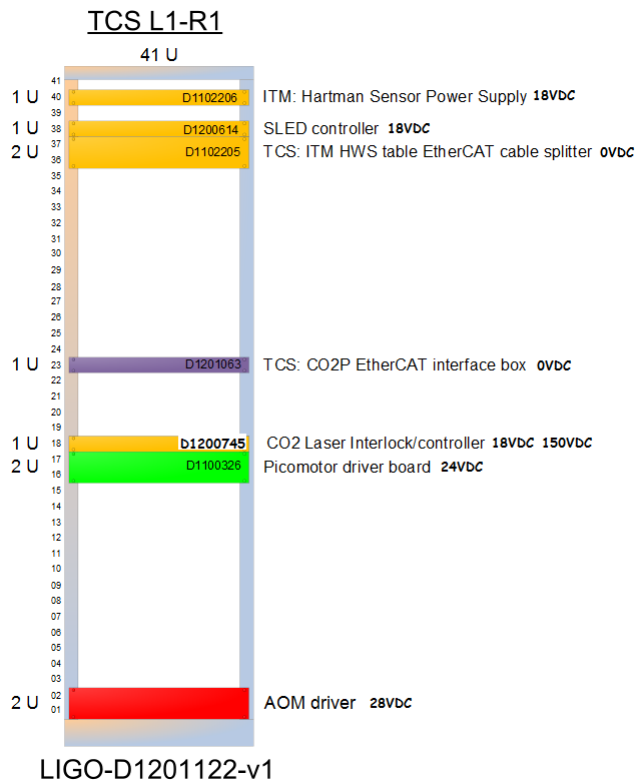

Controller
rface Box

PM 100

AD Driver
ker Driver

C-100-CC

Oscillator

n System

rface Box

istribution

Interlock
Interface

AOM Driver

	42		
	41		
D1102206	40	SN:	?@?A
D1000892	39	SN:	?@?A
D1102206	38	SN:	?@?A
	37		
XXXXXXX	36	XXXXXXX	?@?A
D1101655	35	SN:	?@?A
Dxxxxxxx	34	SN:	?@?A
SMC-100-CC	33	XXXXXXX	?@?A
	32		
XXXXXXX	31	XXXXXXX	?@?A
	30		
XXXXXXX	29	XXXXXXX	?@?A
	28		
D080351	27	SN:	?@?A
Dxxxxxxx	26	SN:	?@?A
	25		
Dxxxxxxx	24	SN:	?@?A
	23		
Dxxxxxxx	22	SN:	?@?A
	21		
Dxxxxxxx	20	SN:	?@?A
D1101931	19	SN:	?@?A
Dxxxxxxx	18	SN:	?@?A
	17		
	16		
	15		
	14		
	13		
	12		
	11		
	10		
	9		
	8		
	7		
	6		
	5		
	4		
	3		
Dxxxxxxx	2	SN:	?@?A
	1		
Front		Rear	

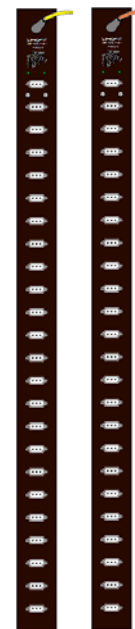

TCS-R1 is part of [D1200258](#)

TCS-R1 is part of [E1100892](#)

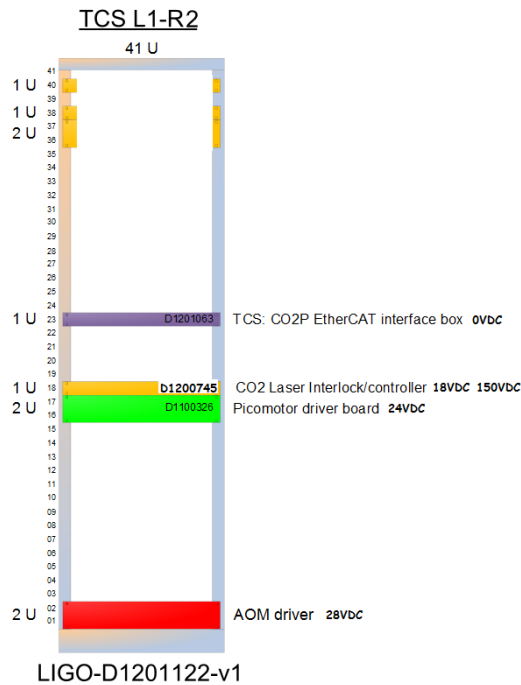

Thorlabs PM 100
QUAD Driver
Shaker Driver
+ SMC-100-CC
RF Oscillator
ilization System
Interface Box
ply Distribution
CO2 Interlock
ernet Interface

		42		
		41		
		40		
		39		
		38		
		37		
		36		
	XXXXXXX	35	XXXXXXX	?@?A
	QUAD Driver	34	SN:	?@?A
	Shaker Driver	33	SN:	?@?A
	+ SMC-100-CC	32	XXXXXXX	?@?A
		31		
		30		
	RF Oscillator	29		
		28	XXXXXXX	?@?A
		27		
	ilization System	26		
		25	SN:	?@?A
	Interface Box	24		
		23	SN:	?@?A
		22		
	ply Distribution	21		
		20	SN:	?@?A
	CO2 Interlock	19		
	ernet Interface	18	SN:	?@?A
		17	SN:	?@?A
		16		
		15		
		14		
		13		
		12		
		11		
		10		
		9		
		8		
		7		
		6		
		5		
		4		
		3		
		2		
	AOM Driver	1	SN:	?@?A
	Front		Rear	

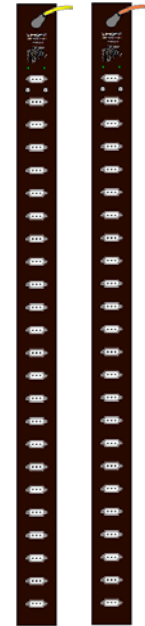

TCS-R2 is part of [D1200258](#)

TCS-R2 is part of [E1100892](#)

Marway MPD100 Power Distribution
 Sorensen DCS33-33E Switching DC Power Supply
 Power-Ten 3300D-3020 Switching DC Power Supply

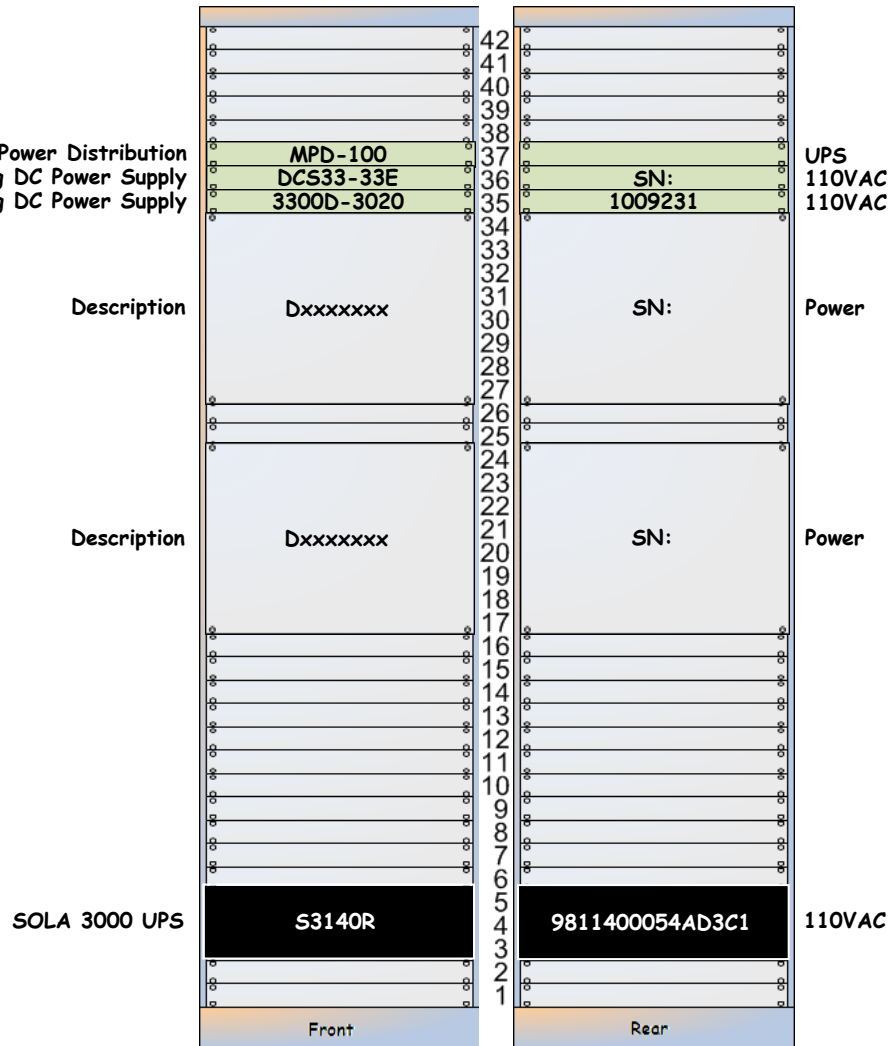

Marway MPD100 Power Distribution
 Sorensen DCS33-33E Switching DC Power Supply
 Power-Ten 3300D-3020 Switching DC Power Supply

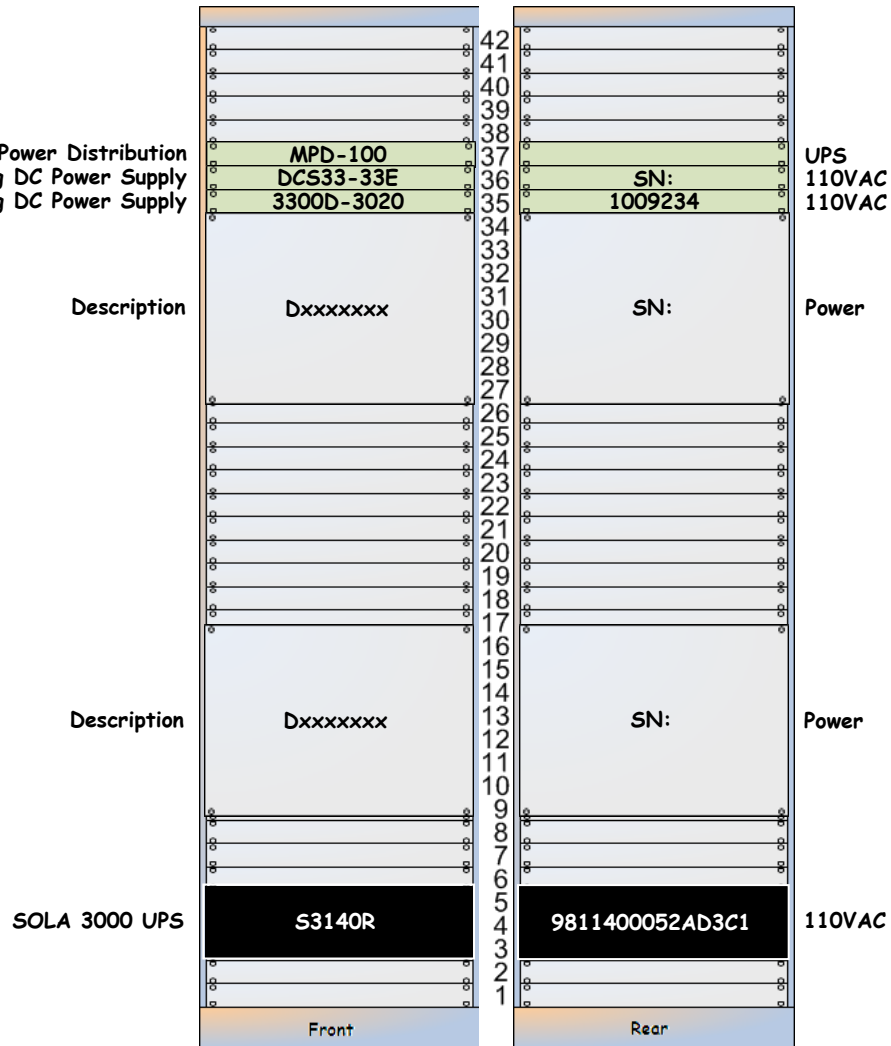

L1-VAC-R3 Mechanical Room Vacuum Rack Layout (Dxxxxxxx)

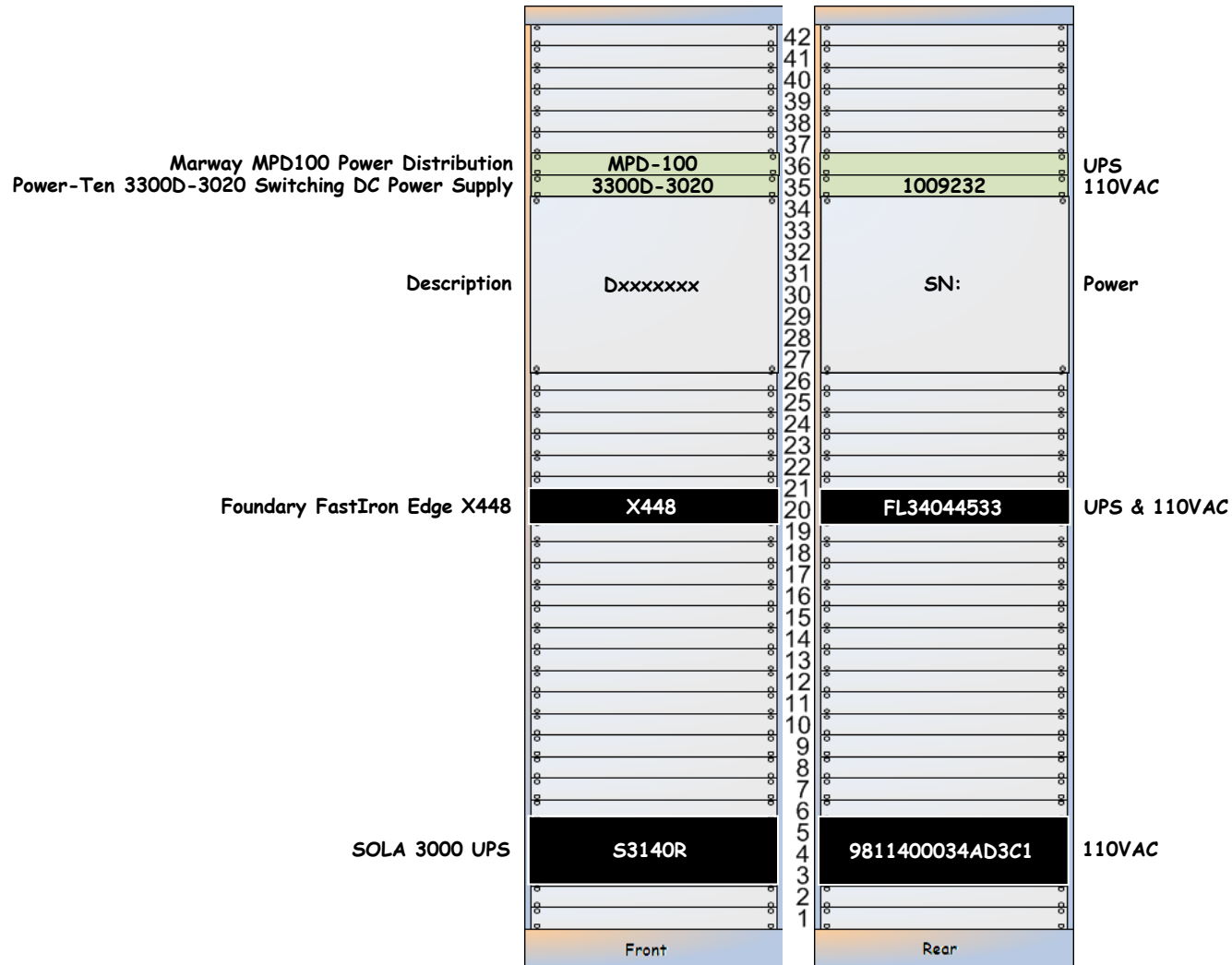

- [<< LLO Corner Station](#)
- [<< LLO Racks by AREA](#)
- [<< LLO CDS Components](#)
- [<< VEAX Fiber Patch Panel](#)

VEAX

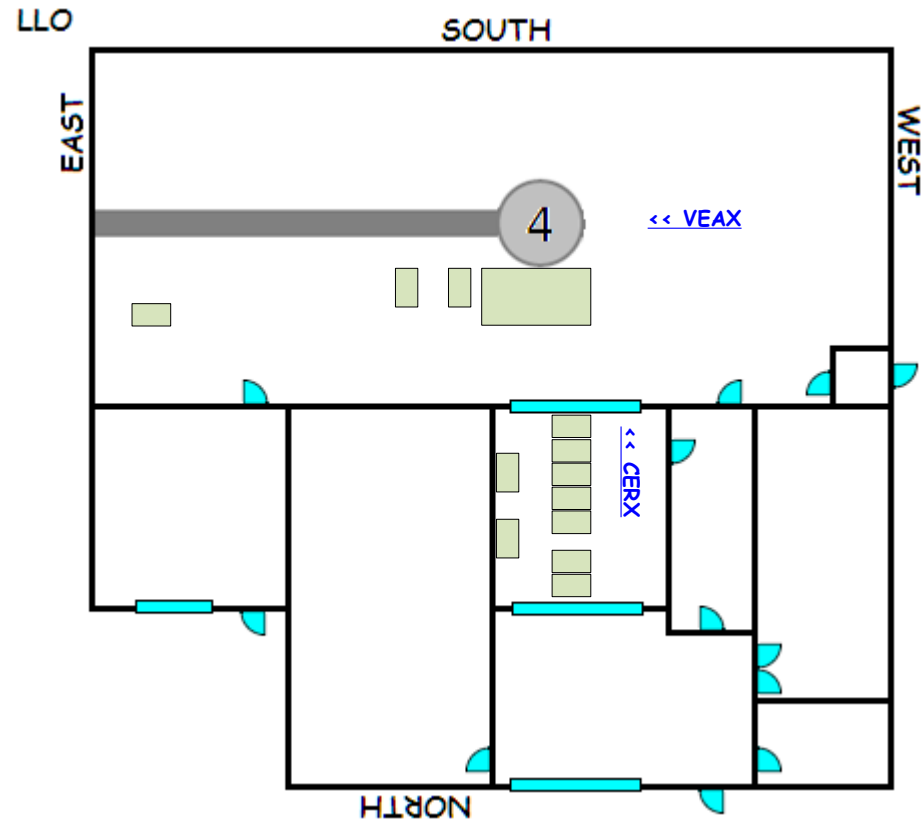

X-End Station Rack Layout

<< LLO Corner Station

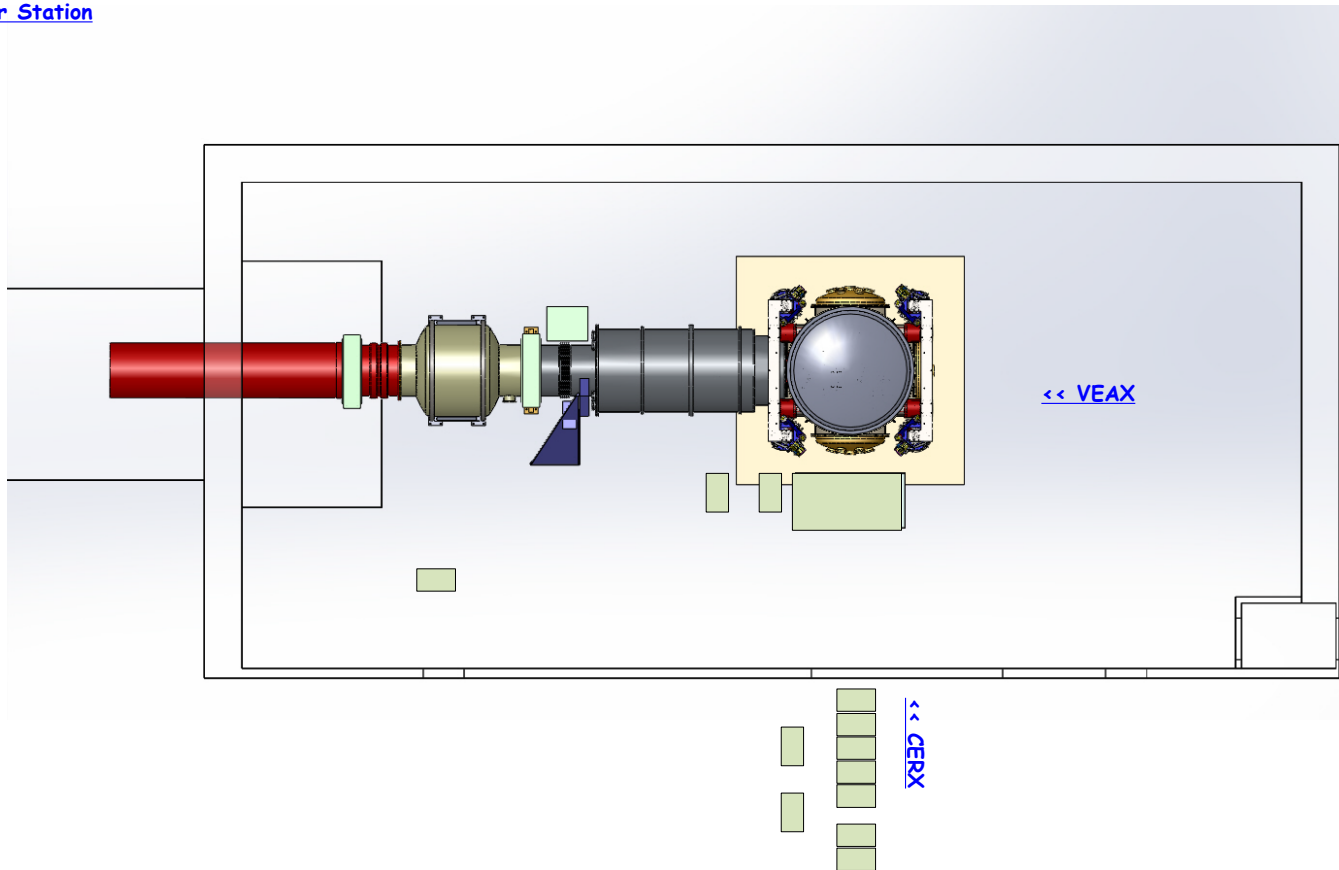

X-End - D0901465

[<< LLO Racks by AREA](#)

[<< LLO Racks by Subsystems](#)

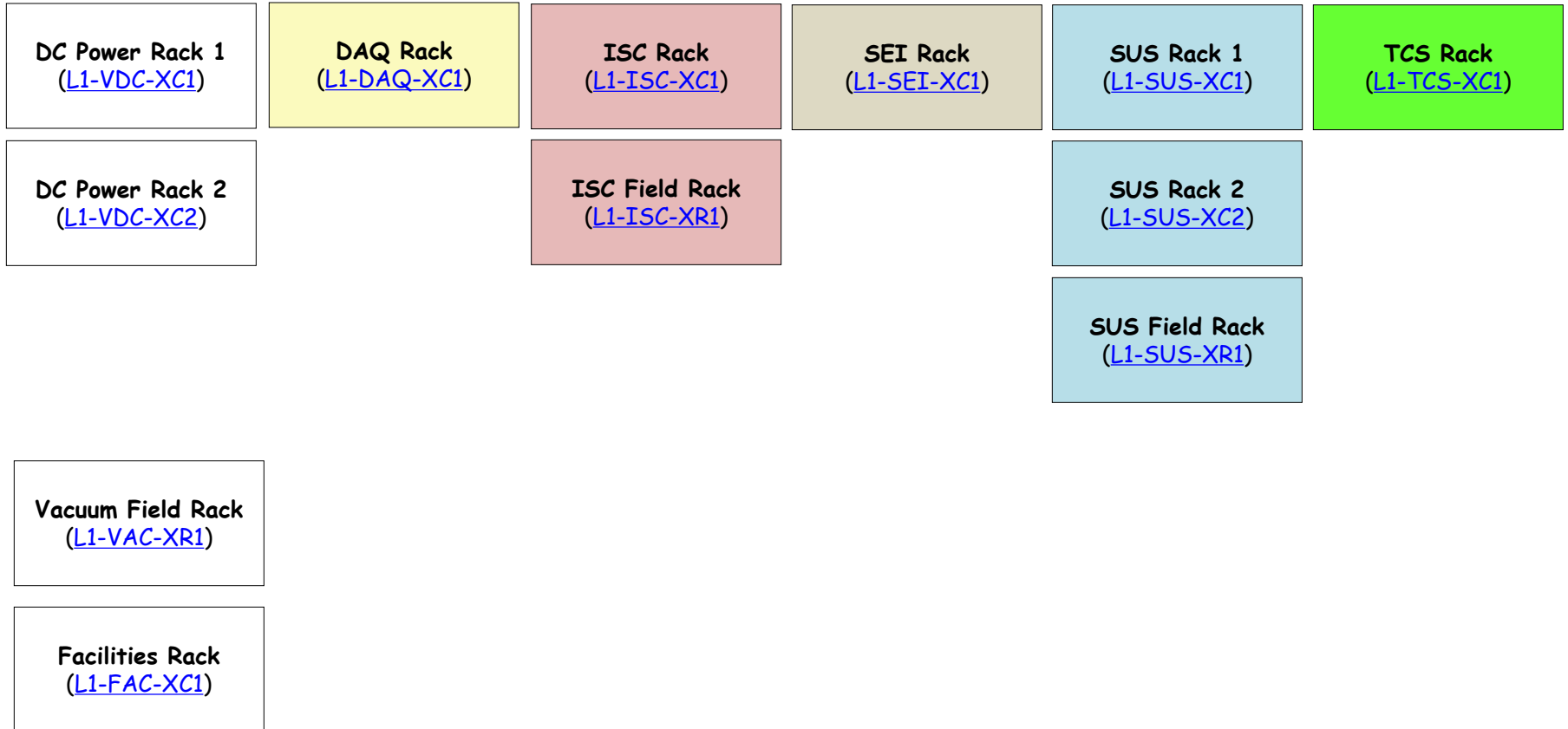

<< X-End Racks

It is 70' from the L1-FAC-XC1 Rack to the knee of the waterfall in the VEAX.

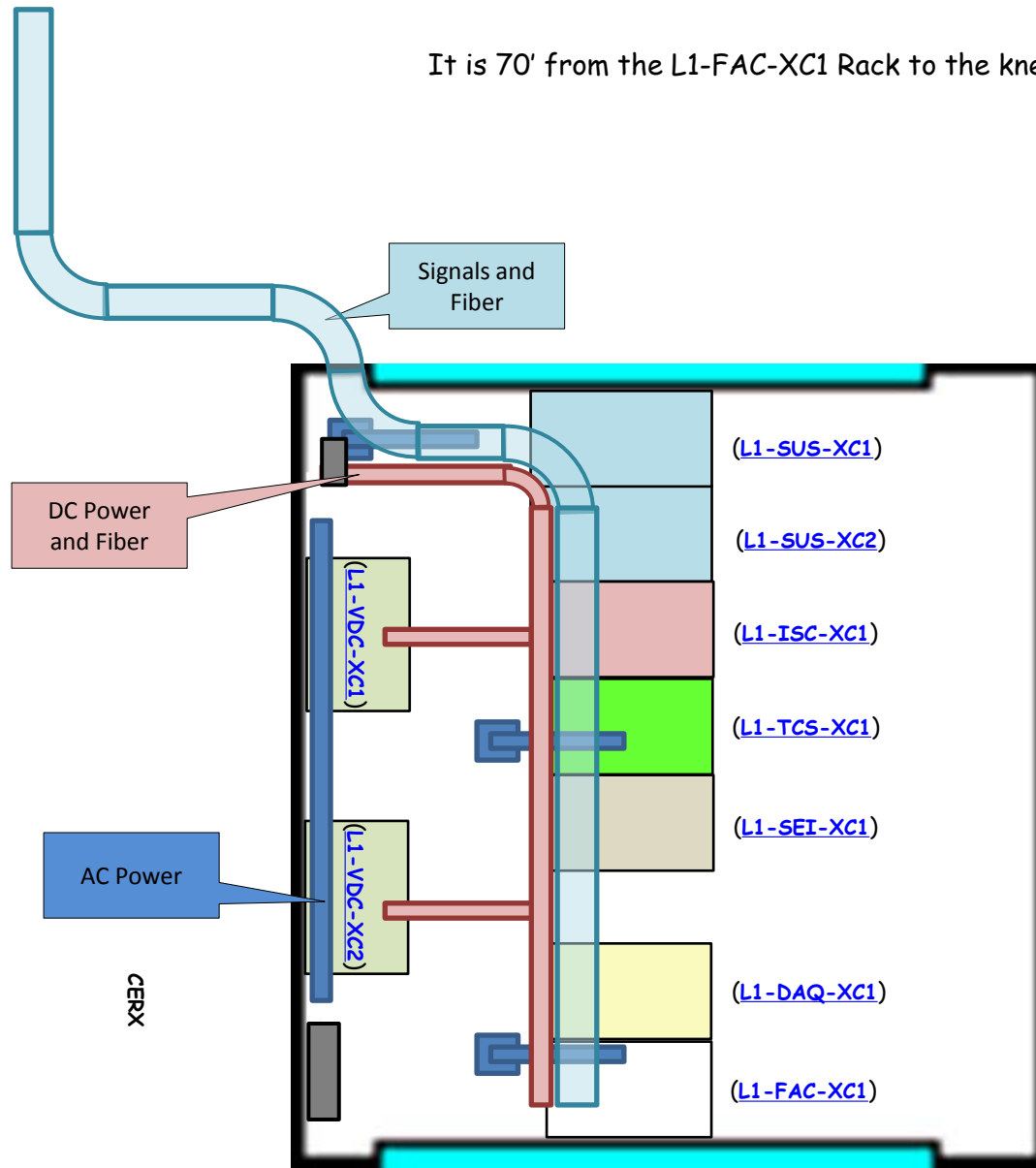

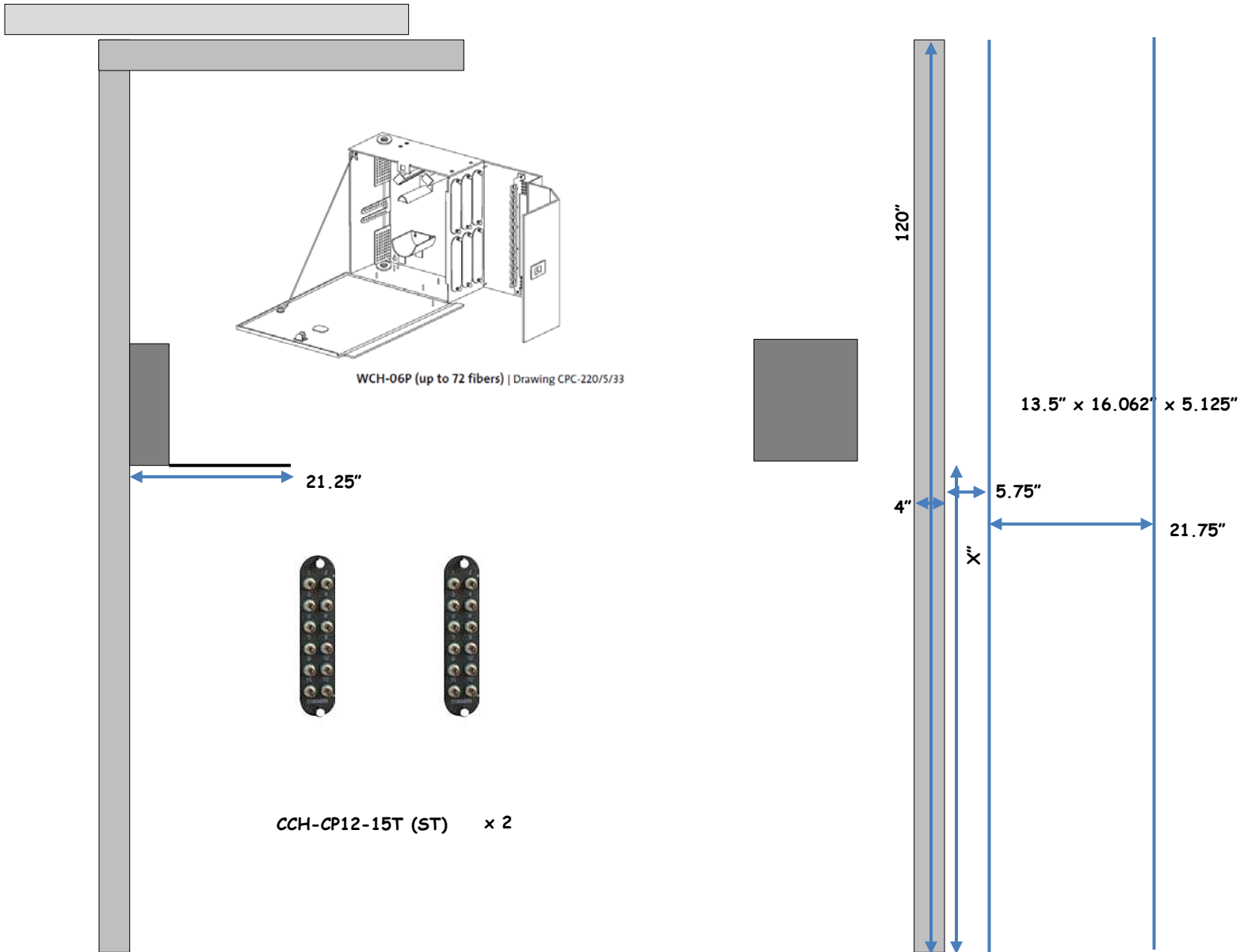

VEAX Fiber Patch Panel

VEAX Fiber Patch Panel

Patch Panel

Patch Panel

No Power

- A - ST Connectors
- B - ST Connectors
- C - NO Connectors
- D - NO Connectors
- E - NO Connectors
- F - NO Connectors

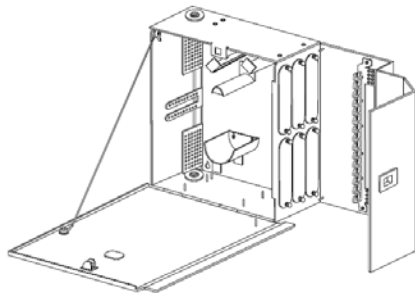

WCH-06P (up to 72 fibers) | Drawing CPC-220/5/33



3/22/2013		X-End Fiber Patch		
Port	Type	Fiber	Designation	Description
A1	FC	X-Fiber-15	l1netfedaqx Port 21F	IP - 10.199.0.87 Netgear GSM7244 Port 21F
A2	FC	Empty		
A3	FC	X-Fiber-16	l1netfedaqx Port 21F	IP - 10.199.0.87 Netgear GSM7244 Port 21F
A4	FC	X-Fiber-04	FACILITIES COMMUNICATIONS	S711DR
A5	FC	X-Fiber-02	Phone OUT	Extension 401
A6	FC	X-Fiber-10	l1fedaqx Port 6	ACC 5595 Port 6
A7	FC	X-Fiber-01	Phone IN	Extension 401
A8	FC	X-Fiber-09	l1fedaqx Port 6	ACC 5595 Port 6
A9	FC	Empty		
A10	FC	A12	Looped	Looped to A12
A11	FC	X-Fiber-03	Security Cameras	VT7430 Optical In/Out
A12	FC	A10	Looped	Looped to A10
Port	Type			
B1	FC	X-Fiber-11	GC 2402 Port 25F	IP - 197.168.253.20 GC 2402 Port 25F
B2	FC	Empty		
B3	FC	X-Fiber-12	GC 2402 Port 25F	IP - 197.168.253.20 GC 2402 Port 25F
B4	FC	Empty		
B5	FC	X-Fiber-07	l1lanfex Port 21F	IP - 10.199.0.13 Netgear GSM7224 Port 21F
B6	FC	X-Fiber-13	D070011 INPUT Port	L1-TCS-XC1 D070011 INPUT Port
B7	FC	X-Fiber-08	l1lanfex Port 21F	IP - 10.199.0.13 Netgear GSM7224 Port 21F
B8	FC	S-Fiber-14	D070011 INPUT Port	L1-TCS-XC1 D070011 INPUT Port
B9	FC	Empty		
B10	FC	X-Fiber-06	CDS GS624P Port 1F	IP - 10.199.0.20 GS624P Port 1F
B11	FC	X-Fiber-05	CDS GS624P Port 1F	IP - 10.199.0.20 GS624P Port 1F
B12	FC	Empty		

L1-VDC-XC1 Power Racks - VEAX Field Supplies

<< CERX Racks

L1-VDC-XC1 X-End Station DC Power Rack Layout ([D1200897](#)) ([S1202311](#))



[Cable Runs >>](#)

L1-VDC-XC1 Cable Runs

<< [L1-VDC-XC1](#)

L1-VDC-XC1 X-End Station DC Cable Runs ([D1200897](#)) ([S1202311](#))

L1-VDC-XC1 S1202311	Power Panel	Circuit	DC Power Rack	Outlet	Plug Position	Rack U	Power Supply Model	Power Supply Serial	Polarity	DC Extension Cable	Electronics Rack	Cable Length	DC Power Strip
1	CDS-X		L1-VDC-XC1	8	Top	U37-A (Left)							
2	CDS-X		L1-VDC-XC1	8	Bottom	U37-B (Right)							
3	CDS-X		L1-VDC-XC1	2	Top	U33-A (Left)							
4	CDS-X		L1-VDC-XC1	2	Bottom	U33-B (Right)							
5	CDS-X		L1-VDC-XC1	9	Top	U29-A (Left)	BHK 500V 80mA	A107266	Plus	PBX-003	L1-AOS		
6	CDS-X		L1-VDC-XC1	9	Bottom	U29-B (Right)	BHK 500V 80mA	A107260	Minus	PBX-003	L1-AOS		
7	CDS-X		L1-VDC-XC1	3	Top	U25-A (Left)	JQE 25V 20A	H236461	Plus	PTO-064	L1-ISC-XR1	60	PSO-xxx
8	CDS-X		L1-VDC-XC1	3	Bottom	U25-B (Right)	JQE 25V 20A	H236389	Minus	PTO-064	L1-ISC-XR1	60	PSO-xxx
9	CDS-X		L1-VDC-XC1	10	Top	U21-A (Left)	JQE 25V 10A	H222052	Plus	PTY-057	L1-ISC-XR1	60	PSY-xxx
10	CDS-X		L1-VDC-XC1	10	Bottom	U21-B (Right)	JQE 25V 10A	H192369	Minus	PTY-057	L1-ISC-XR1	60	PSY-xxx
11	CDS-X		L1-VDC-XC1	4	Top	U17-A (Left)	JQE 25V 20A						
12	CDS-X		L1-VDC-XC1	4	Bottom	U17-B (Right)	JQE 25V 20A						
13	CDS-X		L1-VDC-XC1	11	Top	U13-A (Left)	JQE 25V 20A						
14	CDS-X		L1-VDC-XC1	11	Bottom	U13-B (Right)	JQE 25V 20A						
15	CDS-X		L1-VDC-XC1	5	Top	U09-A (Left)	JQE 25V 20A						
16	CDS-X		L1-VDC-XC1	5	Bottom	U09-B (Right)	JQE 25V 20A						
17	CDS-X		L1-VDC-XC1	12	Top	U05-A (Left)	JQE 25V 20A						
18	CDS-X		L1-VDC-XC1	12	Bottom	U05-B (Right)	JQE 25V 20A						
19	CDS-X		L1-VDC-XC1	6	Top	U01-A (Left)	JQE 25V 20A						
20	CDS-X		L1-VDC-XC1	6	Bottom	U01-B (Right)	JQE 25V 20A						
D1200897													

L1-VDC-XC2 Power Racks - VEAX Supplies

<< CERX Racks

L1-VDC-XC2 X-End Station DC Power Rack Layout ([D1200898](#)) ([S1202312](#))

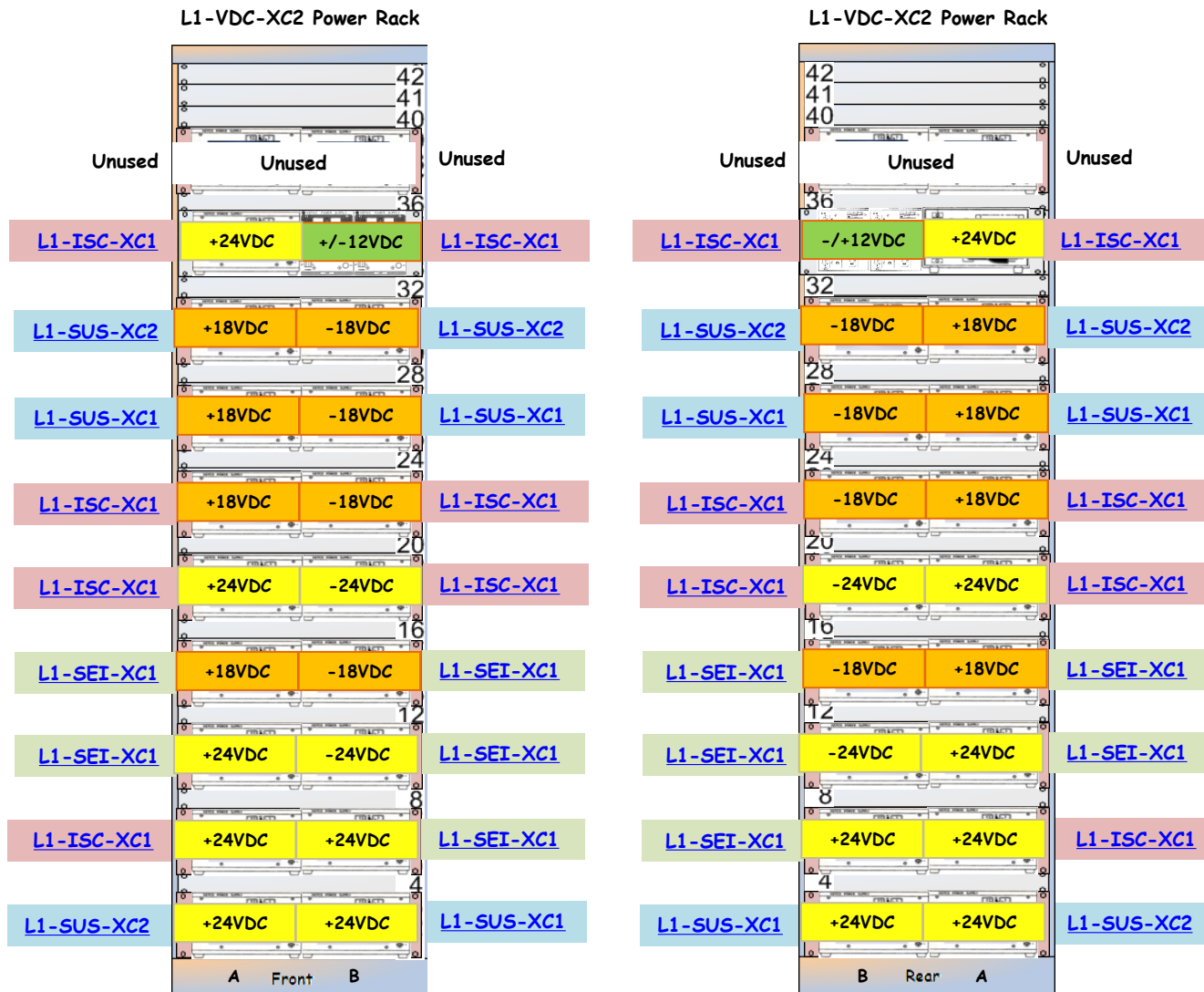

[Cable Runs >>](#)

L1-VDC-XC2 Cable Runs

<< [L1-VDC-XC2](#)

L1-VDC-XC2 X-End Station DC Cable Runs ([D1200898](#)) ([S1202312](#))

L1-VDC-XC2 S1202312	Power Panel	Circuit	DC Power Rack	Outlet	Plug Position	Rack U	Power Supply Model	Power Supply Serial	Polarity	DC Extension Cable	Electronics Rack	Cable Length	DC Power Strip
1	CDS-X		L1-VDC-XC2	8	Top	U37-A (Left)							
2	CDS-X		L1-VDC-XC2	8	Bottom	U37-B (Right)							
3	CDS-X		L1-VDC-XC2	2	Top	U33-A (Left)	JQE 25V 10A	H222053	Plus	PTY-053	L1-ISC-XC1	30	PSY-xxx
4	CDS-X		L1-VDC-XC2	2	Bottom	U33-B (Right)	JQE 15V 6A JQE 15V 6A	H214514 H214461	Plus Minus	PTG-005	L1-ISC-XC1	30	PSG-006
5	CDS-X		L1-VDC-XC2	9	Top	U29-A (Left)	JQE 25V 20A	H236497	Plus	PTO-042	L1-SUS-XC2	30	PSO-042
6	CDS-X		L1-VDC-XC2	9	Bottom	U29-B (Right)	JQE 25V 20A	H236515	Minus	PTO-042	L1-SUS-XC2	30	PSO-042
7	CDS-X		L1-VDC-XC2	3	Top	U25-A (Left)	JQE 25V 20A	H236501	Plus	PTO-043	L1-SUS-XC1	32	PSO-043
8	CDS-X		L1-VDC-XC2	3	Bottom	U25-B (Right)	JQE 25V 20A	H236473	Minus	PTO-043	L1-SUS-XC1	32	PSO-043
9	CDS-X		L1-VDC-XC2	10	Top	U21-A (Left)	JQE 25V 20A	H236510	Plus	PTO-044	L1-ISC-XC1	28	PSO-044
10	CDS-X		L1-VDC-XC2	10	Bottom	U21-B (Right)	JQE 25V 20A	H236511	Minus	PTO-044	L1-ISC-XC1	28	PSO-044
11	CDS-X		L1-VDC-XC2	4	Top	U17-A (Left)	JQE 25V 20A	H236493	Plus	PTY-031	L1-ISC-XC1	28	PSY-031
12	CDS-X		L1-VDC-XC2	4	Bottom	U17-B (Right)	JQE 25V 20A	H236517	Minus	PTY-031	L1-ISC-XC1	28	PSY-031
13	CDS-X		L1-VDC-XC2	11	Top	U13-A (Left)	JQE 25V 20A	H236505	Plus	PTO-045	L1-SEI-XC1	22	PSO-045
14	CDS-X		L1-VDC-XC2	11	Bottom	U13-B (Right)	JQE 25V 20A	H236494	Minus	PTO-045	L1-SEI-XC1	22	PSO-045
15	CDS-X		L1-VDC-XC2	5	Top	U09-A (Left)	JQE 25V 20A	H236509	Plus	PTY-032	L1-SEI-XC1	22	PSY-032
16	CDS-X		L1-VDC-XC2	5	Bottom	U09-B (Right)	JQE 25V 20A	H236492	Minus	PTY-032	L1-SEI-XC1	22	PSY-032
17	CDS-X		L1-VDC-XC2	12	Top	U05-A (Left)	JQE 25V 20A	H236482	Plus	PTY-033	L1-ISC-XC1	30	PSY-033
18	CDS-X		L1-VDC-XC2	12	Bottom	U05-B (Right)	JQE 25V 20A	H236481	Plus	PTY-034	L1-SEI-XC1	22	PSY-034
19	CDS-X		L1-VDC-XC2	6	Top	U01-A (Left)	JQE 25V 20A	H236498	Plus	PTY-035	L1-SUS-XC2	32	PSY-035
20	CDS-X		L1-VDC-XC2	6	Bottom	U01-B (Right)	JQE 25V 20A	H236514	Plus	PTY-036	L1-SUS-XC1	32	PSY-036
D1200898													

L1-DAQ-XC1 Details

Dolphin RFM Switch

DXS410

AD053708012

UPS2



ACC 5595

Front

To I1 lanfey port 5

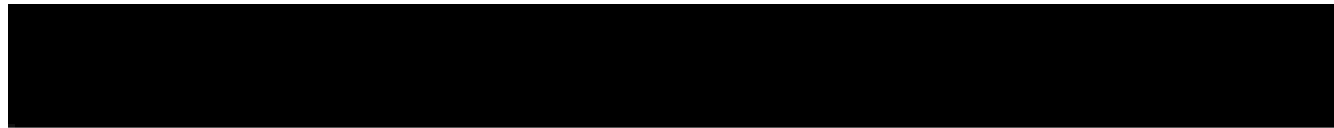

AD053708012

Rear

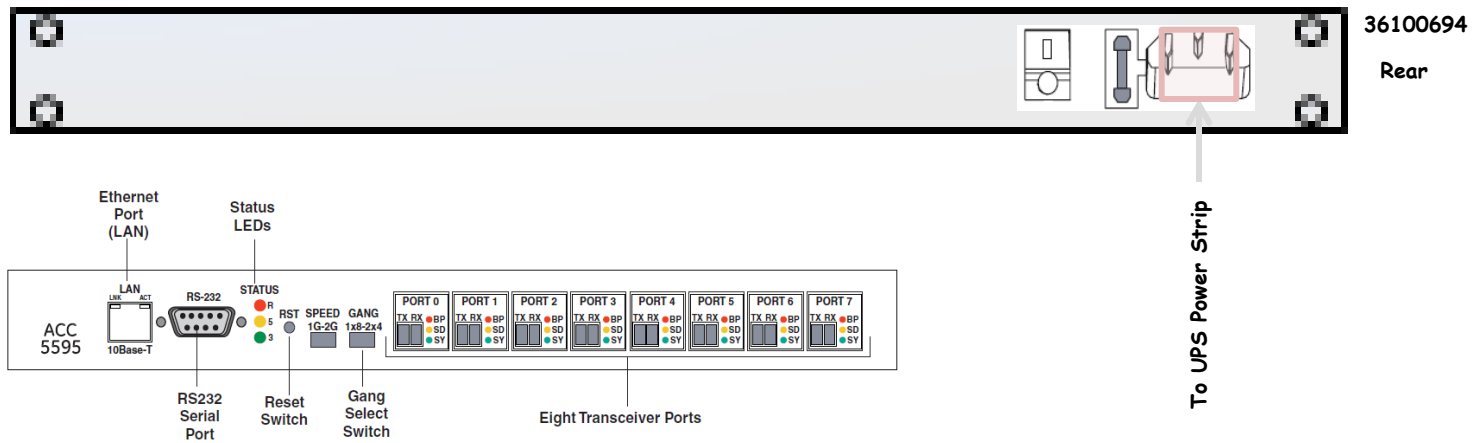
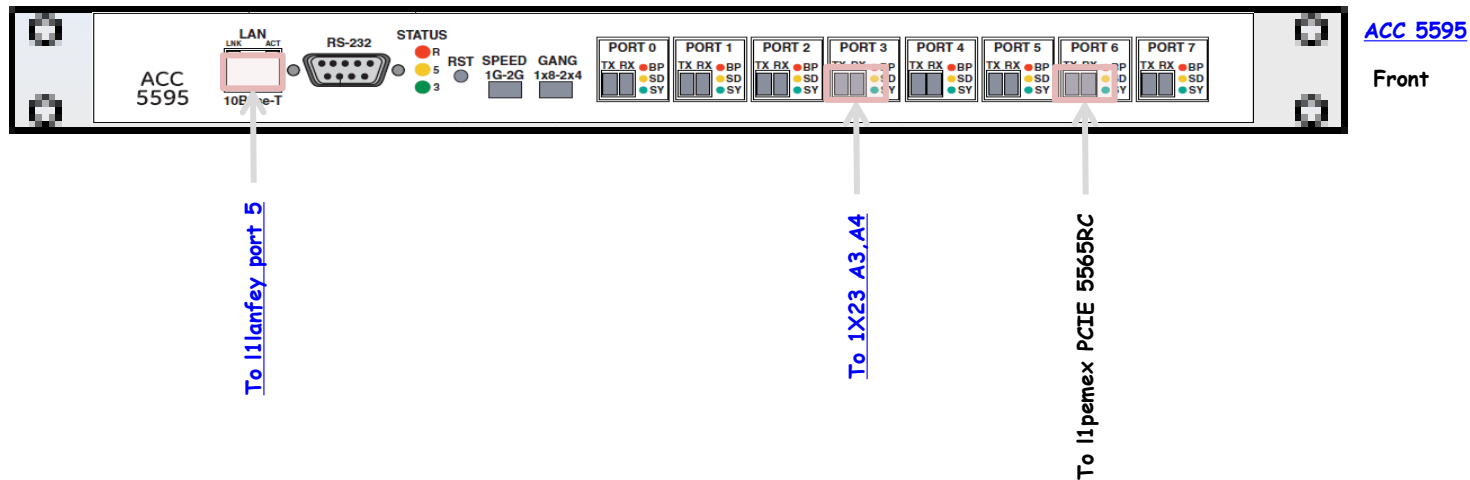



GSM7224

Front

CO:3F:0E:86:88:E0



3 - To FE NET Port

21F - To 1X23 PP B1, B2



2B62045600150

Rear

To UPS Power Strip



GSM7224

Front

CO:3F:0E:86:88:AC

3 - To FE LAN Port

5 - To 5595 LAN 10BaseT

21F - To 1X23 PP E3,E4



2B62045700143

Rear

To UPS Power Strip

Timing IRIG-B Interface Chassis

D0900301

S1107510

+12VDC

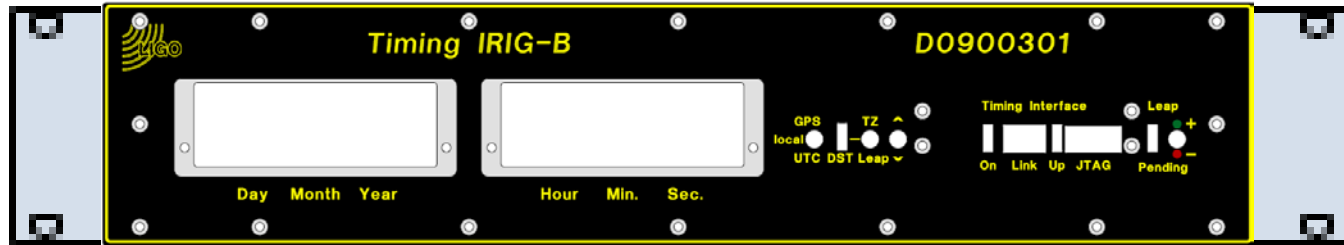

D0900301

Front

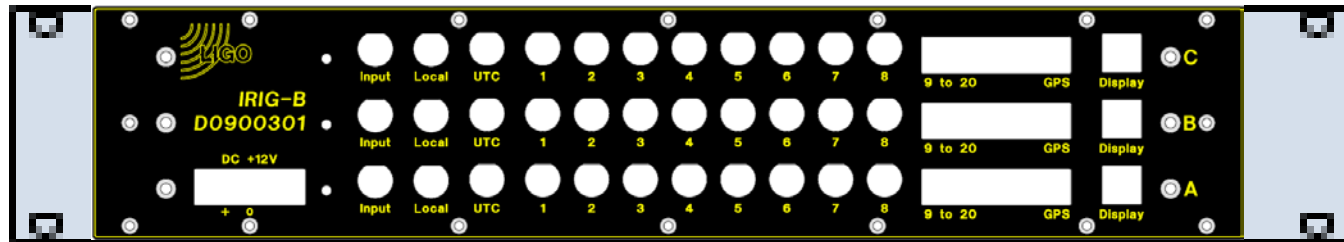

S1107510

Rear

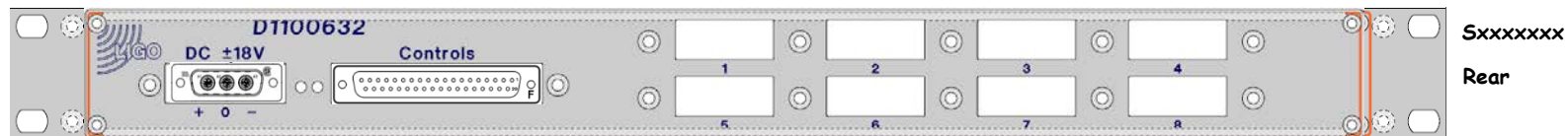
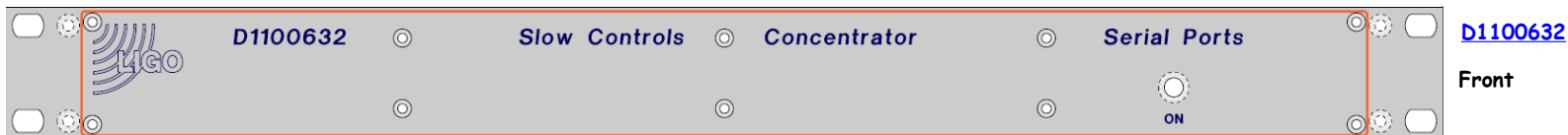

<< L1-DAQ-XC1

Beckhoff Slow Controls
ISC Common

D1002961

S1103497

+24VDC

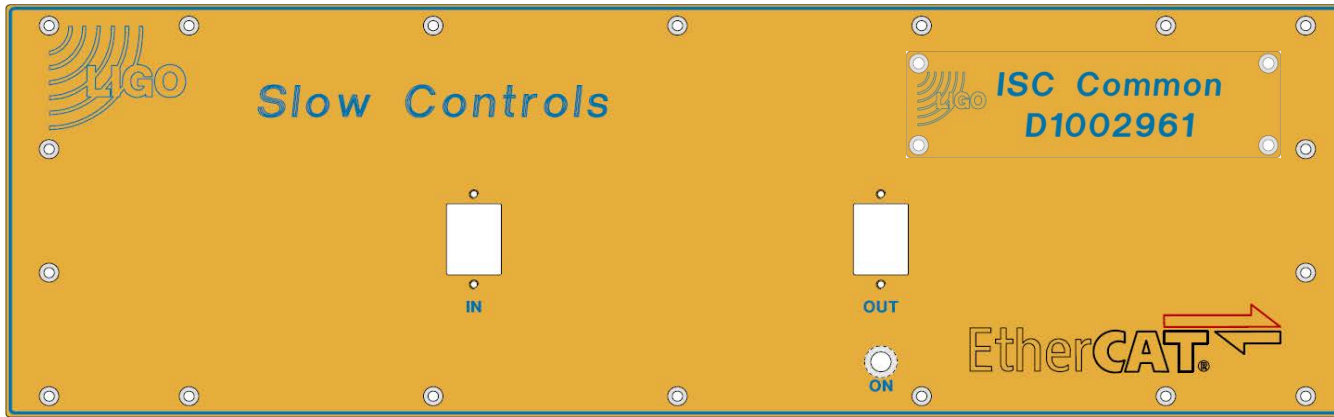

D1002961

Front: D0902553

Name: D1002962

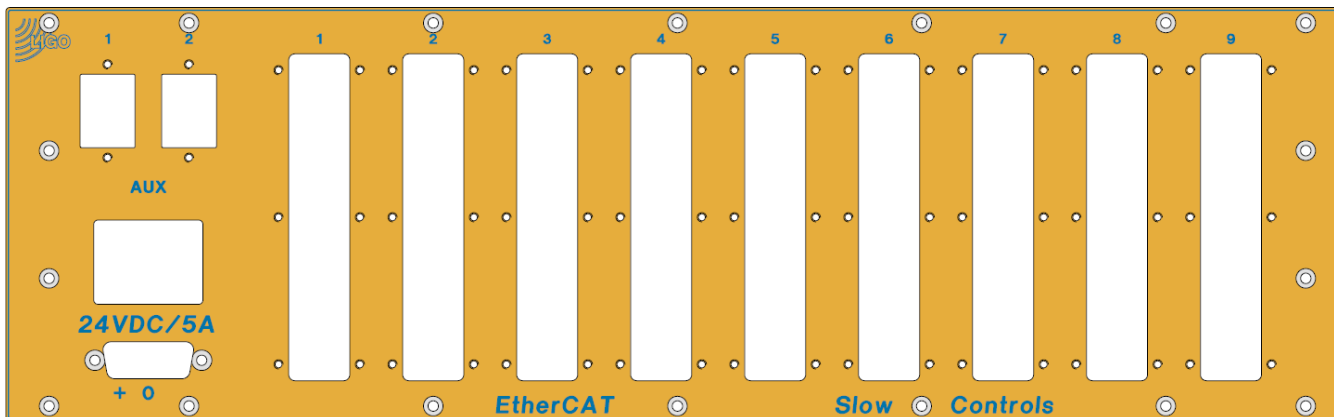

S1103497

Rear: D0902554

<< L1-DAQ-XC1

ATEN KVM Switch

CL1016M

Z8A6Y132ANQ0010

110VAC



l1susex Front End

l1susex Front End Computer

Front End

SN:

110VAC

l1seiex Front End

l1seiex Front End Computer

Front End

SN:

110VAC



Hartmann Sensor Computer Front End

<< [L1-DAQ-XC1](#)

Hartmann Sensor Front End Computer

[T1000702](#)

SN:

110VAC

APC SMX2000RMLV2U

UPS

[APC SMX2000RMLV2U](#)

JS1048019433

110VAC



[APC SMX2000RMLV2U](#)

Front

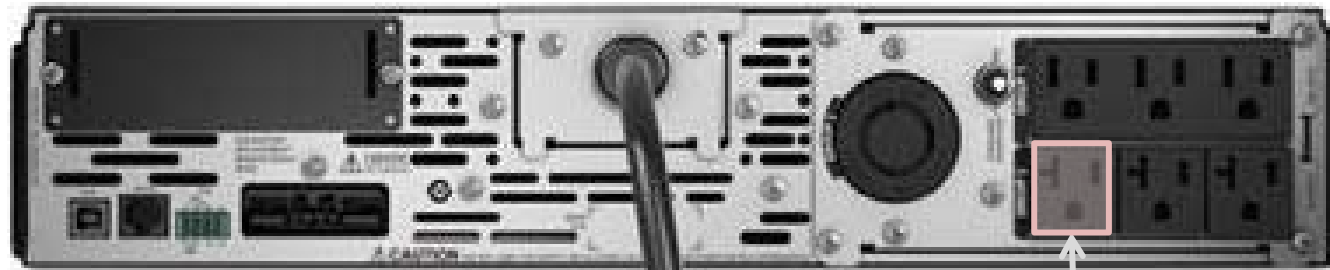

JS1048019433

Rear

[To UPS Power Strip](#)

L1-FAC-XC1

L1-FAC-XC1 Facilities X-End Station Remote Rack Layout (D1201086) (S1202950)

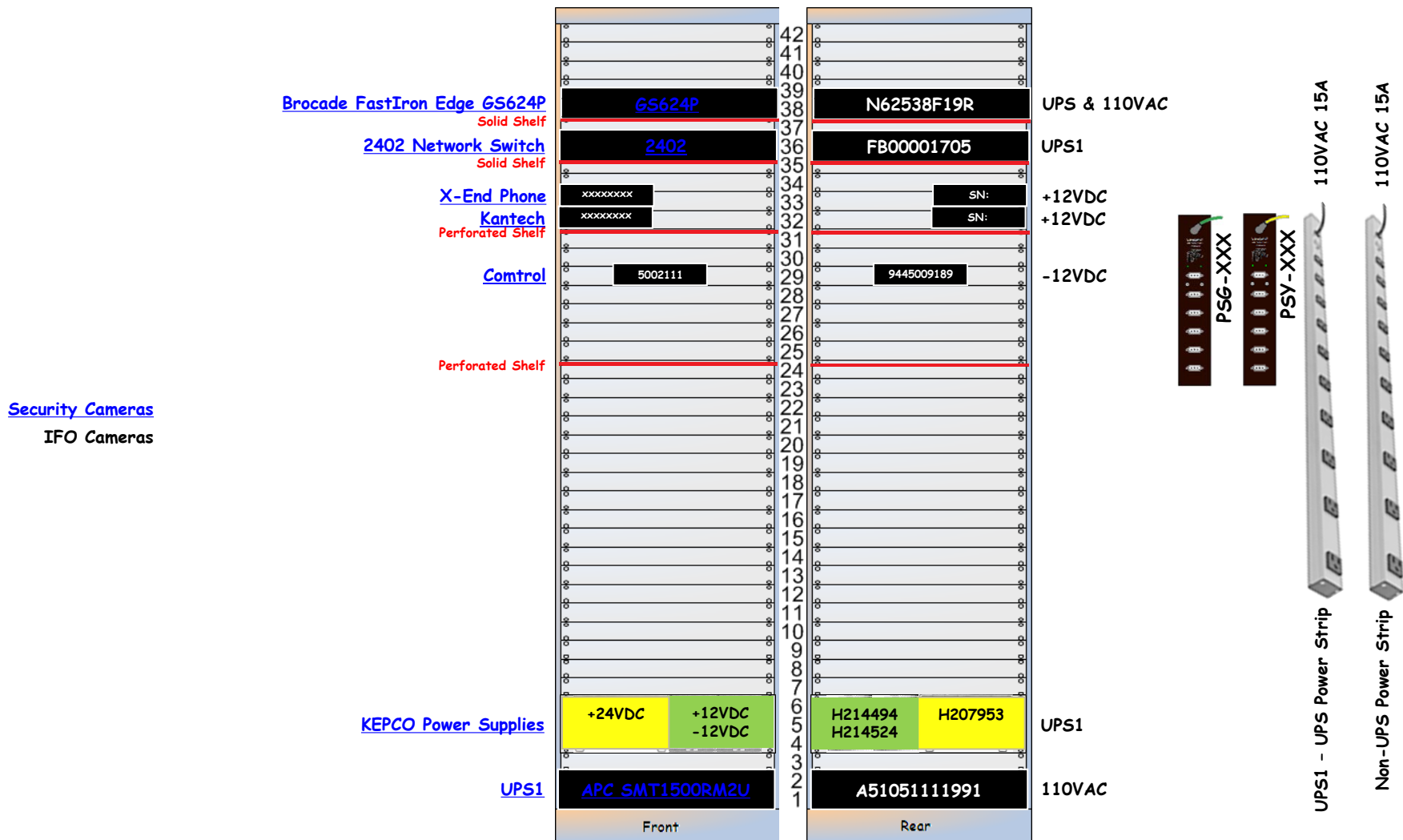

L1-FAC-XC1 Details

<< L1-FAC-XC1

Brocade FastIron Edge GS624P

GS624P

N62538F19R

UPS & 110VAC



GSM7224

Front

CO:3F:0E:86:88:E0

21F - To 1X23 PP B1.B2

3 - To FE NET Port

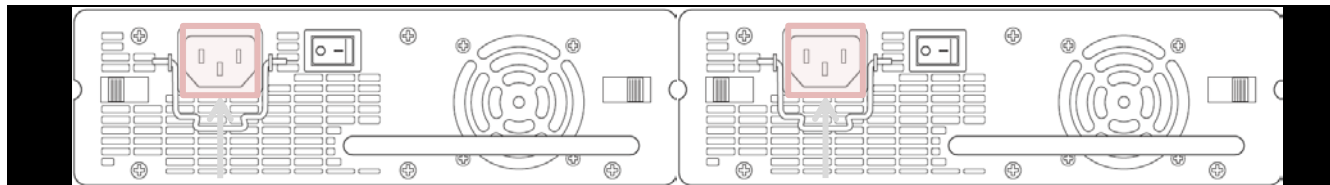

N62538F19R

Rear

To 110 Power Strip

To UPS Power Strip

<< L1-FAC-XC1

2402 Network Switch

2402

FB00001705

110VAC

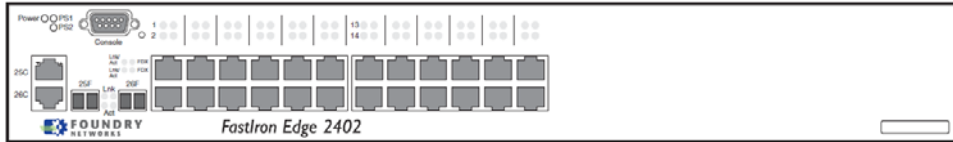

- Empty ↔ 01
- Kantech??? ↔ 02
- Empty ↔ 03
- Empty ↔ 04
- Empty ↔ 05
- Empty ↔ 06
- Empty ↔ 07
- Empty ↔ 08
- Empty ↔ 09
- Empty ↔ 10
- Empty ↔ 11
- Empty ↔ 12
- Empty ↔ 13
- To Seimens ↔ 14
- Empty ↔ 15
- Empty ↔ 16
- Empty ↔ 17
- Empty ↔ 18
- Empty ↔ 19
- Empty ↔ 20
- Empty ↔ 21
- Empty ↔ 22
- Empty ↔ 23
- Empty ↔ 24

- Empty ↔ 25C
- Empty ↔ 26C
- To Special Cable CSR1 ↔ 25F
- To 1X23 PP E1,E2 ↔ 26F

G12038
192.168.253.20

To UPS Power Strip

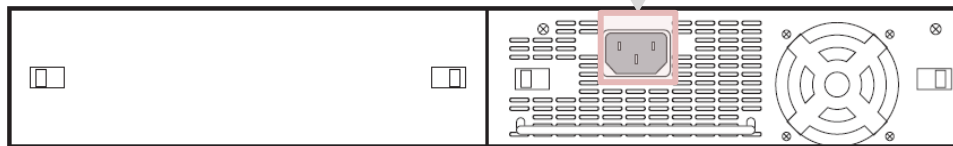

PS1

X-End Phone

Phone

TR3030WDM
 GE Security
 Optical In/Out:
[To 1X23 PP](#)
[B3,B4](#)
 Phone: Copper to
 VEA
 Power: 12VDC

Powered from Wall Wart from
 Tripp-Lite UPS
 Model BC320
 9834DY0BC614000661 To 6-
 Outlet Power Strip in Non-
 isolated wall socket



System Design

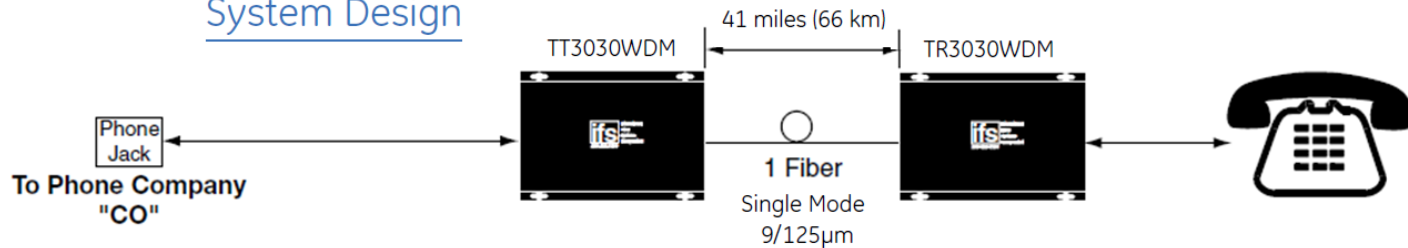

X-End - Kantech Interface

Kantech

Fiber Options
[7711-R \(501R\)](#)
Optical In/Out:
[To 1Y23 PP D2](#)
Power: 13.5VDC
from Wall Wart

Blue CAT5:
1=O/W and
B/W, 4=O, 7=B

Powered from
Wall Wart from
Isolated Power

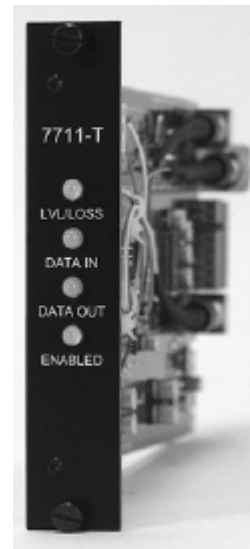
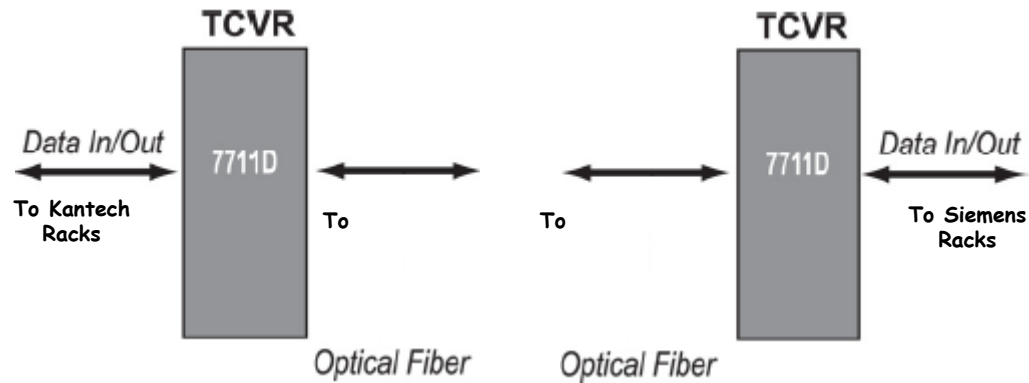

X-End - Control Interface

Control

5002111

9445009189

-12VDC

Control DeviceMaster 4 with DB9 Ports

DeviceMaster 4 with DB9 ports

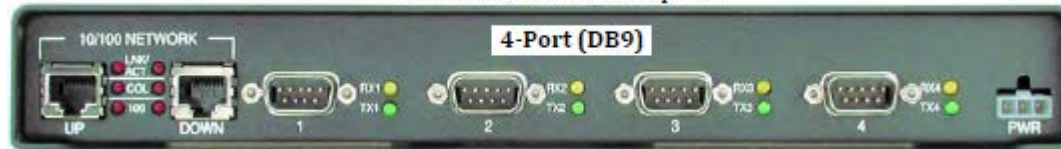

MAC Address:
00-C0-4E-07-3F-5D

IP Address:
10/110.60.??

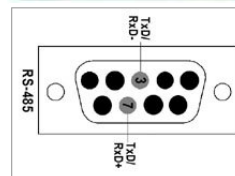

4-Port Power Supply

This table provides the specifications for the power supply shipped with the DeviceMaster 4-port.

Control Power Supply: 4-Port	
Input line frequency	47 - 63 Hz
Input line voltage	90 - 260 VAC
Output voltage	24VDC
Output current	500 mA @ 24VDC

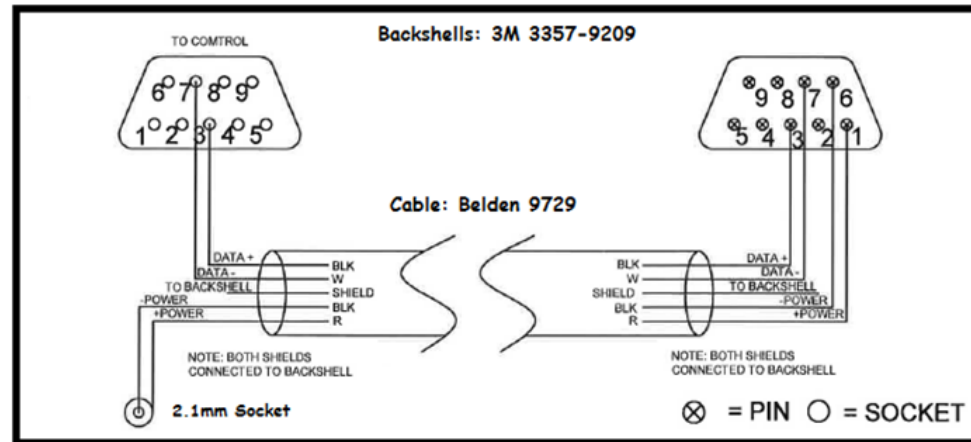
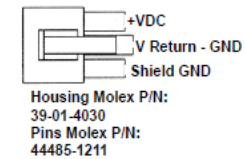

3M Shell 3357-9209

3M Shell 3357-9209

2.1mm Socket
(Note polarity)

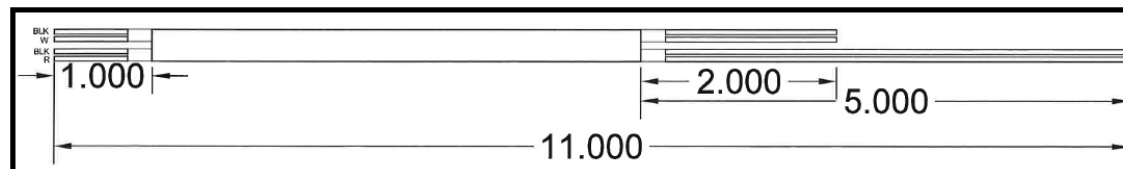

2.1mm Plug
(Note polarity)

KEPCO Power Supplies

KEPCO Power Supplies

+24VDC	+12VDC -12VDC
--------	------------------

H214494 H214524	H207953
--------------------	---------

UPS1

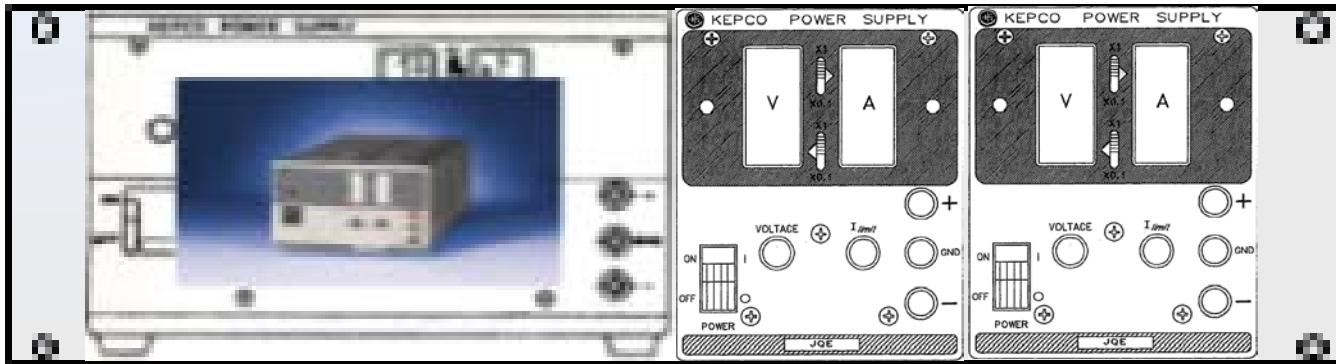

JQE

Front

KEPCO JQE 25-10
+24VDC

KEPCO JQE 15-6
+12VDC

KEPCO JQE 15-6
-12VDC

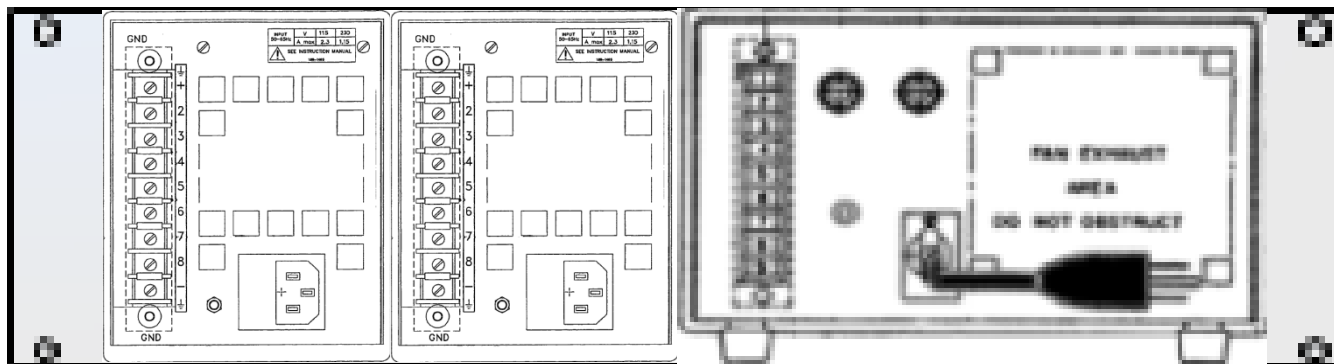

Rear

KEPCO JQE 15-6
H214524

KEPCO JQE 15-6
H214494

KEPCO JQE 25-10
H207953

APC SMT1500RM2U

UPS

APC SMT1500RM2U

A51051111991

110VAC

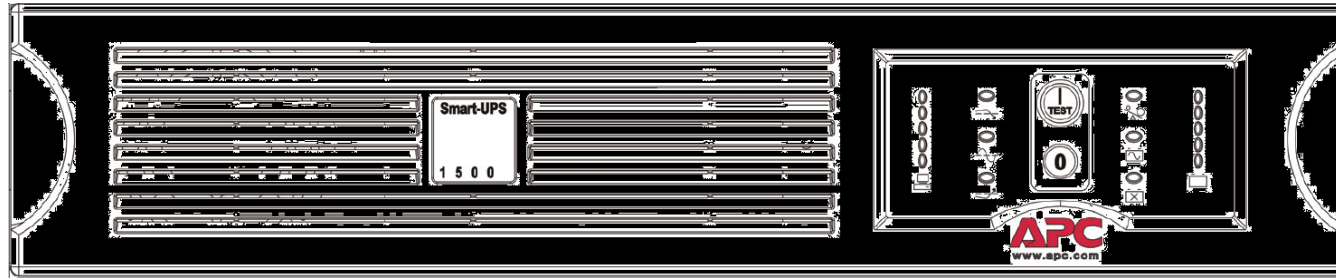

APC SMT1500RM2U

Front

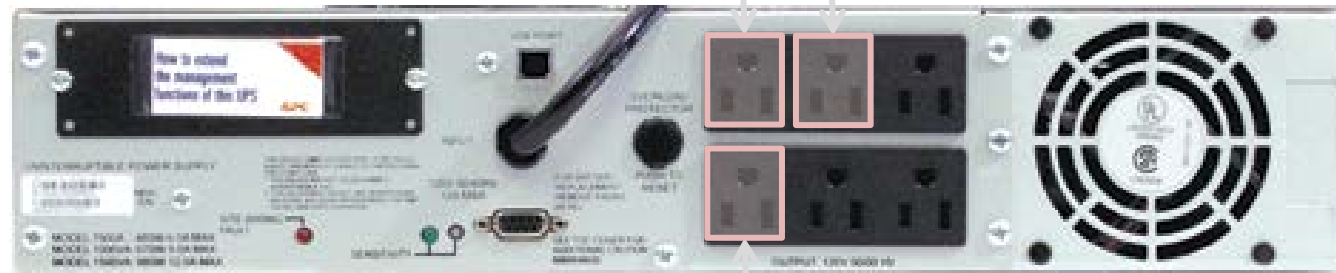

A51051111991

Rear

To 240V PS1

To UPS Power Strip

To 844X 01

1X23 - D070443 - LH02

<< L1-FAC-XC1

Magnetometer: [Bartington Instruments](#)
MAG-03MC



5 meter

Black - G/W ... Ground
Stria - Y/W ... +12VDC

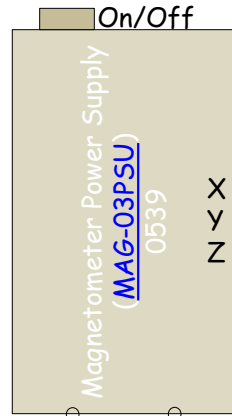

Powered from
12VDC DIN rails

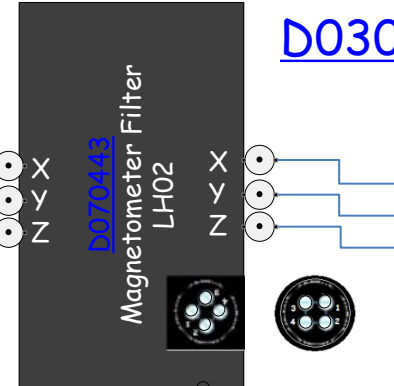
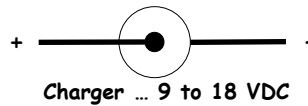

[D030574](#)

Pin 1: +15VDC ... Red/Blk RED
Pin 2: Ground ... Red/Blk BLACK
Pin 3: -15VDC ... Wht/Blk WHITE
Pin 4: Ground ... Wht/Blk BLACK

Powered from
15VDC DIN rails

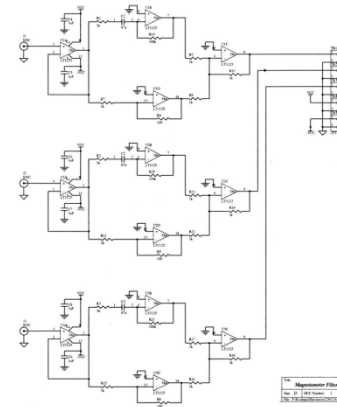

Magnetometer Filter Board

Security Cameras

VT7430-2DRDT
Optical In/Out:
[To 1X23 PP B6](#)
Power: 12VDC
Output: Ch1,
Ch2, Ch3 BNCs
to Cameras

Powered from
Wall Wart from
Isolated Power

Video Master
Power Supply
Model
RT24/16500
Outputs to
Cameras 1,2,3

Note: 6 LEDs
are on.

AC Powered
from Isolated
Power

L1-ISC-XC1

L1-ISC-XC1 X-End Remote Rack Layout ([D1201084](#)) ([S1202948](#))

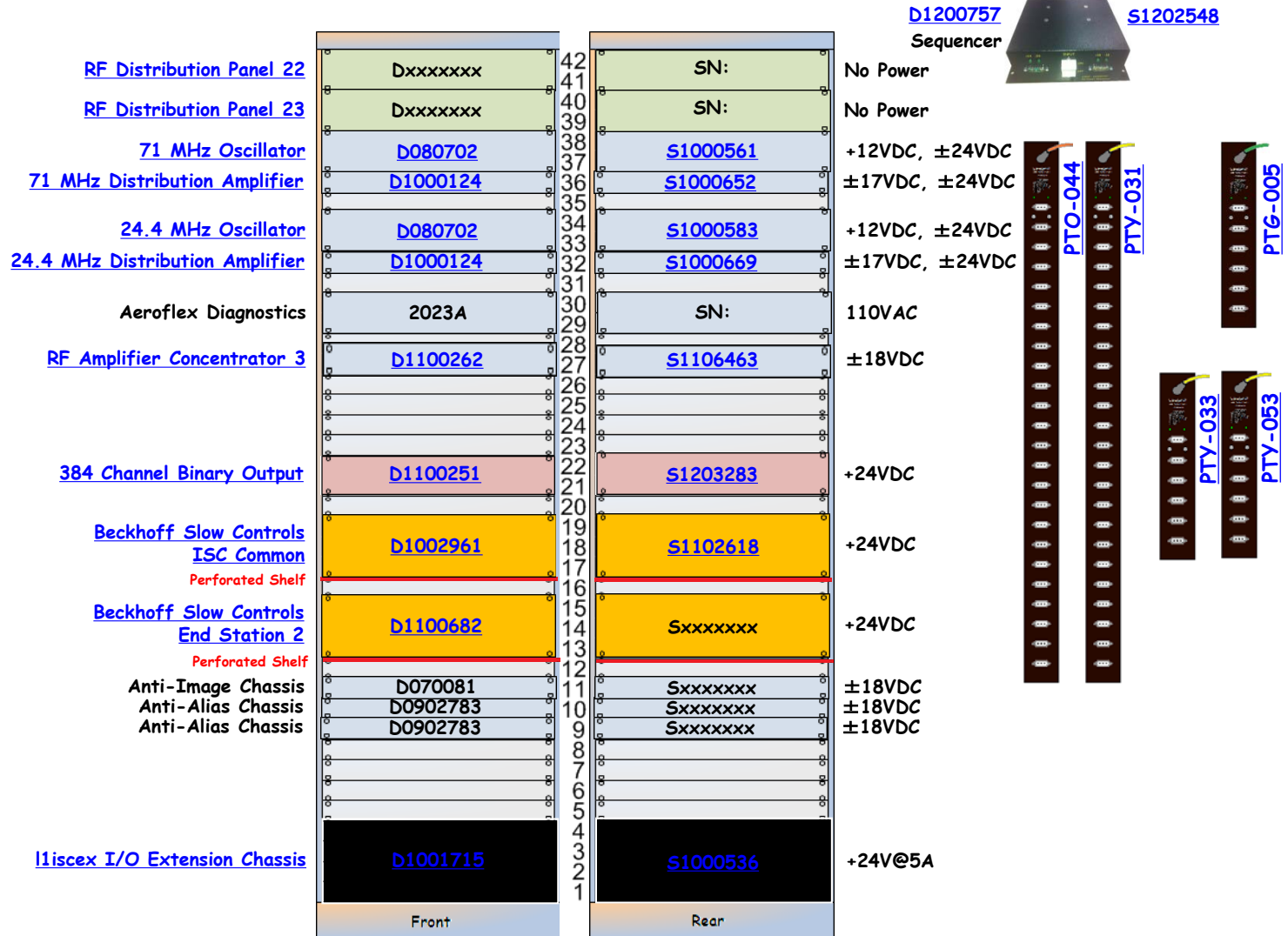

ISC-XC1 is part of [D1001459](#)

L1-ISC-XC1 Details

RF Patch Panel 22

RF Patch Panel 22

Dxxxxxxx

Sxxxxxxx

No Power

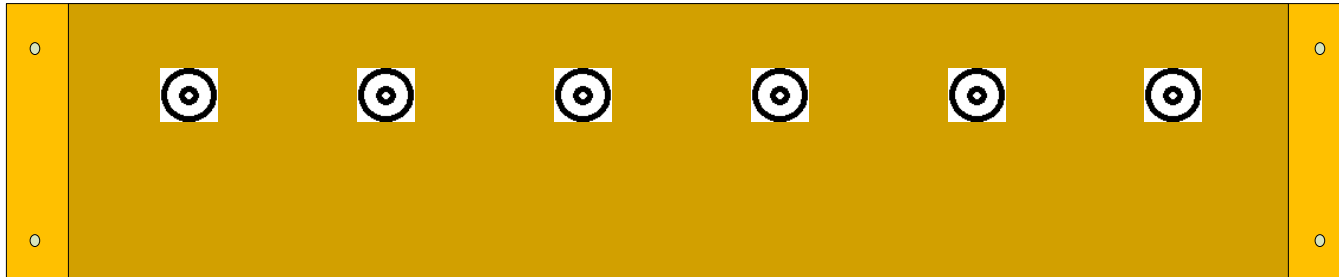

Dxxxxxxx

Front

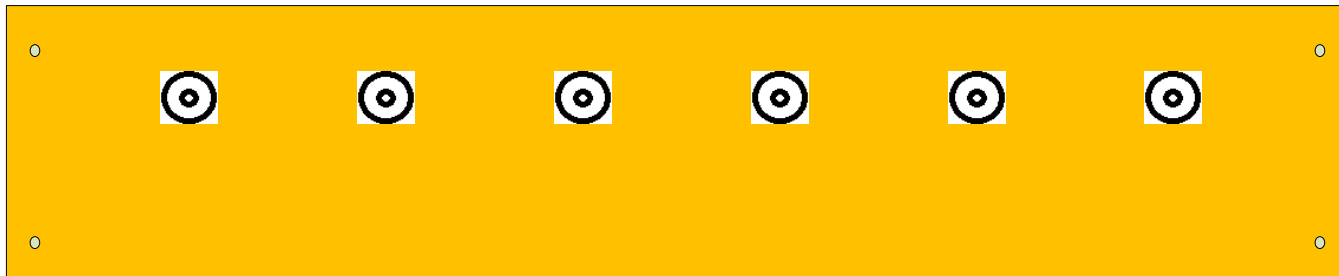

Sxxxxxxx

Rear

RF Patch Panel 23

RF Patch Panel 23

Dxxxxxxx

Sxxxxxxx

No Power

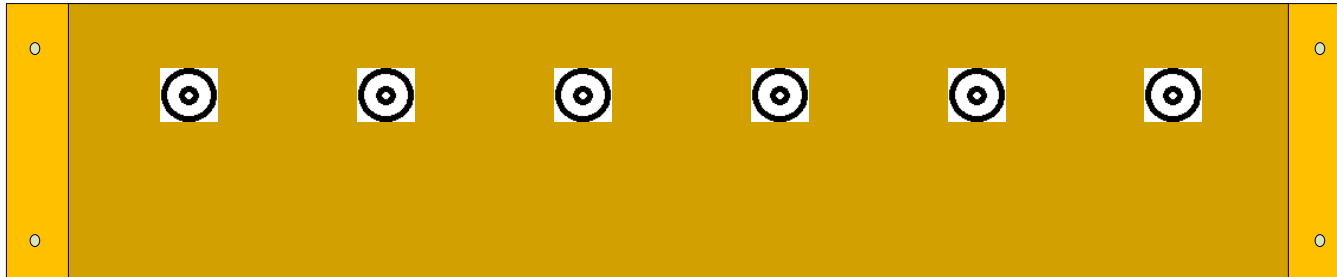

Dxxxxxxx

Front

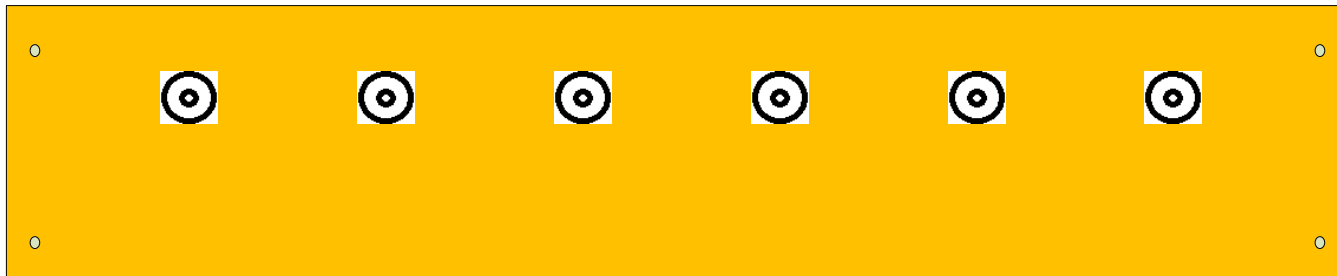

Sxxxxxxx

Rear

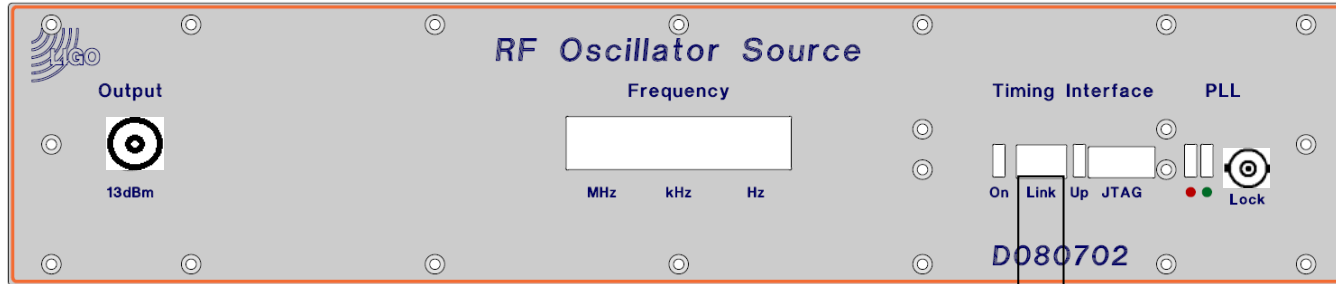

D080702

Front

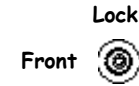

To ...

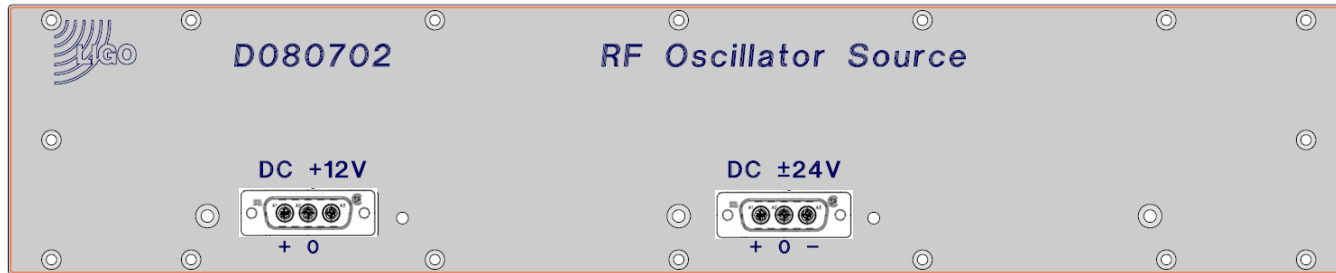

S1000561

Rear

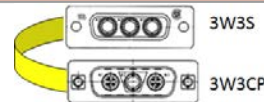

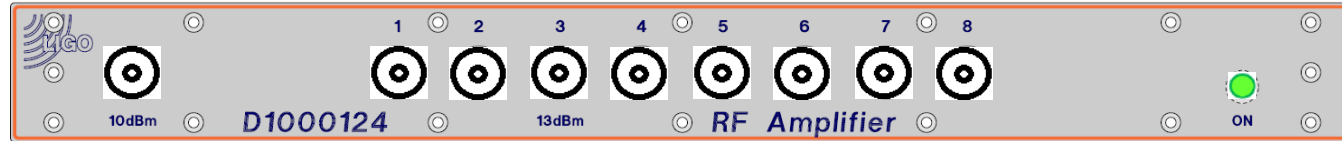

D1000124

Front

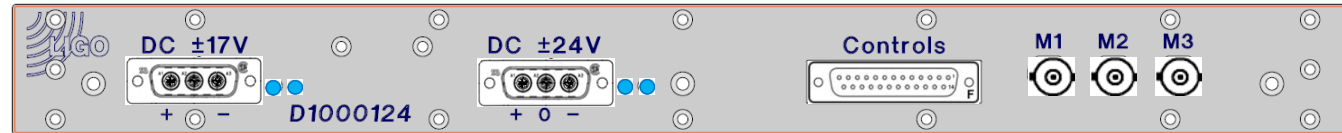
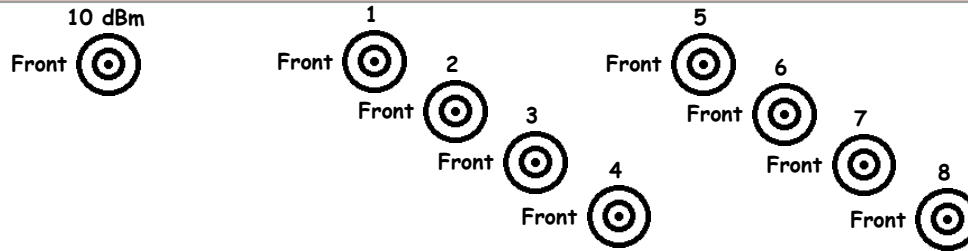

S1000652

Rear

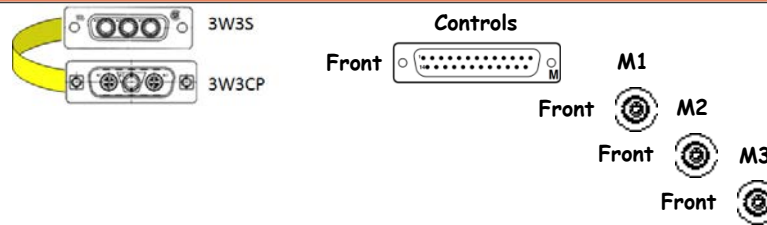

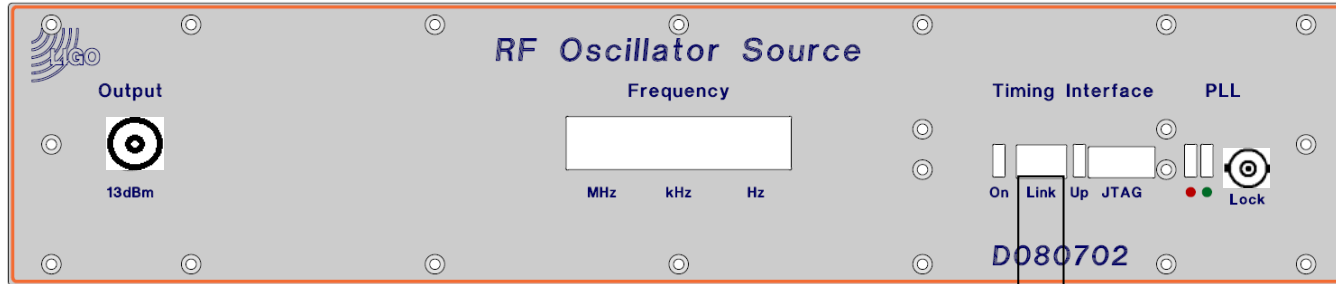

D080702

Front

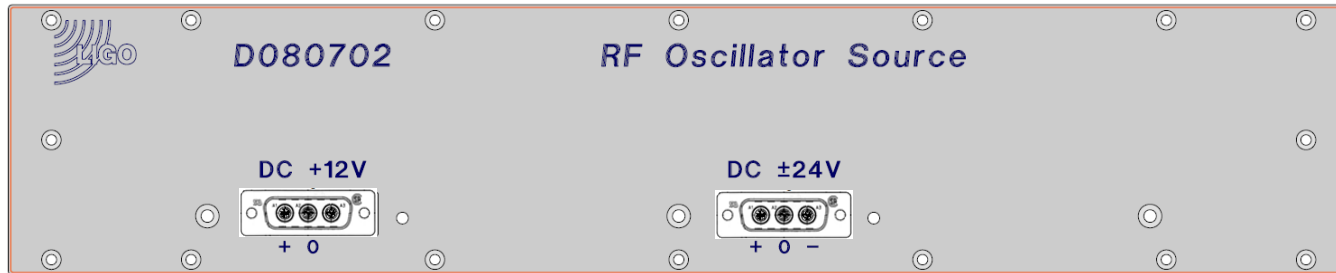
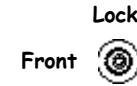
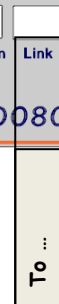

S1000583

Rear

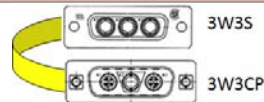

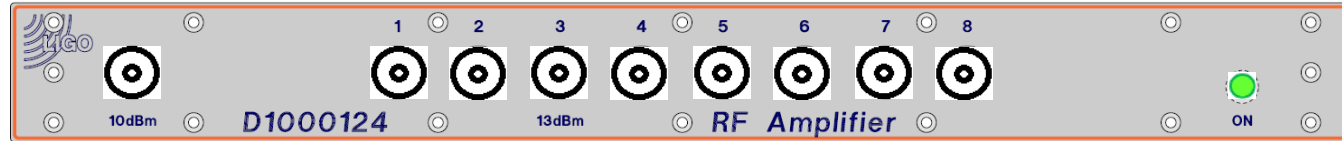

D1000124

Front

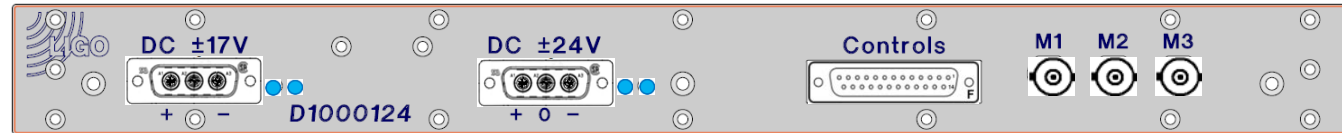
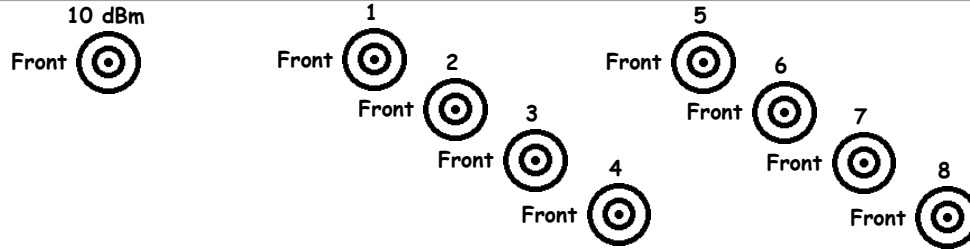

S1000669

Rear

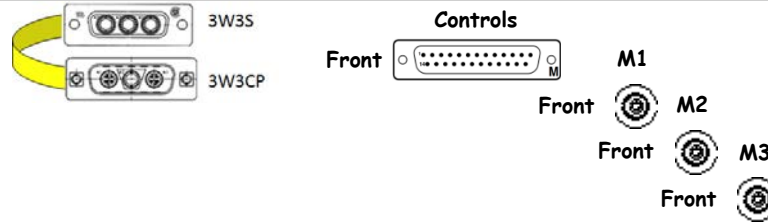

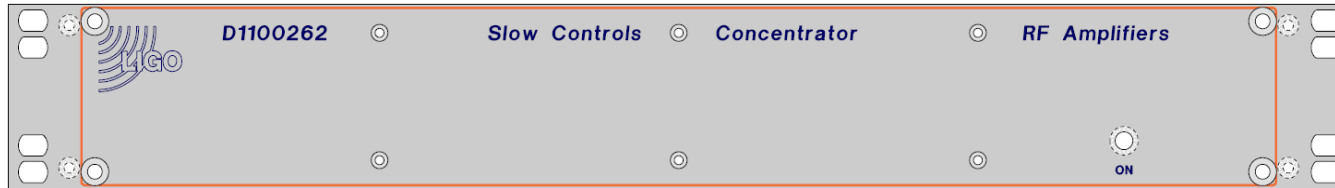

D1100262

Front

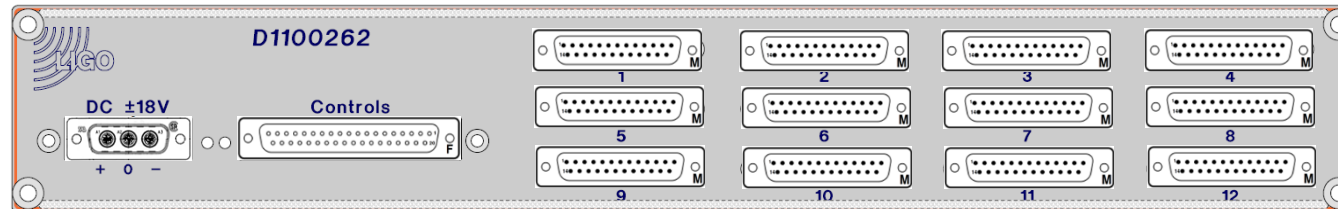

S1106463

Rear

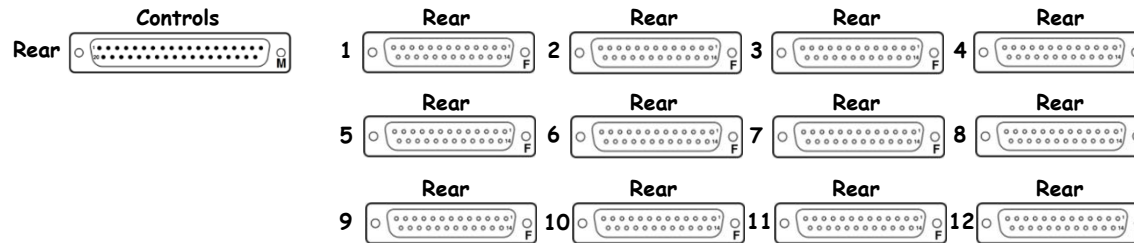

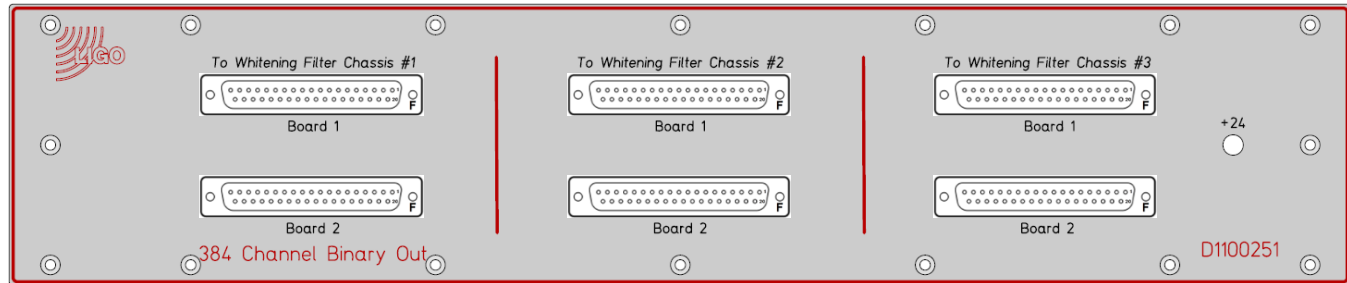

D1100251

Front

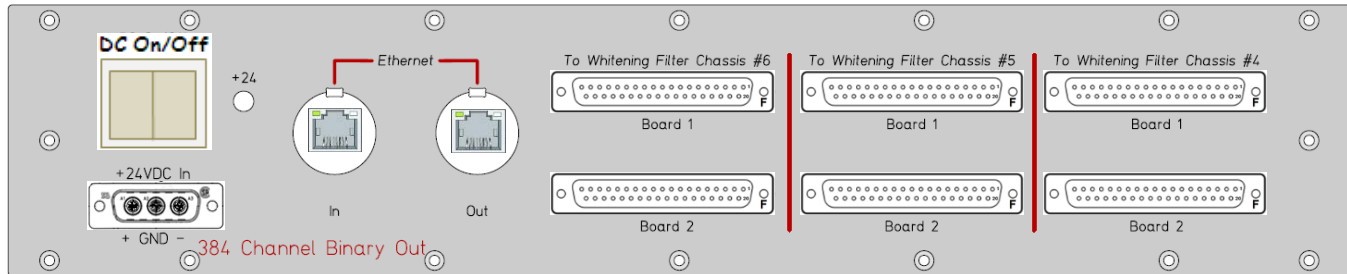
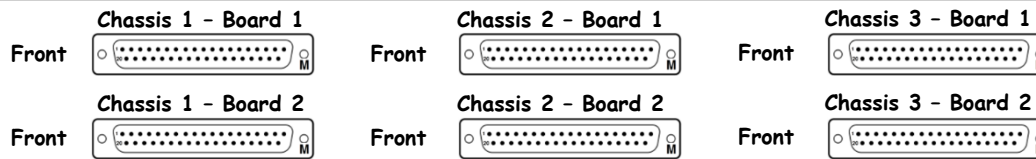

S1203283

Rear

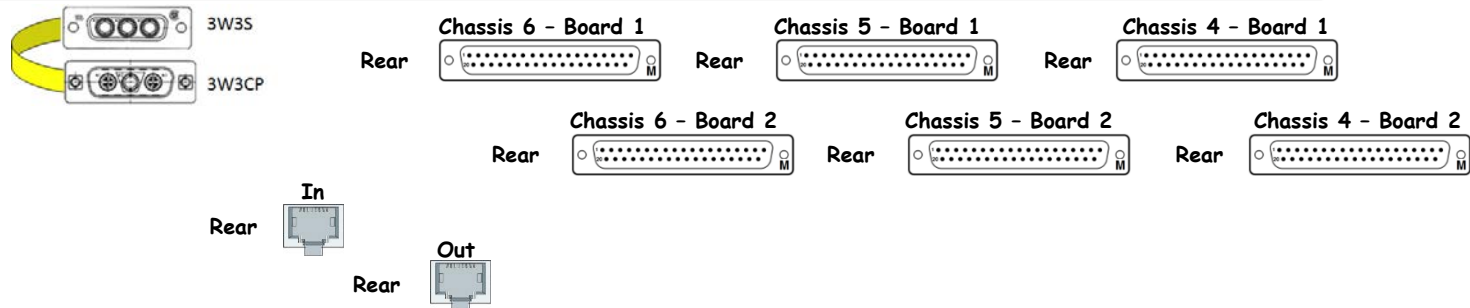

<< L1-ISC-XC1

Beckhoff Slow Controls
ISC Common

D1002961

S1102618

+24VDC

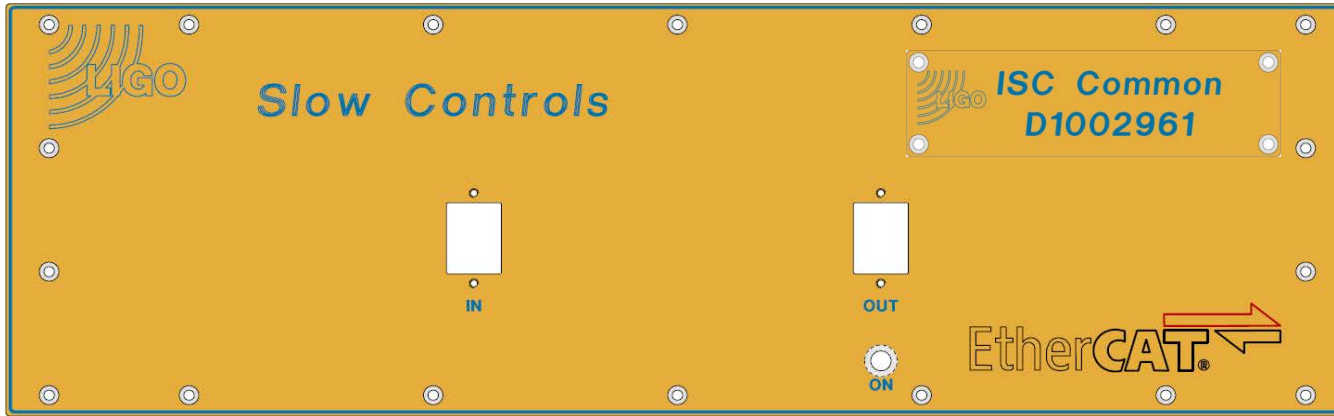

D1002961

Front: D0902553

Name: D1002962

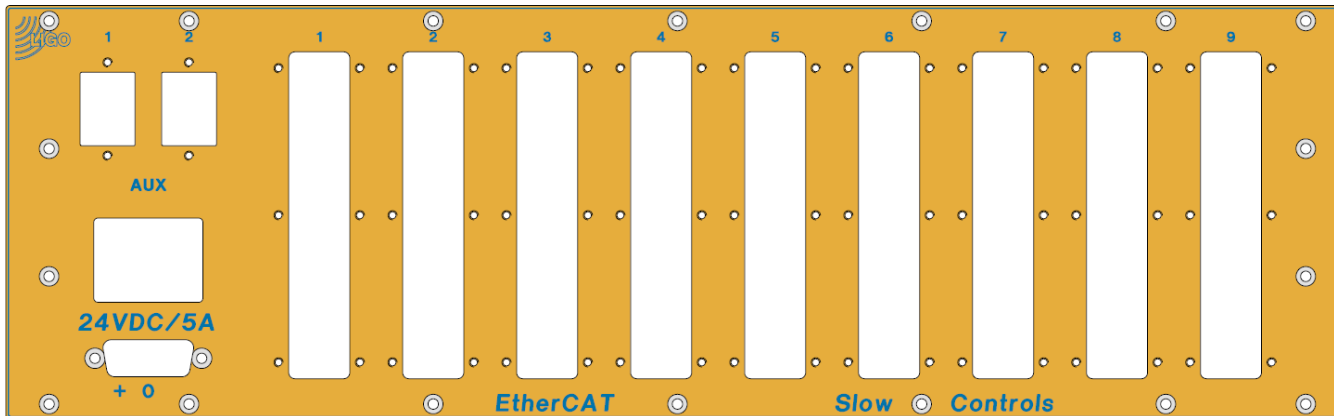

S1102618

Rear: D0902554

<< L1-ISC-XC1

Beckhoff Slow Controls
End Station 2

D1100682

Sxxxxxxx

+24VDC

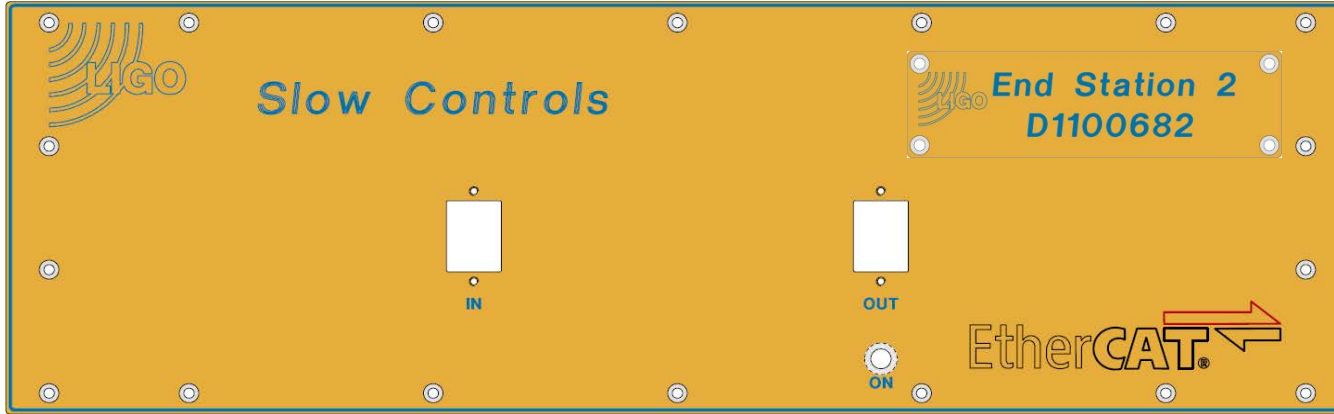

D1100682

Front: D0902553

Name: D1101978

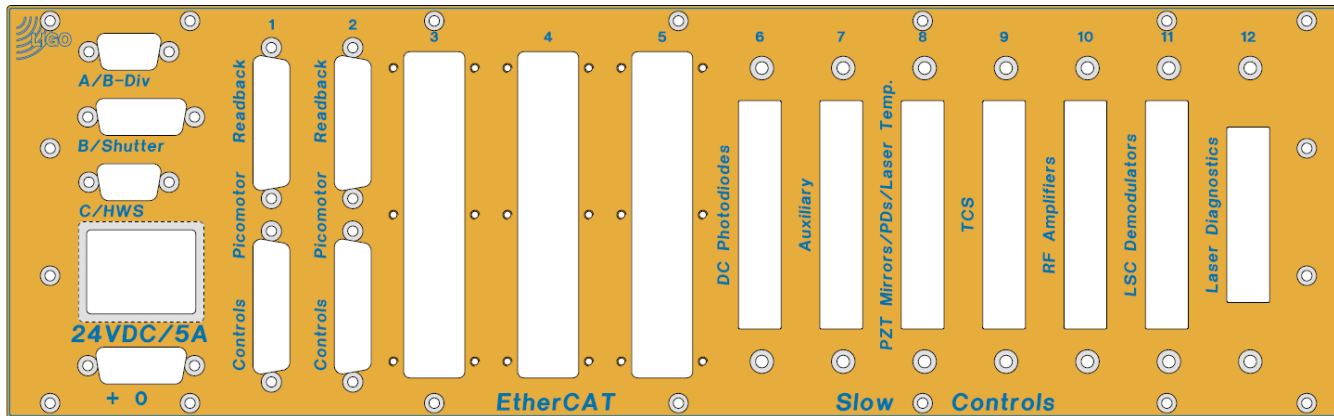

Sxxxxxxx

Rear: D1101977

l1iscex - D1001715 - S1000536

l1iscex I/O Extension Chassis

D1001715

S1000536

110VAC



D1001715

Front

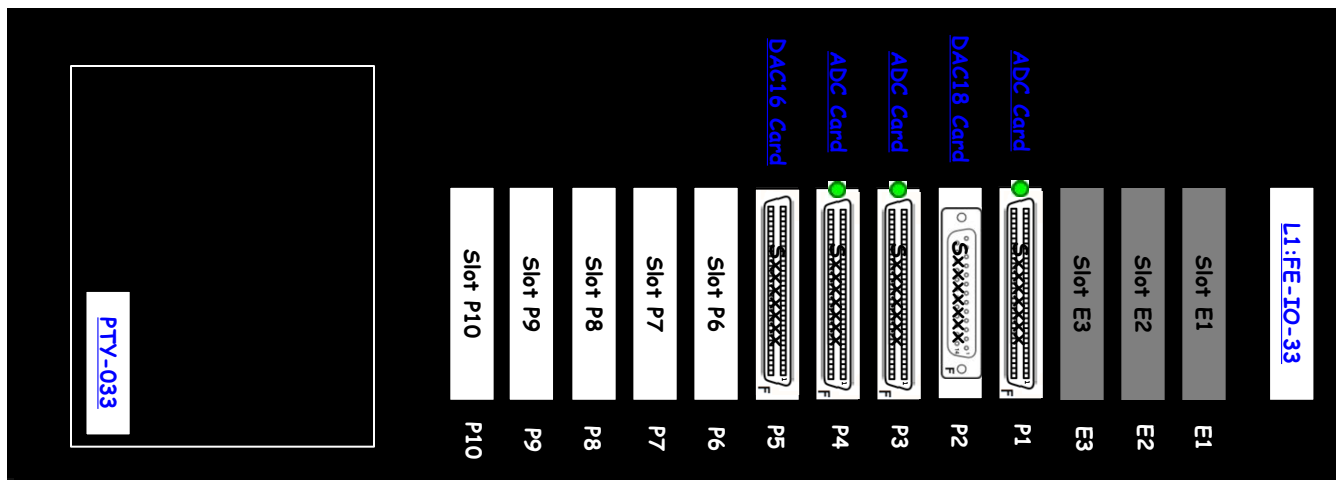

S1000536

Rear

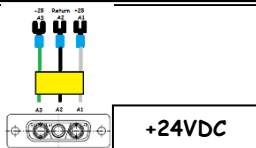
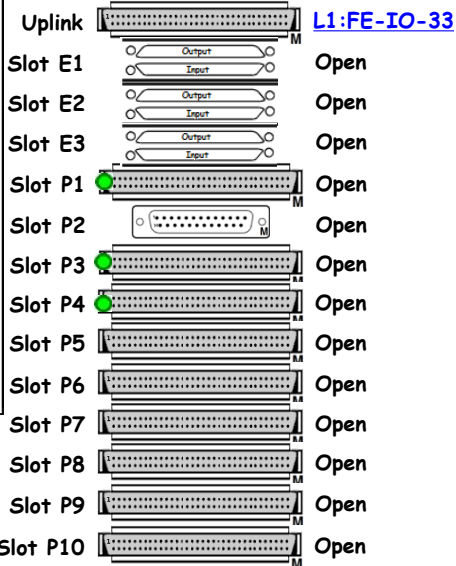

L1-SEI-XC1

L1-SEI-XC1 (BSC4) X-End Remote Rack 1 Layout (D1201081) (S1202945)

BSC4 ISI Interface Chassis Pod 1	D1002432	42	S1203884	±18VDC
BSC4 ISI Interface Chassis Pod 2	D1002432	41	S1203885	±18VDC
BSC4 ISI Interface Chassis Pod 3	D1002432	40	S1203886	±18VDC
		39		
		38		
		37		
BSC4 ISI AA Chassis	D1002693	36	S1203106	Power
BSC4 ISI AA Chassis	D1002693	35	S1203107	Power
		34		
BSC4 ISI AA Chassis	D1002693	33	S1203109	Power
		32		
BCS4 HEPI AA Chassis	D1000272	31	S1203333	Power
BCS4 HEPI AI Chassis	D1100202	30	S1203137	Power
		29		
BSC4 8 Channel Valve Driver	D0900117	28	S0900289	Power
		27		
64 Channel Binary Input Chassis (8*DB9)	D1001726	26	S1101306	±18VDC
64 Channel Binary Input Chassis (8*DB9)	D1001726	25	S1101307	±18VDC
64 Channel Binary Output Chassis (8*DB9)	D1001728	24	S1101321	±18VDC
		23		
		22		
Trillium 240 Interface Chassis Pod 1	D1002964	21	S1201405	±18VDC
Trillium 240 Interface Chassis Pod 2	D1002964	20	S1201406	±18VDC
Trillium 240 Interface Chassis Pod 3	D1002964	19	S1201407	±18VDC
		18		
STS-2 Distribution Chassis	D0900351	17	S0900133	±18VDC
STS-2 Interface Chassis	D080535	16	S0900105	±18VDC
		15		
		14		
1seiex I/O Extension Chassis	D1001715	13	S1201774	+24VDC
		12		
		11		
		10		
Anti-Image Chassis (4*DB9)	D1000305	9	S1300612	±18VDC
		8		
BSC4 ISI Coil Driver Pod 1	D0902744	7	S1103314	±24VDC
BSC4 ISI Coil Driver Pod 2	D0902744	6	S1103336	±24VDC
BSC4 ISI Coil Driver Pod 3	D0902744	5	S1103362	±24VDC
		4		
		3		
		2		
		1		

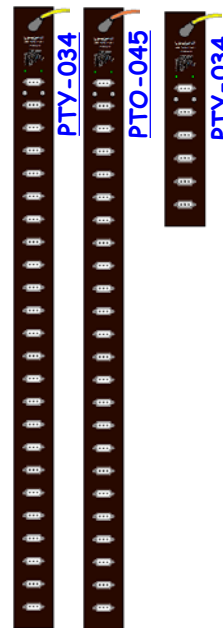

SEI-XC1 is part of [D0901301](#)

Front

Rear

L1-SEI-XC1 Details

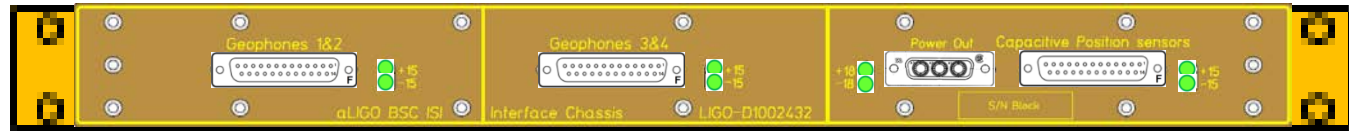

[D1002432](#)

Front

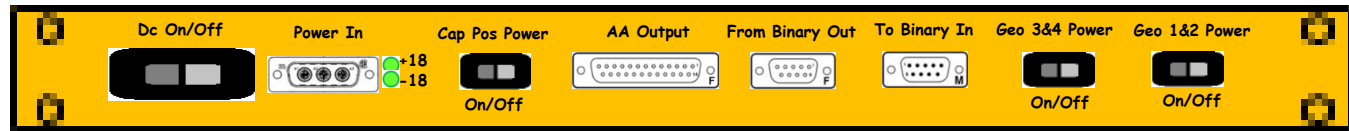
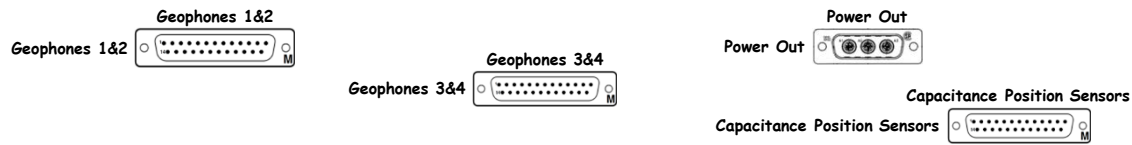

[S1203884](#)

Rear

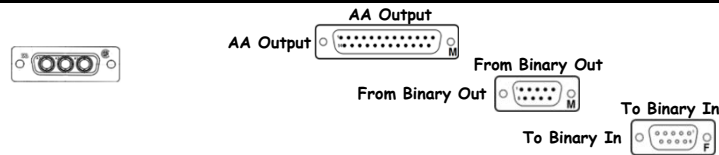

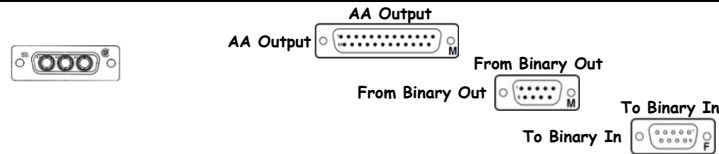
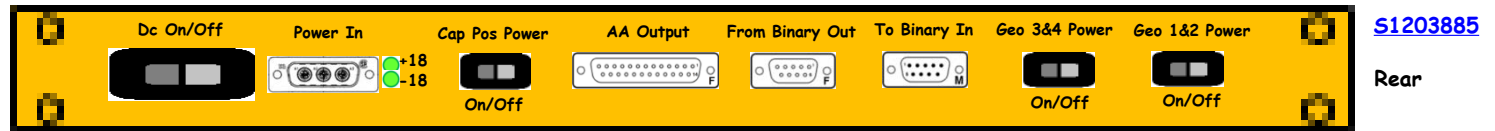
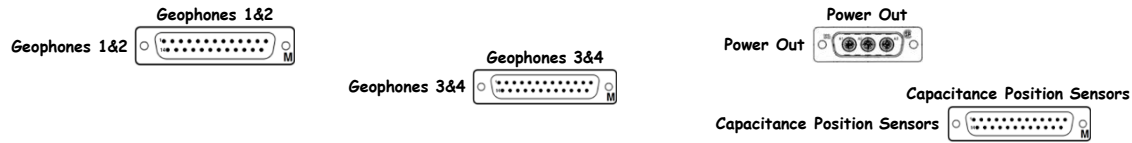
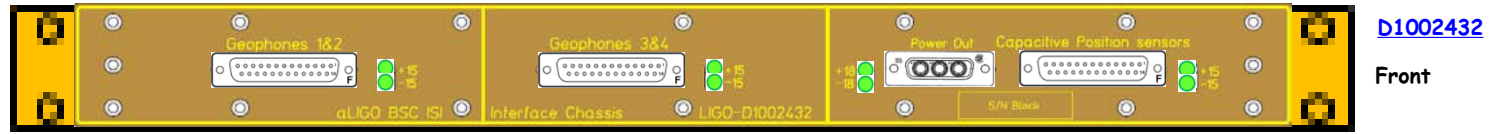

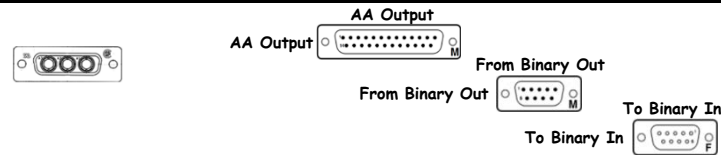
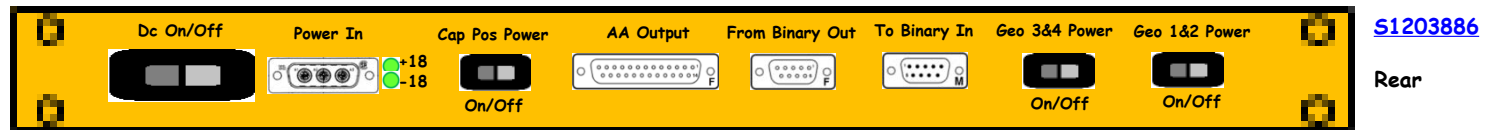
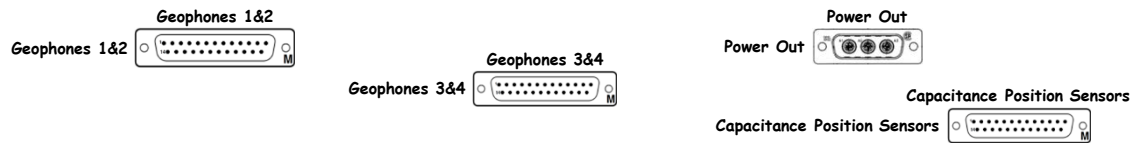
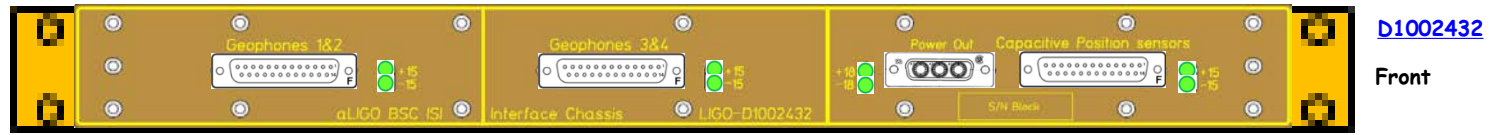

D1002693 - S1203106



<< L1-SEI-XC1

BSC4 ISI AA Chassis Pod 3

D1002693

S1203106

Power

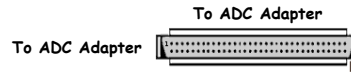
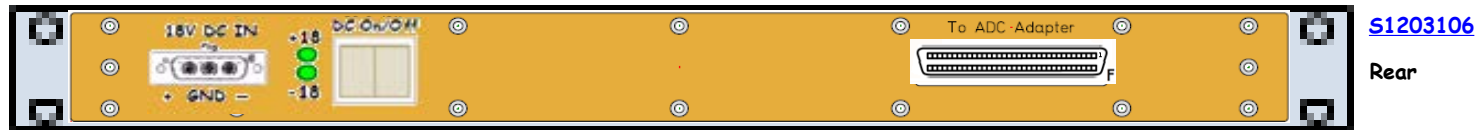
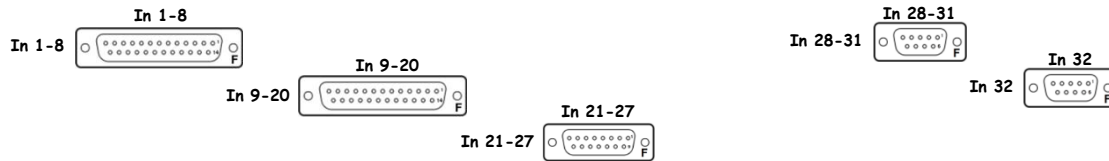
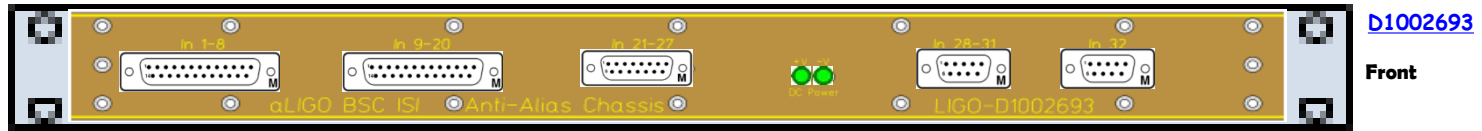

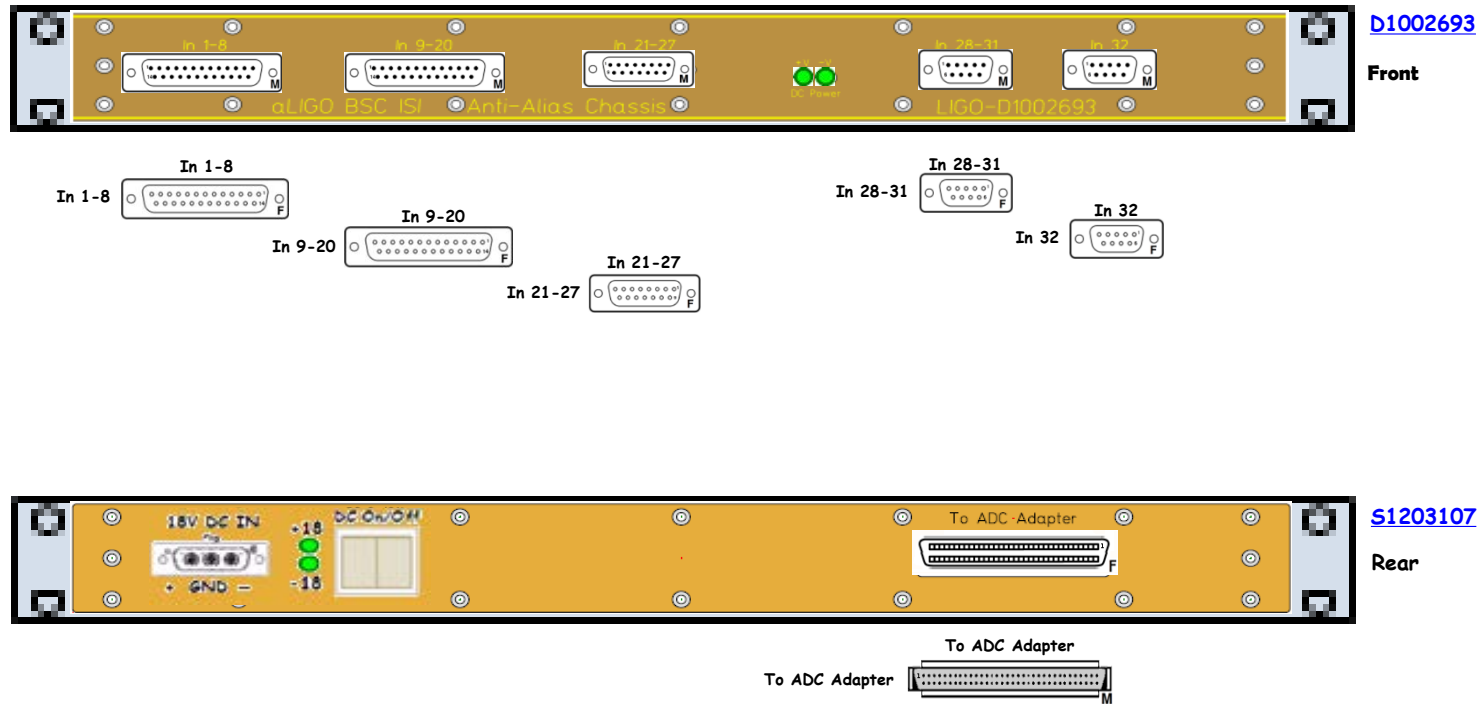

D1002693 - S1203109

BSC4 ISI AA Chassis Pod 3 D1002693 S1203109 Power

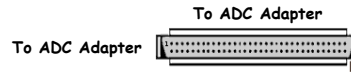
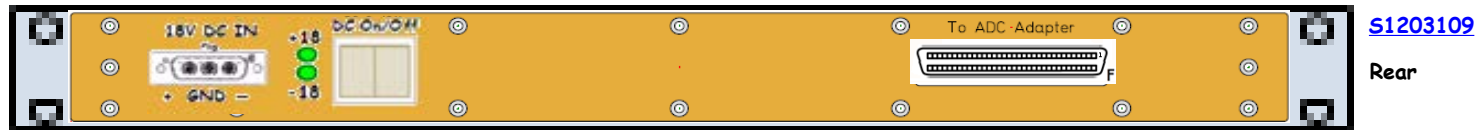
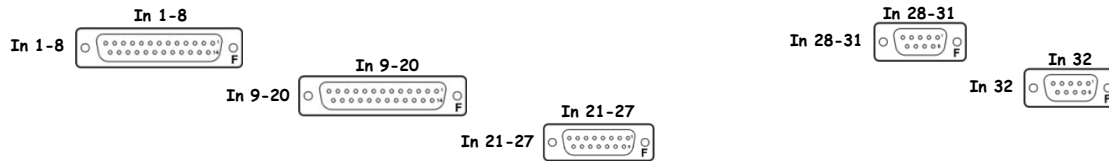
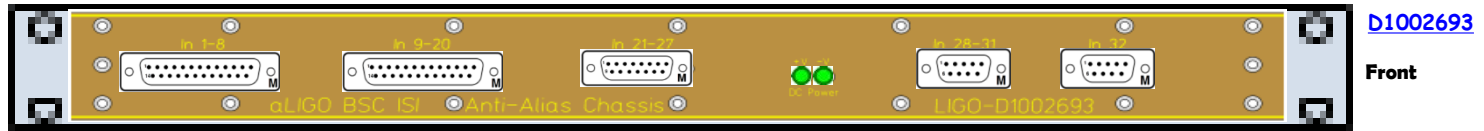

D1000272 - S1203333

BSC4 HEPI AA Chassis Pod 3 D1000272 S1203333 Power

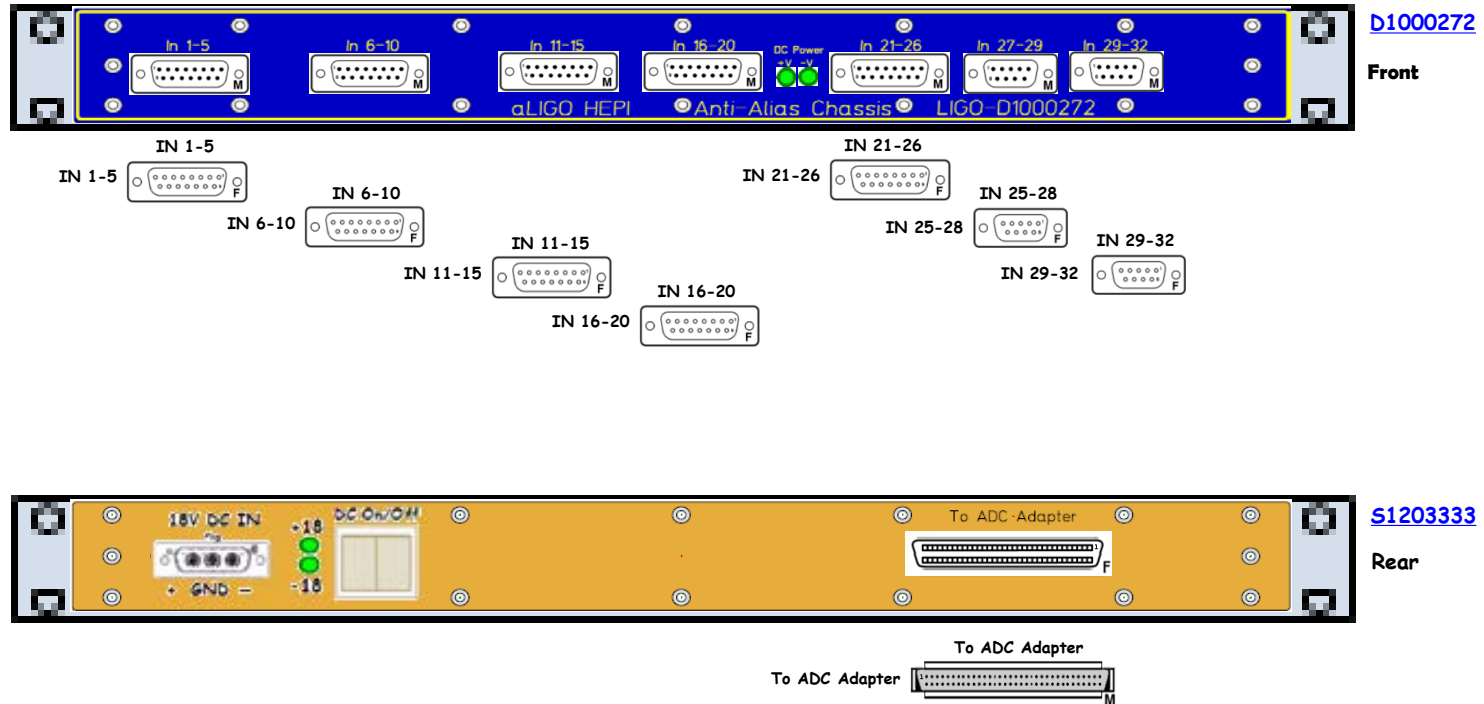

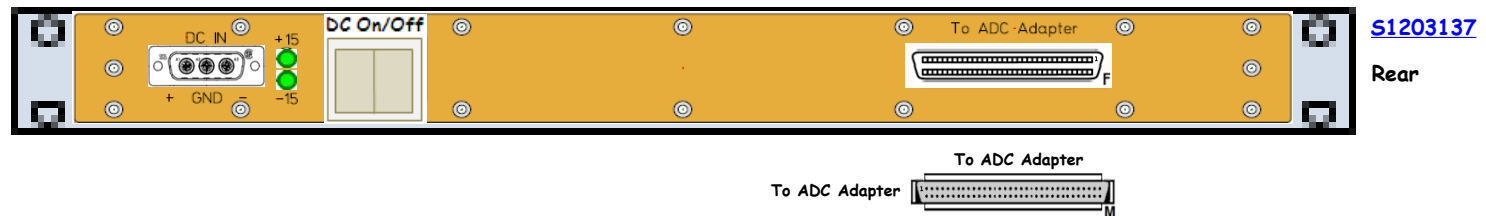
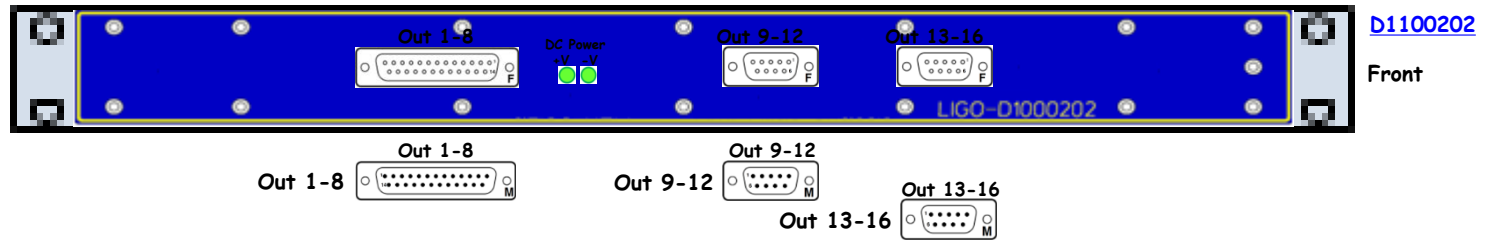

<< L1-SEI-XC1

BSC4 8 Channel Valve Driver

D0900117

S0900289

Power

BSC4

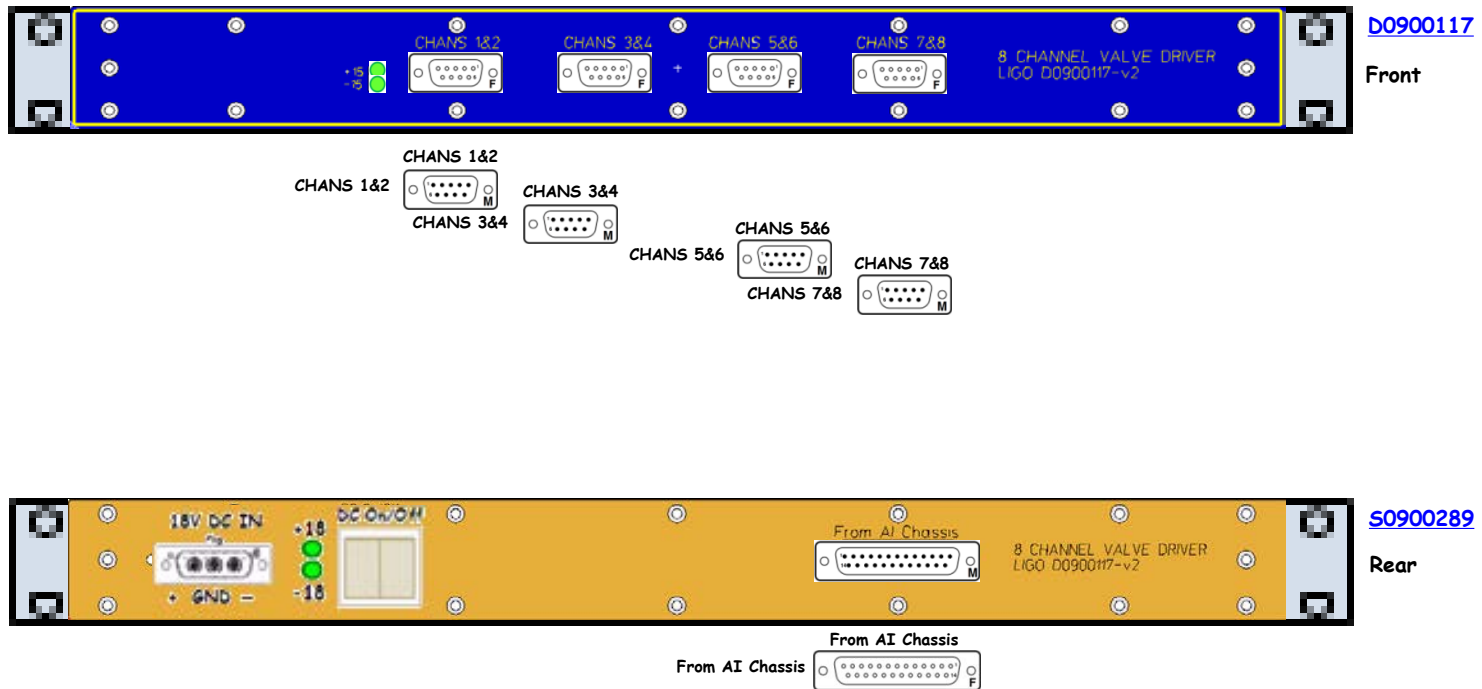

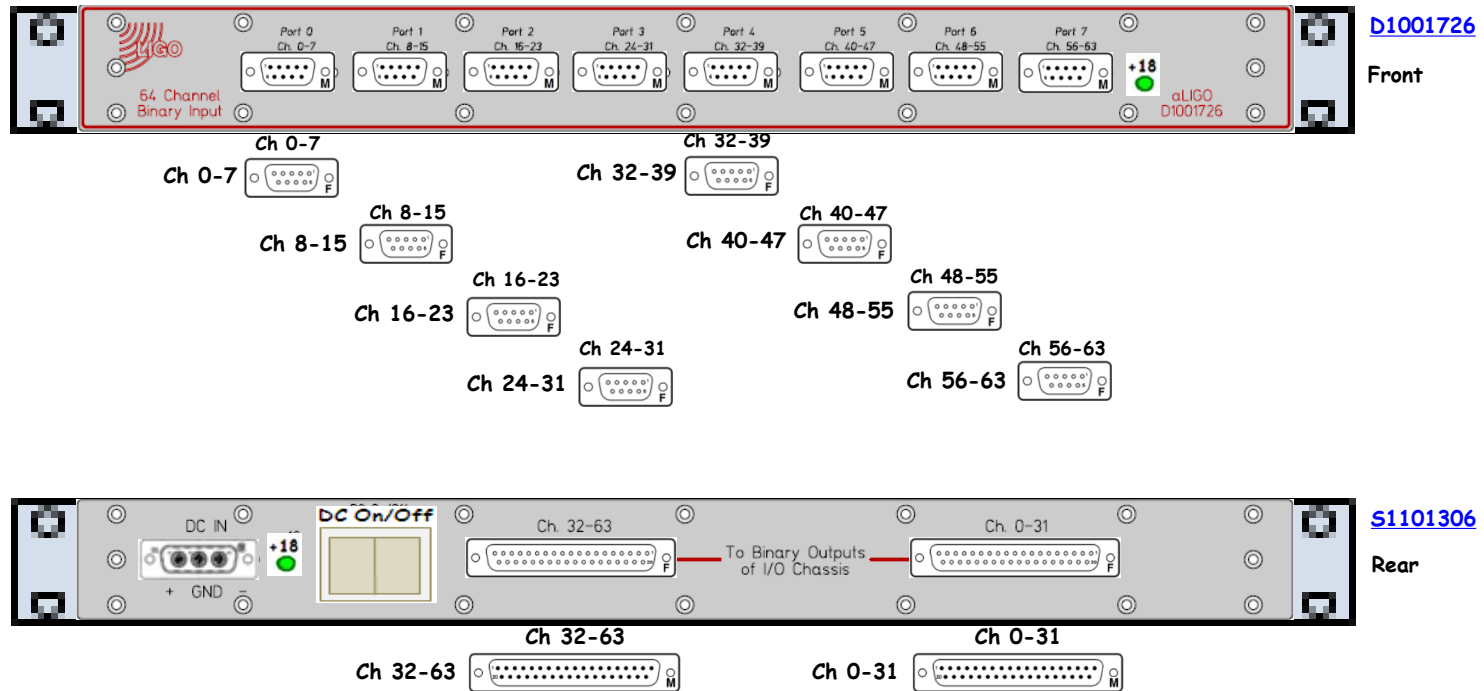

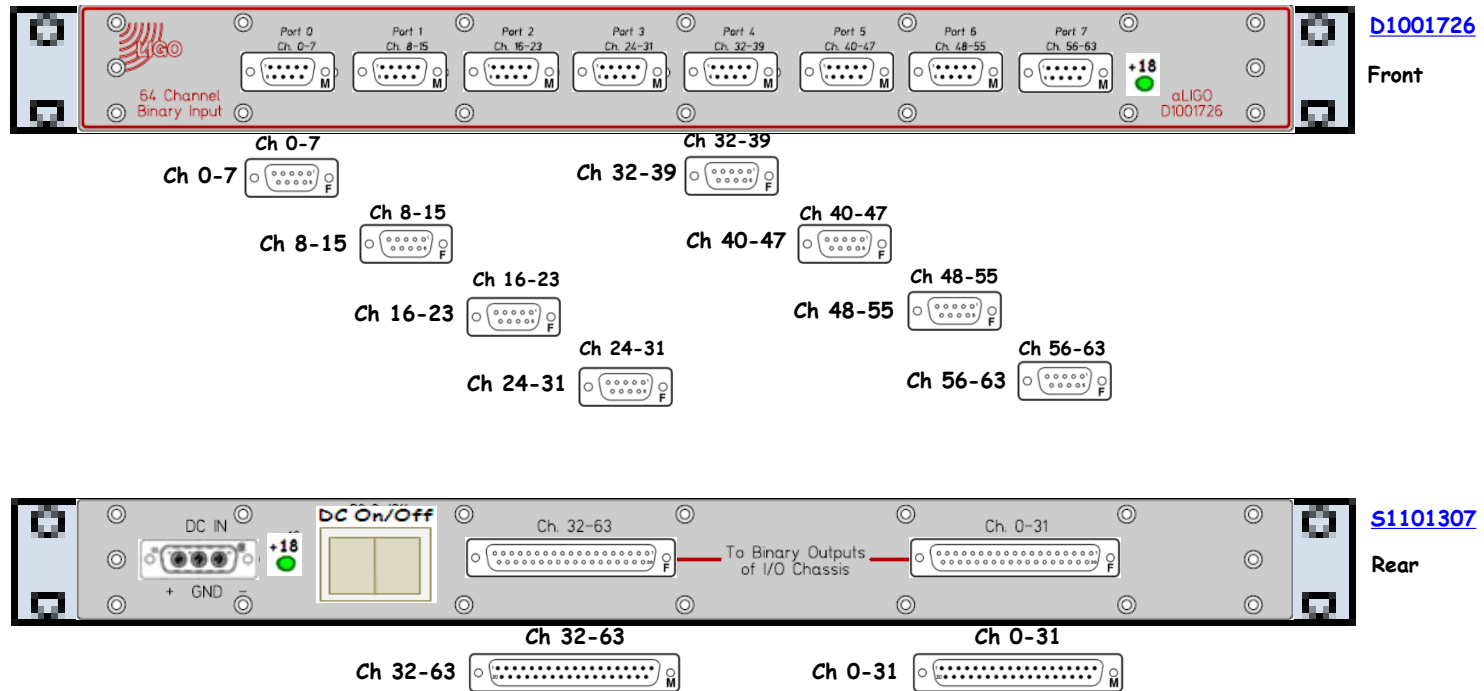

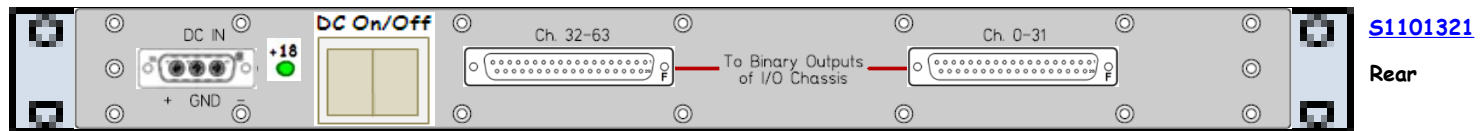
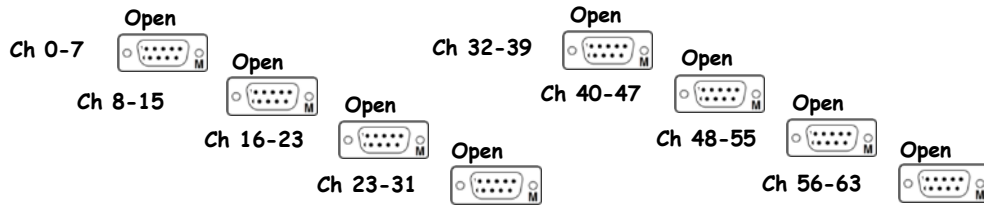
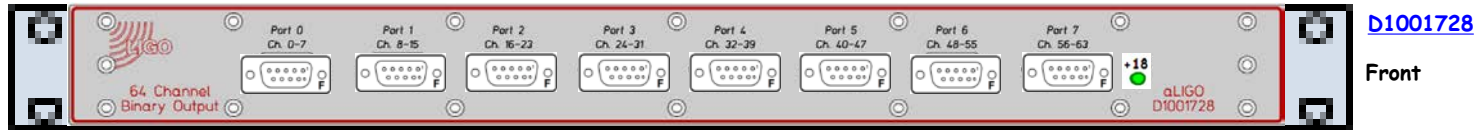

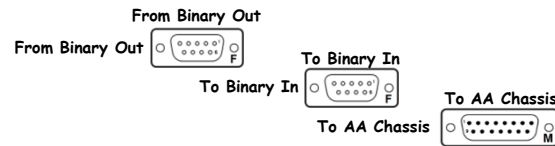
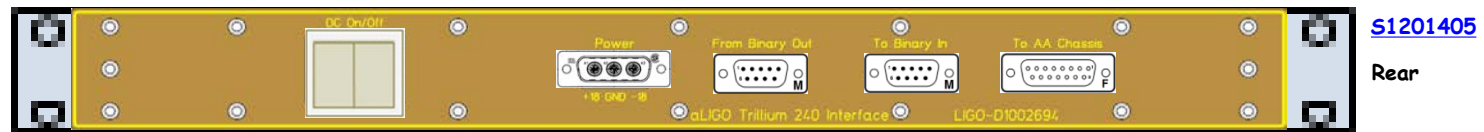

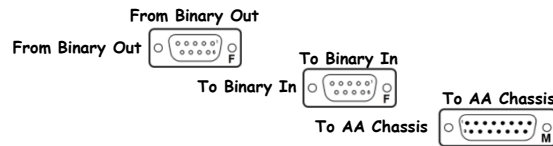
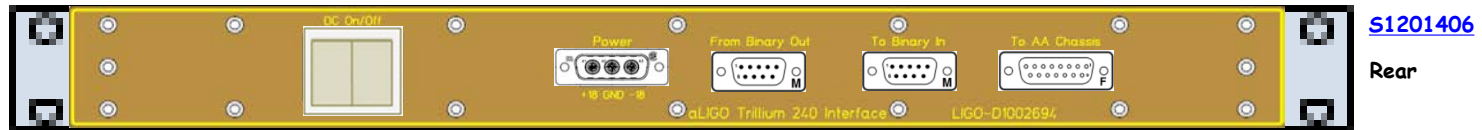

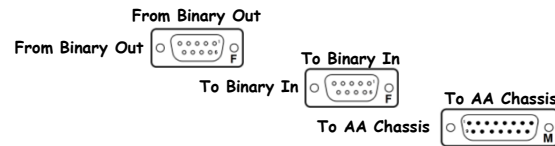
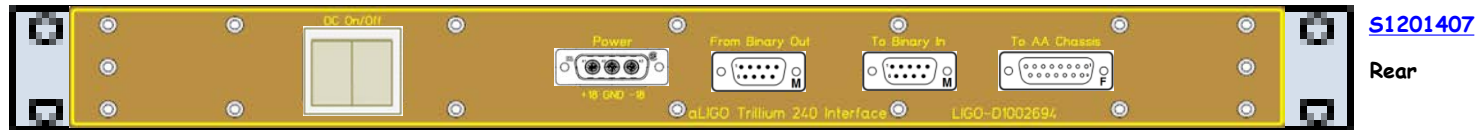

STS-2 Distribution Chassis D0900351 S0900133 ±18VDC

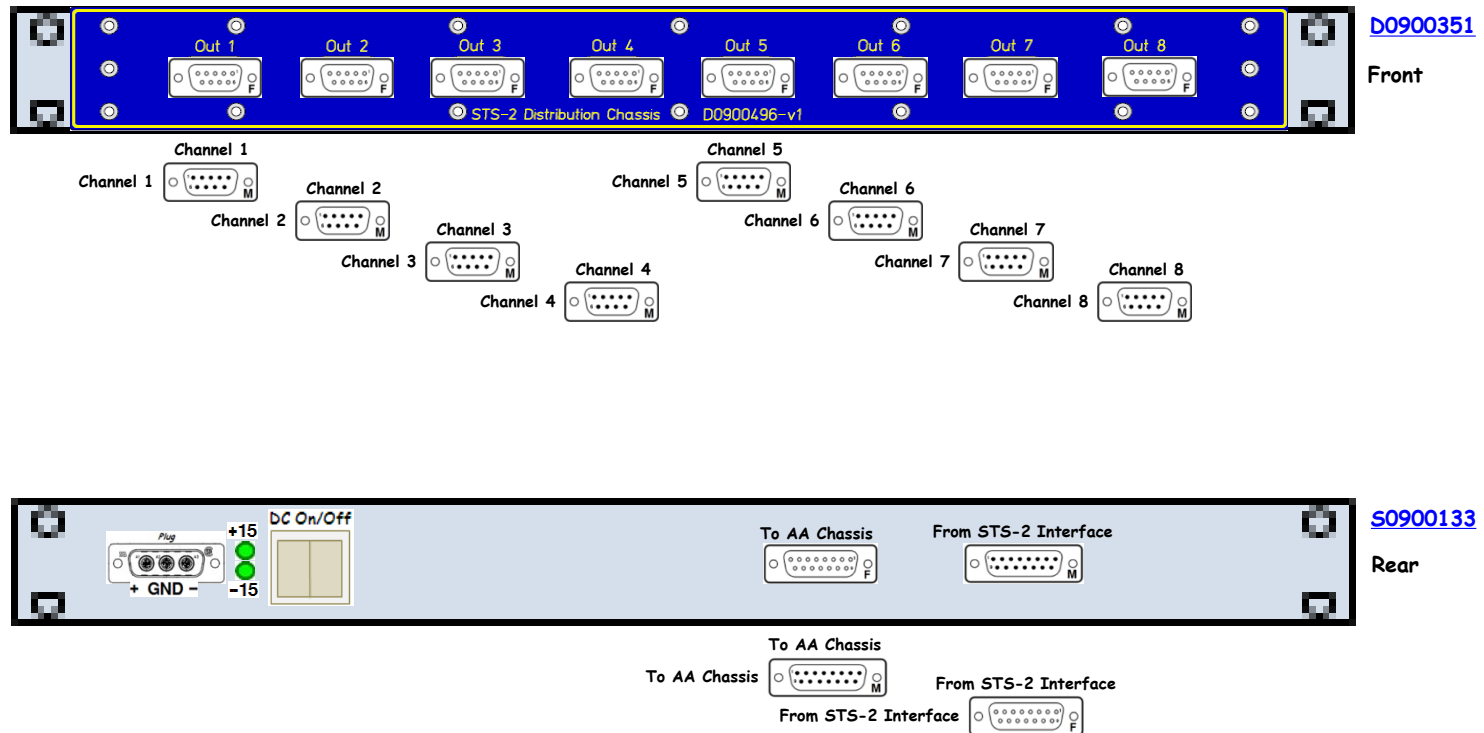

<< L1-SEI-XC1

STS-2 Interface Chassis

D080535

S0900105

±18VDC

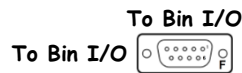
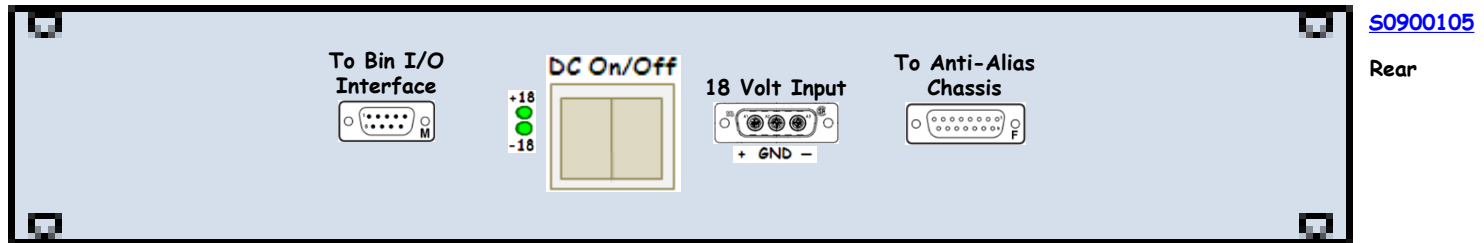
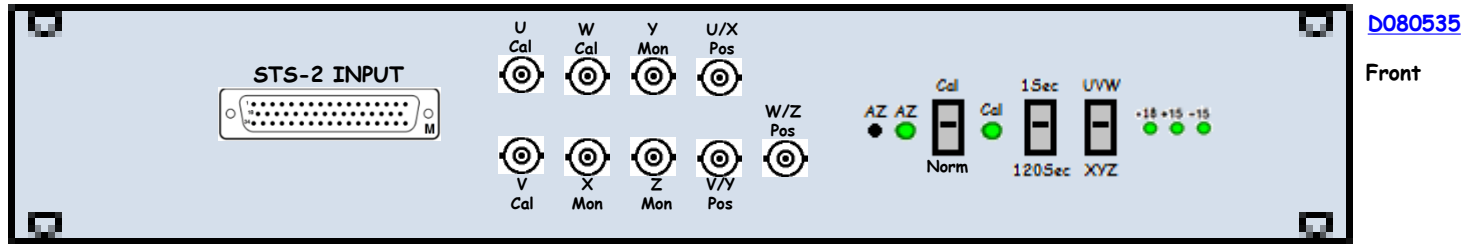



[D1001715](#)

Front

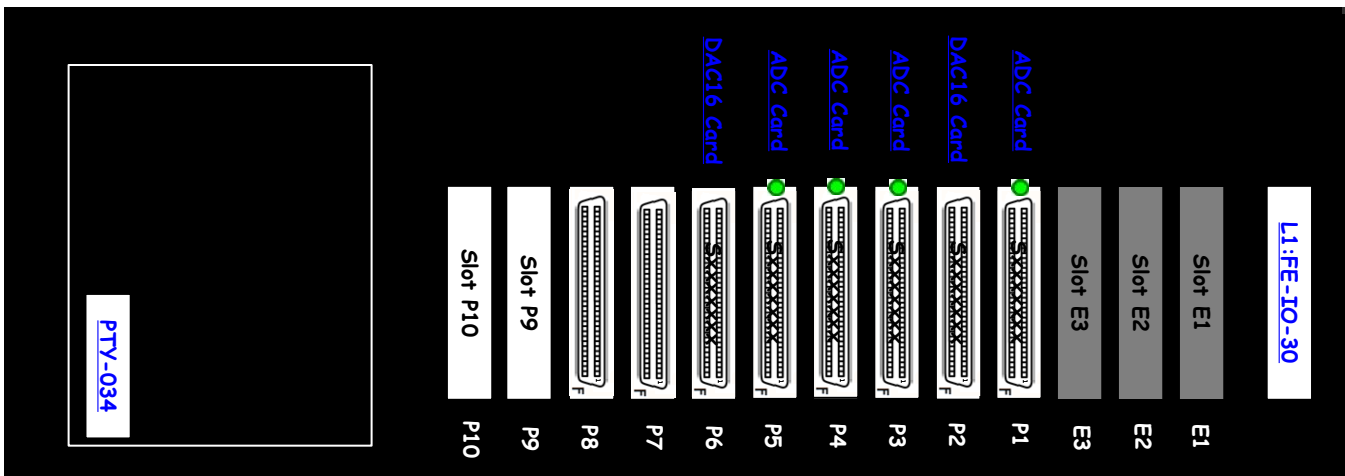

[S1201774](#)

Rear

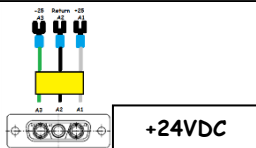
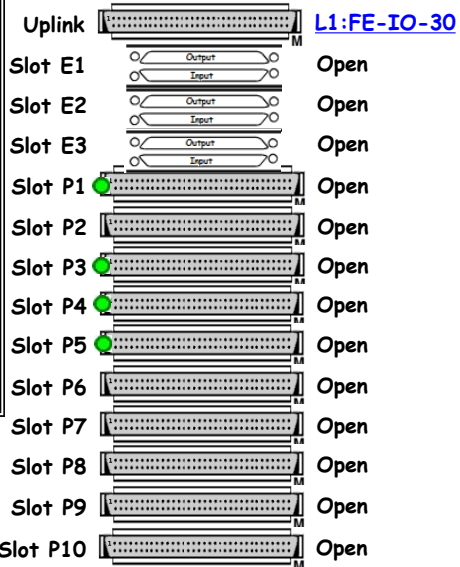

D1000305 - S1300612



<< L1-SEI-XC1

Anti-Image Chassis (4*DB9) D1000305 S1300612 ±18VDC

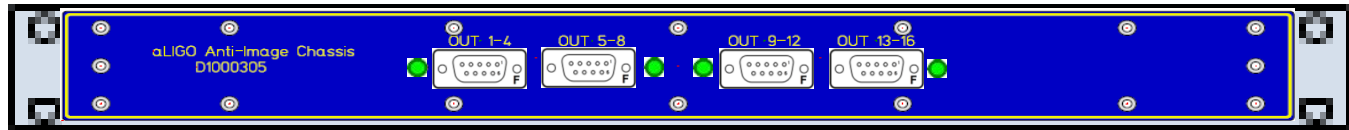

[D1000305](#)

Front

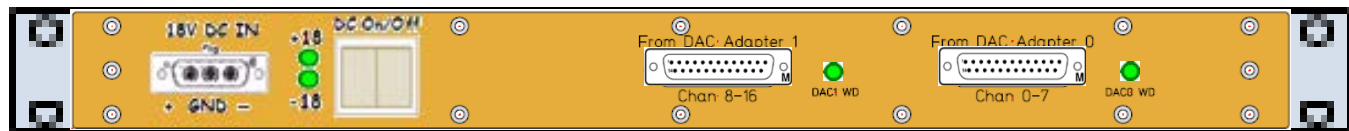
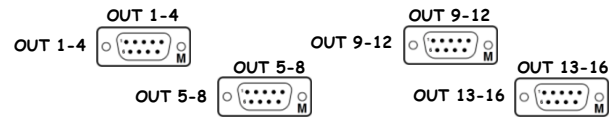

[S1300612](#)

Rear

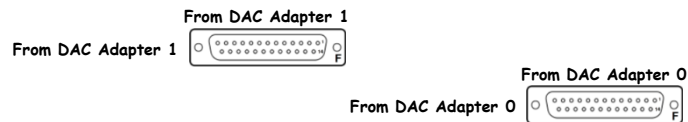

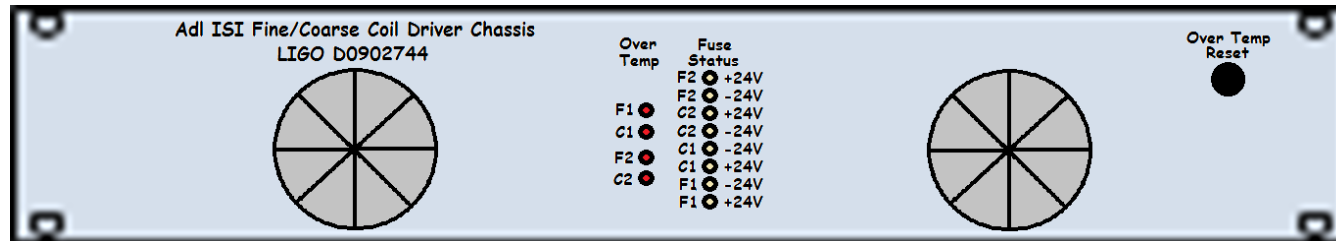

D0902744

Front

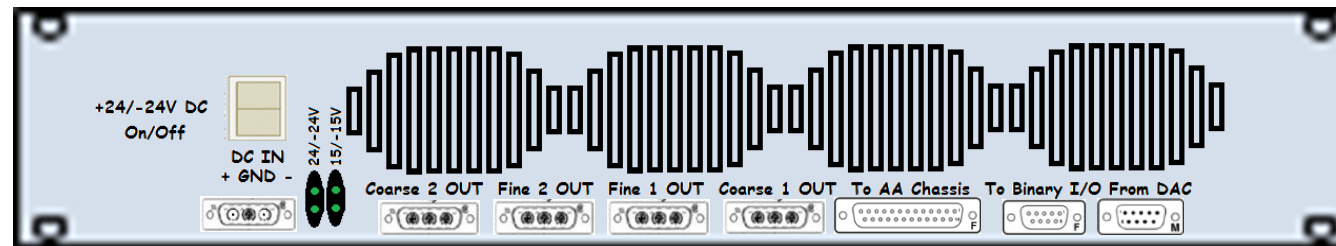

S1103314

Rear

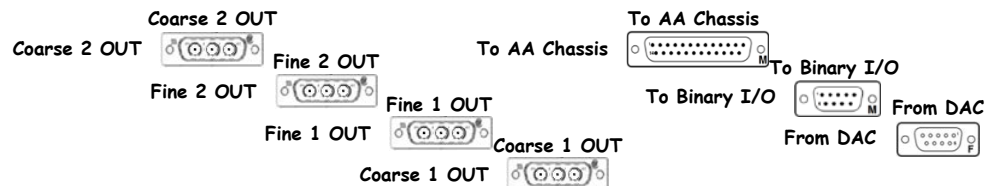

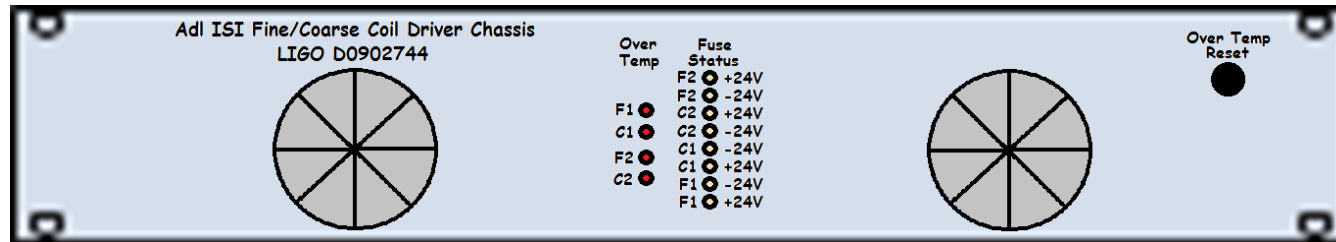

D0902744

Front

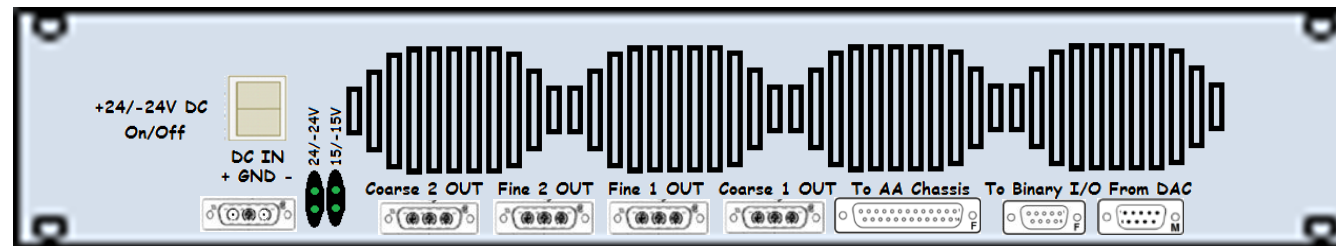

S1103336

Rear

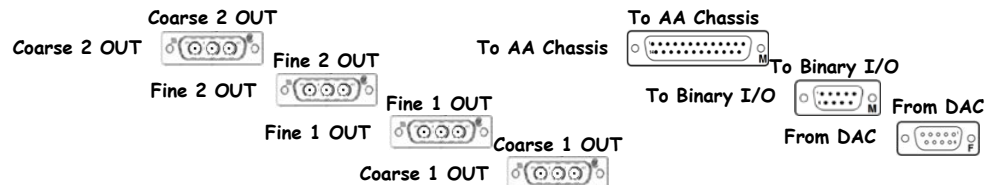

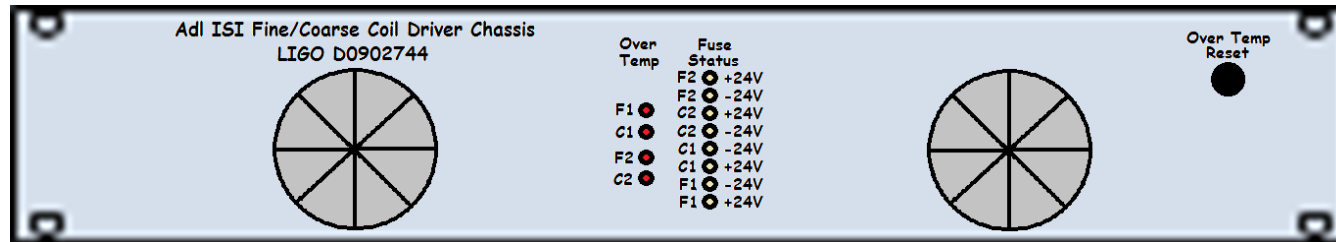

D0902744

Front

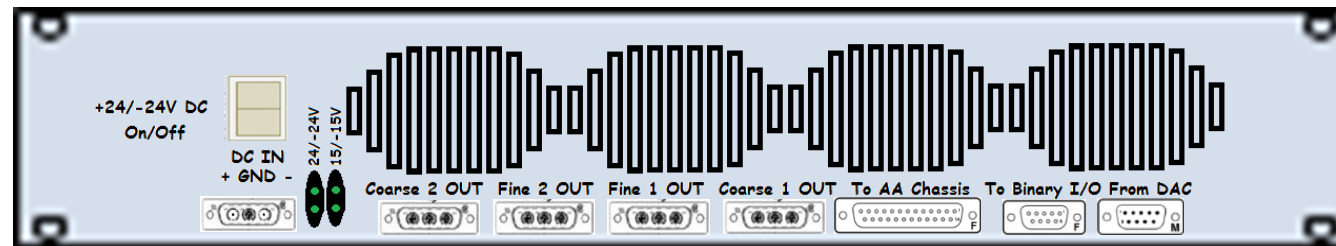

S1103362

Rear

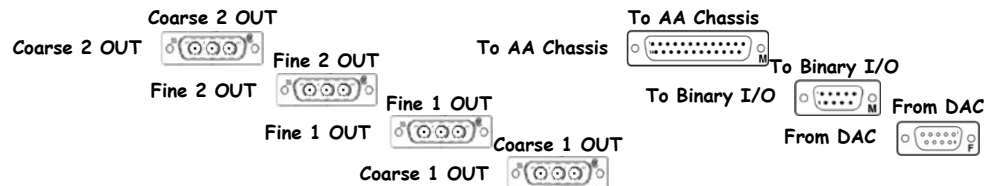

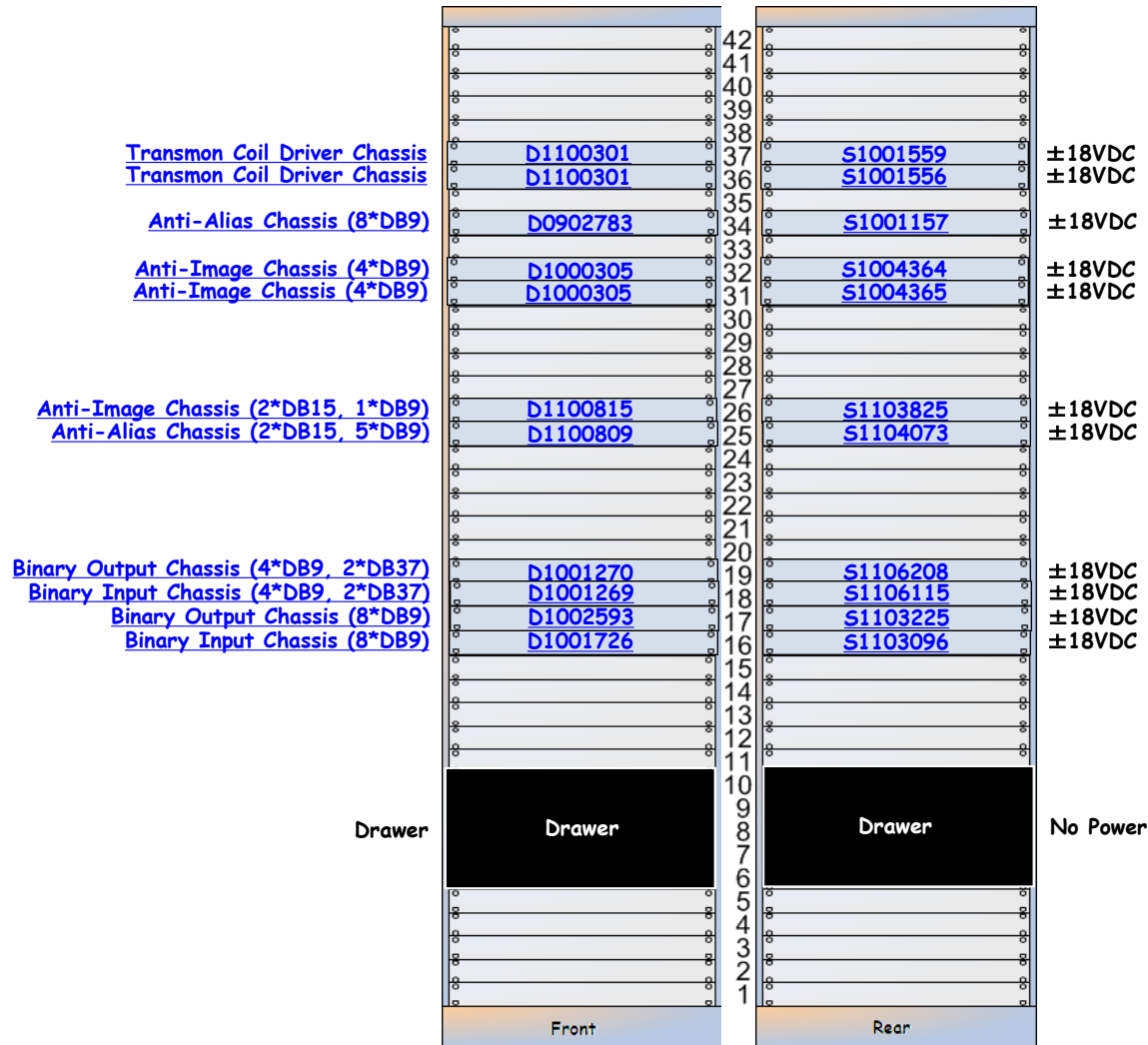

PTO-043

L1-SUS-XC1 Details

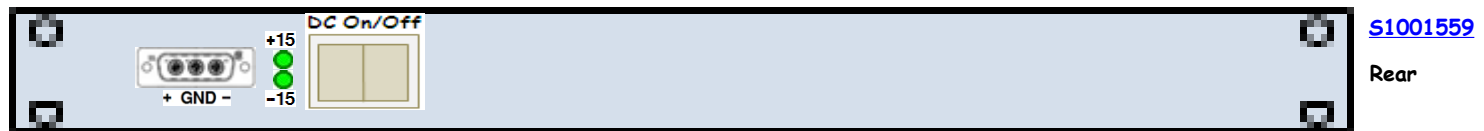
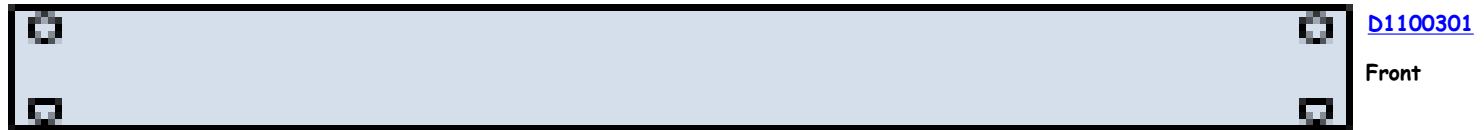

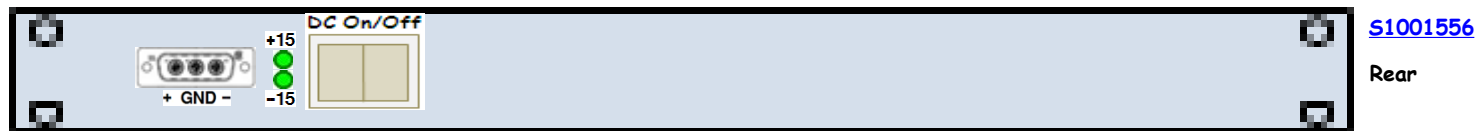
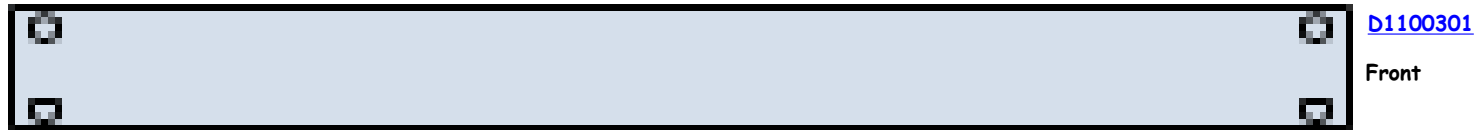

D0902783 - S1001157



<< L1-SUS-XC1

Anti-Alias Chassis (8*DB9) D0902783 S1001157 ±18VDC

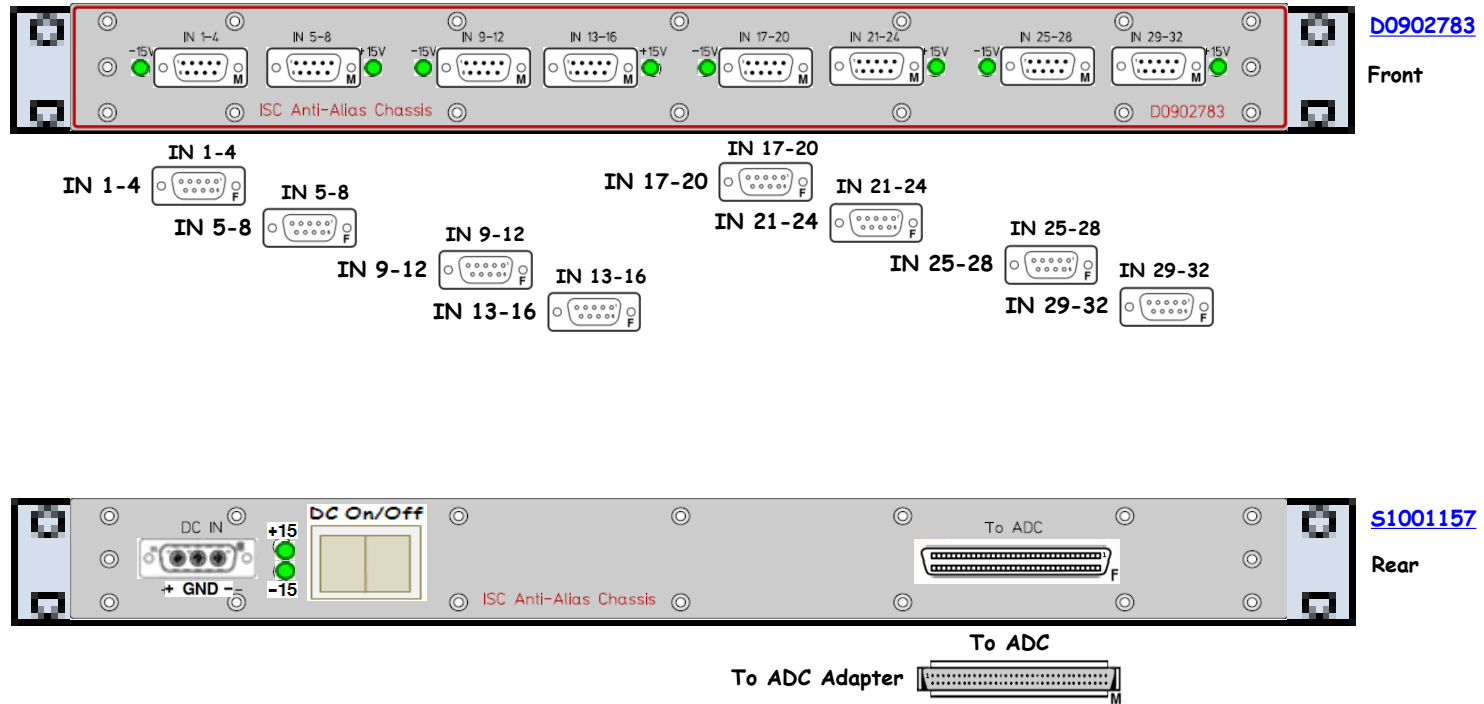

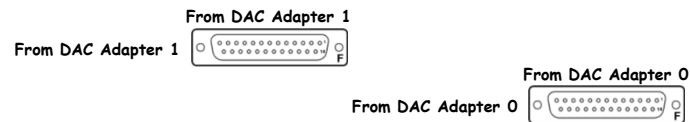
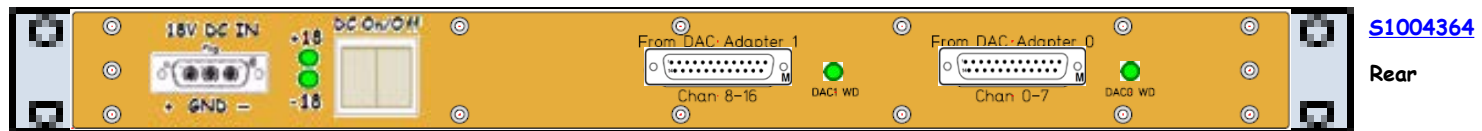
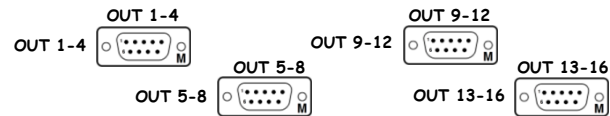
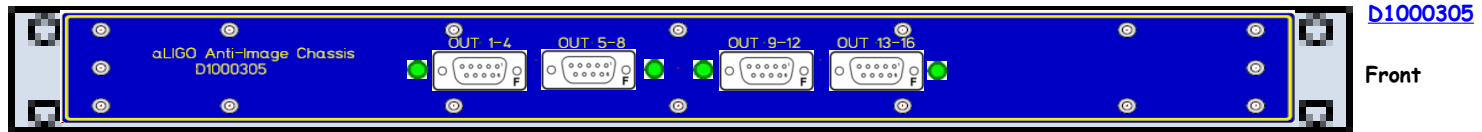

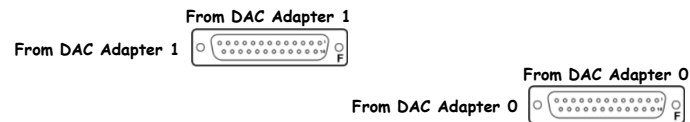
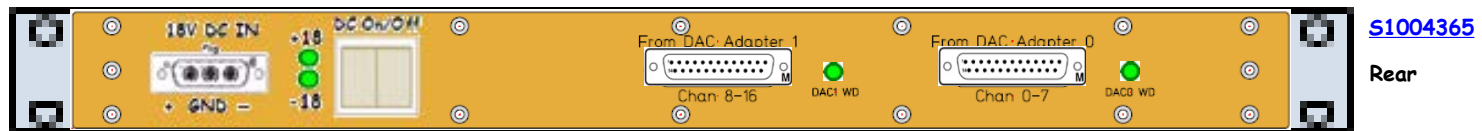
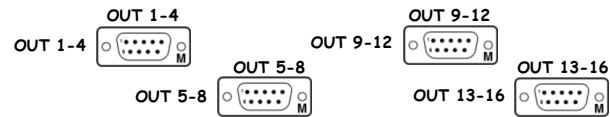
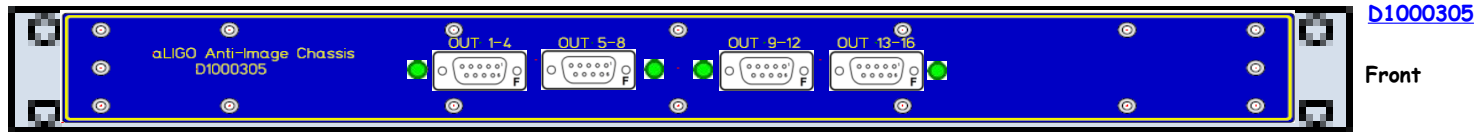

D1100815 is an AI, which means it has OUTPUTS, not INPUTS. The labels are incorrect.

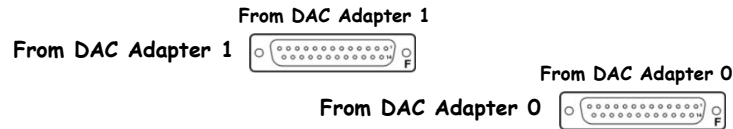
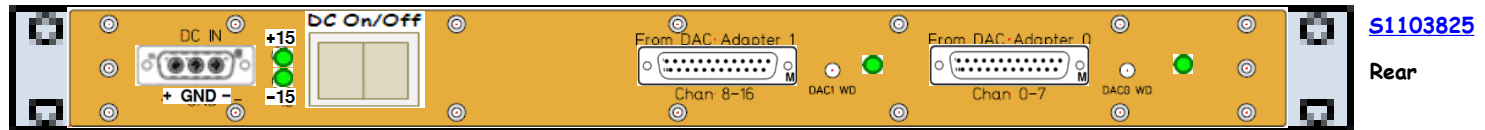
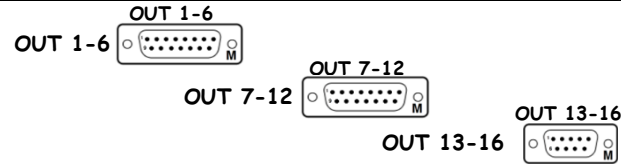
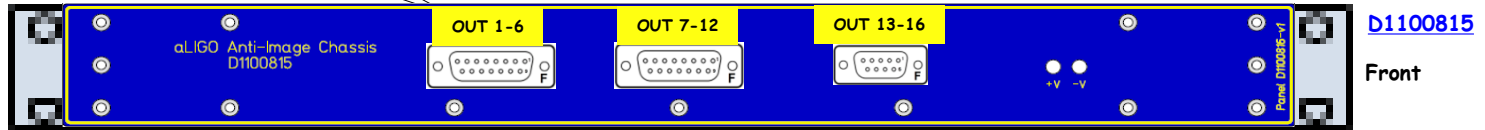

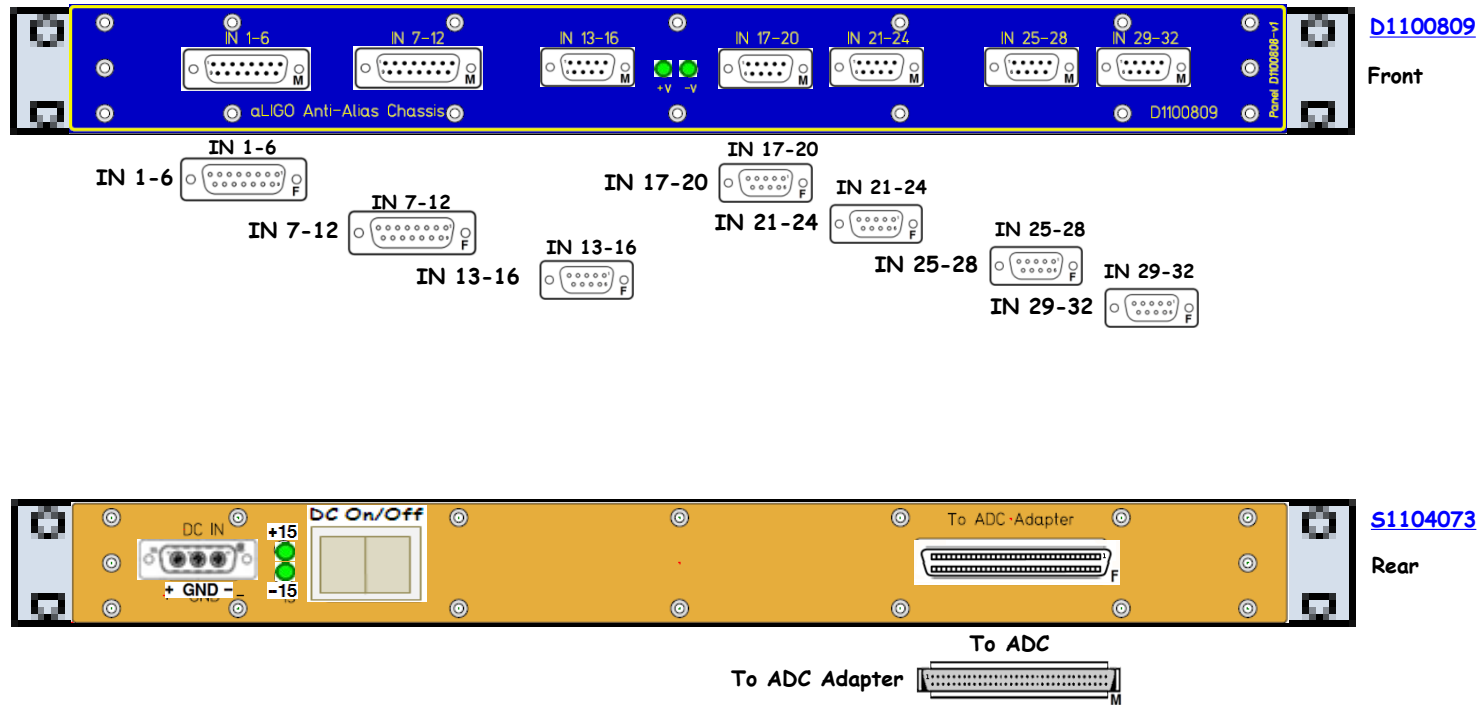

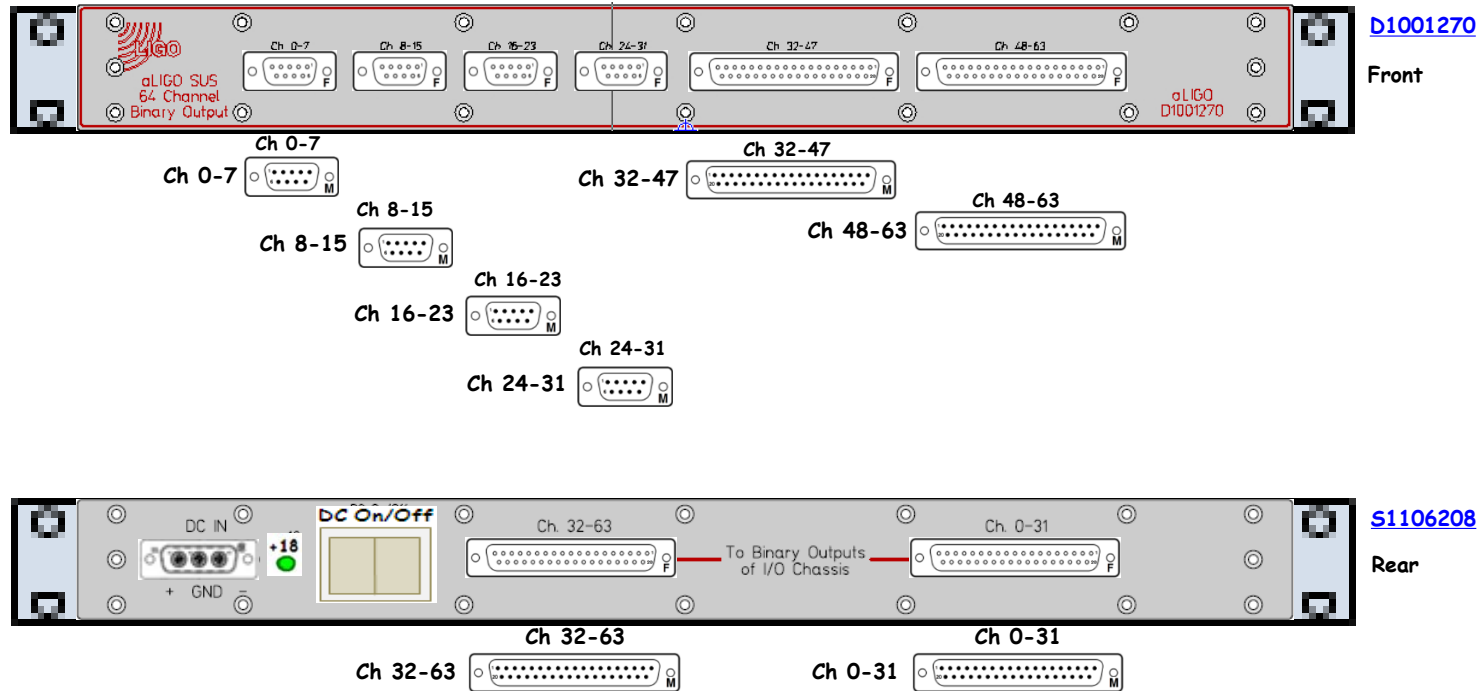

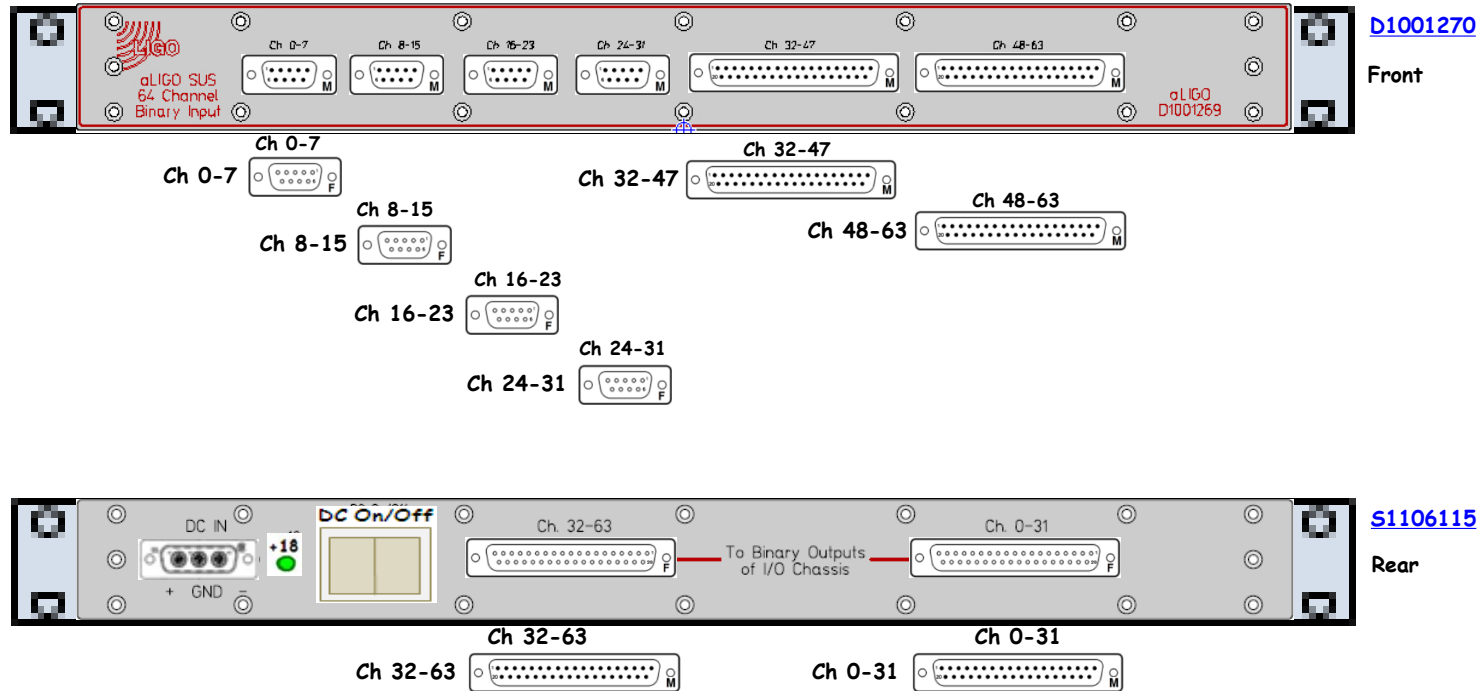

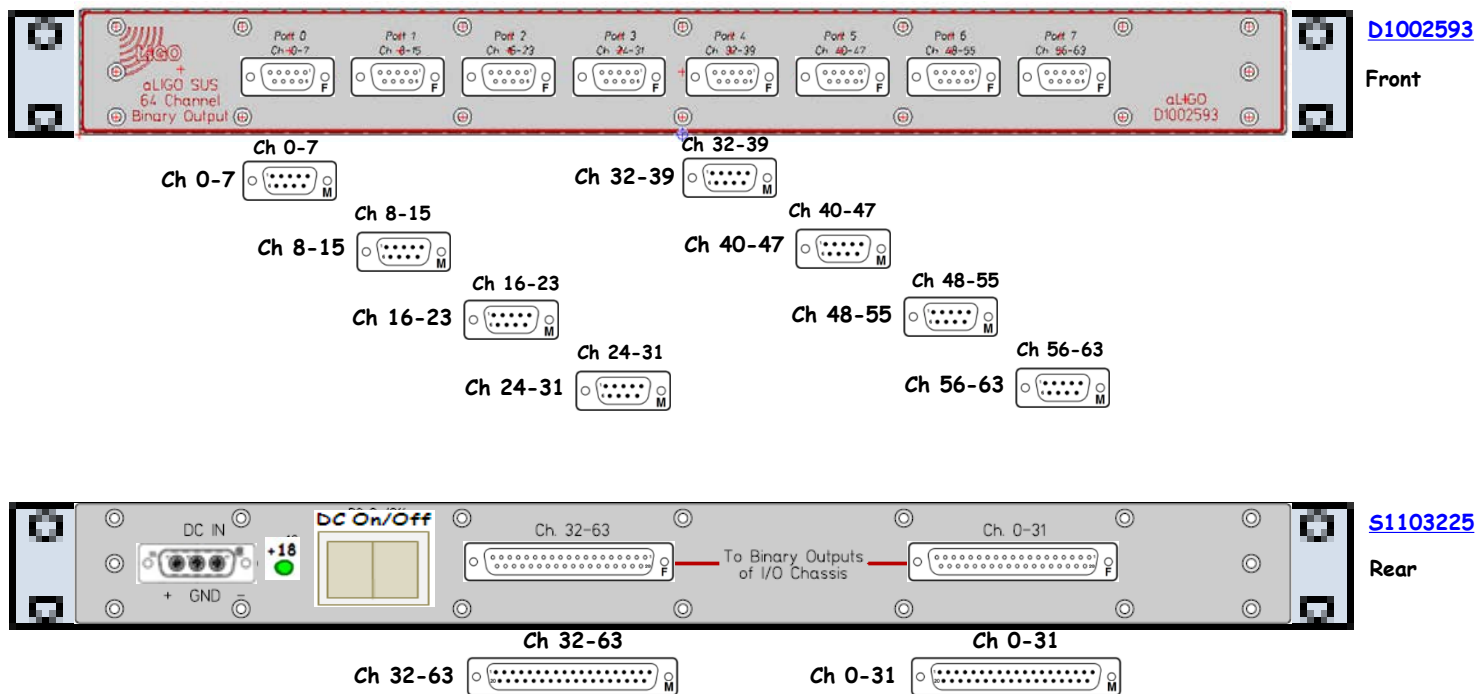

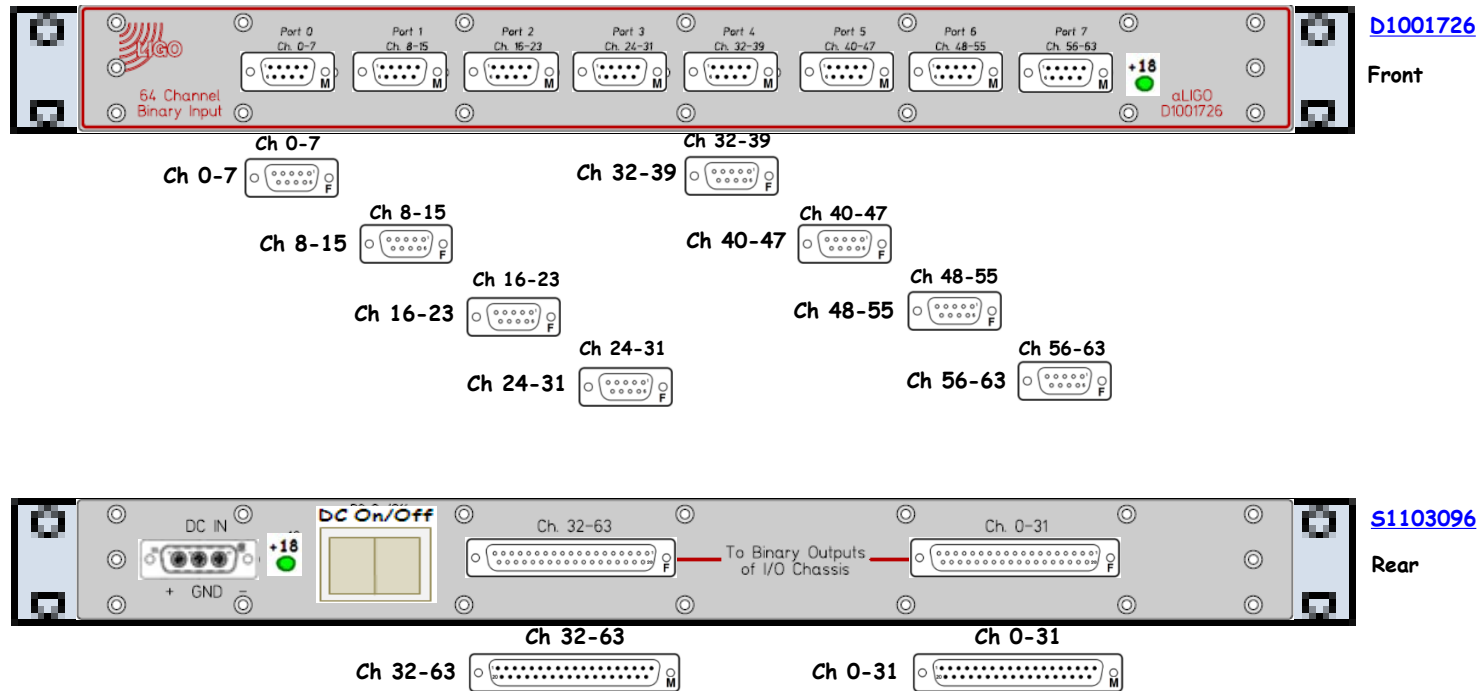

L1-SUS-XC2 Details

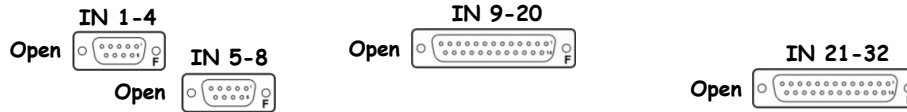

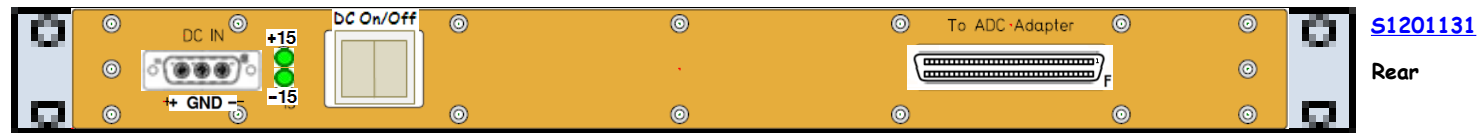
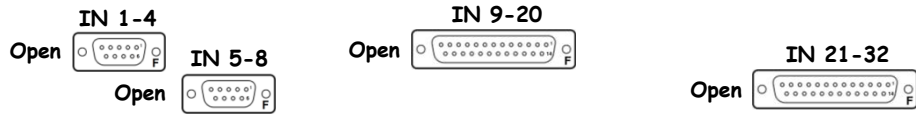
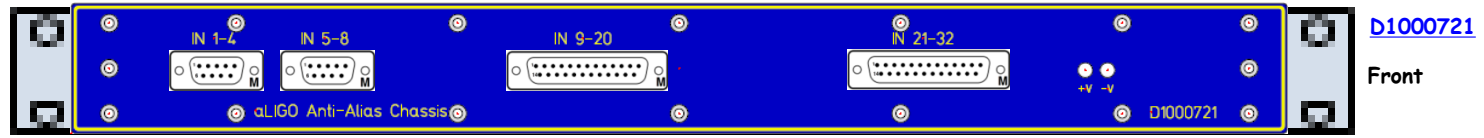

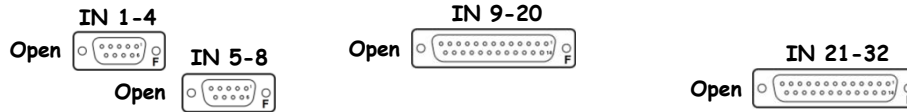
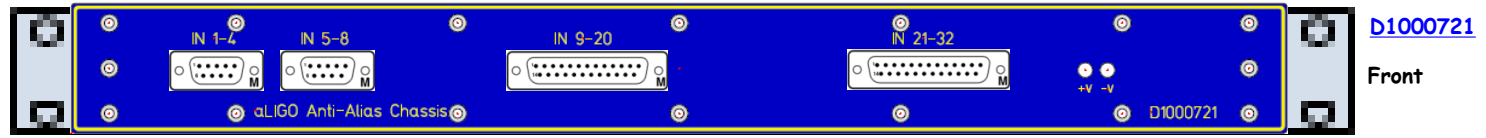

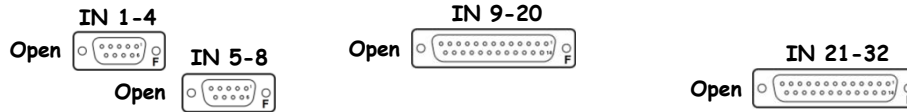



D1001715

Front

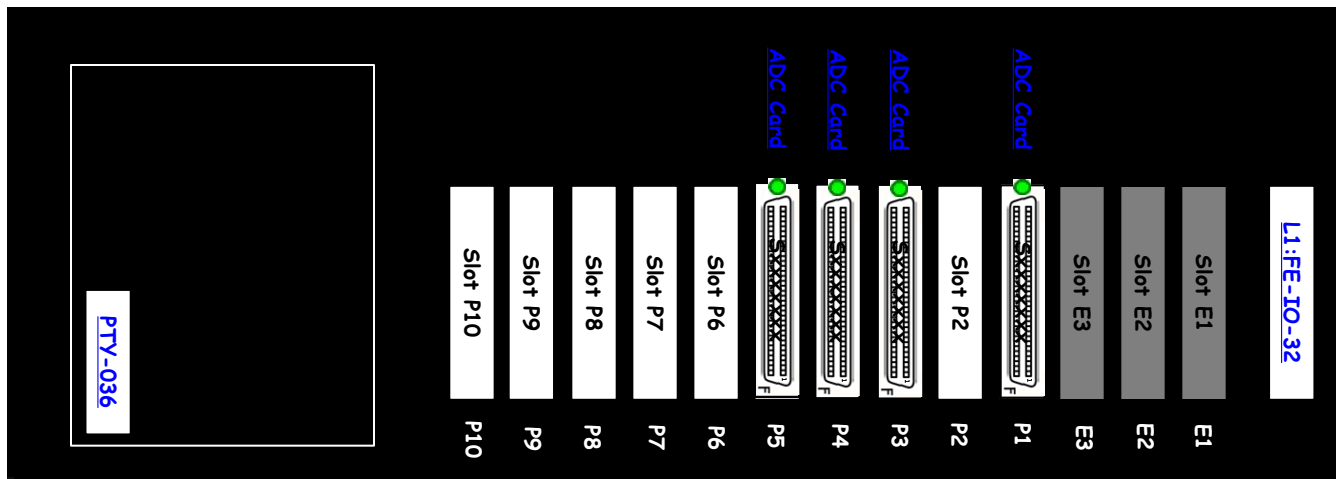

S1201779

Rear

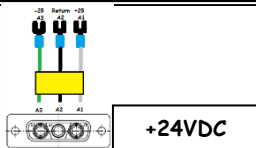
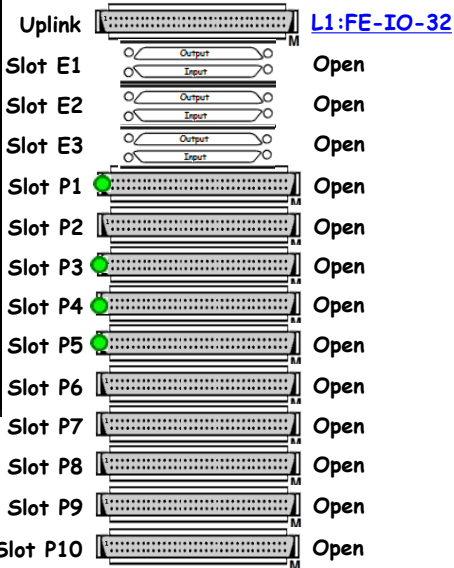

l1susex I/O Extension Chassis

D1001715

S1103367

110VAC



D1001715

Front

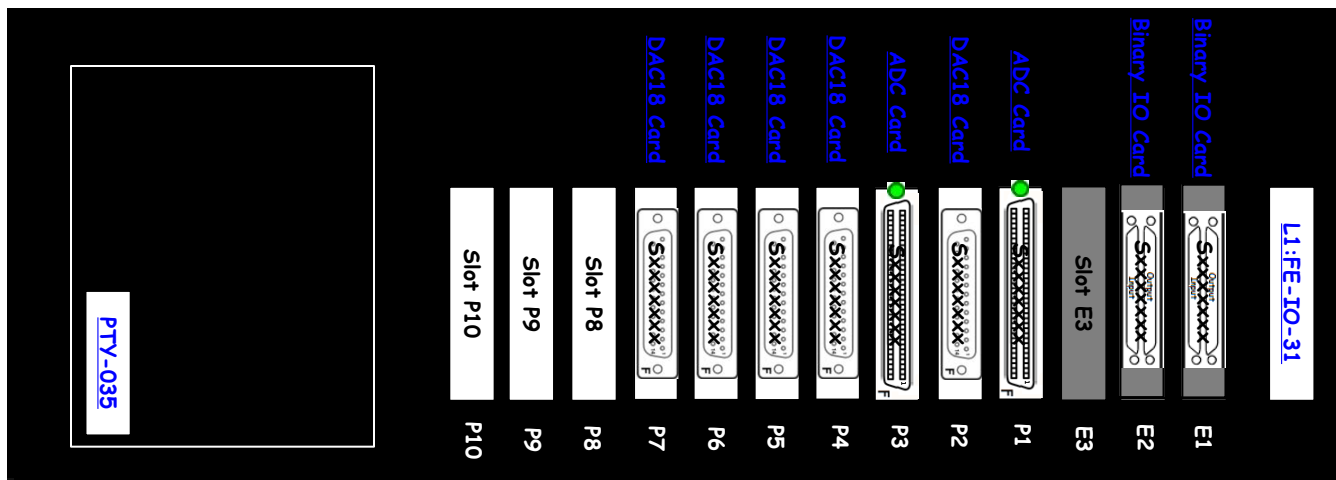

S1103367

Rear

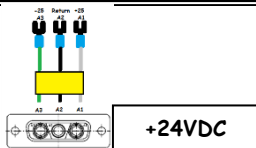
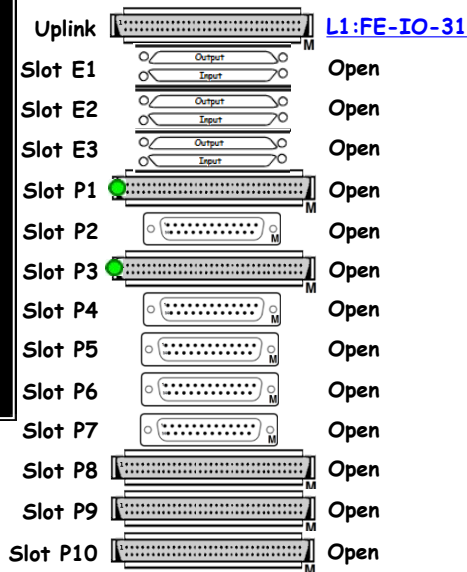

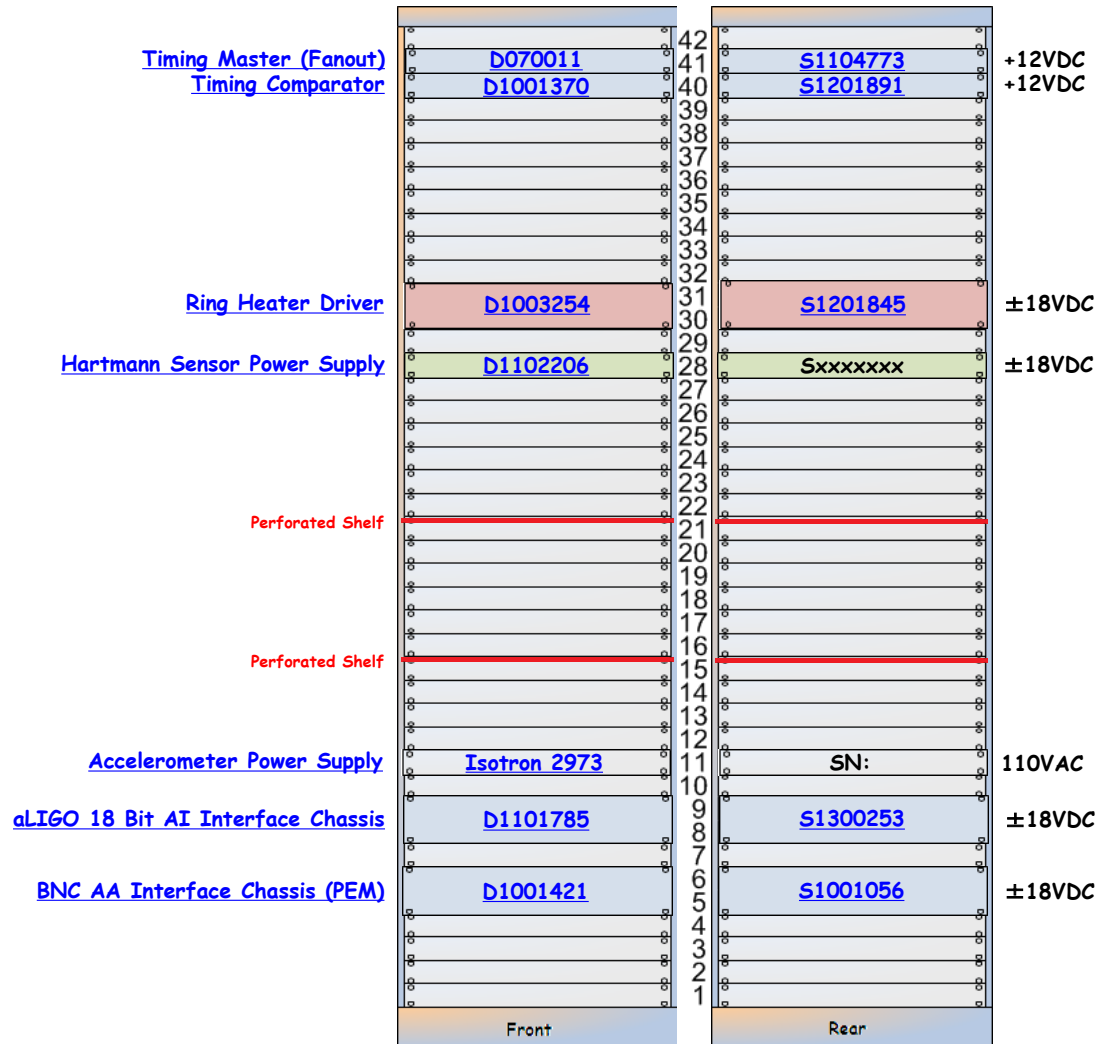

TCS-XC1 is part of [D1200258](#)

TCS-XC1 is part of [E1100894](#)

L1-TCS-XC1 Details

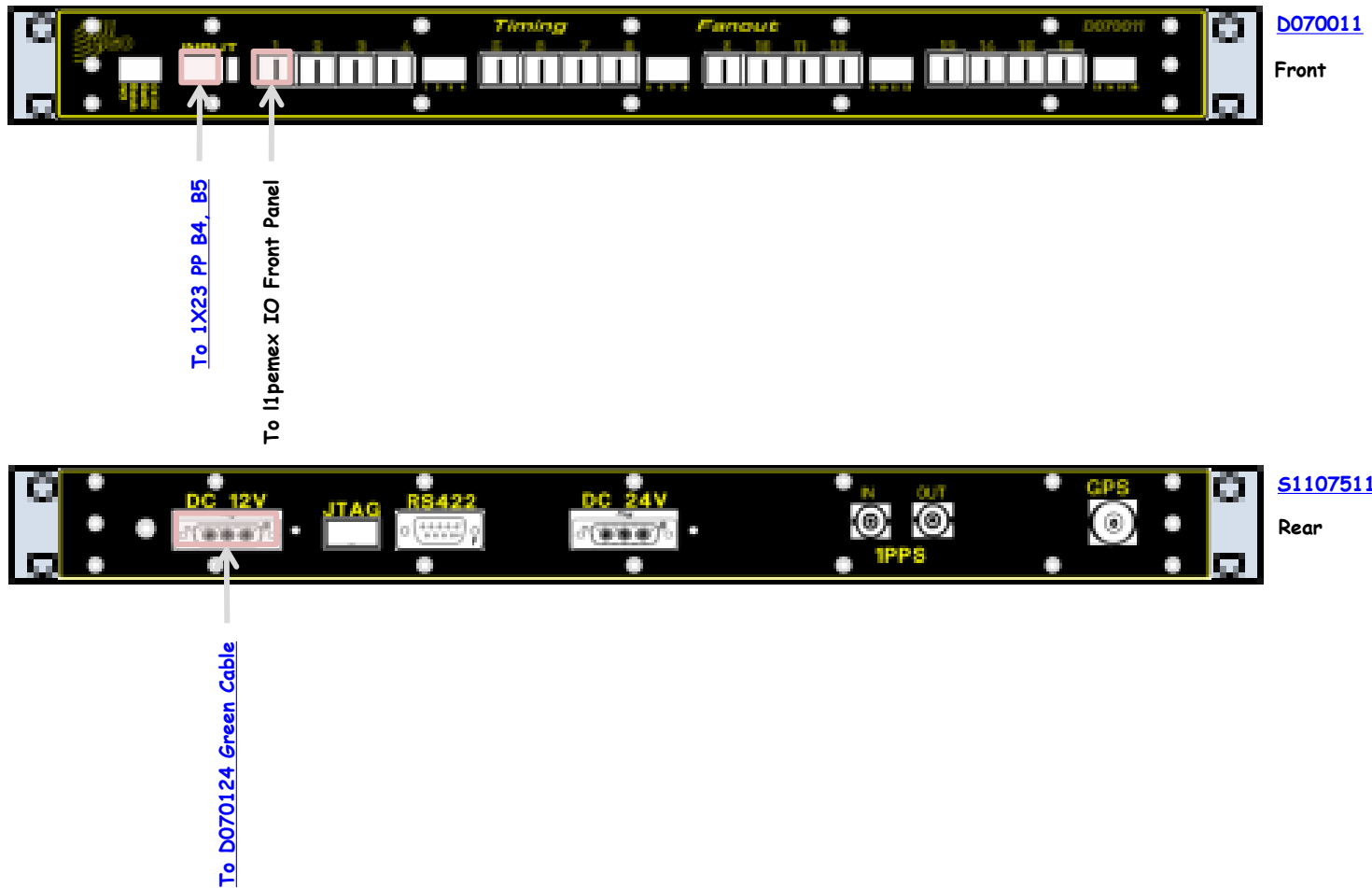

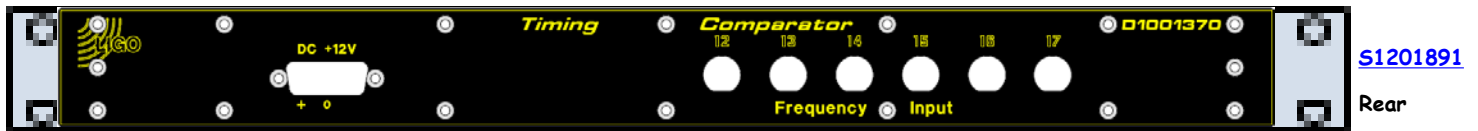
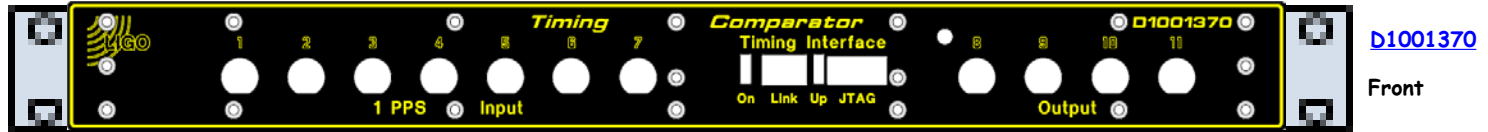

D1003254 - S1201845



<< L1-TCS-XC1

Ring Heater Driver

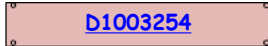

±18VDC

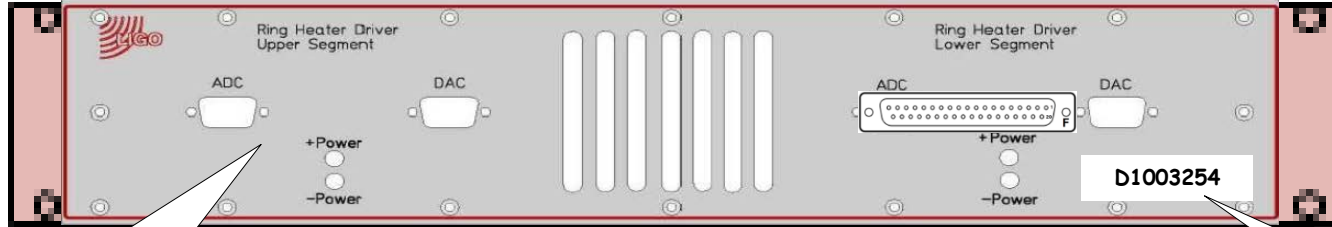

D1003254

Front

This is an early revision of the front panel. It now has one DB37M connector. 20121205 dlk



White label 20121205 dlk

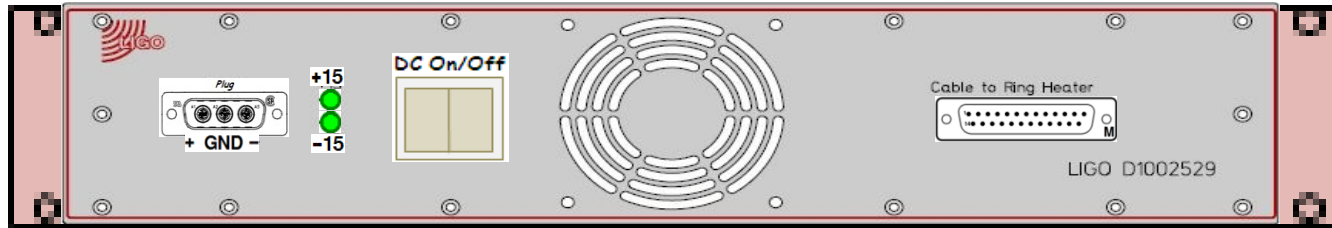

S1201845

Rear



<< L1-TCS-XC1

Hartmann Sensor Power Supply +12VDC

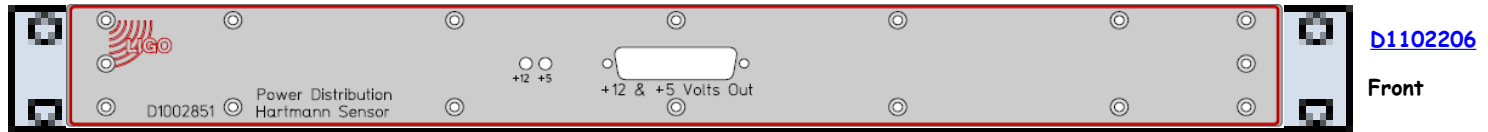

Accelerometer Power Supply

Isotron 2973

SN:

110VAC

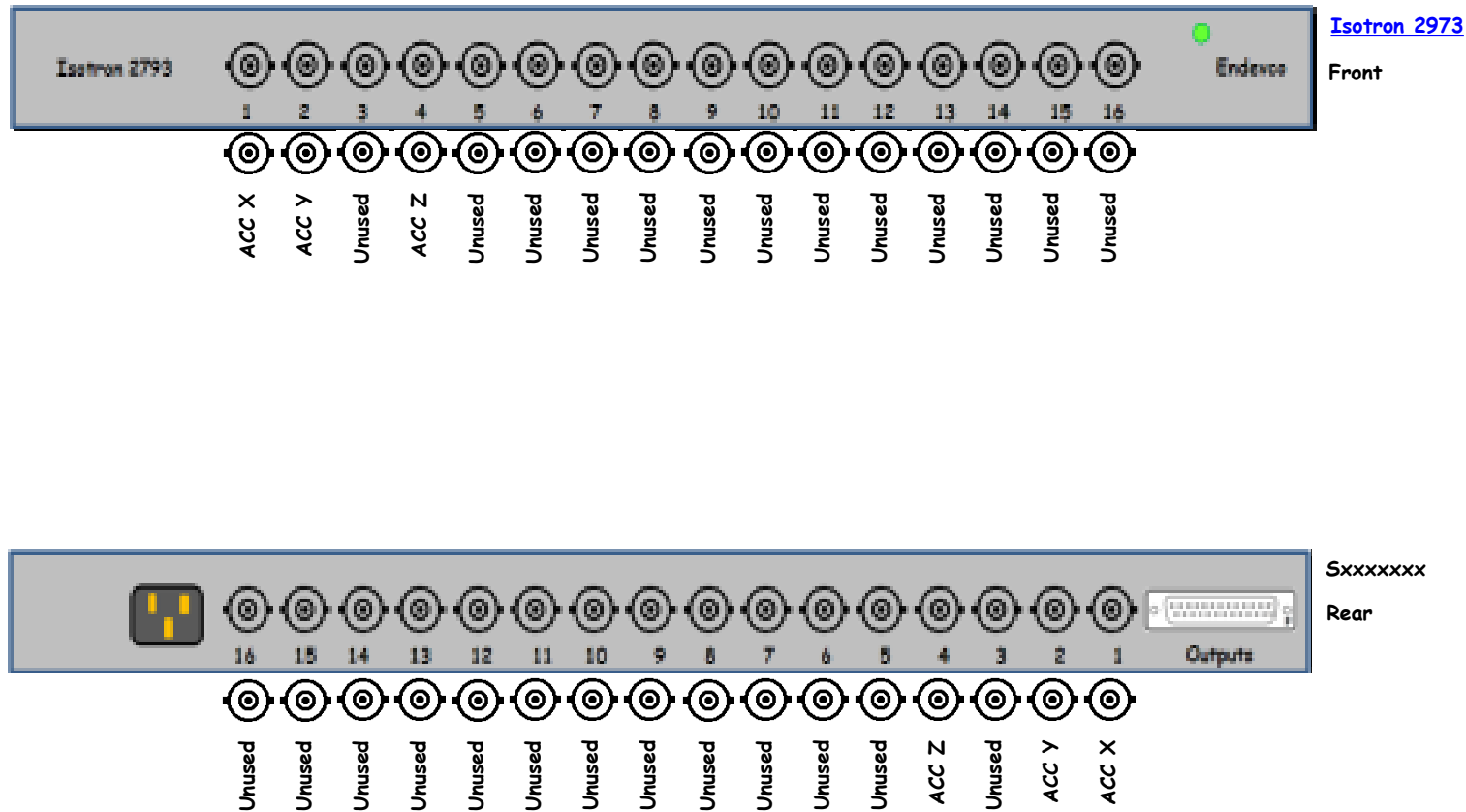

Isotron 2973

Front

Sxxxxxxx

Rear

aLIGO 18 Bit AI Interface Chassis

D1101785

S1300253

Power

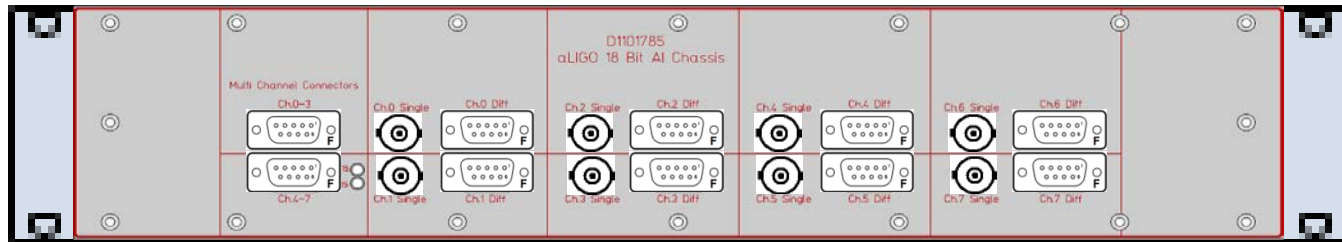

D1101785

Front

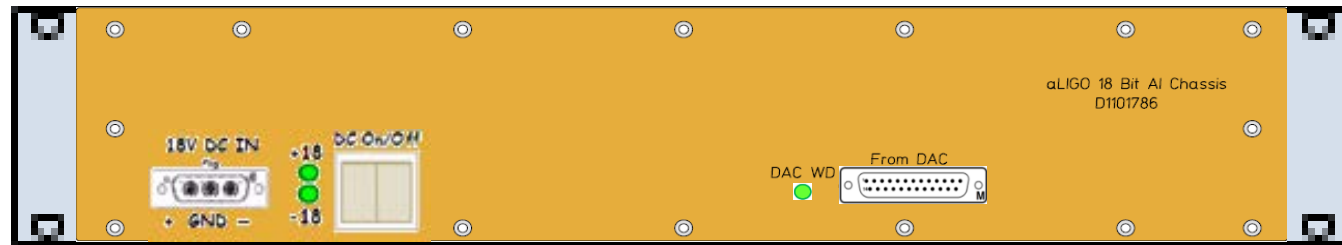
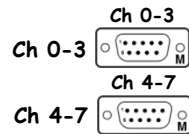

S1300253

Rear



<< L1-TCS-XC1

aLIGO AA Interface Chassis
(32 BNC, x10 Gain Version)

D1001421

SN:

Power

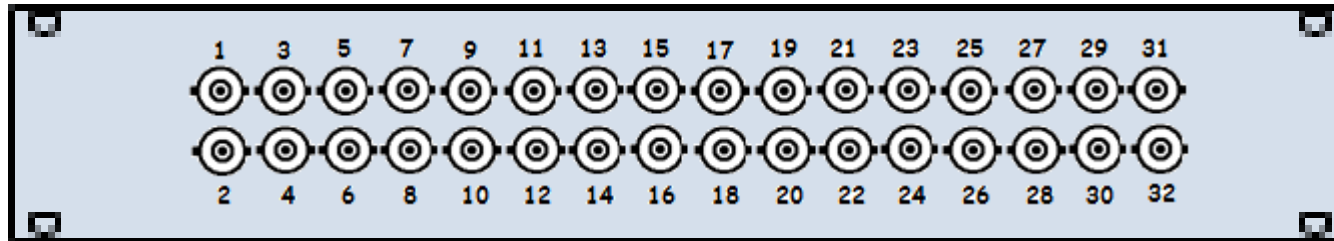

D1001421

Front

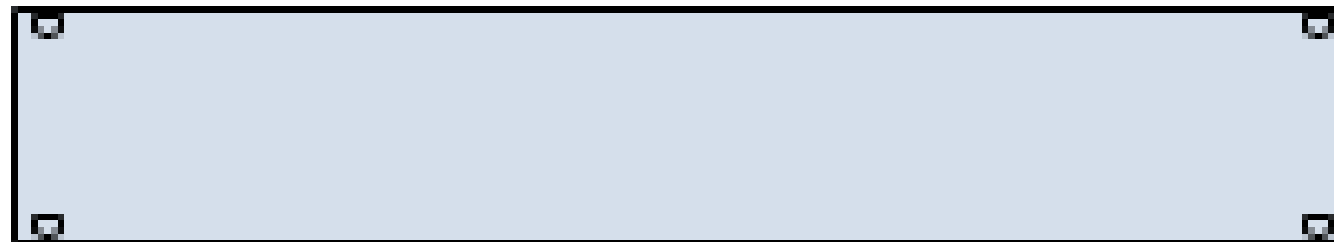
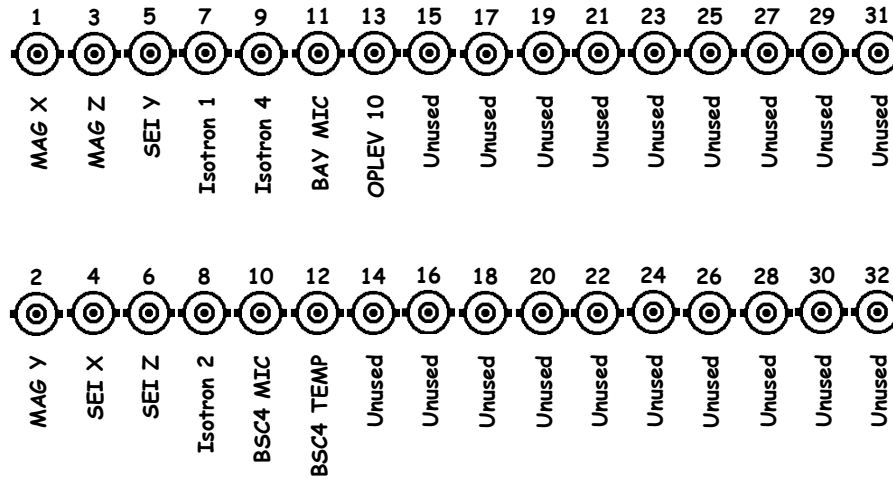

SN:

Rear

aLIGO Accelerometer Interface Chassis

D1101363

SN:

Power

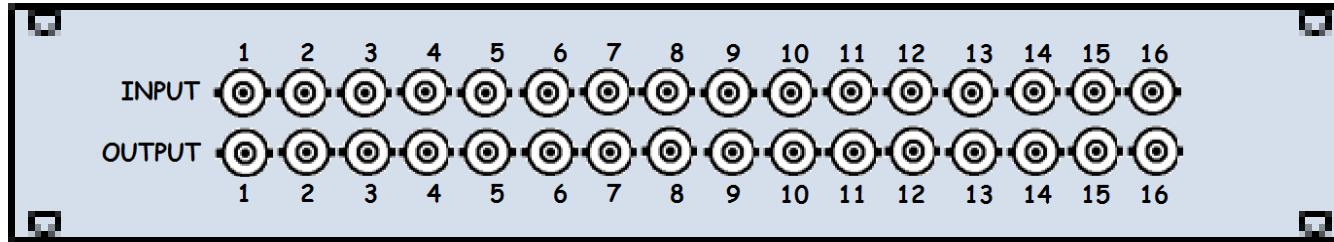

D1101363

Front

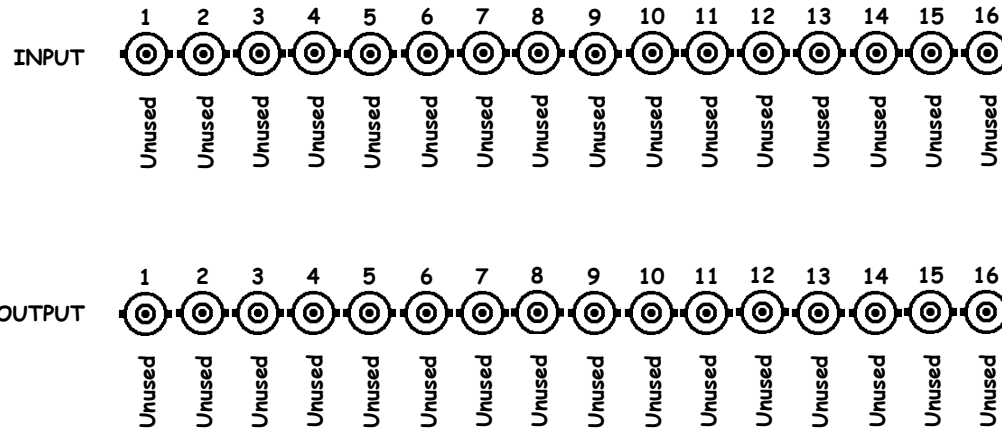

SN:

Rear

L1-ISC-XR1

L1-ISC-XR1 X-End Station Field Rack Layout ([D1201087](#)) ([S1202951](#))

[D1200757](#)
Sequencer



[S1202568](#)

- [RF Distribution Panel 24](#)
- [RF Distribution Panel 25](#)
- [24.5 MHz Delay Line Phase Shifter](#)
- [2 Channel RFPD I/Q Demod \(RC & ALS\)](#)
- [WFS Demodulator Patch Panel](#)
- [79.4 MHz VCO \(ALS\)](#)
- [39.7 MHz Frequency Divider](#)
- [RF Preamplifier](#)
- [39.7 MHz 2 Channel Phase/Freq Discriminator](#)
- [Common Mode Servo \(ALS Laser Locking\)](#)
- [Common Mode Servo \(ALS Cavity Locking\)](#)
- [LSC Demod Concentrator 5](#)
- [ASC Demod Concentrator 6](#)
- [Auxiliary Signals Concentrator 2](#)
- [Auxiliary Signals Concentrator 1](#)
- [Auxiliary Signals Concentrator 5](#)
- [QUAD I&Q Demodulator Module](#)
- [Differential to Single-Ended Converter](#)
- [ISC Whitening Chassis](#)
- [Dual QPD Transimpedance Amplifier](#)
- [Dual QPD Transimpedance Amplifier](#)
- [ISC Whitening Chassis](#)

Dxxxxxxx	42	SN:	No Power
Dxxxxxxx	41	SN:	No Power
D0900128	40	S1103433	+15VDC
D1000181	39	S1000785	±17VDC, ±24VDC
D1100905	38	Sxxxxxxx	No Power
D0900605	37	S1200577	±17VDC, ±24VDC
D1002182	36	S1000752	±17VDC, ±24VDC
D1201294	35	S1203937	??
D1002476	34	S1000767	±17VDC, ±24VDC
D0901781	33	S1102643	±17VDC, ±24VDC
D0901781	32	S1102639	±17VDC, ±24VDC
D1100691	31	S1104009	±18VDC
D1100696	30	S1103988	No Power
D1102045	29	S1200534	±17VDC
D1102065	28	S1200551	±17VDC
D1102065	27	Sxxxxxxx	±17VDC
D0902796	26	Sxxxxxxx	±15VDC
D1100482	25	S1203309	±15VDC
D1002559	24	Sxxxxxxx	±15VDC
D1002481	23	Sxxxxxxx	±18V
D1002481	22	Sxxxxxxx	±18V
D1002559	21	Sxxxxxxx	±15VDC
	20		
	19		
	18		
	17		
	16		
	15		
	14		
	13		
	12		
	11		
	10		
	9		
	8		
	7		
	6		
	5		
	4		
	3		
	2		
	1		

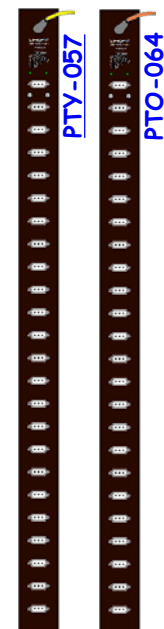

ISC-XR1 is part of [D1001423](#)

L1-ISC-XR1 Details

RF Patch Panel 24

Dxxxxxxx

Sxxxxxxx

No Power

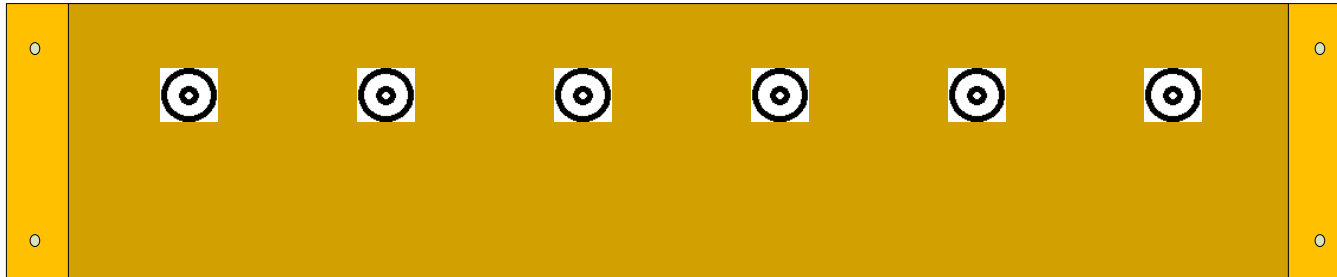

Dxxxxxxx

Front

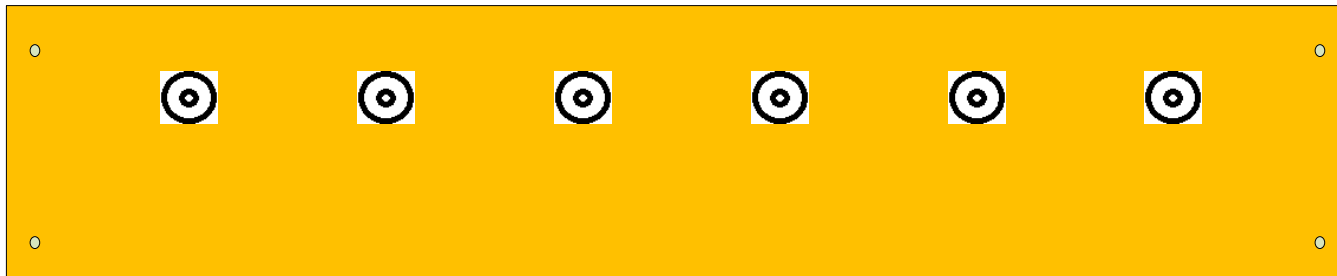

Sxxxxxxx

Rear

RF Patch Panel 25

Dxxxxxxx

Sxxxxxxx

No Power

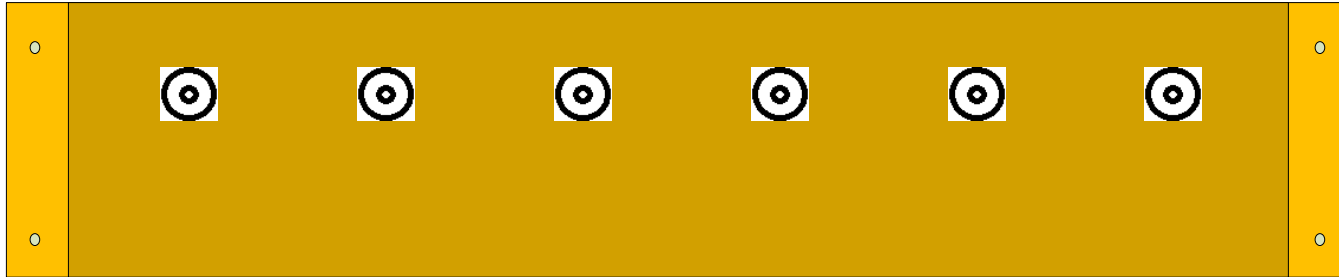

Dxxxxxxx

Front

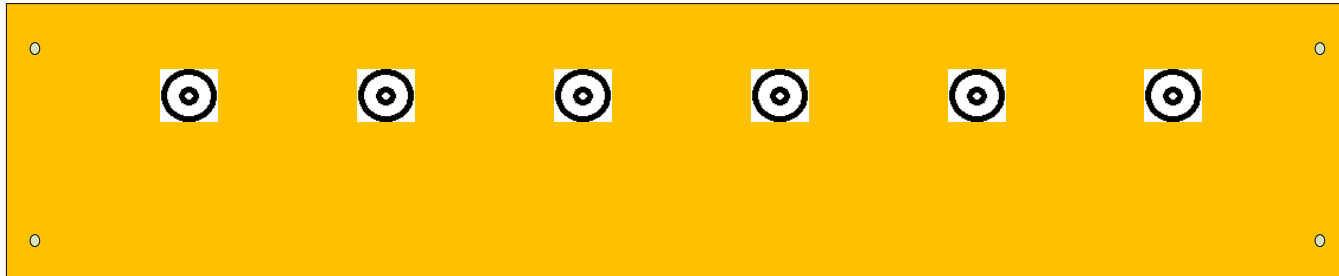

Sxxxxxxx

Rear

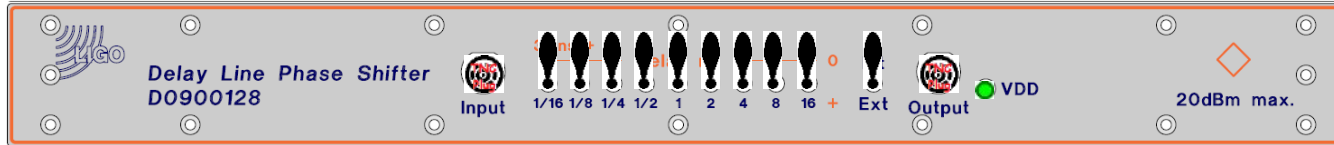

D0900128

Front

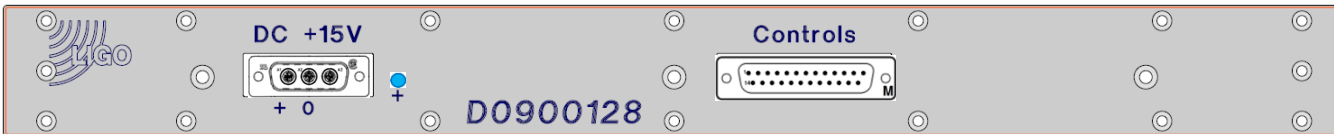
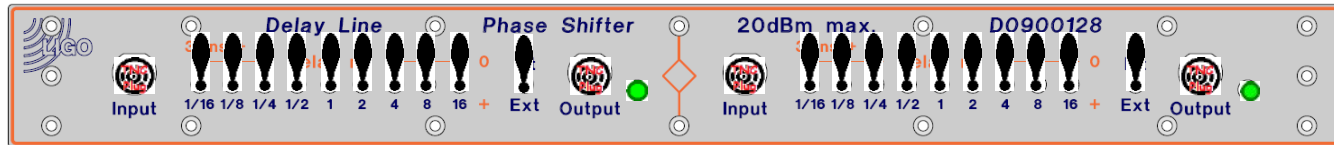

S1103433

Rear

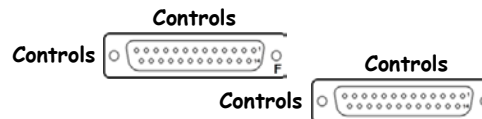
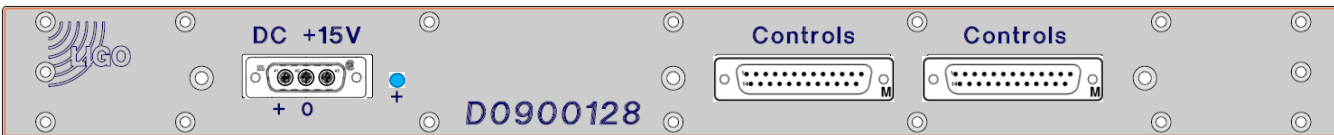
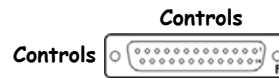

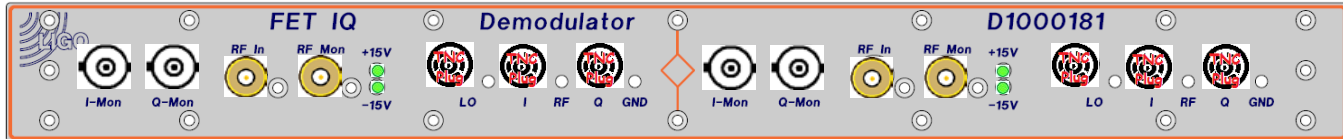

D1000181

Front

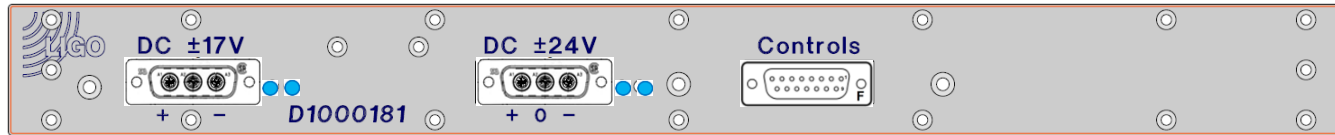

S1000785

Rear

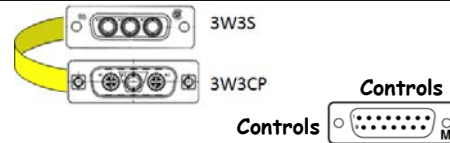

<< L1-ISC-XR1

WFS Demodulator Patch Panel No Power

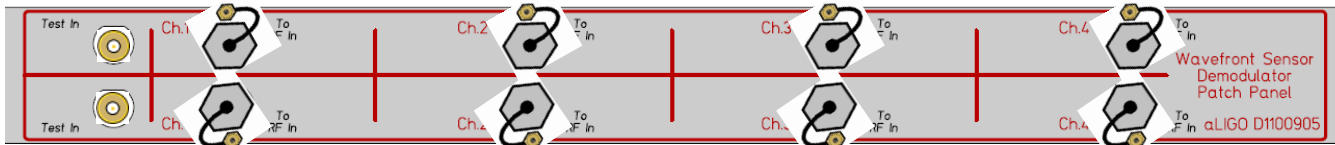

[D1100905](#)

Front



Sxxxxxxx

Rear

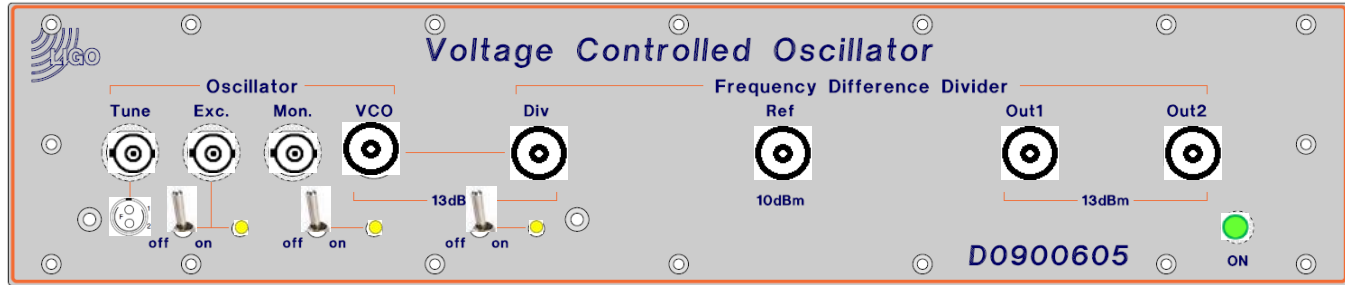

D0900605

Front

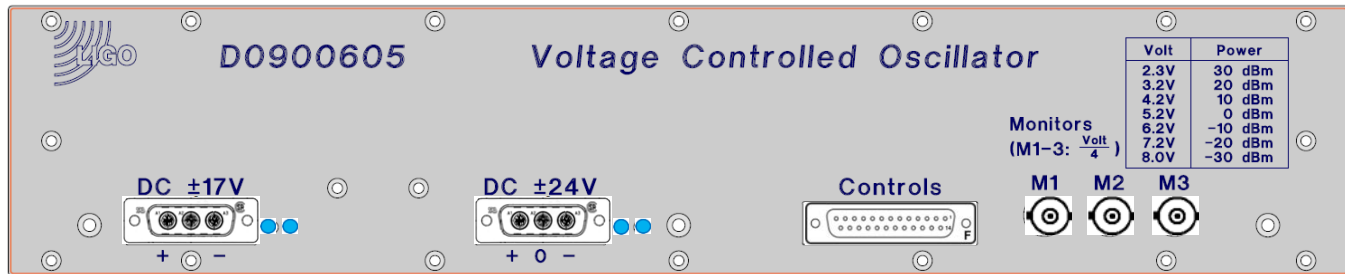

S1200577

Rear

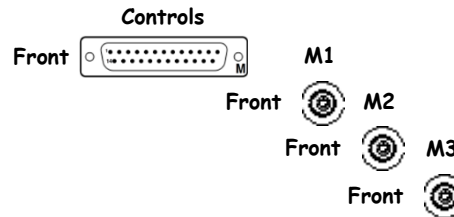
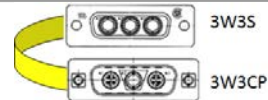

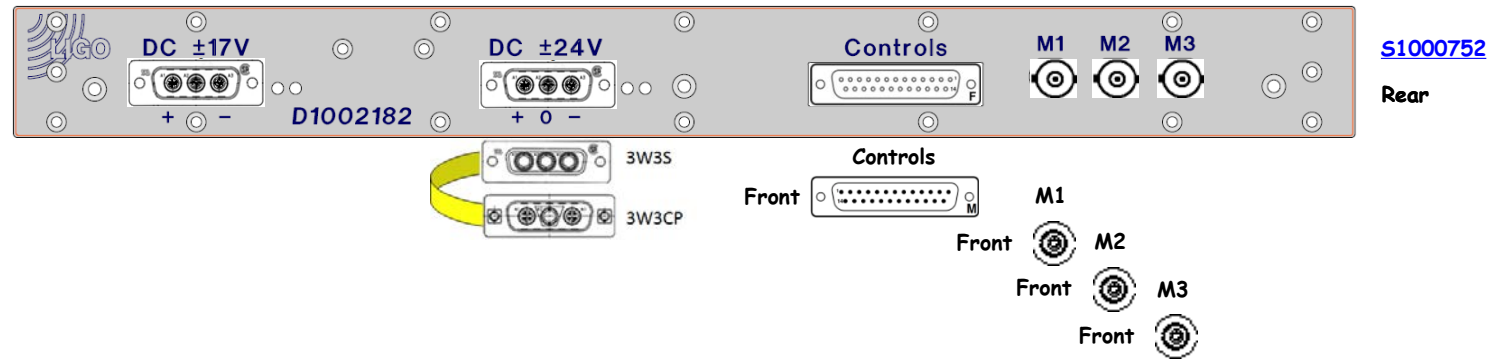
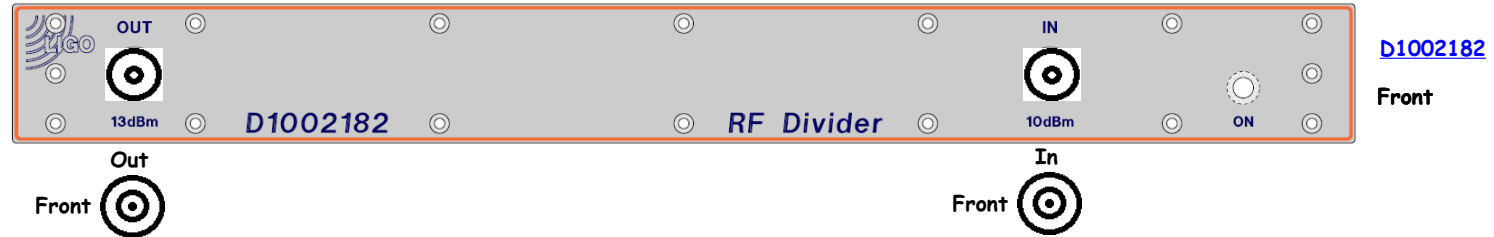

D1201294 - S1203937

The LIGO logo consists of the word "LIGO" in a bold, black, sans-serif font. To the left of the text is a stylized graphic of concentric, overlapping circles, resembling a ripple or a signal, rendered in a light gray color.

[<< L1-ISC-XR1](#)

RF Preamplifier ±18V

[D1002182](#)

Front

[S1203937](#)

Rear

D1002476 - S1000767



<< L1-ISC-XR1

39.7 MHz 2 Channel Phase/Freq Discriminator

D1002476

S1000767

±17VDC, ±24VDC

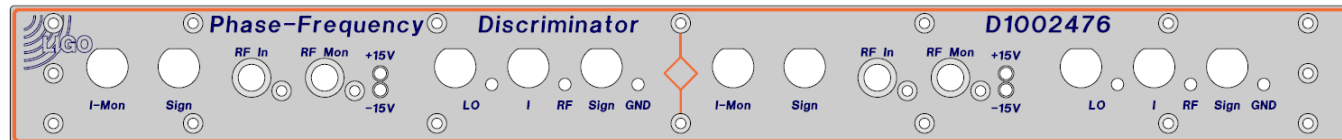

D1002476

Front

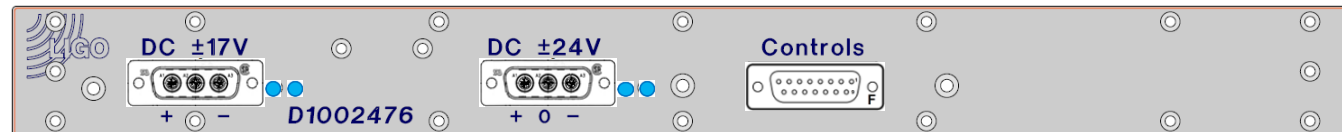

S1000767

Rear

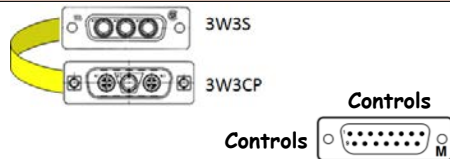



D0901781

Front

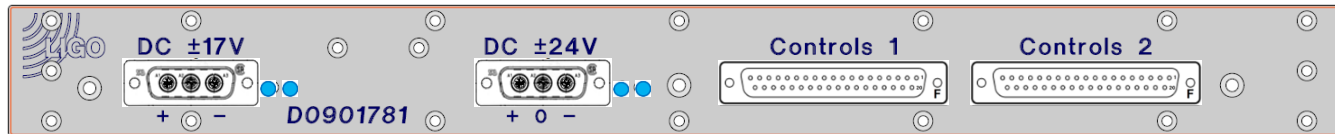

S1102643

Rear

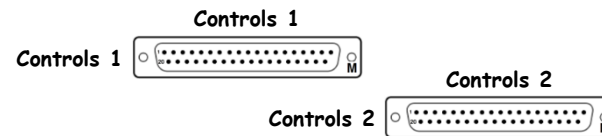
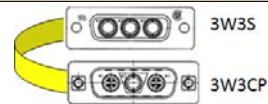



[D0901781](#)

Front

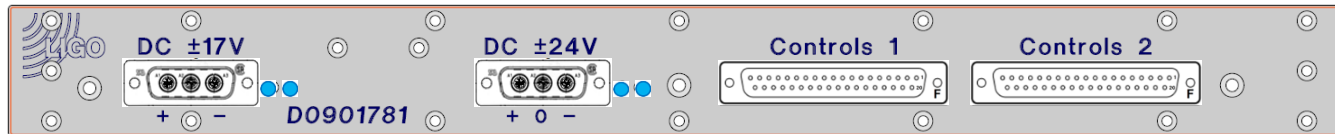

[S1102639](#)

Rear

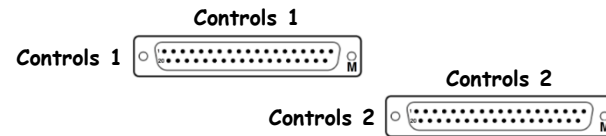
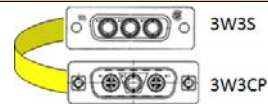

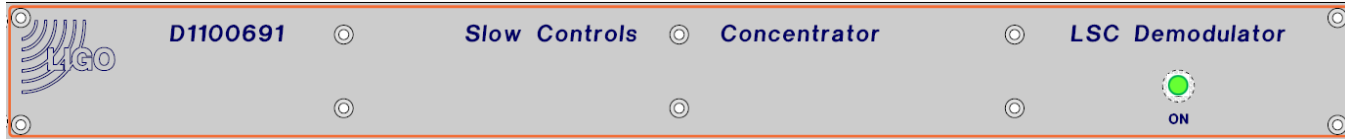

[D1100691](#)

Front

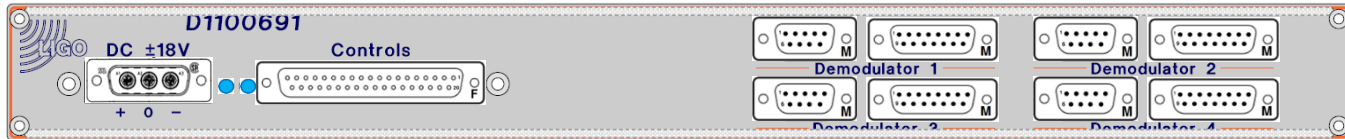

[S1104009](#)

Rear

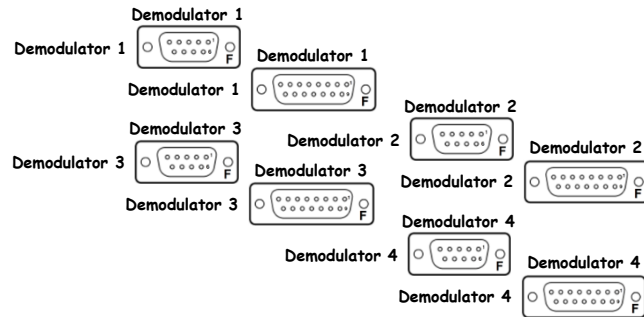
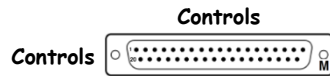

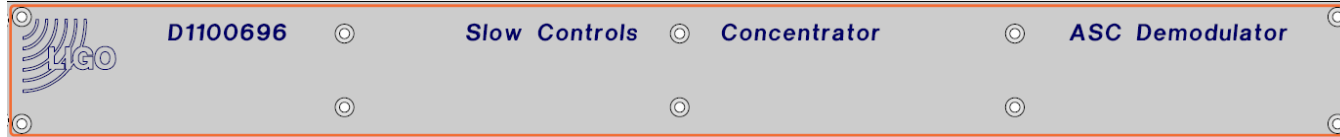

[D1100696](#)

Front

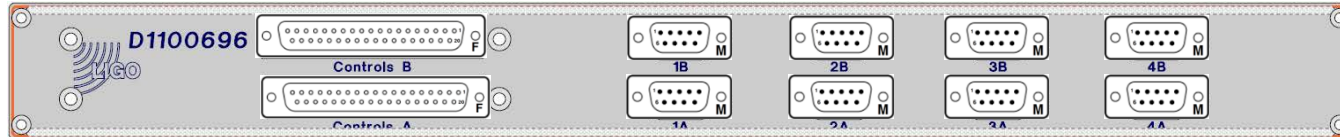

[S1103988](#)

Rear

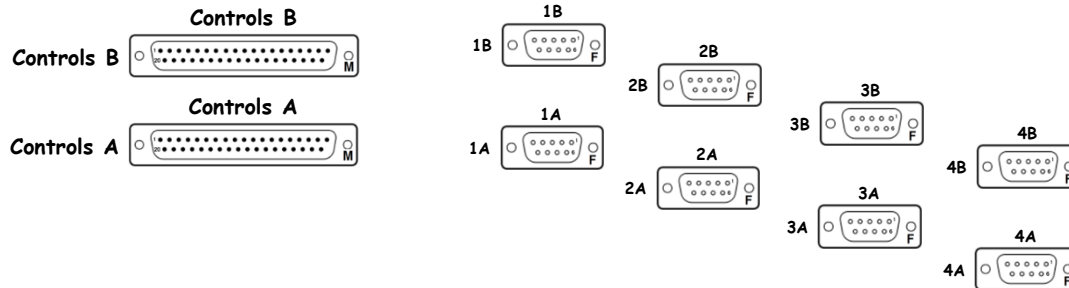

D1102045 - S1200534



<< L1-ISC-XR1

Auxiliary Signals Concentrator 2 D1102045 S1200534 ±17VDC



D1102045

Front

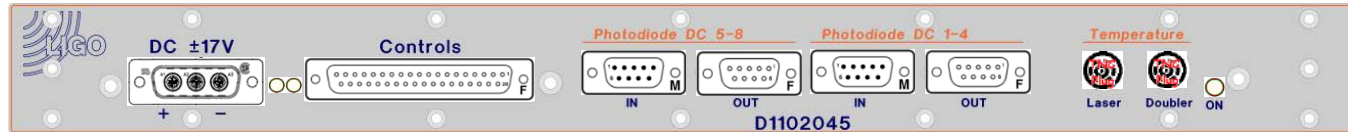

S1200534

Rear

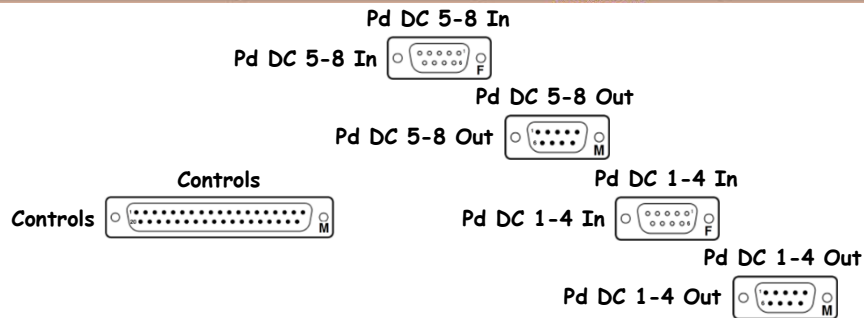

Auxiliary Signals Concentrator 5 D1102065 S1200551 ±17VDC



Auxiliary Signals Concentrator 5 D1102065 S1200551 ±17VDC

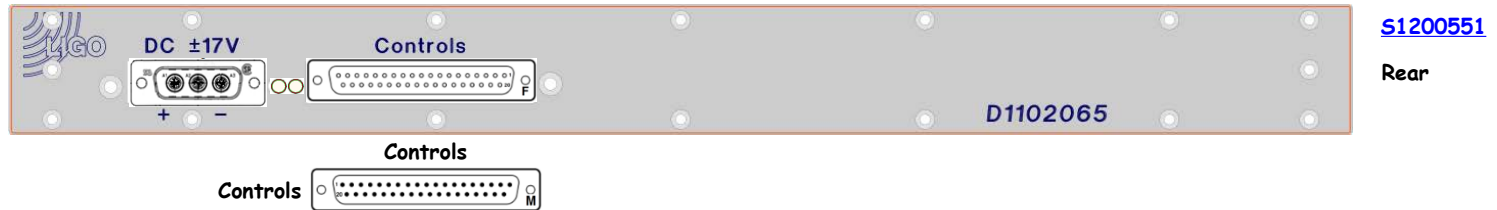

<< L1-ISC-XR1

QUAD I&Q Demodulator Module

D0902796

Sxxxxxxx

±15VDC

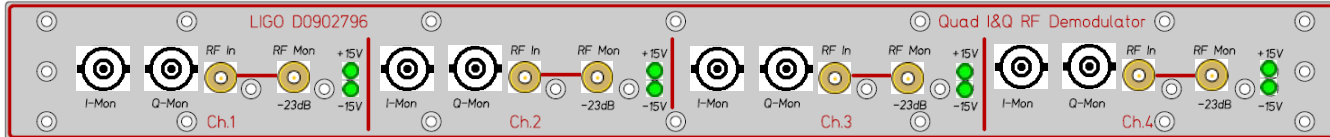

D0902796

Front

D1002032

LSC

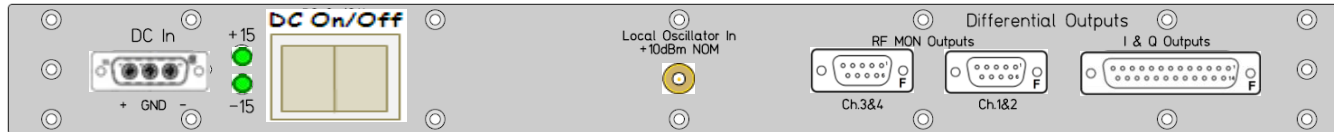

Sxxxxxxx

Rear

RF Mon Out Ch 3&4

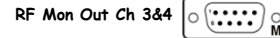

RF Mon Out Ch 3&4

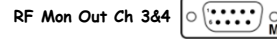

I & Q Outputs



D1002031

WFS

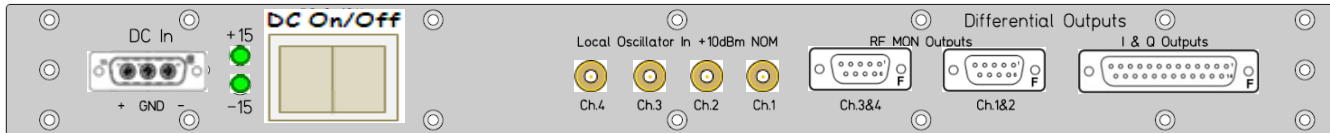

Sxxxxxxx

Rear

RF Mon Out Ch 3&4

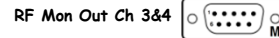

RF Mon Out Ch 3&4

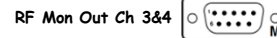

I & Q Outputs



D1100482 - S1203309



<< [L1-ISC-XR1](#)

Differential to Single-Ended Receiver

[D1100482](#)

[S1203309](#)

±15VDC

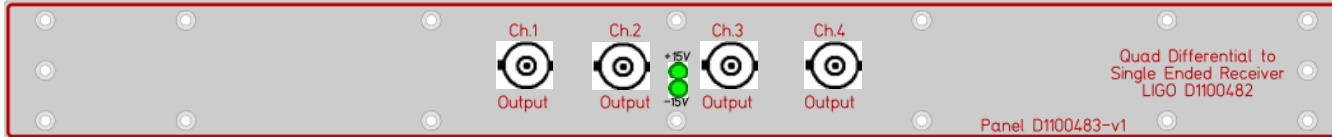

[D1100482](#)

Front



[S1203309](#)

Rear



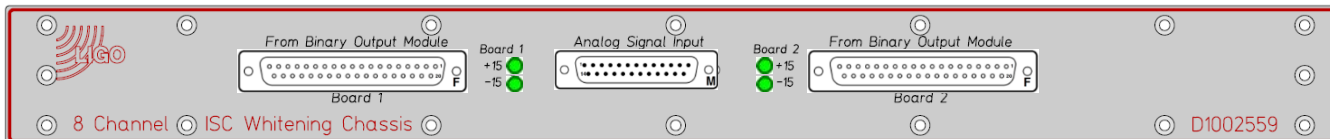

D1002559

Front

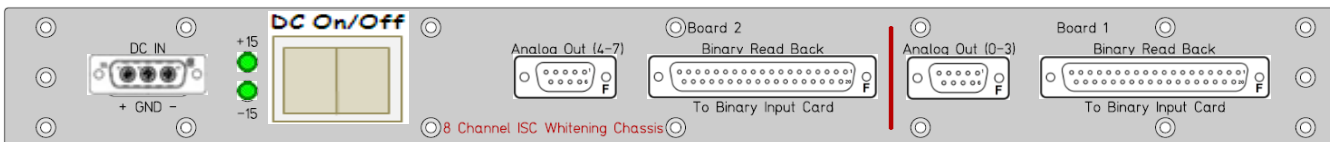
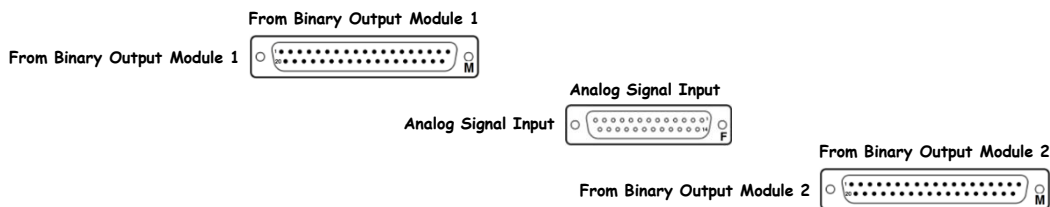

Sxxxxxxx

Rear

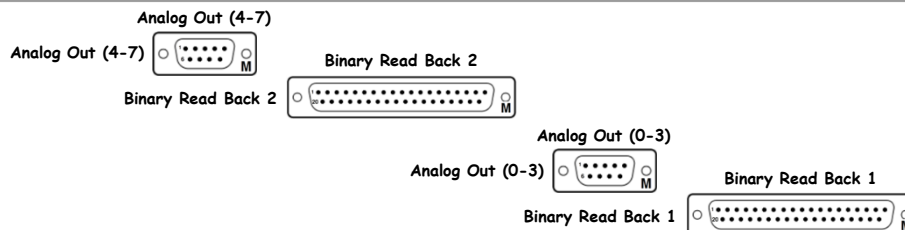

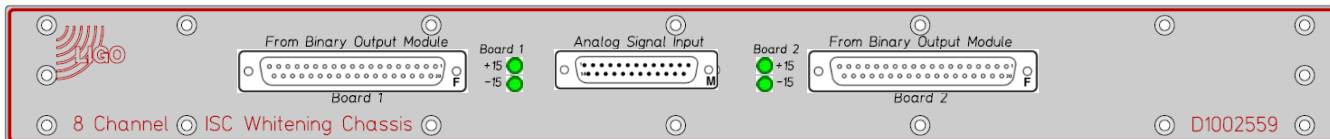

D1002559

Front

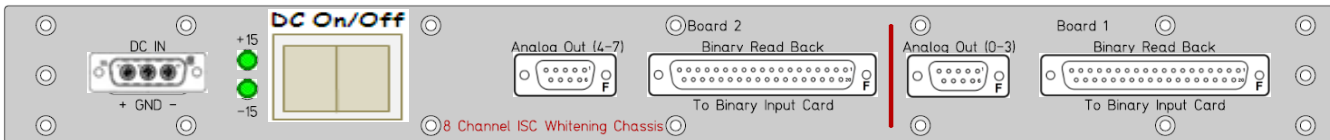
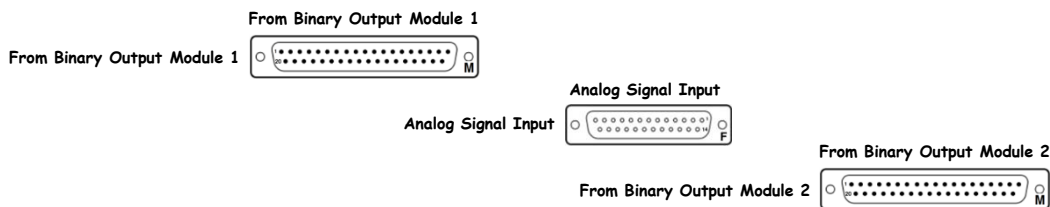

Sxxxxxxx

Rear

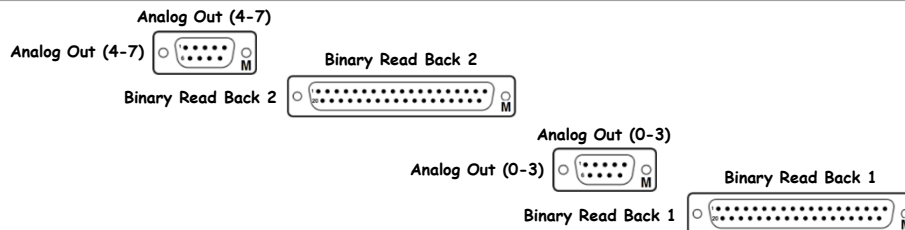

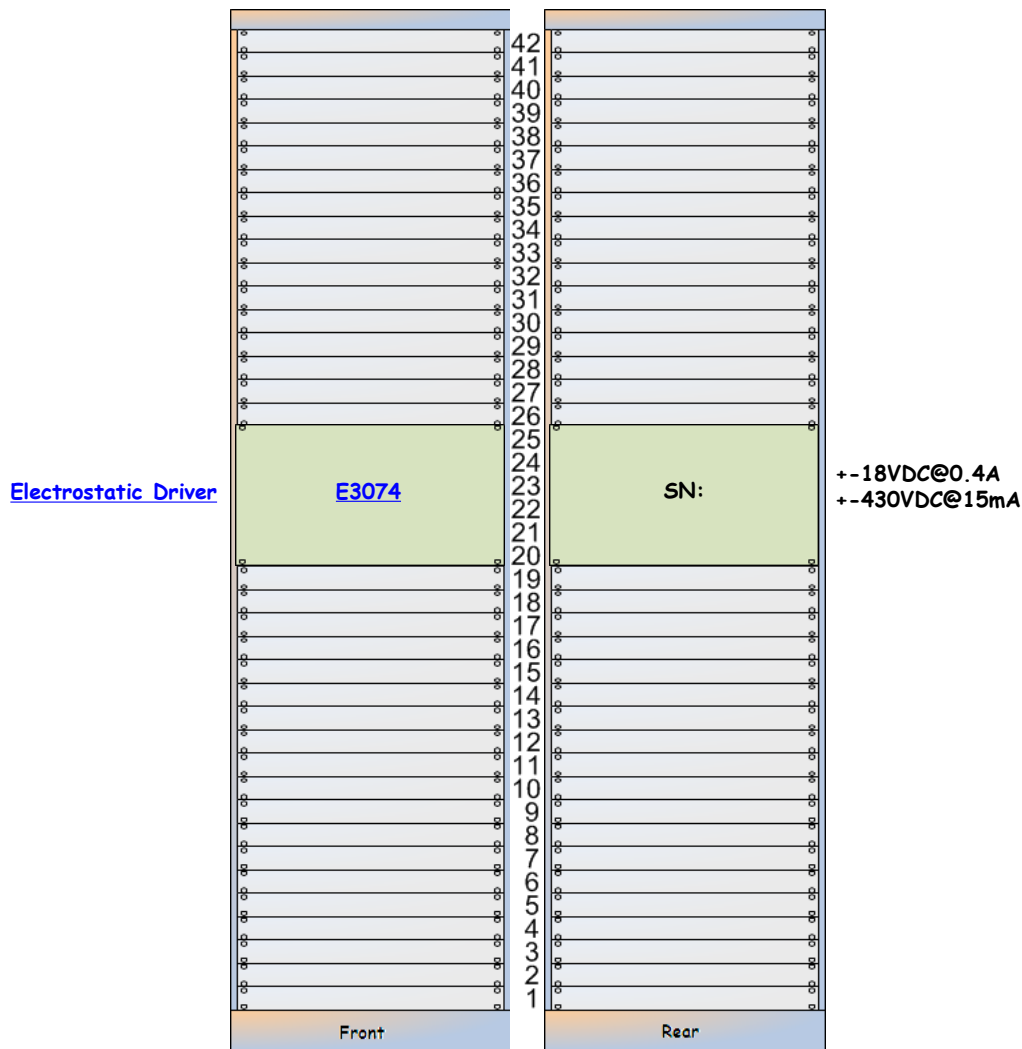

L1-SUS-XR1 Details

E3074

Electrostatic Driver

E3074

SN:

+ -18VDC@0.4A
+ -430VDC@15mA



E3074

Front



S???????

Rear

L1-VAC-XR1

L1-VAC-XR1 X-End Vacuum Rack Layout (Dxxxxxxx)

Marway MPD100 Power Distribution
 Power-Ten 3300D-3020 Switching DC Power Supply
 Power-Ten 3300D-3020 Switching DC Power Supply

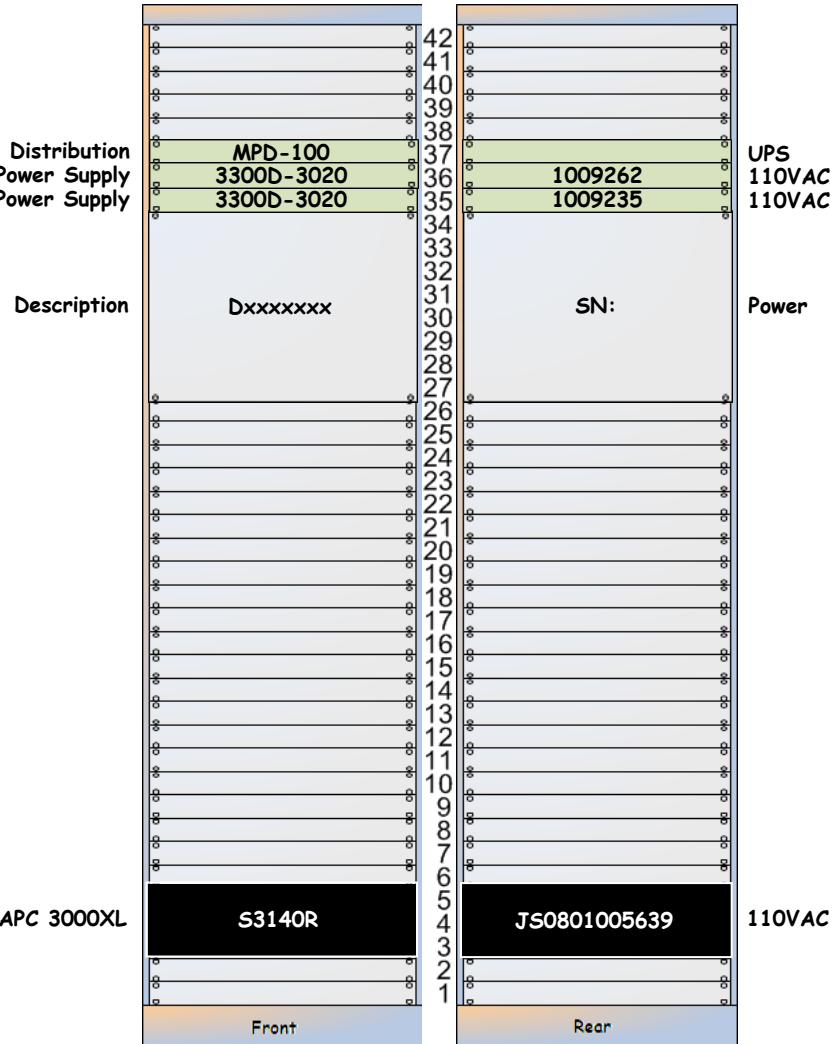

L1-VAC-XR1 Details

Marway MPD100 Power Distribution UPS

L1-VAC-XR1

Power-Ten 3300D-3020 Switching DC Power Supply 110VAC

<< [L1-VAC-XR1](#)

Description

Dxxxxxxx

SN:

--

Power

CentreCom 210TS



APC 3000XL

S3140R

JS0801005639

110VAC

Particle Counter

- Located in Mechanical Room
- +24VDC comes from Power-Ten 1009235
- 485-25E - Telebyte - Cat5 - 162-262 Port 3

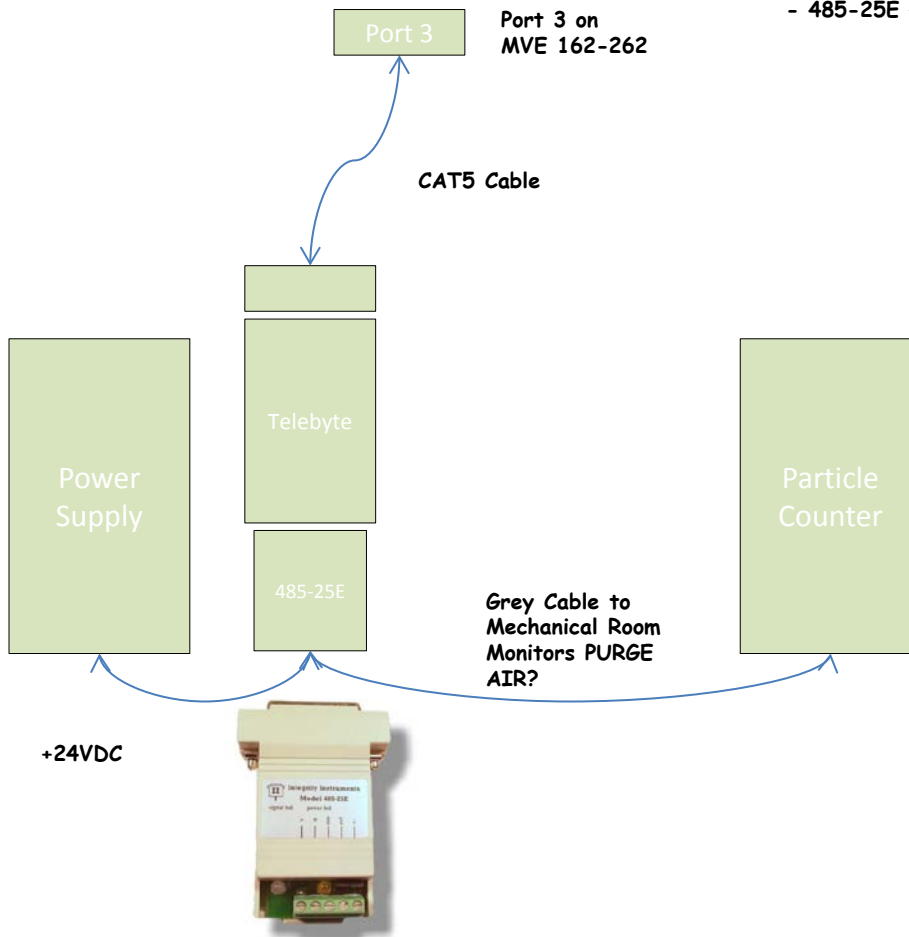

- [<< LLO Corner Station](#)
- [<< LLO Racks by AREA](#)
- [<< LLO CDS Components](#)
- [<< VEAY Fiber Patch Panel](#)

VEAY

Y-End Station Rack Layout

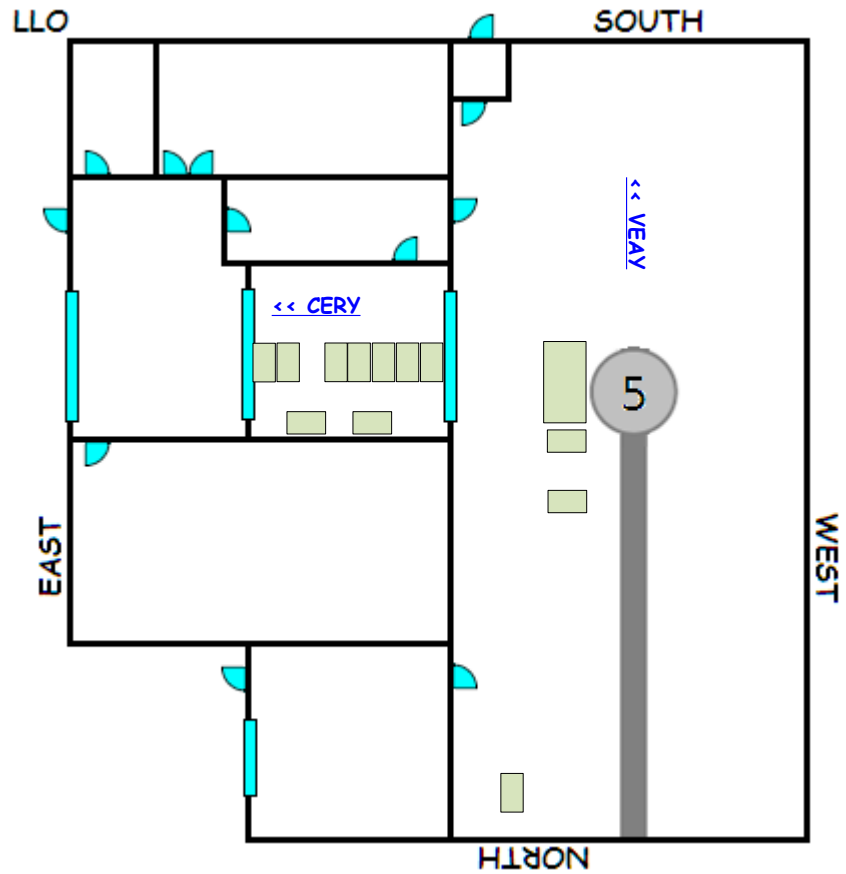

Y-End Station Rack Layout

[<< LLO Corner Station](#)

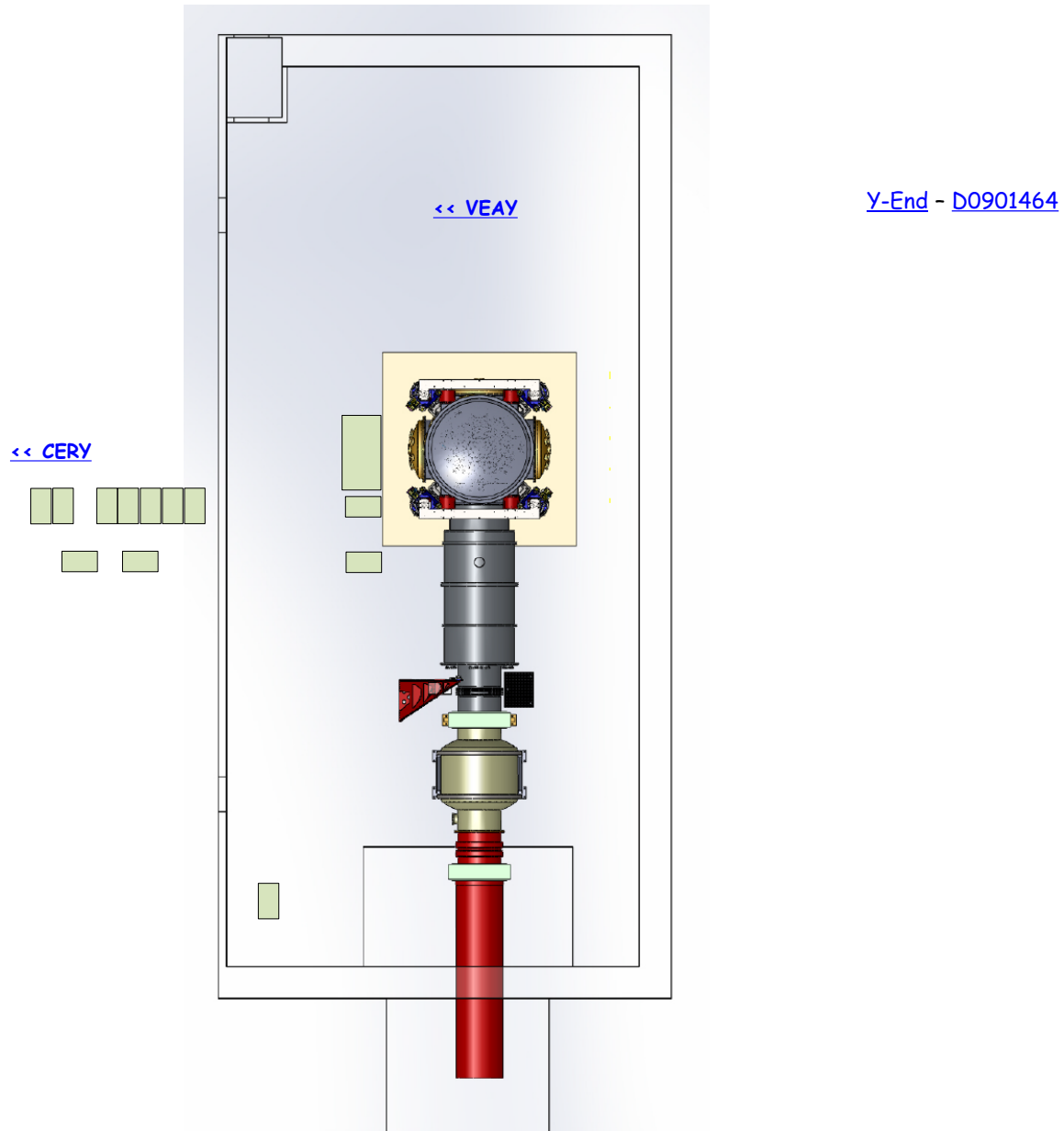

[<< LLO Racks by AREA](#)

[<< LLO Racks by Subsystems](#)

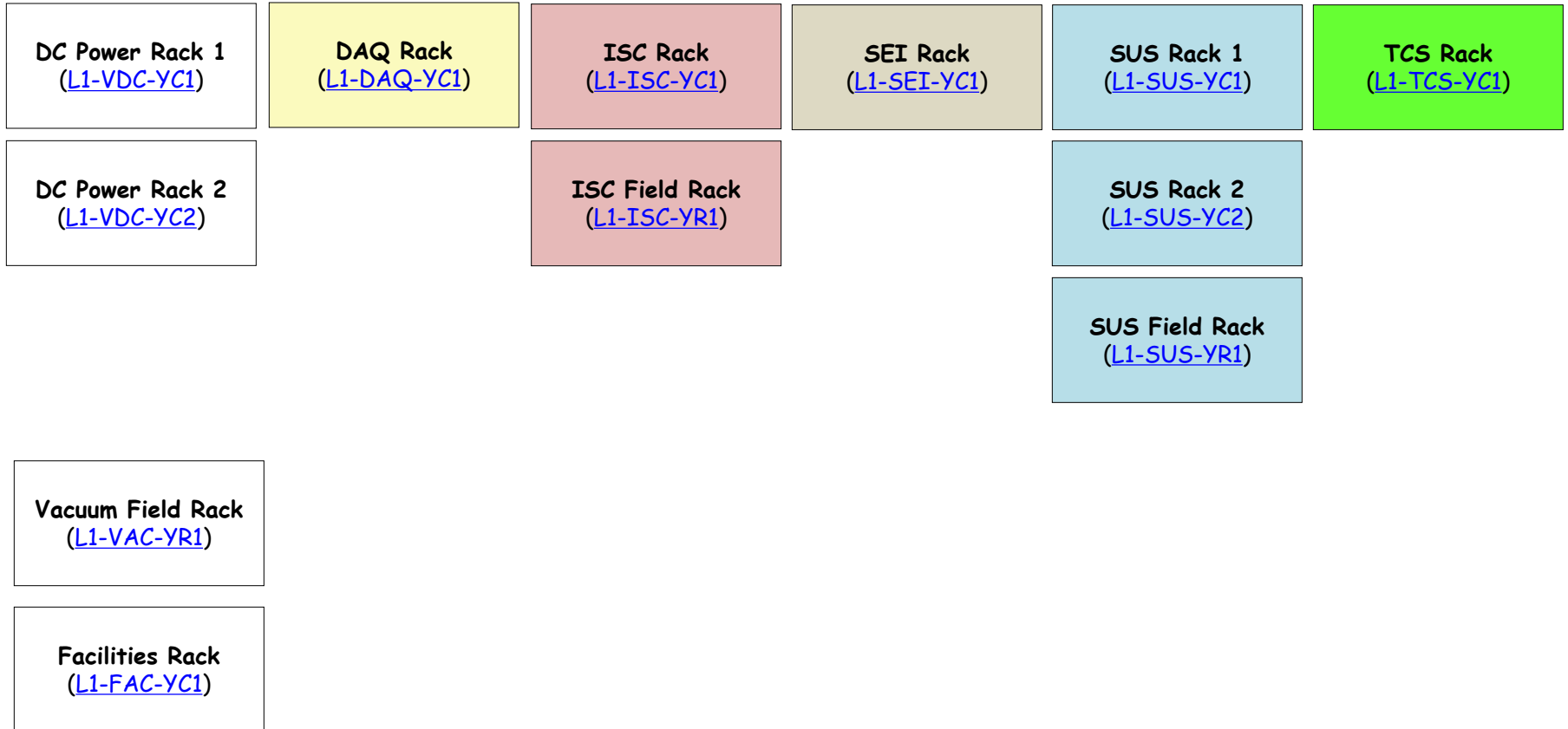

VEAY Fiber Patch Panel

VEAY Fiber Patch Panel

Patch Panel

Patch Panel

No Power

- A - FC Connectors
- B - FC Connectors
- C - NO Connectors
- D - ST Connectors
- E - NO Connectors
- F - LC Connectors

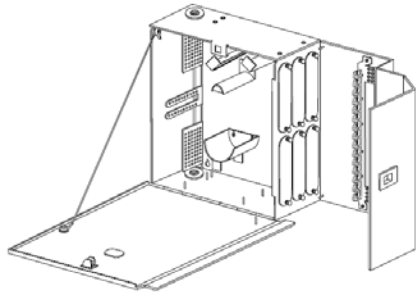

WCH-06P (up to 72 fibers) | Drawing CPC-220/5/33



3/22/2013		Y-End Fiber Patch		
Port	Type	Fiber	Designation	Description
A1	FC	Empty		
A2	FC	Y-Fiber-05	11lanfey Port 21F	IP - 10.199.0.88 Netgear GSM7224 Port 21F
A3	FC	Y-Fiber-01	Phone In/Out	TR3030WDM - Extension 151
A4	FC	Y-Fiber-06	11lanfey Port 21F	IP - 10.199.0.88 Netgear GSM7224 Port 21F
A5	FC	Empty		
A6	FC	Y-Fiber-10	CDS GS624P Port 1F	IP - 10.199.0.21 GS624P Port 1F
A7	FC	Empty		
A8	FC	Y-Fiber-09	CDS GS624P Port 1F	IP - 10.199.0.21 GS624P Port 1F
A9	FC	A11	Looped	Looped to A11
A10	FC	Y-Fiber-15	11fedagay Port 6	ACC 5595 Port 6
A11	FC	A09	Looped	Looped to A09
A12	FC	Y-Fiber-16	11fedagay Port 6	ACC 5595 Port 6
Port	Type	Fiber	Designation	Description
B1	FC	Y-Fiber-08	11neffedagay Port 21F	IP - 10.199.0.14 Netgear GSM7224 Port 21F
B2	FC	Y-Fiber-02	Security Cameras	
B3	FC	Y-Fiber-07	11neffedagay Port 21F	IP - 10.199.0.14 Netgear GSM7224 Port 21F
B4	FC	Y-Fiber-03	Kantech	Fiber Options Enclosure 501R
B5	FC	Y-Fiber-17	GC 2402 Port 26F	IP - 197.168.253.30 GC 2402 Port 26F
B6	FC	Y-Fiber-18	GC 2402 Port 26F	IP - 197.168.253.30 GC 2402 Port 26F
B7	FC	Empty		
B8	FC	Empty		
B9	FC	B11	Looped	Looped to B11
B10	FC	Y-Fiber-13	D070011 INPUT Port	L1-TCS-XC1 D070011 INPUT Port
B11	FC	B09	Looped	Looped to B09
B12	FC	Y-Fiber-14	D070011 INPUT Port	L1-TCS-XC1 D070011 INPUT Port
Port	Type	Fiber	Designation	Description
D1	ST	1X9-7	Trinet Converter	GC 2402 P9
D2	ST	1X9-7	Trinet Converter	GC 2402 P9
D3	ST	Empty		
D4	ST	Fibox	Fibox	FIBOX
D5	ST	Empty		
D6	ST	Empty		
D7	ST	1X7-14	Trinet Converter	GC 2402 P11
D8	ST	1X7-14	Trinet Converter	GC 2402 P11
D9	ST	Empty		
D10	ST	Empty		
D11	ST	Empty		
D12	ST	Empty		
Port	Type	Fiber	Designation	Description
F1	LC	Y-Fiber-19, 20	GC 2402 Port 25F	GC 2402 Port 25F
F2	LC	Empty		
F3	LC	Empty		
F4	None	Empty		
F5	None	Empty		
F6	None	Empty		

It is 65' from the L1-FAC-YC1 Rack to the knee of the waterfall in the VEAY.

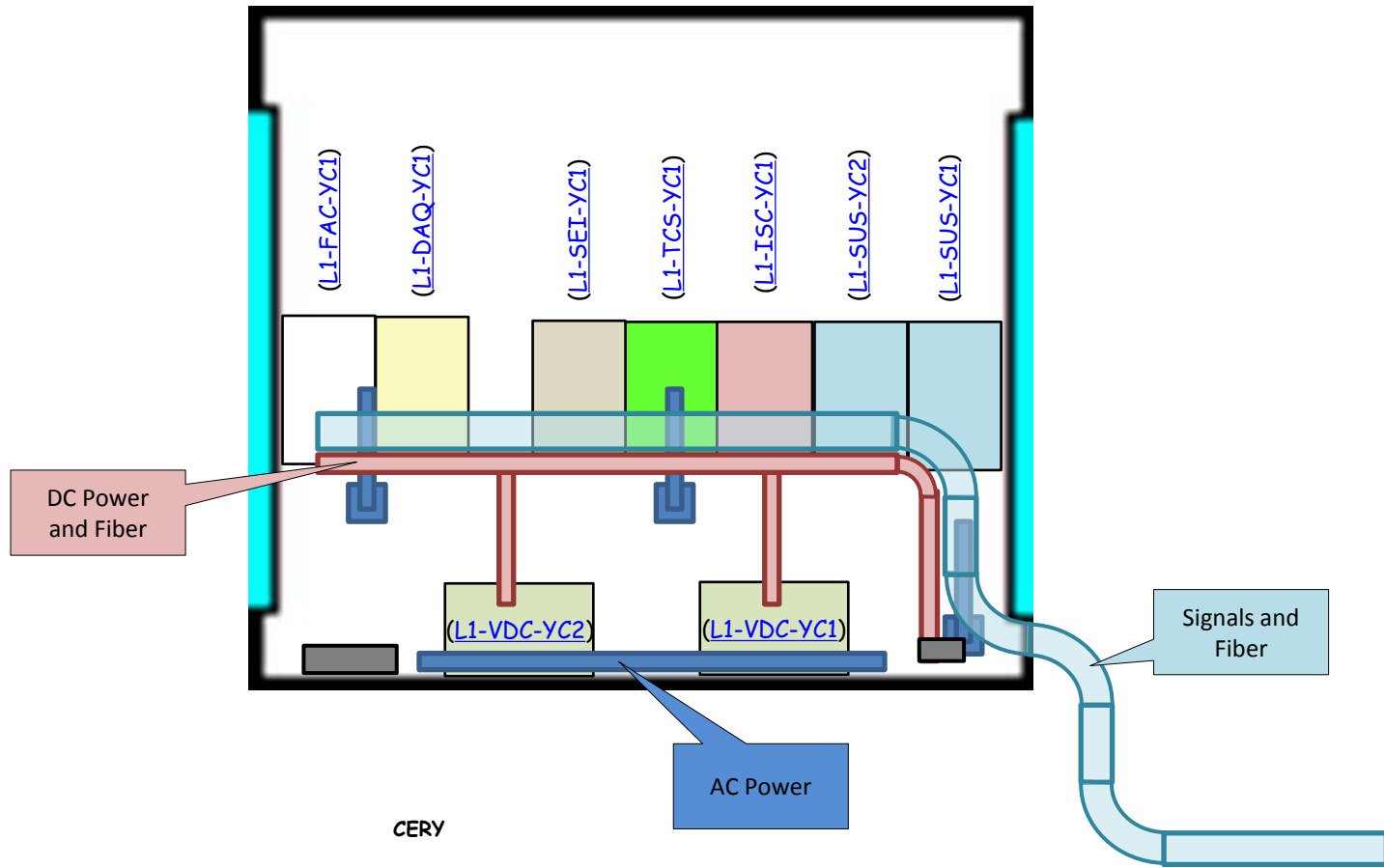

LLO Y-End Cable Tray Layout

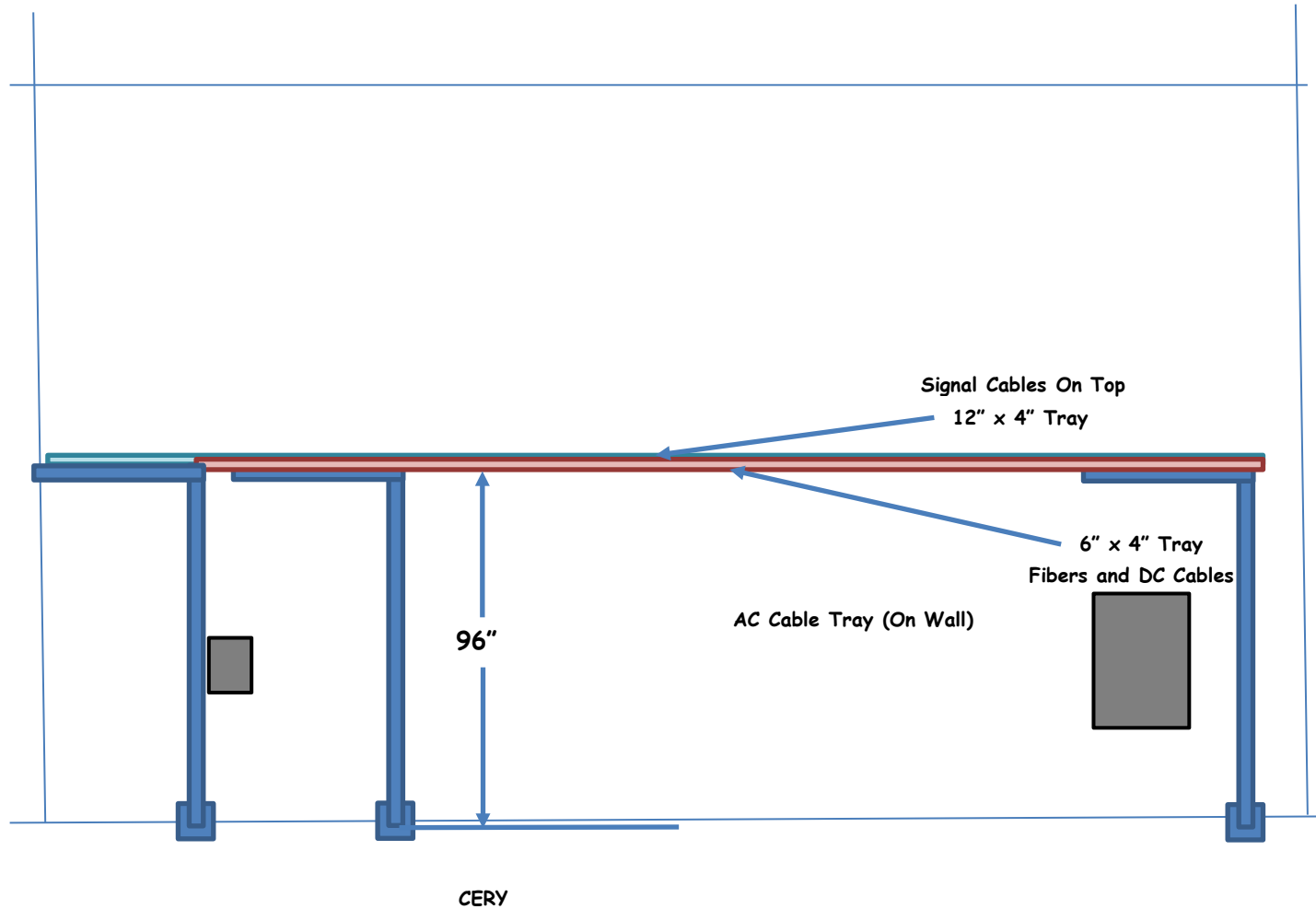

L1-VDC-YC1 Power Racks - VEAY Field Supplies

<< CERY Racks

L1-VDC-YC1 Y-End Station DC Power Rack Layout ([D1200899](#)) ([S1202313](#))

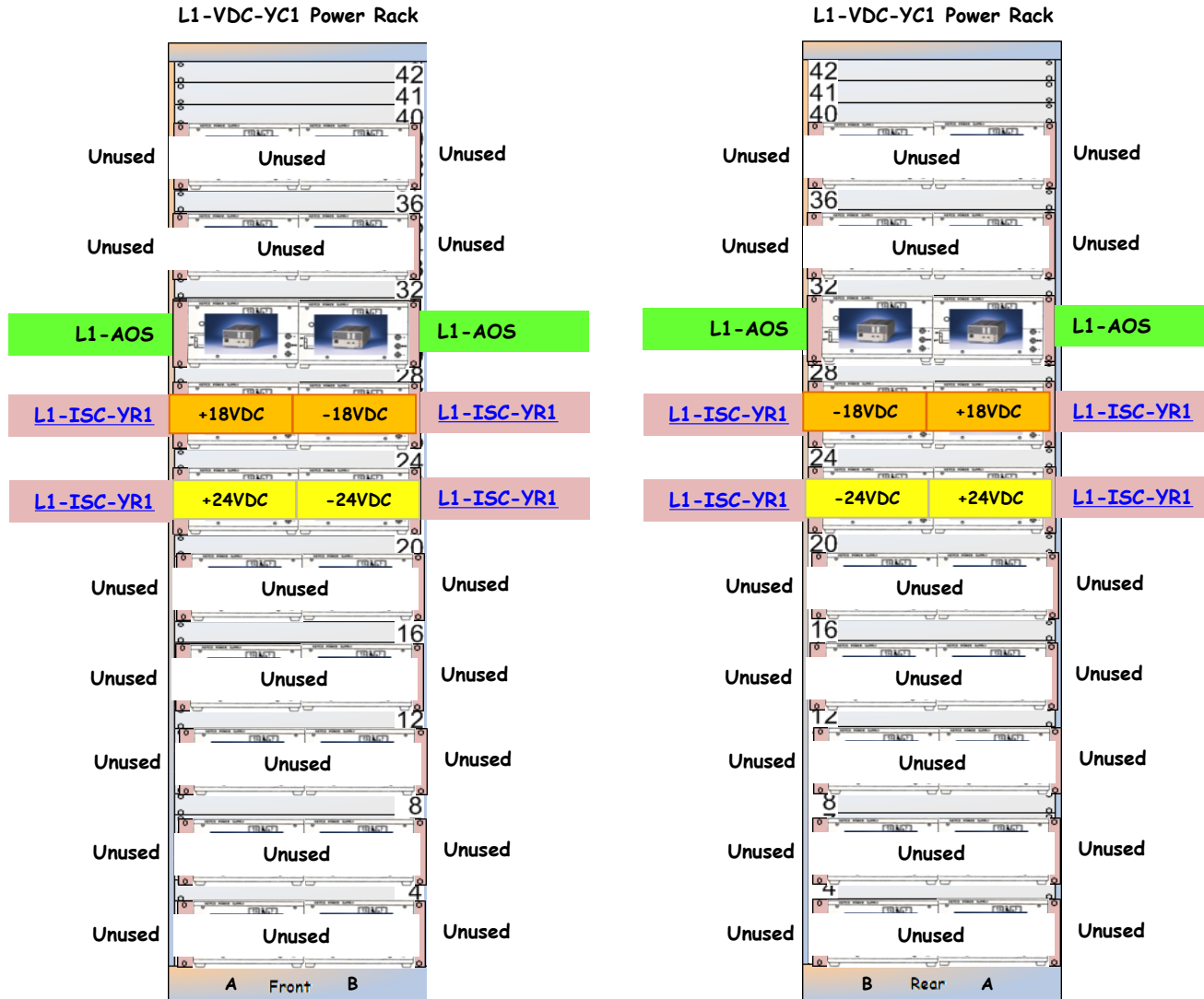

[Cable Runs >>](#)

L1-VDC-YC1 Cable Runs

<< [L1-VDC-YC1](#)

L1-VDC-YC1 Y-End Station DC Cable Runs ([D1200899](#)) ([S1202313](#))

L1-VDC-YC1 S1202313	Power Panel	Circuit	DC Power Rack	Outlet	Plug Position	Rack U	Power Supply Model	Power Supply Serial	Polarity	DC Extension Cable	Electronics Rack	Cable Length	DC Power Strip
1	CDS-Y		L1-VDC-YC1	8	Top	U37-A (Left)							
2	CDS-Y		L1-VDC-YC1	8	Bottom	U37-B (Right)							
3	CDS-Y		L1-VDC-YC1	2	Top	U33-A (Left)							
4	CDS-Y		L1-VDC-YC1	2	Bottom	U33-B (Right)							
5	CDS-Y		L1-VDC-YC1	9	Top	U29-A (Left)	BHK 500V 80mA	A107268	Plus	PBX-004	L1-AOS		
6	CDS-Y		L1-VDC-YC1	9	Bottom	U29-B (Right)	BHK 500V 80mA	A107263	Minus	PBX-004	L1-AOS		
7	CDS-Y		L1-VDC-YC1	3	Top	U25-A (Left)	JQE 25V 20A	H236441	Plus	PTO-063	L1-ISC-YR1	50	PSO-xxx
8	CDS-Y		L1-VDC-YC1	3	Bottom	U25-B (Right)	JQE 25V 20A	H236428	Minus	PTO-063	L1-ISC-YR1	50	PSO-xxx
9	CDS-Y		L1-VDC-YC1	10	Top	U21-A (Left)	JQE 25V 10A	H207939	Plus	PTY-056	L1-ISC-YR1	50	PSY-xxx
10	CDS-Y		L1-VDC-YC1	10	Bottom	U21-B (Right)	JQE 25V 10A	H207941	Minus	PTY-056	L1-ISC-YR1	50	PSY-xxx
11	CDS-Y		L1-VDC-YC1	4	Top	U17-A (Left)	JQE 25V 20A						
12	CDS-Y		L1-VDC-YC1	4	Bottom	U17-B (Right)	JQE 25V 20A						
13	CDS-Y		L1-VDC-YC1	11	Top	U13-A (Left)	JQE 25V 20A						
14	CDS-Y		L1-VDC-YC1	11	Bottom	U13-B (Right)	JQE 25V 20A						
15	CDS-Y		L1-VDC-YC1	5	Top	U09-A (Left)	JQE 25V 20A						
16	CDS-Y		L1-VDC-YC1	5	Bottom	U09-B (Right)	JQE 25V 20A						
17	CDS-Y		L1-VDC-YC1	12	Top	U05-A (Left)	JQE 25V 20A						
18	CDS-Y		L1-VDC-YC1	12	Bottom	U05-B (Right)	JQE 25V 20A						
19	CDS-Y		L1-VDC-YC1	6	Top	U01-A (Left)	JQE 25V 20A						
20	CDS-Y		L1-VDC-YC1	6	Bottom	U01-B (Right)	JQE 25V 20A						
D1200899													

L1-VDC-YC2 Power Racks - VEAY Supplies

<< CERY Racks

L1-VDC-YC2 Y-End Station DC Power Rack Layout ([D1200900](#)) ([S1202314](#))

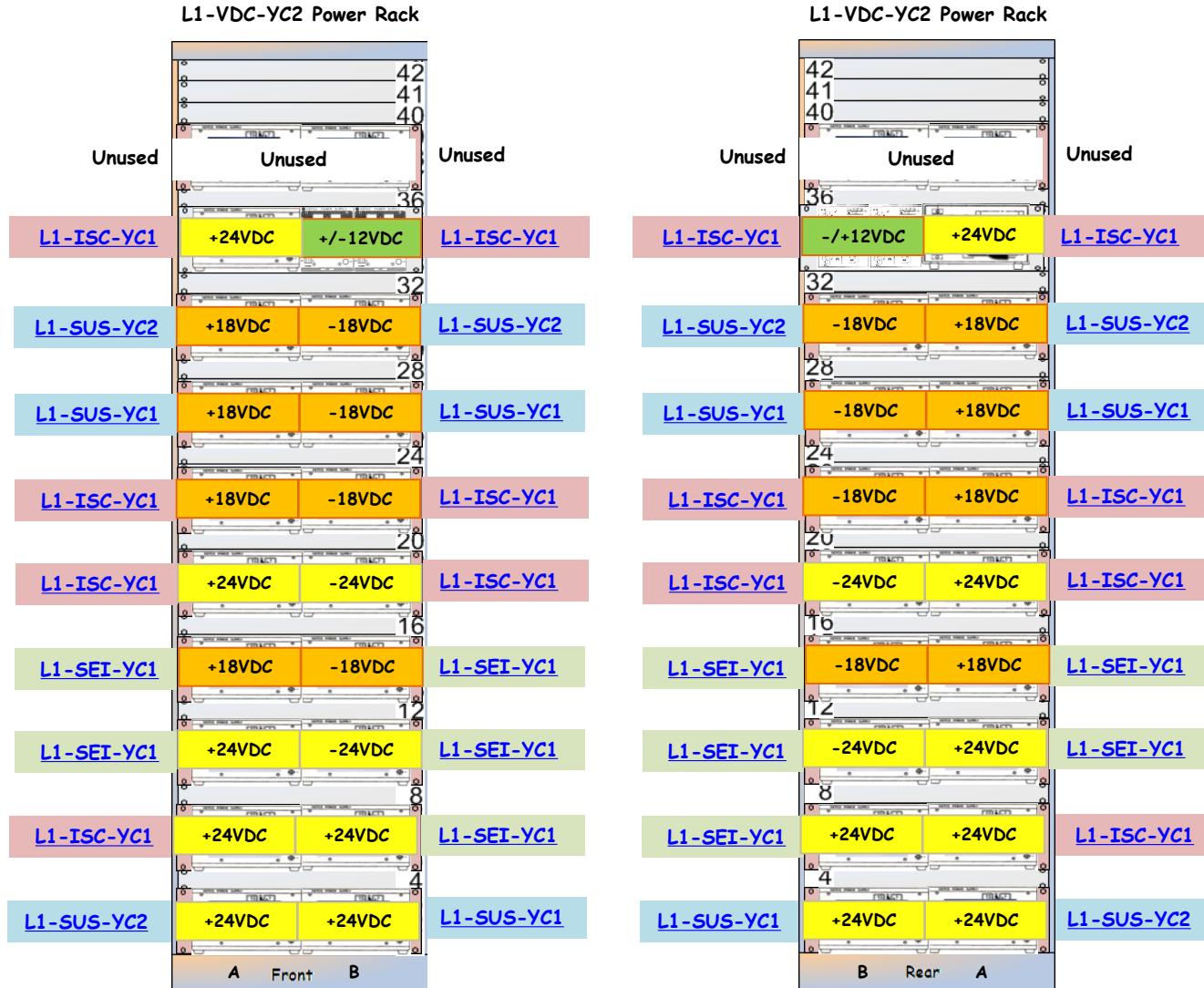

[Cable Runs >>](#)

L1-VDC-YC2 Cable Runs

<< [L1-VDC-YC2](#)

L1-VDC-YC2 Y-End Station DC Cable Runs ([D1200900](#)) ([S1202314](#))

L1-VDC-YC2 S1202314	Power Panel	Circuit	DC Power Rack	Outlet	Plug Position	Rack U	Power Supply Model	Power Supply Serial	Polarity	DC Extension Cable	Electronics Rack	Cable Length	DC Power Strip
1	CDS-Y		L1-VDC-YC2	8	Top	U37-A (Left)							
2	CDS-Y		L1-VDC-YC2	8	Bottom	U37-B (Right)							
3	CDS-Y		L1-VDC-YC2	2	Top	U33-A (Left)	JQE 25V 10A	H222056	Minus	PTY-052	L1-ISC-YC1	30	PSY-xxx
4	CDS-Y		L1-VDC-YC2	2	Bottom	U33-B (Right)	JQE 15V 6A JQE 15V 6A	H214466 H214326	Plus Minus	PTG-004	L1-ISC-YC1	30	PSG-005
5	CDS-Y		L1-VDC-YC2	9	Top	U29-A (Left)	JQE 25V 20A	H236414	Plus	PTO-050	L1-SUS-YC2	30	PSO-050
6	CDS-Y		L1-VDC-YC2	9	Bottom	U29-B (Right)	JQE 25V 20A	H236422	Minus	PTO-050	L1-SUS-YC2	30	PSO-050
7	CDS-Y		L1-VDC-YC2	3	Top	U25-A (Left)	JQE 25V 20A	H236504	Plus	PTO-051	L1-SUS-YC1	32	PSO-051
8	CDS-Y		L1-VDC-YC2	3	Bottom	U25-B (Right)	JQE 25V 20A	H236513	Minus	PTO-051	L1-SUS-YC1	32	PSO-051
9	CDS-Y		L1-VDC-YC2	10	Top	U21-A (Left)	JQE 25V 20A	H236508	Plus	PTO-052	L1-ISC-YC1	28	PSO-052
10	CDS-Y		L1-VDC-YC2	10	Bottom	U21-B (Right)	JQE 25V 20A	H236516	Minus	PTO-052	L1-ISC-YC1	28	PSO-052
11	CDS-Y		L1-VDC-YC2	4	Top	U17-A (Left)	JQE 25V 20A	H236503	Plus	PTY-040	L1-ISC-YC1	28	PSY-040
12	CDS-Y		L1-VDC-YC2	4	Bottom	U17-B (Right)	JQE 25V 20A	H236488	Minus	PTY-040	L1-ISC-YC1	28	PSY-040
13	CDS-Y		L1-VDC-YC2	11	Top	U13-A (Left)	JQE 25V 20A	H236500	Plus	PTO-053	L1-SEI-YC1	22	PSO-053
14	CDS-Y		L1-VDC-YC2	11	Bottom	U13-B (Right)	JQE 25V 20A	H236520	Minus	PTO-053	L1-SEI-YC1	22	PSO-053
15	CDS-Y		L1-VDC-YC2	5	Top	U09-A (Left)	JQE 25V 20A	H236519	Plus	PTY-041	L1-SEI-YC1	22	PSY-041
16	CDS-Y		L1-VDC-YC2	5	Bottom	U09-B (Right)	JQE 25V 20A	H236487	Minus	PTY-041	L1-SEI-YC1	22	PSY-041
17	CDS-Y		L1-VDC-YC2	12	Top	U05-A (Left)	JQE 25V 20A	H236502	Plus	PTY-042	L1-ISC-YC1	30	PSY-042
18	CDS-Y		L1-VDC-YC2	12	Bottom	U05-B (Right)	JQE 25V 20A	H236518	Plus	PTY-043	L1-SEI-YC1	22	PSY-043
19	CDS-Y		L1-VDC-YC2	6	Top	U01-A (Left)	JQE 25V 20A	H236521	Plus	PTY-044	L1-SUS-YC2	32	PSY-044
20	CDS-Y		L1-VDC-YC2	6	Bottom	U01-B (Right)	JQE 25V 20A	H236507	Plus	PTY-045	L1-SUS-YC1	32	PSY-045
D1200900													

L1-DAQ-YC1

<< CERY Racks

L1-DAQ-YC1 Y-End Station Remote Rack Layout (D1201092) (S1202956)

Serial to Internet Converter

10.110.140.58
10.110.140.57
10.110.140.56
10.110.140.55

		42				
Dolphin RFM Switch	DXS410	41	AD053708007		UPS2	
ACC 5595 Reflective Memory Hub	ACC 5595	40			UPS2	
l1netfedaqy 10.199.0.88	GSM7224	39	36106691		UPS2	
l1lanfey 10.199.0.14	GSM7224	38	2B62045400019		UPS2	
<small>Solid Shelf</small>		37	2B62045K0015D		UPS2	
		36				
		35				
		34				
Timing IRIG-B Interface Chassis	D0900301	33	S1202408		+12VDC (from FAC)	
		32				
Serial Concentrator Chassis	D1100632	31	Sxxxxxxx		±18VDC	
Beckhoff Slow Controls	D1002961	30	S1103498		+24VDC	
ISC Common		29				
<small>Perforated Shelf</small>		28				
		27				
		26				
		25				
		24				
		23				
		22				
		21				
ATEN KVM Switch	CL1016M	20	SN:		UPS2	
l1susauxey Front End Computer	Dxxxxxxx	19	SN:		UPS1 & 110VAC	
l1susey Front End Computer	Dxxxxxxx	18	SN:		UPS1 & 110VAC	
l1seiey Front End Computer	Dxxxxxxx	17	SN:		UPS1 & 110VAC	
l1seiey Front End Computer	Dxxxxxxx	16	SN:		UPS1 & 110VAC	
l1iseicy Front End Computer	Dxxxxxxx	15	SN:		UPS1 & 110VAC	
l1iseicy Front End Computer	Dxxxxxxx	14	SN:		UPS1 & 110VAC	
l1ecaty1 Beckhoff Host Computer	Dxxxxxxx	13	SN:		UPS1 & 110VAC	
l1ecaty1 Beckhoff Host Computer	Dxxxxxxx	12	SN:		UPS1 & 110VAC	
Hartmann Sensor Computer	T1000702	11	SN:		UPS1 & 110VAC	
		10	SN:		UPS1 & 110VAC	
		9	SN:		UPS1 & 110VAC	
		8				
		7				
		6				
		5				
		4				
		3				
UPS Group 1 and Group 2	APC SMT2000MLV2U	2	J51048023241		110VAC	
		1				
	Front		Rear			

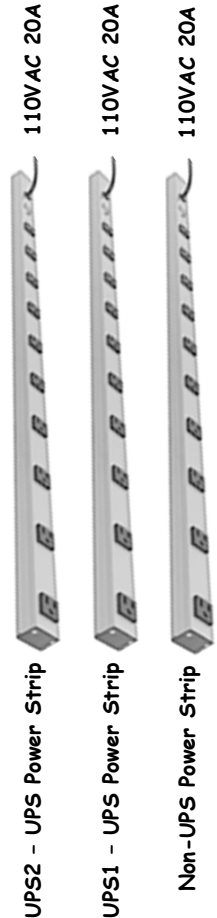

L1-DAQ-YC1 Details

<< L1-DAQ-YC1

Dolphin RFM Switch

DXS410

AD053708007

UPS2



ACC 5595

Front

To I1 lanfey port 5



AD053708007

Rear

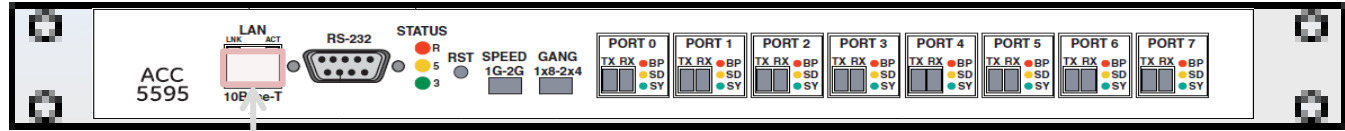

ACC 5595

Front

To L1lanfey port 5

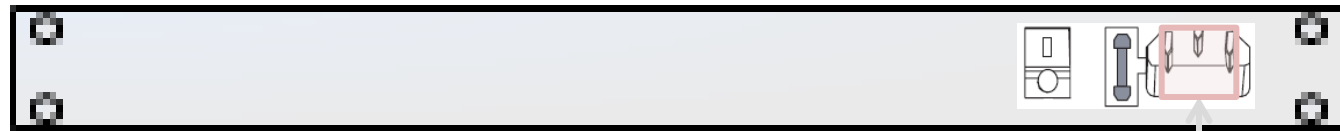

36106691

Rear

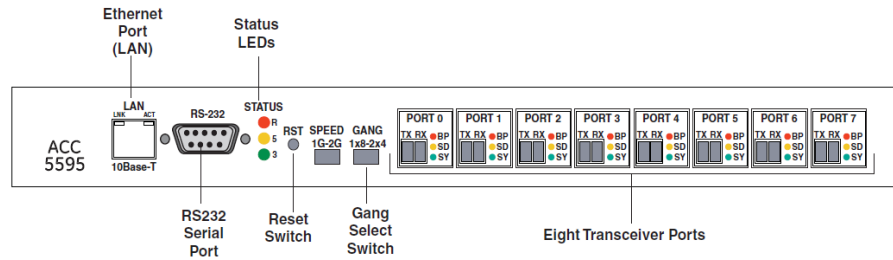

To UPS Power Strip



GSM7224

Front
C0:3F:0E:86:84:04

2 - To FE NET Port

21F - To 1Y23 PP E1, E2



2B62045400019

Rear

To UPS Power Strip



GSM7224

Front

CO:3F:0E:86:89:14



2 - To FE LAN Port

5 - To 5595 LAN 10BaseT

21F - To 1Y23 PP A1, A2



2B62045K0015D

Rear

To UPS Power Strip

Timing IRIG-B Interface Chassis

D0900301

S1202408

Power

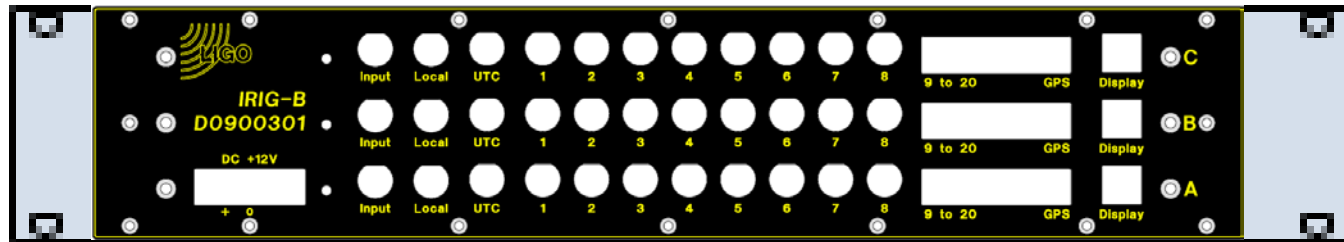
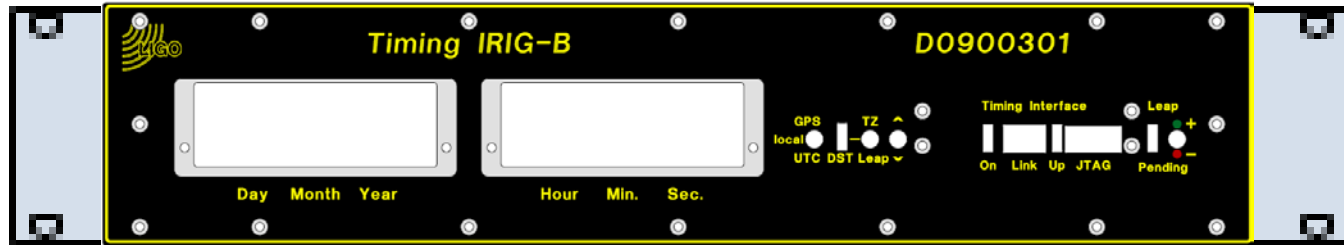

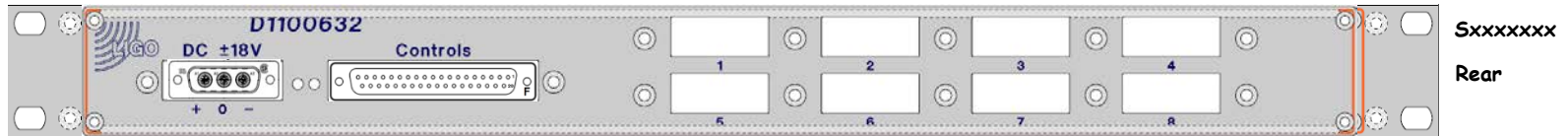
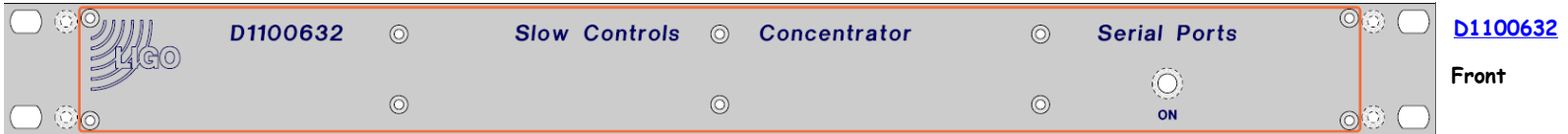

<< L1-DAQ-YC1

Beckhoff Slow Controls
ISC Common

D1002961

S1103498

+24VDC

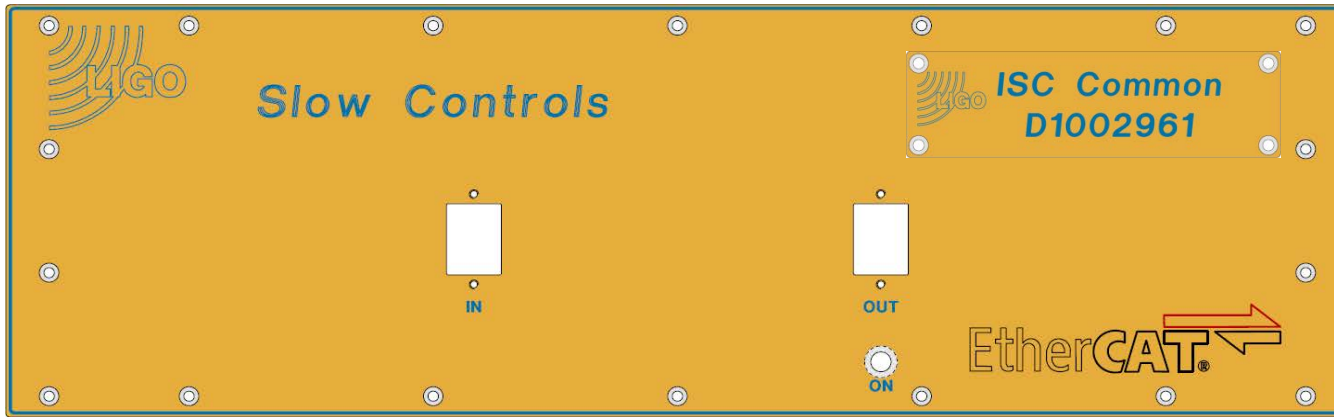

D1002961

Front: D0902553

Name: D1002962

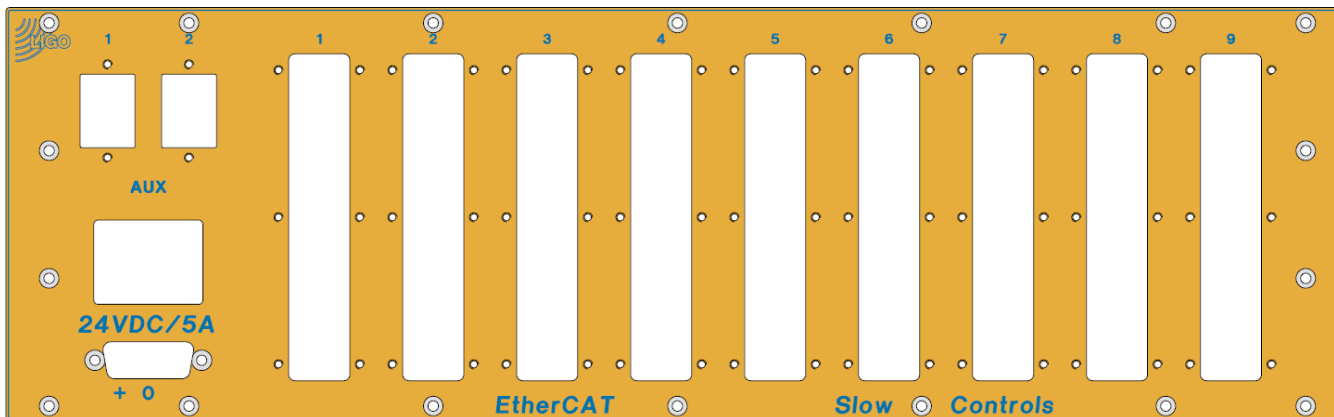

S1103498

Rear: D0902554

<< L1-DAQ-YC1

ATEN KVM Switch

CL1016M

SN:

110VAC



l1susauxey Front End

l1iscey Front End

l1iscey Front End Computer

Front End

SN:

110VAC



Hartmann Sensor Computer Front End

<< [L1-DAQ-YC1](#)

Hartmann Sensor Front End Computer

[T1000702](#)

SN:

110VAC

APC SMX2000RMLV2U

UPS

[APC SMX2000RMLV2U](#)

J51048023241

110VAC



[APC SMX2000RMLV2U](#)

Front

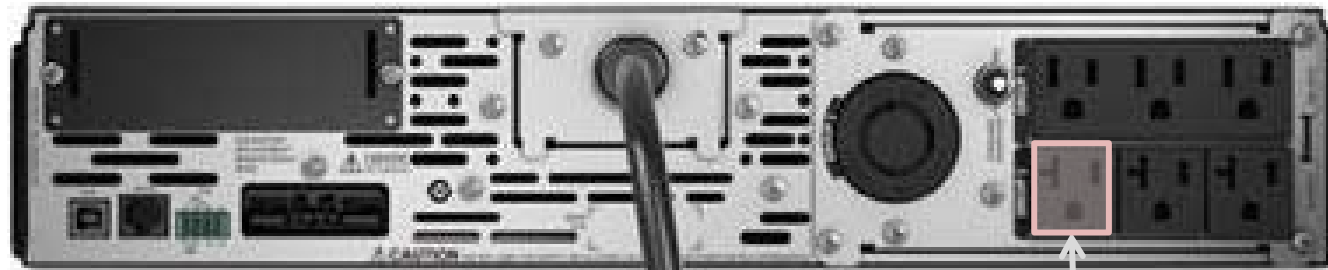

J51048023241

Rear

[To UPS Power Strip](#)

L1-FAC-YC1

L1-FAC-YC1 Facilities Y-End Station Remote Rack Layout (D1201093) (S1202957)

- [Brocade FastIron Edge GS624P](#)
Solid Shelf
- [2402 Network Switch](#)
Solid Shelf
- [Kantech](#)
Perforated Shelf
- [Control](#)
- [Trinet Fibox](#)
Perforated Shelf
- [Phone](#)
- [Security Cameras](#)
- [IFO Cameras](#)

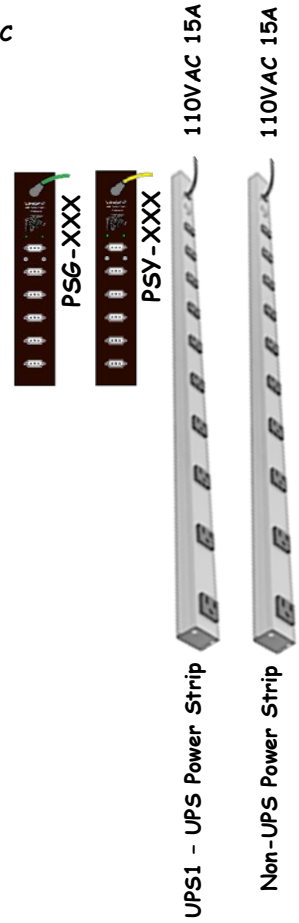
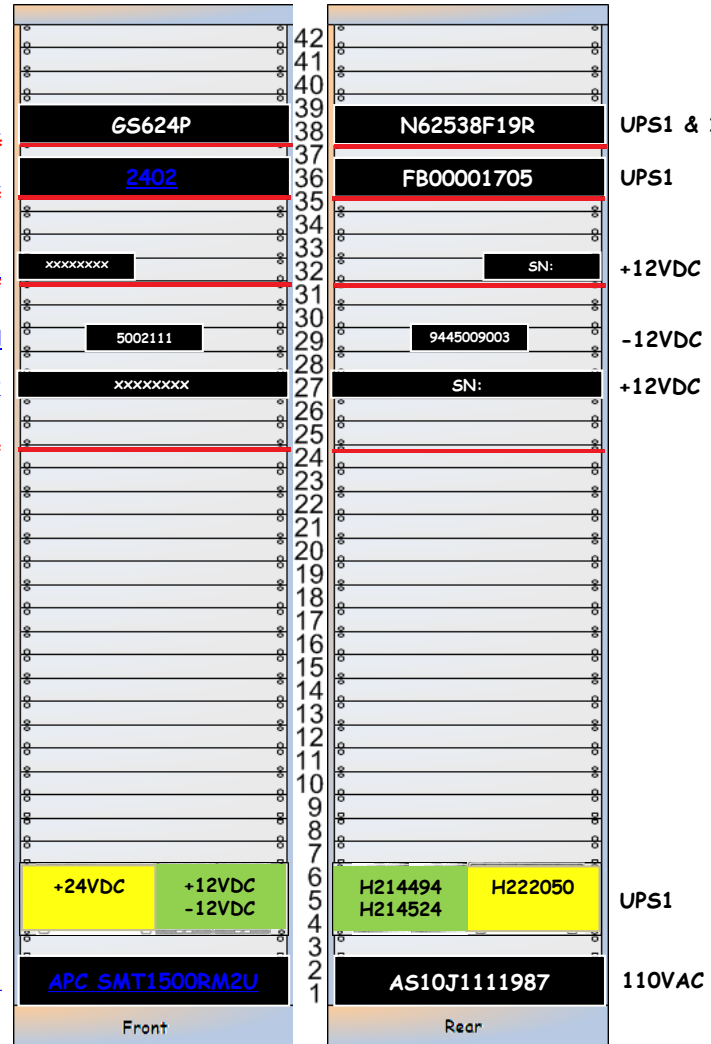

L1-FAC-YC1 Details

Brocade FastIron Edge GS624P

<< L1-FAC-YC1

Brocade FastIron Edge GS624P

GS624P

N62538F1A3

UPS & 110VAC

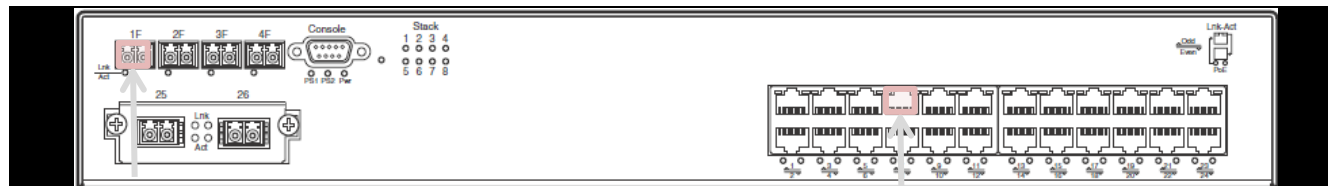

GSM7224

Front
CO:3F:0E:86:88:E0

21F - To 1Y23 PP B1.B2

3 - To FE NET Port

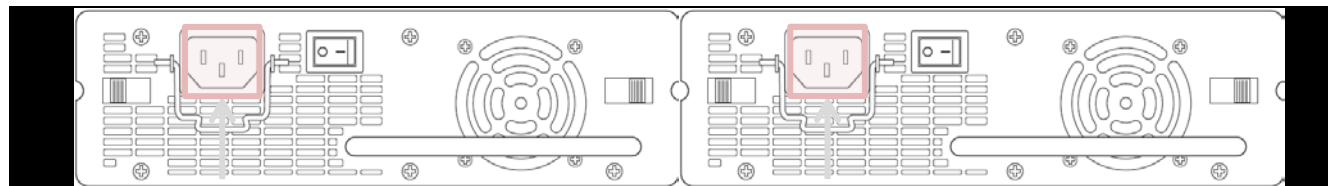

N62538F1A3

Rear

To 110 Power Strip

To UPS Power Strip

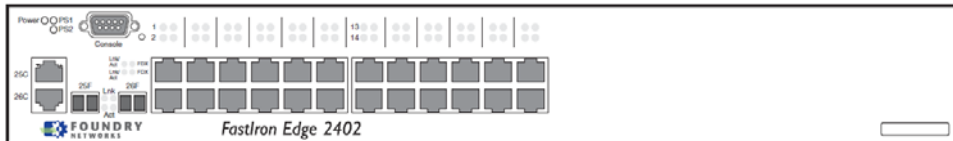

- Empty ↔ 01
- Empty ↔ 02
- Empty ↔ 03
- Empty ↔ 04
- Empty ↔ 05
- Empty ↔ 06
- To Camera on Reel ↔ 07
- Empty ↔ 08
- To Trinet/Trinet ↔ 09
- Empty ↔ 10
- To Trinet/Trinet ↔ 11
- Empty ↔ 12
- Empty ↔ 13
- To Seimens ↔ 14
- Empty ↔ 15
- Empty ↔ 16
- Empty ↔ 17
- Empty ↔ 18
- Empty ↔ 19
- Empty ↔ 20
- To Weather Station ??? ↔ 21
- Empty ↔ 22
- Empty ↔ 23
- Empty ↔ 24

- Empty ↔ 25C
- Empty ↔ 26C
- To Special Cable CSR1 ↔ 25F
- To 1Y23 PP D3, E3 ↔ 26F

G12039
192.168.253.30

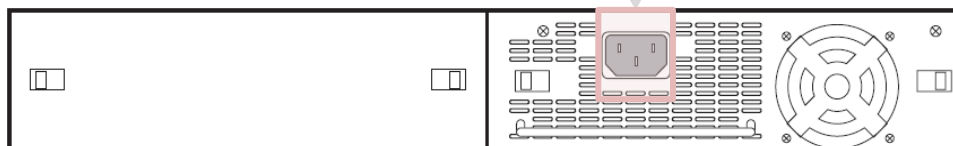

PS1

Y-End - Kantech Interface

LIGO

<< [L1-FAC-YC1](#)

Kantech

Fiber Options
[7711-R \(501R\)](#)
Optical In/Out:
[To 1Y23 PP D2](#)
Power: 13.5VDC
from Wall Wart

Blue CAT5:
1=O/W and
B/W, 4=O, 7=B

Powered from
Wall Wart from
Isolated Power

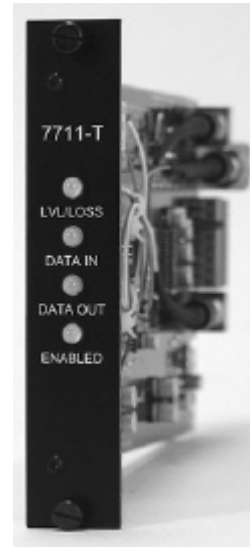
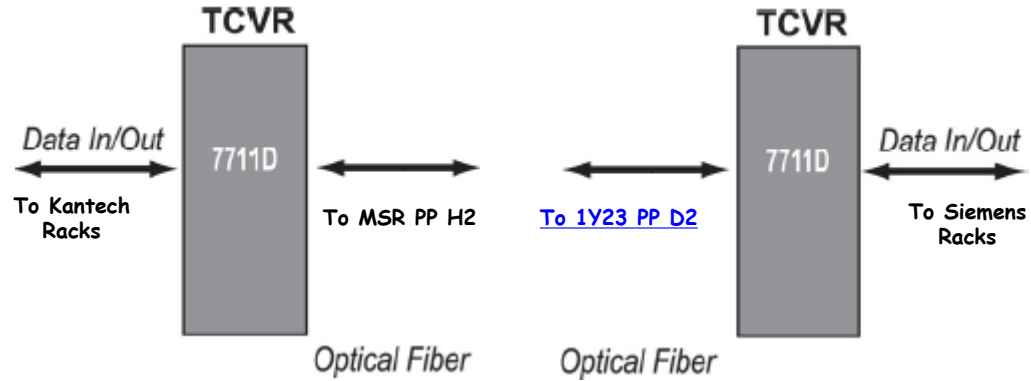

Y-End - Control Interface

Control

5002111

9445009003

-12VDC

[Control DeviceMaster 4 with DB9 Ports](#)

DeviceMaster 4 with DB9 ports



MAC Address:
00-C0-4E-07-6E-3A

IP Address:
10.110.60.54

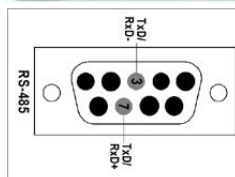

4-Port Power Supply

This table provides the specifications for the power supply shipped with the DeviceMaster 4-port.

Control Power Supply: 4-Port	
Input line frequency	47 - 63 Hz
Input line voltage	90 - 260 VAC
Output voltage	24VDC
Output current	500 mA @ 24VDC

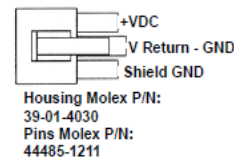

3M Shell 3357-9209

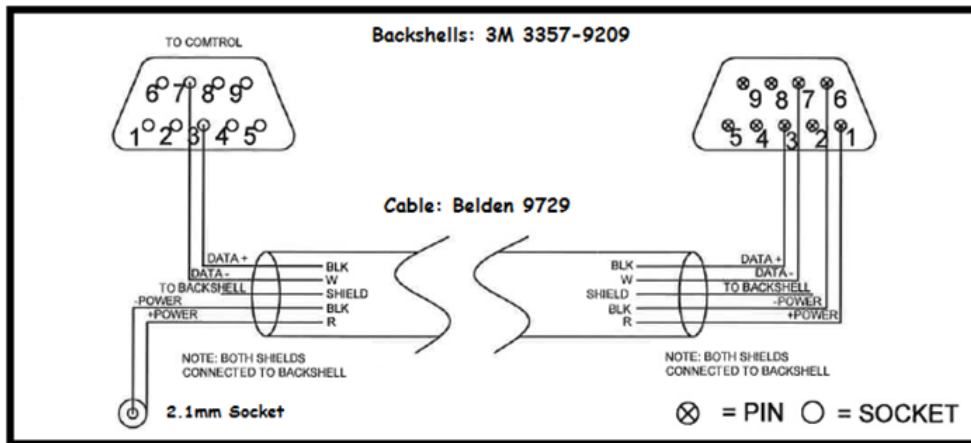

3M Shell 3357-9209



2.1mm Socket
(Note polarity)

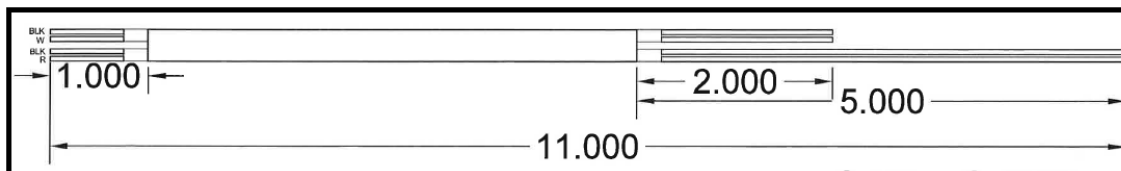

2.1mm Plug
(Note polarity)

Trinet FIBOX Panel

Trinet FIBOX Panel

Trinet **FIBOX** Panel

Trinet Panel

12VDC



- Empty <--> 1
- Trinet Z <--> 2
- Trinet Y <--> 3
- Trinet X <--> 4

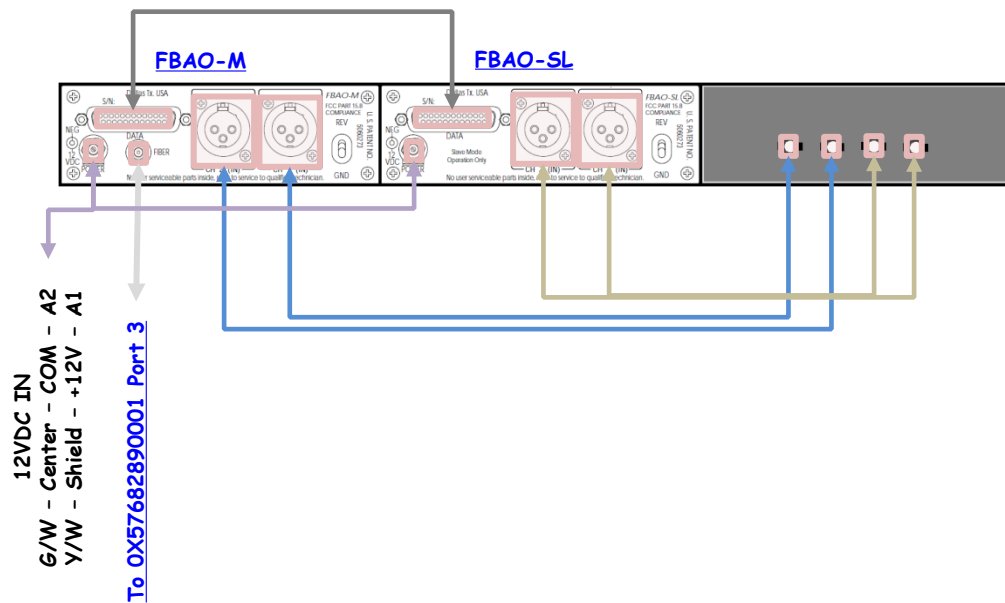

<< L1-FAC-YC1

Magnetometer: [Bartington Instruments](#)
MAG-03MC

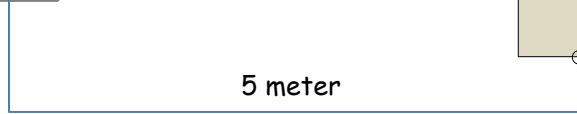

5 meter

Black - G/W ... Ground
Stria - Y/W ... +12VDC

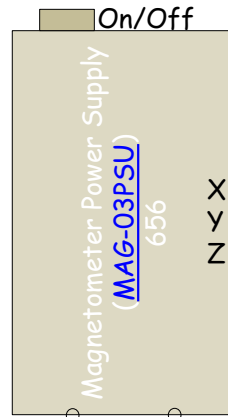
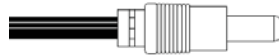

On/Off

X
Y
Z

Powered from
12VDC DIN rails

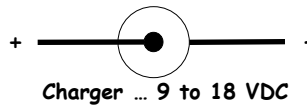

Charger ... 9 to 18 VDC

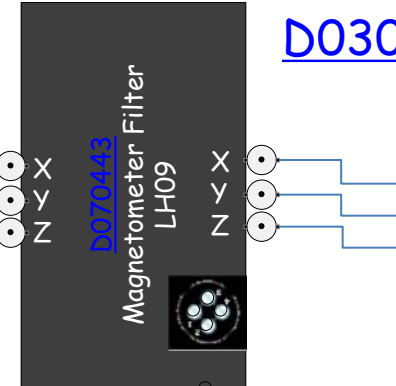

[D030574](#)

[D070443](#)
Magnetometer Filter
LH09

X
Y
Z

X
Y
Z



Pin 1 - Red
Pin 2 - Black
Pin 3 - White
Pin 4 - Black

Powered from
15VDC DIN rails

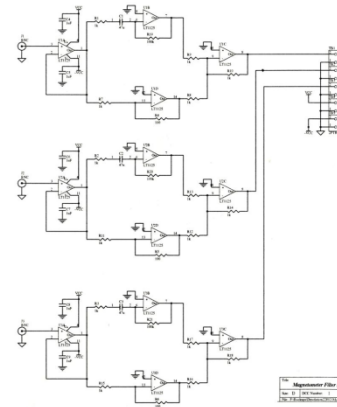

Magnetometer Filter Board

<< [L1-FAC-YC1](#)

IFO Cameras

[VT5030 IFS](#)
International
Fiber Systems,
Inc.
IFS.com
Optical Out:
[To 1Y23 PP B6](#)
Power: 12VDC
Video Input:
Camera 1
Camera 2

Powered from
DIN rails

Security Cameras

[VT7430-2DRDT](#)
Optical In/Out:
[To 1Y23 PP D1](#)
Power: 12VDC
Output: Ch1,
Ch2, Ch3 BNCs
to Cameras

Powered from
Wall Wart from
Isolated Power

Revere Video
Master Power
Supply Model
[RT24/16500](#)
Outputs to
Cameras 1,2,3

*LEDs on with
bad fuse
Note: 8 LEDs
are on.

AC Powered
from Isolated
Power

Kantech

Fiber Options
[7711-R \(501R\)](#)
Optical In/Out:
[To 1Y23 PP D2](#)
Power: 13.5VDC
from Wall Wart

Blue CAT5:
1=O/W and
B/W, 4=O, 7=B

Powered from
Wall Wart from
Isolated Power

Seismic Vault

J/E-CF-01
TriNet
Converter
CAT5:
[To 2402 P9](#)
TX:
[To 0X57... P1](#)
RX:
[To 0X57... P2](#)
Power: 12VDC

Powered from
DIN rails

J/E-CF-01
TriNet
Converter
CAT5:
[To 2402 P11](#)
TX:
[To 0X57... P8](#)
RX:
[To 0X57... P7](#)
Power: 12VDC

Powered from
DIN rails

Phone

[TR3030WDM](#)
GE Security
Optical In/Out:
[To 1Y23 PP B2](#)
Phone: Copper to
VEA
Power: 12VDC

Powered from Wall Wart from
Tripp-Lite UPS
Model BC320
9834DY0BC614000661 To 6-
Outlet Power Strip in Non-
isolated wall socket

Y-End - Security Cameras

Security Cameras

Reverse Video
Master Power
Supply Model
[RT24/16500](#)
Outputs to
Cameras 1,2,3

*LEDs on with
bad fuse
Note: 8 LEDs
are on.

AC Powered
from Isolated
Power



RT24/16500

AC Power120 VAC LED supervised
Non-grounded power cord
furnished
Output24 VAC, 8 amps total
Outputs16 @ 500mA individually
fused at 1/2 amp and
individually supervised
Dimensions7.5" W x 8.25" H x 3.5" D
CabinetHeavy gauge steel



VAC

Y-End - Security Cameras

Security Cameras

VT7430-2DRDT

Optical In/Out:

To 1Y23 PP D1

Power: 12VDC

Output: Ch1,
Ch2, Ch3 BNCs
to Cameras

Powered from
Wall Wart from
Isolated Power

cameras
75-ohm coaxial cables

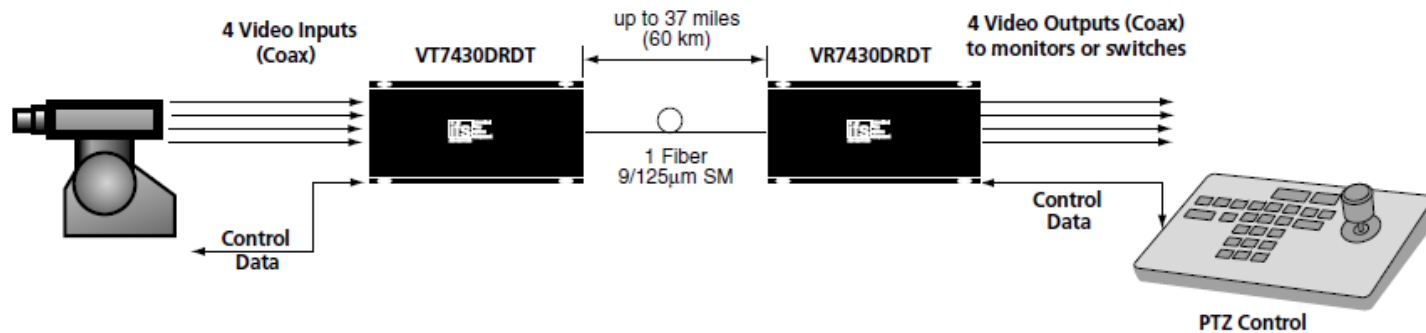

Cameras

[VT5030 IFS](#)
International
Fiber Systems,
Inc.
IFS.com
Optical Out:
[To 1Y23 PP B6](#)
Power: 12VDC
Video Input:
Camera 1
Camera 2

Powered from
DIN rails

cameras
75-ohm coaxial cables

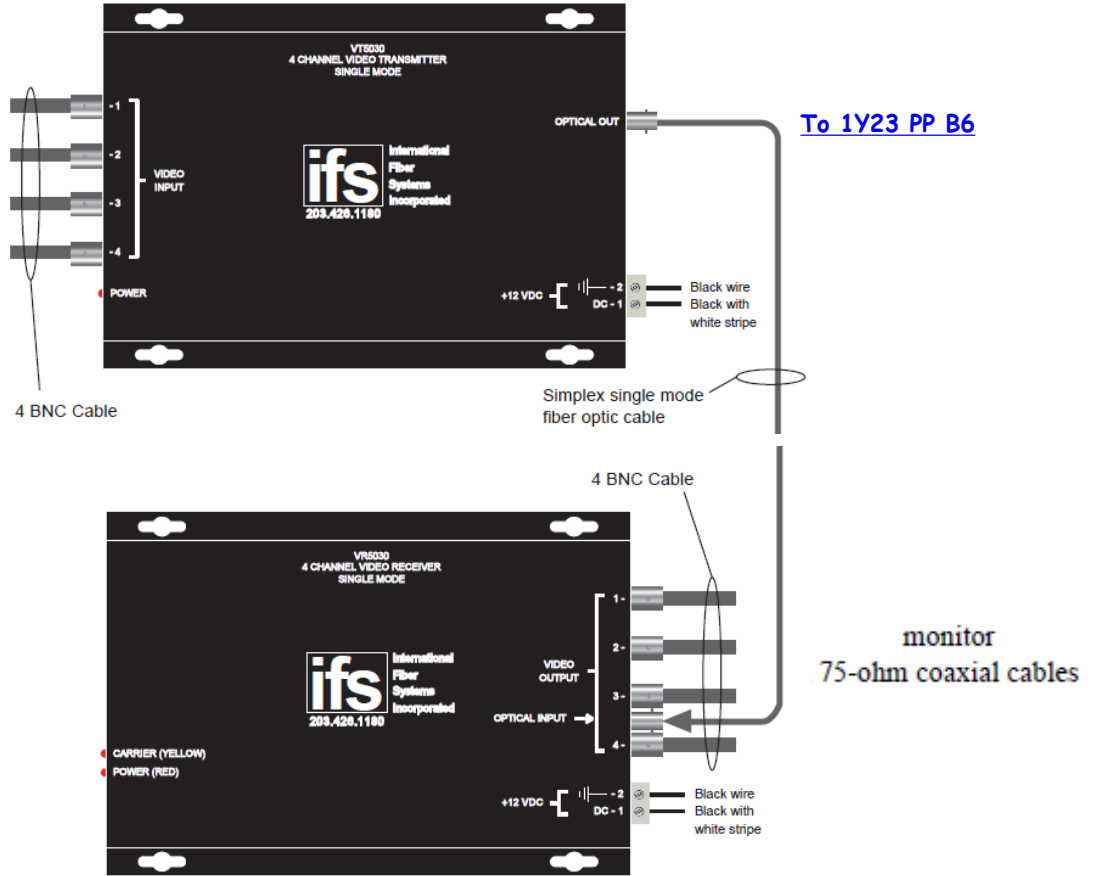

[To 1Y23 PP B6](#)

monitor
75-ohm coaxial cables

Y-End - Trinet

Seismic Vault

<p>J/E-CF-01 TriNet Converter CAT5: To 2402 P9 TX: To OX57... P1 RX: To OX57... P2 Power: 12VDC</p>	<p>J/E-CF-01 TriNet Converter CAT5: To 2402 P11 TX: To OX57... P8 RX: To OX57... P7 Power: 12VDC</p>
Powered from DIN rails	Powered from DIN rails

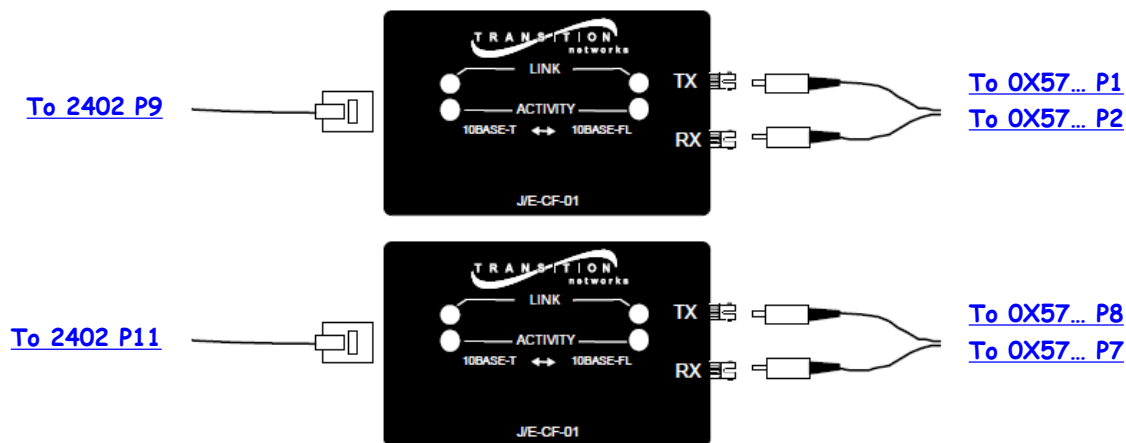

For network installation, the J/E-CF-01 media converter provides an RJ-45 twisted pair connector and a set of RX (receive) and TX (transmit) ST connectors to 850 nm multimode fiber-optic cable.

Y-End - Phone

Phone

[TR3030WDM](#)
 GE Security
 Optical In/Out:
[To 1Y23 PP B2](#)
 Phone: Copper to
 VEA
 Power: 12VDC

Powered from Wall Wart from
 Tripp-Lite UPS
 Model BC320
 9834DY0BC614000661 To 6-
 Outlet Power Strip in Non-
 isolated wall socket



System Design

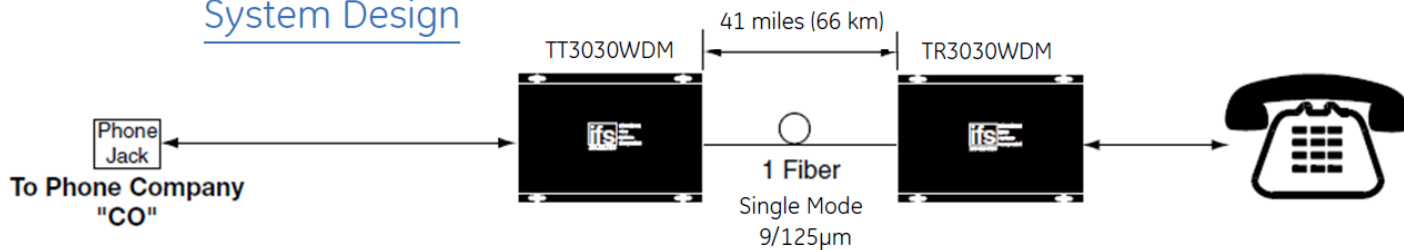

KEPCO Power Supplies

KEPCO Power Supplies

+24VDC	+12VDC -12VDC
--------	------------------

H214494 H214524	H222050
--------------------	---------

UPS1

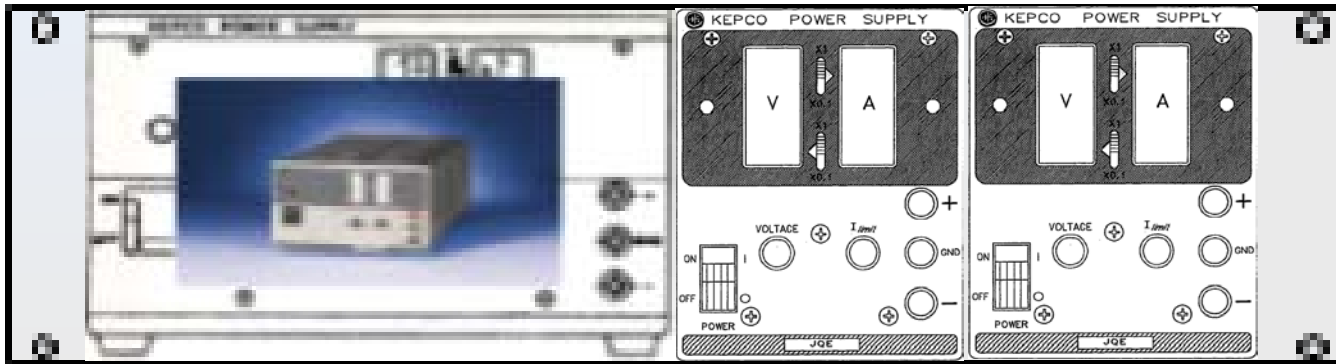

Front

KEPCO JQE 25-10
+24VDC

KEPCO JQE 15-6
+12VDC

KEPCO JQE 15-6
-12VDC

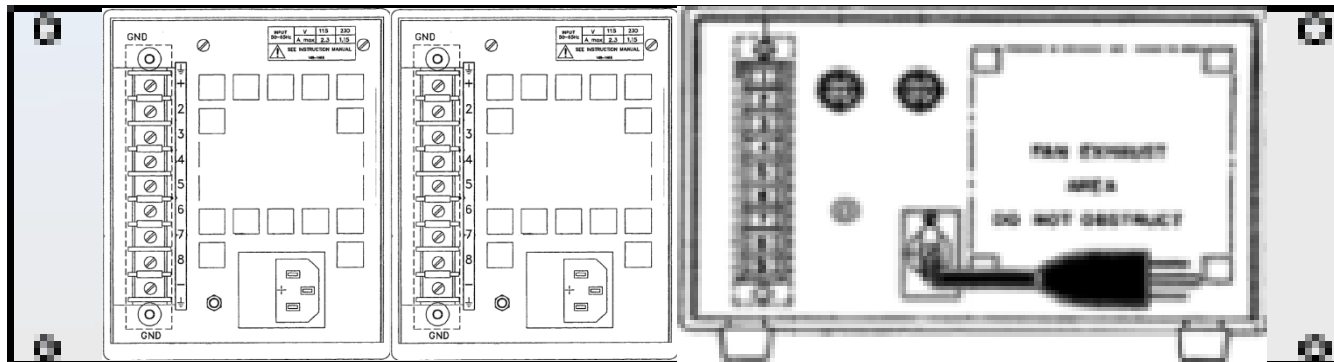

Rear

KEPCO JQE 15-6
H214524

KEPCO JQE 15-6
H214494

KEPCO JQE 25-10
H222050

APC SMT1500RM2U

UPS

APC SMT1500RM2U

A51051111987

110VAC

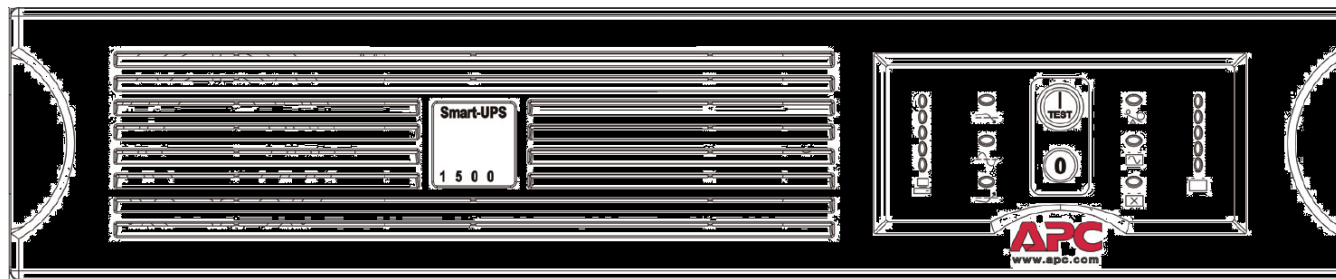

APC SMT1500RM2U

Front

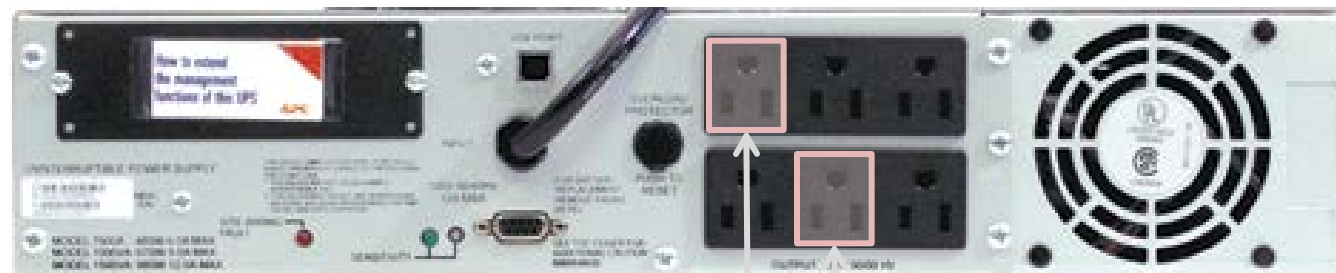

A51051111987

Rear

To 2402 PS1

To X448 PS1

L1-ISC-YC1 Details

RF Patch Panel 26

RF Patch Panel 26

Dxxxxxxx

Sxxxxxxx

No Power

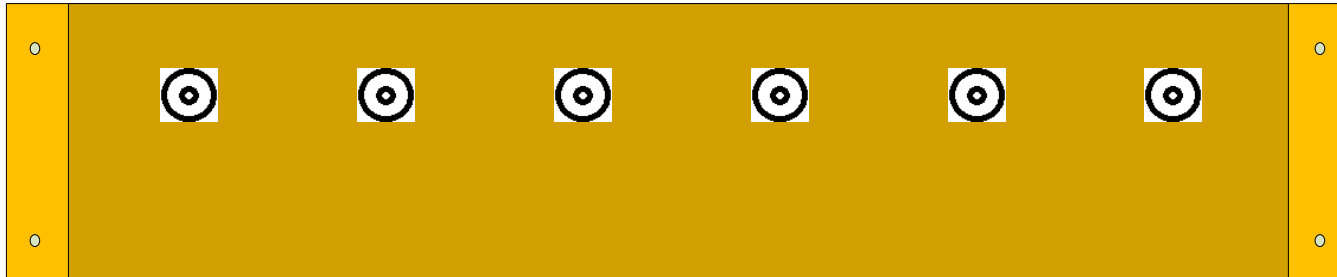

Dxxxxxxx

Front

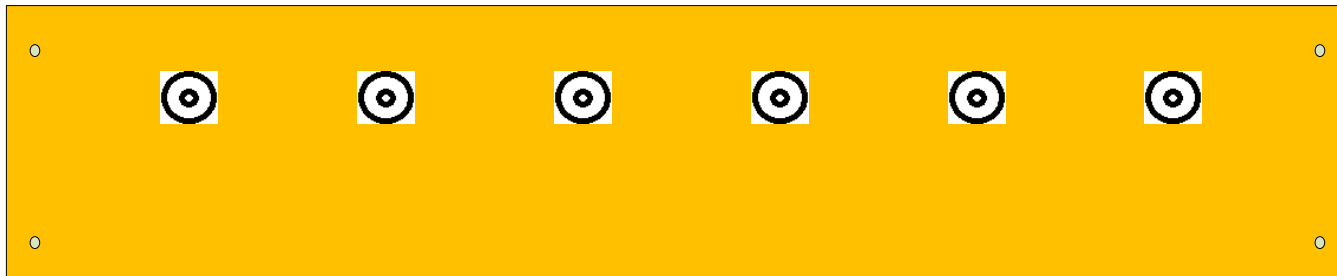

Sxxxxxxx

Rear

RF Patch Panel 27

RF Patch Panel 27

Dxxxxxxx

Sxxxxxxx

No Power

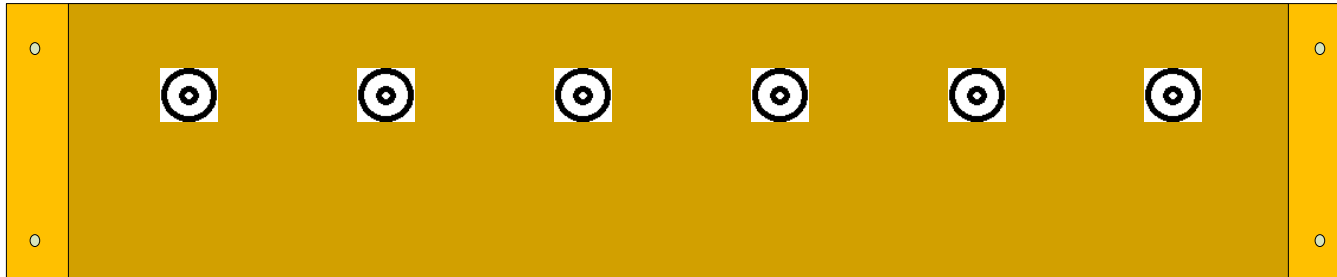

Dxxxxxxx

Front

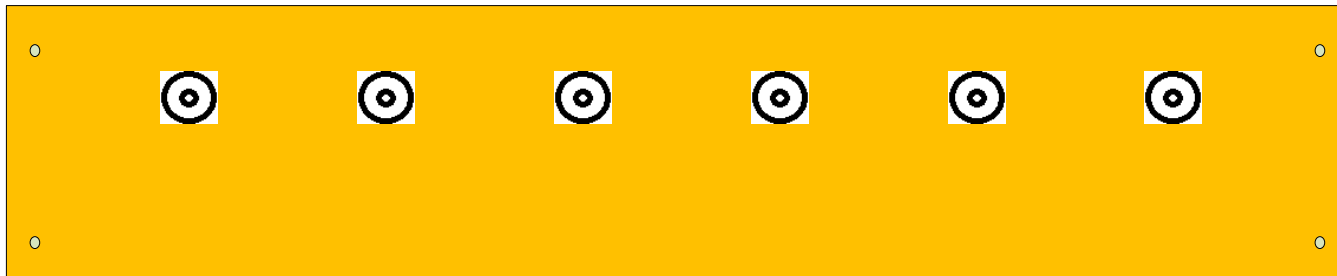

Sxxxxxxx

Rear

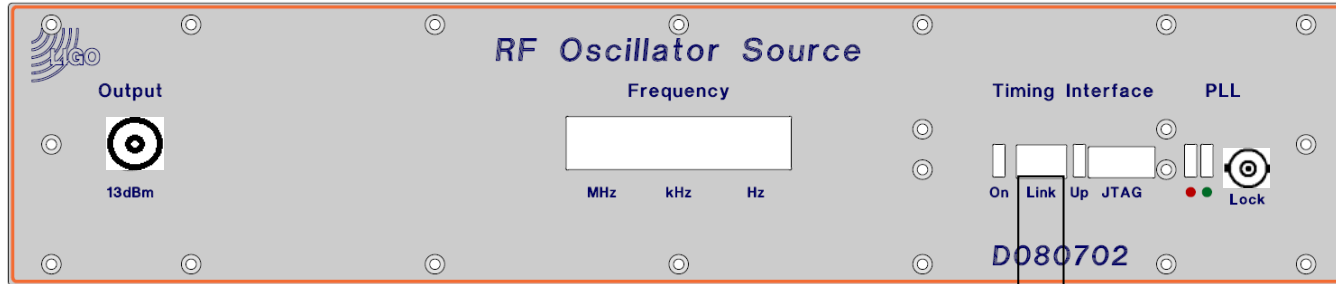

[D080702](#)

Front

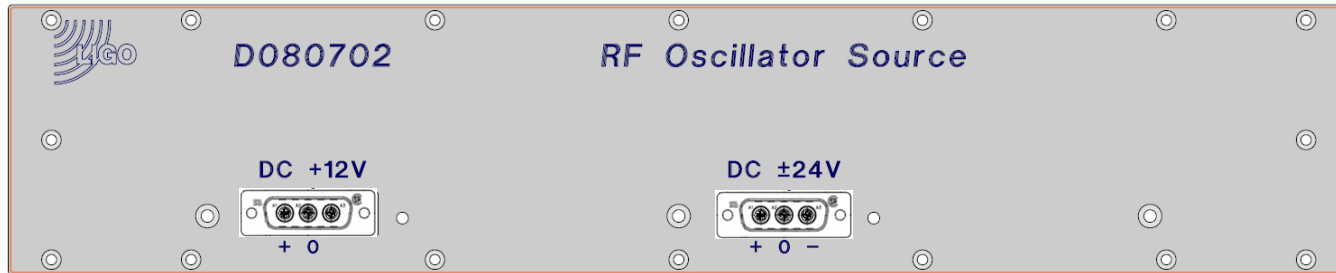
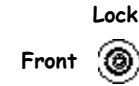

[S1000562](#)

Rear

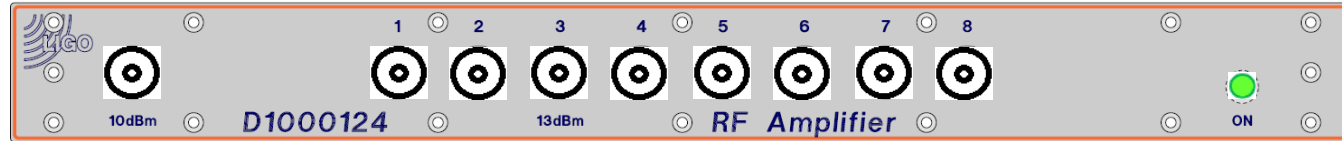

D1000124

Front

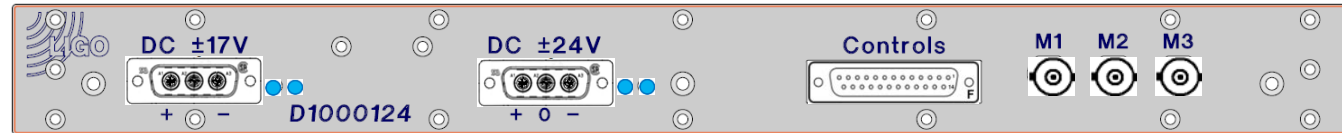
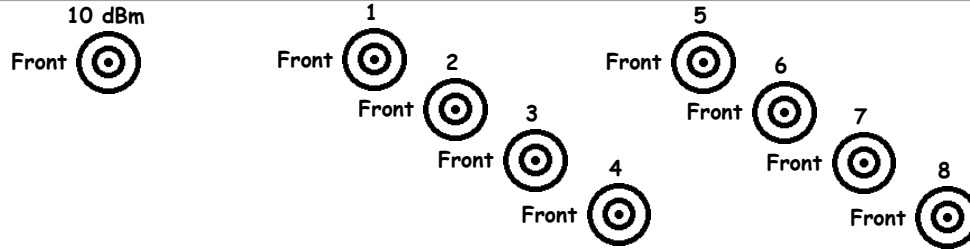

S1000653

Rear

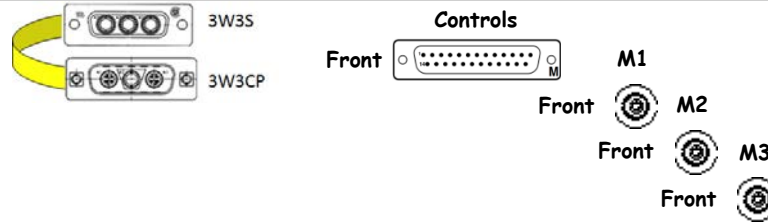

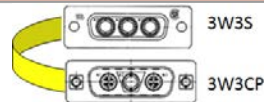
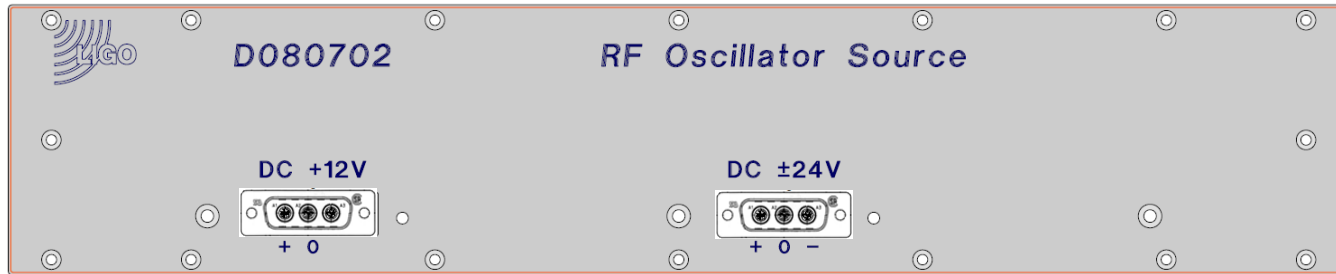
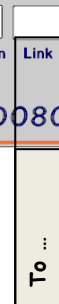
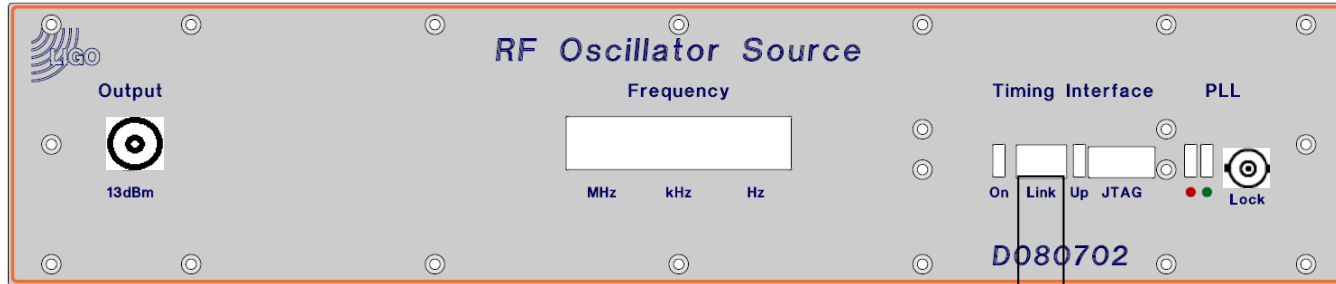

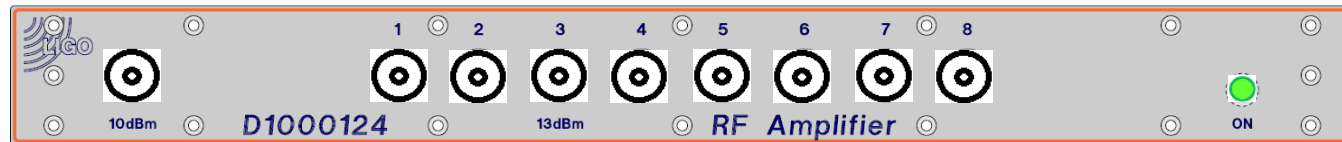

D1000124

Front

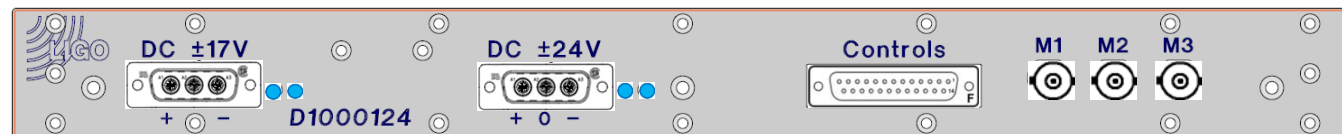
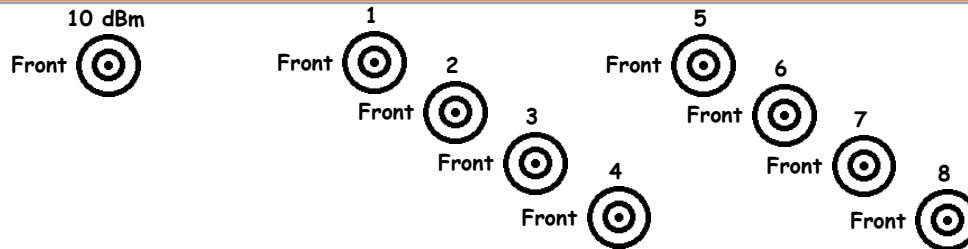

S1000670

Rear

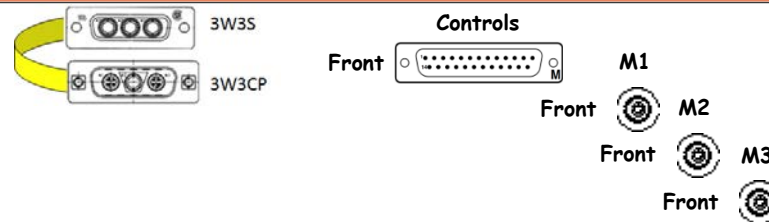



D1100262

Front

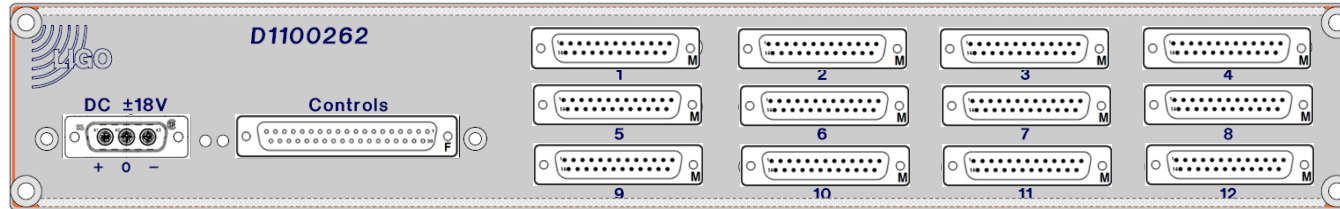

S1103463

Rear

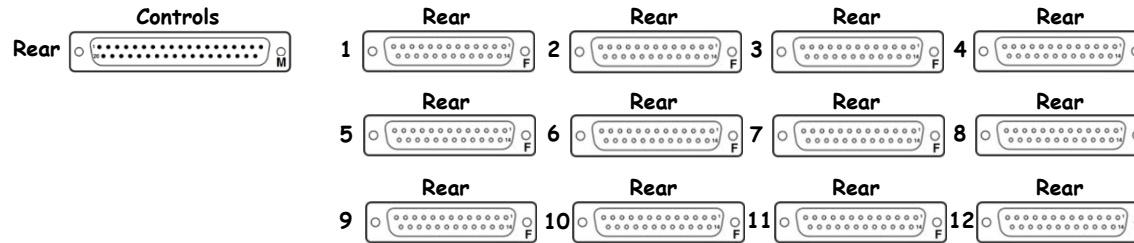

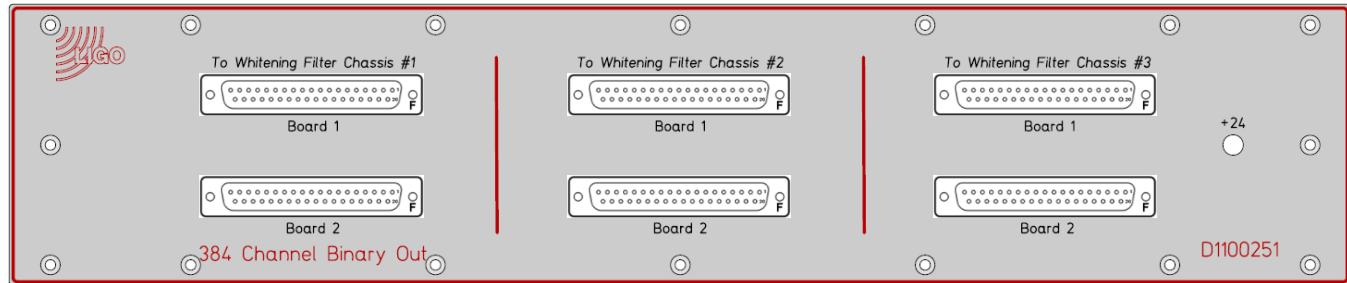

D1100251

Front

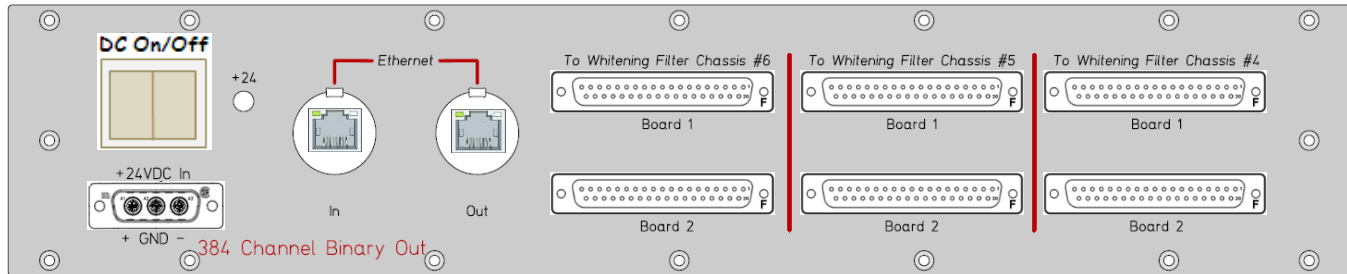
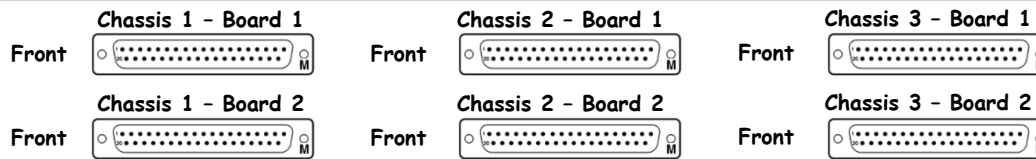

S1203282

Rear

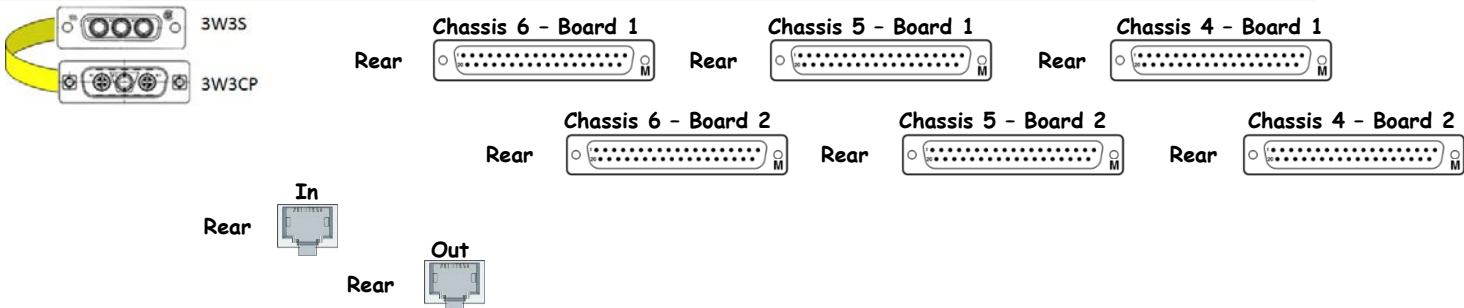

<< L1-ISC-YC1

Beckhoff Slow Controls
ISC Common

D1002961

Sxxxxxxx

+24VDC

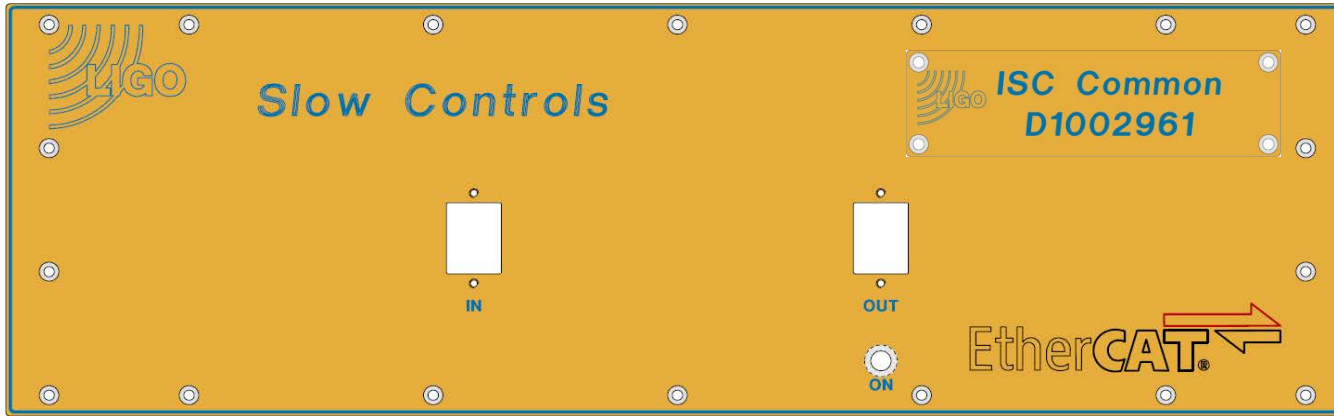

D1002961

Front: D0902553

Name: D1002962

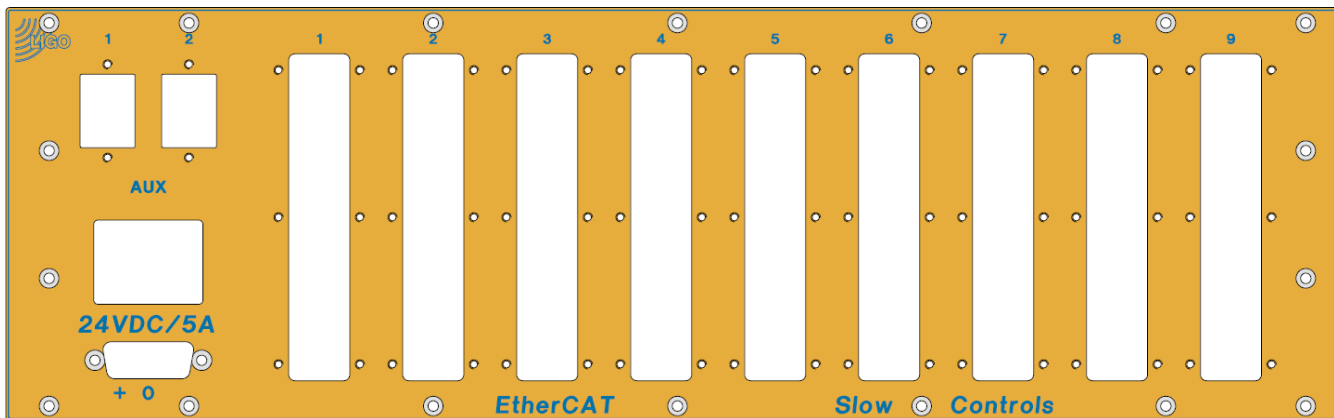

Sxxxxxxx

Rear: D0902554

<< L1-ISC-YC1

Beckhoff Slow Controls
End Station 2

D1100682

Sxxxxxxx

+24VDC

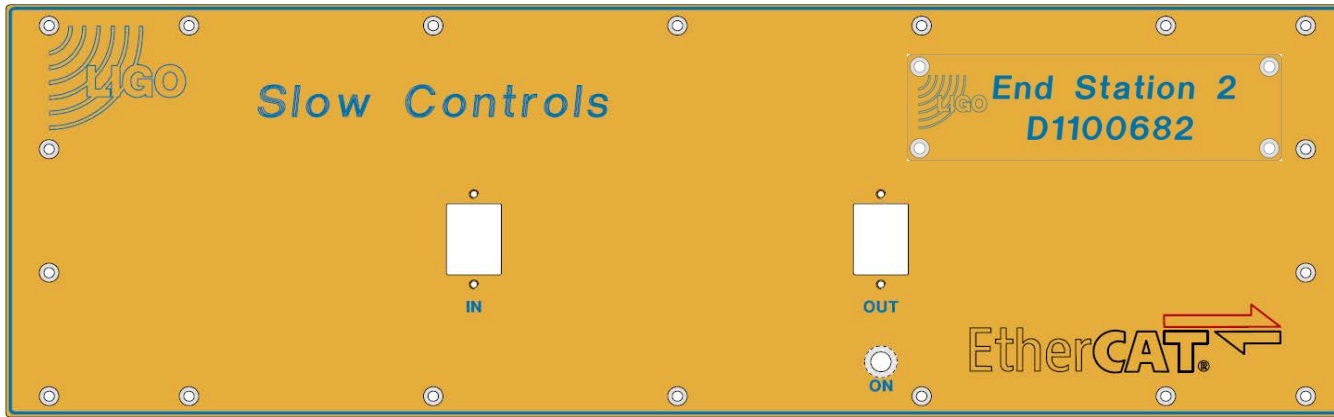

D1100682

Front: D0902553

Name: D1101978

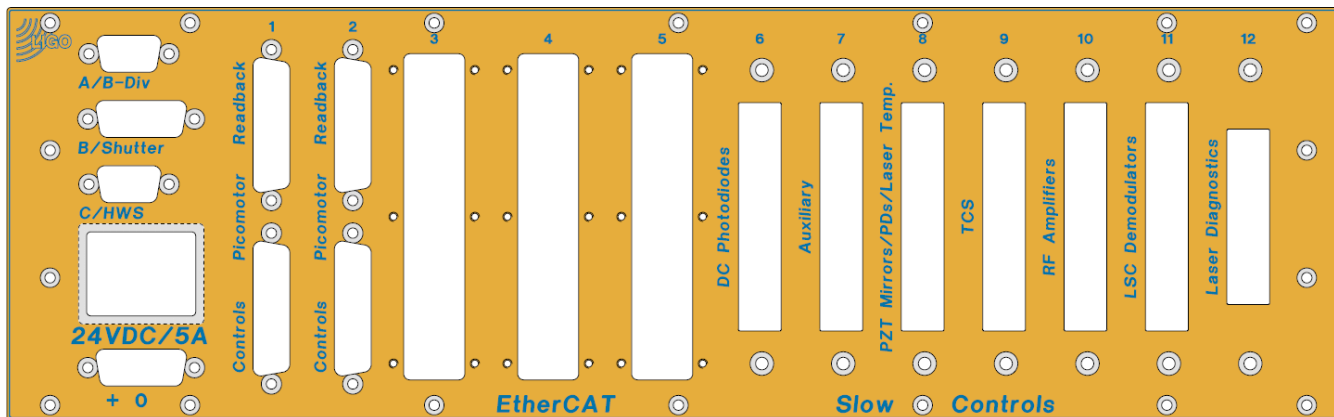

Sxxxxxxx

Rear: D1101977

I1pemey - D1001715 - S1000528

I1pemey I/O Extension Chassis

D1001715

S1000528

110VAC



D1001715
Front

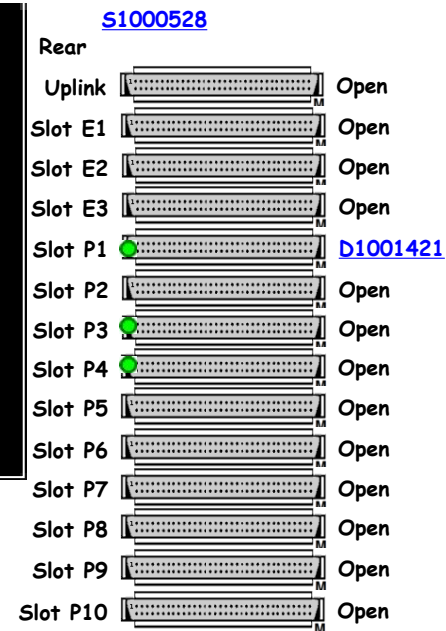
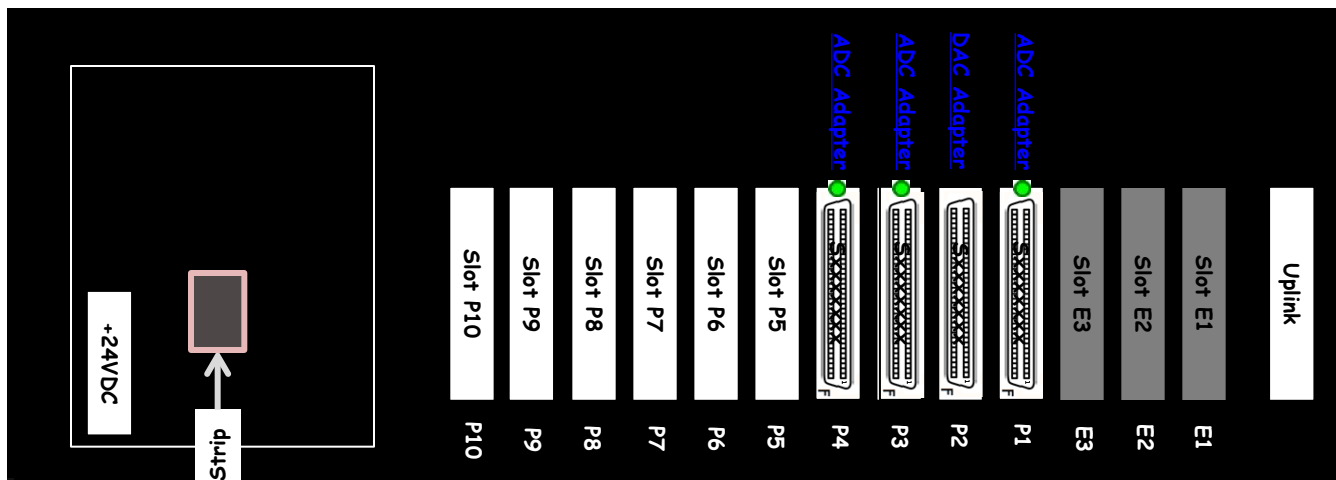

BSC5 ISI Interface Chassis Pod 1	D1002432	42	S1300125	±18VDC
BSC5 ISI Interface Chassis Pod 2	D1002432	41	S1300126	±18VDC
BSC5 ISI Interface Chassis Pod 3	D1002432	40	S1300127	±18VDC
		39		
		38		
		37		
		36		
BSC5 ISI AA Chassis	D1002693	35	S1300138	±18VDC
BSC5 ISI AA Chassis	D1002693	34	S1300139	±18VDC
		33		
BSC5 ISI AA Chassis	D1002693	32	S1300686	±18VDC
		31		
BSC5 HEPI AA Chassis	D1000272	30	S1300142	±18VDC
BSC5 HEPI AI Chassis	D1100202	29	S1300687	±18VDC
		28		
BSC5 8 Channel Valve Driver	D0900117	27	S0900283	±18VDC
		26		
64 Channel Binary Input Chassis (8*DB9)	D1001726	25	Sxxxxxxx	±18VDC
64 Channel Binary Input Chassis (8*DB9)	D1001726	24	S1101307	±18VDC
64 Channel Binary Output Chassis (8*DB9)	D1001728	23	S1101321	±18VDC
		22		
Trillium 240 Interface Chassis Pod 1	D1002964	21	S1201403	±18VDC
Trillium 240 Interface Chassis Pod 2	D1002964	20	S1201404	±18VDC
Trillium 240 Interface Chassis Pod 3	D1002964	19	S1201410	±18VDC
		18		
STS-2 Distribution Chassis	D0900351	17	Sxxxxxxx	±18VDC
STS-2 Interface Chassis	D080535	16	S0900618	±18VDC
		15		
		14		
1seiey I/O Extension Chassis	D1001715	13	S1200166	+24VDC
		12		
		11		
		10		
Anti-Image Chassis (4*DB9)	D1000305	9	S1300612	±18VDC
		8		
BSC5 ISI Coil Driver Pod 1	D0902744	7	S1103360	±24VDC
BSC5 ISI Coil Driver Pod 2	D0902744	6	S1000317	±24VDC
BSC5 ISI Coil Driver Pod 3	D0902744	5	Sxxxxxxx	±24VDC
		4		
		3		
		2		
		1		

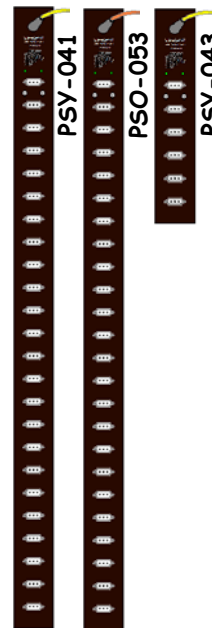

SEI-YC1 is part of [D0901301](#)

Front

Rear

L1-SEI-YC1 Details

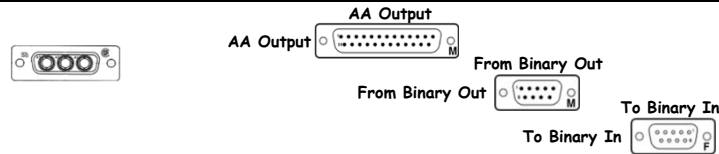
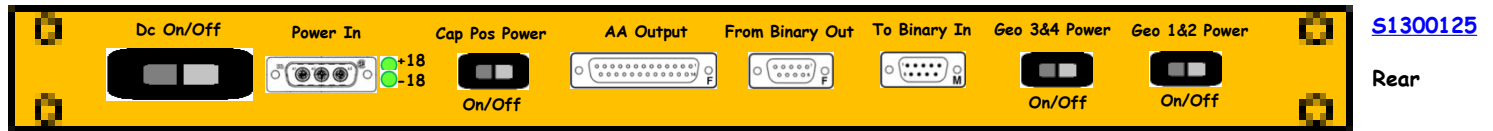
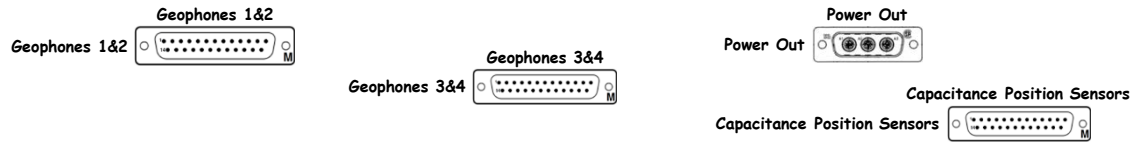

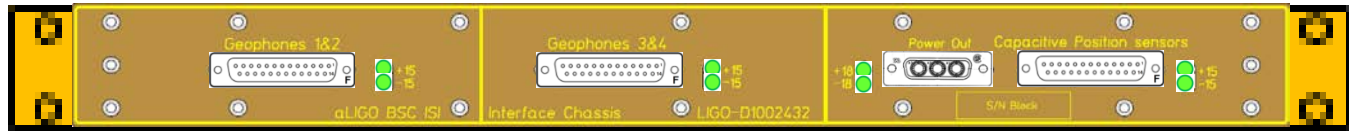

[D1002432](#)

Front

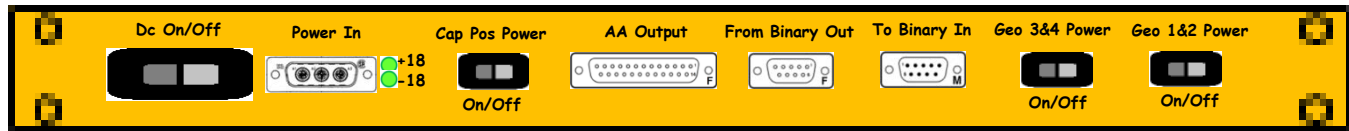
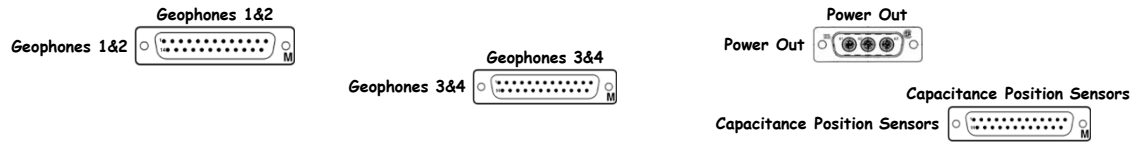

[S1300126](#)

Rear

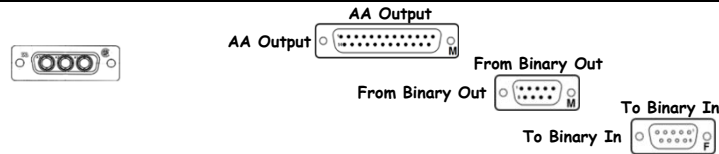

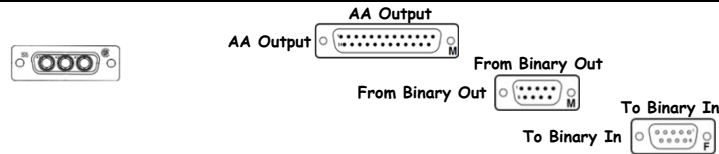
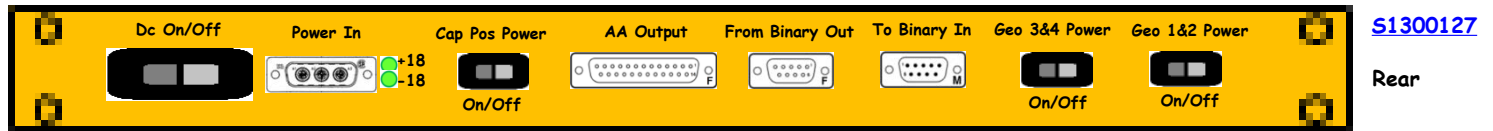
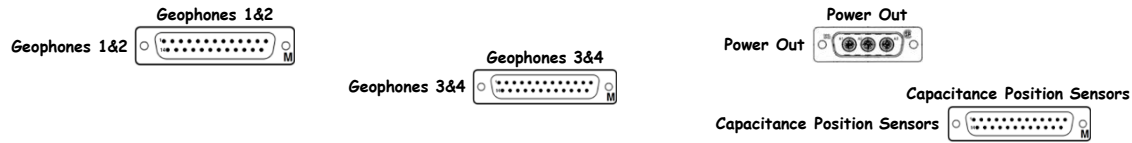

D1002693 - S1300138



<< L1-SEI-YC1

BSC5 ISI AA Chassis Pod 3

D1002693

S1300138

Power

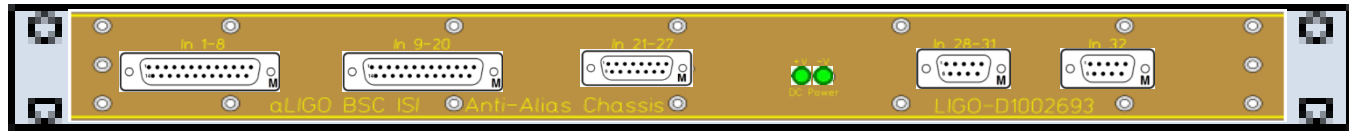

D1002693

Front

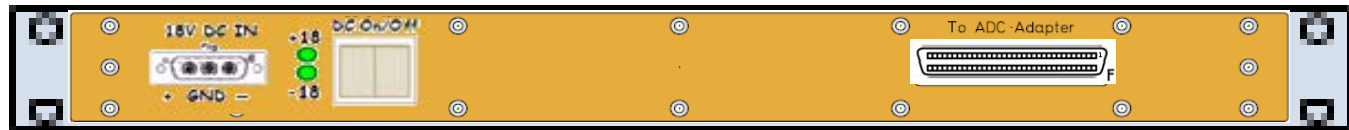
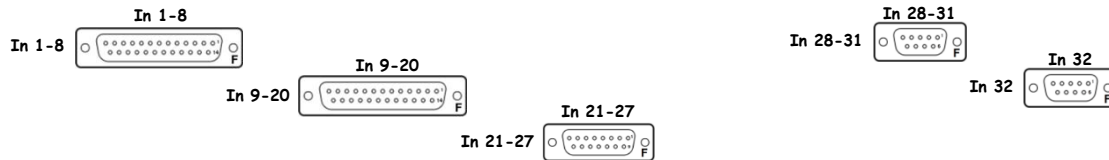

S1300138

Rear

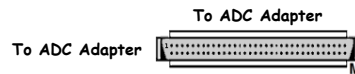

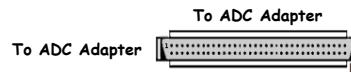
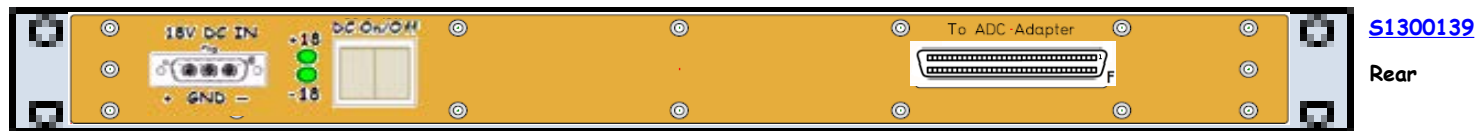
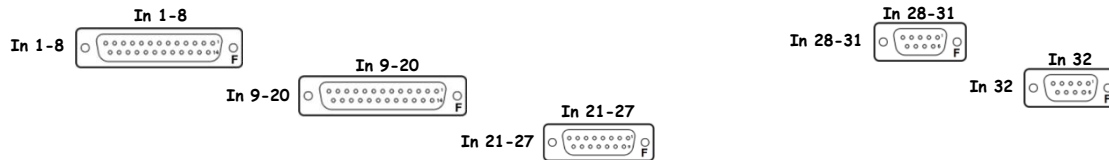
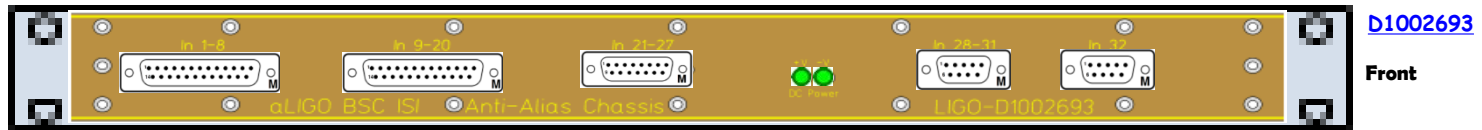

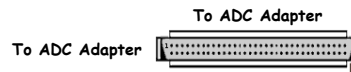
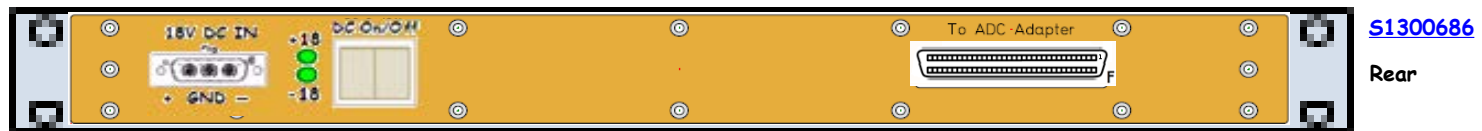
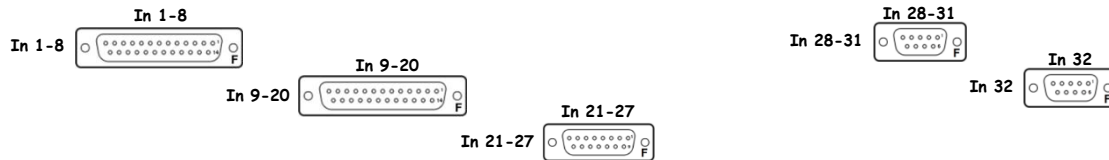
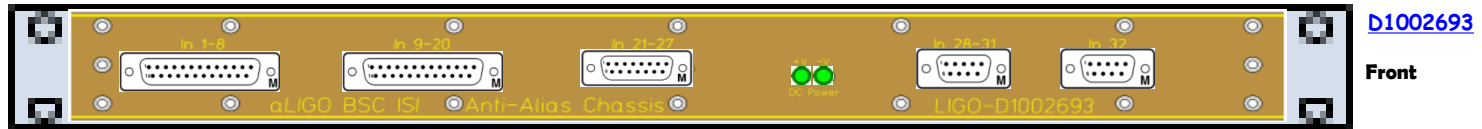

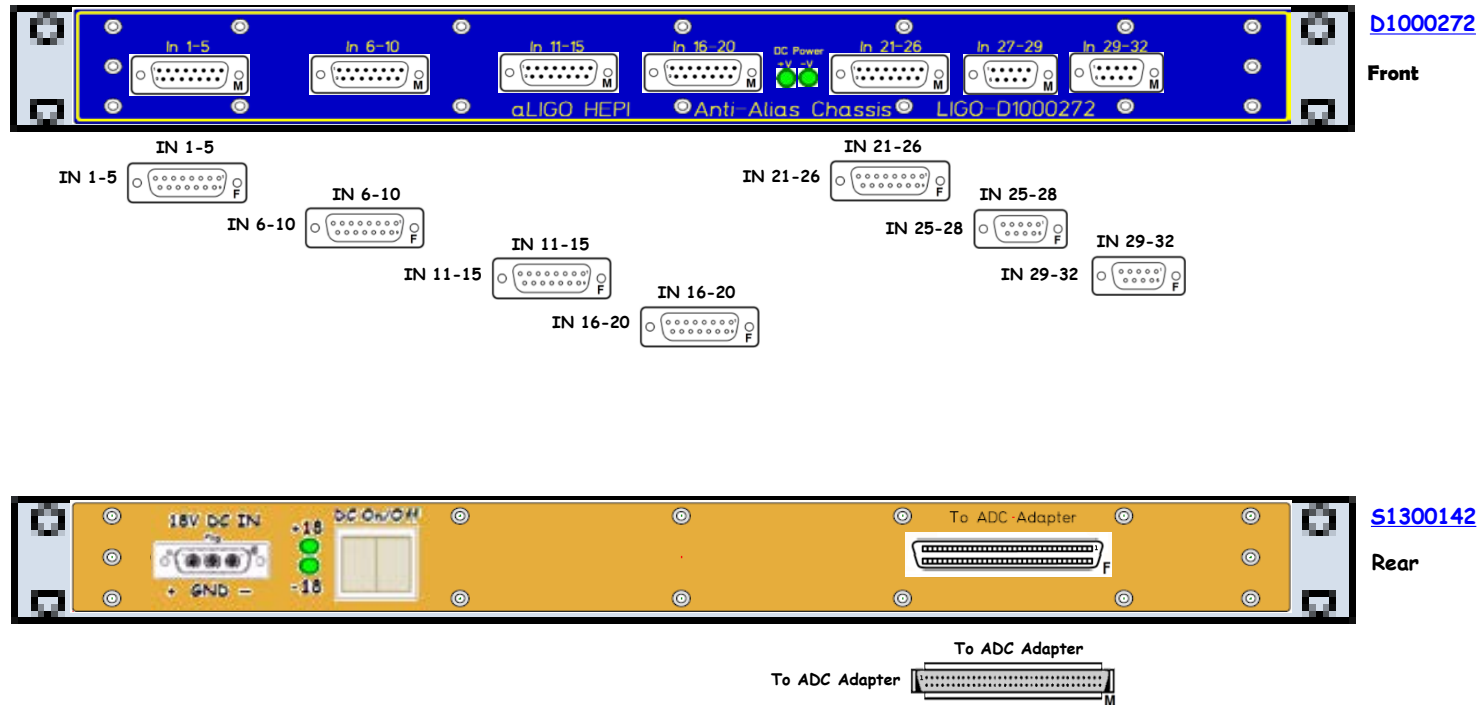

D1100202 - S1300687



<< L1-SEI-YC1

BSC5 HEPI AI Chassis D1100202 S1300687 Power

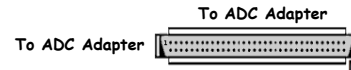
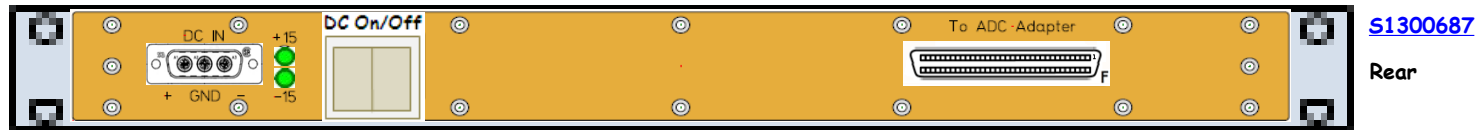
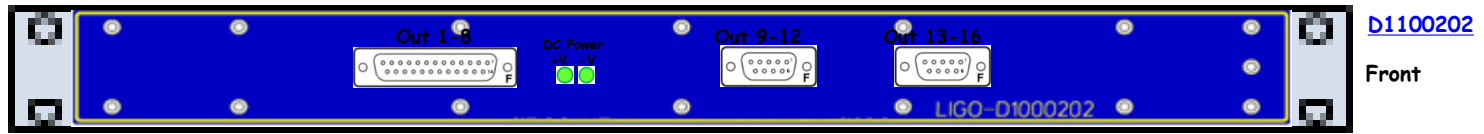

<< L1-SEI-YC1

BSC5 8 Channel Valve Driver

D0900117

S0900283

Power

BSC5

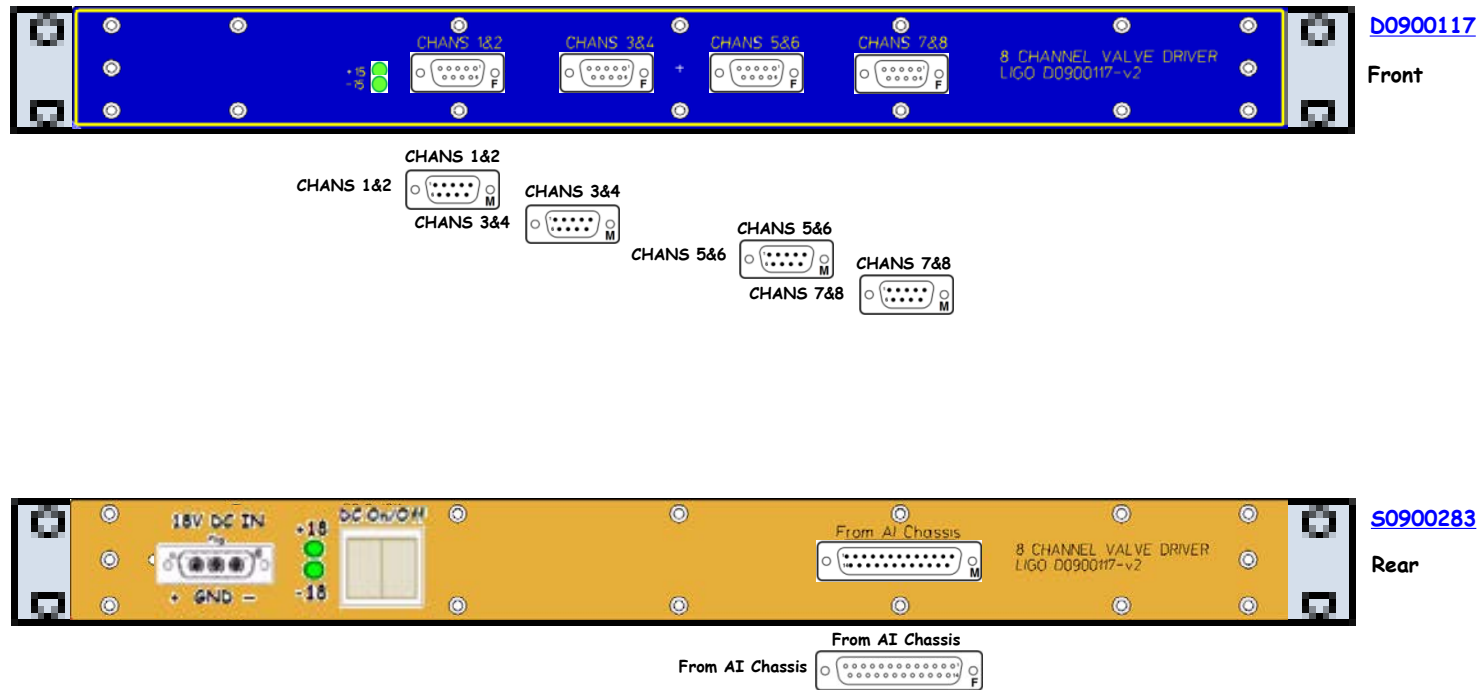

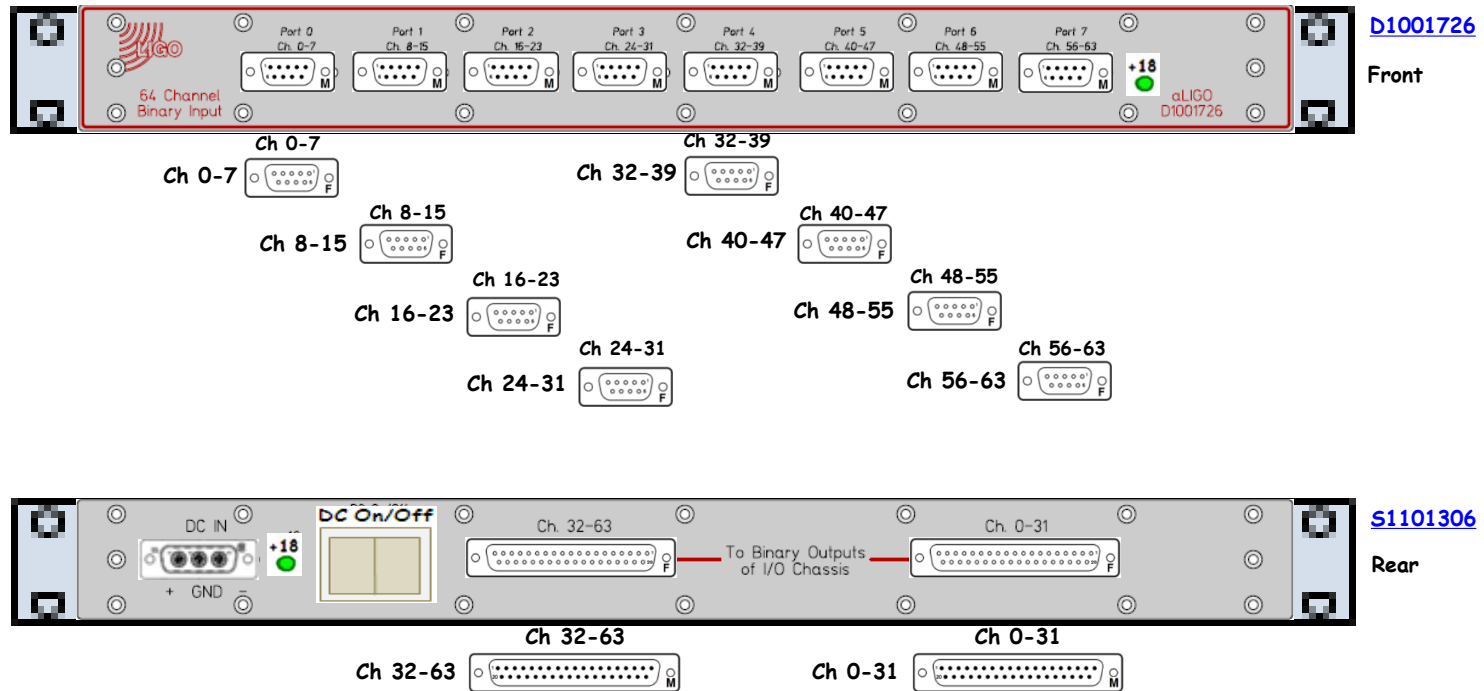

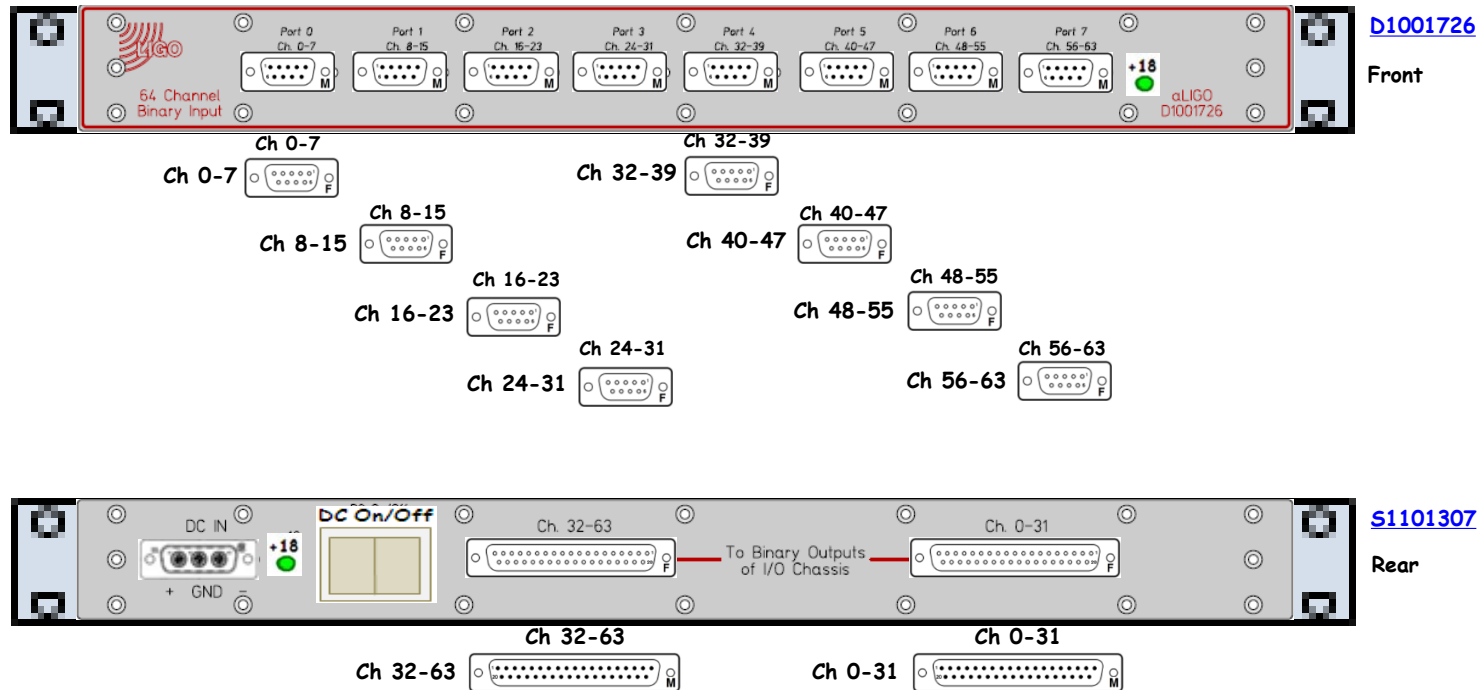

D1001726

Front

S1101307

Rear

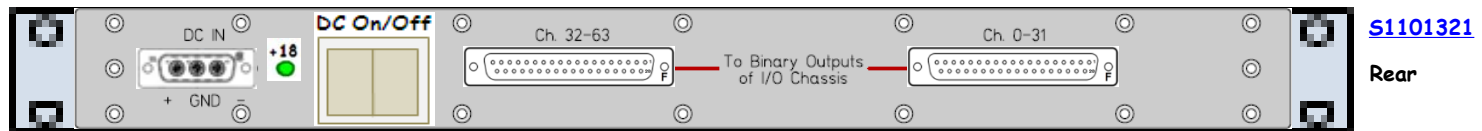
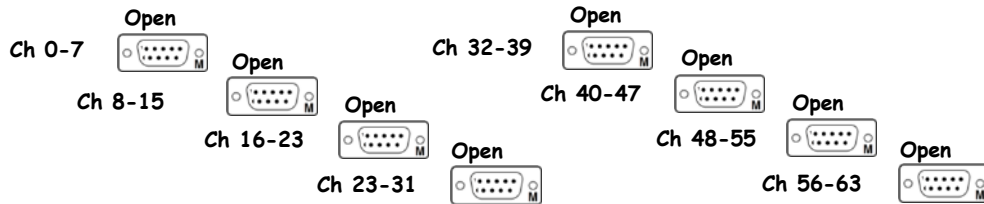
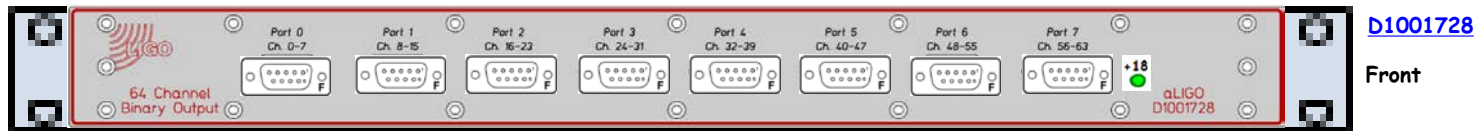

D1002964 - S1201405



<< L1-SEI-YC1

Trillium 240 Interface Chassis Pod 1 D1002964 S1201405 ±18VDC

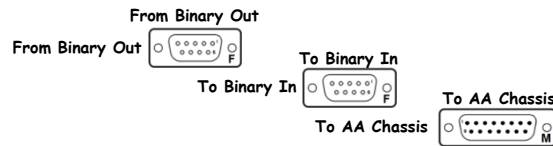
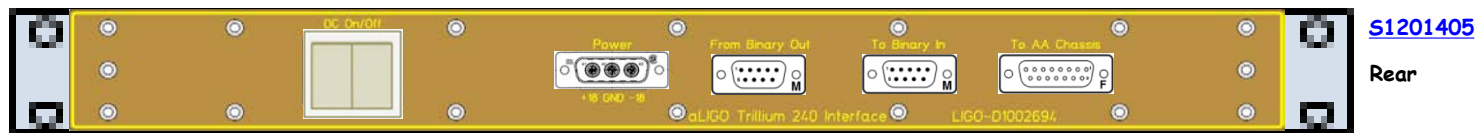

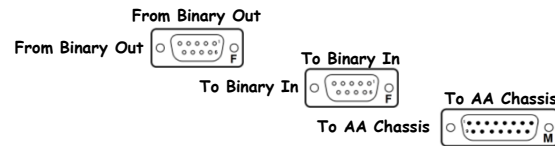
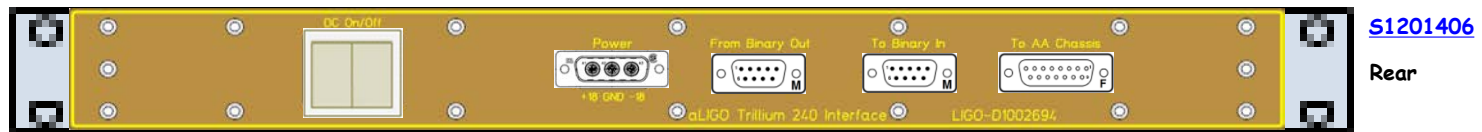
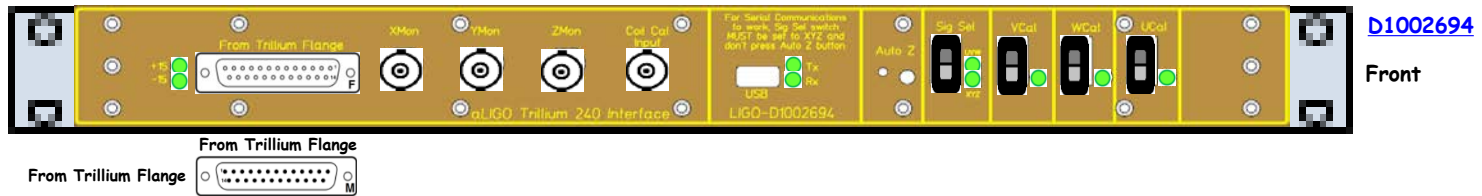

D1002964 - S1201407



<< L1-SEI-YC1

Trillium 240 Interface Chassis Pod 3

D1002964

S1201407

±18VDC



D1002694

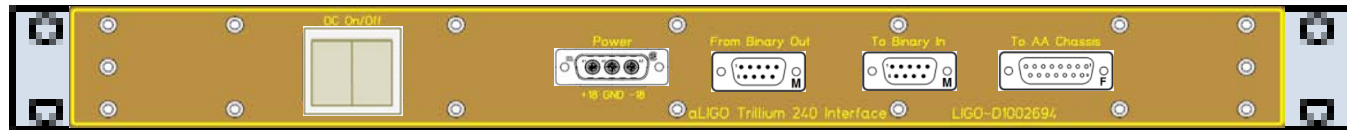

S1201407

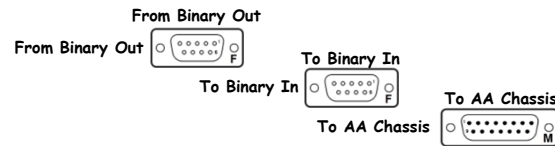

STS-2 Distribution Chassis D0900351 S0900133 ±18VDC

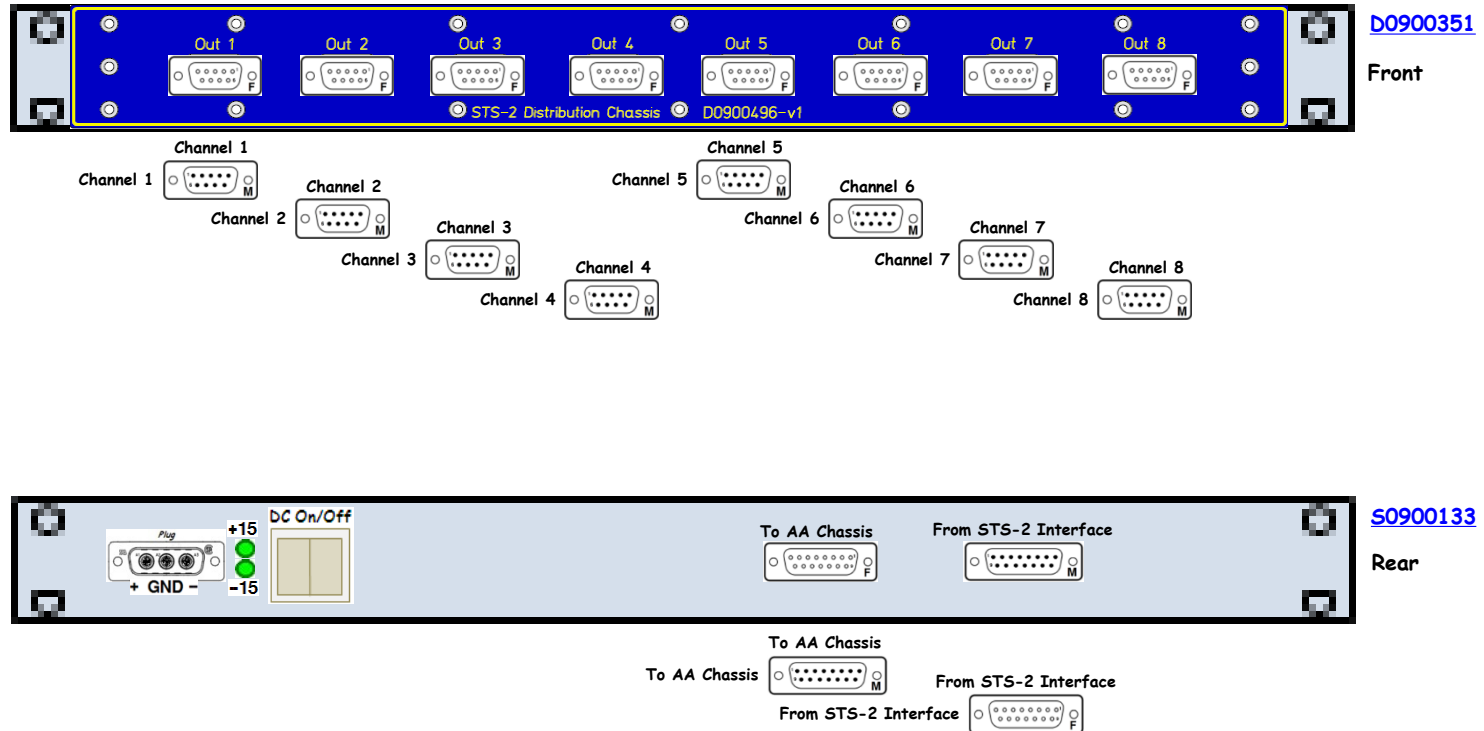

STS-2 Interface Chassis

D080535

S0900105

±18VDC

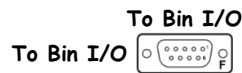
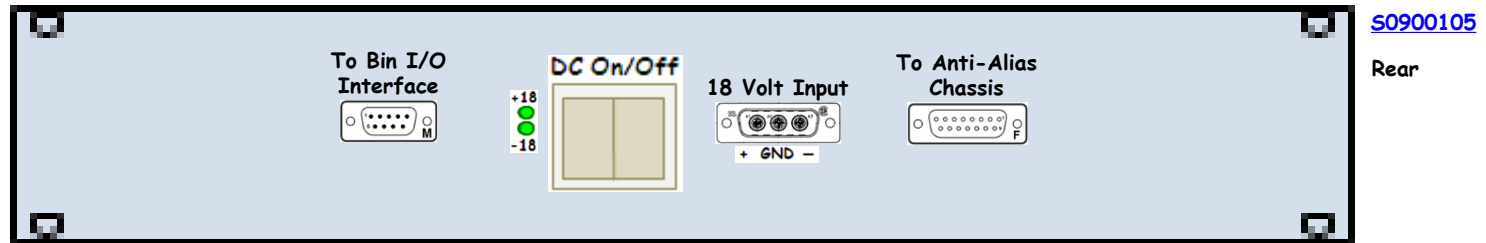
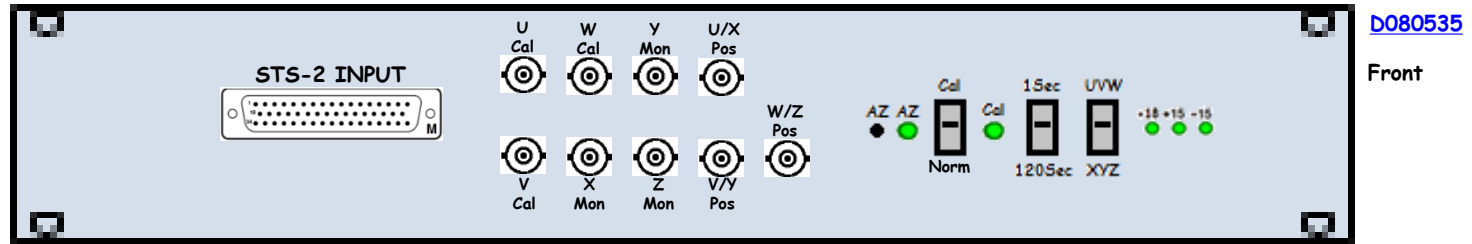

1seiey D1001715 - S1200166

I/O Extension Chassis

D1001715

S1200166

+24VDC



D1001715
Front

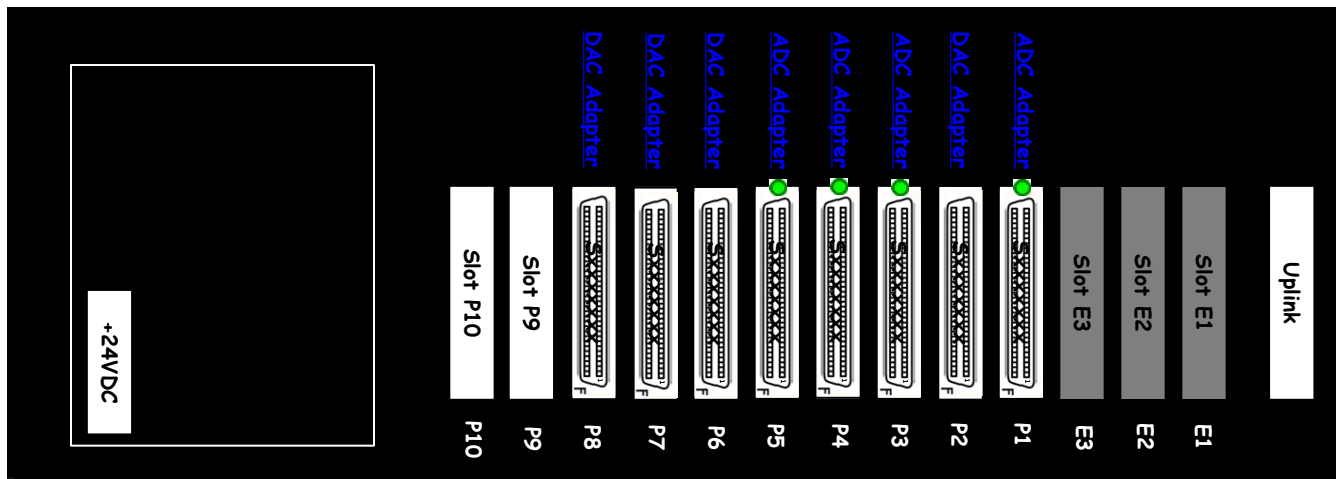

S1200166
Rear

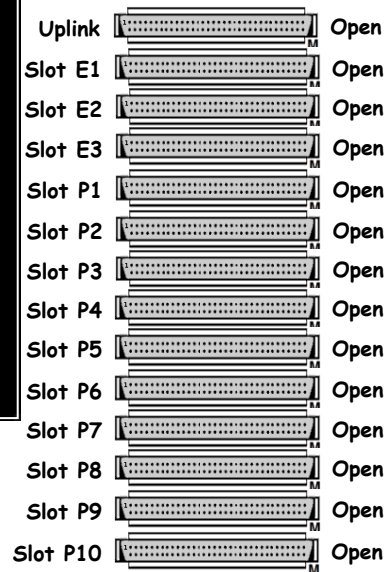

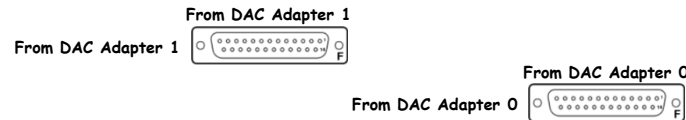
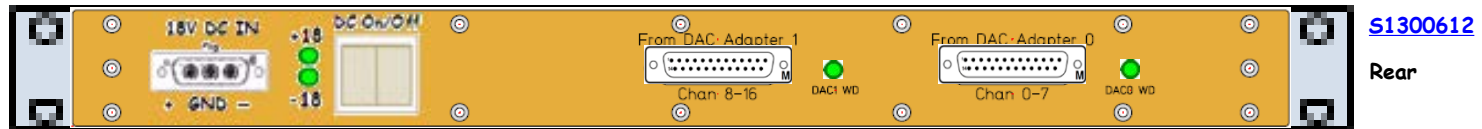
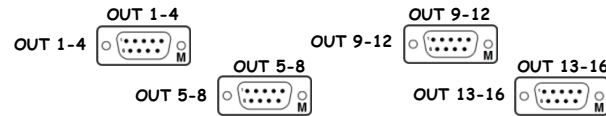
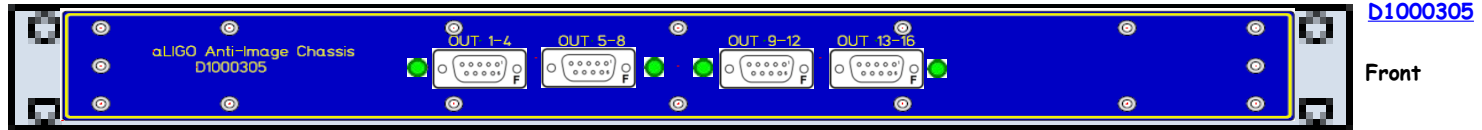

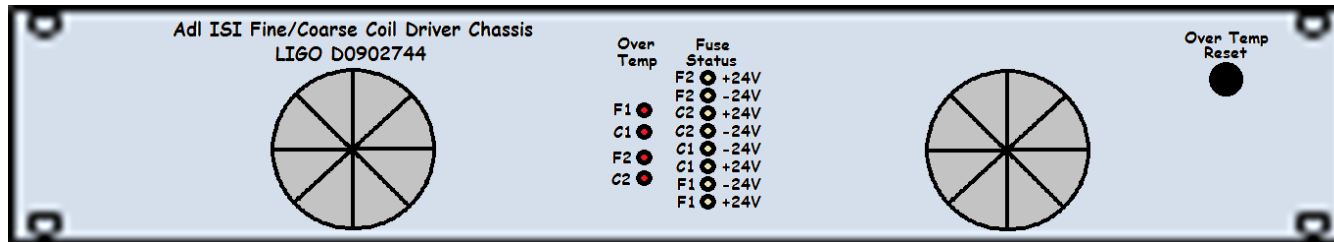

D0902744

Front

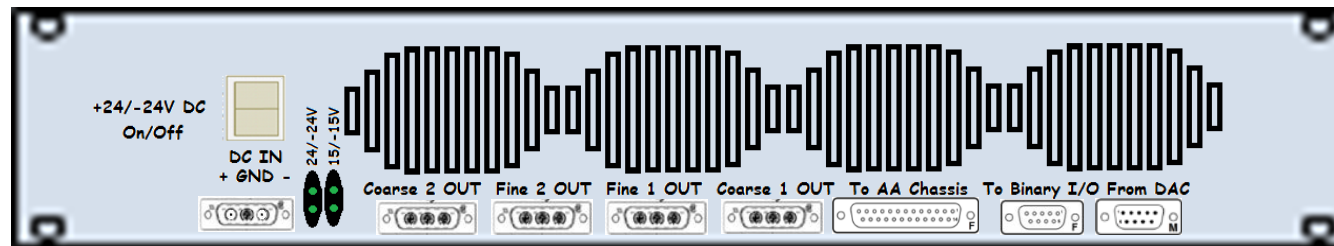

S1103314

Rear

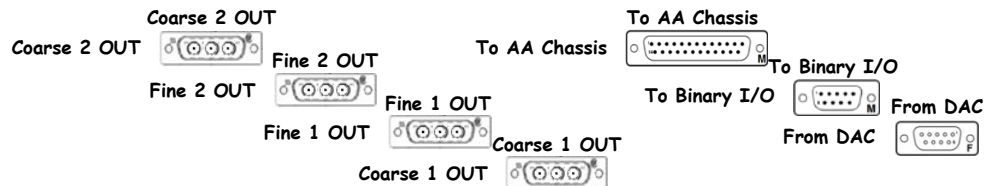

D0902744 - S1103360



<< L1-SEI-YC1

BSC5 ISI Coil Driver Pod 2

D0902744

S1103360

+24V@1.2A, -24V@0.8A

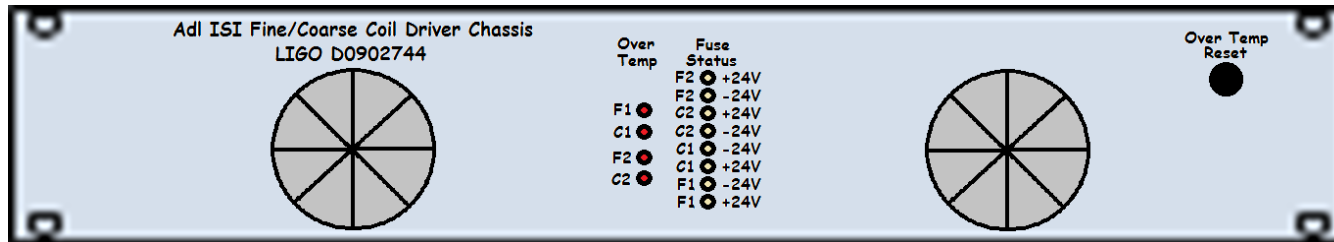

D0902744

Front

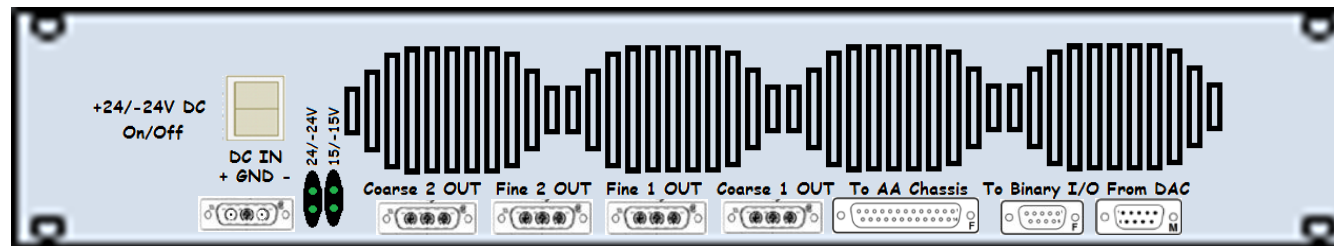

S1103360

Rear

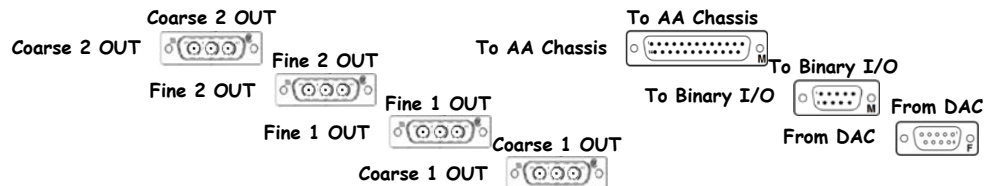

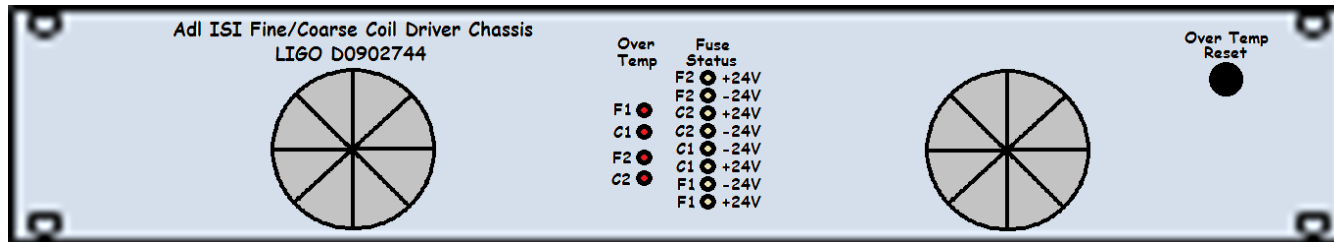

D0902744

Front

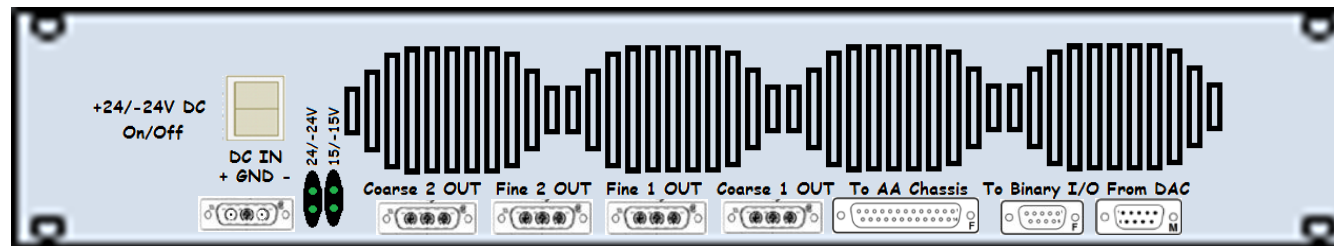

Sxxxxxxx

Rear

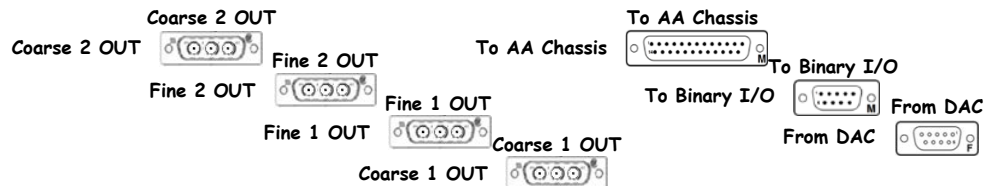

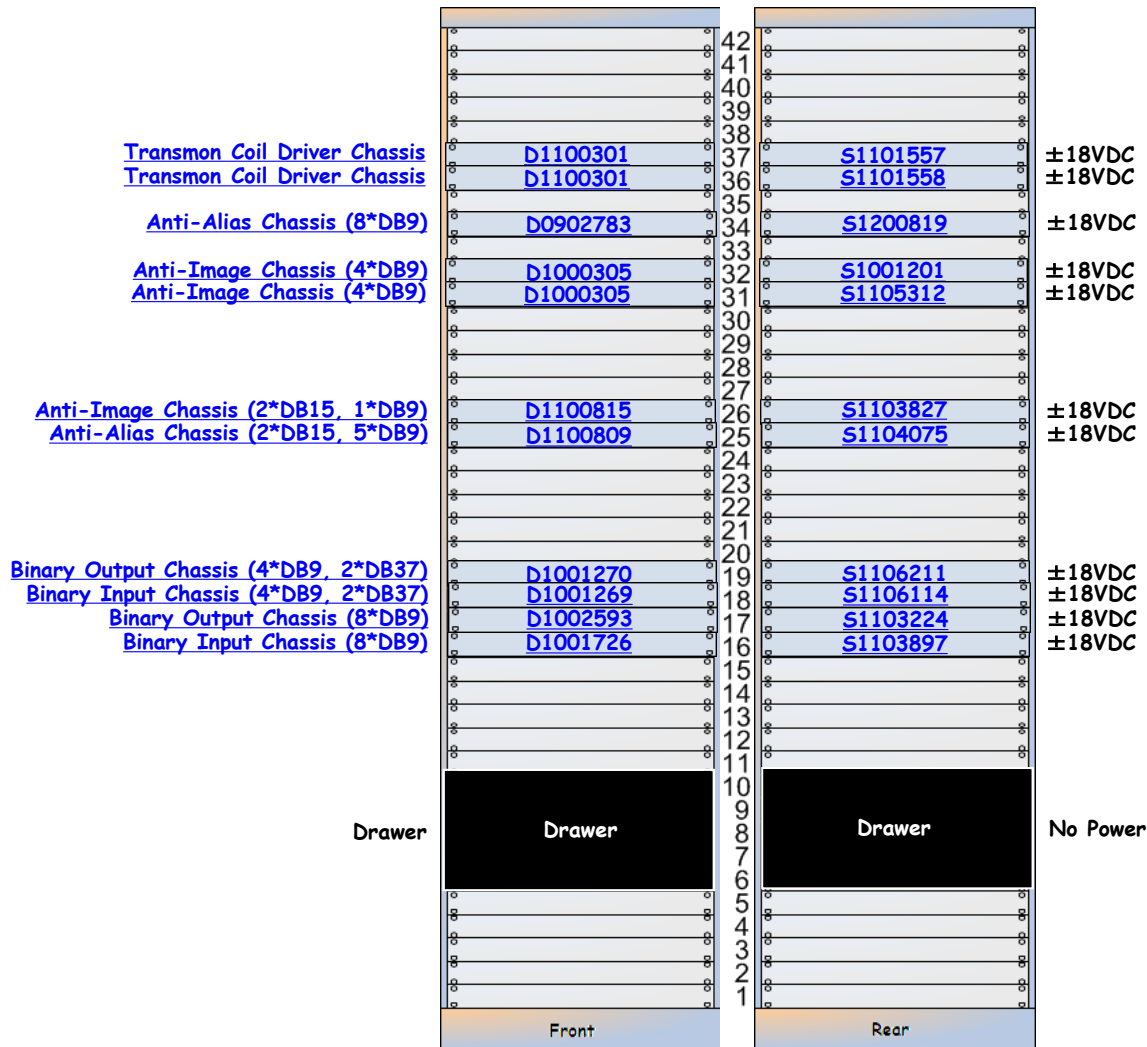

L1-SUS-YC1 Details

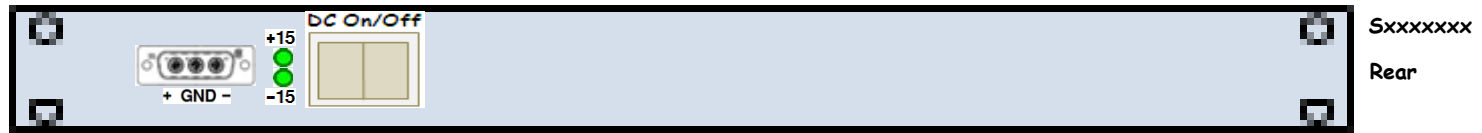

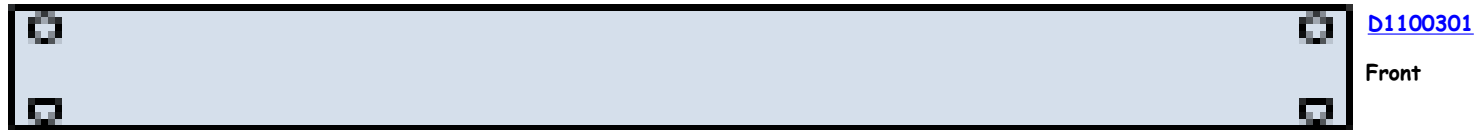

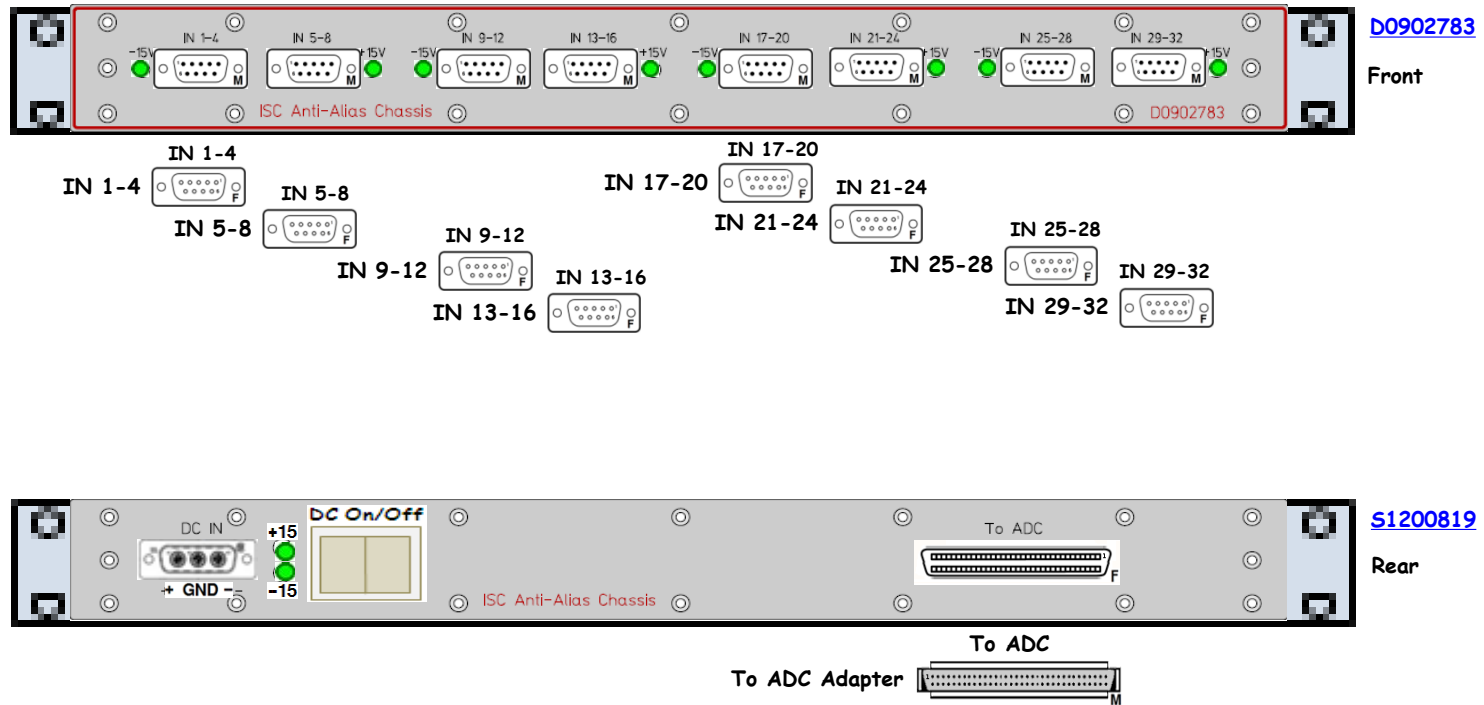

Anti-Image Chassis (4*DB9) D1000305 S1001201 ±18VDC

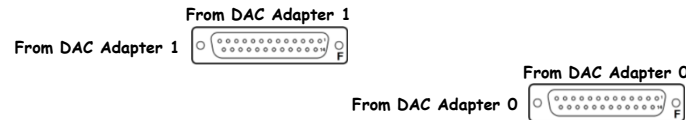
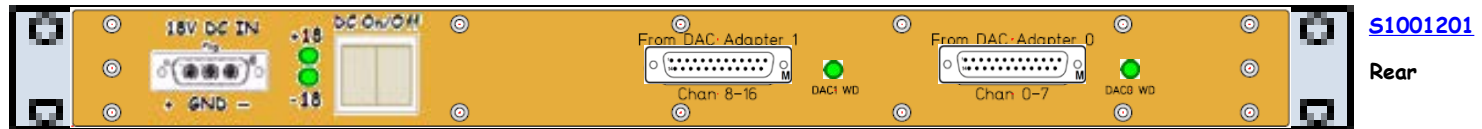
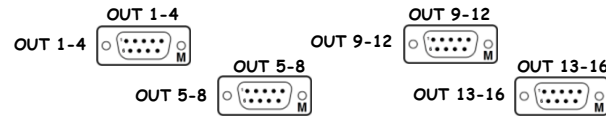
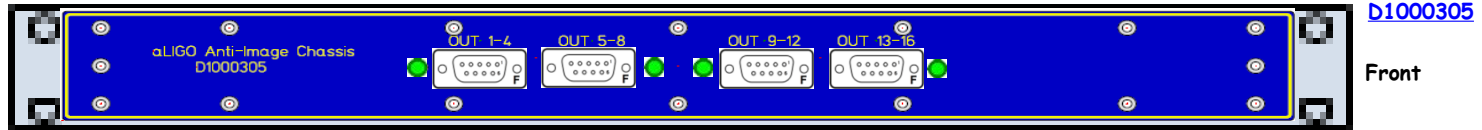

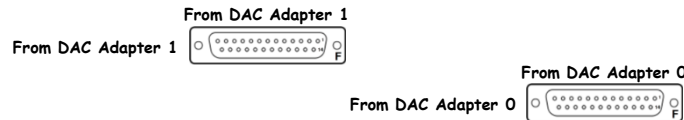
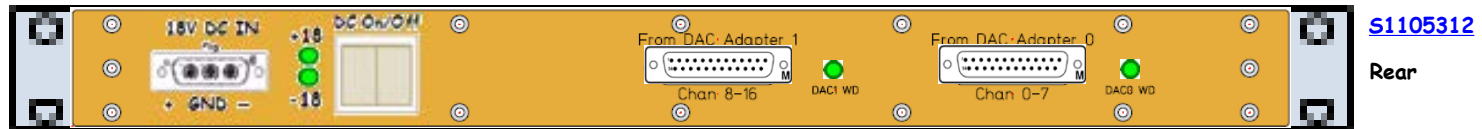
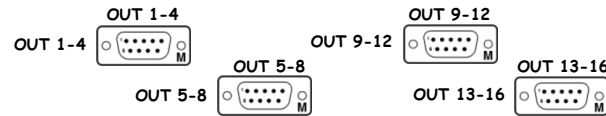
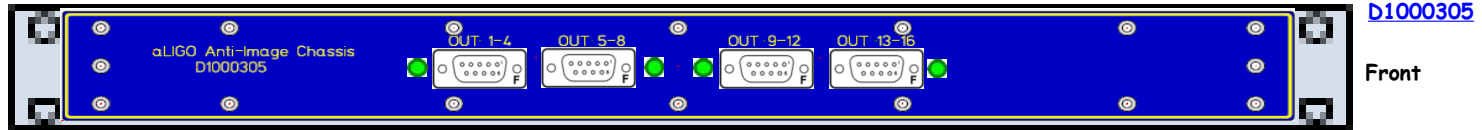

D1100815 is an AI, which means it has OUTPUTS, not INPUTS. The labels are incorrect.

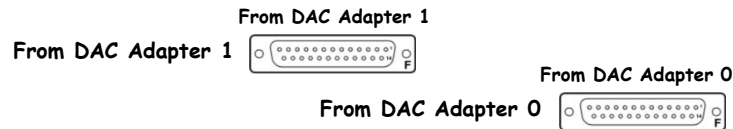
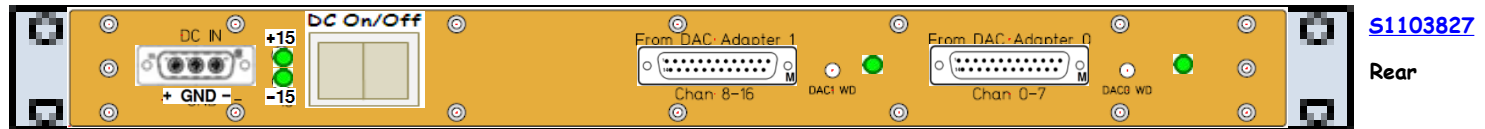
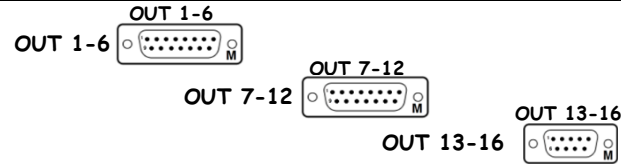
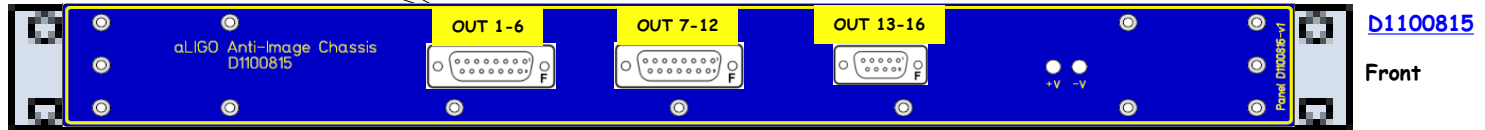

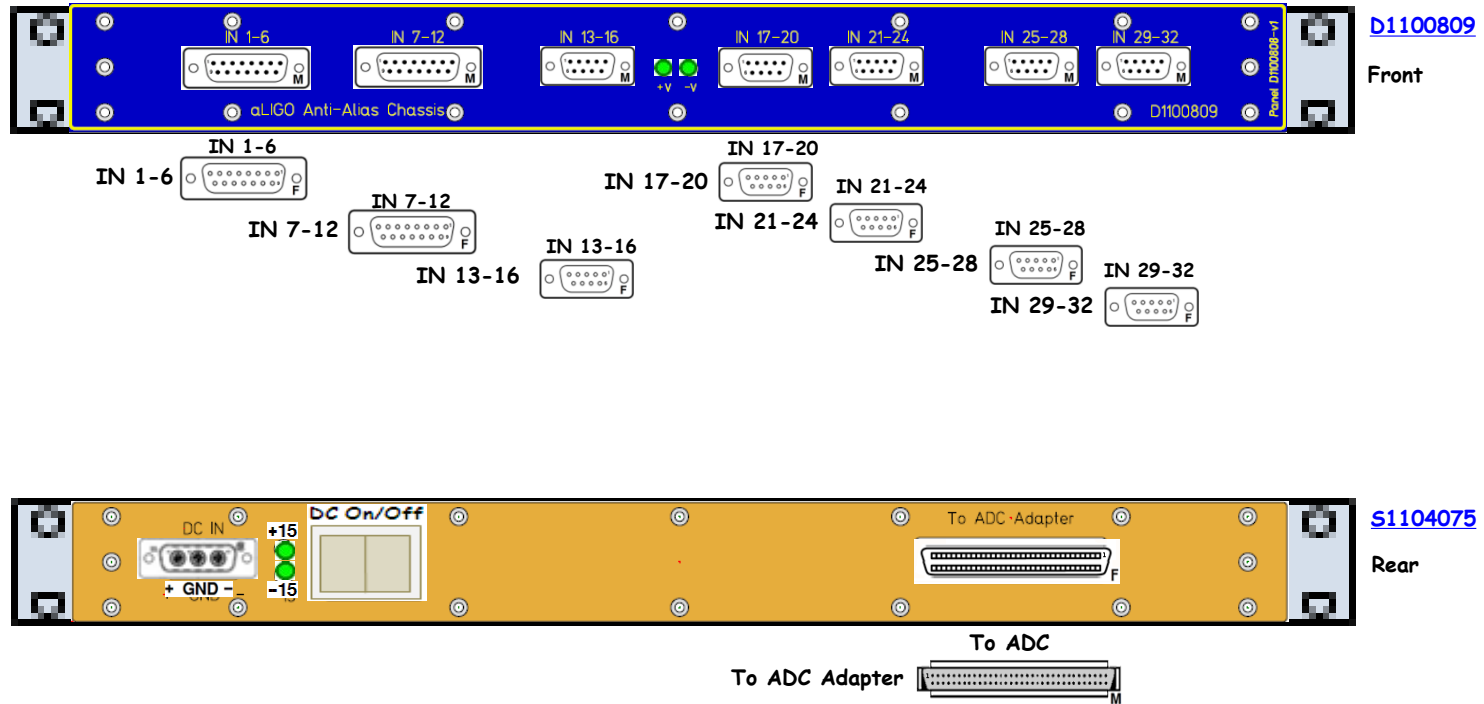

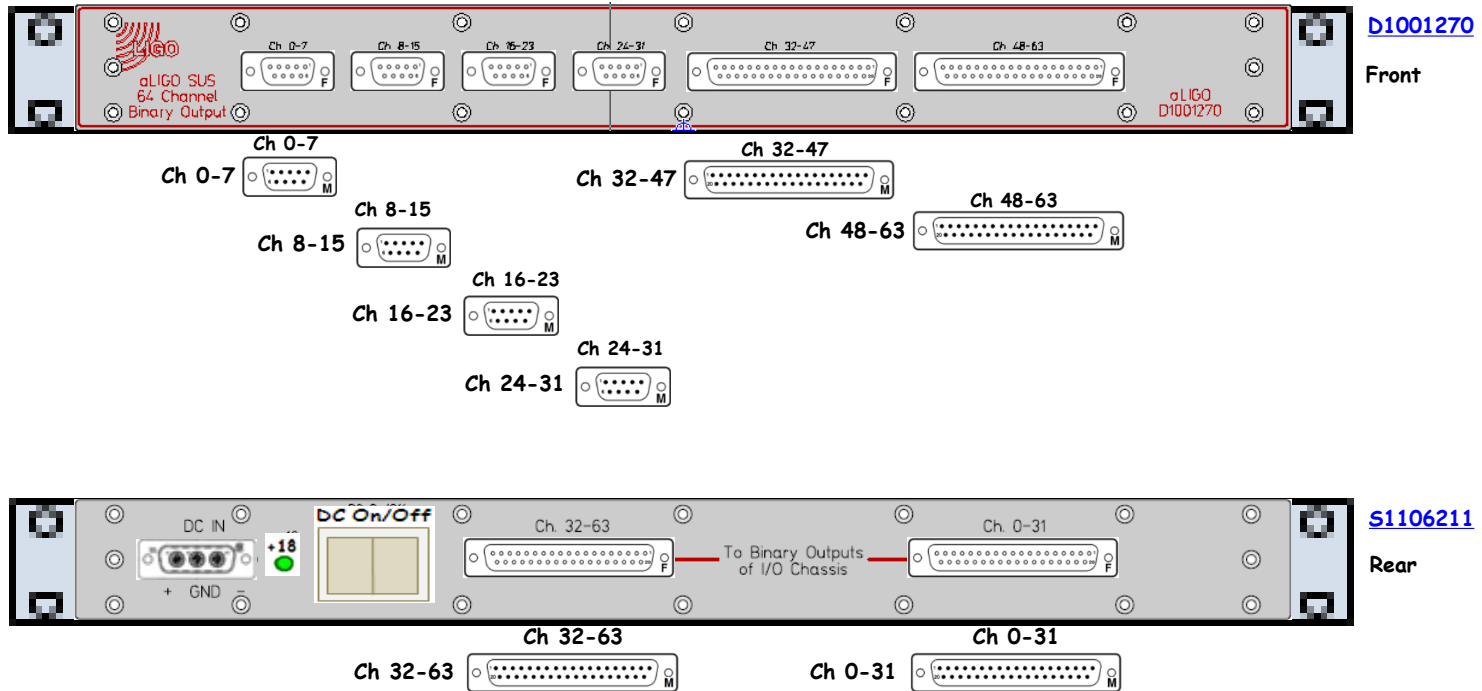

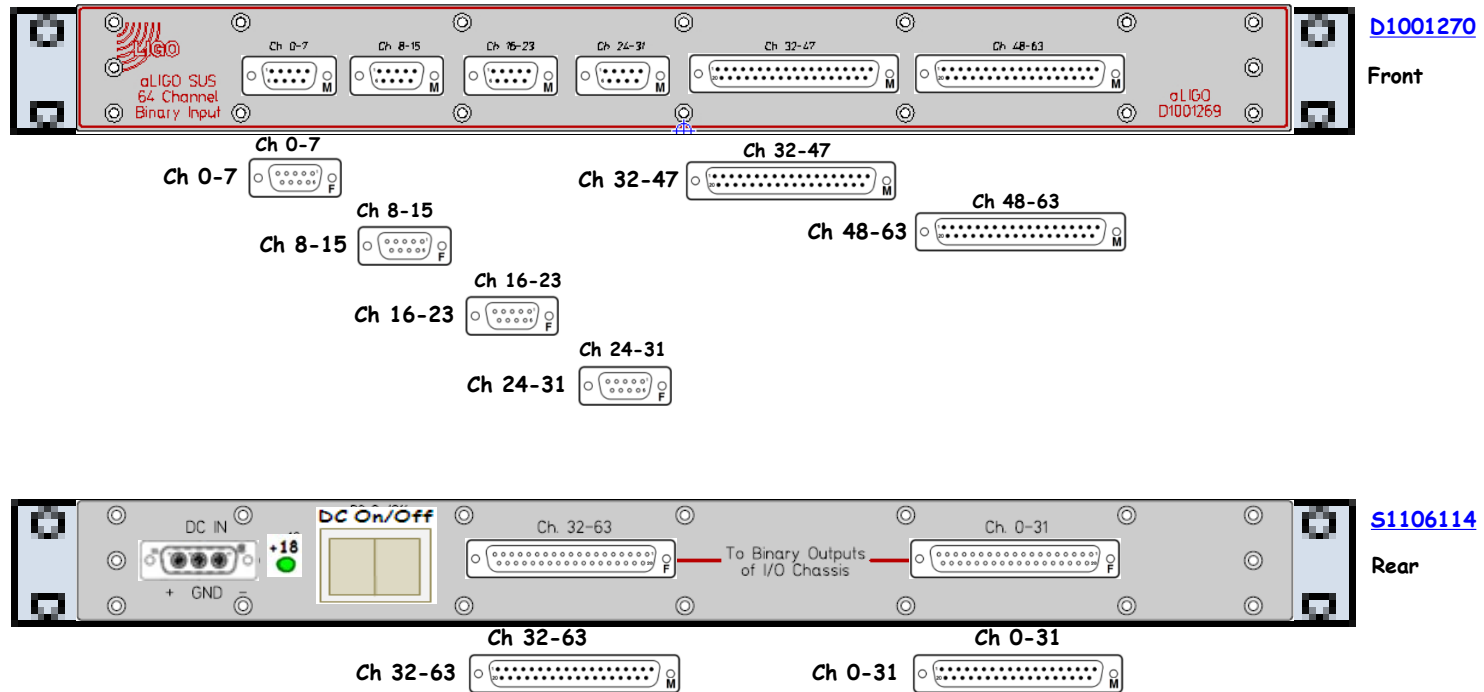

D1002593 - S1103224



<< L1-SUS-YC1

Binary Output Chassis (8*DB9) D1002593 S1103224 ±18VDC

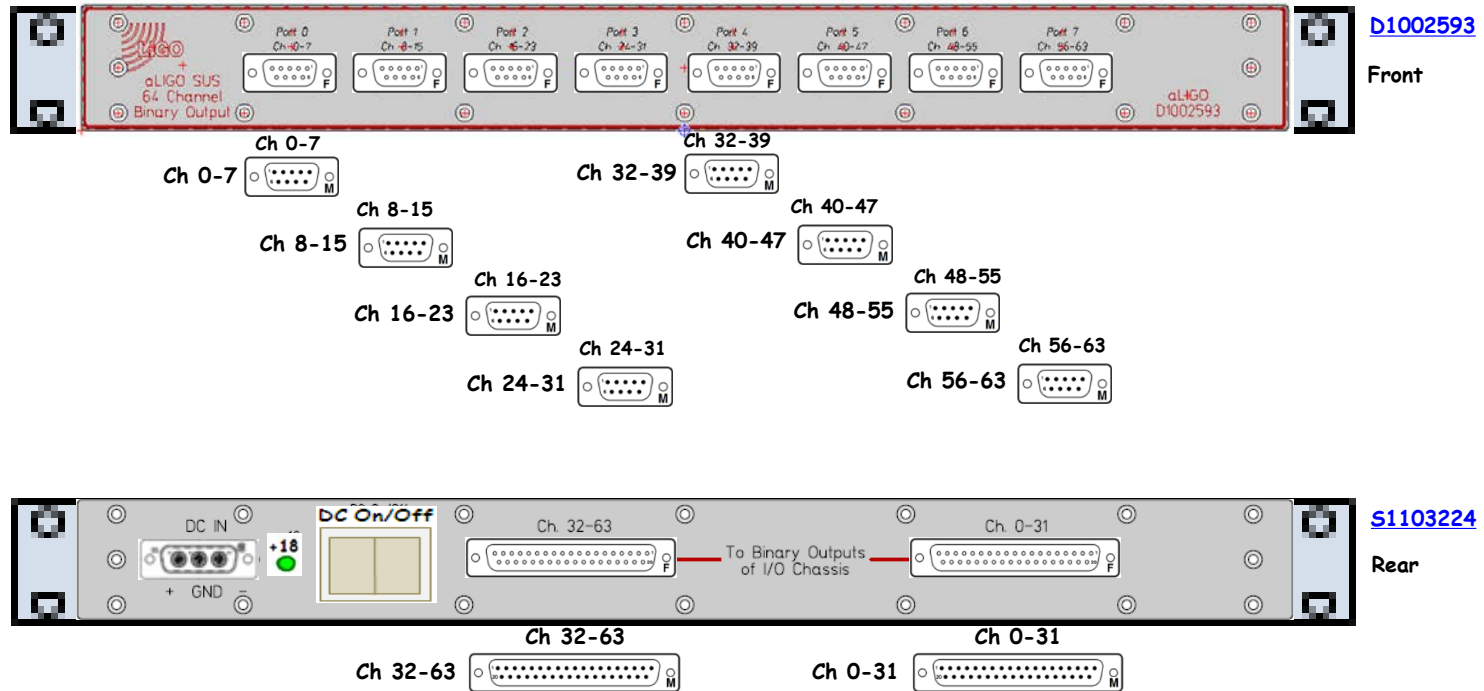

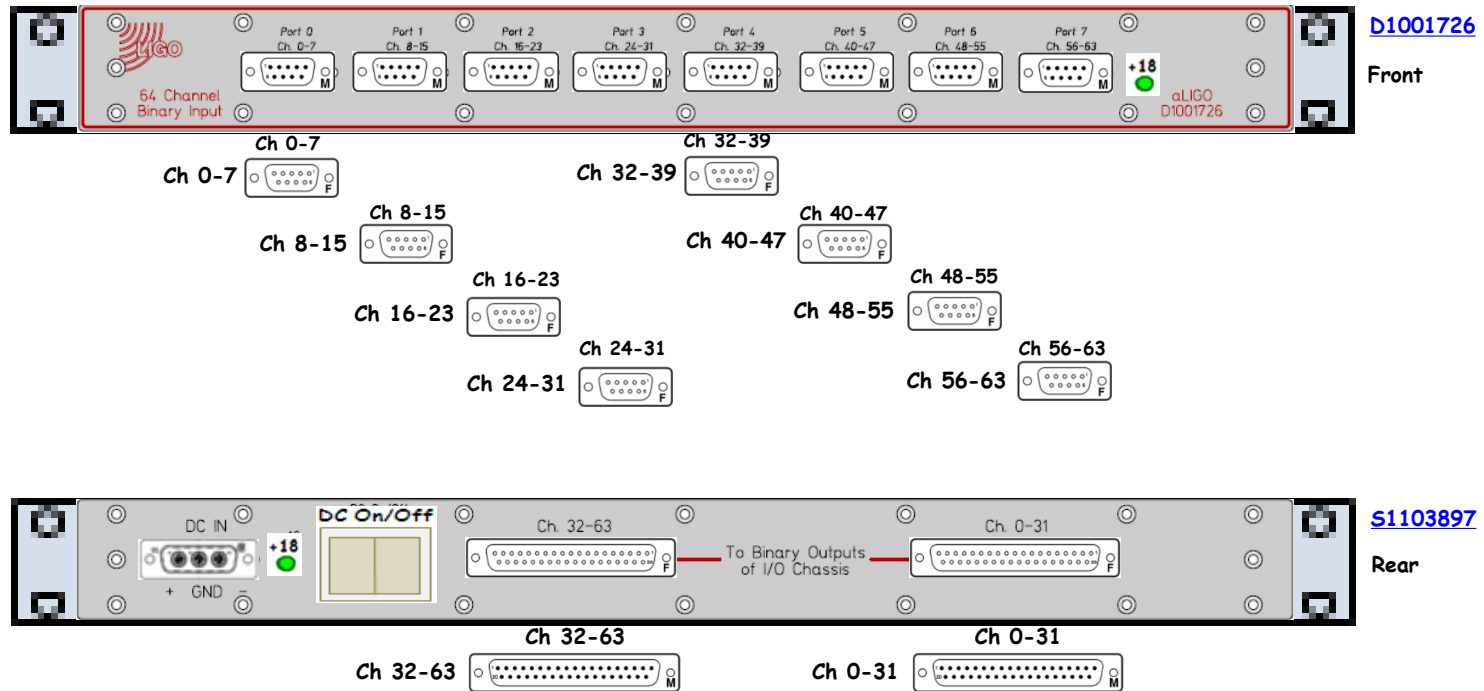

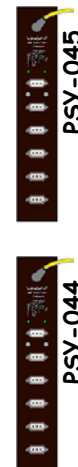
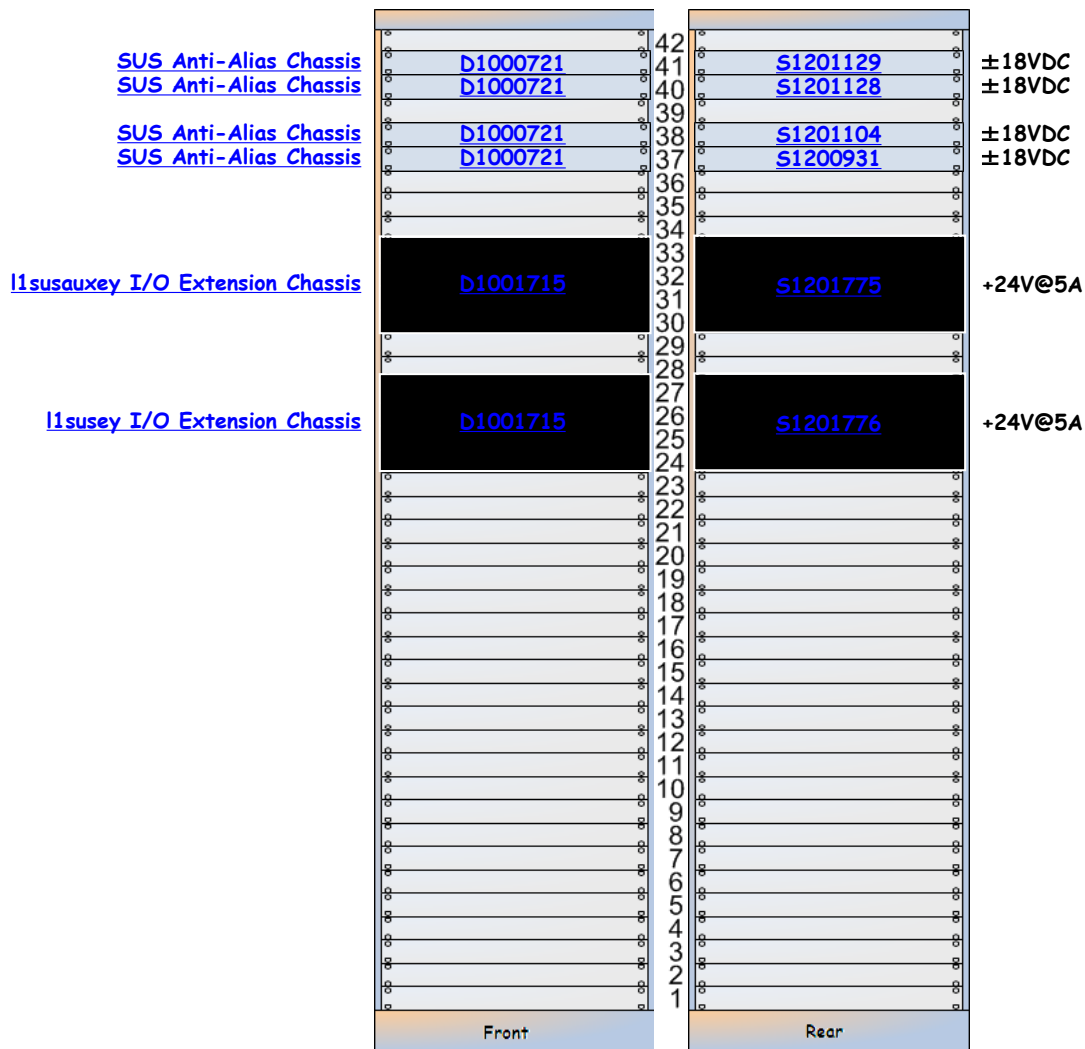

L1-SUS-YC2 Details

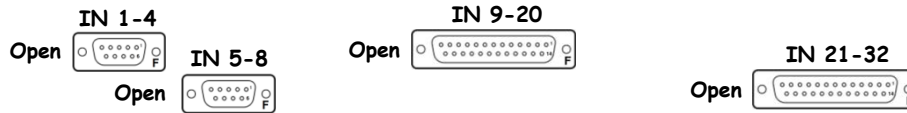

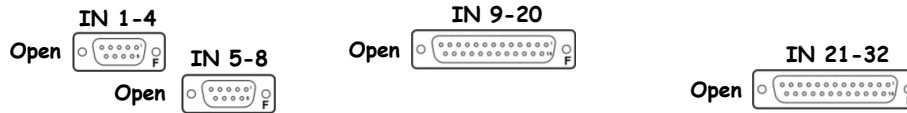

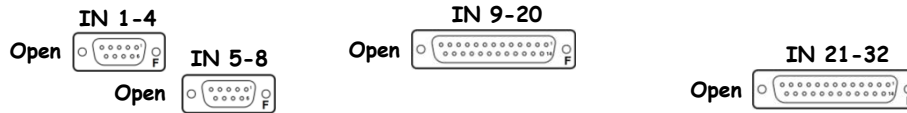

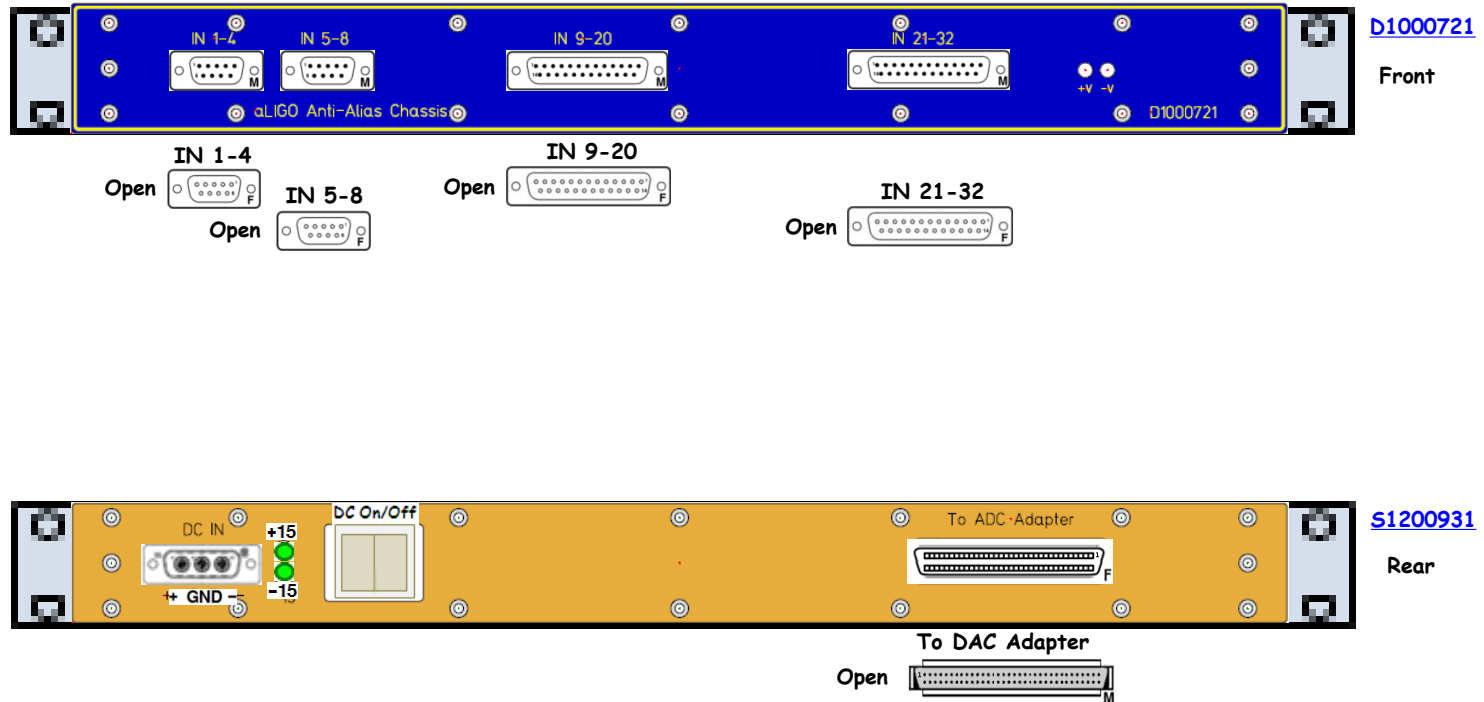



D1001715

Front

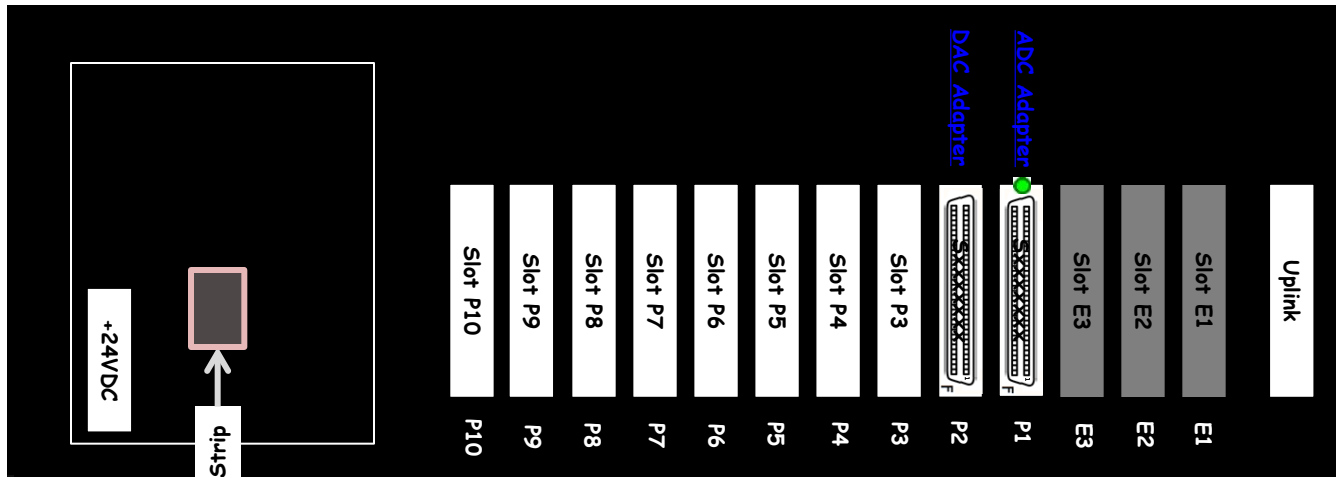

S1201775

Rear

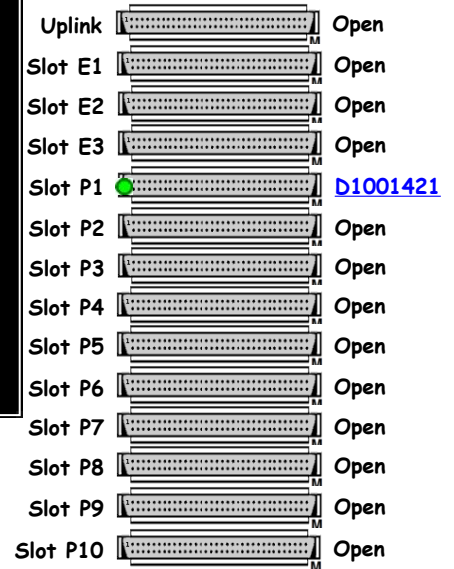

I1susey - D1001715 - S1201776

I1susey I/O Extension Chassis

D1001715

S1201776

110VAC



D1001715

Front

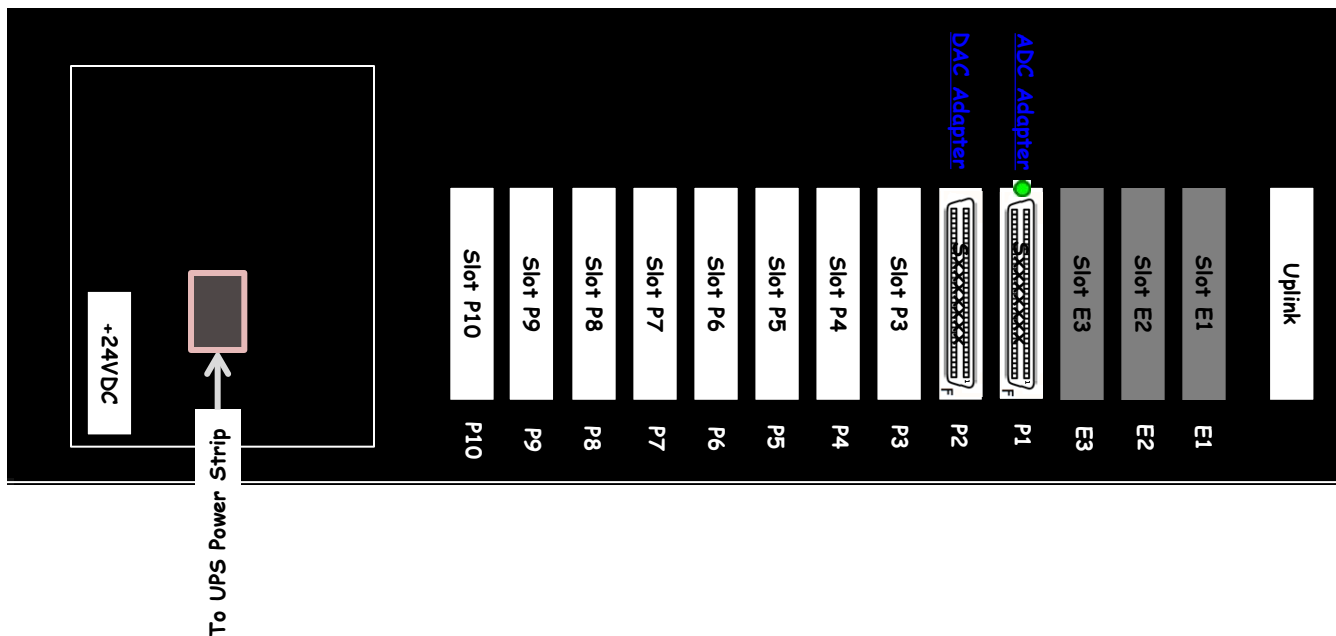

S1201776

Rear

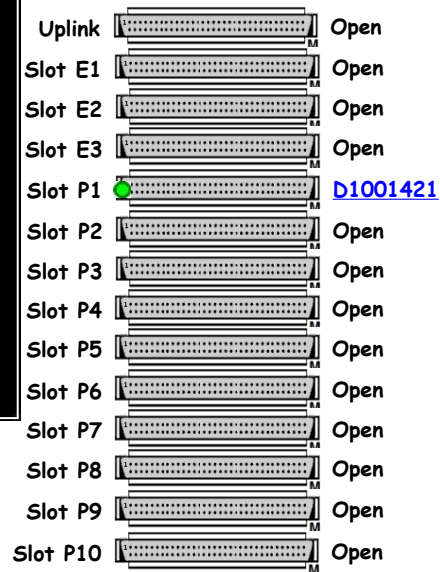

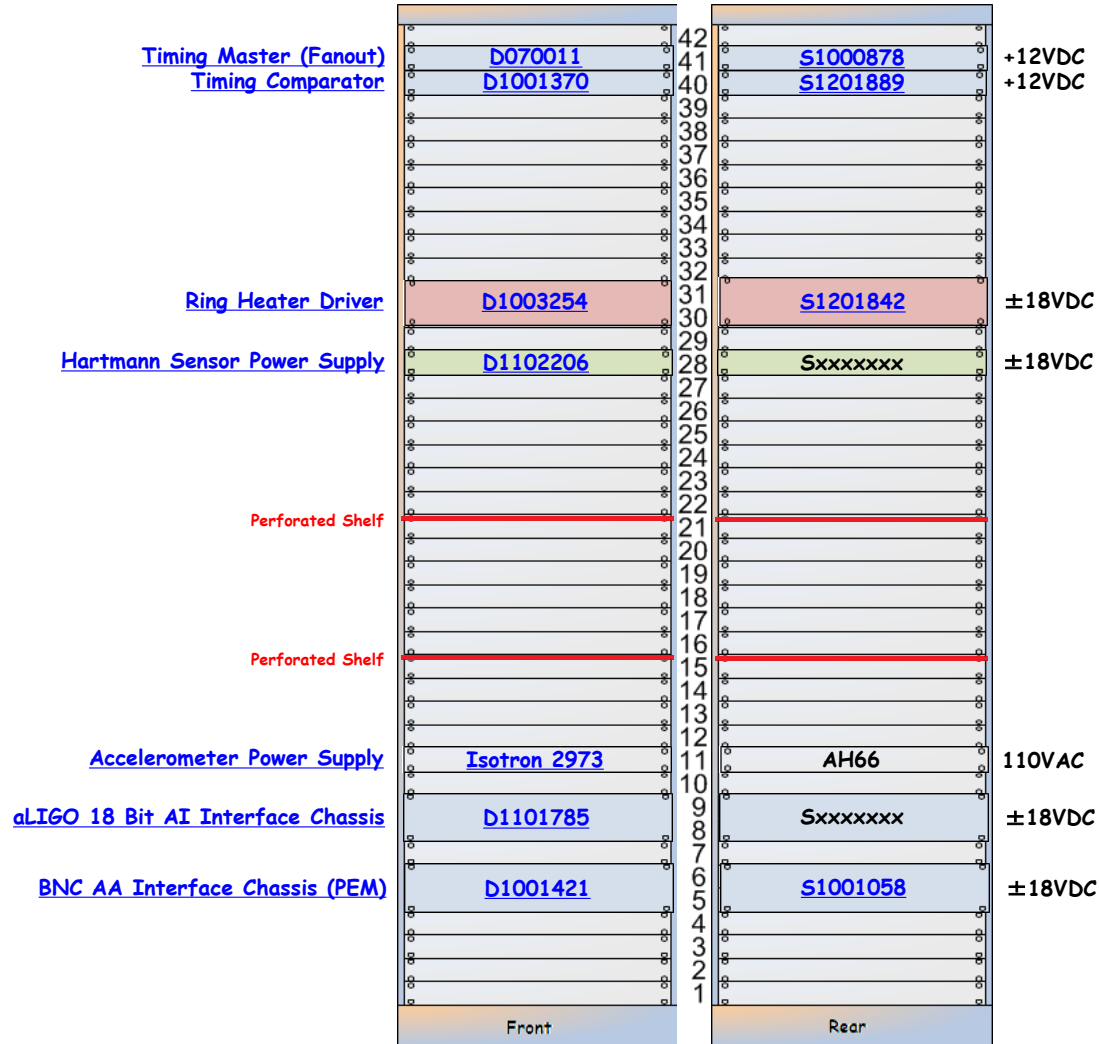

TCS-YC1 is part of [D1200258](#)
TCS-YC1 is part of [E1100894](#)

L1-TCS-YC1 Details



[D070011](#)

Front



[S1000878](#)

Rear

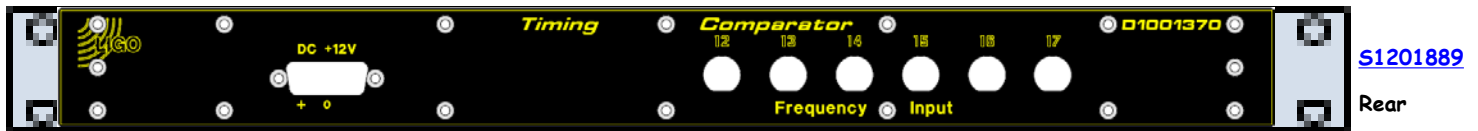
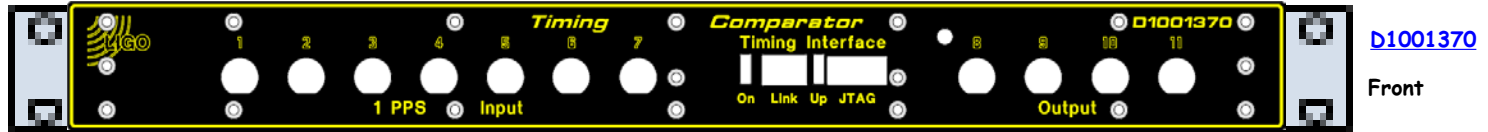

<< L1-TCS-YC1

Ring Heater Driver

D1003254

S1201842

±18VDC

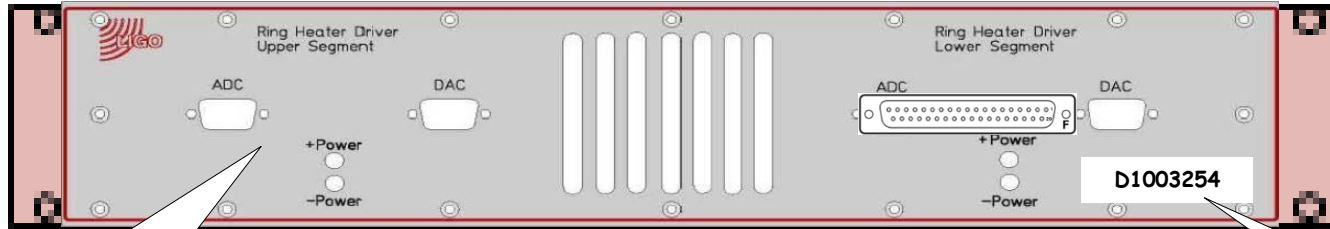

D1003254

Front

This is an early revision of the front panel. It now has one DB37M connector. 20121205 dlk

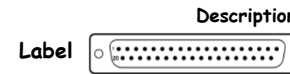

White label 20121205 dlk

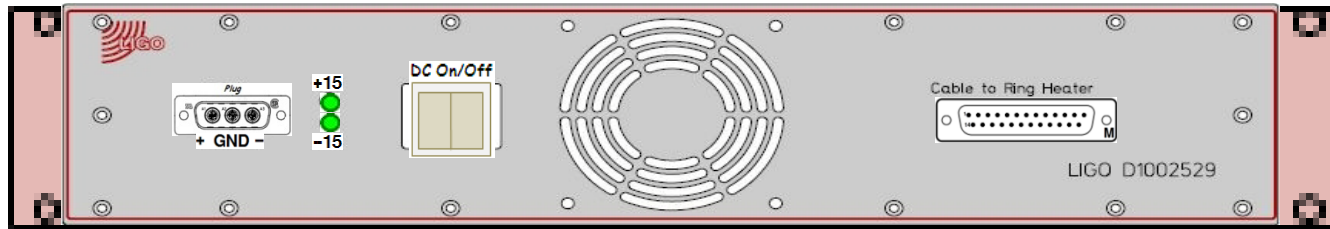

S1201842

Rear



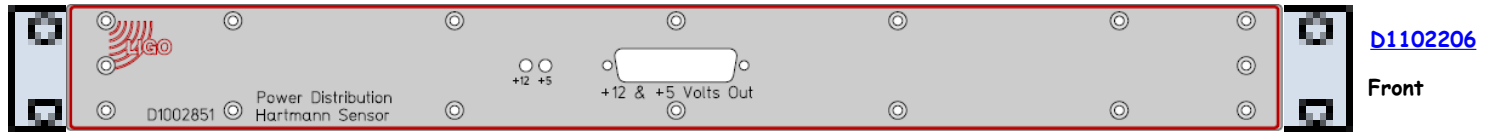

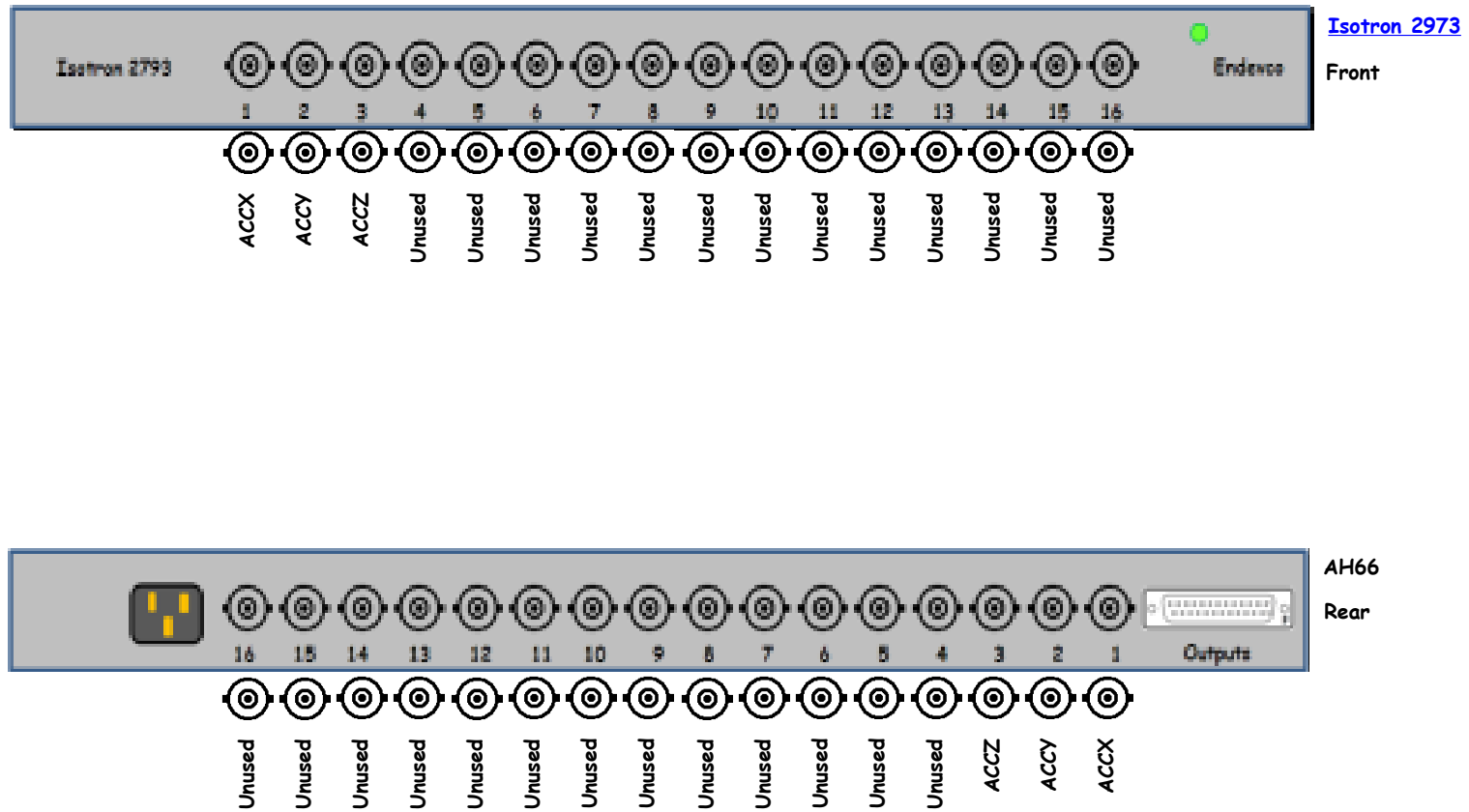

Isotron 2973

Front

AH66

Rear

D1101785 - Sxxxxxxx

aLIGO 18 Bit AI Interface Chassis

D1101785

Sxxxxxxx

±18VDC

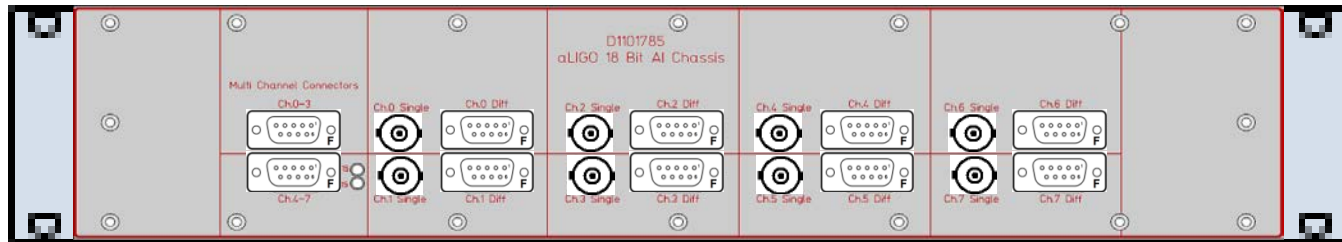

D1101785

Front

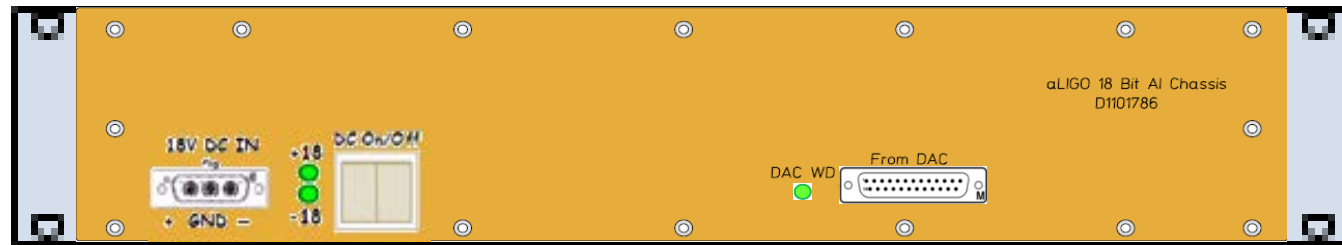
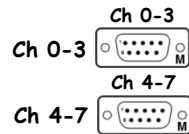

Sxxxxxxx

Rear



BNC AA Interface Chassis (PEM)

[D1001421](#)

[S1001058](#)

±18VDC

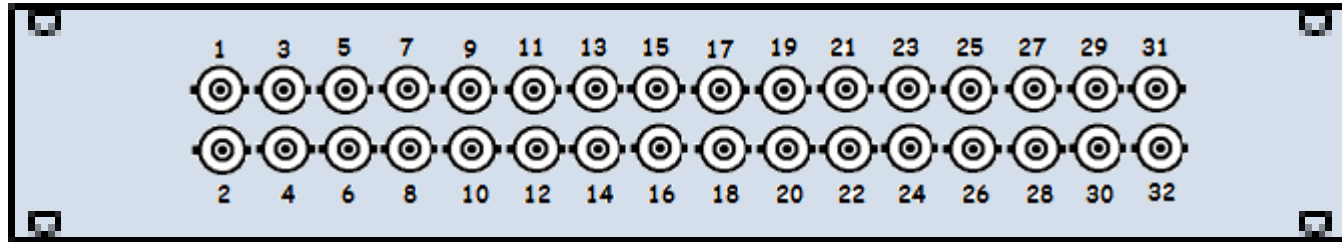

[D1001421](#)

Front

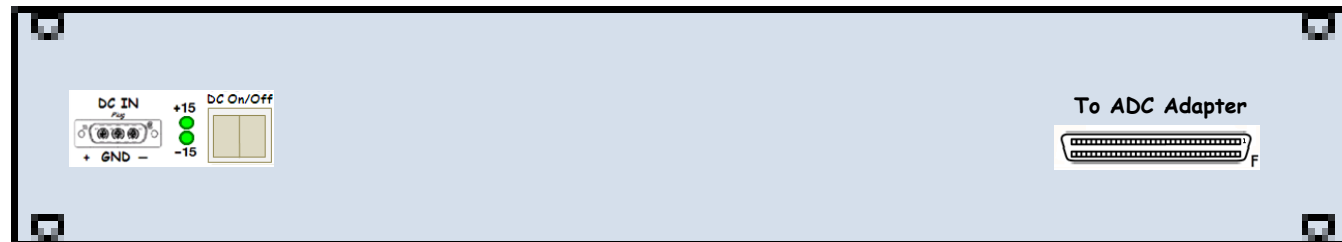
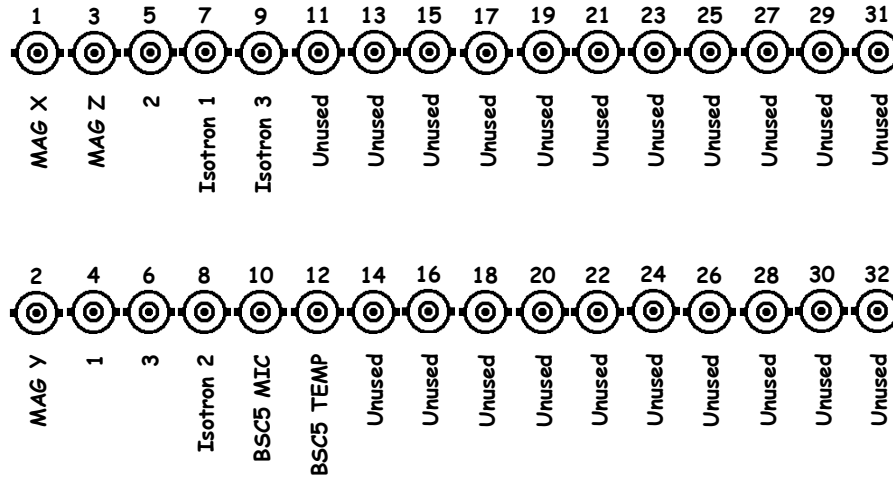

[S1001058](#)

Rear

[To l1pemey Slot P1](#)

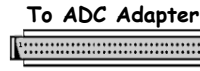

To ADC Adapter

<< L1-TCS-YC1

aLIGO Accelerometer Interface Chassis

D1101363

SN:

Power

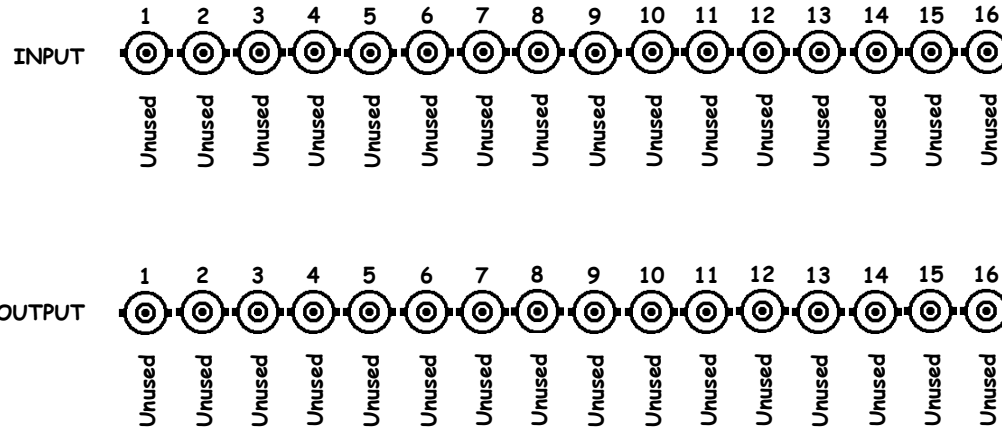
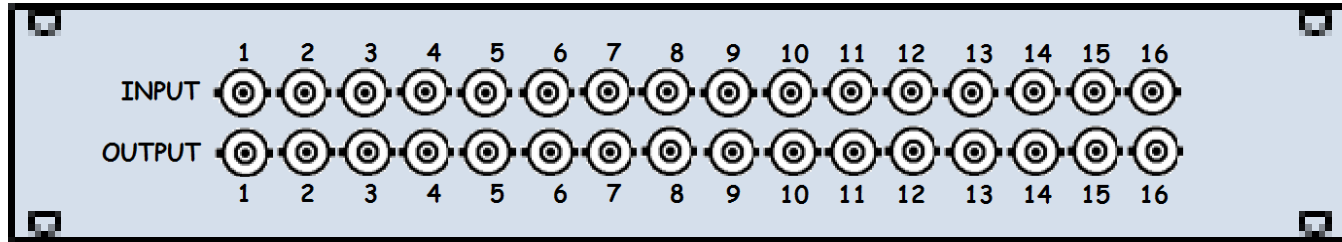



- [RF Distribution Panel 24](#)
- [RF Distribution Panel 25](#)
- [24.5 MHz Delay Line Phase Shifter](#)
- [2 Channel RFPD I/Q Demod \(RC & ALS\)](#)
- [WFS Demodulator Patch Panel](#)
- [79.4 MHz VCO \(ALS\)](#)
- [39.7 MHz Frequency Divider](#)
- [RF Preamplifier](#)
- [39.7 MHz 2 Channel Phase/Freq Discriminator](#)
- [Common Mode Servo \(ALS Laser Locking\)](#)
- [Common Mode Servo \(ALS Cavity Locking\)](#)
- [LSC Demod Concentrator 5](#)
- [ASC Demod Concentrator 6](#)
- [Auxiliary Signals Concentrator 2](#)
- [Auxiliary Signals Concentrator 1](#)
- [Auxiliary Signals Concentrator 5](#)
-
- [QUAD I&Q Demodulator Module](#)
-
- [Differential to Single-Ended Converter](#)
- [ISC Whitening Chassis](#)
- [Dual QPD Transimpedance Amplifier](#)
- [Dual QPD Transimpedance Amplifier](#)
- [ISC Whitening Chassis](#)

Dxxxxxxx	42	SN:	No Power
Dxxxxxxx	41	SN:	No Power
D0900128	40	S1103430	±15VDC
D1000181	39	S1000786	±17VDC, ±24VDC
D1100905	38	Sxxxxxxx	No Power
D0900605	37	S1200578	±17VDC, ±24VDC
D1002182	36	S1000753	±17VDC, ±24VDC
D1201294	35	Sxxxxxxx	??
D1002476	34	S1000768	±17VDC, ±24VDC
D0901781	33	S1102646	±17VDC, ±24VDC
D0901781	32	S1102647	±17VDC, ±24VDC
D1100691	29	S1104010	±18VDC
D1100696	28	S1103989	No Power
D1102045	27	S1200535	±17VDC
D1102065	26	S1200552	±17VDC
D1102065	25	Sxxxxxxx	±17VDC
	24		
	23		
	22		
	21		
	20		
	19		
	18		
	17		
	16		
D0902796	15	S1000987	±15VDC
	14		
	13		
	12		
	11		
	10		
	9		
	8		
D1100482	7	S1203308	±15VDC
D1002559	6	Sxxxxxxx	±15VDC
D1002481	5	Sxxxxxxx	±18V
D1002481	4	Sxxxxxxx	±18V
D1002559	3	Sxxxxxxx	±15VDC
	2		
	1		

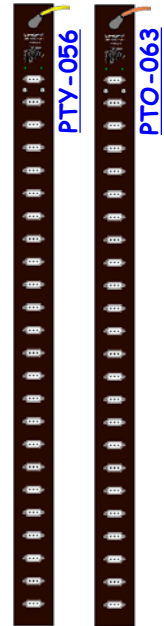

ISC-YR1 is part of [D1001423](#)

L1-ISC-YR1 Details

RF Patch Panel 24

RF Patch Panel 24

Dxxxxxxx

Sxxxxxxx

No Power

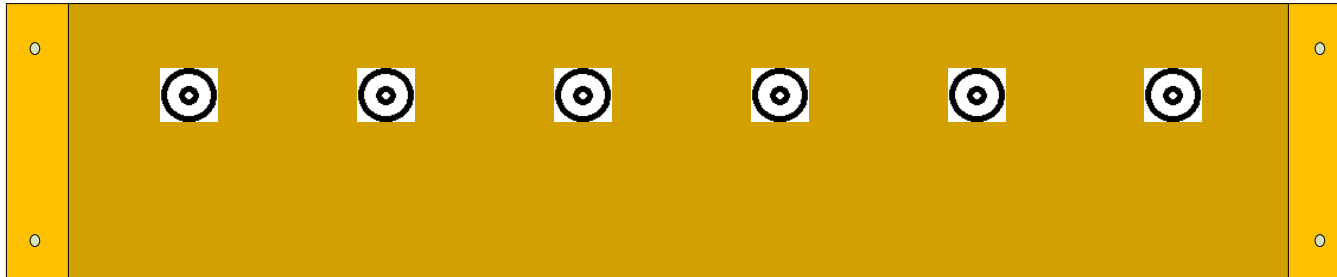

Dxxxxxxx

Front

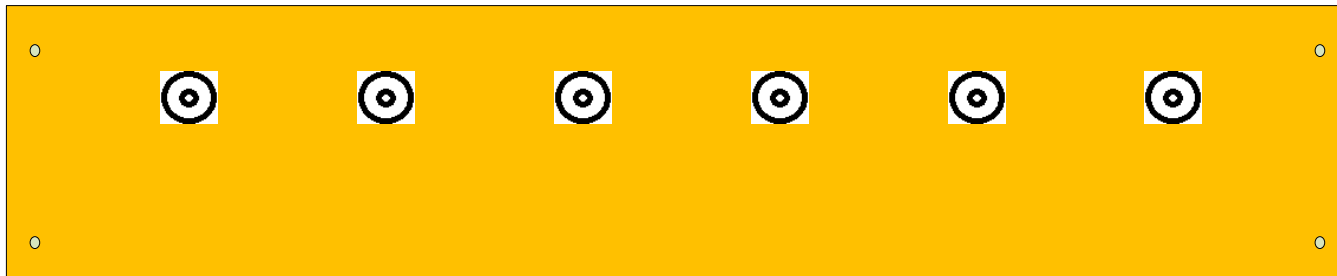

Sxxxxxxx

Rear

RF Patch Panel 25

RF Patch Panel 25

Dxxxxxxx

Sxxxxxxx

No Power

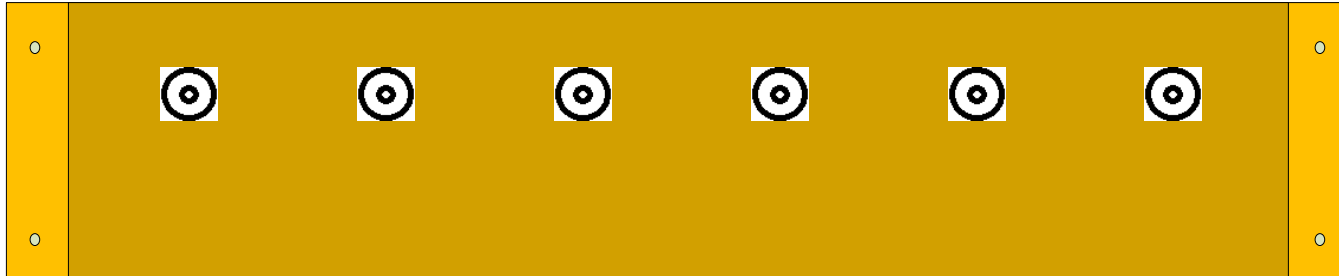

Dxxxxxxx

Front

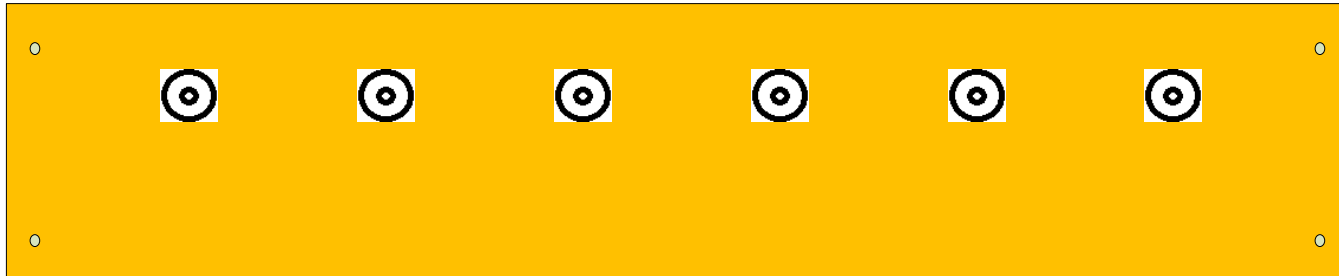

Sxxxxxxx

Rear

<< L1-ISC-YR1

Delay Line Phase Shifter +15VDC



[D0900128](#)

Front

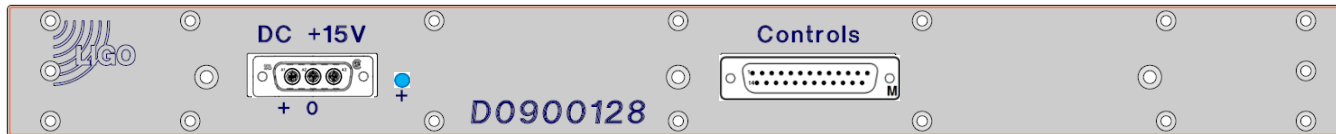

[S1103430](#)

Rear

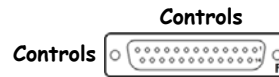

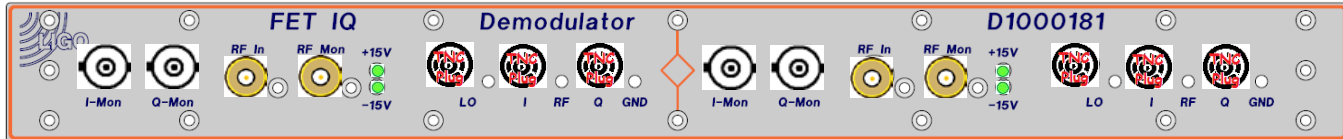

D1000181

Front

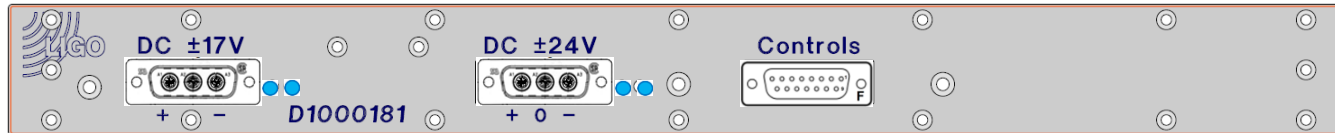

S1000786

Rear

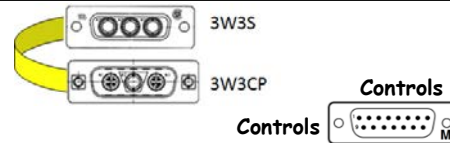

<< L1-ISC-YR1

WFS Demodulator Patch Panel No Power

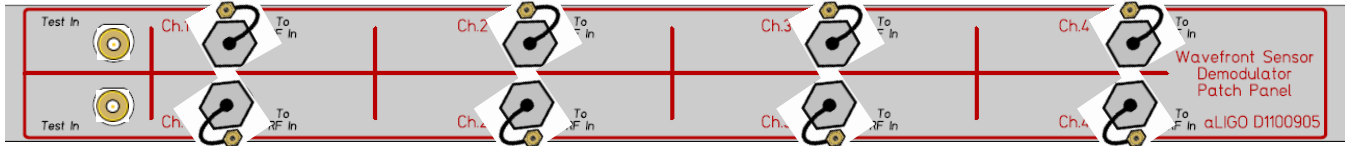

[D1100905](#)

Front



Sxxxxxxx

Rear

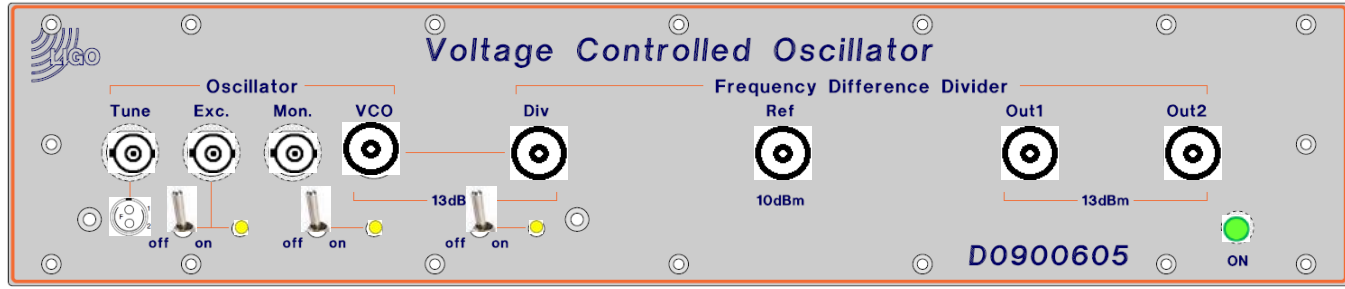

D0900605

Front

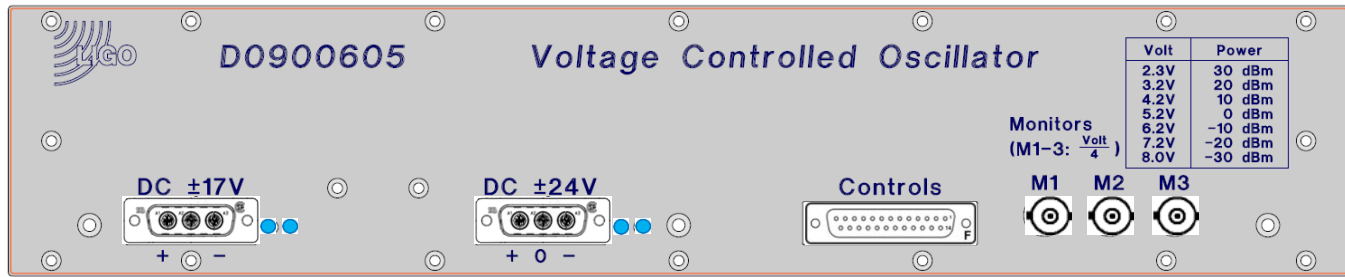
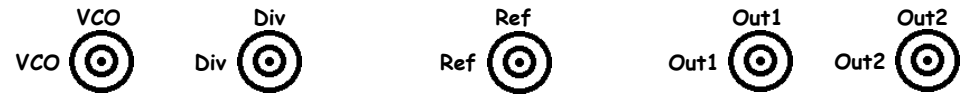

S1200578

Rear

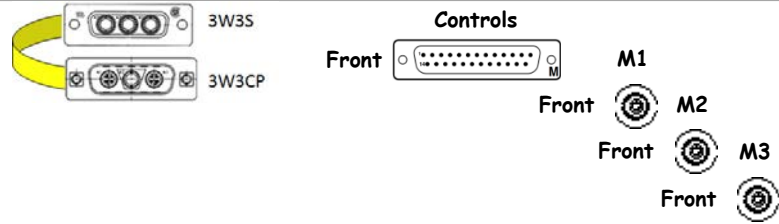

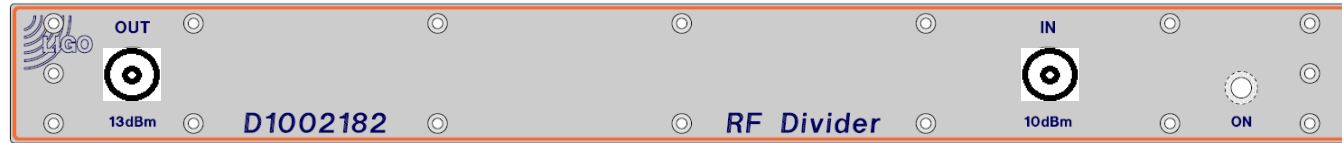

D1002182

Front

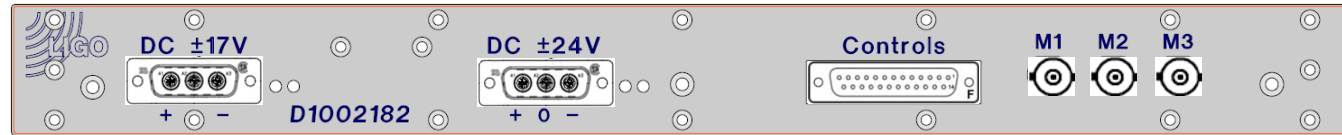
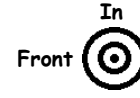

S1000753

Rear

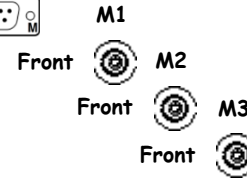
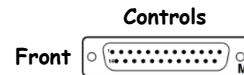
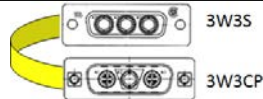

D1201294 - Sxxxxxxx

RF Preamplifier ±18V

[D1002182](#)

Front

Sxxxxxxx

Rear

D1002476 - S1000768



<< L1-ISC-YR1

39.7 MHz 2 Channel Phase/Freq Discriminator

D1002476

S1000768

±17VDC, ±24VDC

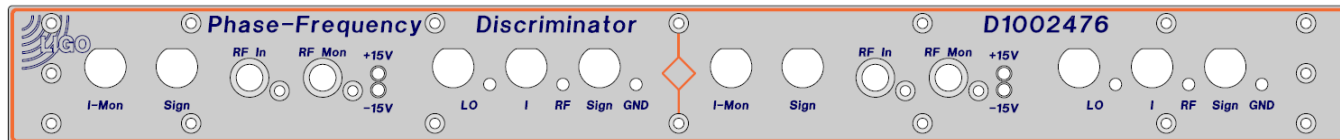

D1002476

Front

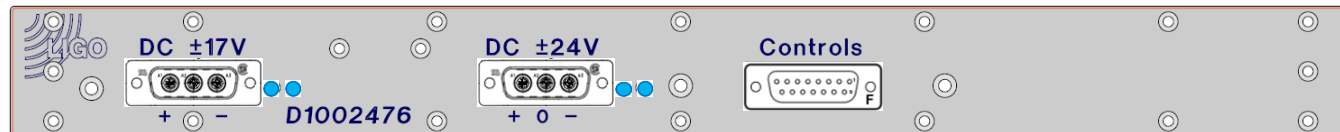

S1000768

Rear

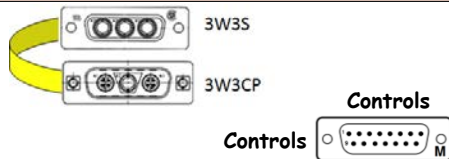



[D0901781](#)

Front

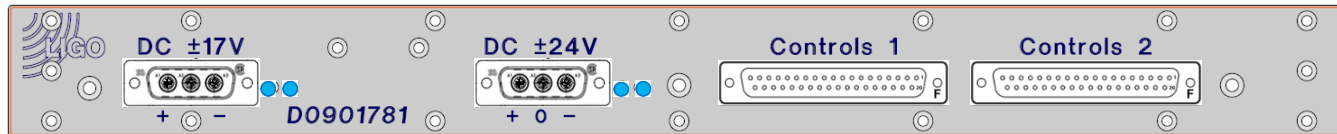

[S1102646](#)

Rear

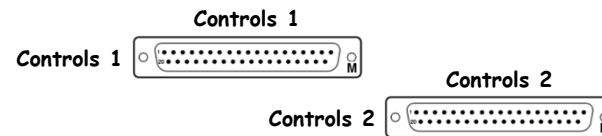
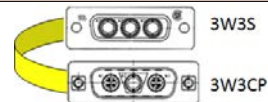

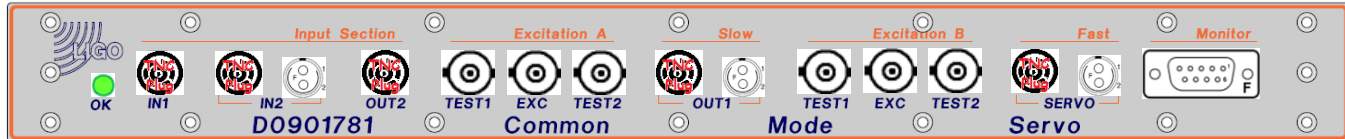

D0901781

Front

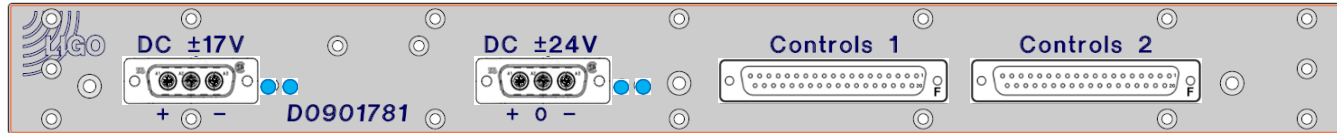

S1102647

Rear

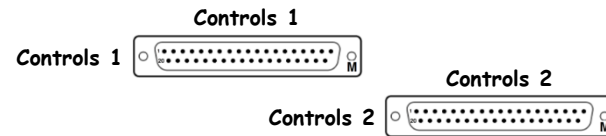
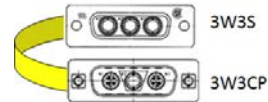

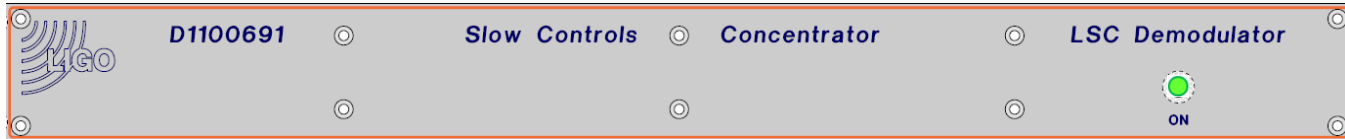

[D1100691](#)

Front

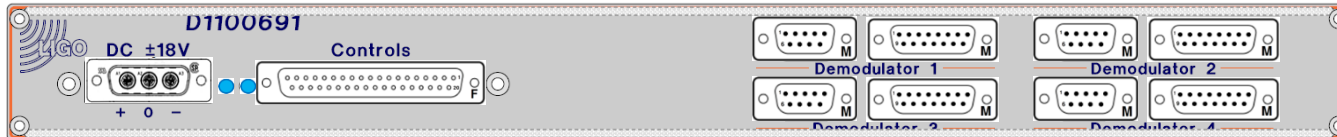

[S1104010](#)

Rear

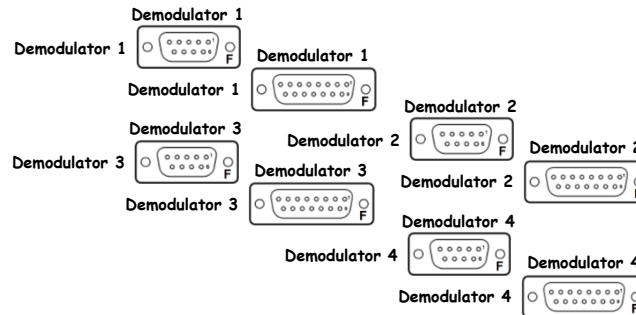
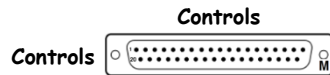

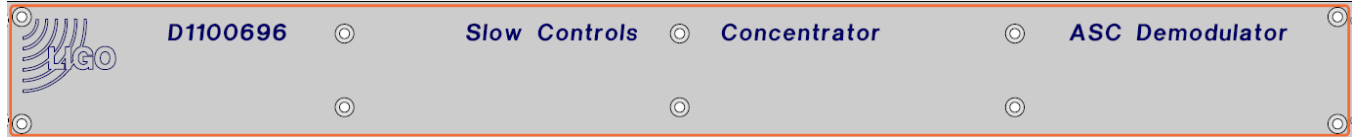

[D1100696](#)

Front

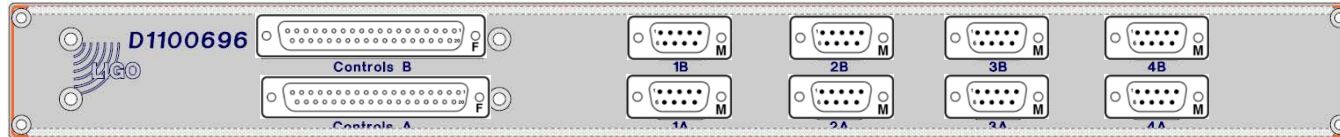

[S1103989](#)

Rear

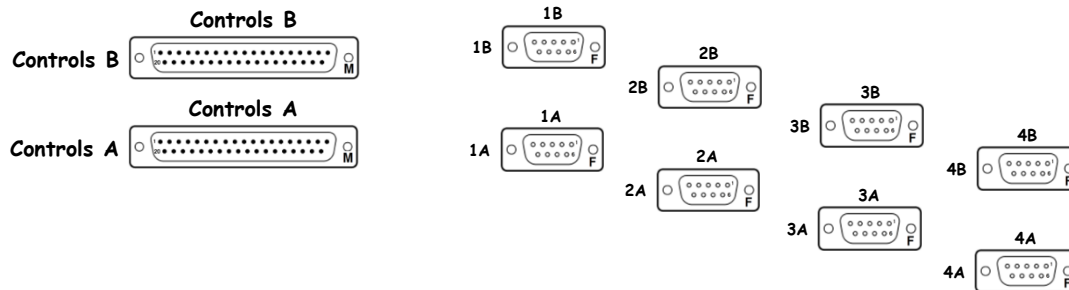



[S1200535](#)

Front

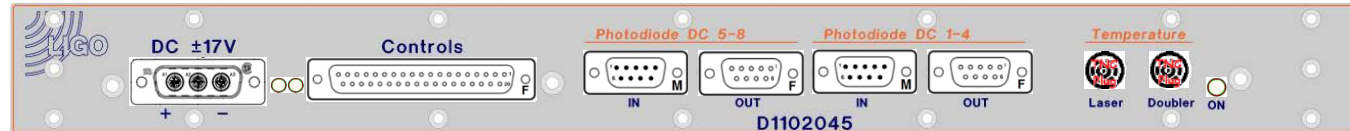

[S1200535](#)

Rear

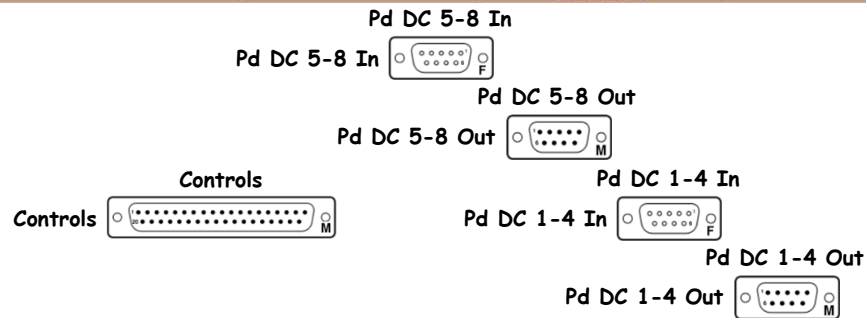

Auxiliary Signals Concentrator 1 D1102065 S1200552 ±18V

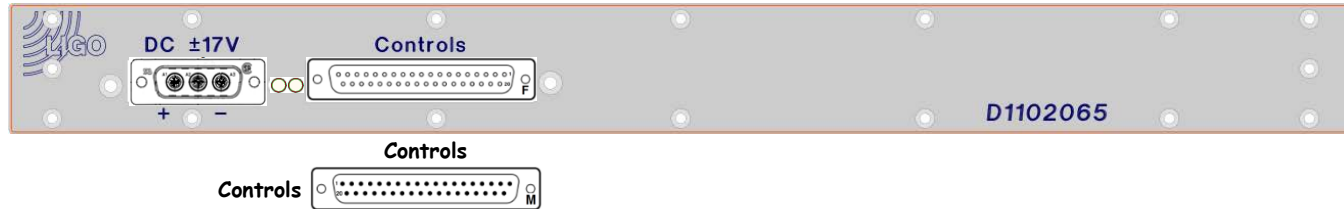

D1102065 - S1200552



<< L1-ISC-YR1

Auxiliary Signals Concentrator 5 D1102065 S1200552 ±18V

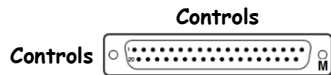
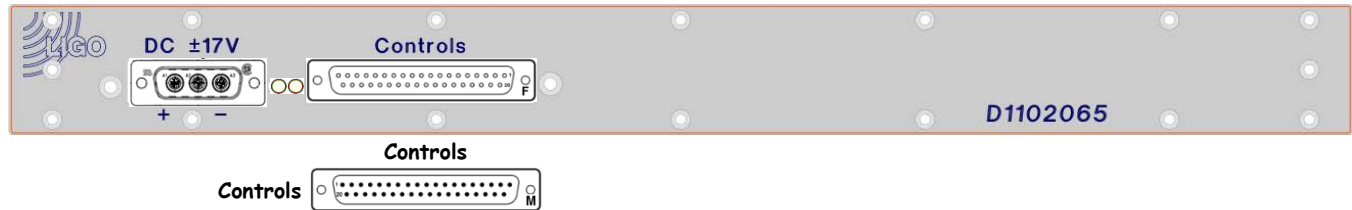

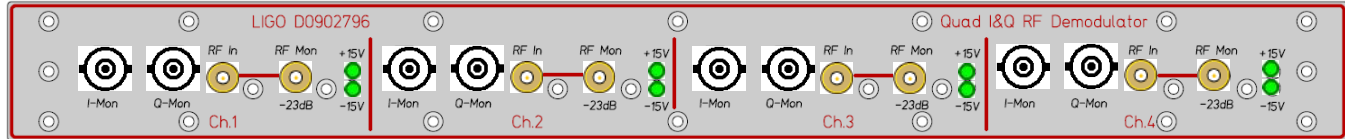

D0902796

Front

D1002032

LSC

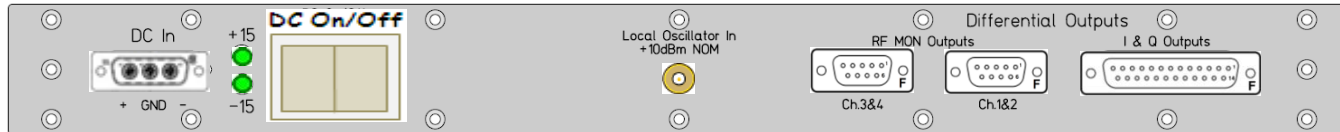

Sxxxxxxx

Rear

RF Mon Out Ch 3&4

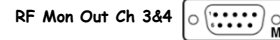

RF Mon Out Ch 3&4

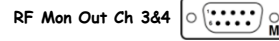

I & Q Outputs



D1002031

WFS

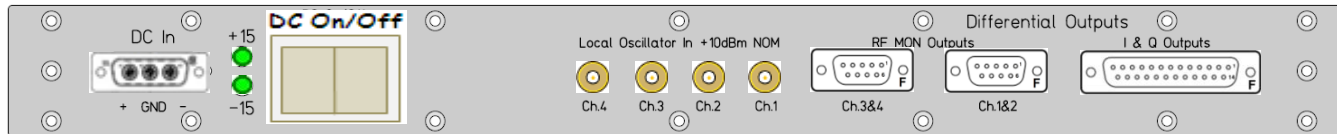

Sxxxxxxx

Rear

RF Mon Out Ch 3&4

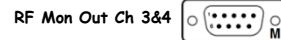

RF Mon Out Ch 3&4

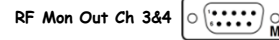

I & Q Outputs



D1100482 - S1203308



<< [L1-ISC-YR1](#)

Differential to Single-Ended Receiver

[D1100482](#)

[S1203308](#)

±15VDC

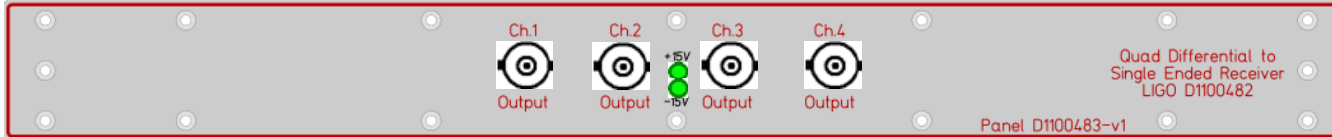

[D1100482](#)

Front



[S1203308](#)

Rear



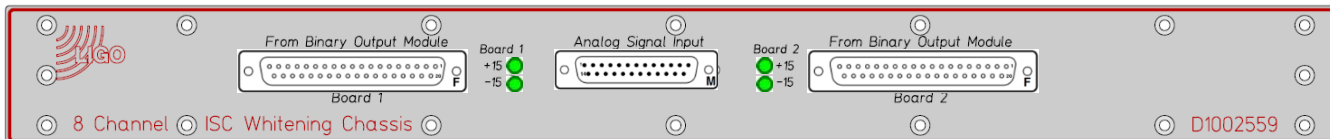

D1002559

Front

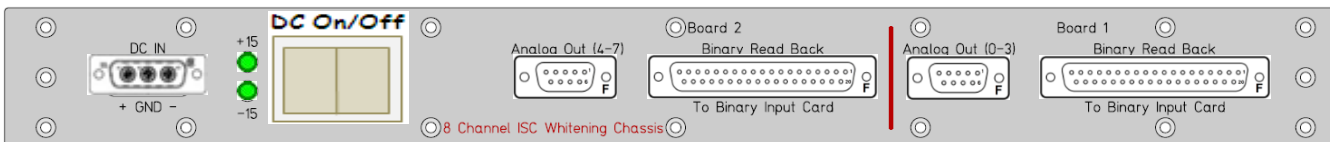
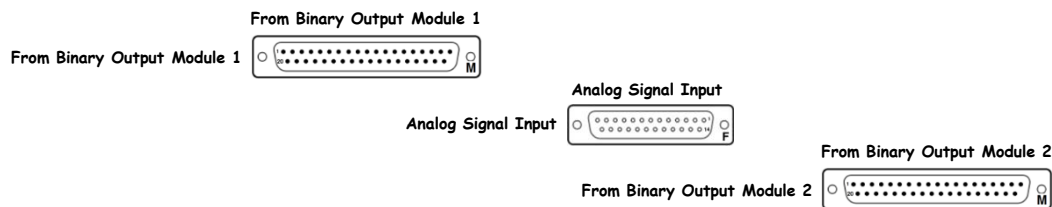

Sxxxxxxx

Rear

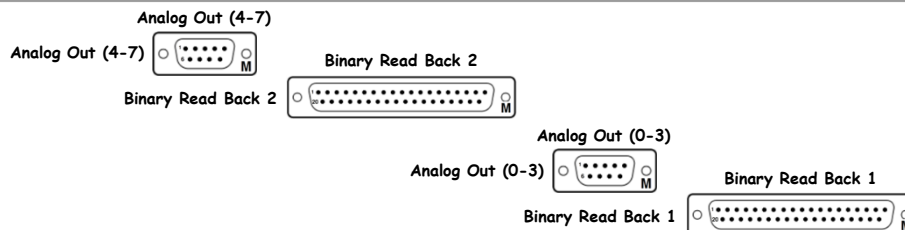

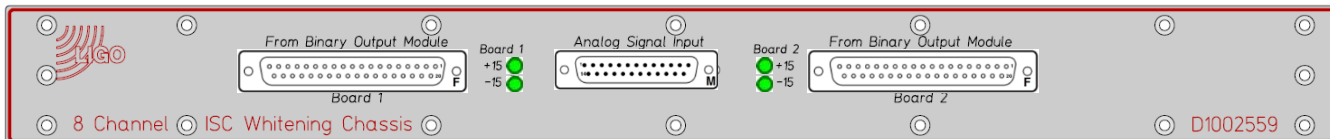

D1002559

Front

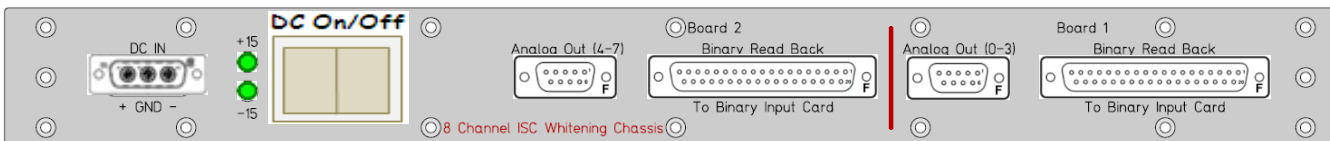
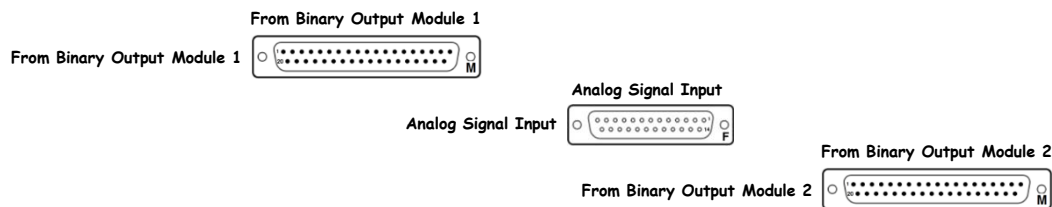

Sxxxxxxx

Rear

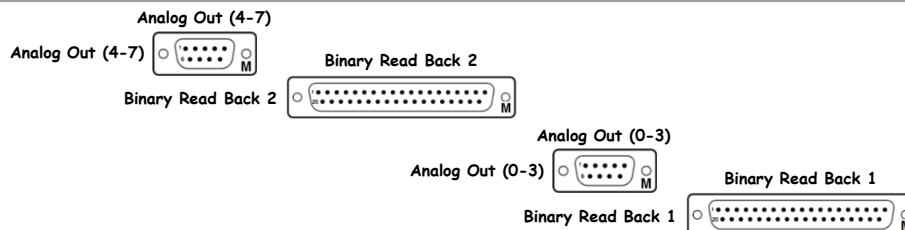

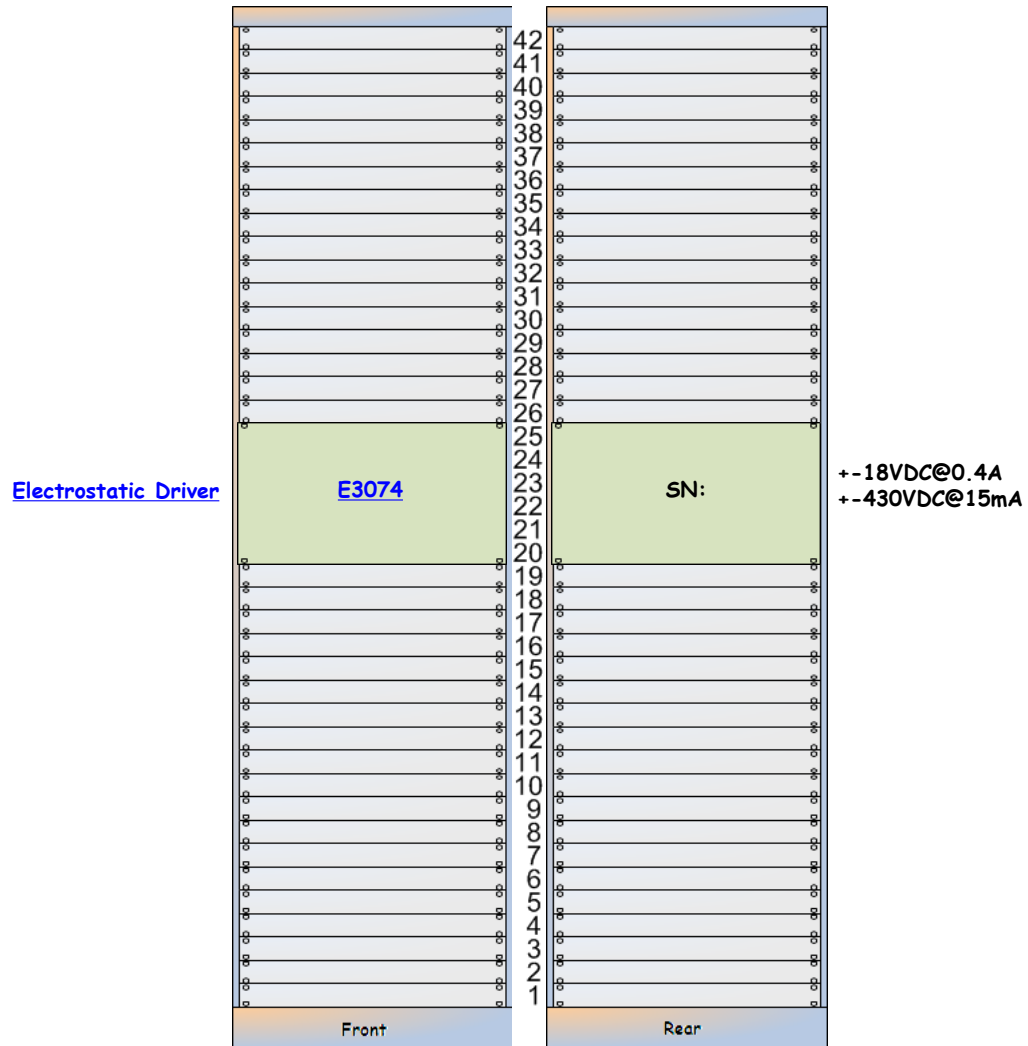

L1-SUS-YR1 Details

E3074

Electrostatic Driver

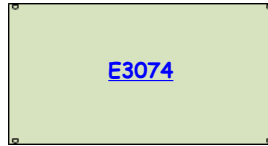

[E3074](#)

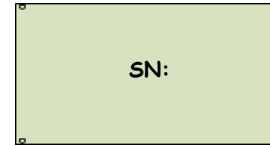

SN:

+ -18VDC@0.4A
+ -430VDC@15mA



[E3074](#)

Front



S???????

Rear

L1-VAC-YR1 Y-End Vacuum Rack Layout (Dxxxxxxx)

Marway MPD100 Power Distribution
 Power-Ten 3300D-3020 Switching DC Power Supply
 Power-Ten 3300D-3020 Switching DC Power Supply

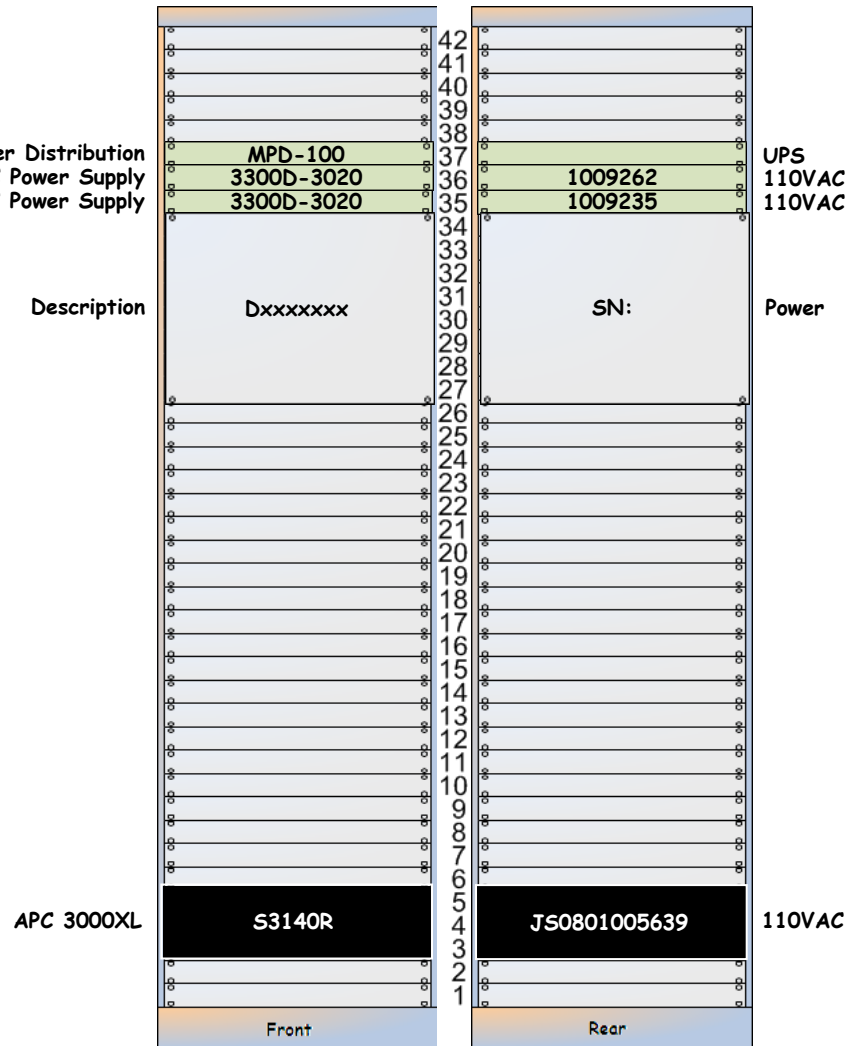

L1-VAC-YR1 Details

Marway MPD100 Power Distribution UPS

Power-Ten 3300D-3020 Switching DC Power Supply 110VAC

Power-Ten 3300D-3020 Switching DC Power Supply 110VAC

<< [L1-VAC-YR1](#)

Description

Dxxxxxxx

SN:

Power

CentreCom 210TS



Grey CAT5 Cable
to CDS Network
Switch Port 17

APC 3000XL

S3140R

JS0801005639

110VAC

Particle Counter

- Located in Mechanical Room
- +24VDC comes from Power-Ten 1009235
- 485-25E - Telebyte - Cat5 - 162-262 Port 3

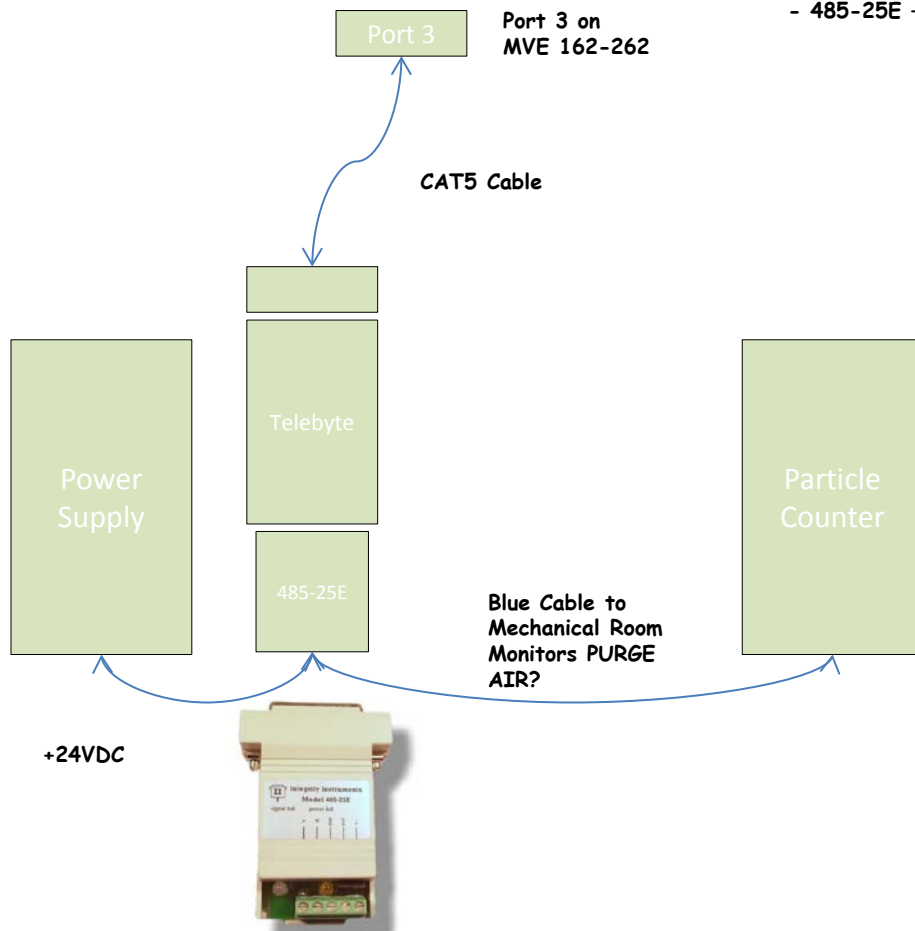

[<< LLO Corner Station](#)

[<< LLO Racks by AREA](#)

[<< LLO CDS Components](#)

DAQ (aka CDS) Test Rack (L1-ETR-01)	RMS (aka Triple) Test Rack (L1-ETR-04)	Triple SUS Test Rack (L1-ETR-07)
BSC (aka QUAD) Test Rack (L1-ETR-02)	HAM ISI Test Rack (L1-ETR-05)	Future Test Rack (L1-ETR-08)
Optics Test Rack (L1-ETR-03)	STS Huddle Test Rack (L1-ETR-06)	Future Test Rack (L1-ETR-09)

L1 DTS – IO

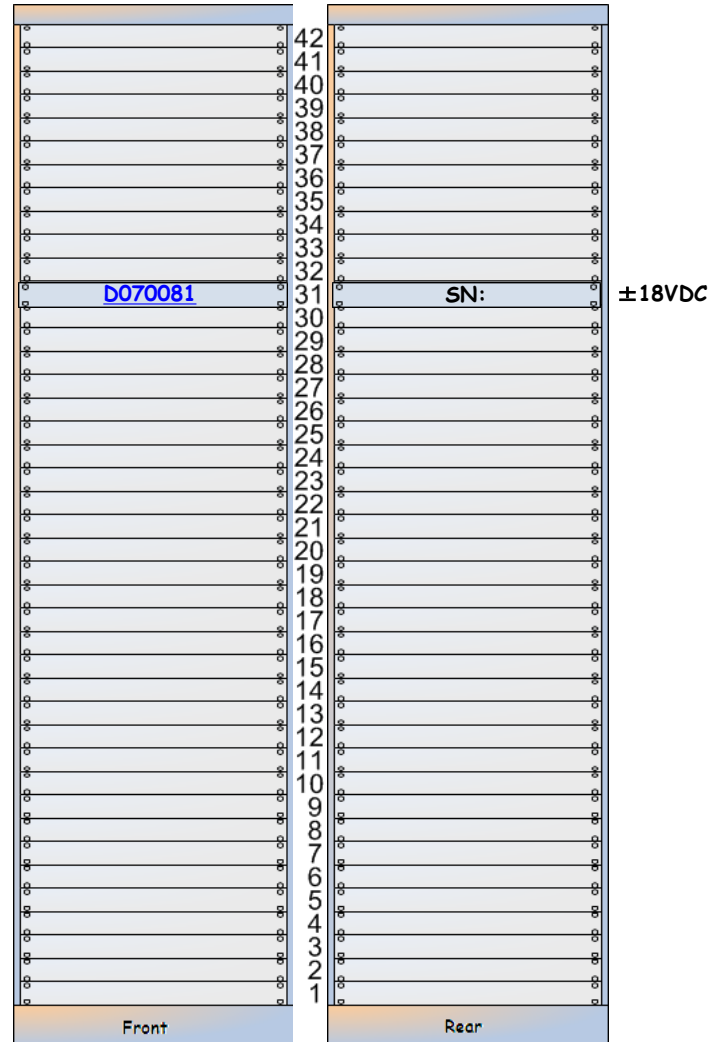
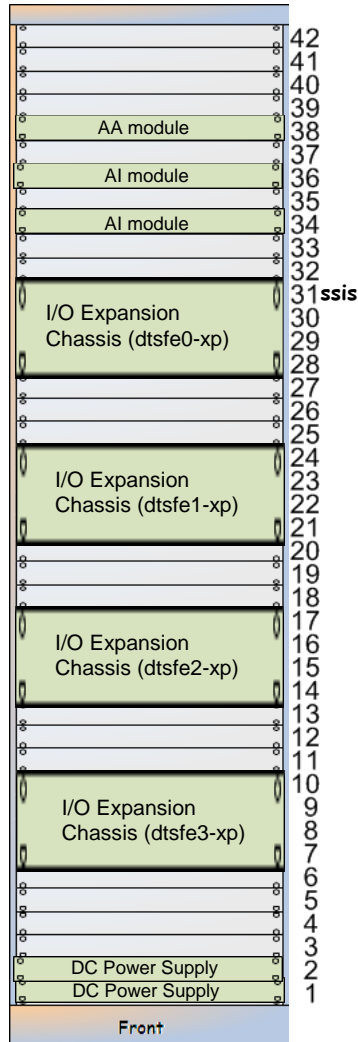

D070124 Rack Input
Power Box (RU 34-36)

+18VDC	?A
-18VDC	?A
+24VDC	?A
-24VDC	?A

L1-ETRO1 DAQ (aka CDS)

L1-ETRO1
Front

Linksys BEFSX41
Firewall Router
D070011 Fanout Timing
Netgear GS724T Switch
Netgear GSM7352S Switch
SUN Microsystems X2200
SuperMicro



I/O Extension
2 ADC
1 DAC
1 Timing Slave
Shelf
KVM



D070081 AI Chassis
D070081 AA Chassis



SuperMicro
SuperMicro
SuperMicro



JQE25-10M +15V
JQE25-10M -15V

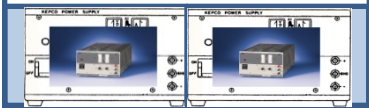

JQE25-10M +24V
JQE25-10M -24V

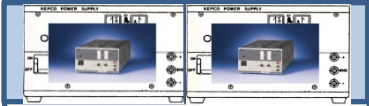

L1-ETRO1
Rear

D070011 Fanout Timing
SN:
SN:
0923QAT00D dtserver 192.168.100.10
... dtsfe1 192.168.100.15

DC Bus Distribution Box

Shelf
SN:
D070081 SYYYYYYYY
D070081 SYYYYYYYY
... dtstdco 192.168.100.30
... dtswfo 192.168.100.31
... dtsndso 192.168.100.32

SN:
SN:

SN:
SN:

Linier Rack – has front and rear doors and wheels.

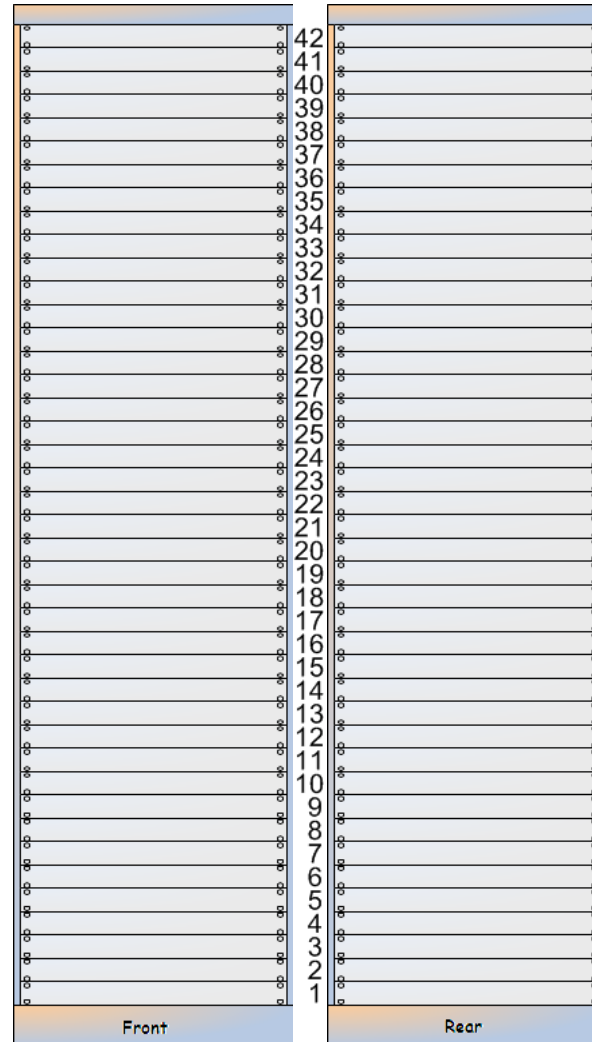
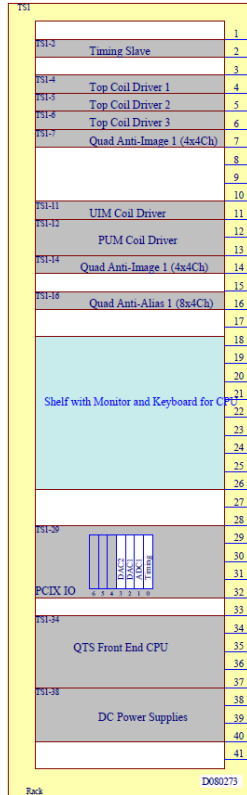

D070124 Rack Input Power Box (RU 34-36)

+18VDC	?A
-18VDC	?A
+24VDC	?A
-24VDC	?A

L1-ETRO2 BSC (aka Quad)

L1-ETRO2
Front

L1-ETRO2
Rear

Computer

I/O Extension
2 ADC
1 DAC
1 Timing Slave

JQE25-10M +15V
JQE25-10M -15V

SN:

SN:
SN:

Satellite Amplifier

Satellite Amplifier

Satellite Amplifier

Satellite Amplifier

Satellite Amplifier

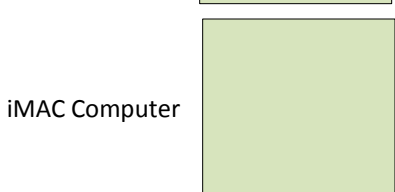
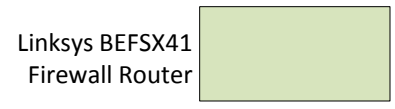
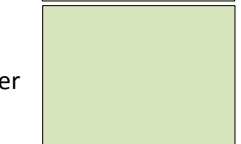
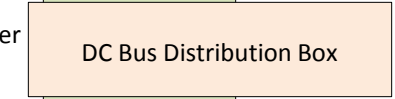

DC Bus Distribution Box

Linksys BEFSX41
Firewall Router

Netgear GS108
Gigabit Switch

iMAC Computer

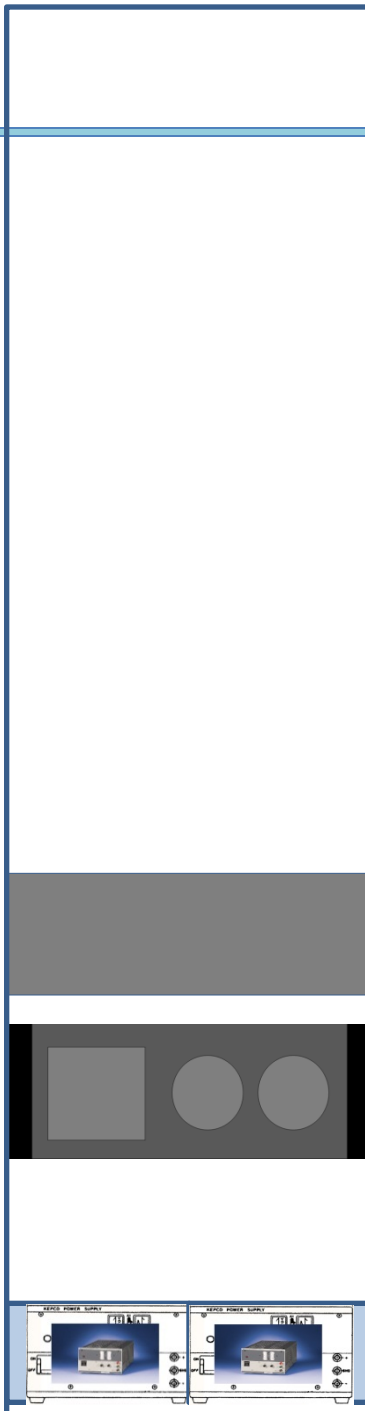



**D070124 Rack Input
Power Box (RU 34-36)**

+18VDC	?A
-18VDC	?A
+24VDC	?A
-24VDC	?A



Dxxxxxx-V1

L1-ETRO3 OPTICS

L1-ETRO3
Front

L1-ETRO3
Rear

Computer
I/O Extension
2 ADC
1 DAC
1 Timing Slave

SN:

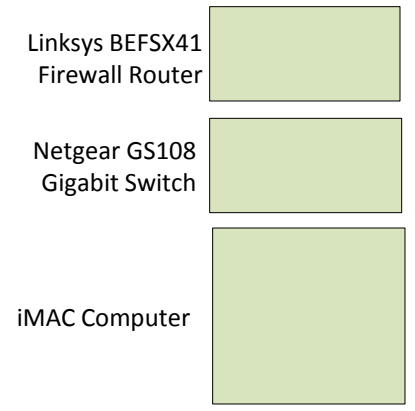

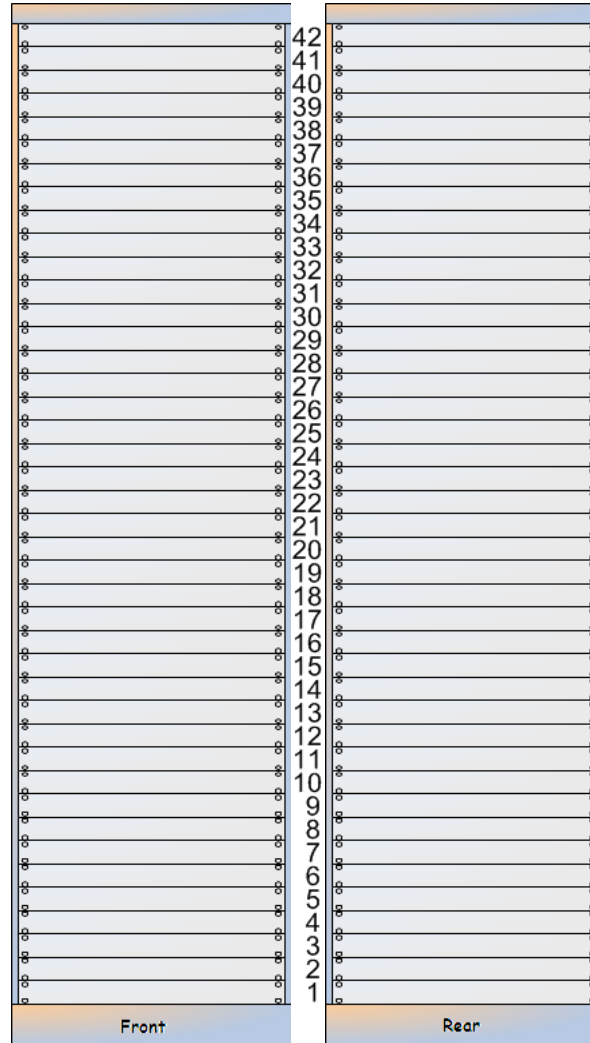

D070124 Rack Input Power Box (RU 34-36)

+18VDC	?A
-18VDC	?A
+24VDC	?A
-24VDC	?A

L1-ETRO4 RMT (aka Triple)

L1-ETRO4
Front

L1-ETRO4
Rear

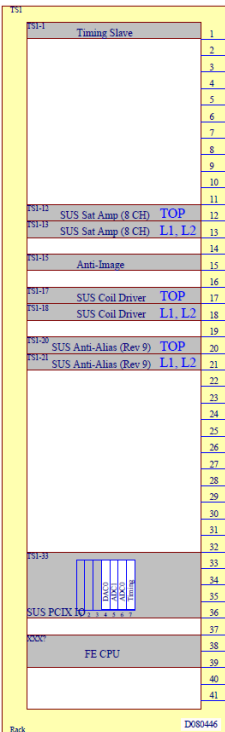

D1000305 AI Chassis

D1000305 SYYYYYYYY

D0902783 AA Chassis

D0902783 SYYYYYYYY

D0902783 AA Chassis

D0902783 SYYYYYYYY

Computer

SN:

I/O Extension

2 ADC

1 DAC

1 Timing Slave

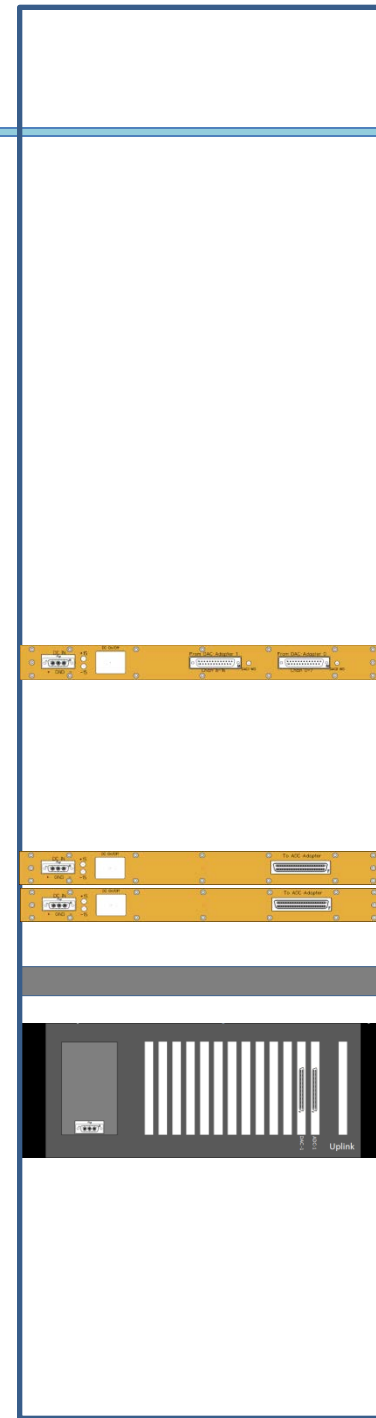
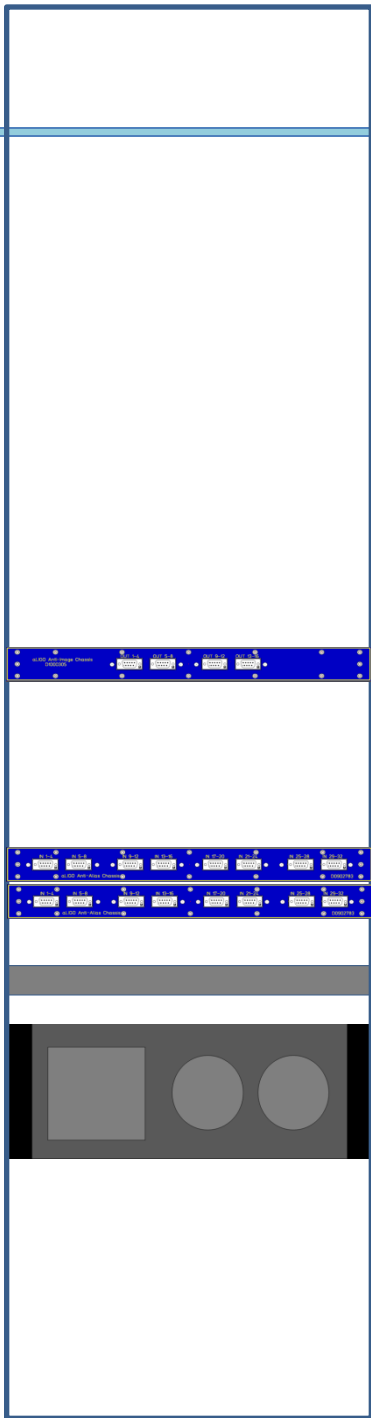
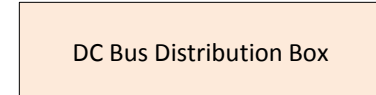

Linksys BEFSX41
Firewall Router



Netgear GS108
Gigabit Switch

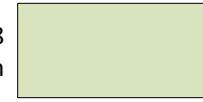

iMAC Computer

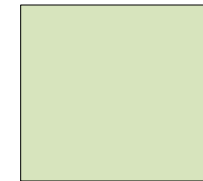

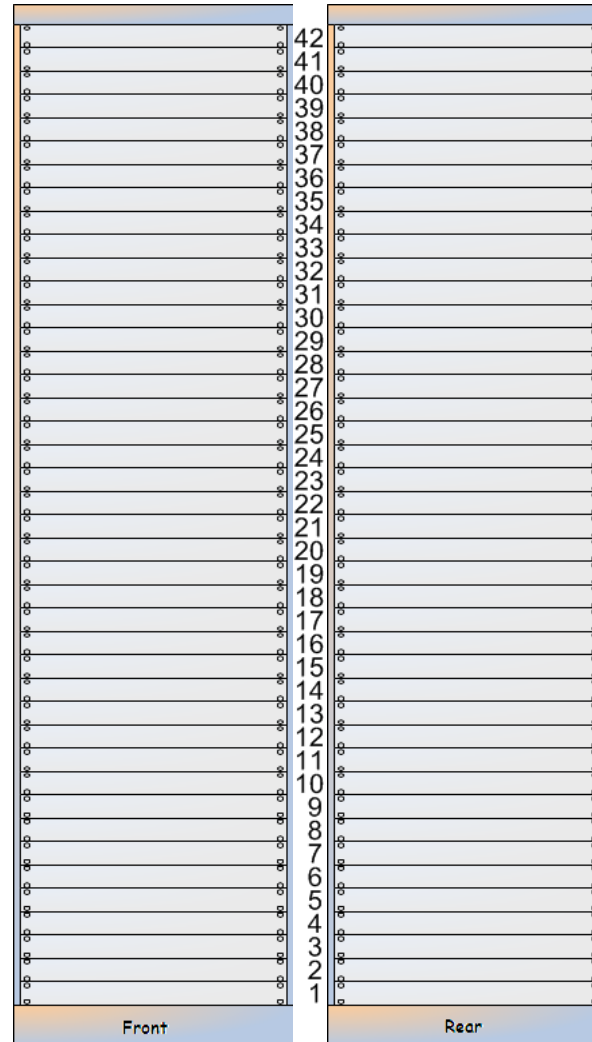

**D070124 Rack Input
Power Box (RU 34-36)**

+18VDC	?A
-18VDC	?A
+24VDC	?A
-24VDC	?A

D1001412-V1



Linksys BEFSX41 Firewall Router

Netgear GS108 Gigabit Switch

L1-ETRO5 HAM ISI

L1-ETRO5
Front

L1-ETRO5
Rear

ISI Interface Pod 1 & L4C
ISI Interface Pod 2 & L4C
ISI Interface Pod 3 & L4C

Anti-Alias (AA) Chassis

Anti-Alias (AA) Chassis

Anti-Image (AI) Chassis

ISI Coil Driver (Pod 1 and 2)

ISI Coil Driver (Pod 3)

D1000067 S1000311
D1000067 S1000312
D1000067 S1000314

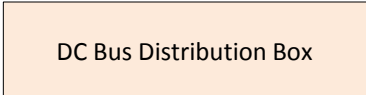

D1000269 S1000244

D1000269 S1000298

D070081 SS1000251

D0902744 S1000317

D0902744 S1000316

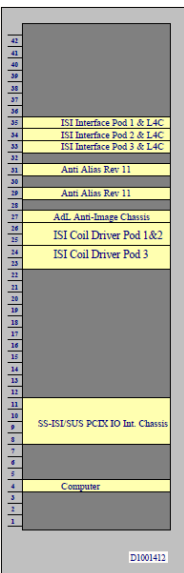

I/O Extension
2 ADC
1 DAC
1 Timing Slave
Computer

JQE25-10M +24V
JQE25-10M -24V

JQE25-10M +15V
JQE25-10M -15V

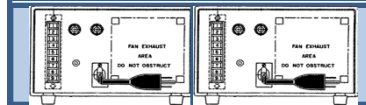
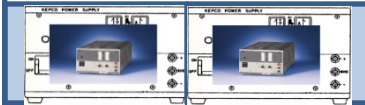
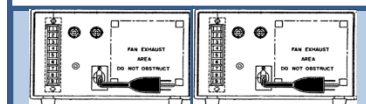
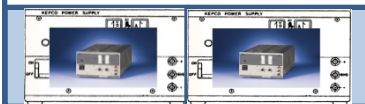

SN:

SN:

SN:

SN:

SN:

SN:

iMAC Computer



STS Huddle Test Rack Layout (D1001412)

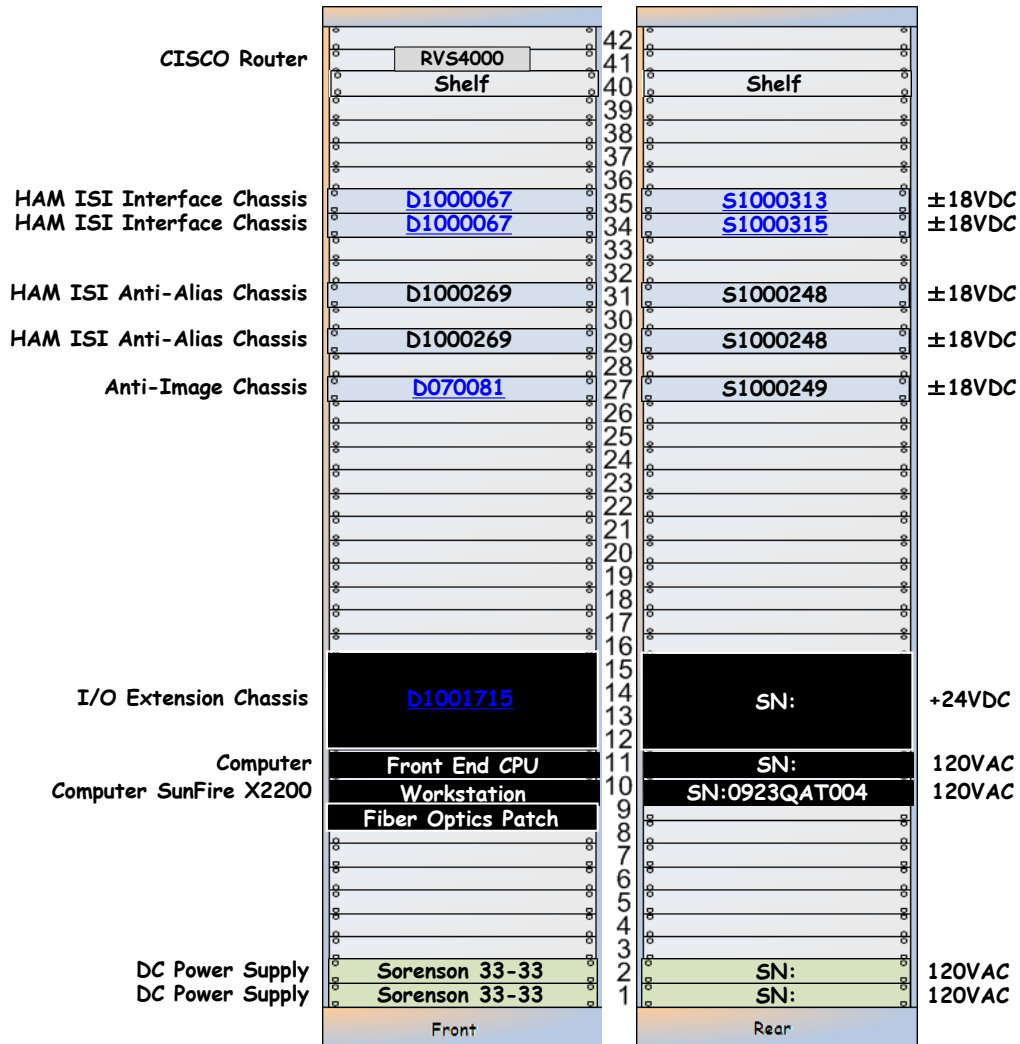

D070124 Rack Input Power Box (RU 34-36)

0 - ADC0
1 - DAC0
2 - ADC1

+18VDC	?A
-18VDC	?A
+24VDC	?A
-24VDC	?A

D1001412-V1

LIGO

L1-ETRO6
Front

L1:ETRO6 STS Huddle

L1-ETRO6
Rear

ISI Interface Pod 1 & L4C
Pod 2 & L4C
Pod 3 & L4C

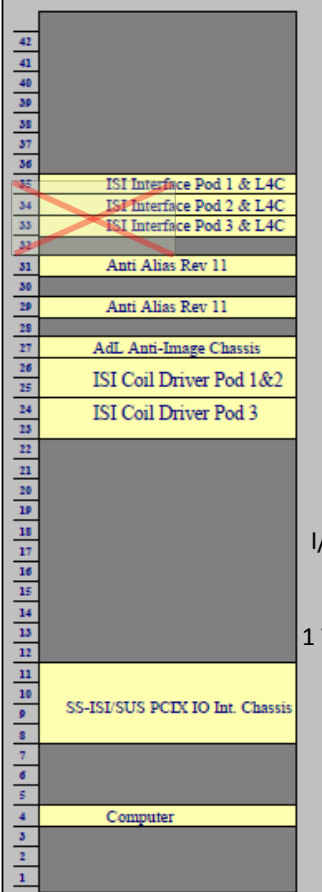

3 AA Chassis
3 AA Chassis
I/O Extension
2 ADC
1 DAC
1 Timing Slave
Computer

5-10M +15V
5-10M -15V

D1001412

LIGO-G1001032-V11

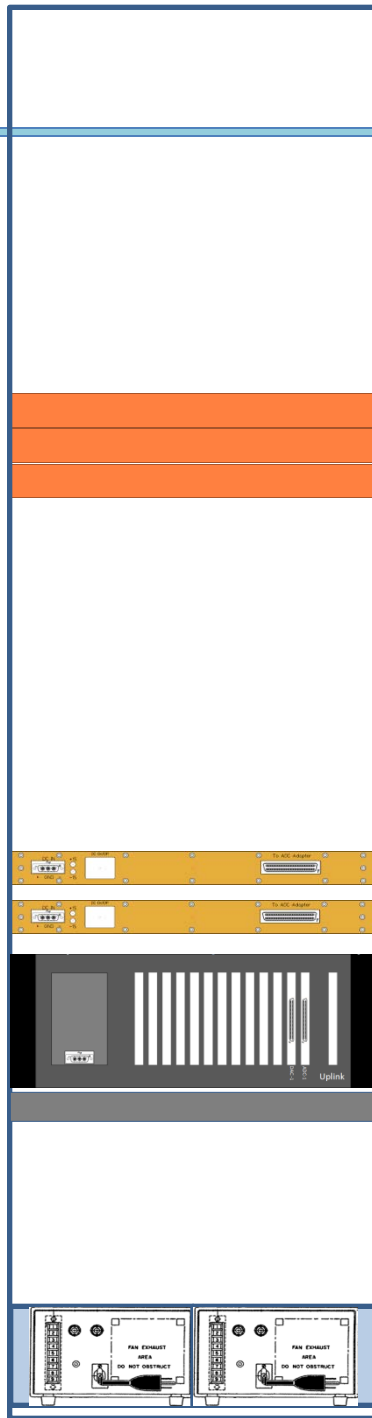
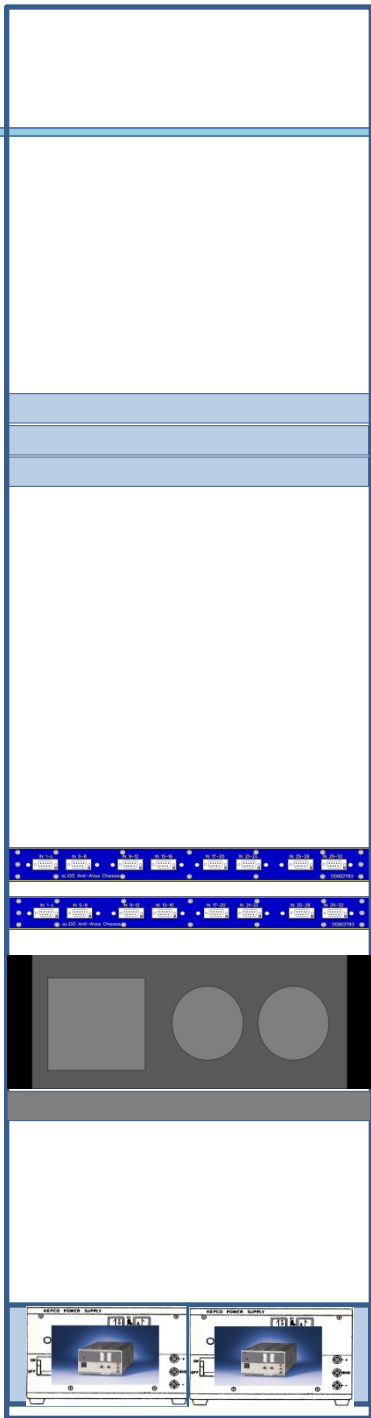

DXXXXXXXX SYYYYYYYY
DXXXXXXXX SYYYYYYYY
DXXXXXXXX SYYYYYYYY

D0902783 SYYYYYYYY
D0902783 SYYYYYYYY

SN:

SN:
SN:

DC Bus Distribution Box

Linksys BEFSX41
Firewall Router

Netgear GS108
Gigabit Switch

iMAC Computer

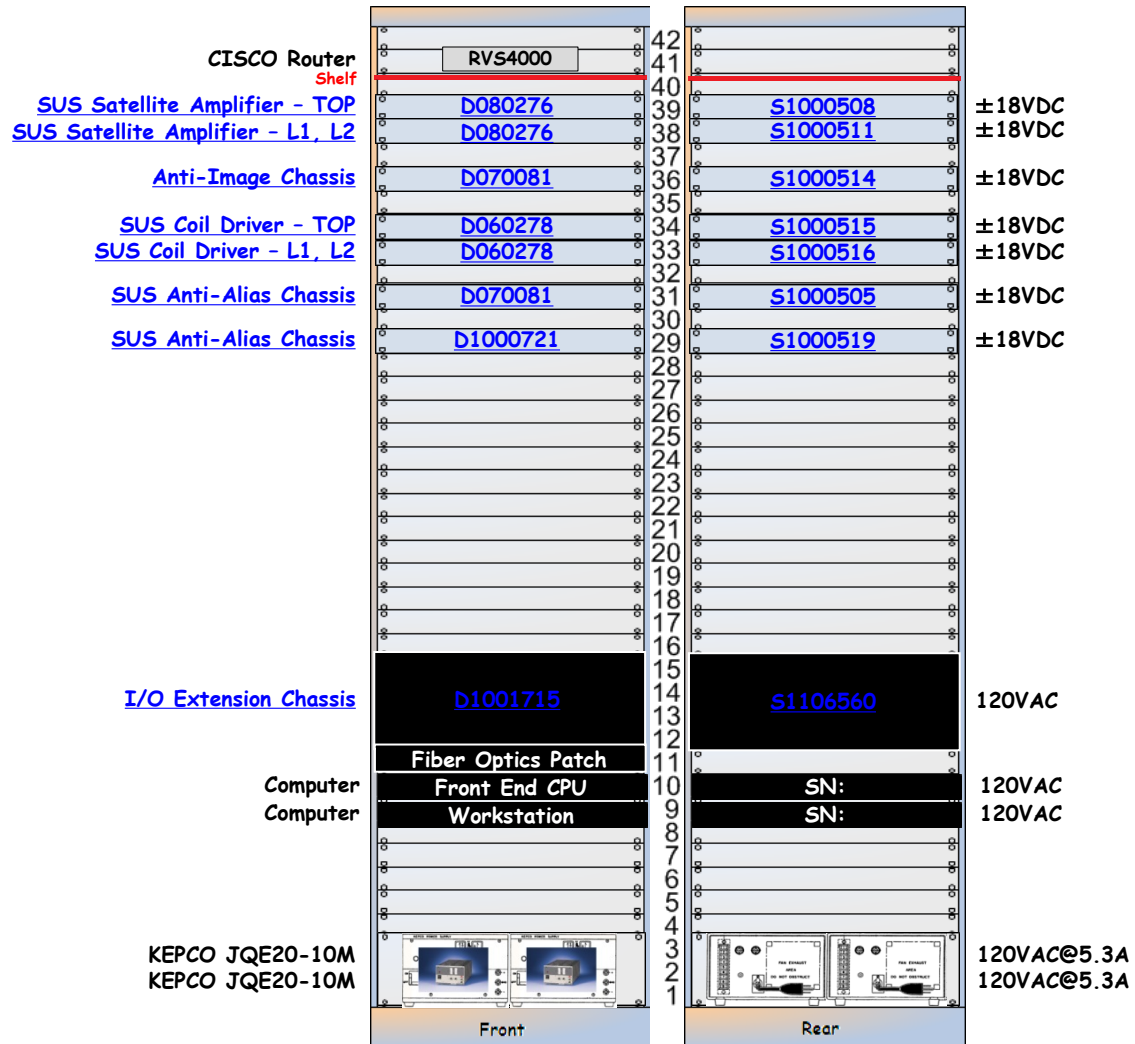

D070124 Rack Input Power Box (RU 34-36)

0 - ADC0
1 - DAC0
2 - ADC1

UM (Top)

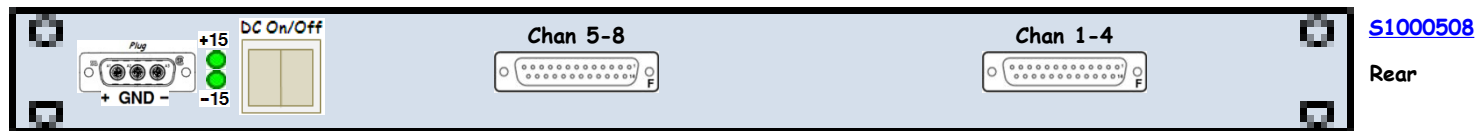
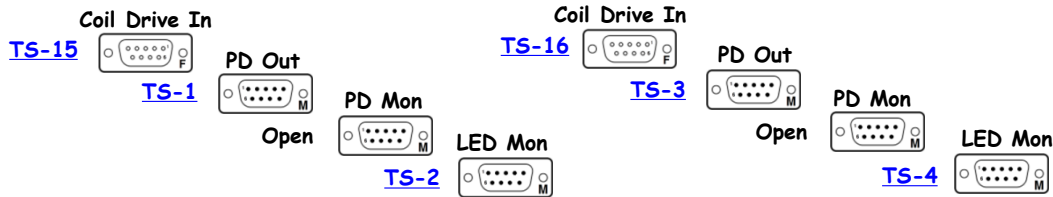

IM (L1), BM (L2)

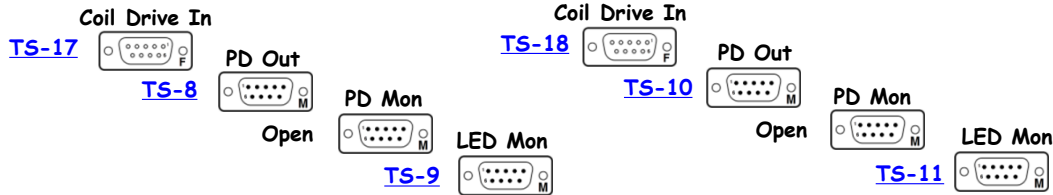

Anti-Image Chassis D070081 S1000514 ±18VDC

UNBUFFERED

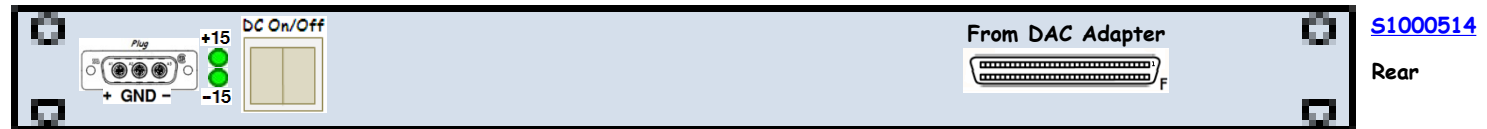

UM (Top)

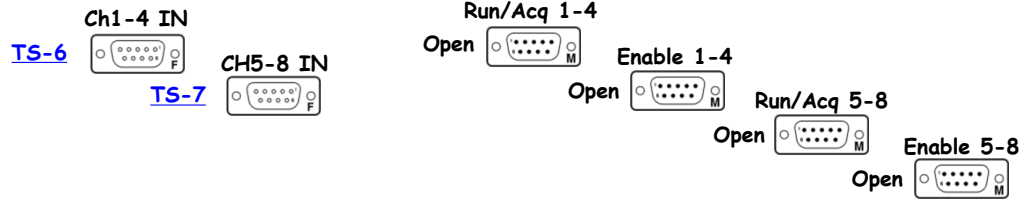
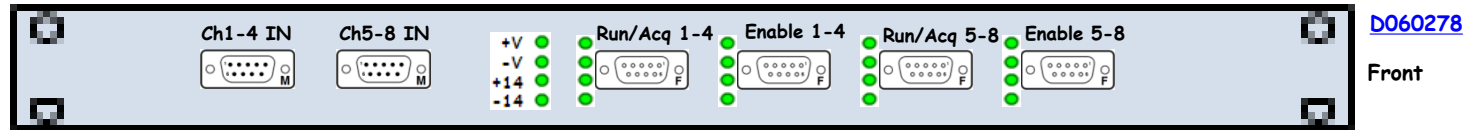

IM (L1), BM (L2)

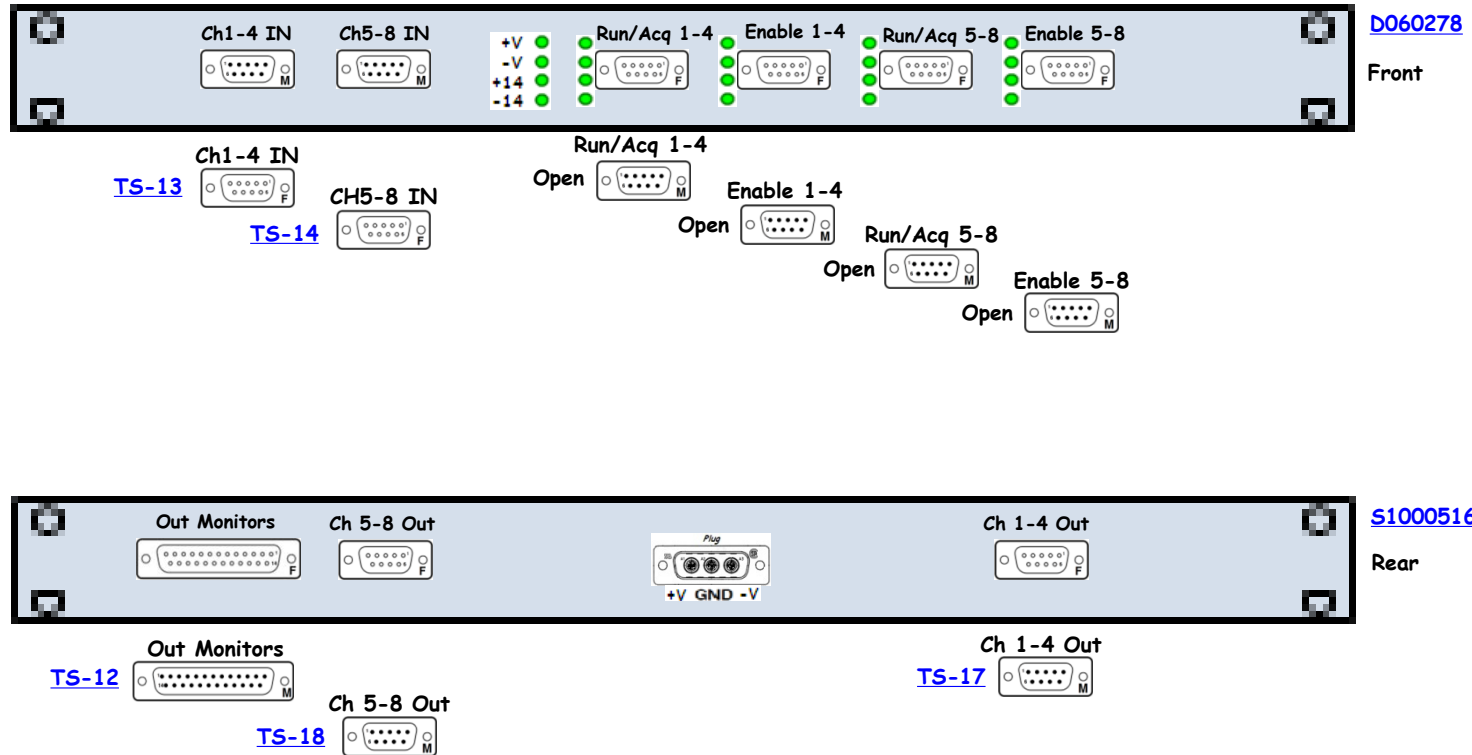

<< L1-ETR-07

SUS Anti-Alias Chassis D070081 S1000505 ±18VDC

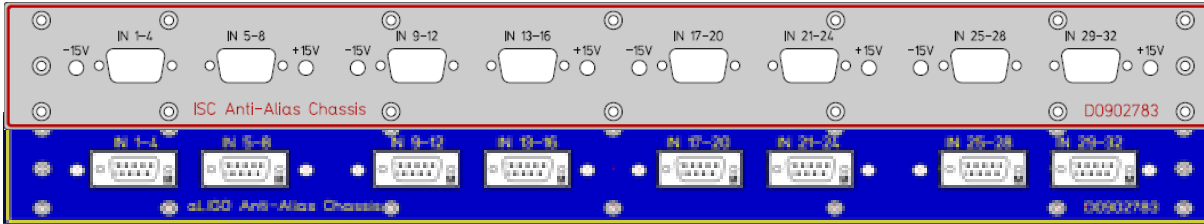

D0902783

Front

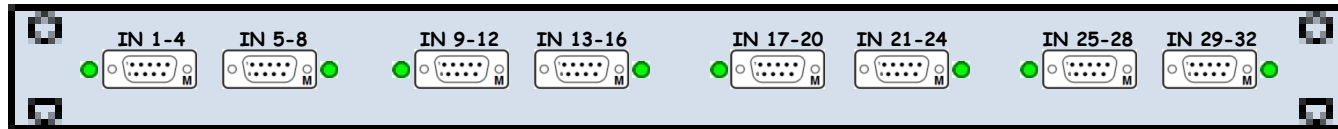

D070081

Front

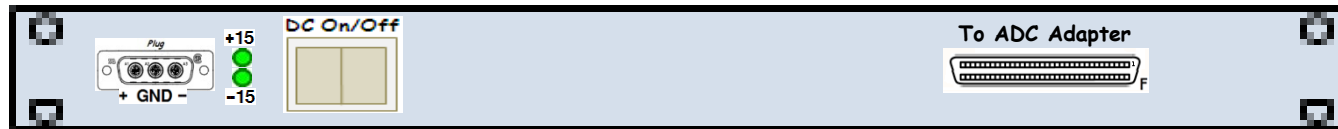
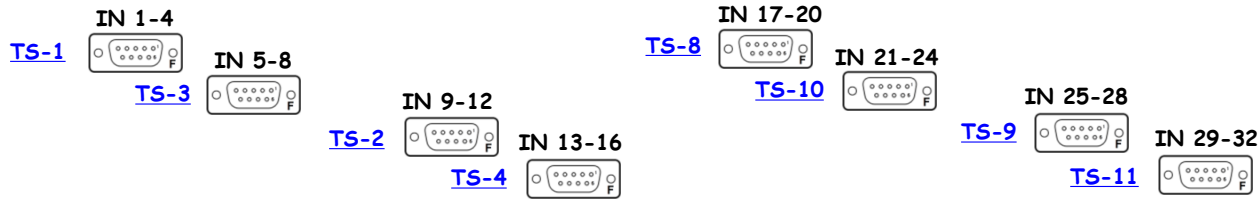

S1000505

Rear

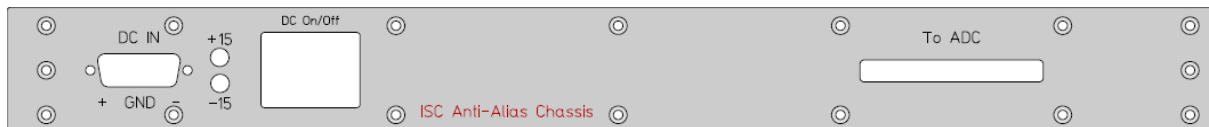
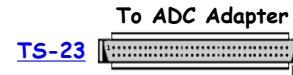

SUS Anti-Alias Chassis D1000721 S1000519 ±18VDC

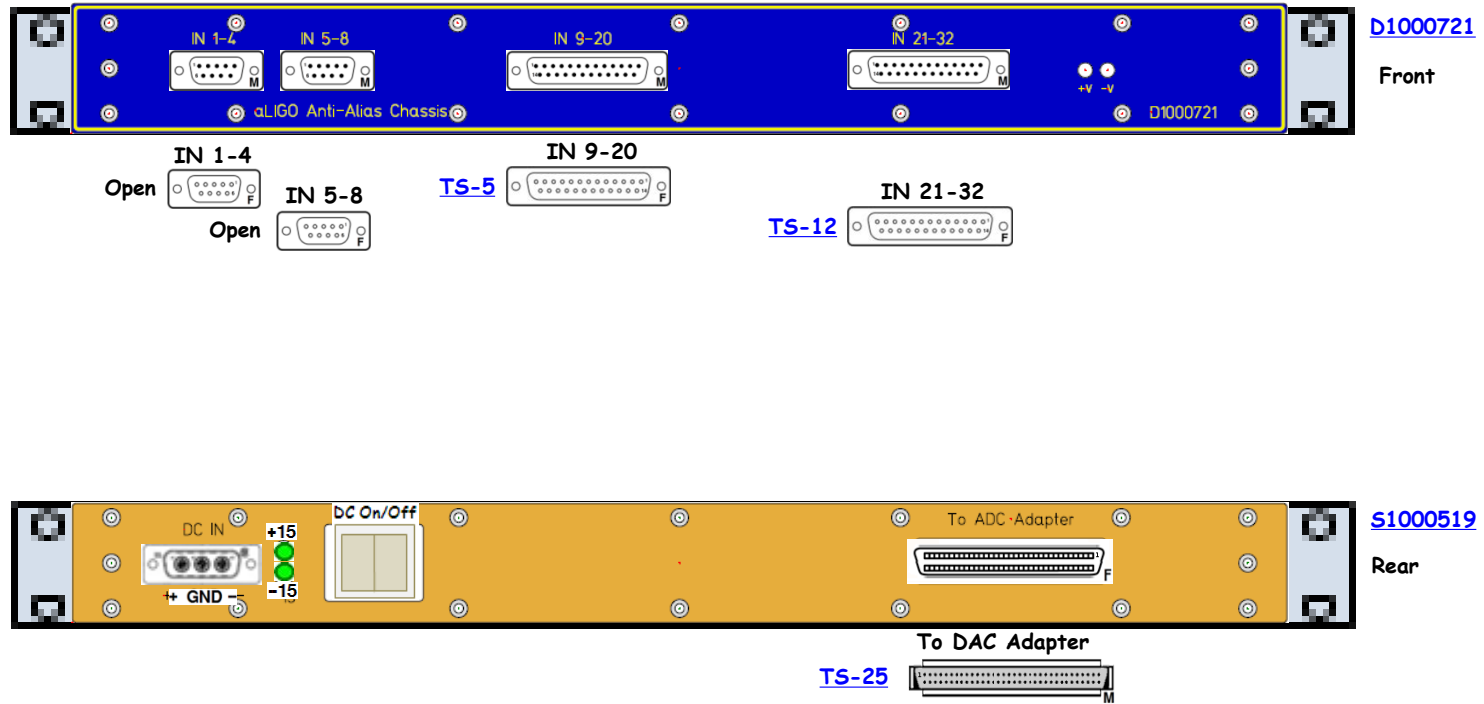



D1001715

Front

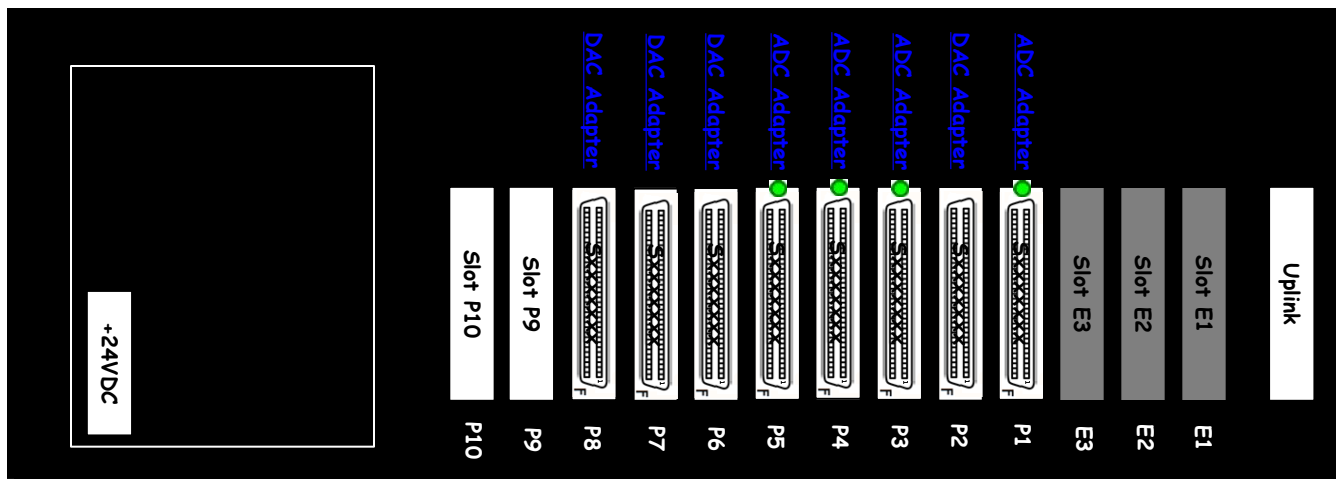

S1106560

Rear

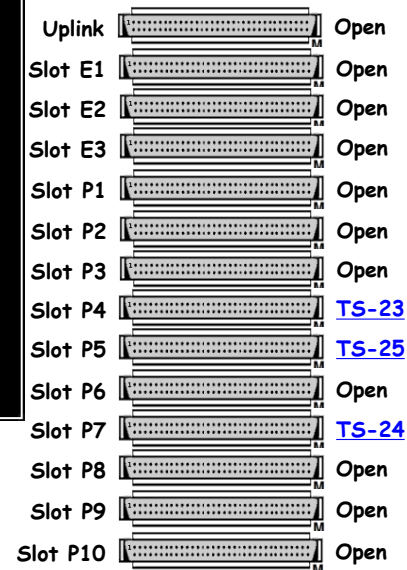

Templates

D070124 Rack Input
Power Box (RU 34-36)

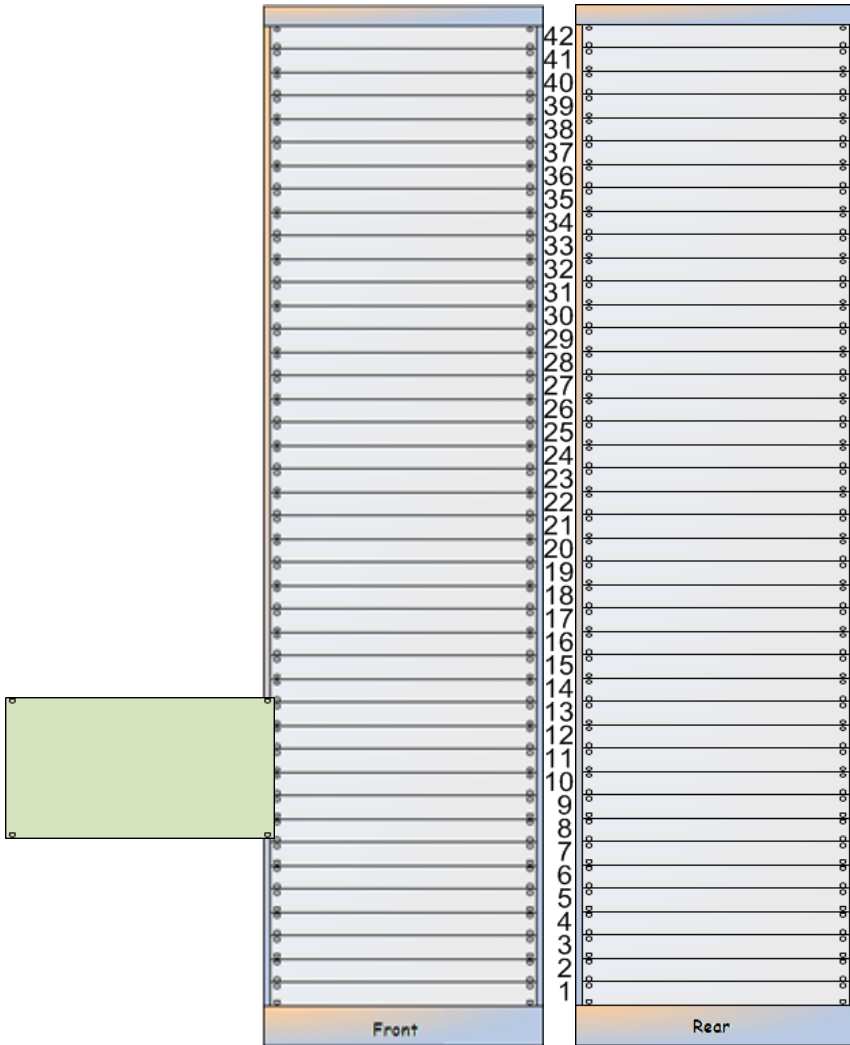
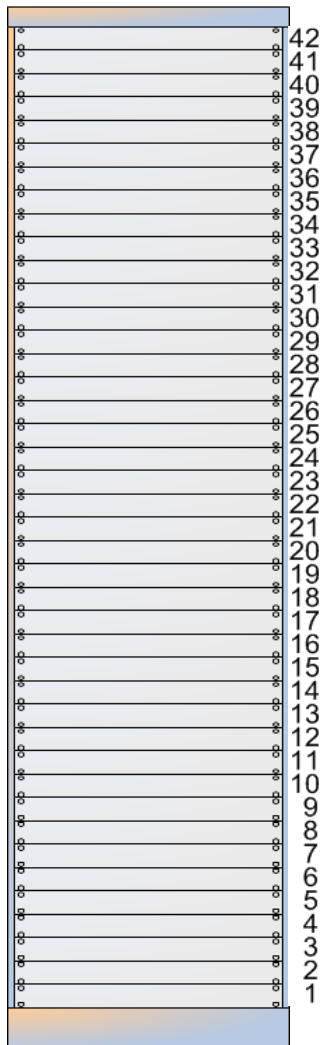
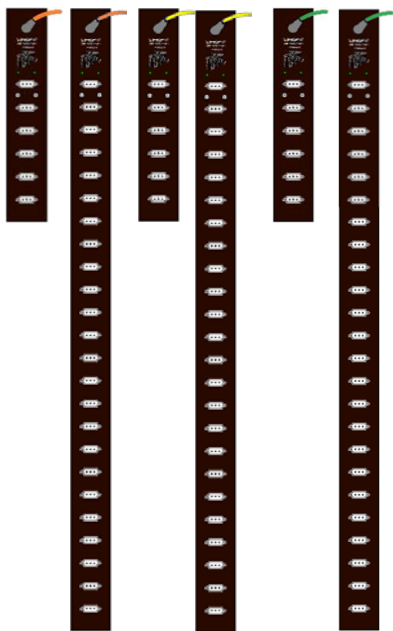

Description **Dxxxxxxx** **SN:** Power

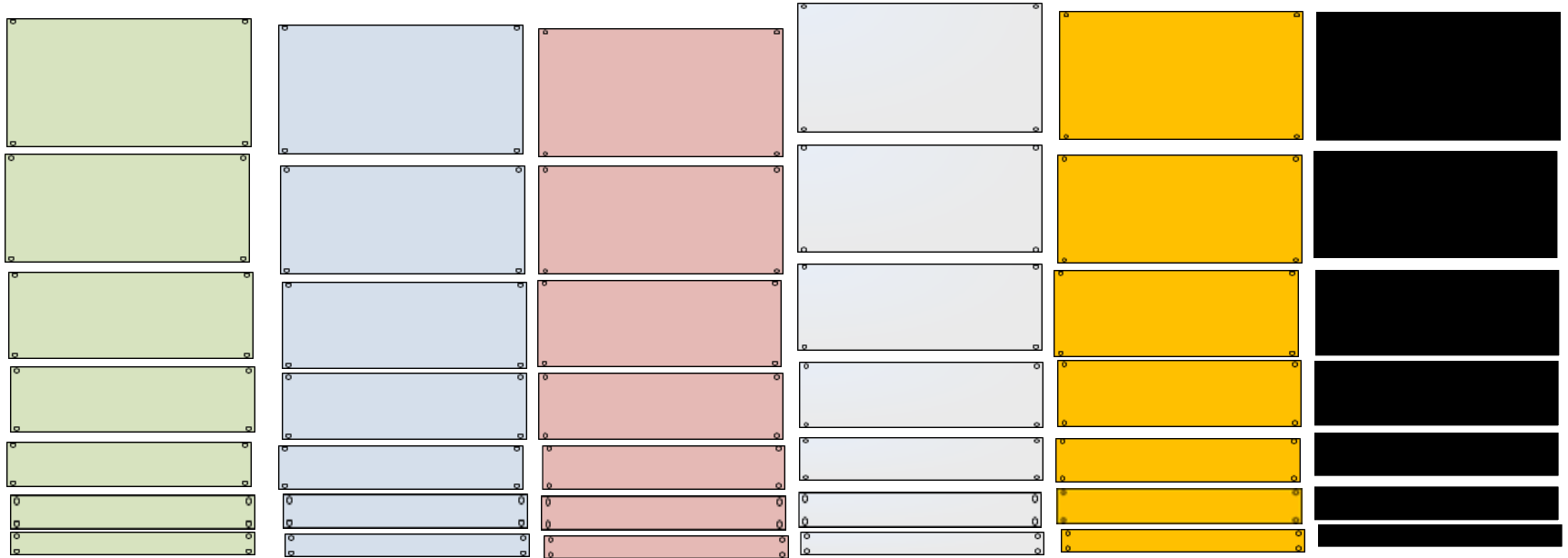

Description **Dxxxxxxx** **SN:** Power

Description Power

Description Power

Description Power

Description Power

Description Power

Description Power

Description Power

Description **Dxxxxxxx** **SN:** Power

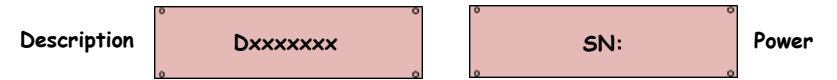
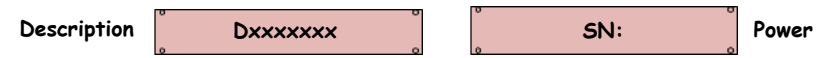
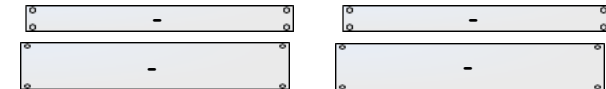

Shelf

DE-9

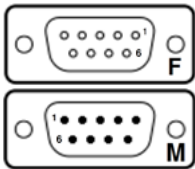

DA-15

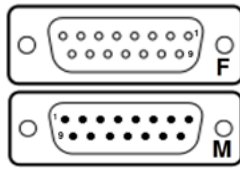

DB-25

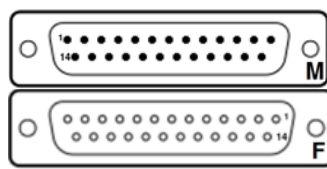

DC-37

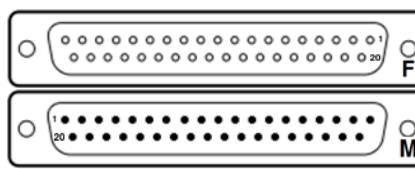

DD-50

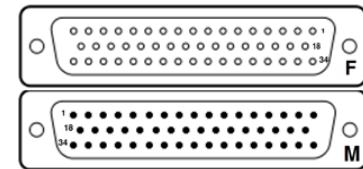

CP-4

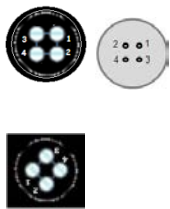

LEMO 2-Pin

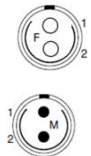

LEMO 4-Pin

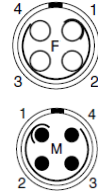

Conec

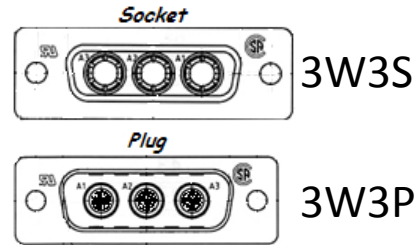

SCSI-68

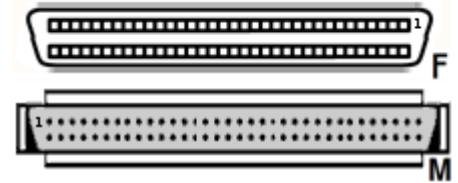

BNC

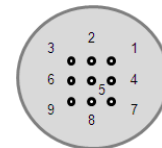

Conec

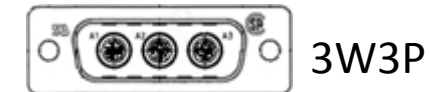
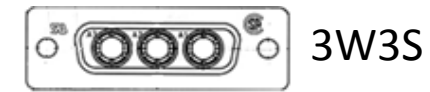
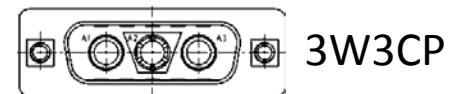
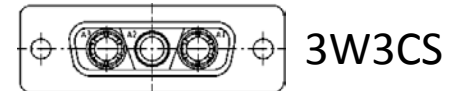
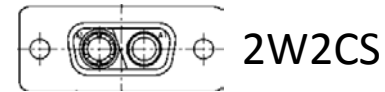
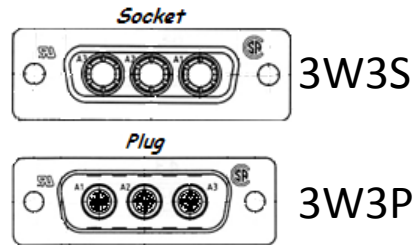

CP-4

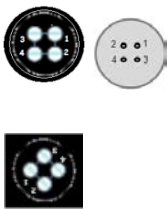

LEMO 2-Pin



LEMO 1-Pin



LEMO 4-Pin



+V -V Layouts



Slot E3

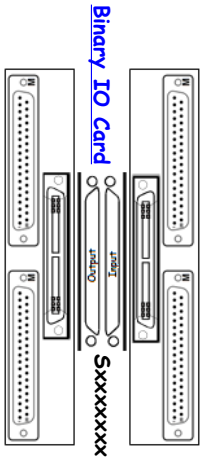

DAC16 Card



Slot P3

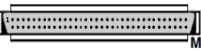

Open

Binary IO Card



Slot E3

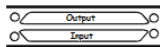

Open

ADC Card

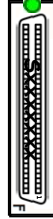

DAC18 Card



Slot P3

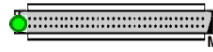

Open

Slot P3



Open

Binary IO Card

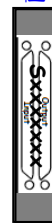

ADC Card

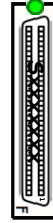

DAC16 Card

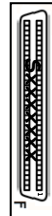

DAC18 Card

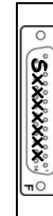

+V -V Layouts

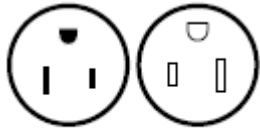

125 VAC, 15 Amps

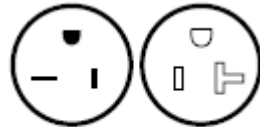

125 VAC, 20 Amps

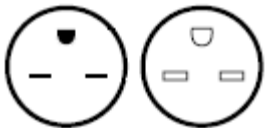

250 VAC, 15 Amps

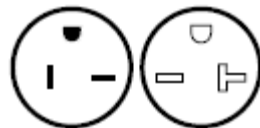

250 VAC, 20 Amps



L6-30R L6-30P

VOLTAGE	NEMA	15 AMPERE		20 AMPERE		30 AMPERE		50 AMPERE		60 AMPERE	
		Receptacle	Plug	Receptacle	Plug	Receptacle	Plug	Receptacle	Plug	Receptacle	Plug
125 V	1	1-15R	1-15P								
250V	2		2-15P	2-20R	2-20P	2-30R	2-30P				
125V	5	5-15R	5-15P	5-20R	5-20P	5-30R	5-30P	5-50R	5-50P		
250V	6	6-15R	6-15P	6-20R	6-20P	6-30R	6-30P	6-50R	6-50P		
277V, A.C.	7	7-15R	7-15P	7-20R	7-20P	7-30R	7-30P	7-50R	7-50P		
125/ 250V	10			10-20R	10-20P	10-30R	10-30P	10-50R	10-50P		
3Ø 250V	11	11-15R	11-15P	11-20R	11-20P	11-30R	11-30P	11-50R	11-50P		
125/ 250V	14	14-15R	14-15P	14-20R	14-20P	14-30R	14-30P	14-50R	14-50P	14-60R	14-60P
3Ø 250V	15	15-15R	15-15P	15-20R	15-20P	15-30R	15-30P	15-50R	15-50P	15-60R	15-60P
3ØY 120/208V	18	18-15R	18-15P	18-20R	18-20P	18-30R	18-30P	18-50R	18-50P	18-60R	18-60P

24VAC Power
To Camera

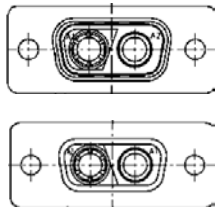

A1 = Black
A2 = White(Y) Red(X)

24VAC



Transformer

110VAC

Signals To
Camera

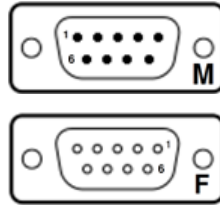

- 1 =
- 2 =
- 3 =
- 4 =
- 5 =
- 6 =
- 7 =
- 8 =
- 9 =



75 Ohm Signal
from Camera

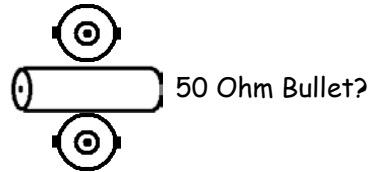

Type N



BNC



TNC

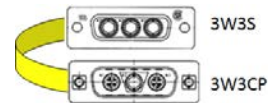

SMA

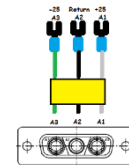

Interface

12VDC



Fiber Optics Connector Types



FC Ferrule Connector or Fiber Channel



ST / BFOC Straight Tip / Bayonet Fiber Optic Connector



LC Lucent Connector, or Little Connector, or Local Connector

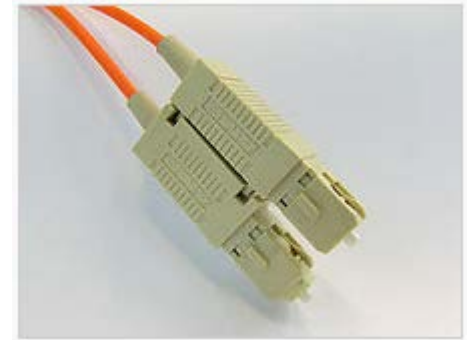

SC Subscriber Connector or square connector or Standard Connector

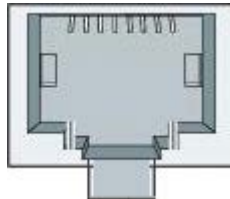
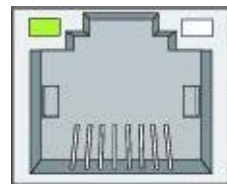

How Rack Documents Relate

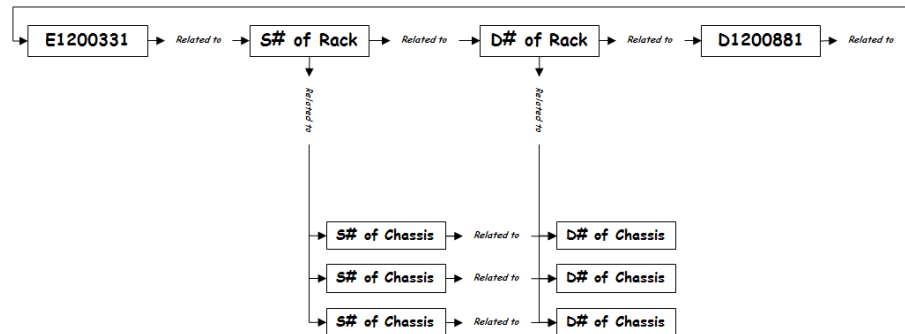
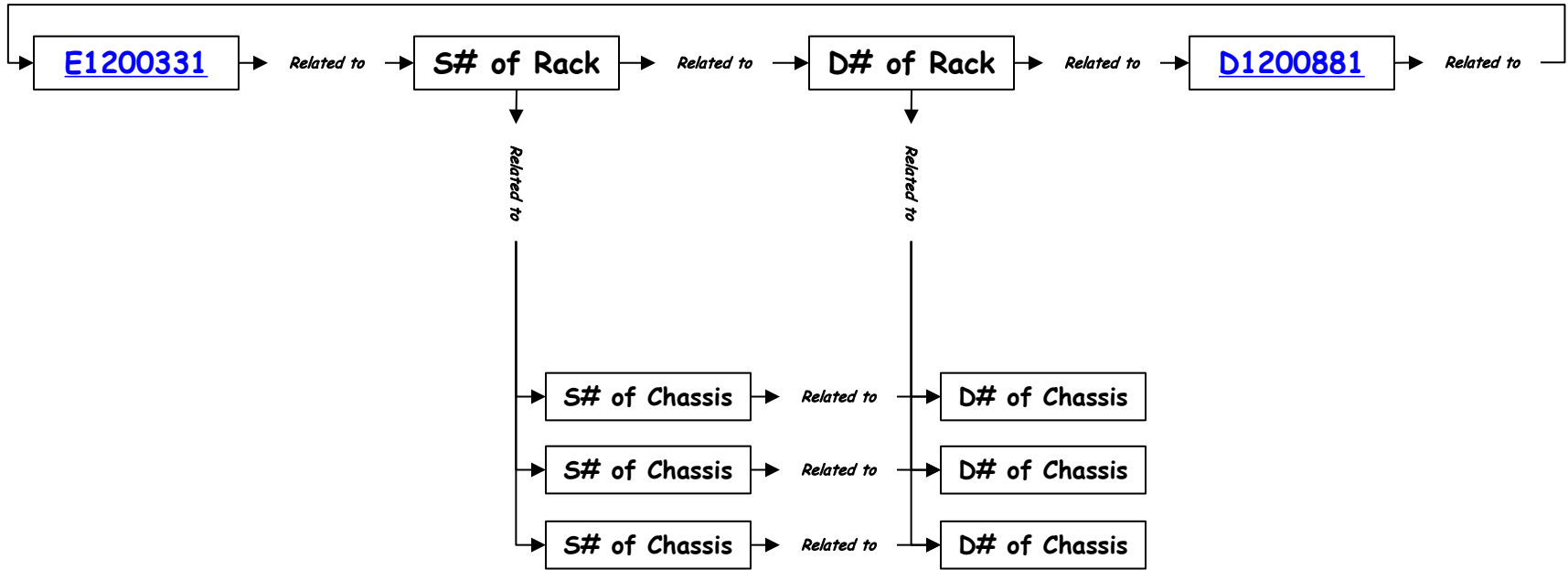

D1100619 - End Link

Beckhoff Slow Controls
End Link

D1100619

SN:

+24VDC

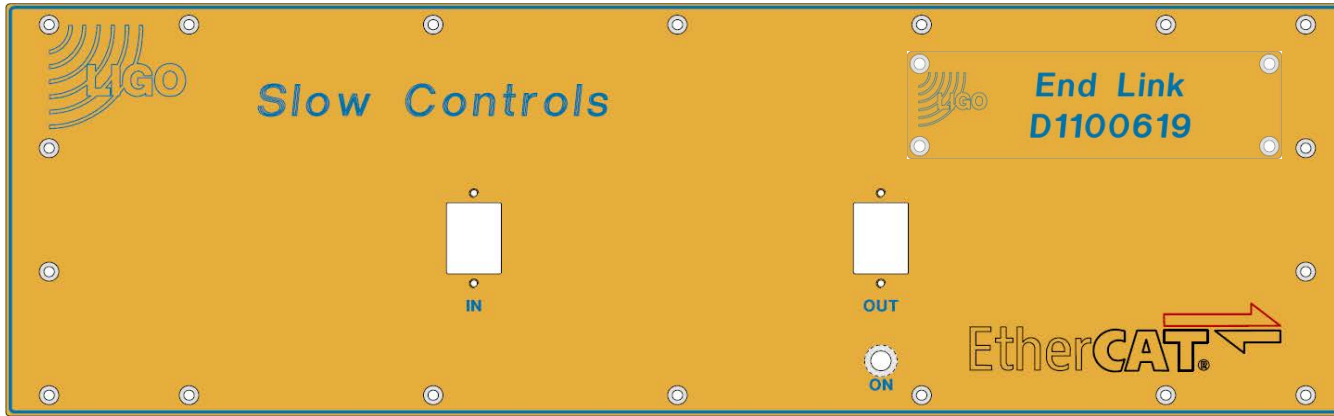

[D1100619](#)

[Front: D0902553](#)

[Name: D1200133](#)

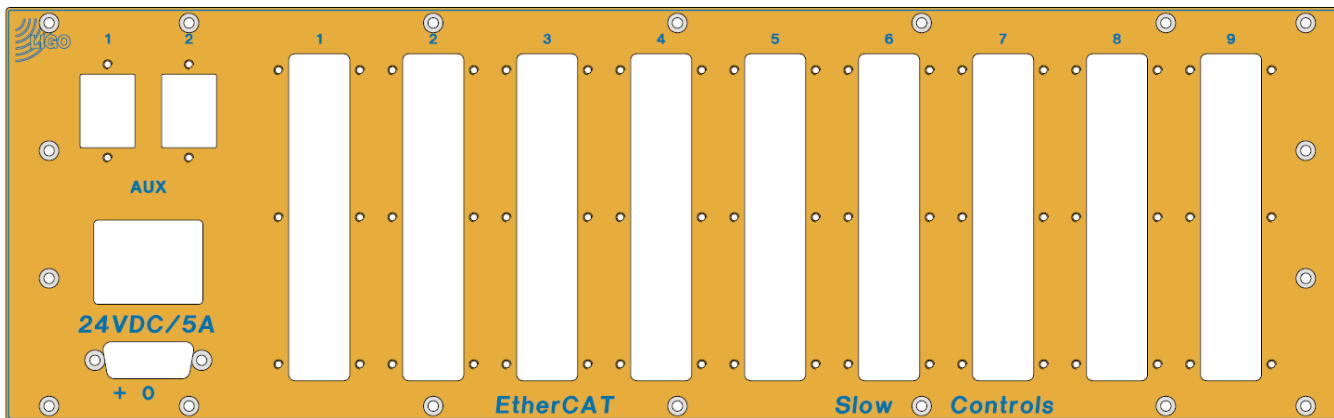

[S1000519](#)

[Rear: D0902554](#)

D1100682 - End Station 2

Beckhoff Slow Controls
End Station 2

D1100682

SN:

+24VDC

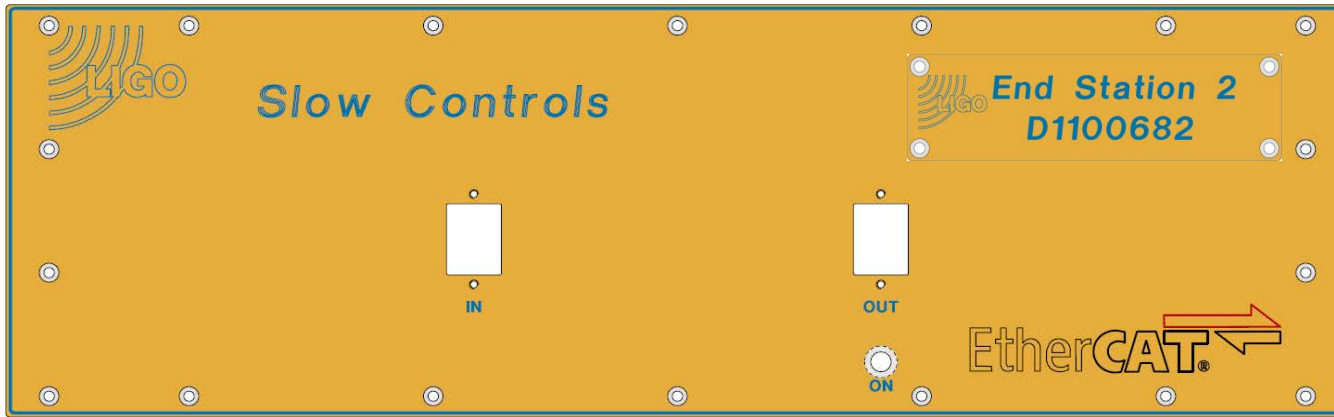

D1100682

Front: D0902553

Name: D1101978

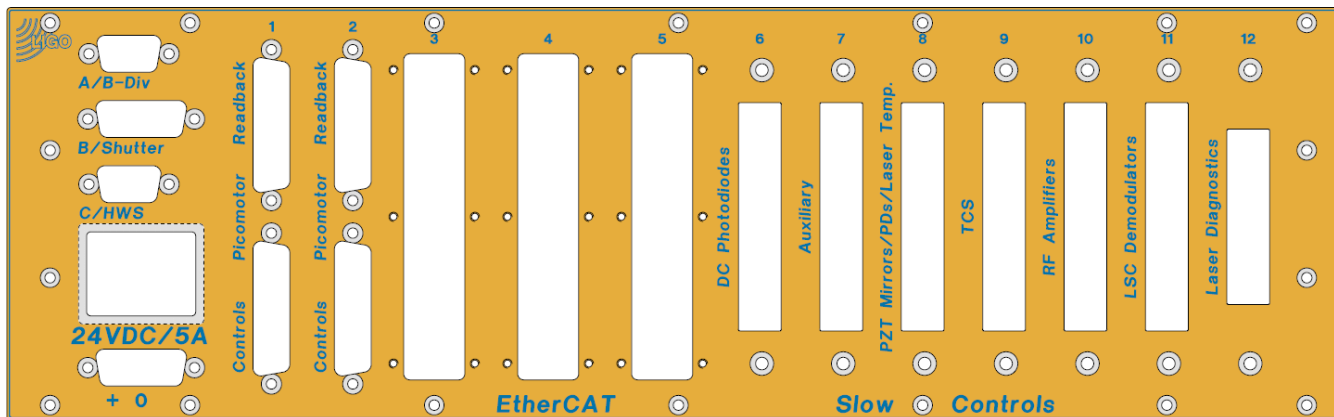

S1000519

Rear: D1101977

D1100680 - Corner 2

Beckhoff Slow Controls
Corner 2

D1100680

SN:

+24VDC

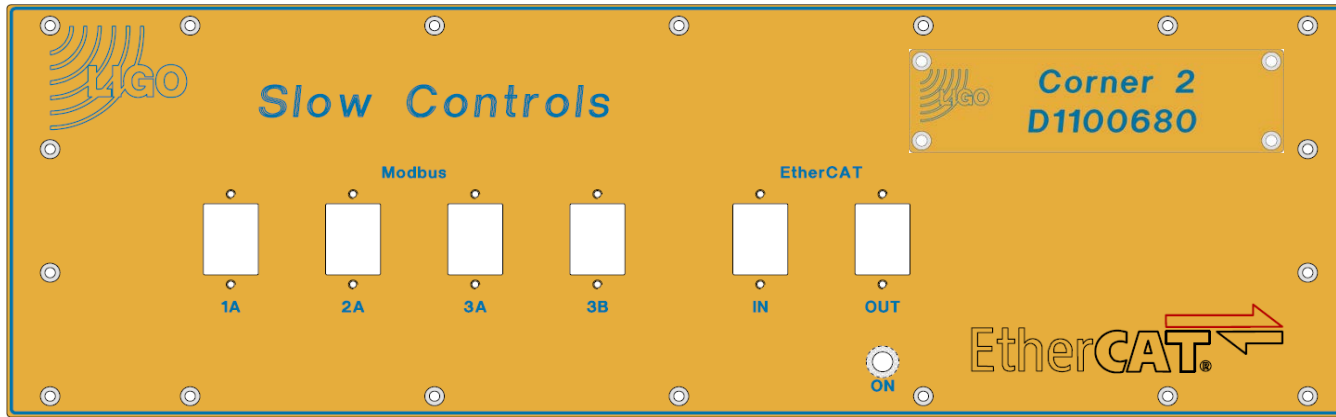

D1100680

Front: D1102322

Name: D1102269

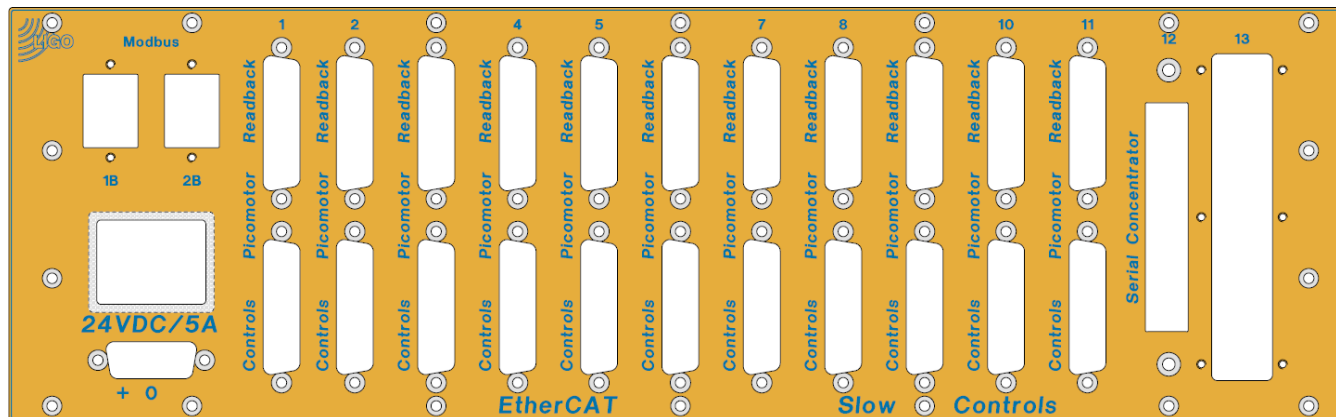

S1000519

Rear: D1102268

D1100681 - Corner 3

Beckhoff Slow Controls
Corner 3

D1100681

SN:

+24VDC

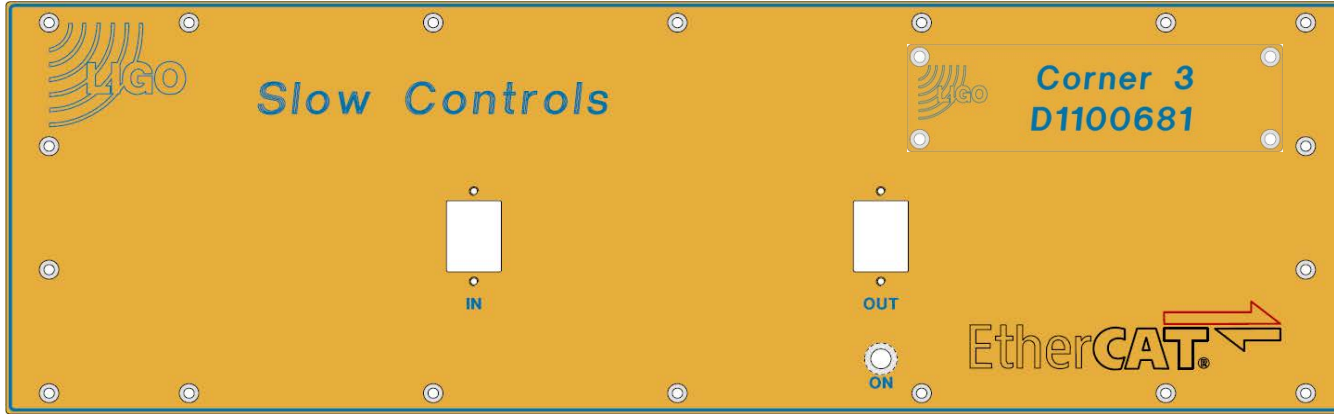

D1100681

Front: D0902553

Name: D1102434

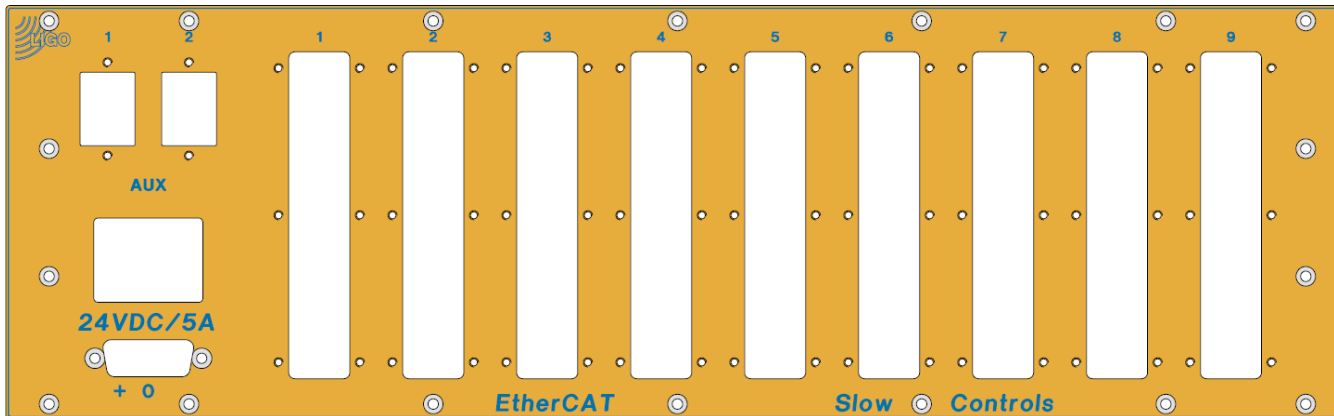

SN:

Rear: D0902554

D1101266 - Corner 4

Beckhoff Slow Controls
Corner 4

D1101266

SN:

+24VDC

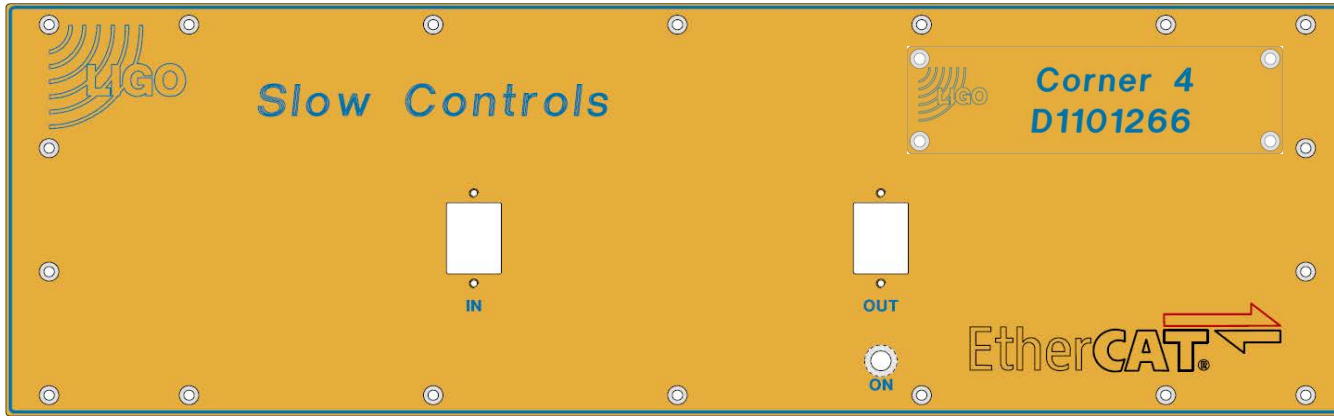

D1101266

Front: D0902553

Name: D1102435

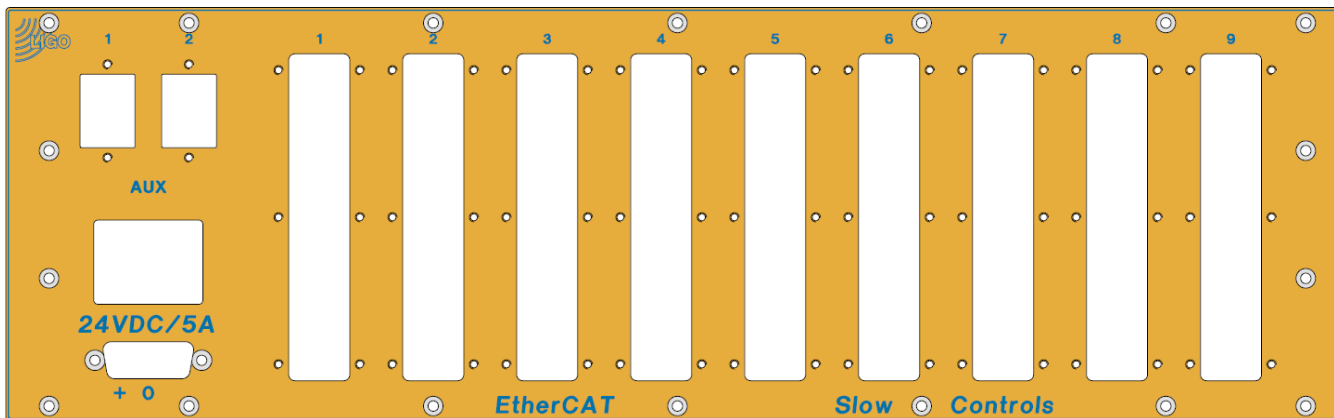

SN:

Rear: D0902554

D1200132 - Corner 5

Beckhoff Slow Controls
Corner 5

D1200132

SN:

+24VDC

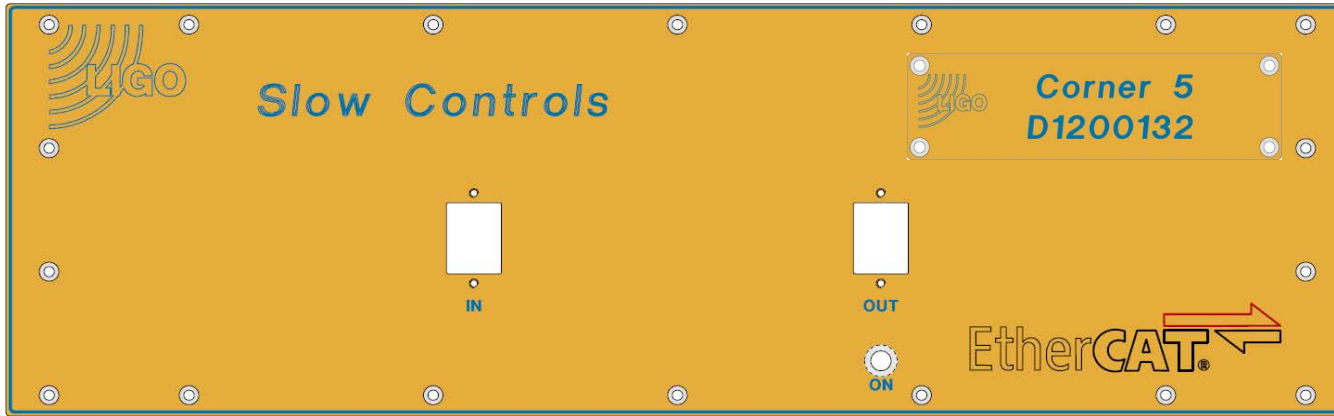

D1200132

Front: D0902553

Name: D1200133

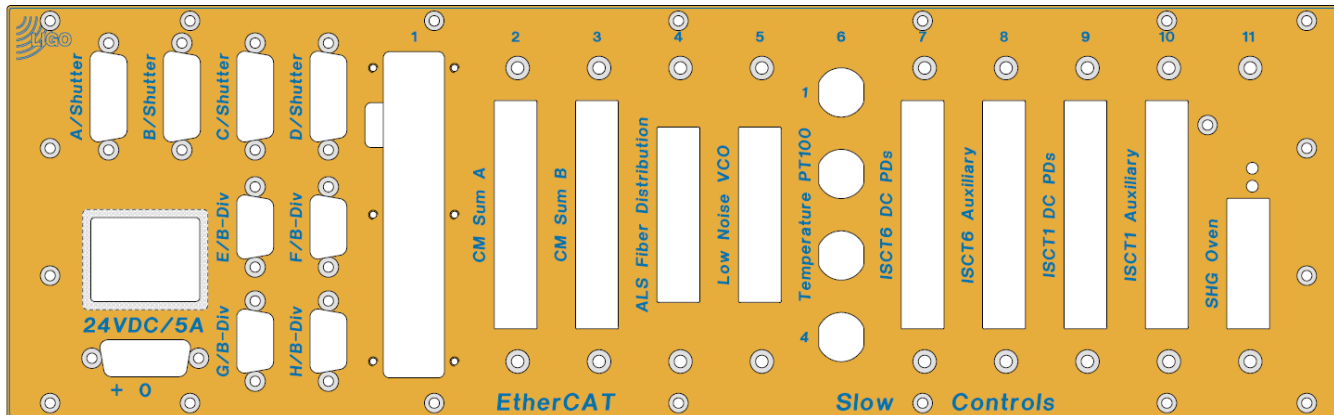

S1000519

Rear: D1201340

D1100618 - Corner MSR

Beckhoff Slow Controls
Corner MSR

D1100618

SN:

+24VDC

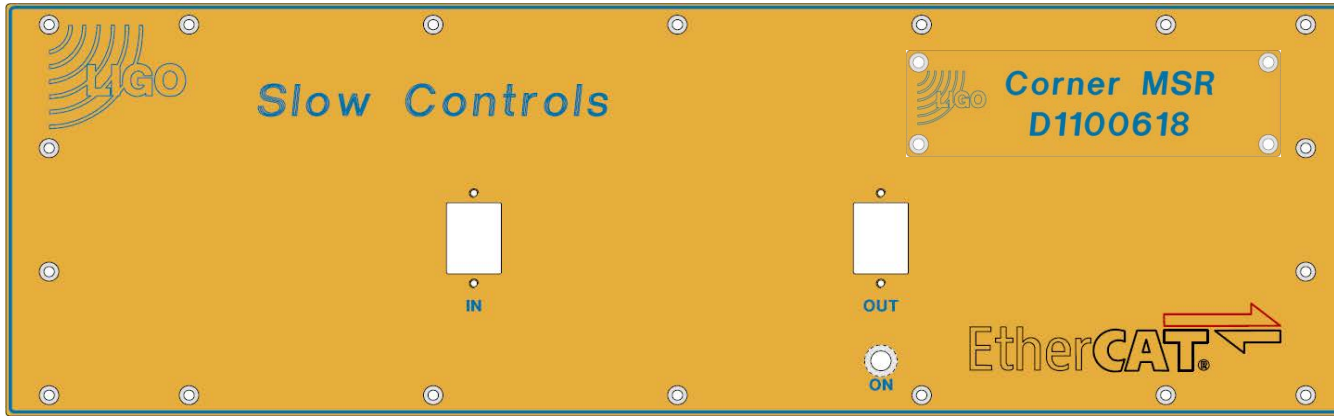

D1100618

Front: D0902553

Name: D1100666

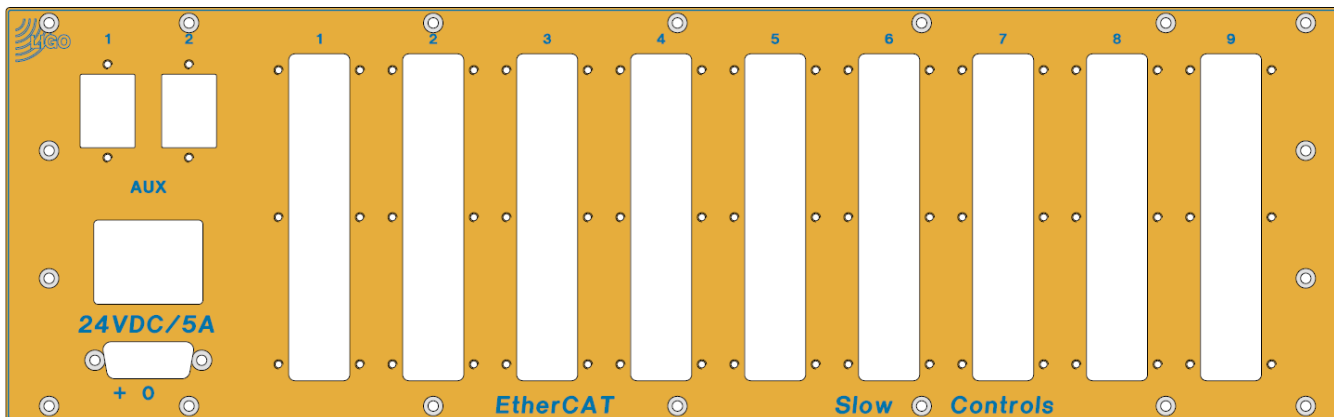

SN:

Rear: D0902554

D1002961 - ISC Common

Beckhoff Slow Controls
ISC Common

D1002961

SN:

+24VDC

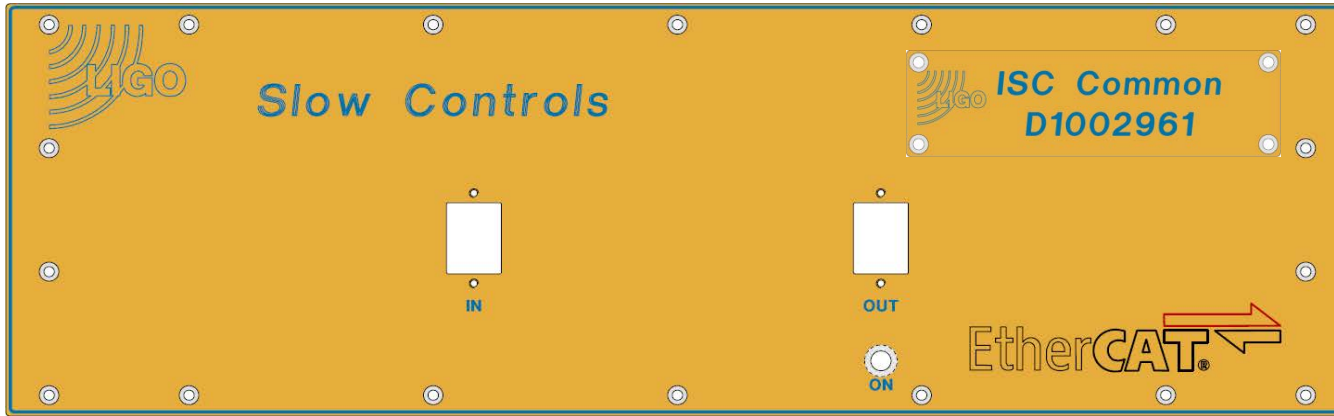

D1002961

Front: D0902553

Name: D1002962

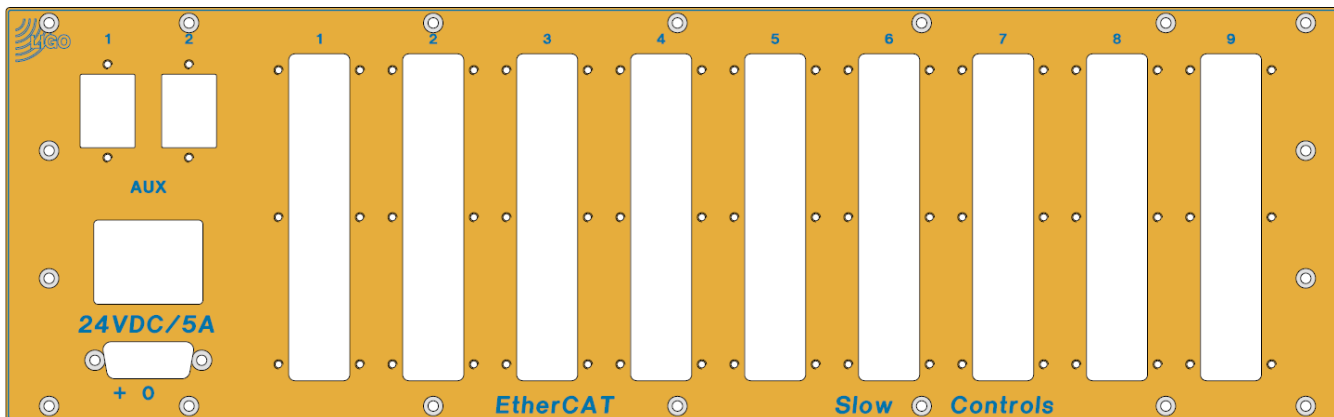

SN:

Rear: D0902554

D0902552 - Empty

Beckhoff Slow Controls
Empty

D0902552

SN:

+24VDC

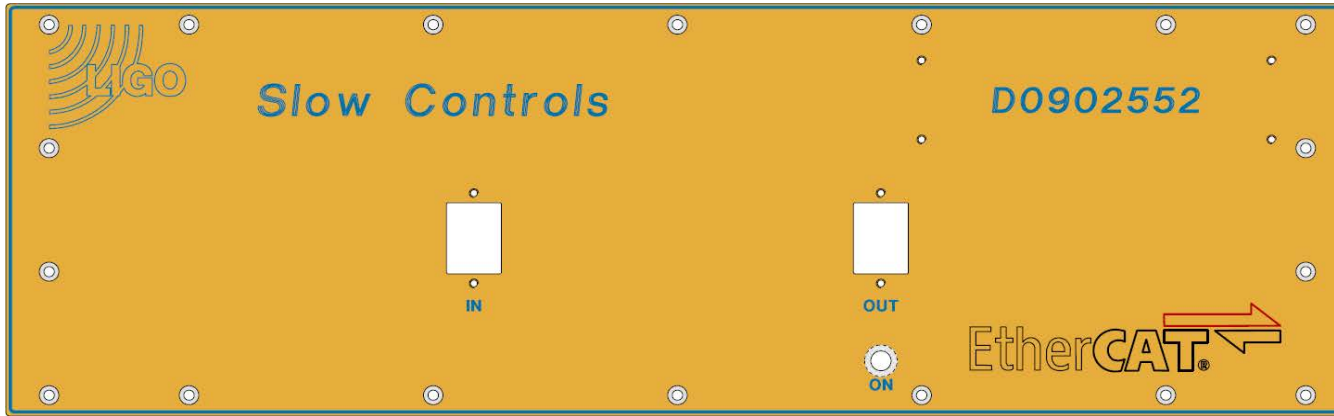

[D0902552](#)

Front: [D0902553](#)

Name: None

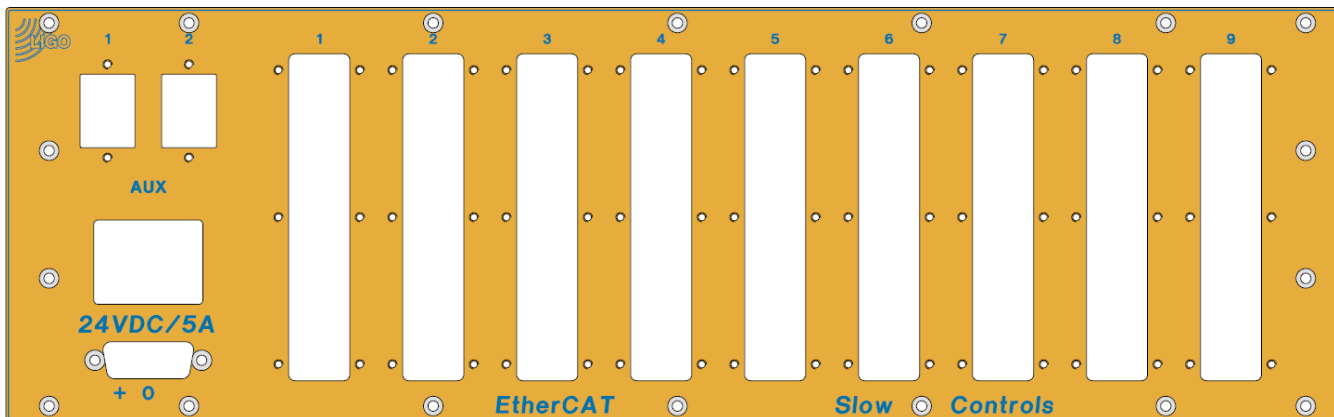

SN:

Rear: [D0902554](#)