

This document provides details about the LLO electronics racks. It may be examined through four separate but interconnected methods: racks may be found searching MAPS of the observatory, or for AREAS in which they reside, or by searching SUBSYSTEMS that they service., or through the DocDB references to their D-numbers or S-numbers.

[Search by LOCATION](#)

[Search by AREA](#)

[Search by SUBSYSTEM](#)

[Search by DocDB](#)

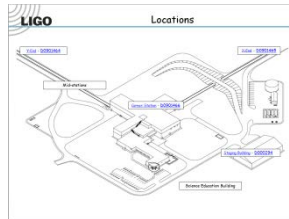

Operator Control Room (OSR)	CD-8 Electronics Room (ES8)	LVEA Racks (LVEA)	Electronics Test Rack (ETR)
Mass Storage Room (MSR)	Laser Diode Room (LDR)	X-End Racks (X-ER)	Other Areas (Other)
Computer User Room (CUR)	ZD-8 Power Room (ZSR)	Y-End Racks (Y-ER)	

Auxiliary Optics CER (LVEA, LVEB) LVEA (LVEA, LVEB) CERX (LVEA, LVEB) VEAX (LVEA, LVEB) CERY (LVEA, LVEB) VEAY (LVEA, LVEB)	Pre-stabilized Laser CER (LVEA) LVEA (LVEA) CERX (LVEA) VEAX (LVEA) CERY (LVEA) VEAY (LVEA)	Vacuum CER (VAC) LVEA (VAC) CERX (VAC) VEAX (VAC) CERY (VAC) VEAY (VAC)
Interferometer Sensing and Control CER (LSC) LVEA (LSC) CERX (LSC) VEAX (LSC) CERY (LSC) VEAY (LSC)	Seismic Isolation CER (SEI) LVEA (SEI) CERX (SEI) VEAX (SEI) CERY (SEI) VEAY (SEI)	DC Power CER (LDC) LVEA (LDC) CERX (LDC) VEAX (LDC) CERY (LDC) VEAY (LDC)
Data Acquisition CER (DAQ, FER, DAF) LVEA (DAQ, FER, DAF) CERX (DAQ, FER, DAF) VEAX (DAQ, FER, DAF) CERY (DAQ, FER, DAF) VEAY (DAQ, FER, DAF)	Suspension CER (SUS) LVEA (SUS) CERX (SUS) VEAX (SUS) CERY (SUS) VEAY (SUS)	Facilities CER (FAC) LVEA (FAC) CERX (FAC) VEAX (FAC) CERY (FAC) VEAY (FAC)

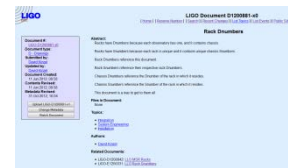

[<< Start](#)

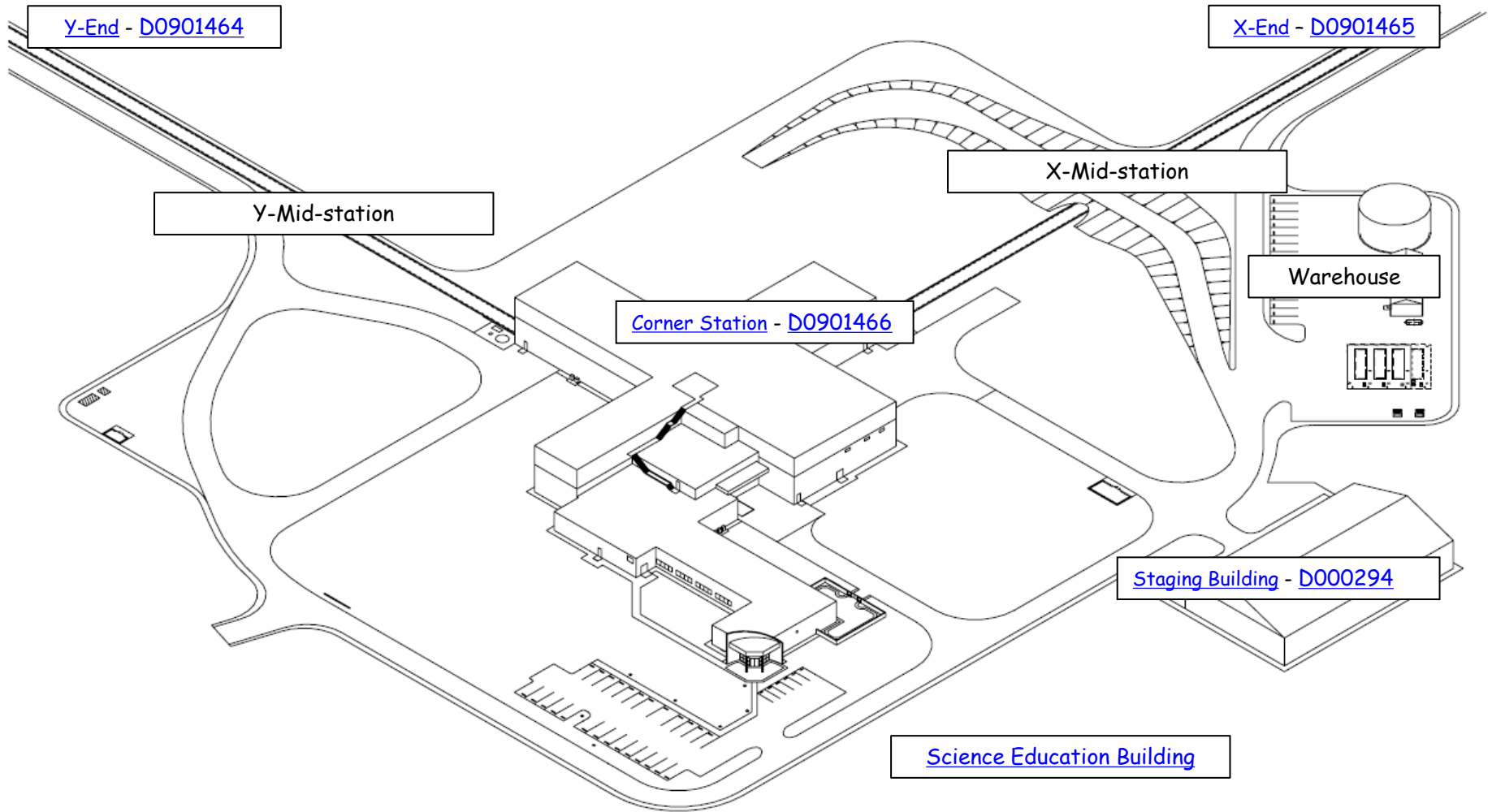

Corner Station - D0901490

<< [Locations](#)

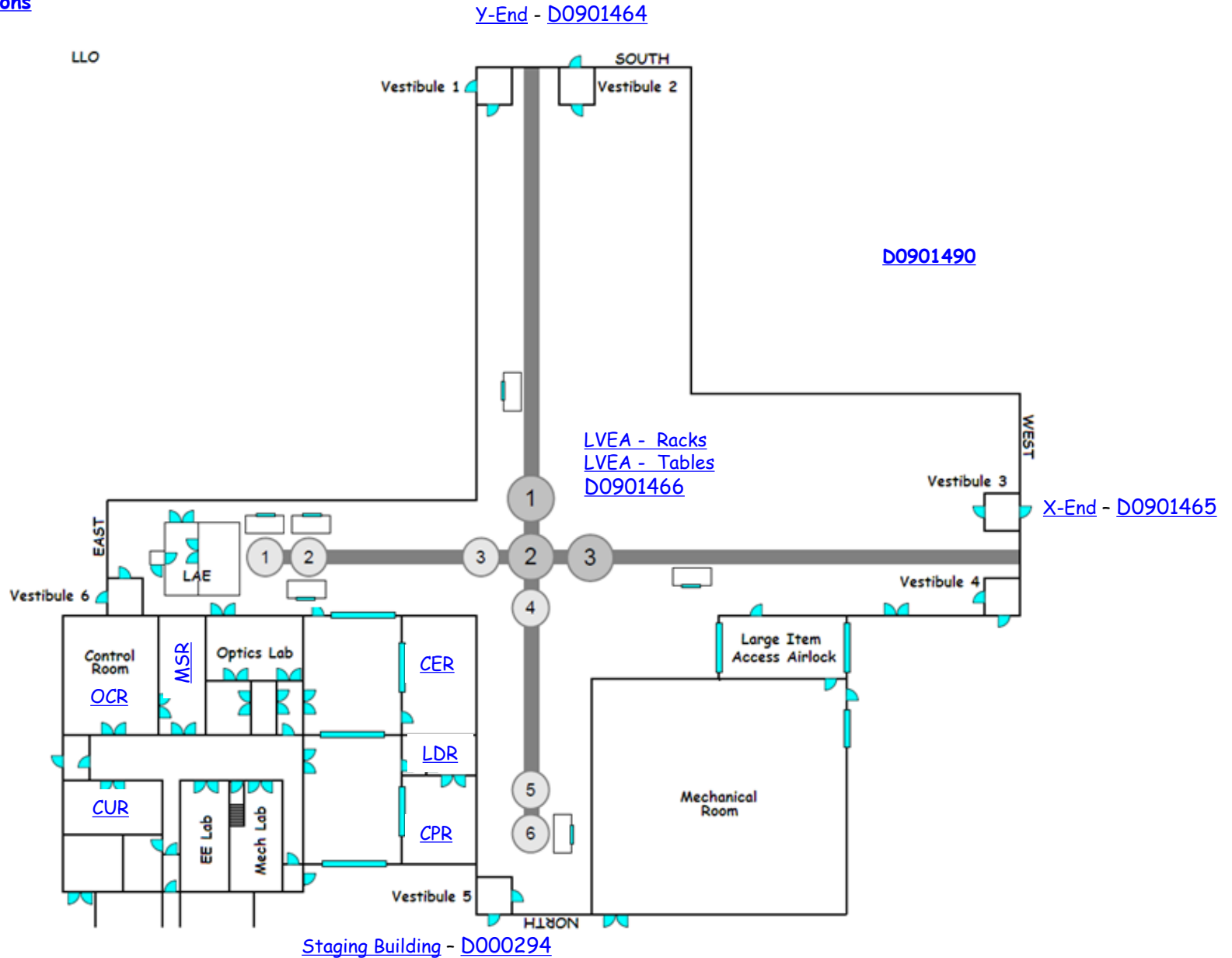

LLO electronics racks are installed in a variety of *LOCATIONS*. Generally speaking, each location houses a specific type of rack. Front-end computers are housed in the [MSR](#). Electronics racks with IO chassis are housed in the [CER](#). Other electronics racks that interface to chambers are located in the [LVEA](#), [X-End](#) and [Y-End](#) areas. Power supplies are housed in the [CPR](#). And finally, test racks for electronics are spread throughout the facility, housed wherever they are required.

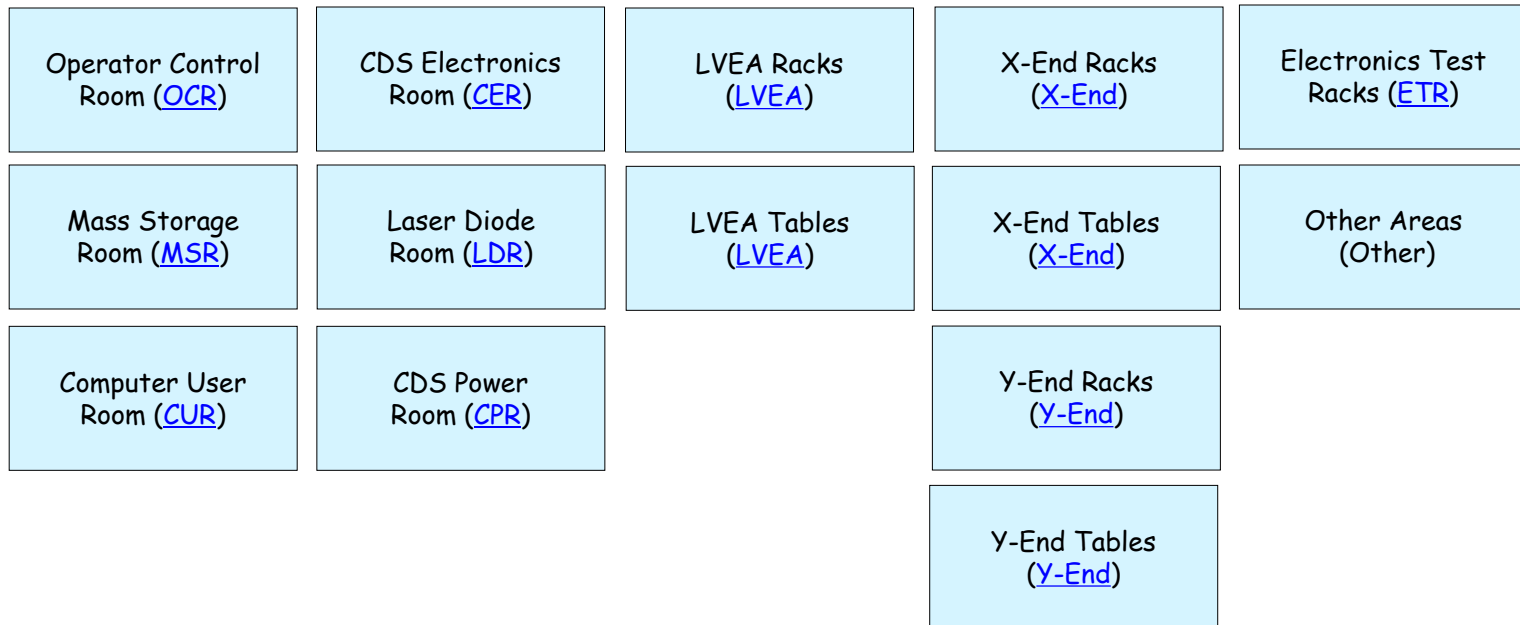

IFO Subsystems are another way to view the racks that are installed in a variety of locations. Generally speaking, each subsystem has racks that are positioned in several physical locations. The subsystems are: AOS, DAQ, ISC, PSL, SEI, SUS, VAC, and VDC. TCS is a part of AOS. PEM and OAF are part of DAQ. HEPI is part of SEI.

<p>Auxiliary Optics CER:(AOS / TCS) LVEA:(AOS / TCS) CERX:(AOS / TCS) VEAX:(AOS / TCS) CERY:(AOS / TCS) VEAY:(AOS / TCS)</p>	<p>Pre-stabilized Laser CER:(PSL) LVEA:(PSL) CERX:(PSL) VEAX:(PSL) CERY:(PSL) VEAY:(PSL)</p>	<p>Vacuum CER:(VAC) LVEA:(VAC) CERX:(VAC) VEAX:(VAC) CERY:(VAC) VEAY:(VAC)</p>
<p>Interferometer Sensing and Control CER:(ISC) LVEA:(ISC) CERX:(ISC) VEAX:(ISC) CERY:(ISC) VEAY:(ISC)</p>	<p>Seismic Isolation CER:(SEI) LVEA:(SEI) CERX:(SEI) VEAX:(SEI) CERY:(SEI) VEAY:(SEI)</p>	<p>DC Power CER:(VDC) LVEA:(VDC) CERX:(VDC) VEAX:(VDC) CERY:(VDC) VEAY:(VDC)</p>
<p>Data Acquisition CER:(DAQ / PEM / OAF) LVEA:(DAQ / PEM / OAF) CERX:(DAQ / PEM / OAF) VEAX:(DAQ / PEM / OAF) CERY:(DAQ / PEM / OAF) VEAY:(DAQ / PEM / OAF)</p>	<p>Suspensions CER:(SUS) LVEA:(SUS) CERX:(SUS) VEAX:(SUS) CERY:(SUS) VEAY:(SUS)</p>	<p>Facilities CER:(FAC) LVEA:(FAC) CERX:(FAC) VEAX:(FAC) CERY:(FAC) VEAY:(FAC)</p>

LLO Rack Naming Scheme

CDS racks are named according to site, IFO designation, subsystem use, station (location) and sequence. (See [G1001030](#))

Site	Description	IFO	Subsystem	Description	Station	Description	Rack Number
L	Livingston	1	AOS	Auxiliary Optics	C	[Corner] Common	1
H	Hanford	2	DAQ	Data Acquisition	MS	Mass Storage	2
M	MIT		ETR	Electronics Test Rack	R	[Corner] Remote (Field)	3
C	CIT		FAC	Facilities and Infrastructure	XC	X-End Common	4
			ISC	IFO Sensing and Control	XR	X-End Remote [Field]	5
			LDR	Laser Diode Room	YC	Y-End Common	6
			OAF	Online Adaptive Filtering	YR	Y-End Remote [Field]	7
			PEM	Physical Environment Monitoring			8
			PSL	Pre-stabilized Laser			9
			SEI	Seismic Isolation			10
			SUS	Suspensions			11
			TCS	Thermal Compensation System			12
			VAC	Vacuum			etc.
			VDC	Voltage - DC			

LLO Rack Names

CDS racks are named according to site, IFO designation, subsystem use, station (location) and sequence. (See [G1001030](#))

Rack	Rack Designator	Subsystem	Location	Comment
1	L1-TCS-C1	AOS	Common Electronics Room	
2	L1-TCS-R1	AOS	Remote Electronics Rack	
3	L1-TCS-R2	AOS	Remote Electronics Rack	
4	L1-TCS-XC1	AOS	X End Remote Electronics Rack	
5	L1-TCS-XR1	AOS	X End Remote Electronics Rack	
6	L1-TCS-YC1	AOS	Y End Common Electronics Rack	
7	L1-TCS-YR1	AOS	Y End Remote Electronics Rack	
8	L1-OAF-C1	DAQ	Common Electronics Room	
9	L1-ETR-01	DAQ	DAQ Electronics Test Rack	DAQ Electronics Test Rack
10	L1-OAF-XC1	DAQ/ISC	X End Common Electronics Rack	
11	L1-OAF-YC1	DAQ/ISC	Y End Common Electronics Rack	
12	L1-ISC-C1	ISC	Common Electronics Room	
13	L1-ISC-C2	ISC	Common Electronics Room	
14	L1-ISC-C3	ISC	Common Electronics Room	
15	L1-ISC-C4	ISC	Common Electronics Room	
16	L1-ISC-R1	ISC	Remote Electronics Rack	
17	L1-ISC-R2	ISC	Remote Electronics Rack	
18	L1-ISC-R3	ISC	Remote Electronics Rack	
19	L1-ISC-XR1	ISC	X End Remote Electronics Rack	
20	L1-ISC-YR1	ISC	Y End Remote Electronics Rack	
21	L1-ETR-04	OPTICS	Optics Electronics Lab Rack	Optics Electronics Lab Rack
22	L1-LDR-C1	PSL	Laser Diode Room Rack	
23	L1-LDR-C2	PSL	Laser Diode Room Rack	
24	L1-PSL-C1	PSL	Common Electronics Room	
25	L1-PSL-R1	PSL	Remote Electronics Rack	
26	L1-PSL-R2	PSL	Remote Electronics Rack	
27	L1-SEI-C1	SEI	Common Electronics Room	SEI HAM 1 and HAM 6
28	L1-SEI-C2	SEI	Common Electronics Room	SEI HAM 2 and HAM 3
29	L1-SEI-C3	SEI	Common Electronics Room	SEI HAM 4 and HAM 5
30	L1-SEI-C4	SEI	Common Electronics Room	SEI BCS1
31	L1-SEI-C5	SEI	Common Electronics Room	SEI BCS2
32	L1-SEI-C6	SEI	Common Electronics Room	SEI BCS3
33	L1-SEI-XC1	SEI	X End Common Electronics Rack	SEI BCS4
34	L1-SEI-YC1	SEI	Y End Common Electronics Rack	SEI BCS5
35	L1-ETR-05	SEI	HAM ISI Electronics Test Rack	HAM ISI Electronics Test Rack
36	L1-ETR-07	SEI	Triple Electronics Test Rack	Triple Electronics Test Rack
37	L1-SUS-C1	SUS	Common Electronics Room	SUS ITM, FM, and BS (1 of 2)
38	L1-SUS-C2	SUS	Common Electronics Room	SUS ITM, FM, and BS (2 of 2)
39	L1-SUS-C3	SUS	Common Electronics Room	SUS HAM 2 (1 of 2)
40	L1-SUS-C4	SUS	Common Electronics Room	SUS HAM 2 (2 of 2)
41	L1-SUS-C5	SUS	Common Electronics Room	SUS ITMX, ITMY, and BS (1 of 2)
42	L1-SUS-C6	SUS	Common Electronics Room	SUS ITMX, ITMY, and BS (2 of 2)

43	L1-SUS-C7	SUS	Common Electronics Room	SUS HAM 5 and HAM 6 (1 of 2)
44	L1-SUS-C8	SUS	Common Electronics Room	SUS HAM 5 and HAM 6 (2 of 2)
45	L1-SUS-R1	SUS	Remote Electronics Rack	
46	L1-SUS-R2	SUS	Remote Electronics Rack	
47	L1-SUS-R3	SUS	Remote Electronics Rack	
48	L1-SUS-R4	SUS	Remote Electronics Rack	
49	L1-SUS-R5	SUS	Remote Electronics Rack	
50	L1-SUS-R6	SUS	Remote Electronics Rack	
51	L1-SUS-XC1	SUS	X End Common Electronics Rack	
52	L1-SUS-XC2	SUS	X End Common Electronics Rack	
53	L1-SUS-XR1	SUS	X End Remote Electronics Rack	
54	L1-SUS-YC1	SUS	Y End Common Electronics Rack	
55	L1-SUS-YC2	SUS	Y End Common Electronics Rack	
56	L1-SUS-YR1	SUS	Y End Remote Electronics Rack	
57	L1-ETR-02	SUS	BSC Electronics Test Rack	BSC Electronics Test Rack
58	L1-ETR-03	SUS	RM Electronics Test Rack	RM Electronics Test Rack
59	L1-ETR-06	SUS	STS Huddle Electronics Test Rack	STS Huddle Electronics Test Rack
60	L1-VAC-R1	VAC	Remote Electronics Rack	
61	L1-VAC-R2	VAC	Remote Electronics Rack	
62	L1-VAC-R3	VAC	Remote Electronics Rack	
63	L1-VAC-XR1	VAC	X End Remote Electronics Rack	
64	L1-VAC-YR1	VAC	Y End Remote Electronics Rack	
65	L1-VDC-C1	VDC	DC Voltage Rack - CPR	
66	L1-VDC-C2	VDC	DC Voltage Rack - CPR	
67	L1-VDC-C3	VDC	DC Voltage Rack - CPR	
68	L1-VDC-C4	VDC	DC Voltage Rack - CPR	
69	L1-VDC-C5	VDC	DC Voltage Rack - CPR	
70	L1-VDC-C6	VDC	DC Voltage Rack - CPR	
71	L1-VDC-C6	VDC	DC Voltage Rack - CPR	
72	L1-VDC-XC1	VDC	DC Voltage Rack - VEAX	
73	L1-VDC-XC2	VDC	DC Voltage Rack - VEAX	
74	L1-VDC-YC1	VDC	DC Voltage Rack - VEAY	
75	L1-VDC-YC2	VDC	DC Voltage Rack - VEAY	
76	L1-MS1			
77	L1-MS2			
78	L1-MS3			
79	L1-MS4			
80	L1-MS5			
81	L1-MS6			
82	L1-DAQ-MS7	DAQ	Front end computers	
83	L1-DAQ-MS8	DAQ	Front end computers	
84	L1-DAQ-MS9	DAQ	Front end computers	
85	L1-MS10			
86	L1-MS11			
87	L1-MS12			
88	L1-MS13			
89	L1-FAC-XC1	FAC	Facilities - VEAX	
90	L1-FAC-YC1	FAC	Facilities - VEAY	

LLO CDS Electronics Rack Names

CDS racks are named according to site, IFO designation, subsystem use, station (location) and sequence. (See [G1001030](#))

Rack	Rack Designator	Subsystem	Location	Comment	Rack Type	Dxxxxxxx	Sxxxxxxx
1	L1-AOS-C1	AOS	CER		Standard	D1201119	S1202974
2	L1-TCS-R1	AOS	LVEA		Standard	D1201122	S1202975
3	L1-TCS-R2	AOS	LVEA		Standard	D1201123	S1202976
4	L1-TCS-XC1	AOS	CERX		Standard	D1201129	S1202980
5	L1-TCS-YC1	AOS	CERY		Standard	D1201130	S1202981
6	L1-OAF-C1	DAQ	CER	OAF/PEM	Standard	D1200941	S1202404
7	L1-DAQ-XC1	DAQ	CERX		Standard	D1201085	S1202949
8	L1-DAQ-YC1	DAQ	CERY		Standard	D1201092	S1202956
9	L1-ISC-C1	ISC	CER		Standard	D1200949	S1201186
10	L1-ISC-C2	ISC	CER		Standard	D1200975	S1201187
11	L1-ISC-C3	ISC	CER		Standard	D1200976	S1201188
12	L1-ISC-C4	ISC	CER		Standard	D1200977	S1201189
13	L1-ISC-R1	ISC	LVEA		Standard	D1001460	S1201192
14	L1-ISC-R2	ISC	LVEA		Standard	D1001425	S1201193
15	L1-ISC-R3	ISC	LVEA		Standard	D1001426	S1201194
16	L1-ISC-R4	ISC	LVEA		Standard	D1101904	S1201195
17	L1-ISC-R5	ISC	LVEA		Standard	D1200196	S1201196
18	L1-ISC-XC1	ISC	CERX		Standard	D1201084	S1202948
19	L1-ISC-YC1	ISC	CERY		Standard	D1201091	S1202955
20	L1-ISC-XR1	ISC	VEAX		Standard	D1201087	S1202951
21	L1-ISC-YR1	ISC	VEAY		Standard	D1201094	S1202958
22	L1-ETR-04	OPTICS	Test Rack	Optics Electronics Lab Rack	11U		
23	L1-LDR-C1	PSL	LDR		Vendor		
24	L1-LDR-C2	PSL	LDR		Vendor		
25	L1-PSL-C1	PSL	CER		Standard	D1201118	S1202977
26	L1-PSL-R1	PSL	LVEA		Standard	D1201120	S1202978
27	L1-PSL-R2	PSL	LVEA		Standard	D1201121	S1202979
28	L1-SEI-C1	SEI	CER	SET HAM 1 and HAM 6	Standard	D1201112	S1200743
29	L1-SEI-C2	SEI	CER	SET HAM 2 and HAM 3	Standard	D1201113	S1200744
30	L1-SEI-C3	SEI	CER	SET HAM 4 and HAM 5	Standard	D1201114	S1200745
31	L1-SEI-C4	SEI	CER	SET BCS1	Standard	D1201115	S1200746
32	L1-SEI-C5	SEI	CER	SET BCS2	Standard	D1201116	S1200747
33	L1-SEI-C6	SEI	CER	SET BCS3	Standard	D1201117	S1200748
34	L1-SEI-XC1	SEI	CERX	SET BCS4	Standard	D1201081	S1202945
35	L1-SEI-YC1	SEI	CERY	SET BCS5	Standard	D1201088	S1202952
36	L1-ETR-05	SET	Test Rack	HAM ISI Electronics Test Rack			
37	L1-ETR-07	SET	Test Rack	Triple Electronics Test Rack			
38	L1-SUS-C1	SUS	CER	SUS ITM, FM, and BS (1 of 2)	Standard	D1200856	S1104062
39	L1-SUS-C2	SUS	CER	SUS ITM, FM, and BS (2 of 2)	Standard	D1200859	S1104356
40	L1-SUS-C3	SUS	CER	SUS HAM 2 (1 of 2)	Standard	D1200864	S1104357
41	L1-SUS-C4	SUS	CER	SUS HAM 2 (2 of 2)	Standard	D1200867	S1104358
42	L1-SUS-C5	SUS	CER	SUS ITMX, ITMY, and BS (1 of 2)	Standard	D1200874	S1105375
43	L1-SUS-C6	SUS	CER	SUS ITMX, ITMY, and BS (2 of 2)	Standard	D1200875	S1105376
44	L1-SUS-C7	SUS	CER	SUS HAM 5 and HAM 6 (1 of 2)	Standard	D1200876	S1105377
45	L1-SUS-C8	SUS	CER	SUS HAM 5 and HAM 6 (2 of 2)	Standard	D1200877	S1105378
46	L1-SUS-R1	SUS	LVEA		Standard	D1200879	S1200749
47	L1-SUS-R2	SUS	LVEA		Standard	D1200880	S1200750
48	L1-SUS-R3	SUS	LVEA		Standard	D1200883	S1202300

49	L1-SUS-R4	SUS	LVEA		Standard	D1201134	S1202995
50	L1-SUS-R5	SUS	LVEA		Standard	D1201135	S1202996
51	L1-SUS-R6	SUS	LVEA		Standard	D1201136	S1202997
52	L1-SUS-XC1	SUS	CERX		Standard	D1201082	S1202946
53	L1-SUS-XC2	SUS	CERX		Standard	D1201083	S1202947
54	L1-SUS-XR1	SUS	VEAX		Standard	D1201131	S1202993
55	L1-SUS-YC1	SUS	CERY		Standard	D1201089	S1202953
56	L1-SUS-YC2	SUS	CERY		Standard	D1201090	S1202954
57	L1-SUS-YR1	SUS	VEAY		Standard	D1201132	S1202994
58	L1-ETR-02	SUS	Test Rack	BSC Electronics Test Rack			
59	L1-ETR-03	SUS	Test Rack	RM Electronics Test Rack			
60	L1-ETR-06	SUS	Test Rack	STS Huddle Electronics Test Rack			
61	L1-VAC-R1	VAC	LVEA	Vacuum Rack - X Arm	Knurr		
62	L1-VAC-R2	VAC	LVEA	Vacuum Rack - Y Arm	Knurr		
63	L1-VAC-R3	VAC	Mechanical Room	Vacuum Rack - Mechanical Room	Knurr		
64	L1-VAC-XR1	VAC	VEAX	Vacuum Rack - X End	Knurr		
65	L1-VAC-YR1	VAC	VEAY	Vacuum Rack - Y End	Knurr		
66	L1-VDC-C1	VDC	CPR		DC	D1200890	S1105247
67	L1-VDC-C2	VDC	CPR		DC	D1200891	S1105248
68	L1-VDC-C3	VDC	CPR		DC	D1200892	S1105249
69	L1-VDC-C4	VDC	CPR		DC	D1200893	S1105250
70	L1-VDC-C5	VDC	CPR		DC	D1200894	S1105251
71	L1-VDC-C6	VDC	CPR		DC	D1200895	S1105252
72	L1-VDC-C7	VDC	CPR		DC	D1200896	S1105253
73	L1-VDC-C8	VDC	CPR	Planned	DC	D1201137	S1202998
74	L1-VDC-XC1	VDC	CERX		DC	D1200897	S1202311
75	L1-VDC-XC2	VDC	CERX		DC	D1200898	S1202312
76	L1-VDC-YC1	VDC	CERY		DC	D1200899	S1202313
77	L1-VDC-YC2	VDC	CERY		DC	D1200900	S1202314
78	L1-MSR-01	CDS	MSR	Atomic Clock	Knurr	D1201372	S1203487
79	L1-MSR-02	CDS	MSR	Fiber Patch	Knurr	D1201373	S1203488
80	L1-MSR-03	CDS	MSR	EPICS	Knurr	D1201374	S1203489
81	L1-MSR-04	CDS	MSR	EPICS	Knurr	D1201375	S1203490
82	L1-MSR-05	CDS	MSR	Backup Tape	Knurr	D1201376	S1203491
83	L1-MSR-06	CDS	MSR	Video	Knurr	D1201377	S1203492
84	L1-MSR-07	CDS	MSR	IFO Front End Computers	Standard	D1201378	S1203493
85	L1-MSR-08	CDS	MSR	IFO Front End Computers	Standard	D1201379	S1203494
86	L1-MSR-09	CDS	MSR	CDS Computers	Standard	D1201380	S1203495
87	L1-MSR-10	CDS	MSR	CDS Computers	Standard	D1201381	S1203496
88	L1-MSR-11	CDS	MSR	General Computing	Standard	D1201382	S1203497
89	L1-MSR-12	CDS	MSR	DAQ Electronics Test Rack	Standard	D1201383	S1203498
90	L1-MSR-13	CDS	MSR	UPS for IFO and CDS Computers	Linier	D1201384	S1203499
91	L1-FAC-C1	FAC	CER		Standard	D1200940	S1202403
92	L1-FAC-XC1	FAC	CERX		Standard	D1201086	S1202950
93	L1-FAC-YC1	FAC	CERY		Standard	D1201093	S1202957
94	L1-UNK-C1	CER			Standard	D1201356	S1203450
95	L1-UNK-C2	CER			Standard	D1201357	S1203451
96	L1-UNK-C3	CER			Standard	D1201358	S1203452

Subsystem	Count	Percent	MSR	CER / CPR	LVEA	CERX	VEAX	CERY	VEAY	Other	Comment
SUS	20	39.22	0	8	6	2	1	2	1	0	Suspensions
SEI	8	15.69	0	6	0	1	0	1	0	0	Seismic
ISC	8	15.69	0	3	3	0	1	0	1	0	IFO Sensing and Control
PEM / DAQ	3	5.88	3	1	0	1	0	1	0	0	Data Acquisition
AOS - TCS	7	13.73	0	1	2	1	1	1	1	0	Thermal Compensation
PSL / LDR	5	9.80	0	3	2	0	0	0	0	0	Pre-stabilized Laser
Subsystem Subtotal	51	100.00	3	22	13	5	3	5	3	0	
Infrastructure	Count		MSR	CER / CPR	LVEA	CERX	VEAX	CERY	VEAY	Other	Comment
DC Power	11		0	7	0	2	0	2	0	0	DC Power Supplies
MSR	13		10	0	0	0	0	0	0	13	MSR Racks
Vacuum	5		0	0	3	0	1	0	1	0	Vacuum Racks
Facilities	2		0	0	0	1	0	1	0	0	Facilities Racks
Test Racks	7		0	0	0	0	0	0	0	7	Subsystem Test Racks
Infrastructure Subtotal	38		10	7	3	3	1	3	1	20	
Total	89		13	29	16	8	4	8	4	20	

Subsystem	Supply Count	Percent	%
SUS	50	29.07	29
SEI	40	23.26	23
ISC	33	19.19	19
DAQ	13	7.56	8
AOS	25	14.53	15
PSL	11	6.40	6
Total	172	100.00	100

<< Start

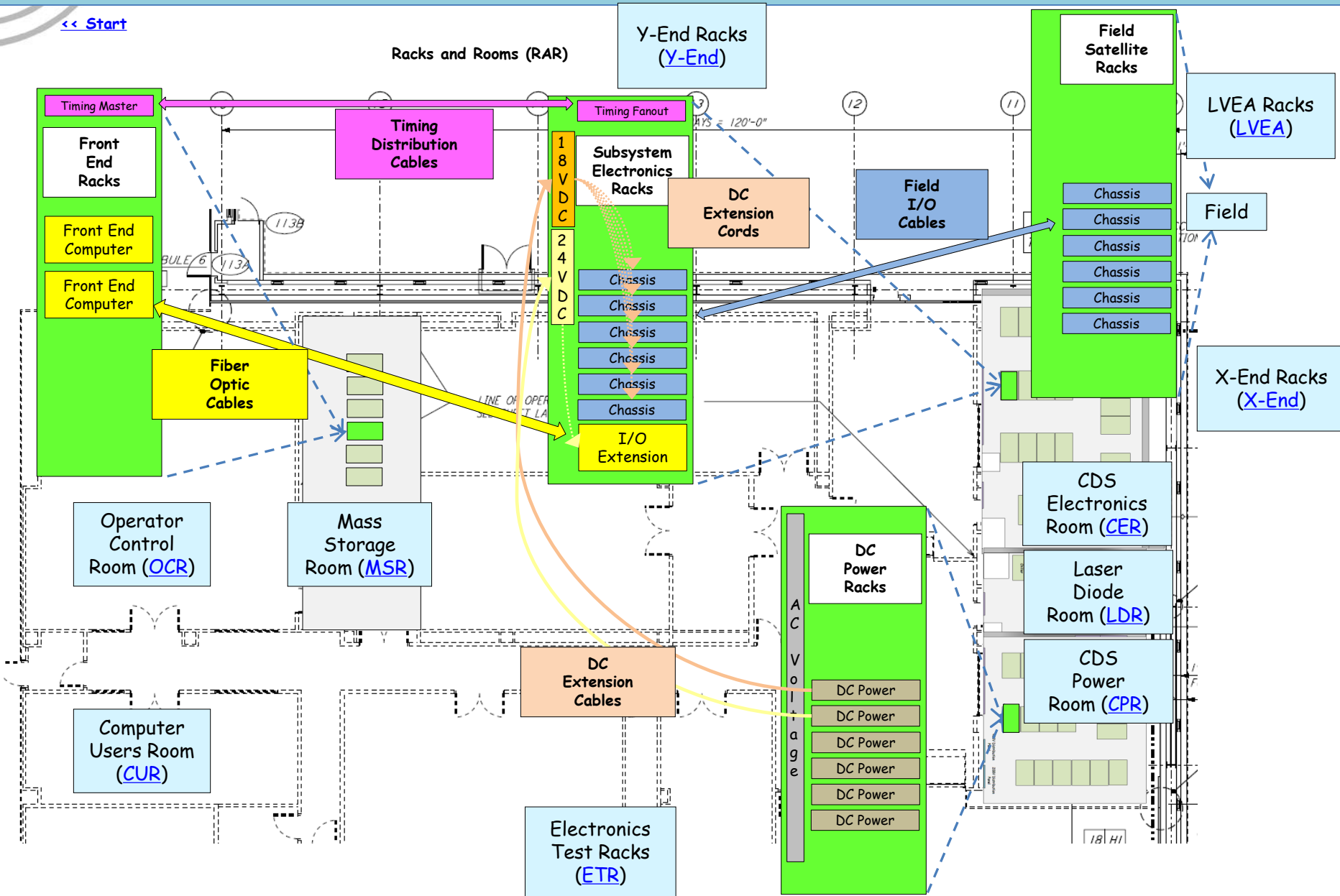

[<< LLO Corner Station](#)

[<< LLO Racks by AREA](#)

[<< LLO CDS Components](#)

OCR

[OCR Documentation](#)

[<< LLO Corner Station](#)

[<< LLO Racks by AREA](#)

[<< LLO CDS Components](#)

CUR

[CUR Documentation](#)

[<< LLO Corner Station](#)

[<< LLO Racks by AREA](#)

[<< LLO CDS Components](#)

MSR

[MSR Documentation](#)
[MSR Layout](#)

MSR (Mass Storage Room) Layout

- [<< LLO Corner Station](#)
- [<< LLO Racks by AREA](#)
- [<< LLO CDS Components](#)

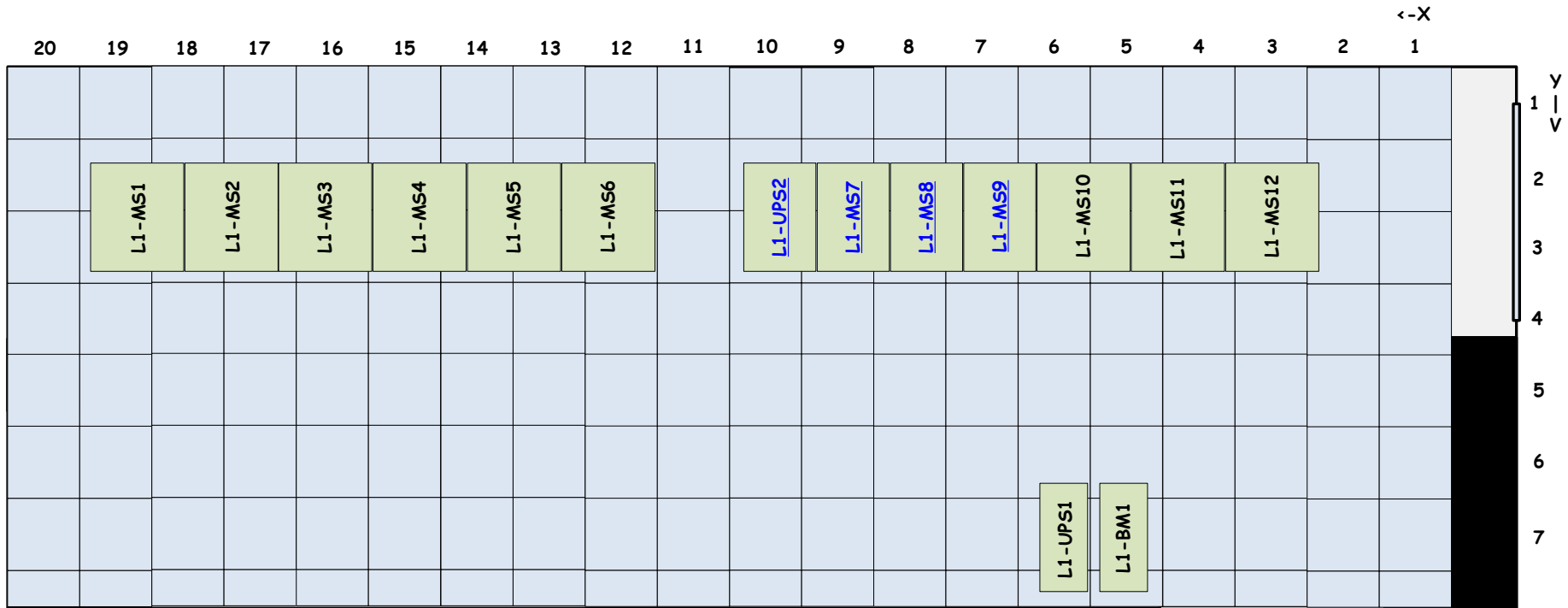
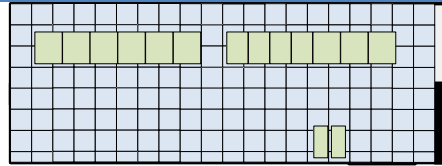

MSR (Mass Storage Room) Layout

- << LLO Corner Station
- << LLO Racks by AREA
- << LLO CDS Components

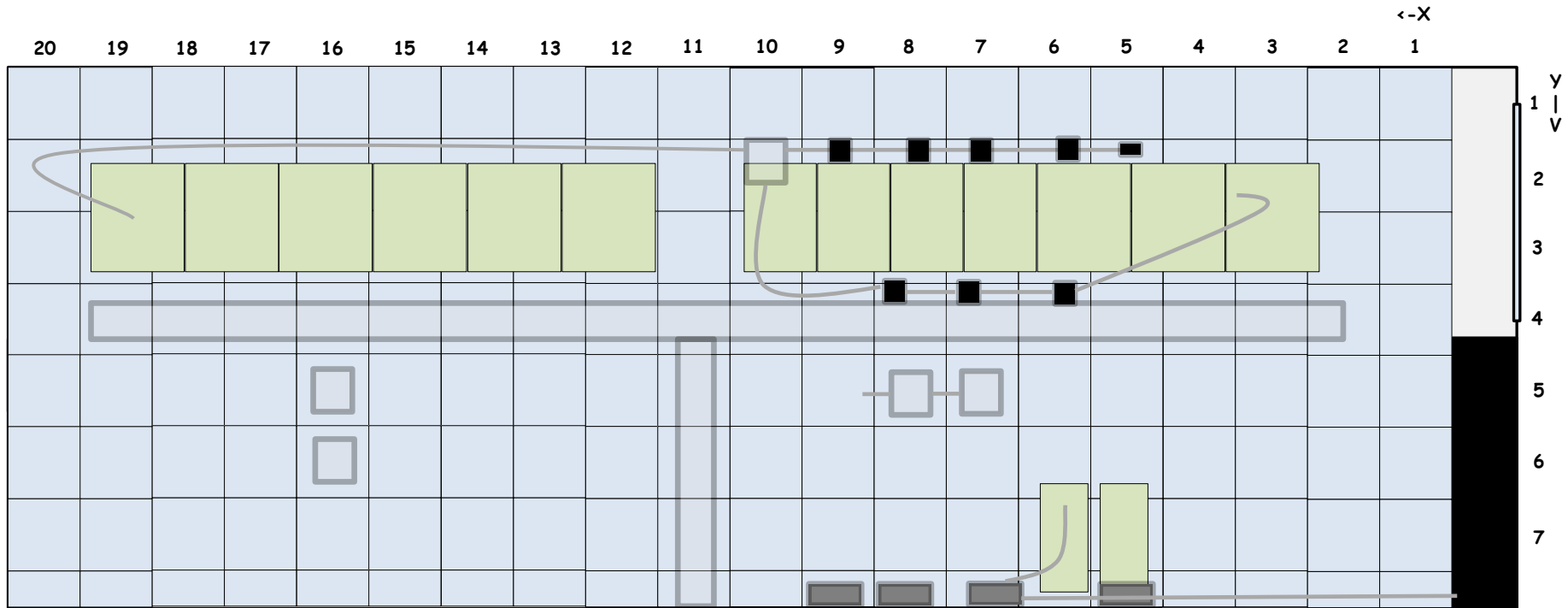
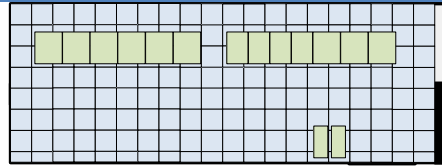



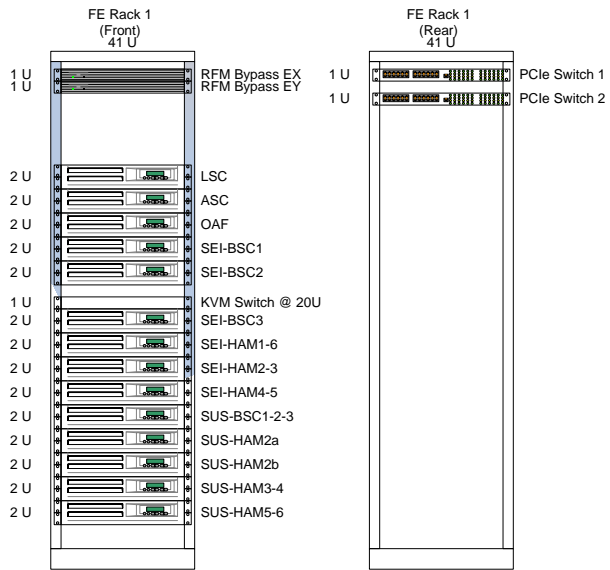

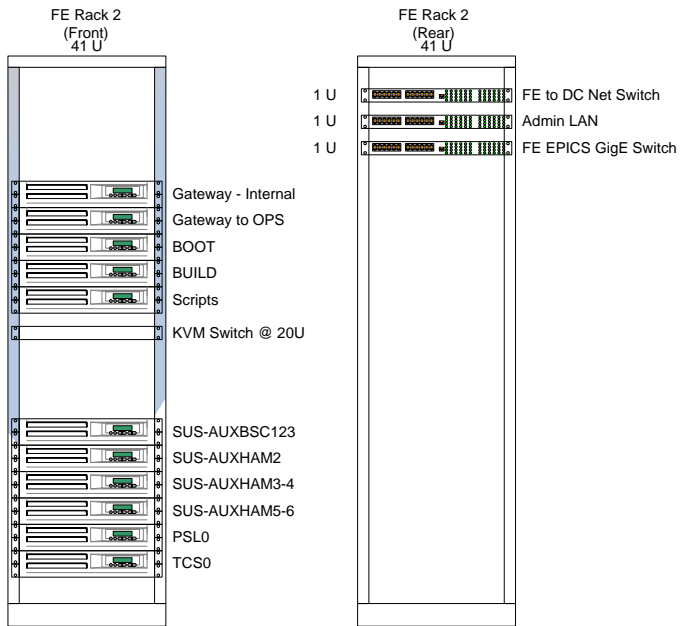

MSR

CDS MSR Rack 9 Layout (T1000588)

Timing IRIG-B Chassis
MasterClock GPS Seconds Display
Power 10 DC Power Supply

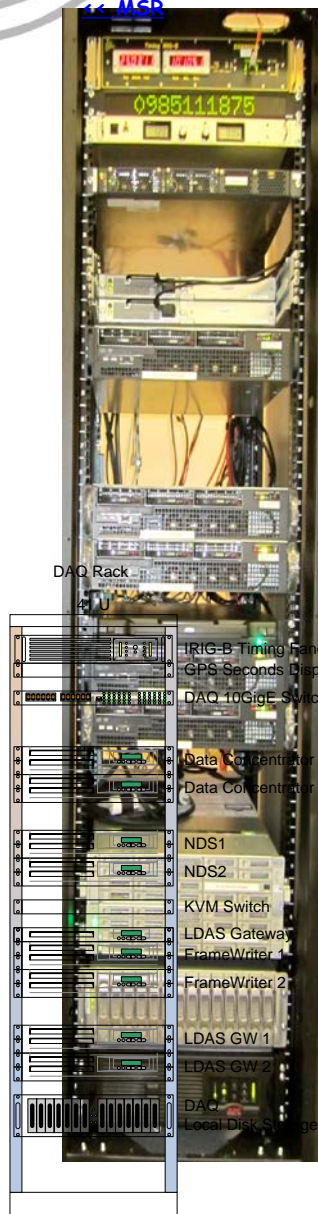

±12@1A
 UPS
 UPS

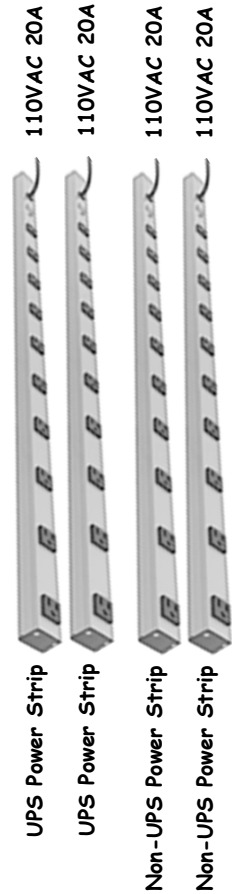

Timing IRIG-B Interface Chassis

D0900301

S1202405

+12VDC

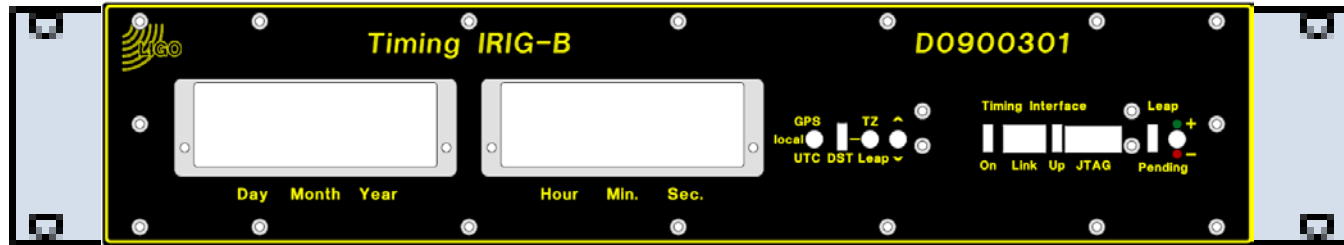

D0900301

Front

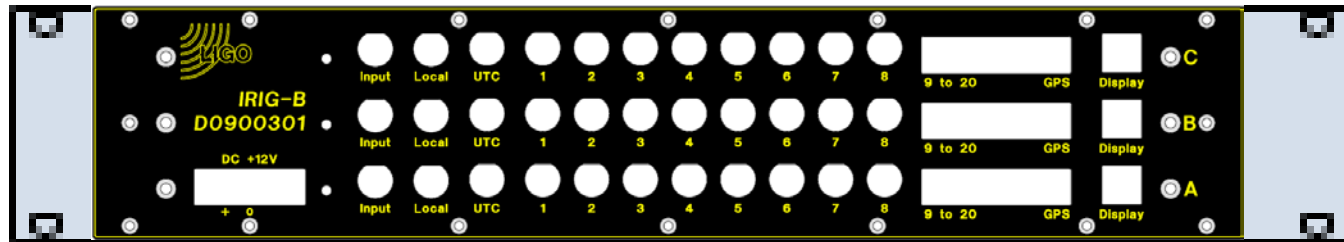

S1202405

Rear

[D0900301](#)

Front

[S1202405](#)

Rear

Power 10 DC Power Supply

The LIGO logo consists of the word "LIGO" in a bold, black, sans-serif font. To the left of the text is a stylized graphic of concentric, overlapping circles, resembling a ripple or a signal, rendered in a light gray color.

[<< L1-MS9](#)

Power 10 DC Power Supply UPS

[D0900301](#)

Front

[S1202405](#)

Rear

[<< LLO Corner Station](#)

[<< LLO Racks by AREA](#)

[<< LLO CDS Components](#)

CER

[Rack Layout >>](#)

- << [LLO Corner Station](#)
- << [LLO Racks by Area](#)
- << [LLO CDS Components](#)

CDS Electronics Room (CER)

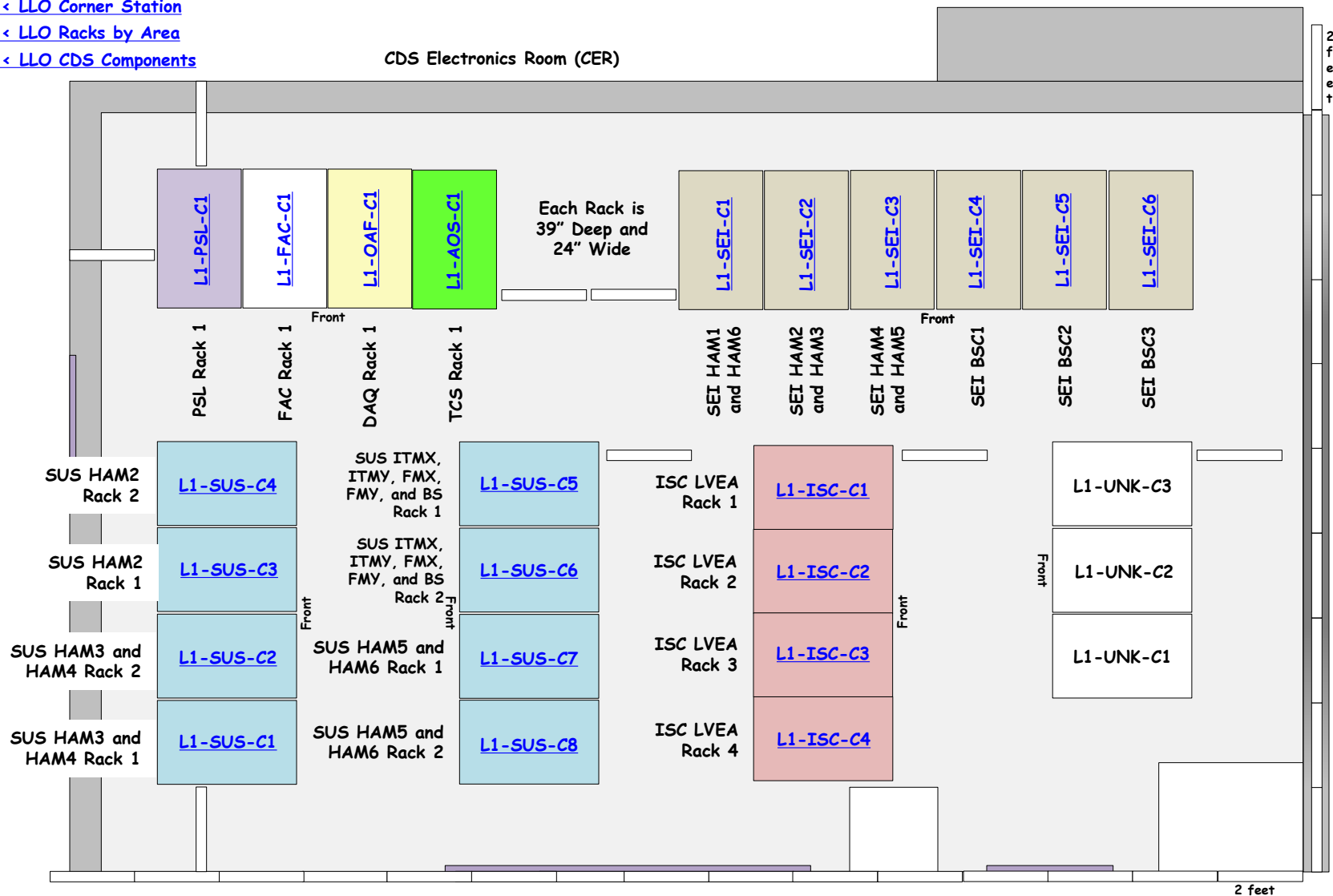

LLO CER, LDR, and CPR Cable Tray Layout

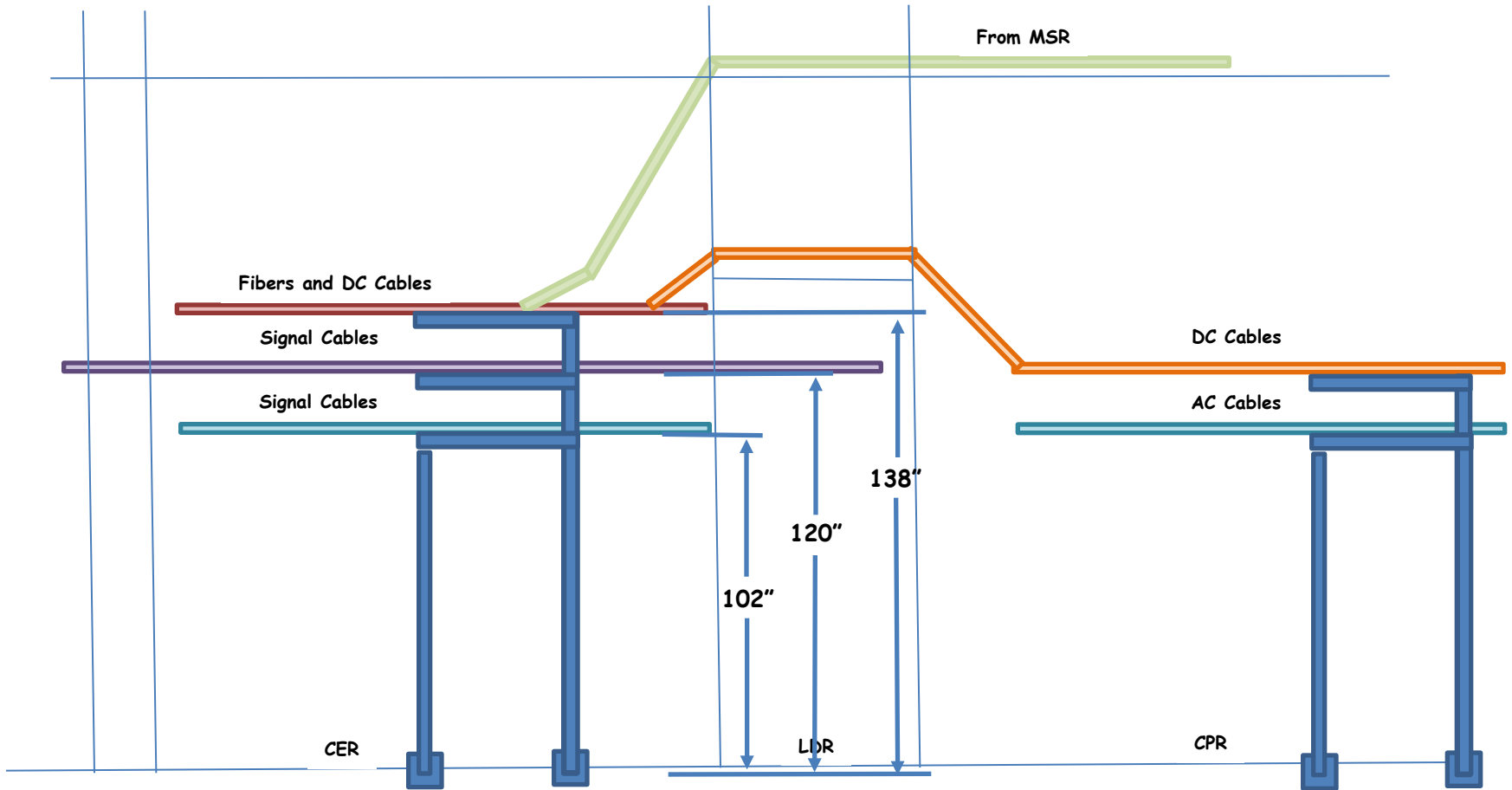

LLO CER - 8.5ft Cable Tray Layout

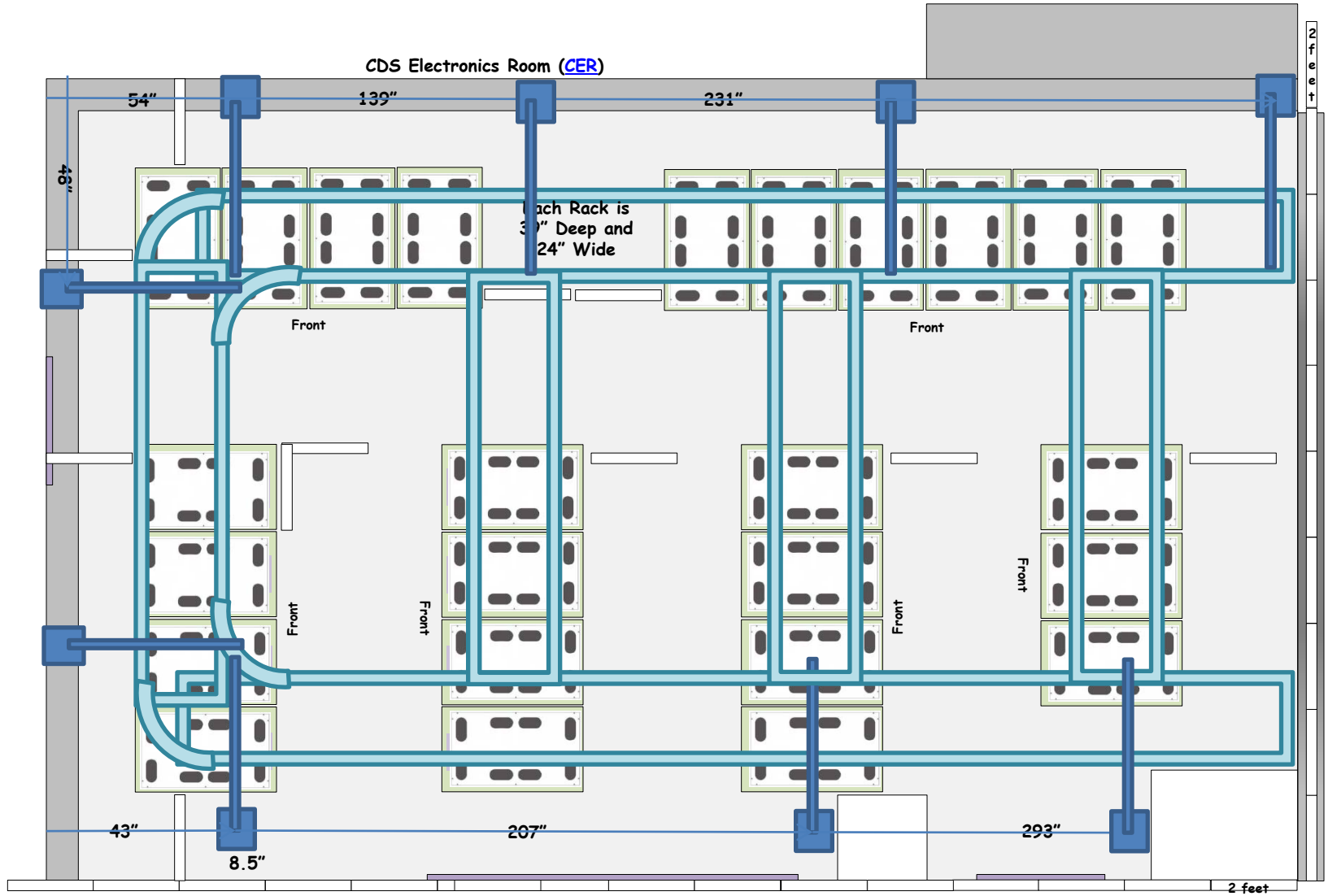

All posts are E-Posts

LIGO CER - 10ft Cable Tray Layout

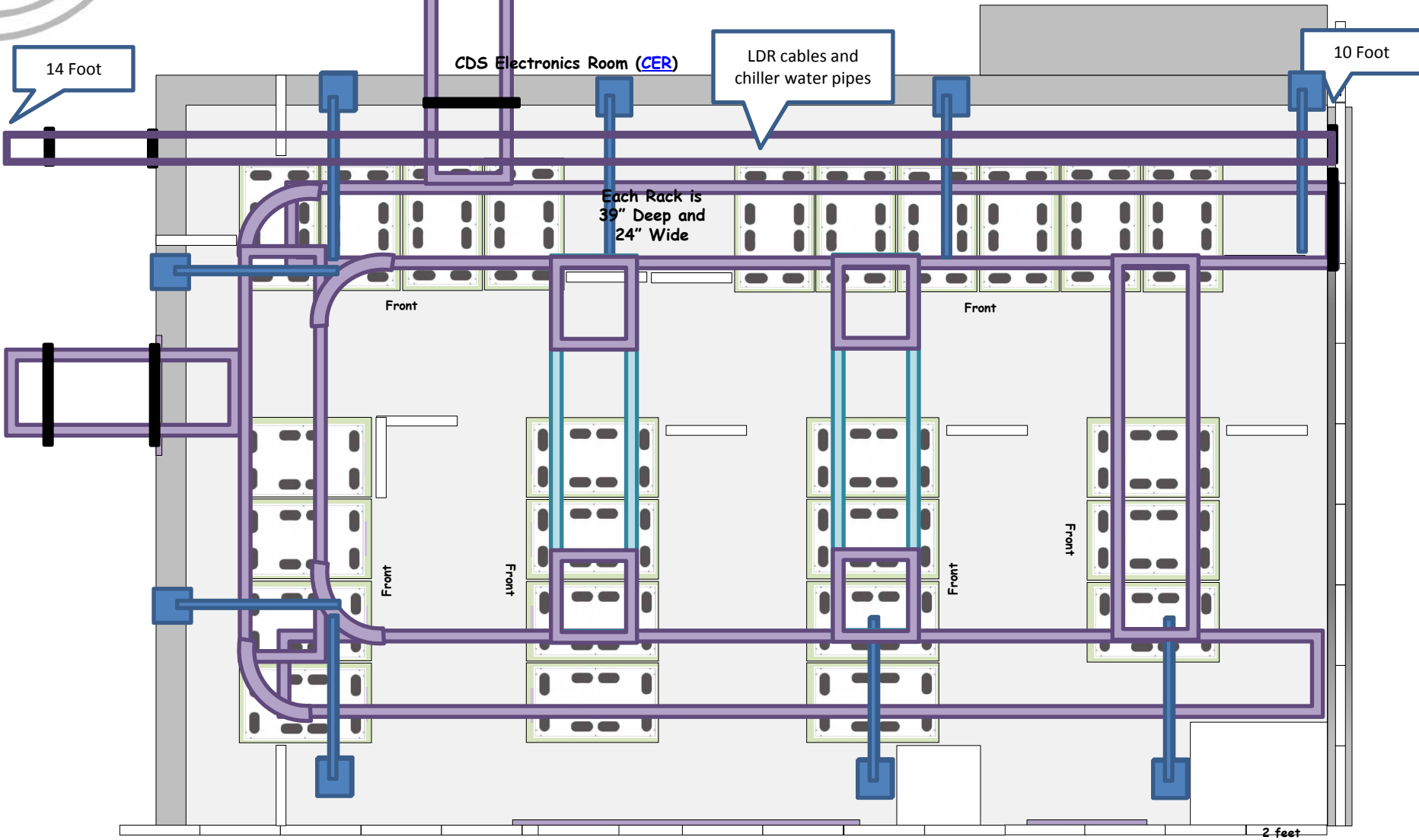

All posts are E-Posts

LLO CER - 11.5ft Cable Tray Layout

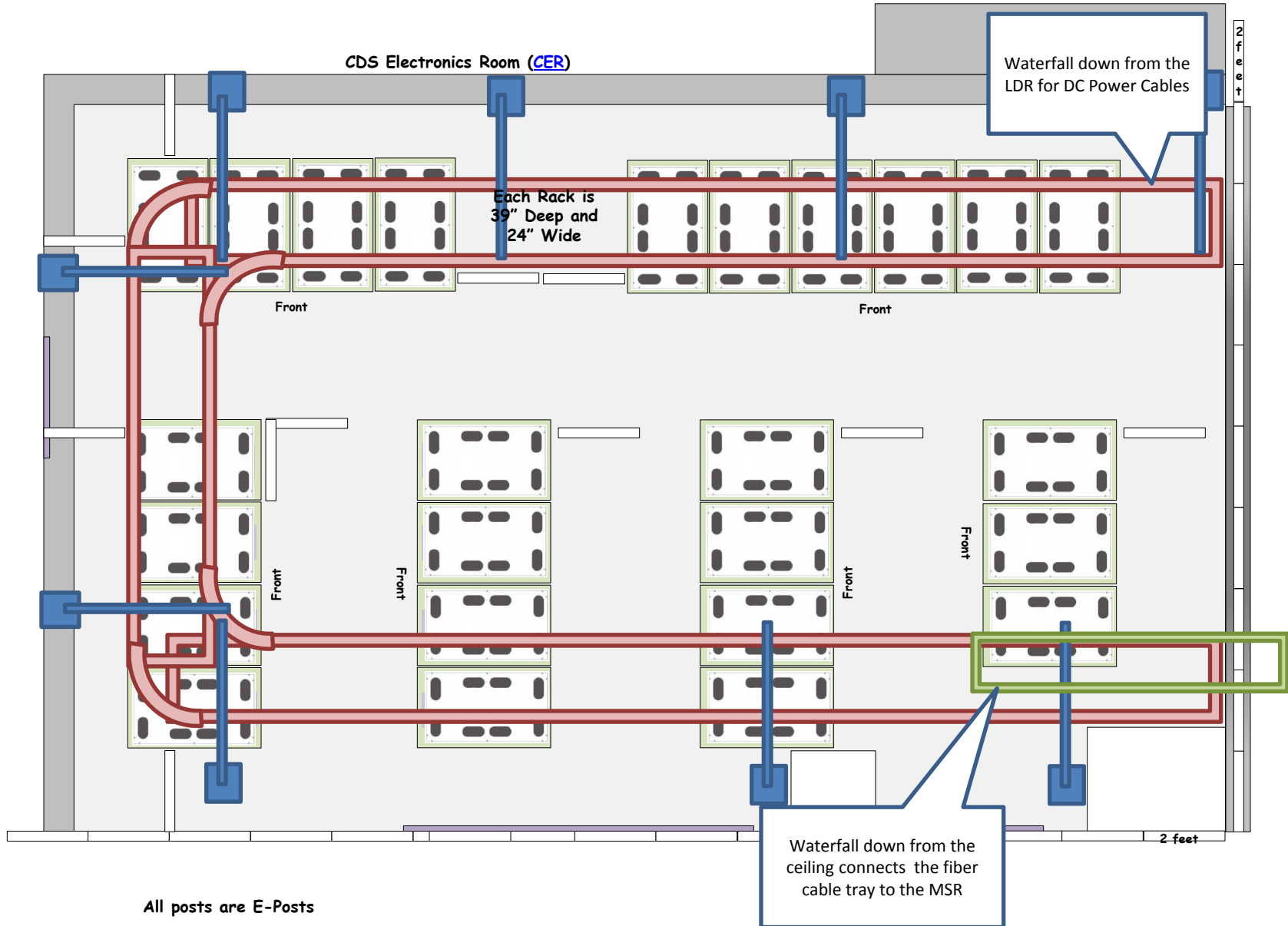

LLO CER - Rack Layout

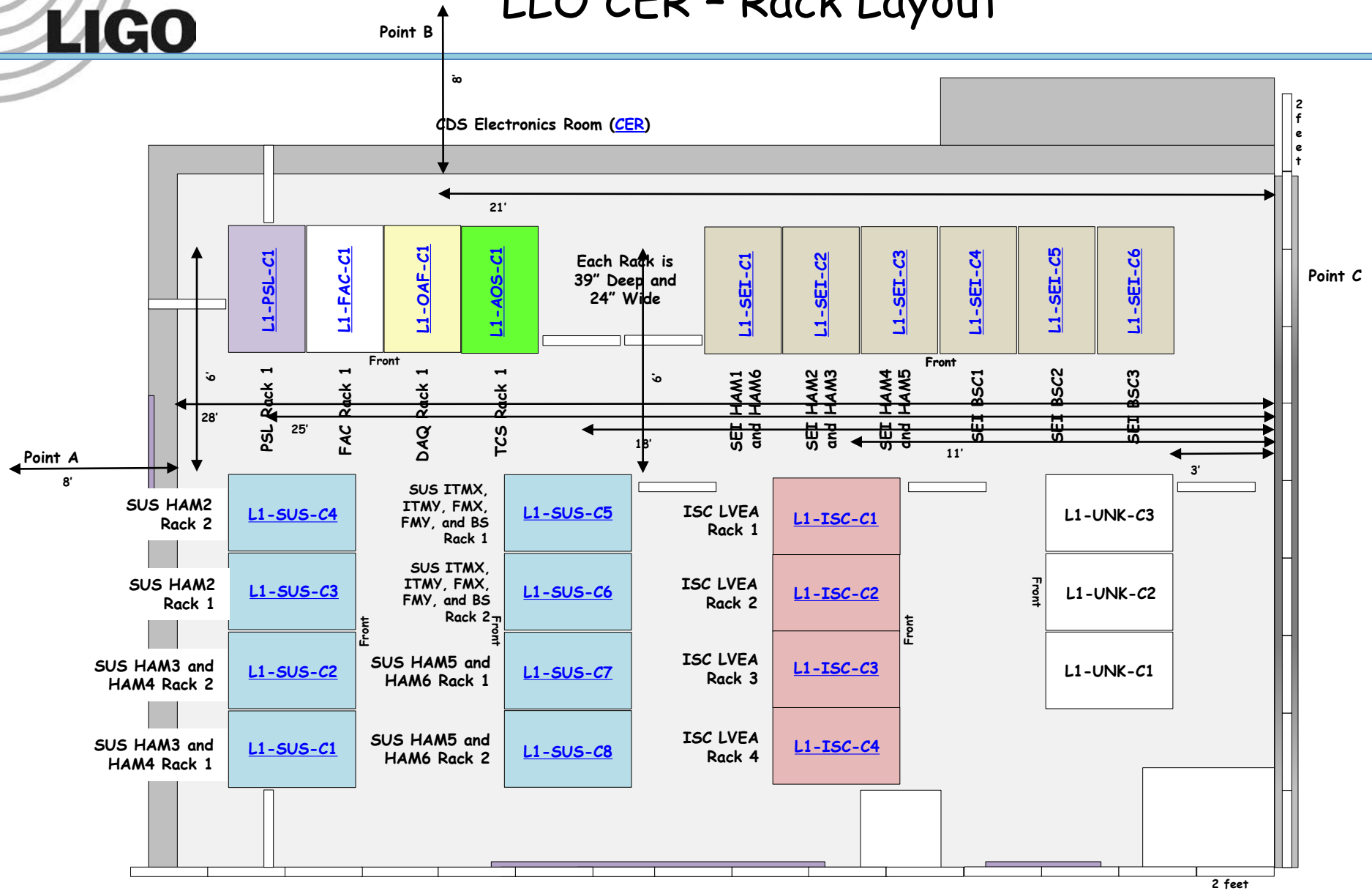

LDR

- << [LLO Corner Station](#)
- << [LLO Racks by AREA](#)
- << [LLO CDS Components](#)

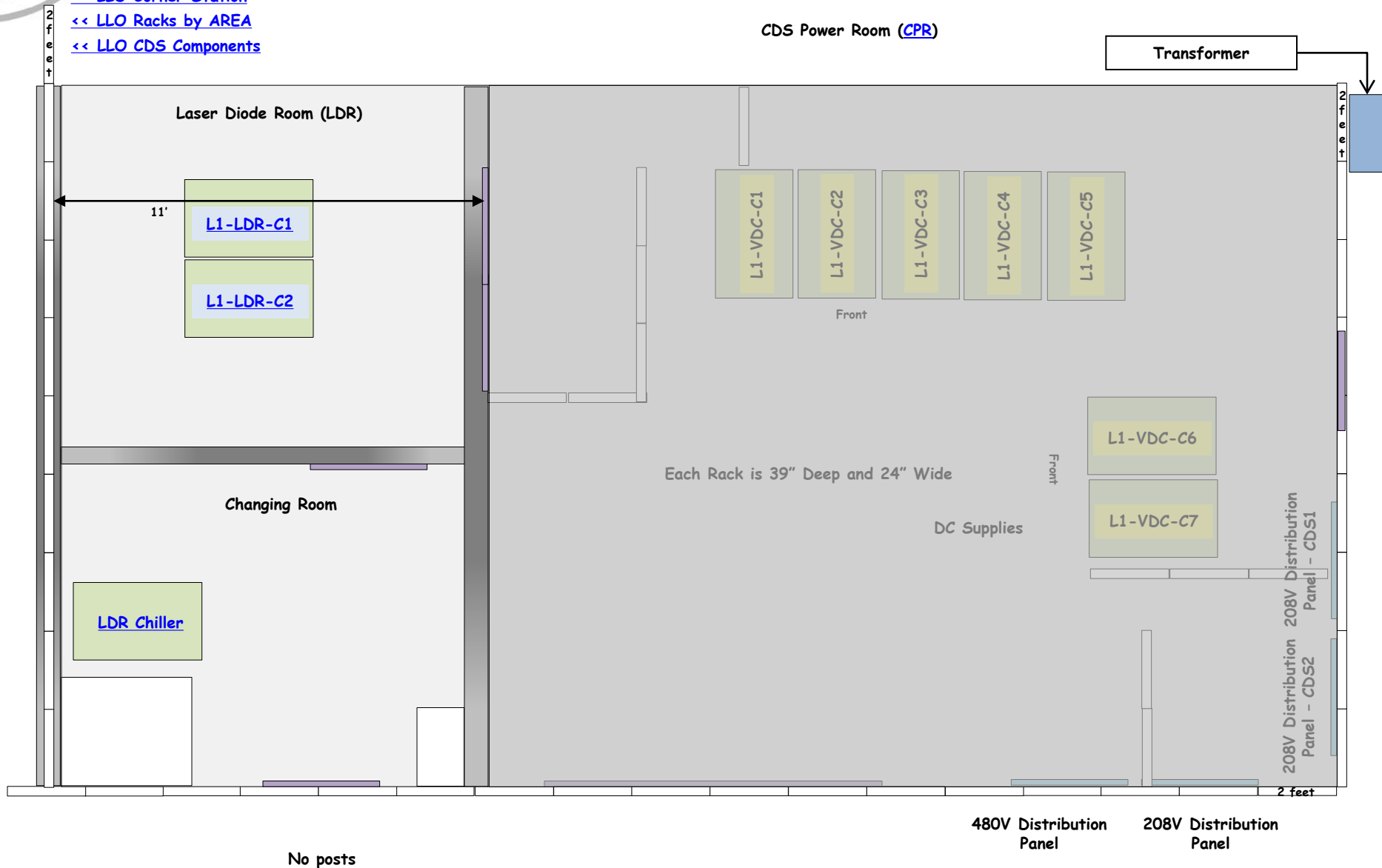

LLO LDR - 10ft Cable Tray Layout

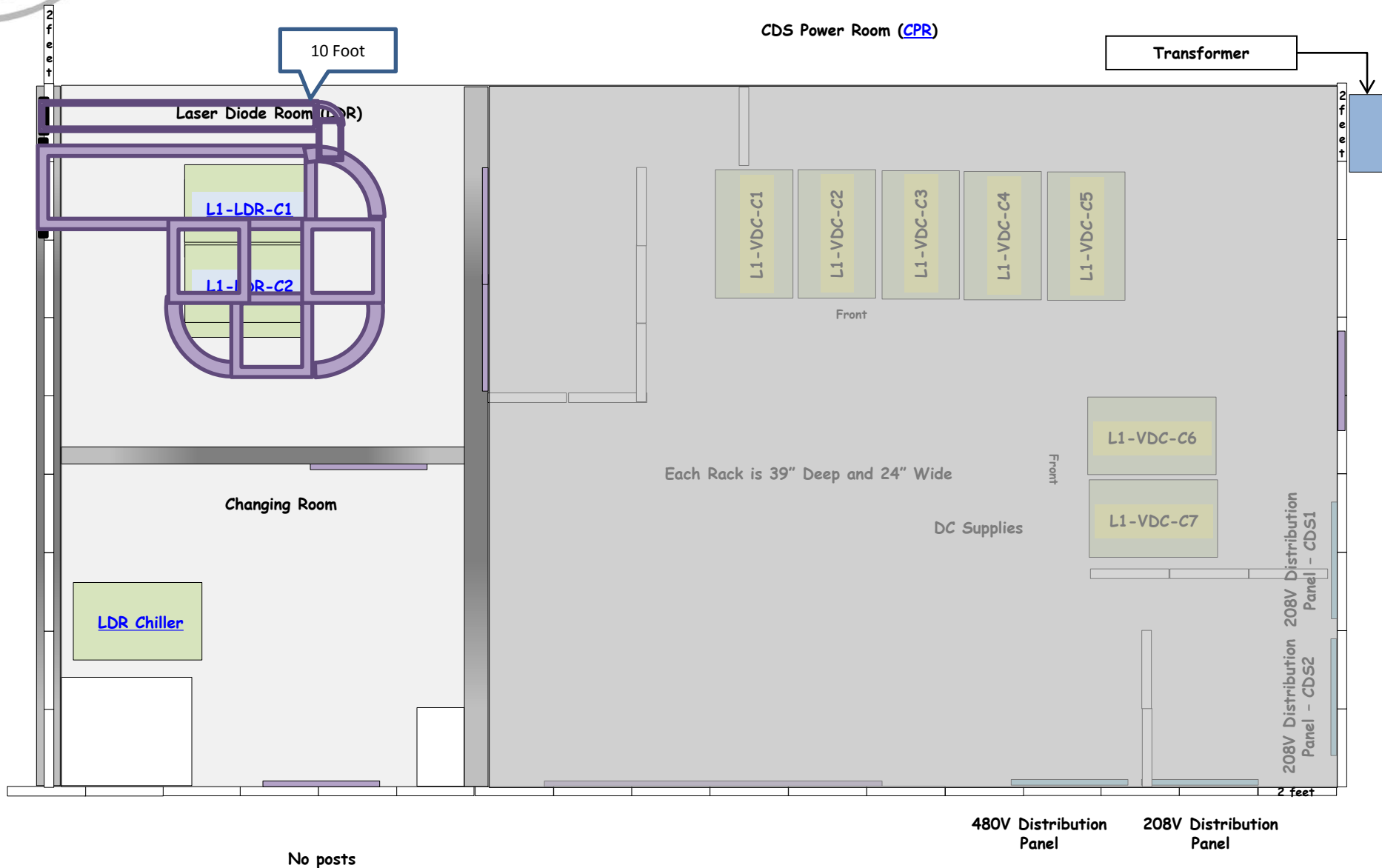

[<< LLO Corner Station](#)

[<< LLO Racks by AREA](#)

[<< LLO CDS Components](#)

CPR

LLO CPR - Rack Layout

- << [LLO Corner Station](#)
- << [LLO Racks by AREA](#)
- << [LLO CDS Components](#)

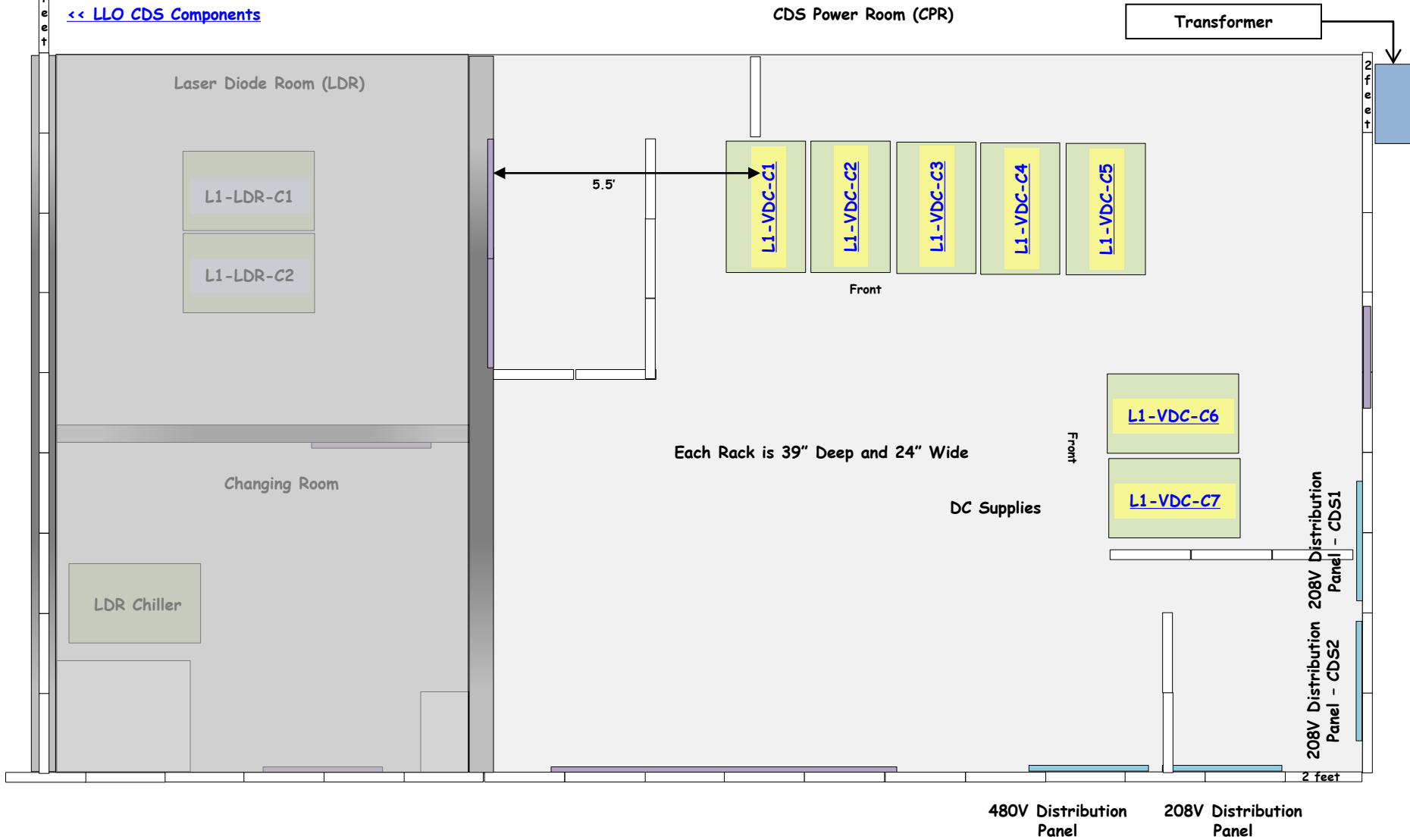

LLO CPR - 8.5ft (AC) Cable Tray Layout

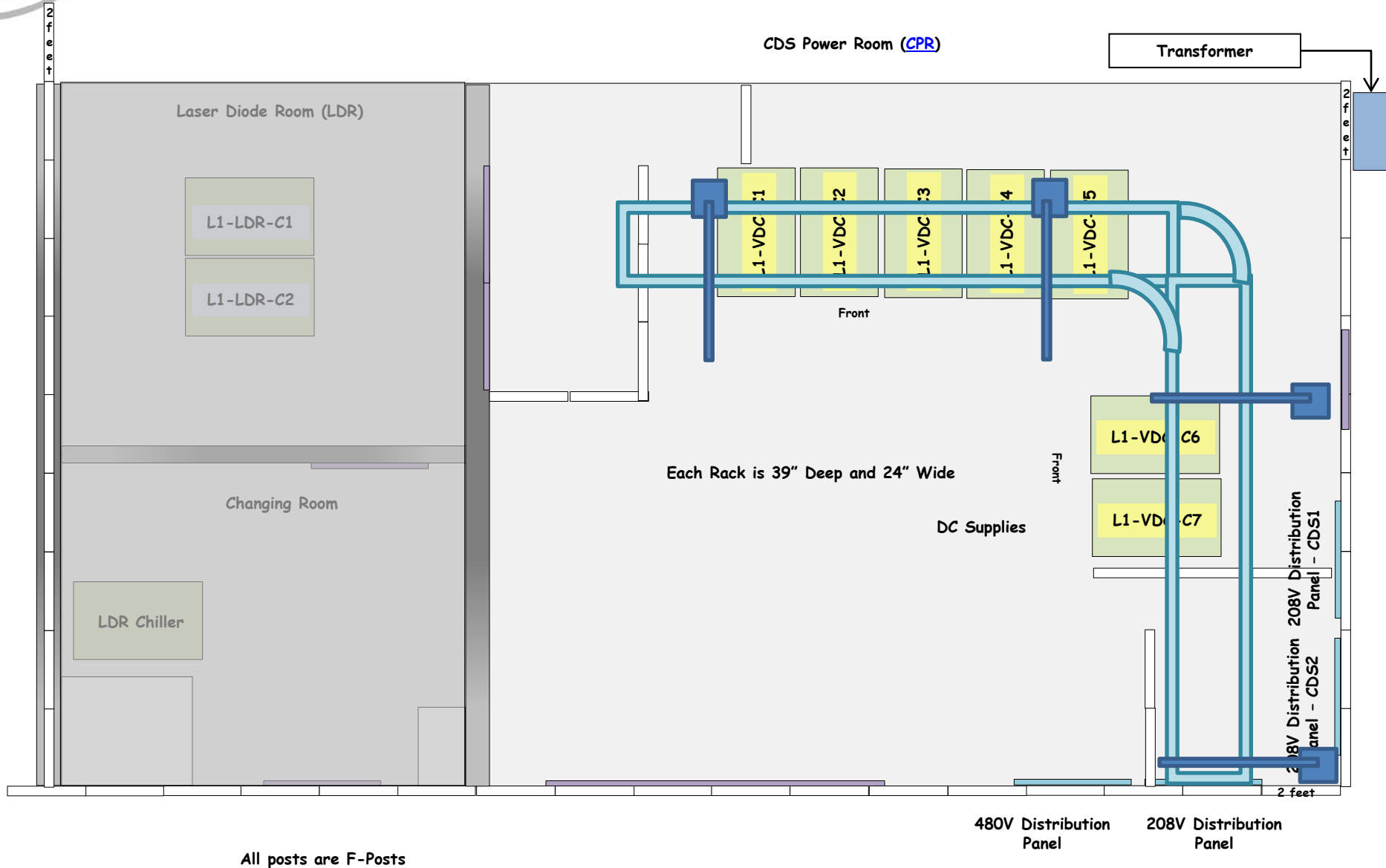

LLO CPR - 10ft (DC) Cable Tray

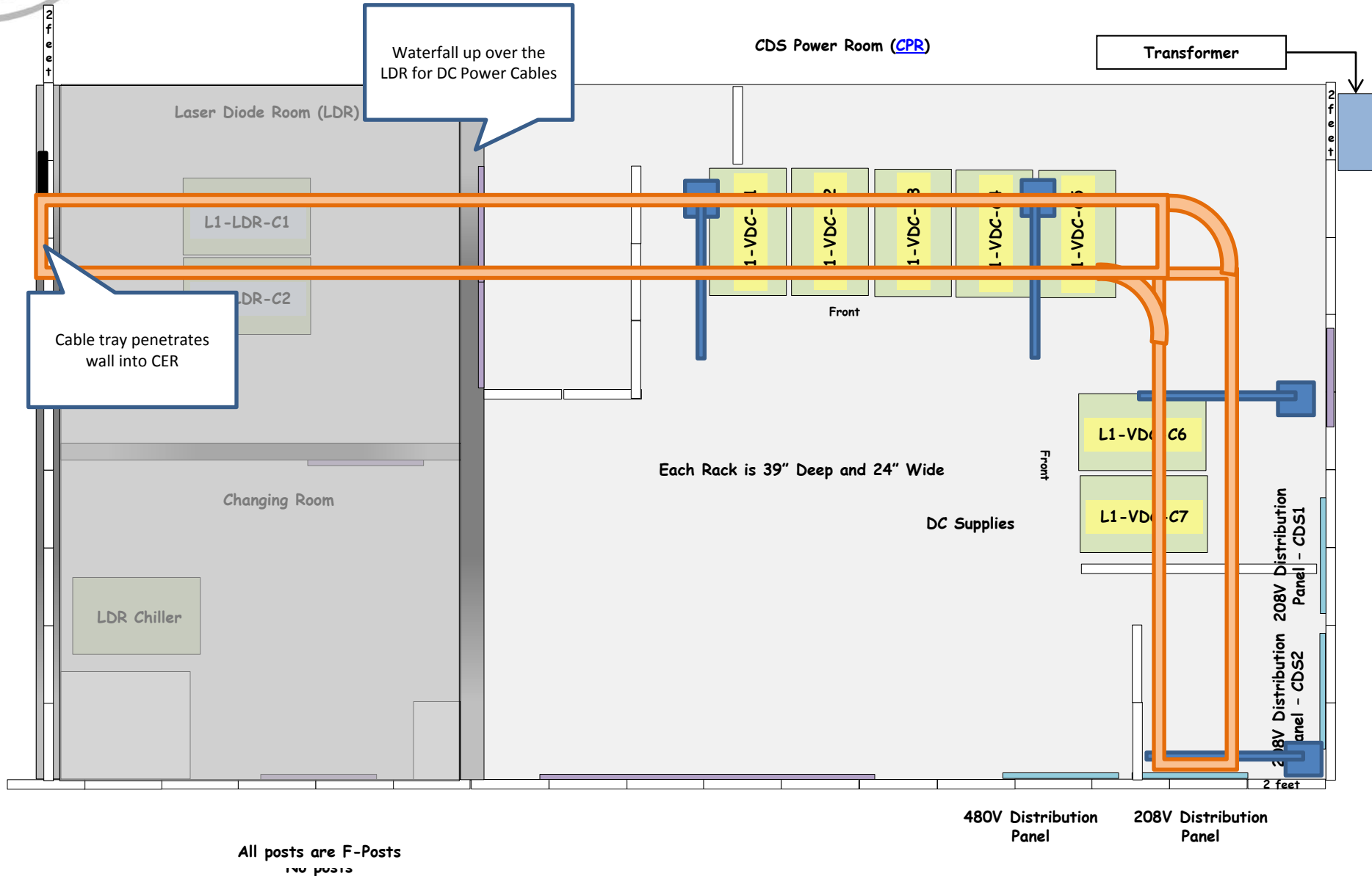

[<< LLO Corner Station](#)
[<< LLO Racks by AREA](#)
[<< LLO CDS Components](#)
[<< IFO Subsystems](#)

VDC

[DC Power Supplies >>](#)

[CPR Rack Layout >>](#)

[CERX DC Rack Layout >>](#)

[CERY DC Rack Layout >>](#)

[KEPCO BHK500-80MG](#)

[KEPCO JQE25-20MVPY27274](#)

[KEPCO JQE36-30M](#)

Picture: Front Panel

Picture: Rear Panel

Specifications

Inventory of Serial Numbers / Dates received / scheduled maintenance / assigned use / etc.

Acceptance Testing: LIGO-Txxxxxxx

Picture: Front Panel

Picture: Rear Panel

Specifications

Inventory of Serial Numbers / Dates received / scheduled maintenance / assigned use / etc.

Acceptance Testing: [LIGO-T1100478](#)

Picture: Front Panel

Picture: Rear Panel

Specifications

**Inventory of Serial Numbers / Dates received / scheduled
maintenance / assigned use / etc.**

Acceptance Testing: LIGO-Txxxxxxx

DC Power Rack - Required VDC

<< CPR

5 Standard Banks
per Rack

10 x 4U => 40U

DC Power Rack

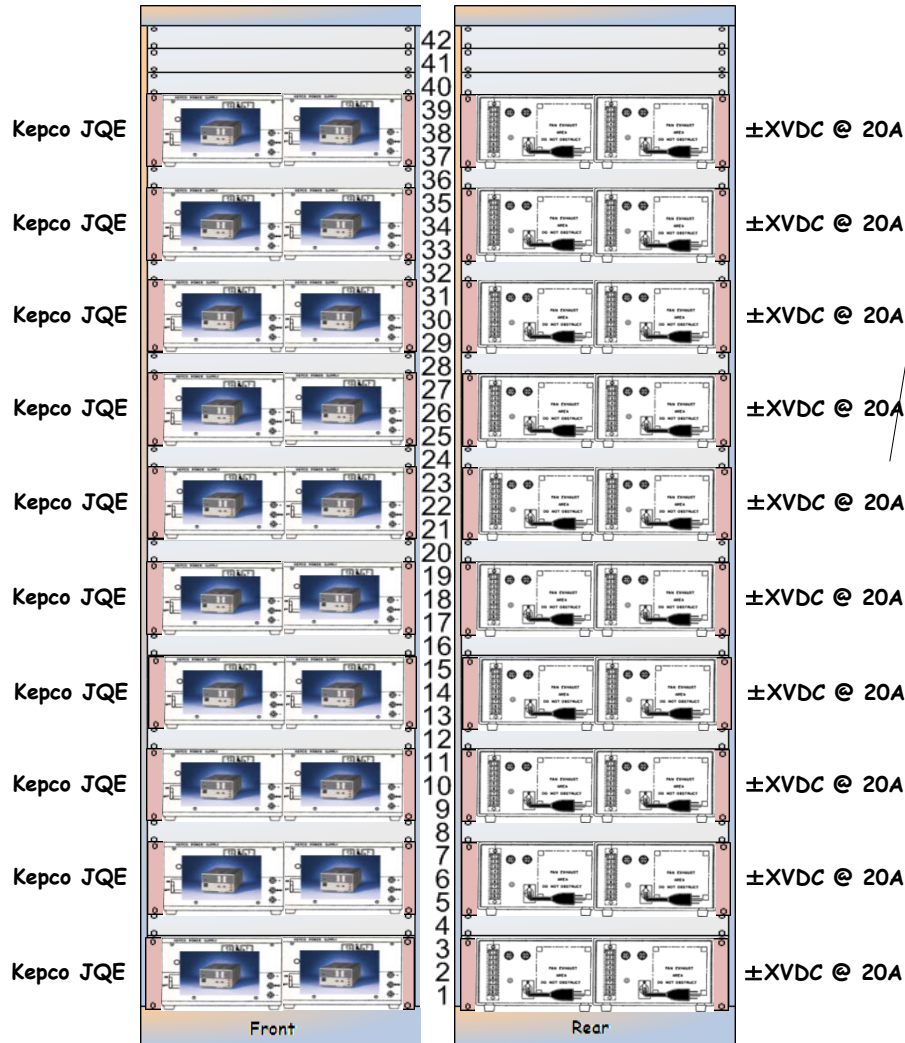

A Standard Bank (SB) of power supplies consists of 4 supplies, and services 1 Electronics Rack.

The 4 supplies are:
+18V@20A, -18V@20A,
+24V@20A, and -24V@20A.

Each Standard Bank of DC Power Supplies provides

$18V * 20A \Rightarrow 360W$
 $360W * 2 PS \Rightarrow 720W$
 $24V * 20A \Rightarrow 480W$
 $480W * 2 PS \Rightarrow 960W$
 $720W + 960W \Rightarrow 1680W$

There are 5 SB (20 PS) / Power Rack. Each Power Rack therefore provides 8400W

Each Power Rack services 5 Electronics Racks.

There are roughly 22 racks per interferometer.

Therefore 5 DC Power Racks are required and will **provide** for a total of 42,000 W.

DC Power Rack - Required VAC

<< CPR

5 Standard Banks
per Rack

10 x 4U => 40U

DC Power Rack

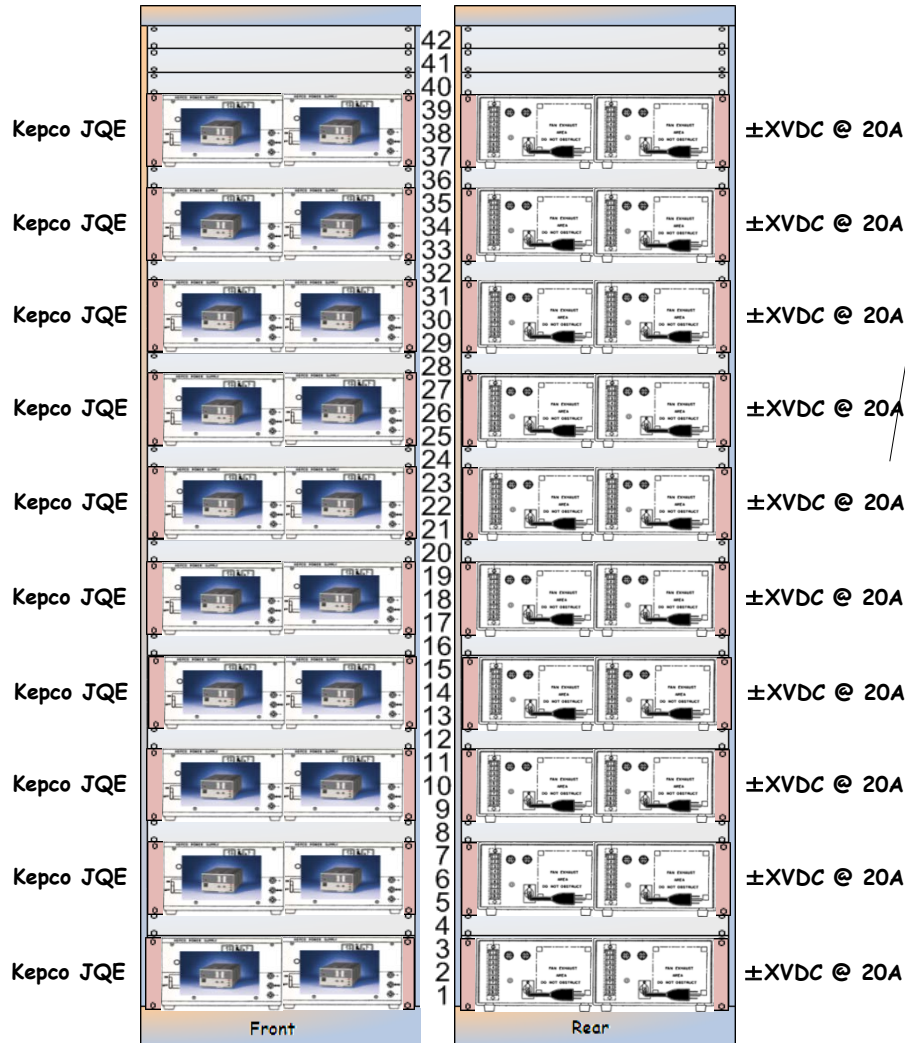

A Standard Bank (SB) of power supplies consists of 4 supplies, and services 1 Electronics Rack.

The 4 supplies are:
+18V@20A, -18V@20A,
+24V@20A, and -24V@20A.

Each (~JQE25-20M) DC Power Supply requires 10.5A @ 125VAC

Each Standard Bank of DC Power Supplies requires 42A @ 125VAC

There are 5 SB (20 PS) / Power Rack. Each Power Rack therefore requires 210A @ 125VAC.

10 - 125V@20A circuits per Power Rack should suffice.

Each Power Rack services 5 Electronics Racks.

There are roughly 22 racks per interferometer.

70 - 125V @20A circuits are required for a total of 183,750W.

Therefore 2 - 480VAC * 200A circuits would provide 192,000W

DC Power Rack

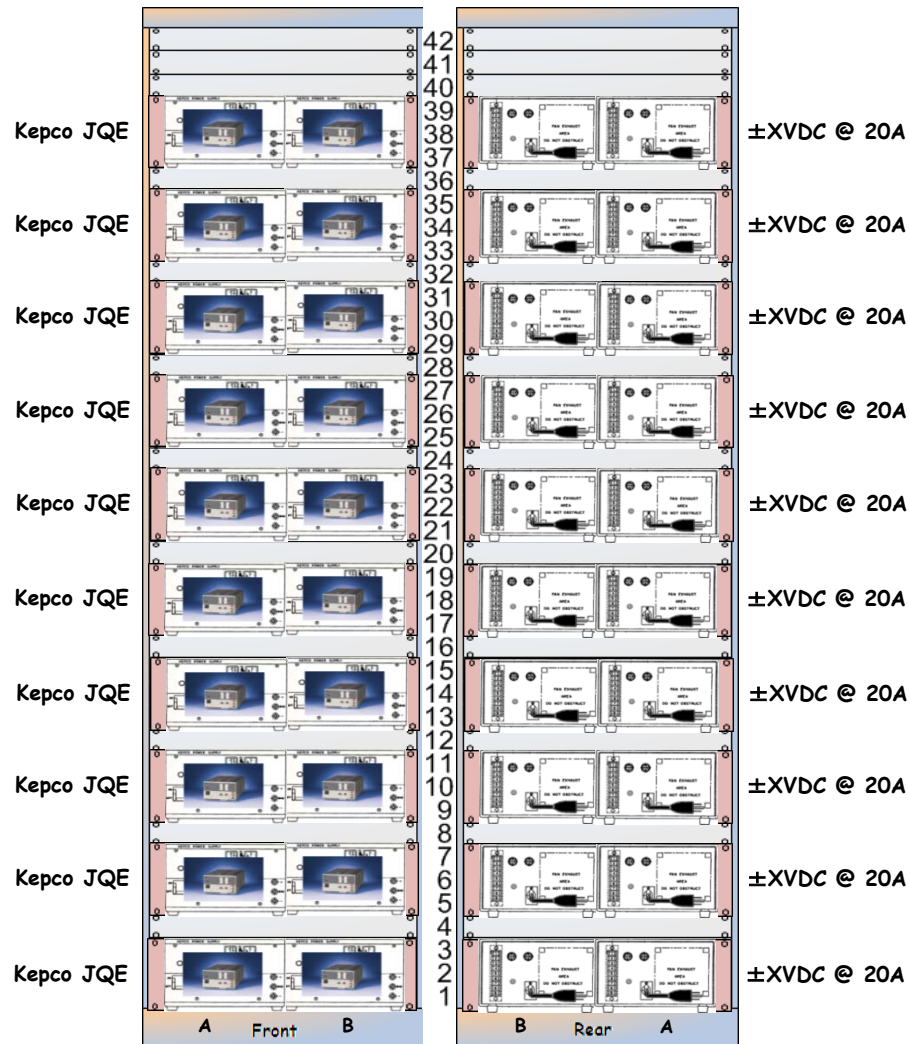

12 @ 125V, 20A Circuits per Rack

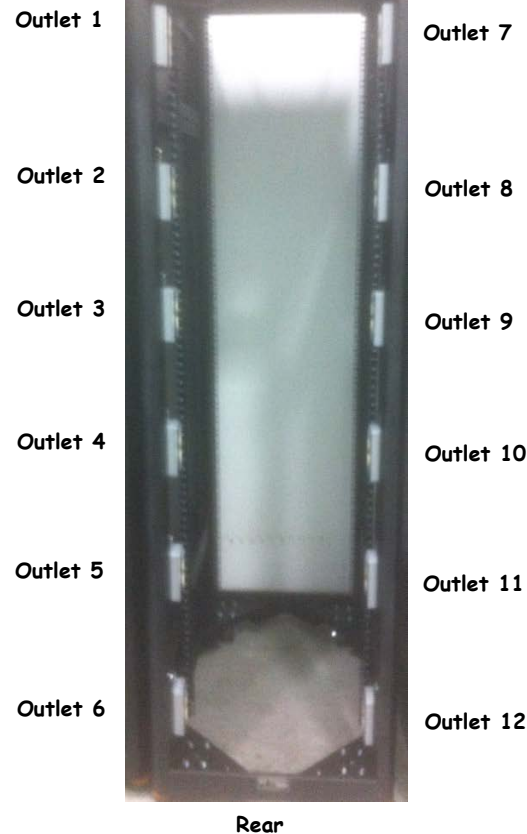

L1-VDC-C1 Power Racks - Required Supplies

<< CPR

L1-VDC-C1 Corner Station DC Power Rack Layout ([D1200890](#)) ([S1105247](#))

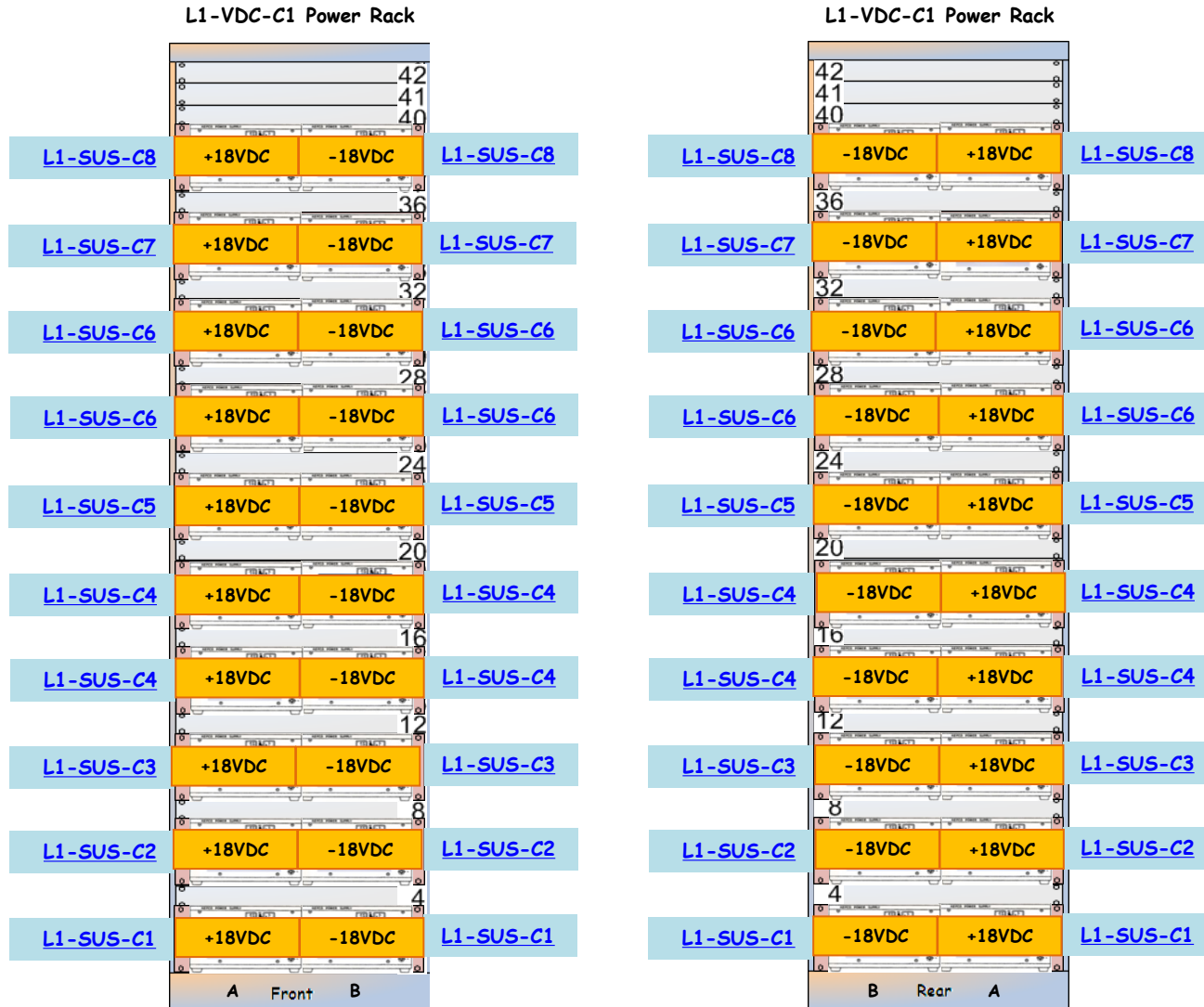

[Cable Runs >>](#)

L1-VDC-C1 Cable Runs

<< [L1-VDC-C1](#)

L1-VDC-C1 Corner Station DC Cable Runs ([D1200890](#)) ([S1105247](#))

L1-VDC-C1 S1105247	Power Panel	Circuit	DC Power Rack	Outlet	Plug Position	Rack U	Power Supply Model	Power Supply Serial	Polarity	DC Extension Cable	Electronics Rack	DC Power Strip
1	CDS-1	06	L1-VDC-C1	08	Top	U37-A (Left)	JQE 25V 20A	H236464	Plus	PTO-001	L1-SUS-C8	PSO-001
2	CDS-1	06	L1-VDC-C1	08	Bottom	U37-B (Right)	JQE 25V 20A	H236467	Minus	PTO-001	L1-SUS-C8	PSO-001
3	CDS-1	27	L1-VDC-C1	02	Top	U33-A (Left)	JQE 25V 20A	H236434	Plus	PTO-002	L1-SUS-C7	PSO-002
4	CDS-1	27	L1-VDC-C1	02	Bottom	U33-B (Right)	JQE 25V 20A	H236427	Minus	PTO-002	L1-SUS-C7	PSO-002
5	CDS-1	08	L1-VDC-C1	09	Top	U29-A (Left)	JQE 25V 20A	H236468	Plus	PTO-021	L1-SUS-C6A	PSO-003
6	CDS-1	08	L1-VDC-C1	09	Bottom	U29-B (Right)	JQE 25V 20A	H236372-R1	Minus	PTO-021	L1-SUS-C6A	PSO-003
7	CDS-1	29	L1-VDC-C1	03	Top	U25-A (Left)	JQE 25V 20A	H236447	Plus	PTO-003	L1-SUS-C6B	PSO-021
8	CDS-1	29	L1-VDC-C1	03	Bottom	U25-B (Right)	JQE 25V 20A	H236463	Minus	PTO-003	L1-SUS-C6B	PSO-021
9	CDS-1	10	L1-VDC-C1	10	Top	U21-A (Left)	JQE 25V 20A	H236388	Plus	PTO-004	L1-SUS-C5	PSO-004
10	CDS-1	10	L1-VDC-C1	10	Bottom	U21-B (Right)	JQE 25V 20A	H236406	Minus	PTO-004	L1-SUS-C5	PSO-004
11	CDS-1	31	L1-VDC-C1	04	Top	U17-A (Left)	JQE 25V 20A	H236396	Plus	PTO-005	L1-SUS-C4A	PSO-005
12	CDS-1	31	L1-VDC-C1	04	Bottom	U17-B (Right)	JQE 25V 20A	H236404	Minus	PTO-005	L1-SUS-C4A	PSO-005
13	CDS-1	12	L1-VDC-C1	11	Top	U13-A (Left)	JQE 25V 20A	H236418	Plus	PTO-022	L1-SUS-C4B	PSO-022
14	CDS-1	12	L1-VDC-C1	11	Bottom	U13-B (Right)	JQE 25V 20A	H236424	Minus	PTO-022	L1-SUS-C4B	PSO-022
15	CDS-1	33	L1-VDC-C1	05	Top	U09-A (Left)	JQE 25V 20A	H236469	Plus	PTO-006	L1-SUS-C3	PSO-006
16	CDS-1	33	L1-VDC-C1	05	Bottom	U09-B (Right)	JQE 25V 20A	H236443	Minus	PTO-006	L1-SUS-C3	PSO-006
17	CDS-1	14	L1-VDC-C1	12	Top	U05-A (Left)	JQE 25V 20A	H210616	Plus	PTO-007	L1-SUS-C2	PSO-007
18	CDS-1	14	L1-VDC-C1	12	Bottom	U05-B (Right)	JQE 25V 20A	H210622	Minus	PTO-007	L1-SUS-C2	PSO-007
19	CDS-1	02	L1-VDC-C1	06	Top	U01-A (Left)	JQE 25V 20A	H210617	Plus	PTO-008	L1-SUS-C1	PSO-008
20	CDS-1	02	L1-VDC-C1	06	Bottom	U01-B (Right)	JQE 25V 20A	H210619	Minus	PTO-008	L1-SUS-C1	PSO-008
D1200890												

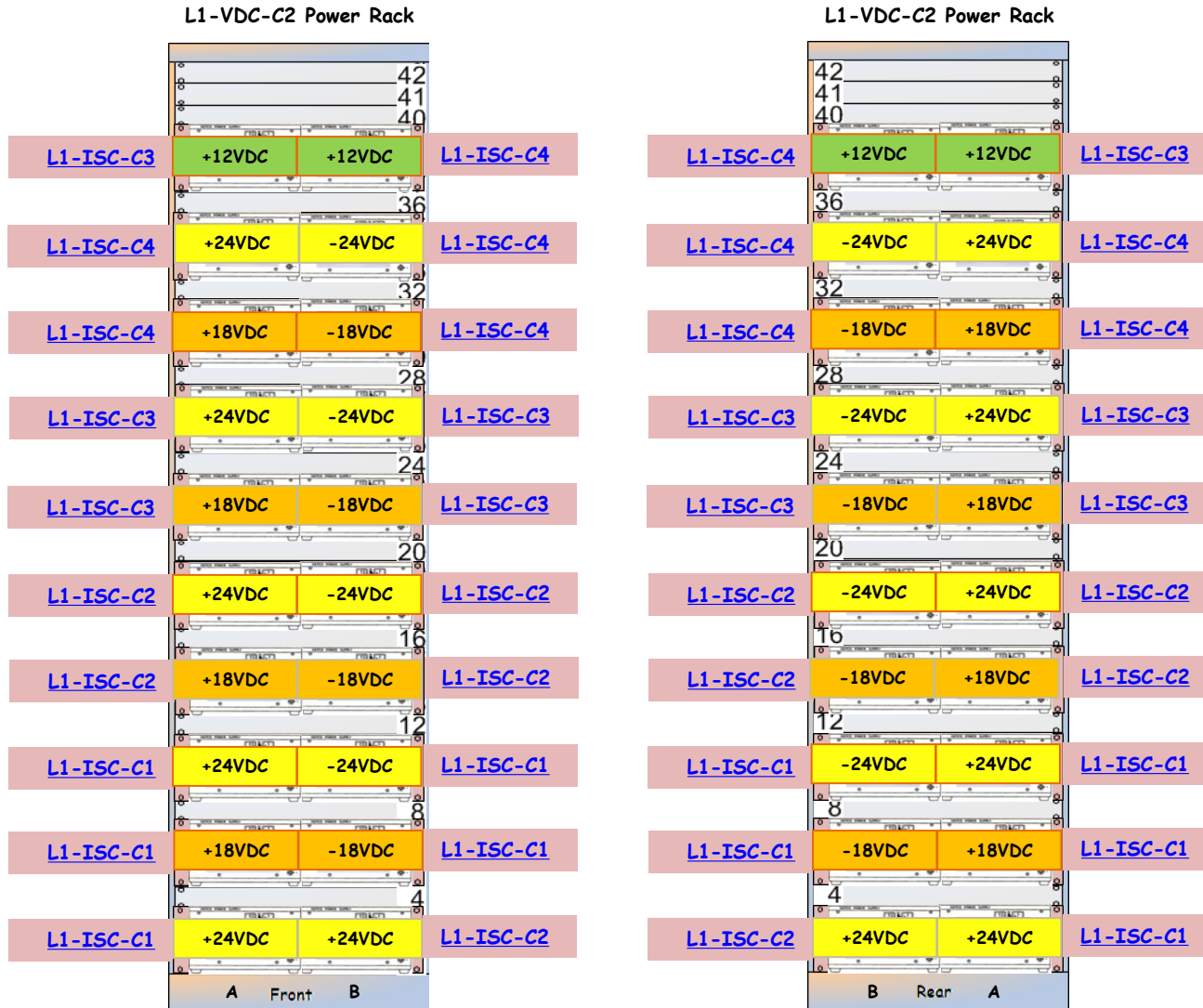

L1-VDC-C2 Cable Runs

<< [L1-VDC-C2](#)

L1-VDC-C2 Corner Station DC Cable Runs ([D1200891](#)) ([S1105248](#))

L1-VDC-C2 S1105248	Power Panel	Circuit	DC Power Rack	Outlet	Plug Position	Rack U	Power Supply Model	Power Supply Serial	Polarity	DC Extension Cable	Electronics Rack	DC Power Strip
1	CDS-1	15	L1-VDC-C2	08	Top	U37-A (Left)	JQE 15V 6A		Plus	PT6-002	L1-ISC-C3	PS6-003
2	CDS-1	15	L1-VDC-C2	08	Bottom	U37-B (Right)	JQE 15V 6A		Plus	PT6-003	L1-ISC-C4	PS6-004
3	CDS-1	03	L1-VDC-C2	02	Top	U33-A (Left)	JQE 25V 20A	H236408	Plus	PTY-012	L1-ISC-C4	
4	CDS-1	03	L1-VDC-C2	02	Bottom	U33-B (Right)	JQE 25V 20A	H236466	Minus	PTY-012	L1-ISC-C4	
5	CDS-1	17	L1-VDC-C2	09	Top	U29-A (Left)	JQE 25V 20A	H236426	Plus	PTO-057	L1-ISC-C4	
6	CDS-1	17	L1-VDC-C2	09	Bottom	U29-B (Right)	JQE 25V 20A	H236439	Minus	PTO-057	L1-ISC-C4	
7	CDS-1	05	L1-VDC-C2	03	Top	U25-A (Left)	JQE 25V 20A	H236437	Plus	PTY-011	L1-ISC-C3	
8	CDS-1	05	L1-VDC-C2	03	Bottom	U25-B (Right)	JQE 25V 20A	H236425	Minus	PTY-011	L1-ISC-C3	
9	CDS-1	19	L1-VDC-C2	10	Top	U21-A (Left)	JQE 25V 20A	H236444	Plus	PTO-056	L1-ISC-C3	
10	CDS-1	19	L1-VDC-C2	10	Bottom	U21-B (Right)	JQE 25V 20A	H236471	Minus	PTO-056	L1-ISC-C3	
11	CDS-1	07	L1-VDC-C2	04	Top	U17-A (Left)	JQE 25V 20A	H236431	Plus	PTY-047	L1-ISC-C2	
12	CDS-1	07	L1-VDC-C2	04	Bottom	U17-B (Right)	JQE 25V 20A	H236470	Minus	PTY-047	L1-ISC-C2	
13	CDS-1	21	L1-VDC-C2	11	Top	U13-A (Left)	JQE 25V 20A	H236430	Plus	PTO-055	L1-ISC-C2	
14	CDS-1	21	L1-VDC-C2	11	Bottom	U13-B (Right)	JQE 25V 20A	H236445	Minus	PTO-055	L1-ISC-C2	
15	CDS-1	09	L1-VDC-C2	05	Top	U09-A (Left)	JQE 25V 20A		Plus	PTY-046	L1-ISC-C1	
16	CDS-1	09	L1-VDC-C2	05	Bottom	U09-B (Right)	JQE 25V 20A		Minus	PTY-046	L1-ISC-C1	
17	CDS-1	23	L1-VDC-C2	12	Top	U05-A (Left)	JQE 25V 20A	H236475	Plus	PTO-054	L1-ISC-C1	
18	CDS-1	23	L1-VDC-C2	12	Bottom	U05-B (Right)	JQE 25V 20A	H236455	Minus	PTO-054	L1-ISC-C1	
19	CDS-1	06	L1-VDC-C2	06	Top	U01-A (Left)	JQE 25V 20A	H236399	Plus	L1-TB02	L1-ISC-C1	
20	CDS-1	06	L1-VDC-C2	06	Bottom	U01-B (Right)	JQE 25V 20A	H236407	Plus	L1-TB07	L1-ISC-C2	
D1200891												

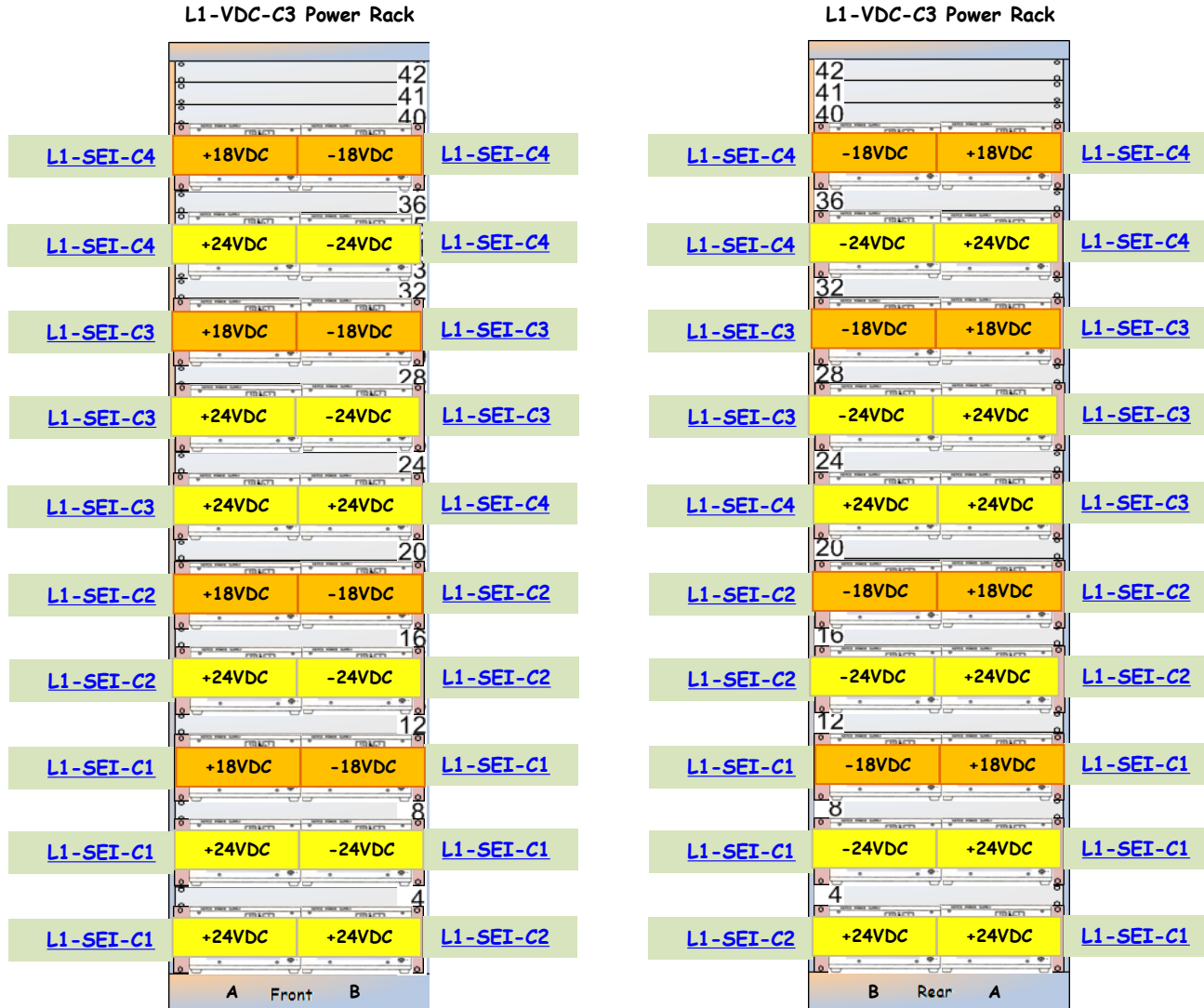

L1-VDC-C3 Cable Runs

<< [L1-VDC-C3](#)

L1-VDC-C3 Corner Station DC Cable Runs ([D1200892](#)) ([S1105249](#))

L1-VDC-C3 S1105249	Power Panel	Circuit	DC Power Rack	Outlet	Plug Position	Rack U	Power Supply Model	Power Supply Serial	Polarity	DC Extension Cable	Electronics Rack	DC Power Strip
1	CDS-2	15	L1-VDC-C3	08	Top	U37-A (Left)	JQE 25V 20A	H236457	Plus	PTO-014	L1-SEI-C4	PSO-014
2	CDS-2	15	L1-VDC-C3	08	Bottom	U37-B (Right)	JQE 25V 20A	H236456	Minus	PTO-014	L1-SEI-C4	PSO-014
3	CDS-2	03	L1-VDC-C3	02	Top	U33-A (Left)	JQE 25V 20A	H236450	Plus	PTY-013	L1-SEI-C4	PSY-013
4	CDS-2	03	L1-VDC-C3	02	Bottom	U33-B (Right)	JQE 25V 20A	H236454	Minus	PTY-013	L1-SEI-C4	PSY-013
5	CDS-2	17	L1-VDC-C3	09	Top	U29-A (Left)	JQE 25V 20A	H236452	Plus	PTO-015	L1-SEI-C3	PSO-015
6	CDS-2	17	L1-VDC-C3	09	Bottom	U29-B (Right)	JQE 25V 20A	H236451	Minus	PTO-015	L1-SEI-C3	PSO-015
7	CDS-2	05	L1-VDC-C3	03	Top	U25-A (Left)	JQE 25V 20A	H236458	Plus	PTY-014	L1-SEI-C3	PSY-014
8	CDS-2	05	L1-VDC-C3	03	Bottom	U25-B (Right)	JQE 25V 20A	H236432	Minus	PTY-014	L1-SEI-C3	PSY-014
9	CDS-2	19	L1-VDC-C3	10	Top	U21-A (Left)	JQE 25V 20A	H236435	Plus	PTY-015	L1-SEI-C3	PSY-015
10	CDS-2	19	L1-VDC-C3	10	Bottom	U21-B (Right)	JQE 25V 20A	H236436	Plus	PTY-016	L1-SEI-C4	PSY-016
11	CDS-2	07	L1-VDC-C3	04	Top	U17-A (Left)	JQE 25V 20A	H236402	Plus	PTO-016	L1-SEI-C2	PSO-016
12	CDS-2	07	L1-VDC-C3	04	Bottom	U17-B (Right)	JQE 25V 20A	H236477	Minus	PTO-016	L1-SEI-C2	PSO-016
13	CDS-2	21	L1-VDC-C3	11	Top	U13-A (Left)	JQE 25V 20A	H236384	Plus	PTY-017	L1-SEI-C2	PSY-017
14	CDS-2	21	L1-VDC-C3	11	Bottom	U13-B (Right)	JQE 25V 20A	H236390	Minus	PTY-017	L1-SEI-C2	PSY-017
15	CDS-2	09	L1-VDC-C3	05	Top	U09-A (Left)	JQE 25V 20A	H236383	Plus	PTO-017	L1-SEI-C1	PSO-017
16	CDS-2	09	L1-VDC-C3	05	Bottom	U09-B (Right)	JQE 25V 20A	H236391	Minus	PTO-017	L1-SEI-C1	PSO-017
17	CDS-2	23	L1-VDC-C3	12	Top	U05-A (Left)	JQE 25V 20A	H236372-R2	Plus	PTY-018	L1-SEI-C1	PSY-018
18	CDS-2	23	L1-VDC-C3	12	Bottom	U05-B (Right)	JQE 25V 20A	H236377	Minus	PTY-018	L1-SEI-C1	PSY-018
19	CDS-2	11	L1-VDC-C3	06	Top	U01-A (Left)	JQE 25V 20A	H236401	Plus	PTY-019	L1-SEI-C1	PSY-019
20	CDS-2	11	L1-VDC-C3	06	Bottom	U01-B (Right)	JQE 25V 20A	H236392	Plus	PTY-020	L1-SEI-C2	PSY-020
D1200892												



L1-VDC-C4 Cable Runs

<< [L1-VDC-C4](#)

L1-VDC-C4 Corner Station DC Cable Runs ([D1200893](#)) ([S1105250](#))

L1-VDC-C4 S1105250	Power Panel	Circuit	DC Power Rack	Outlet	Plug Position	Rack U	Power Supply Model	Power Supply Serial	Polarity	DC Extension Cable	Electronics Rack	DC Power Strip
1	CDS-2	26	L1-VDC-C4	08	Top	U37-A (Left)	JQE 25V 20A	H236442	Plus	PTO-018	L1-PSL-C1	PSO-018
2	CDS-2	26	L1-VDC-C4	08	Bottom	U37-B (Right)	JQE 25V 20A	H236416	Minus	PTO-018	L1-PSL-C1	PSO-018
3	CDS-2	14	L1-VDC-C4	02	Top	U33-A (Left)	JQE 25V 20A	H236449				
4	CDS-2	14	L1-VDC-C4	02	Bottom	U33-B (Right)	JQE 25V 20A	H236453	Plus	PTY-009	L1-PSL-C1	PSY-009
5	CDS-2	28	L1-VDC-C4	09	Top	U29-A (Left)	JQE 25V 20A	H236495	Plus	PTY-002	L1-SUS-C5A	None
6	CDS-2	28	L1-VDC-C4	09	Bottom	U29-B (Right)	JQE 25V 20A	H236375	Plus	PTY-005	L1-SUS-C3A	PSY-027
7	CDS-2	16	L1-VDC-C4	03	Top	U25-A (Left)	JQE 25V 20A	H210621	Plus	L1-TB03	L1-SUS-C2	PSY-004
8	CDS-2	16	L1-VDC-C4	03	Bottom	U25-B (Right)	JQE 25V 20A	H210620	Plus	L1-TB04	L1-SUS-C3B	PSY-005
9	CDS-2	30	L1-VDC-C4	10	Top	U21-A (Left)	JQE 25V 20A	H210618	Plus	L1-TB01	L1-SUS-C5B	PSY-002
10	CDS-2	30	L1-VDC-C4	10	Bottom	U21-B (Right)	JQE 25V 20A	H236386	Plus	PTY-001	L1-SUS-C8	PSY-001
11	CDS-2	18	L1-VDC-C4	04	Top	U17-A (Left)	JQE 25V 20A	H236374	Plus	PTO-019	L1-SEI-C6	PSO-019
12	CDS-2	18	L1-VDC-C4	04	Bottom	U17-B (Right)	JQE 25V 20A	H236382	Minus	PTO-019	L1-SEI-C6	PSO-019
13	CDS-2	32	L1-VDC-C4	11	Top	U13-A (Left)	JQE 25V 20A	H236373	Plus	PTY-021	L1-SEI-C6	PSY-021
14	CDS-2	32	L1-VDC-C4	11	Bottom	U13-B (Right)	JQE 25V 20A	H236387	Minus	PTY-021	L1-SEI-C6	PSY-021
15	CDS-2	20	L1-VDC-C4	05	Top	U09-A (Left)	JQE 25V 20A	H236376	Plus	PTO-020	L1-SEI-C5	PSO-020
16	CDS-2	20	L1-VDC-C4	05	Bottom	U09-B (Right)	JQE 25V 20A	H236379	Minus	PTO-020	L1-SEI-C5	PSO-020
17	CDS-2	34	L1-VDC-C4	12	Top	U05-A (Left)	JQE 25V 20A	H236381	Plus	PTY-022	L1-SEI-C5	PSY-022
18	CDS-2	34	L1-VDC-C4	12	Bottom	U05-B (Right)	JQE 25V 20A	H236385	Minus	PTY-022	L1-SEI-C5	PSY-022
19	CDS-2	22	L1-VDC-C4	06	Top	U01-A (Left)	JQE 25V 20A	H236415	Plus	PTY-023	L1-SEI-C5	PSY-023
20	CDS-2	22	L1-VDC-C4	06	Bottom	U01-B (Right)	JQE 25V 20A	H236403	Plus	PTY-024	L1-SEI-C6	PSY-024
D1200893												



L1-VDC-C5 Cable Runs

<< [L1-VDC-C5](#)

L1-VDC-C5 Corner Station DC Cable Runs ([D1200894](#)) ([S1105251](#))

L1-VDC-C5 S1105251	Power Panel	Circuit	DC Power Rack	Outlet	Plug Position	Rack U	Power Supply Model	Power Supply Serial	Polarity	DC Extension Cable	Electronics Rack	DC Power Strip
1	CDS-1	25	L1-VDC-C5	08	Top	U37-A (Left)						
2	CDS-1	25	L1-VDC-C5	08	Bottom	U37-B (Right)						
3	CDS-2	13	L1-VDC-C5	02	Top	U33-A (Left)						
4	CDS-2	13	L1-VDC-C5	02	Bottom	U33-B (Right)						
5	CDS-1	13	L1-VDC-C5	09	Top	U29-A (Left)						
6	CDS-1	13	L1-VDC-C5	09	Bottom	U29-B (Right)						
7	CDS-2	38	L1-VDC-C5	03	Top	U25-A (Left)						
8	CDS-2	38	L1-VDC-C5	03	Bottom	U25-B (Right)						
9	CDS-1	01	L1-VDC-C5	10	Top	U21-A (Left)	JQE 25V 20A	H236420	Plus	PTO-027 PTO-028 PTO-030	L1-SUS-R3 L1-SUS-R5 L1-SUS-R6	
10	CDS-1	01	L1-VDC-C5	10	Bottom	U21-B (Right)	JQE 25V 20A	H236378	Minus	PTO-027 PTO-028 PTO-030	L1-SUS-R3 L1-SUS-R5 L1-SUS-R6	
11	CDS-2	12	L1-VDC-C5	04	Top	U17-A (Left)	JQE 25V 20A	H236409	Plus	PTO-023 PTO-024	L1-SUS-R1 L1-SUS-R2	
12	CDS-2	12	L1-VDC-C5	04	Bottom	U17-B (Right)	JQE 25V 20A	H236410	Minus	PTO-023 PTO-024	L1-SUS-R1 L1-SUS-R2	
13	CDS-1	04	L1-VDC-C5	11	Top	U13-A (Left)	JQE 25V 20A	H236380	Plus	PTO-025	L1-PSL-R2	PSO-025
14	CDS-1	04	L1-VDC-C5	11	Bottom	U13-B (Right)	JQE 25V 20A	H236465	Minus	PTO-025	L1-PSL-R2	PSO-025
15	CDS-2	24	L1-VDC-C5	05	Top	U09-A (Left)	JQE 25V 20A	H236459	Plus	PTY-025	L1-PSL-R2	PSY-025
16	CDS-2	24	L1-VDC-C5	05	Bottom	U09-B (Right)	JQE 25V 20A	H236394	Minus	PTY-025	L1-PSL-R2	PSY-025
17	CDS-2	01	L1-VDC-C5	12	Top	U05-A (Left)	JQE 25V 20A	H236397	Plus	PTO-026	L1-PSL-R1	PSO-026
18	CDS-2	01	L1-VDC-C5	12	Bottom	U05-B (Right)	JQE 25V 20A	H236400	Minus	PTO-026	L1-PSL-R1	PSO-026
19	CDS-2	36	L1-VDC-C5	06	Top	U01-A (Left)	JQE 25V 20A	H236393	Plus	L1-TB05	L1-PSL-R1	PSY-026
20	CDS-2	36	L1-VDC-C5	06	Bottom	U01-B (Right)	JQE 25V 20A	H236398	Minus	L1-TB05	L1-PSL-R1	PSY-026
D1200894												

L1-VDC-C6 Power Racks - Required Supplies

<< CPR

L1-VDC-C6 Corner Station DC Power Rack Layout ([D1200895](#)) ([S1105252](#))

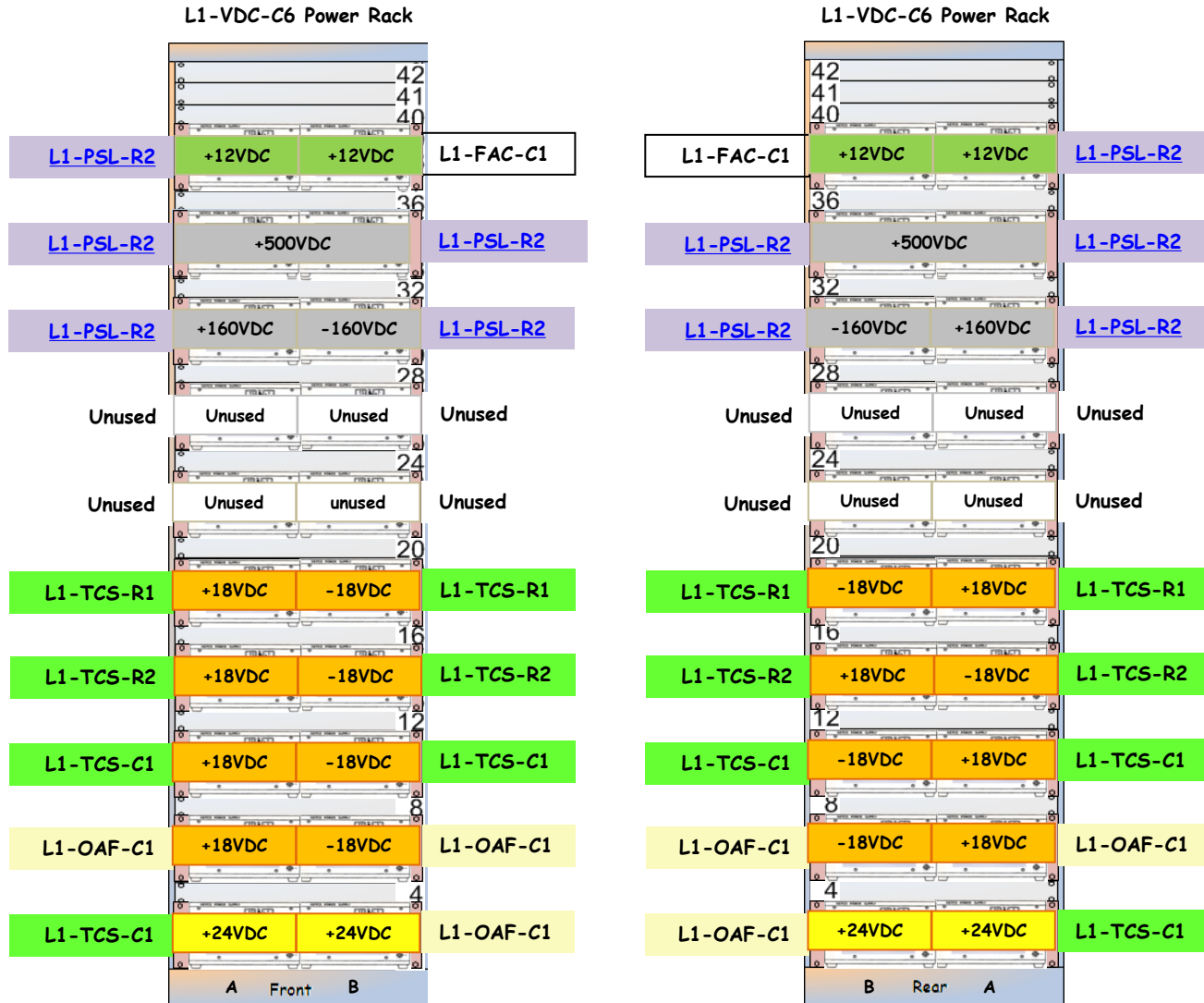

[Cable Runs >>](#)

L1-VDC-C6 Cable Runs

<< [L1-VDC-C6](#)

L1-VDC-C6 Corner Station DC Cable Runs ([D1200895](#)) ([S1105252](#))

L1-VDC-C6 S1105252	Power Panel	Circuit	DC Power Rack	Outlet	Plug Position	Rack U	Power Supply Model	Power Supply Serial	Polarity	DC Extension Cable	Electronics Rack	DC Power Strip
1	CDS-2	37	L1-VDC-C6	08	Top	U37-A (Left)	JQE 15V 6A		Plus	PTB-001	L1-PSL-R2	PSG-002
2	CDS-2	37	L1-VDC-C6	08	Bottom	U37-B (Right)	JQE 15V 6A		Plus	PTG-001	L1-FAC-C1	PSG-001
3	CDS-2	31	L1-VDC-C6	02	Top	U33-A (Left)	BHK 500V 0.4A	C72508	Plus	PBX-001	L1-PSL-R2	
4	CDS-2	31	L1-VDC-C6	02	Bottom	U33-B (Right)	BHK 500V 0.4A	C72508	Plus	PBX-001	L1-PSL-R2	
5	CDS-2	27	L1-VDC-C6	09	Top	U29-A (Left)	PCX 200V 0.1A		Plus	PBX-002	L1-PSL-R2	
6	CDS-2	27	L1-VDC-C6	09	Bottom	U29-B (Right)	PCX 200V 0.1A		Minus	PBX-002	L1-PSL-R2	
7	CDS-2	08	L1-VDC-C6	03	Top	U25-A (Left)	BHK 500V 80mA	A107262	Plus	Spare		
8	CDS-2	08	L1-VDC-C6	03	Bottom	U25-B (Right)	BHK 500V 80mA	A107265	Minus	Spare		
9	CDS-2	39	L1-VDC-C6	10	Top	U21-A (Left)	JQE 25V 10A	H222053				
10	CDS-2	39	L1-VDC-C6	10	Bottom	U21-B (Right)	JQE 25V 10A	H207953				
11	CDS-2	33	L1-VDC-C6	04	Top	U17-A (Left)	JQE 25V 10A	H222050	Plus	PTO-038	L1-TCS-R1	
12	CDS-2	33	L1-VDC-C6	04	Bottom	U17-B (Right)	JQE 25V 10A	H222056	Minus	PTO-038	L1-TCS-R1	
13	CDS-2	29	L1-VDC-C6	11	Top	U13-A (Left)	JQE 25V 10A	H222052	Plus	PTO-037	L1-TCS-R2	
14	CDS-2	29	L1-VDC-C6	11	Bottom	U13-B (Right)	JQE 25V 10A	H192369	Minus	PTO-037	L1-TCS-R2	
15	CDS-2	10	L1-VDC-C6	05	Top	U09-A (Left)	JQE 25V 10A	H207939	Plus	PTO-013	L1-TSC-C1	
16	CDS-2	10	L1-VDC-C6	05	Bottom	U09-B (Right)	JQE 25V 10A	H207941	Minus	PTO-013	L1-TSC-C1	
17	CDS-2	41	L1-VDC-C6	12	Top	U05-A (Left)	JQE 25V 20A	H236423	Plus	PTO-012	L1-OAF-C1	
18	CDS-2	41	L1-VDC-C6	12	Bottom	U05-B (Right)	JQE 25V 20A	H236413	Minus	PTO-012	L1-OAF-C1	
19	CDS-2	35	L1-VDC-C6	06	Top	U01-A (Left)	JQE 25V 20A	H236491	Plus	PTY-055	L1-TSC-C1	
20	CDS-2	35	L1-VDC-C6	06	Bottom	U01-B (Right)	JQE 25V 20A	H236472	Plus	PTY-053	L1-OAF-C1	
D1200895												

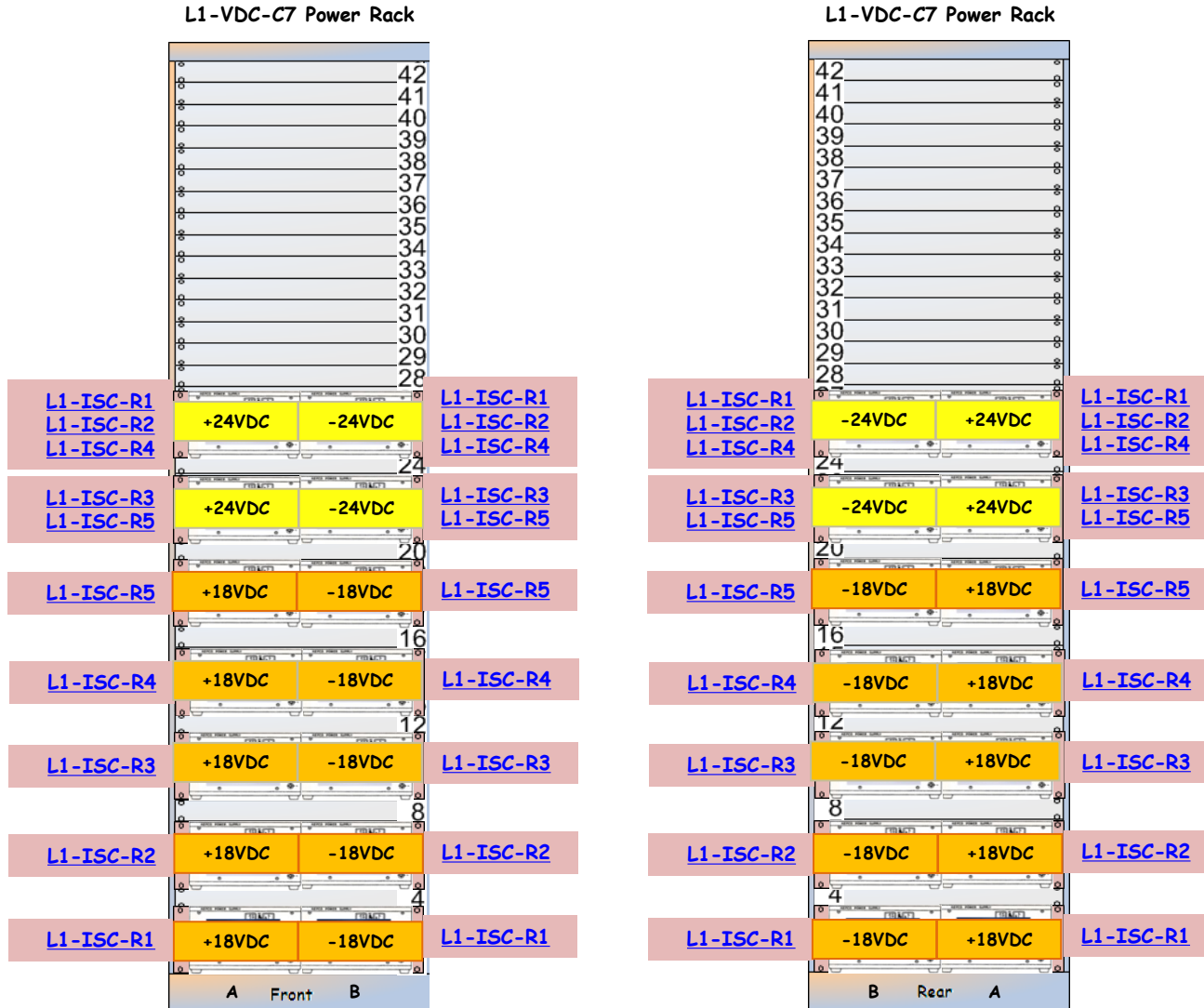

L1-VDC-C7 Cable Runs

<< [L1-VDC-C7](#)

L1-VDC-C7 Corner Station DC Cable Runs ([D1200896](#)) ([S1105253](#))

L1-VDC-C7 S1105253	Power Panel	Circuit	DC Power Rack	Outlet	Plug Position	Rack U	Power Supply Model	Power Supply Serial	Polarity	DC Extension Cable	Electronics Rack	DC Power Strip
1	CDS-1	22	L1-VDC-C5	07	Top	U37-A (Left)						
2	CDS-1	22	L1-VDC-C5	07	Bottom	U37-B (Right)						
3	CDS-1	16	L1-VDC-C5	01	Top	U33-A (Left)						
4	CDS-1	16	L1-VDC-C5	01	Bottom	U33-B (Right)						
5	CDS-1	34	L1-VDC-C7	08	Top	U29-A (Left)						
6	CDS-1	34	L1-VDC-C7	08	Bottom	U29-B (Right)						
7	CDS-1	28	L1-VDC-C7	02	Top	U25-A (Left)	JQE 25V 20A	H236405	Plus	L1-TB06 PTY-048 PTY-049	L1-ISC-R1 L1-ISC-R2 L1-ISC-R4	
8	CDS-1	28	L1-VDC-C7	02	Bottom	U25-B (Right)	JQE 25V 20A	H236411	Minus	L1-TB06 PTY-048 PTY-049	L1-ISC-R1 L1-ISC-R2 L1-ISC-R4	
9	CDS-1	24	L1-VDC-C7	09	Top	U21-A (Left)	JQE 25V 20A	H236460	Plus	PTY-050 PTY-051	L1-ISC-R3 L1-ISC-R5	
10	CDS-1	24	L1-VDC-C7	09	Bottom	U21-B (Right)	JQE 25V 20A	H236433	Minus	PTY-050 PTY-051	L1-ISC-R3 L1-ISC-R5	
11	CDS-1	18	L1-VDC-C7	03	Top	U17-A (Left)	JQE 25V 20A	H236448	Plus	PTO-061	L1-ISC-R5	
12	CDS-1	18	L1-VDC-C7	03	Bottom	U17-B (Right)	JQE 25V 20A	H236446	Minus	PTO-061	L1-ISC-R5	
13	CDS-2	02	L1-VDC-C7	10	Top	U13-A (Left)	JQE 25V 20A	H236440	Plus	PTO-060	L1-ISC-R4	
14	CDS-2	02	L1-VDC-C7	10	Bottom	U13-B (Right)	JQE 25V 20A	H236485	Minus	PTO-060	L1-ISC-R4	
15	CDS-1	30	L1-VDC-C7	04	Top	U09-A (Left)	JQE 25V 20A	H236419	Plus	PTO-059	L1-ISC-R3	
16	CDS-1	30	L1-VDC-C7	04	Bottom	U09-B (Right)	JQE 25V 20A	H236412	Minus	PTO-059	L1-ISC-R3	
17	CDS-1	26	L1-VDC-C7	11	Top	U05-A (Left)	JQE 25V 20A	H236429	Plus	PTO-059	L1-ISC-R2	
18	CDS-1	26	L1-VDC-C7	11	Bottom	U05-B (Right)	JQE 25V 20A	H236462	Minus	PTO-059	L1-ISC-R2	
19	CDS-1	20	L1-VDC-C7	05	Top	U01-A (Left)	JQE 25V 20A	H236417	Plus	PTO-058	L1-ISC-R1	
20	CDS-1	20	L1-VDC-C7	05	Bottom	U01-B (Right)	JQE 25V 20A	H236421	Minus	PTO-058	L1-ISC-R1	
D1200896												

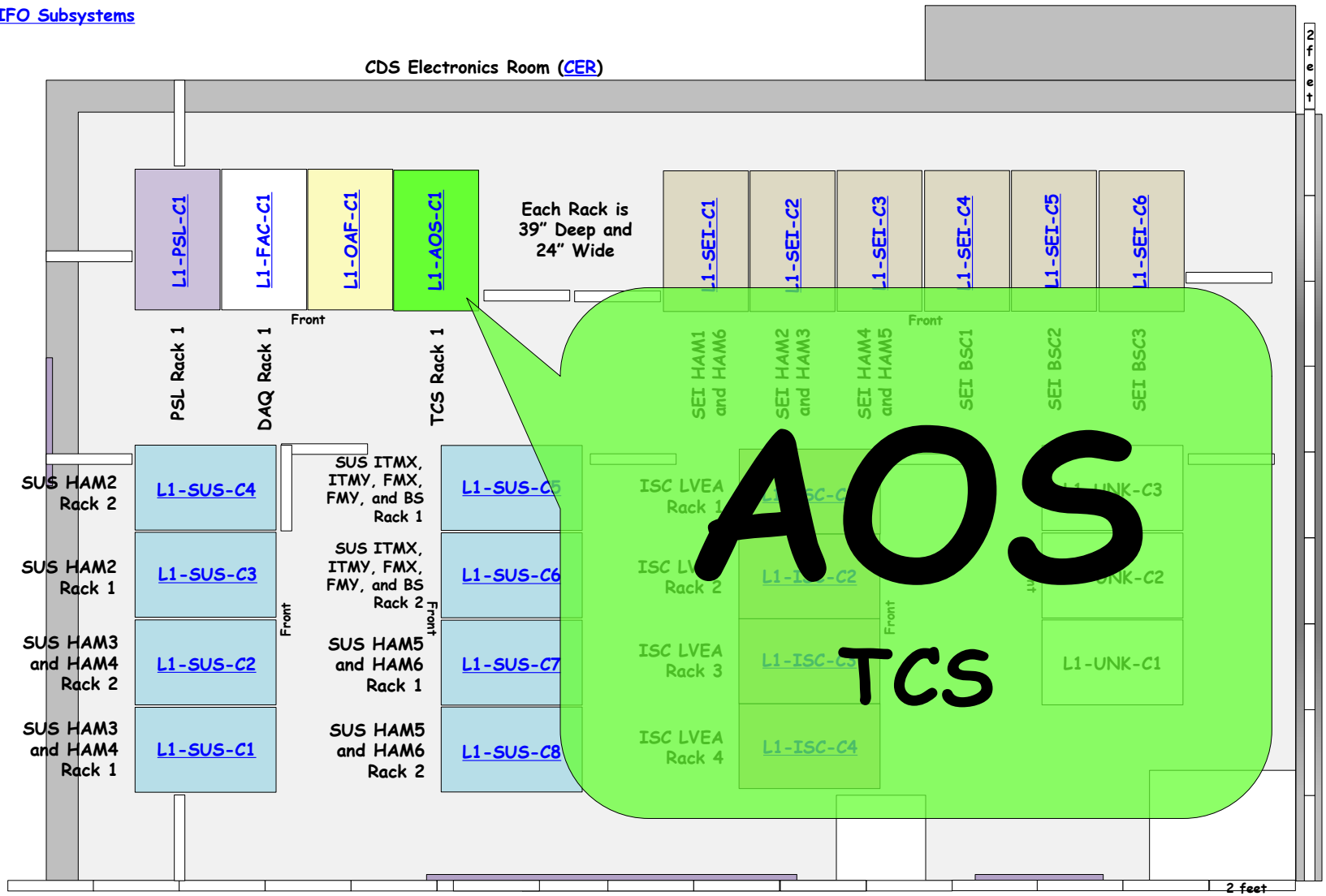

IO Diagram: [D1100909](#)

Op Lev Docs : [E1200031](#) and [T1000097](#)

[LIGO-D1200258](#)

L1-AOS-C1

AOS Rack Layout ([D1200258](#)) ([S1202974](#))

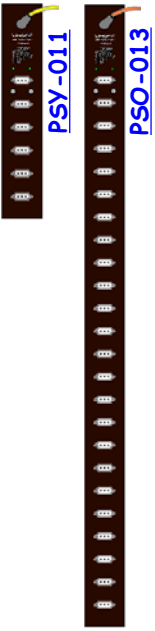
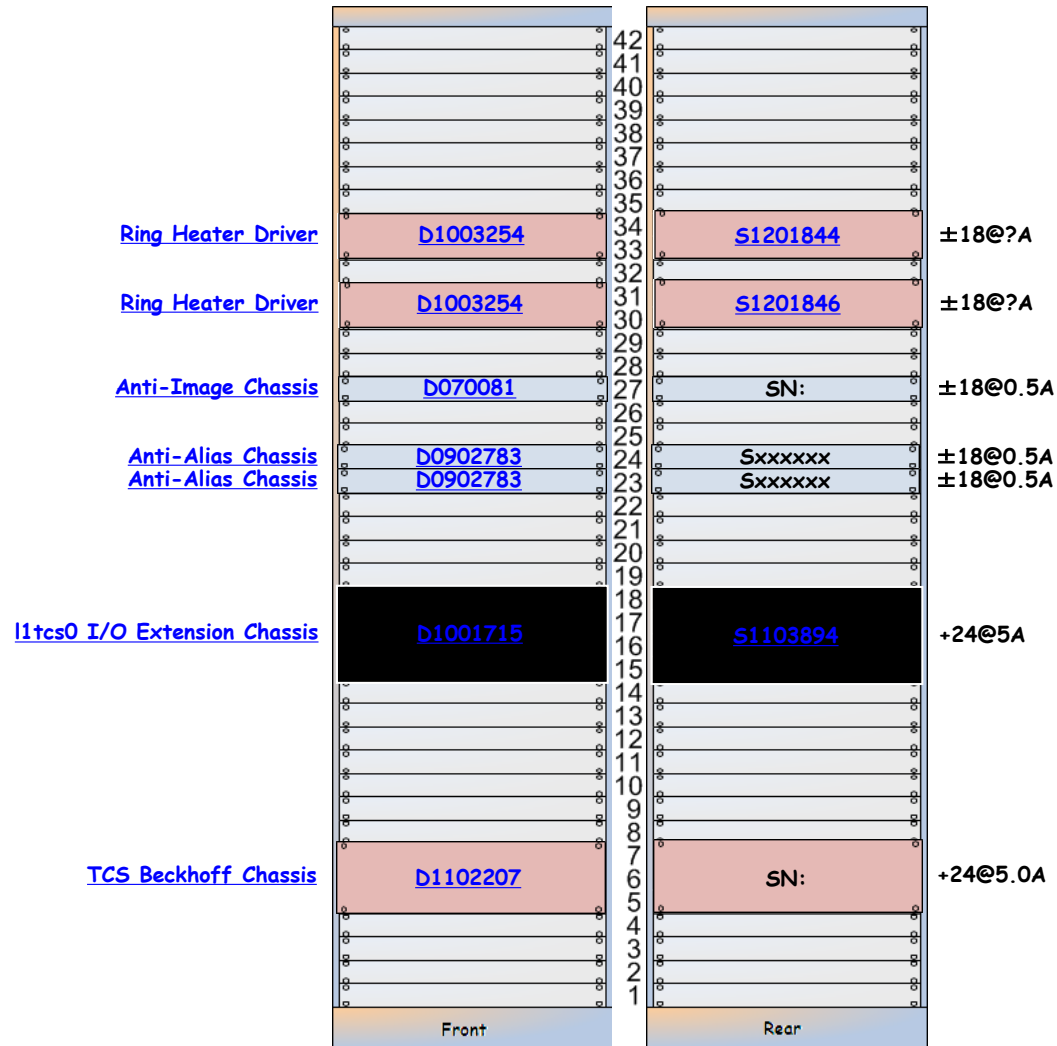

L1-AOS-C1 is part of [E1100895](#)

L1-AOS-C1 Details

Ring Heater Driver



±18@?A

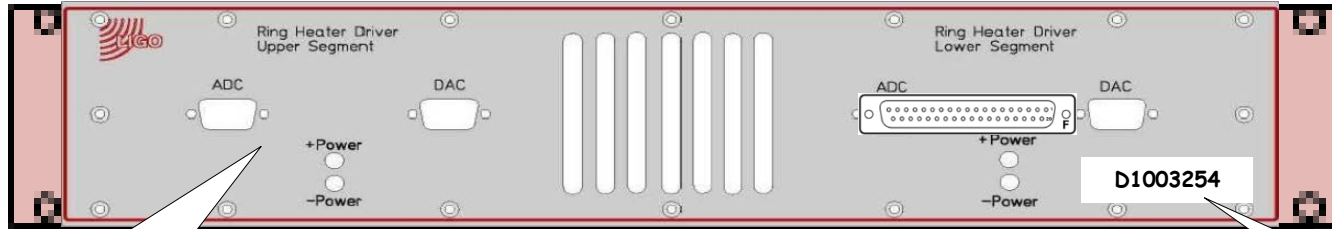

D1003254

Front

This is an early revision of the front panel. It now has one DB37M connector. 20121205 dlk

Label	Description

White label 20121205 dlk

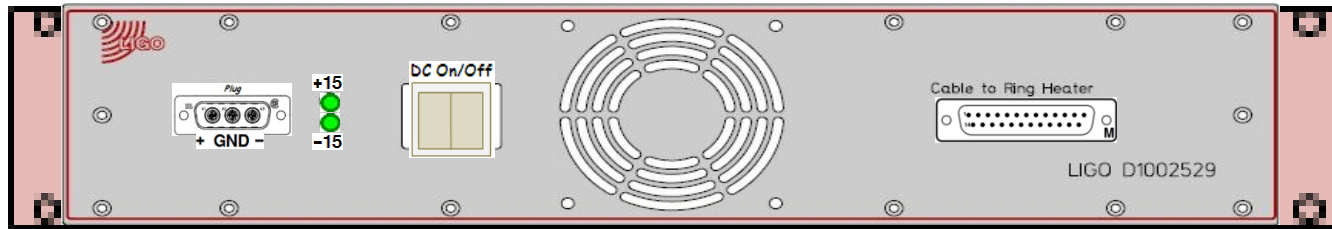

S1201844

Rear

Label	Description
	Cable to Ring Heater

Ring Heater Driver

D1003254

S1201846

±18V@?A

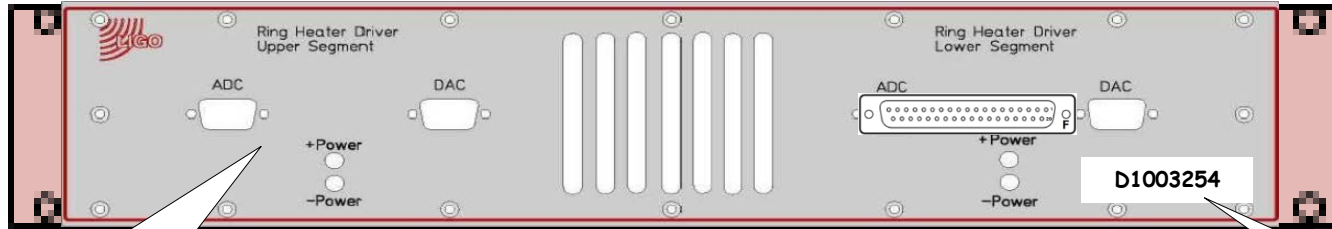

D1003254

Front

This is an early revision of the front panel. It now has one DB37M connector. 20121205 dlk

Label	Description

White label 20121205 dlk

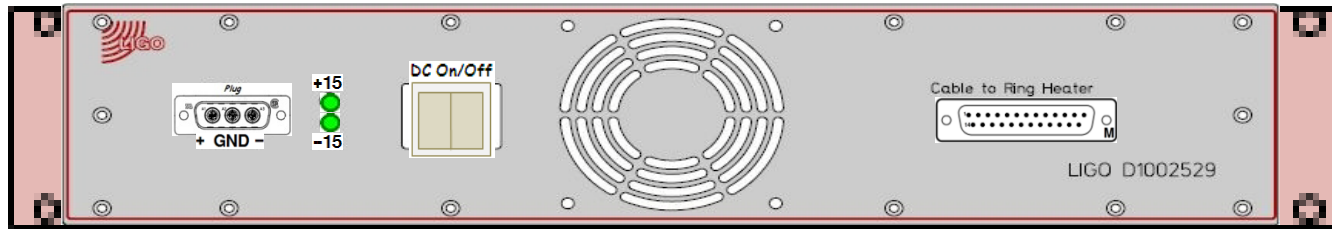

S1201846

Rear

Label	Description
	Cable to Ring Heater

Anti-Image Chassis D070081 Sxxxxxxx ±18@0.5A

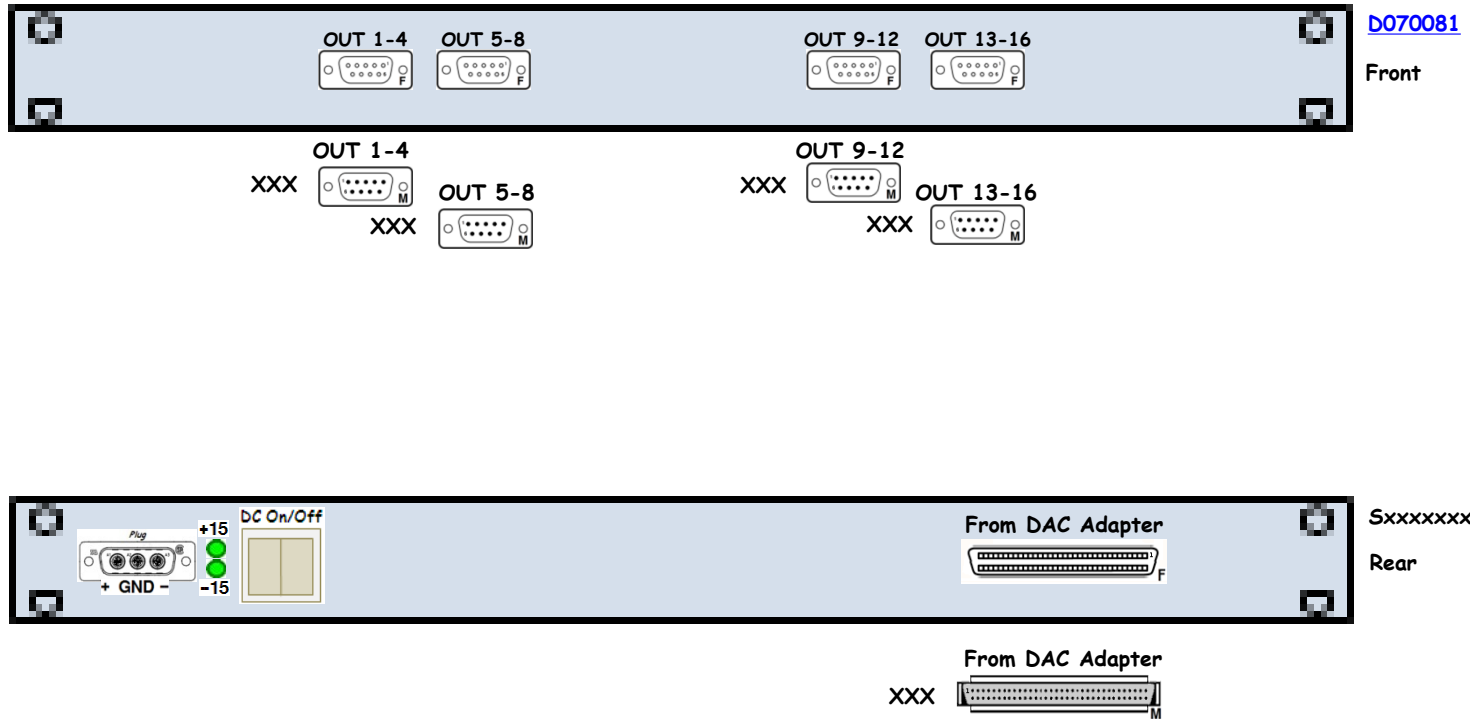

Anti-Alias Chassis D0902783 Sxxxxxxx ±18@0.5A

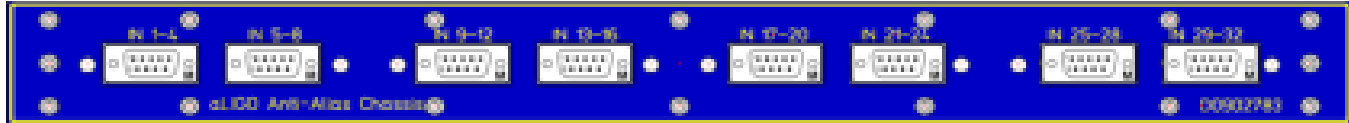

[D0902783](#)

Front

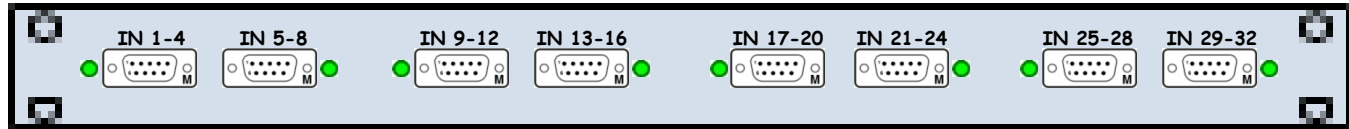

[D070081](#)

Front

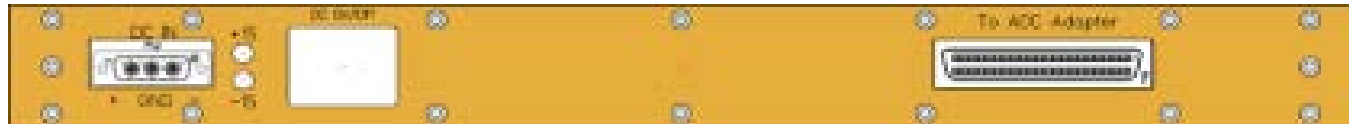
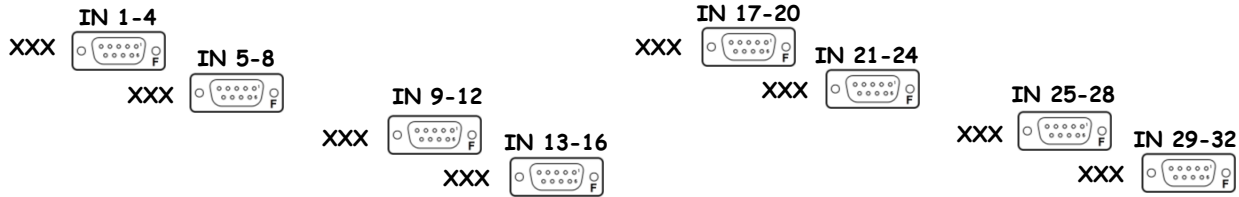

Sxxxxxxx

Rear

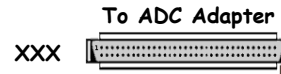
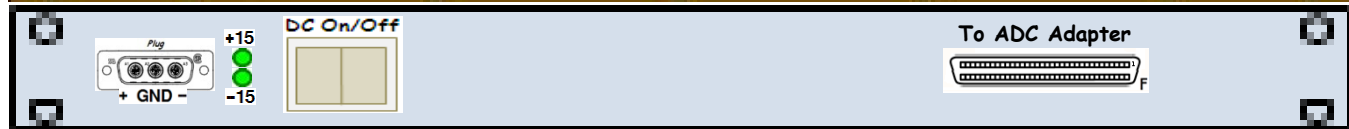

Anti-Alias Chassis D0902783 Sxxxxxxx ±18@0.5A

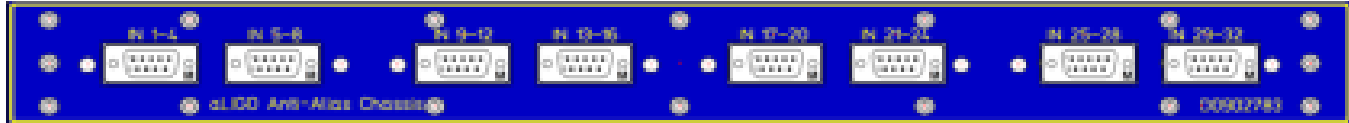

[D0902783](#)

Front

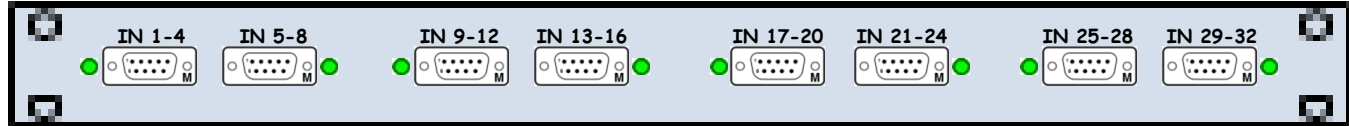

[D070081](#)

Front

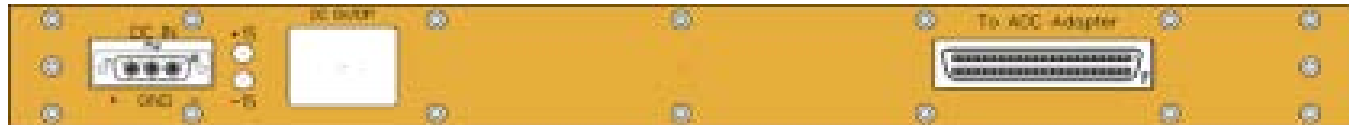
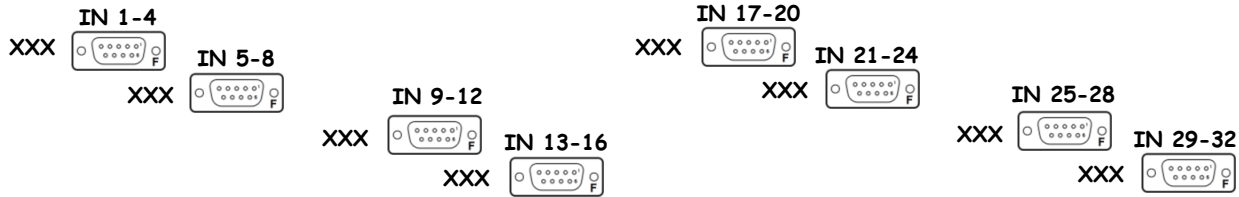

[Sxxxxxxx](#)

Rear

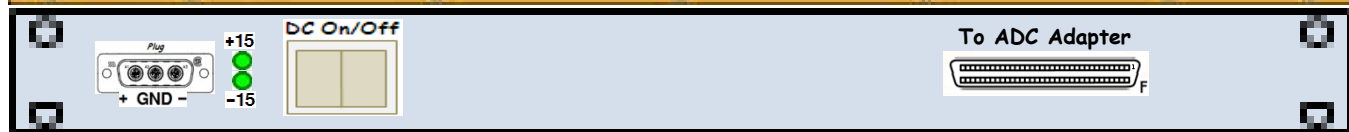

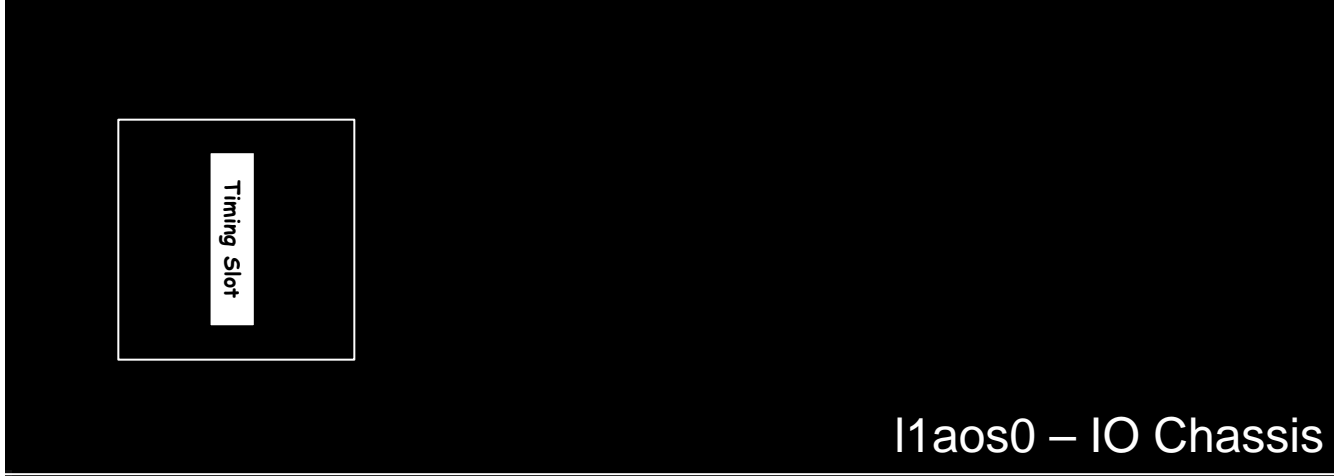

D1001715

Front

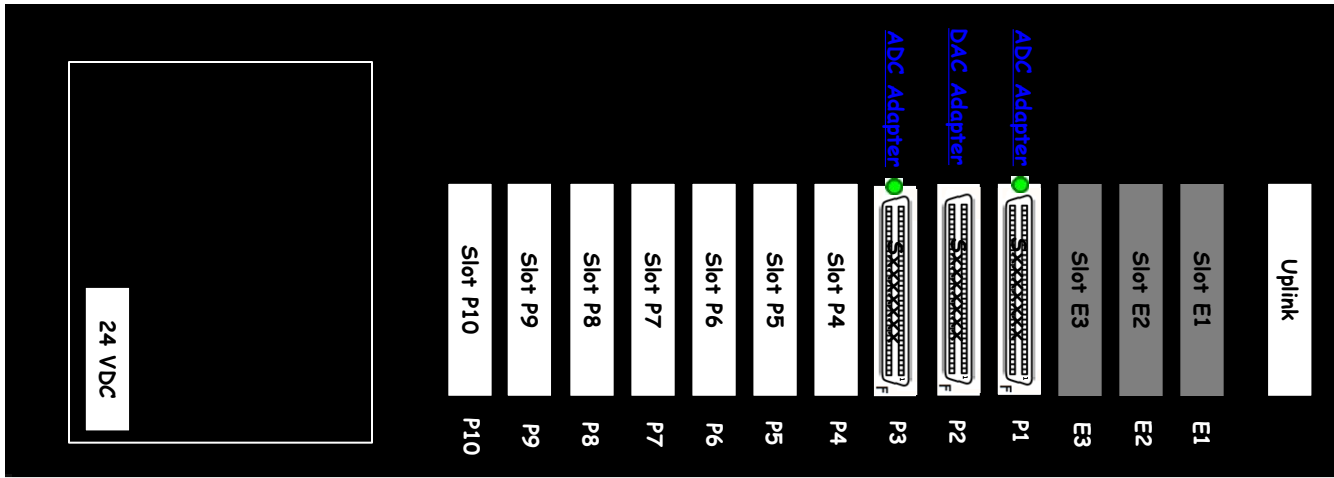

S1103894

Rear

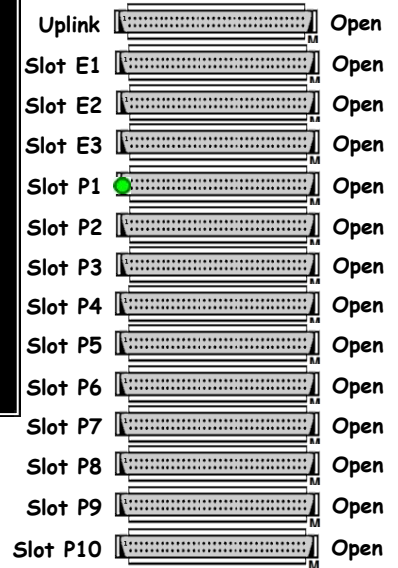

<< L1-AOS-C1

TCS Beckhoff Chassis

[D1102207](#)

SN:

+24@5.0A

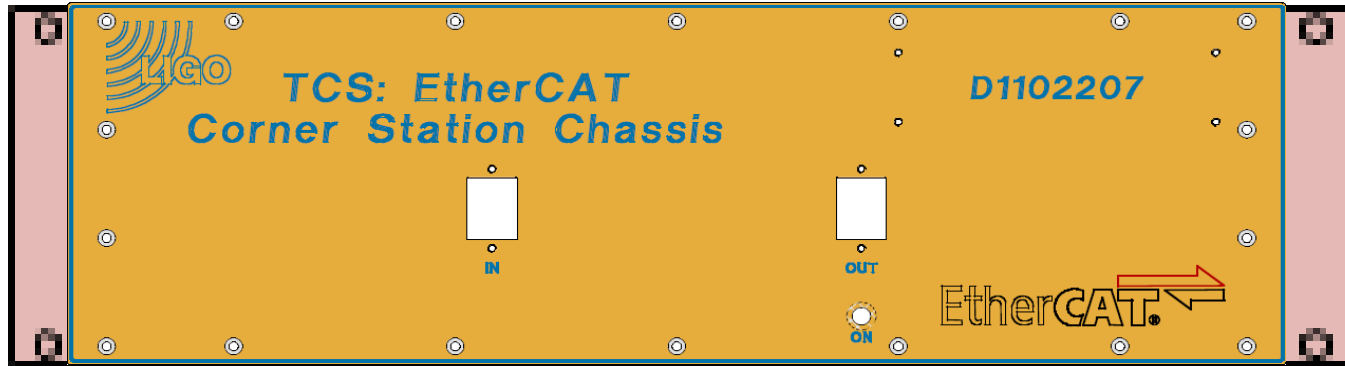

[D1102207](#)

Front

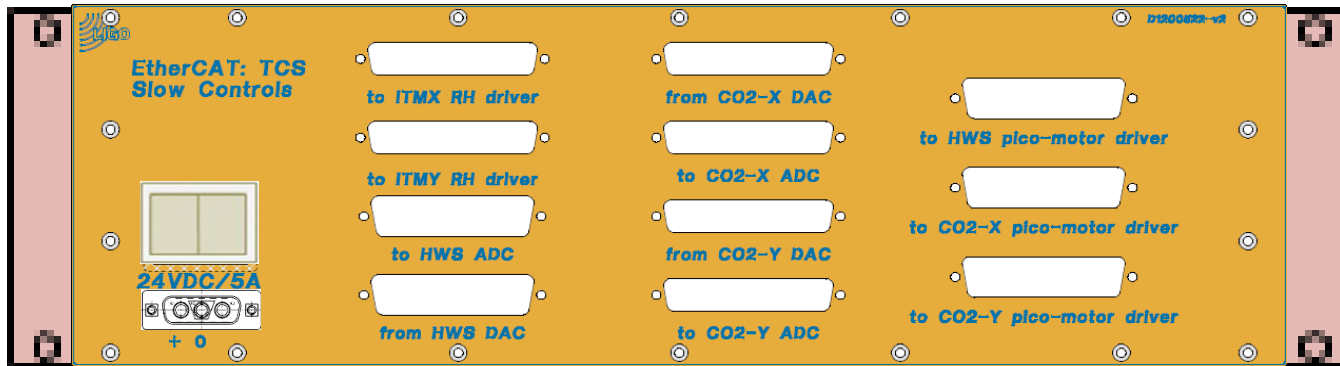

Sxxxxxx

Rear

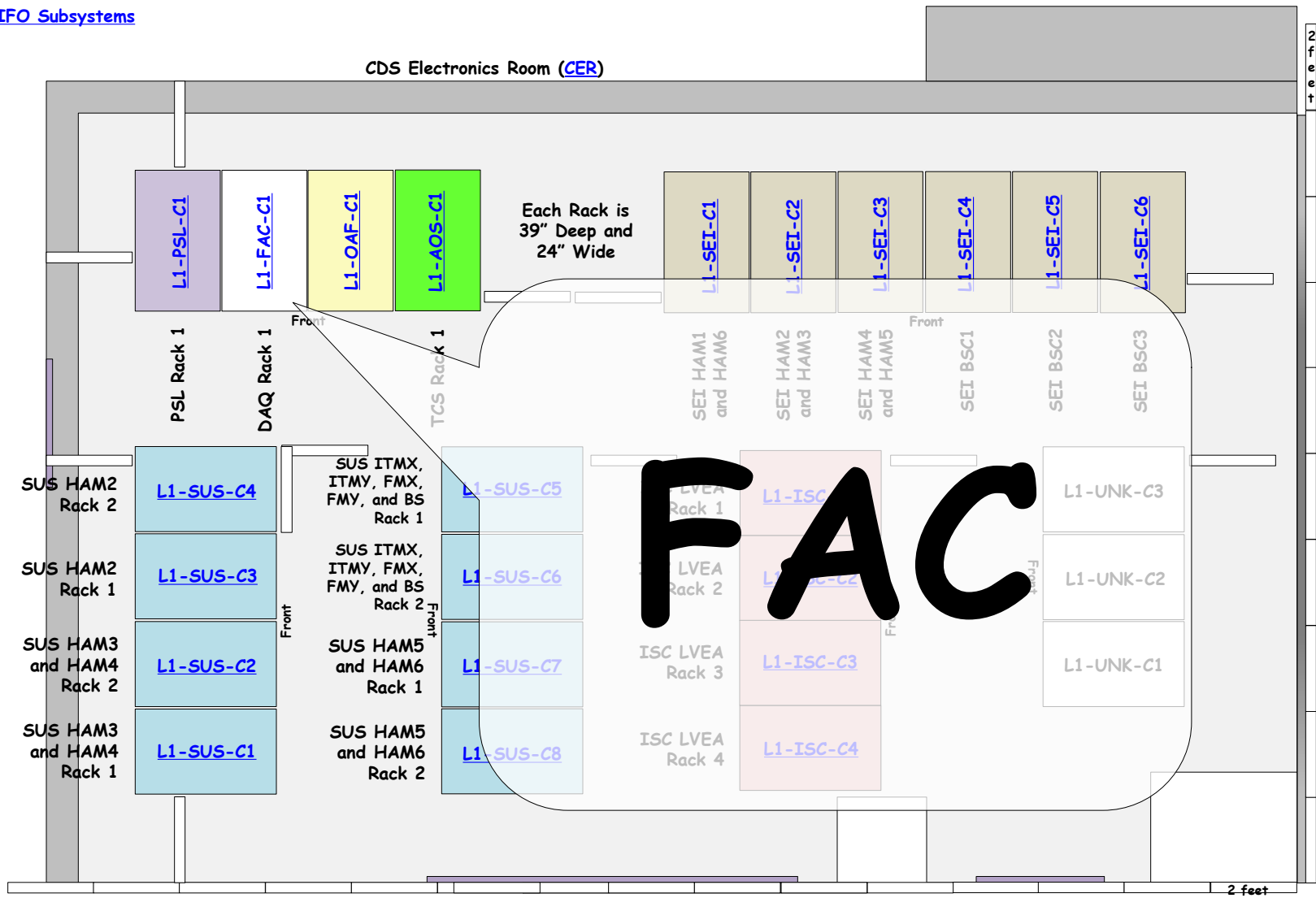

L1-FAC-C1 Rack Layout (D1200940) (S1202403)

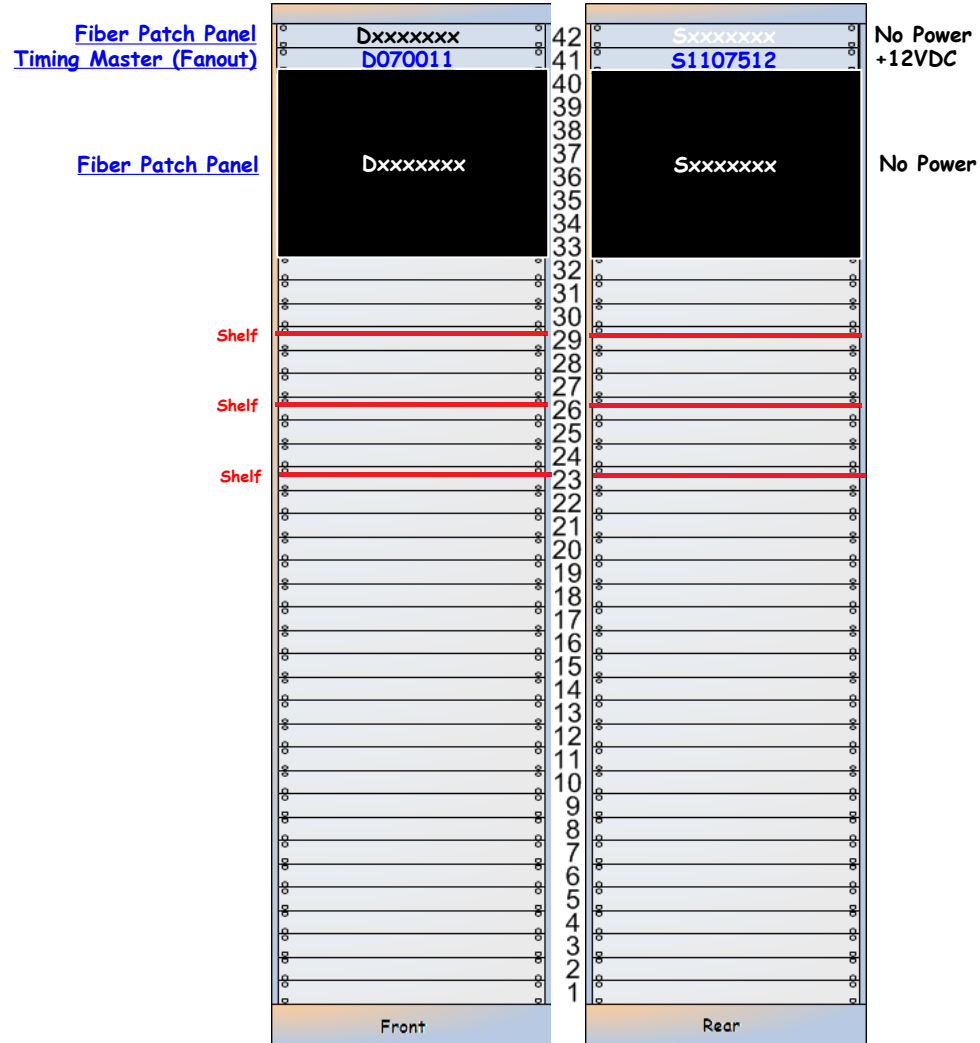

L1-FAC-C1 Details

<< [L1-FAC-C1](#)

Fiber Patch Panel No Power

Fibercables.com



[D070011](#)

Front



[S1107511](#)

Rear



Front



Rear

Fiber Patch Panel

Fiber Patch Panel

Dxxxxxxx

Sxxxxxxx

No Power

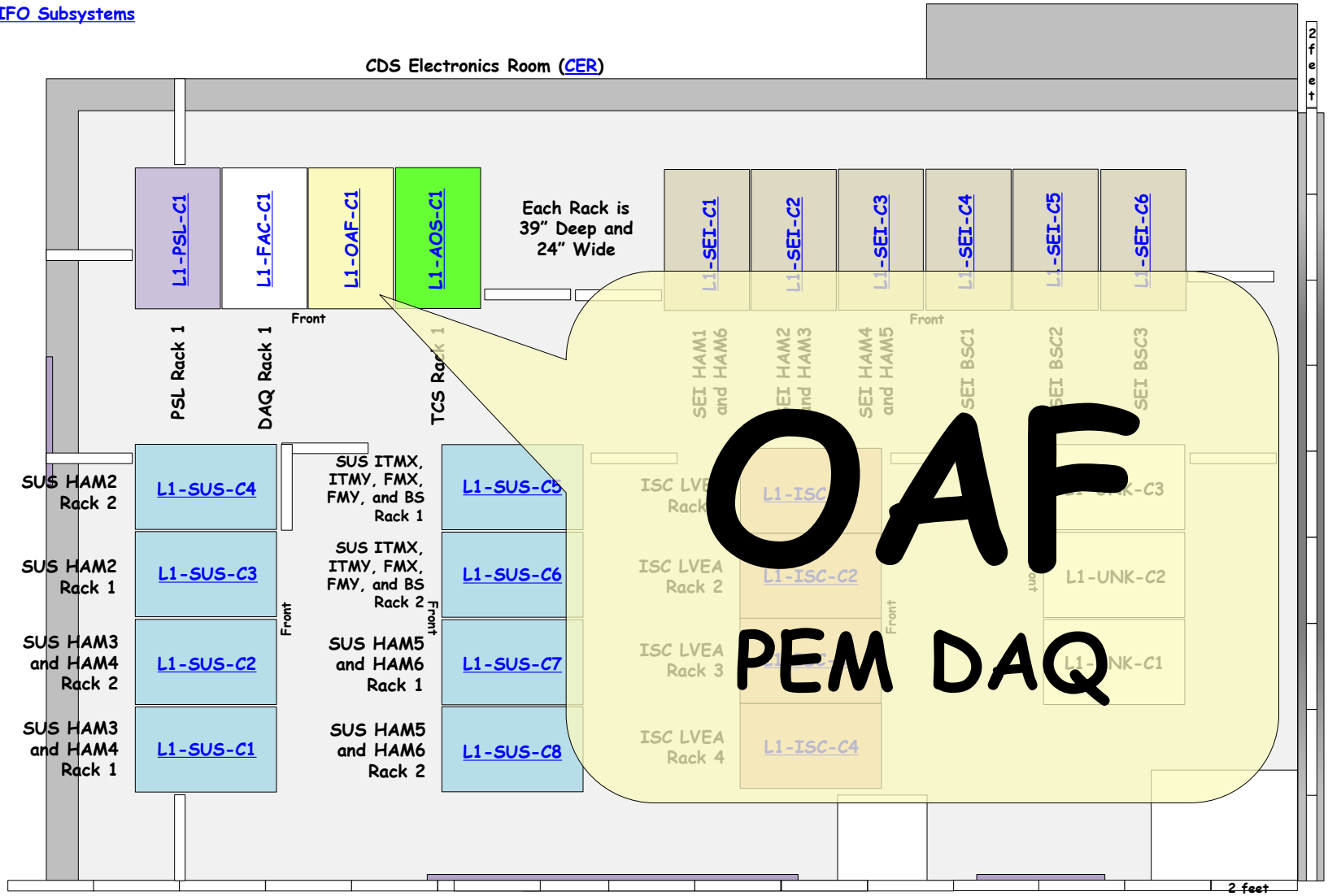

L1-OAF-C1 Rack Layout ([D1200941](#)) ([S1202404](#))

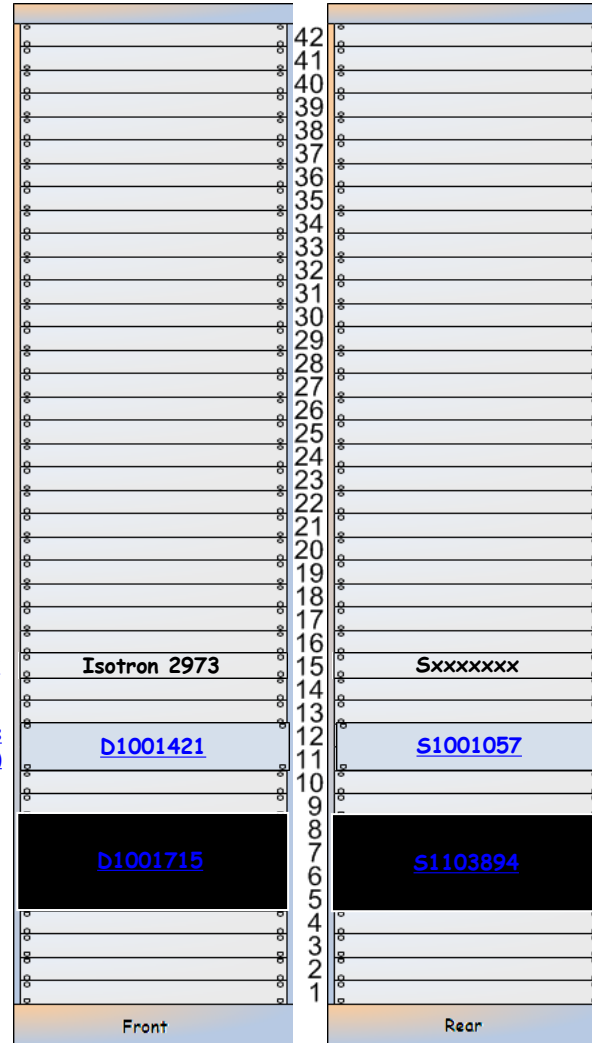

[Accelerometer Power Supply](#)

[aLIGO AA Interface Chassis
\(32 BNC x10 Gain Version\)](#)

[Iloaf0 I/O Extension Chassis](#)

+12VDC	?A
-12VDC	?A
+18VDC	?A
-18VDC	?A
+24VDC	?A
-24VDC	?A
High Voltage	?A



L1-OAF-C1 Details

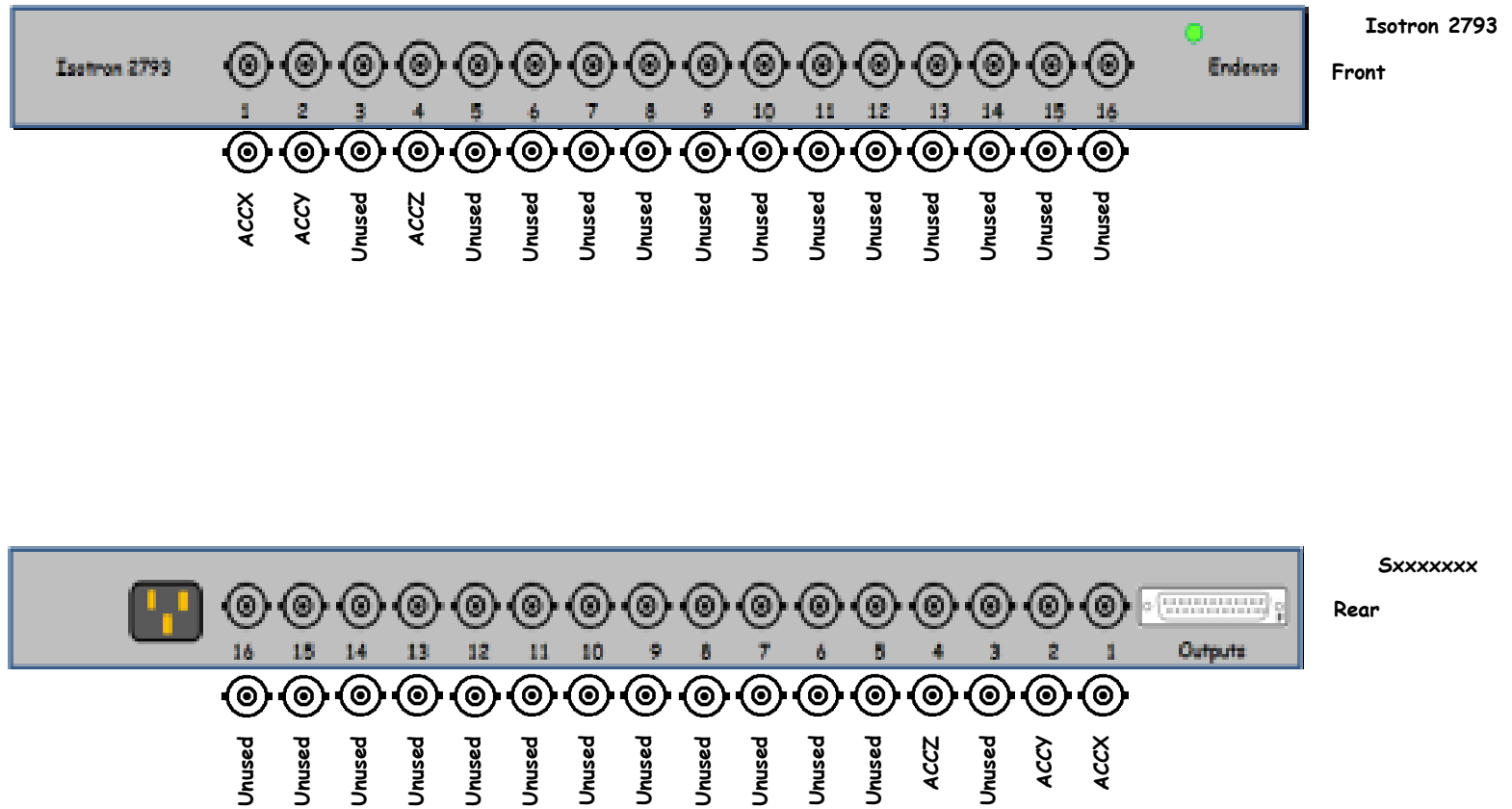

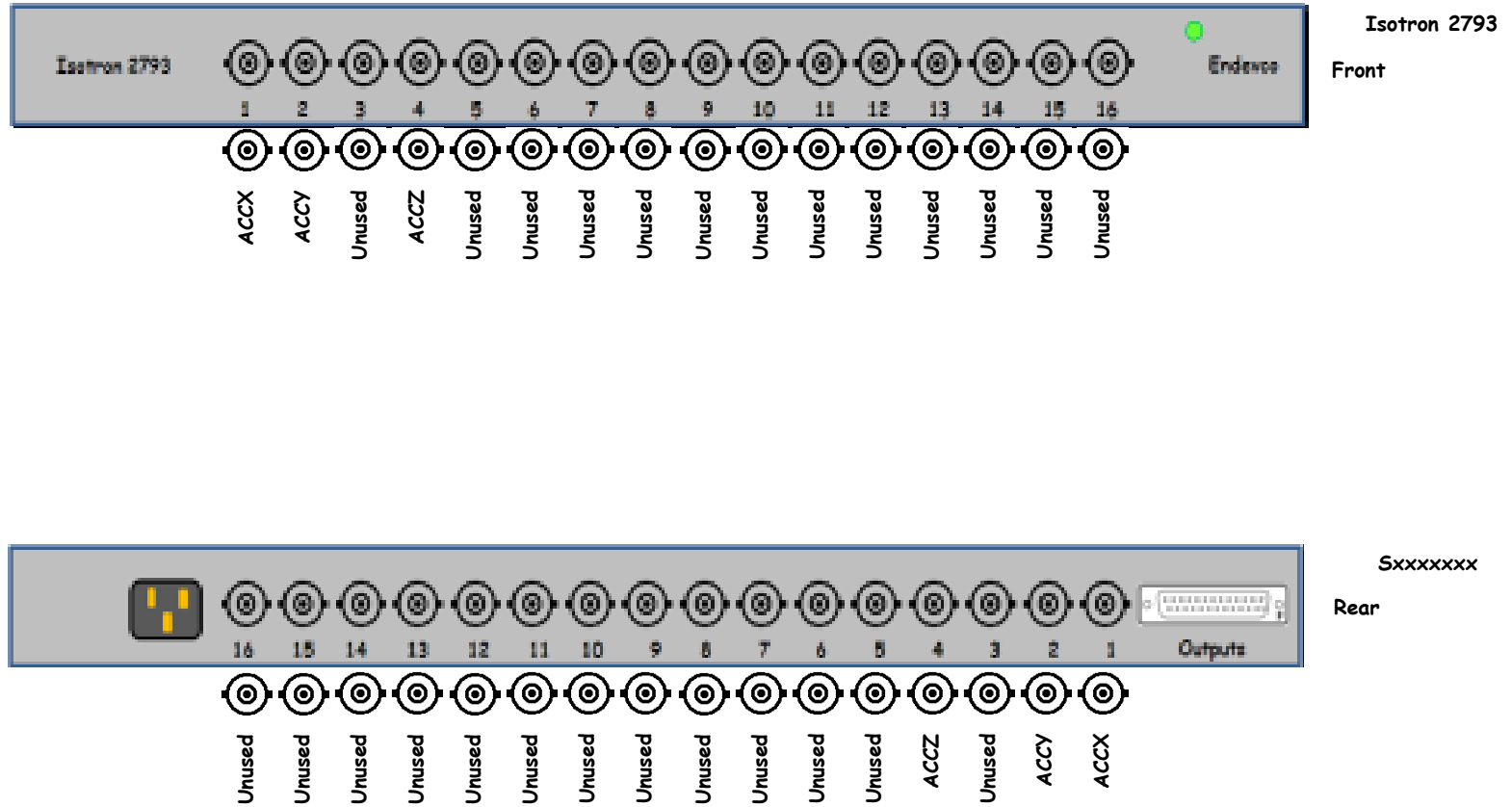

<< L1-OAF-C1

aLIGO AA Interface Chassis
(32 BNC, x10 Gain Version)

[D1001421](#)

[S1001057](#) :

Power

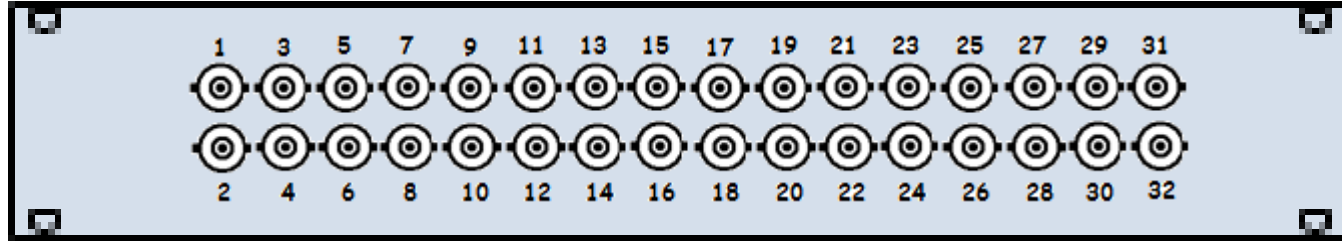

[D1001421](#)

Front

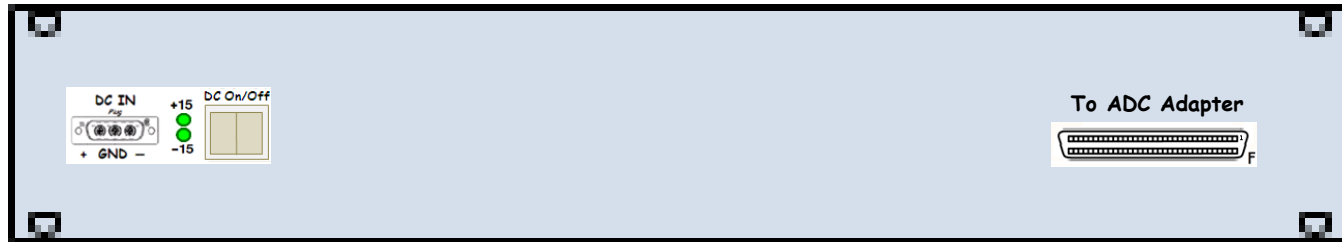
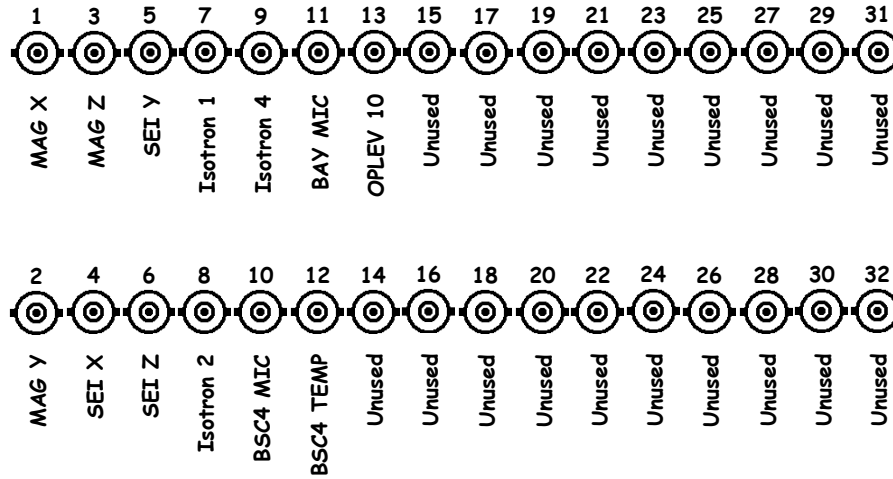

[S1001057](#)

Rear

[To I1oaf0 Slot P1](#)

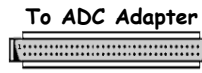

To ADC Adapter

11oaf0 I/O Extension Chassis

D1001715

S1103844

+24VDC



D1001715
Front

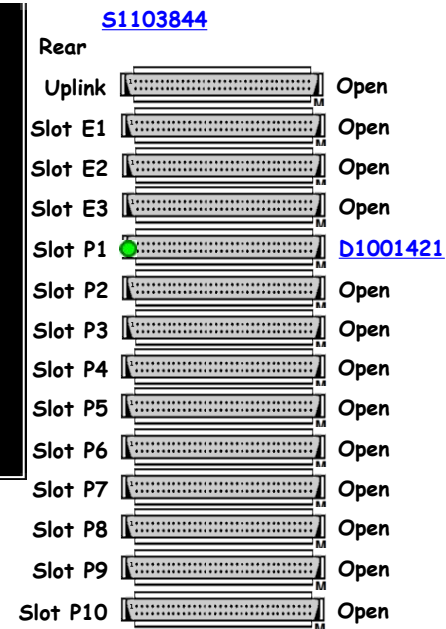
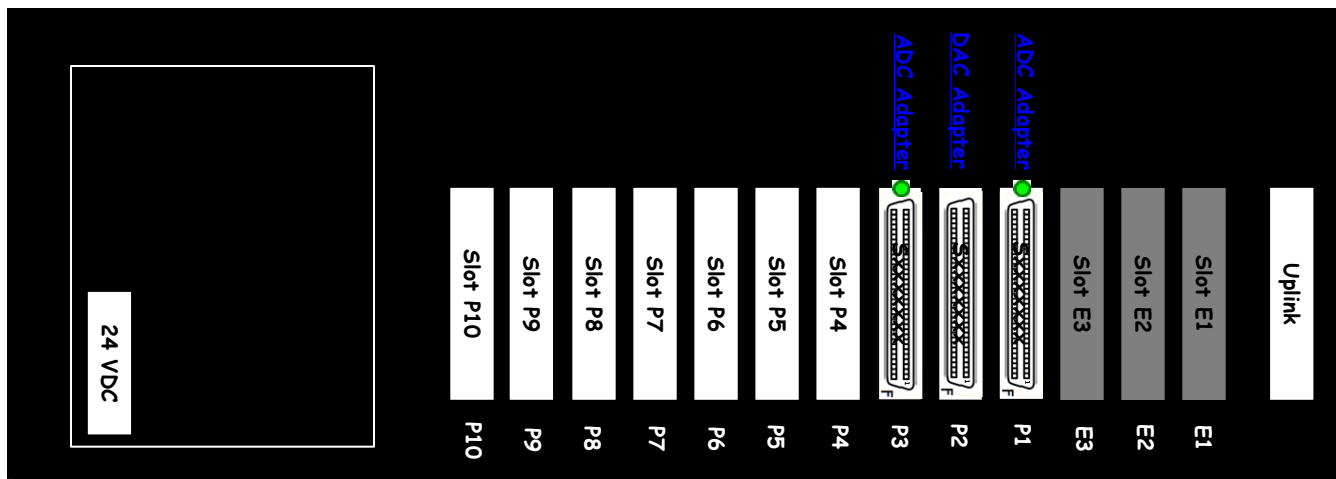

L1 PEM Sensor Details

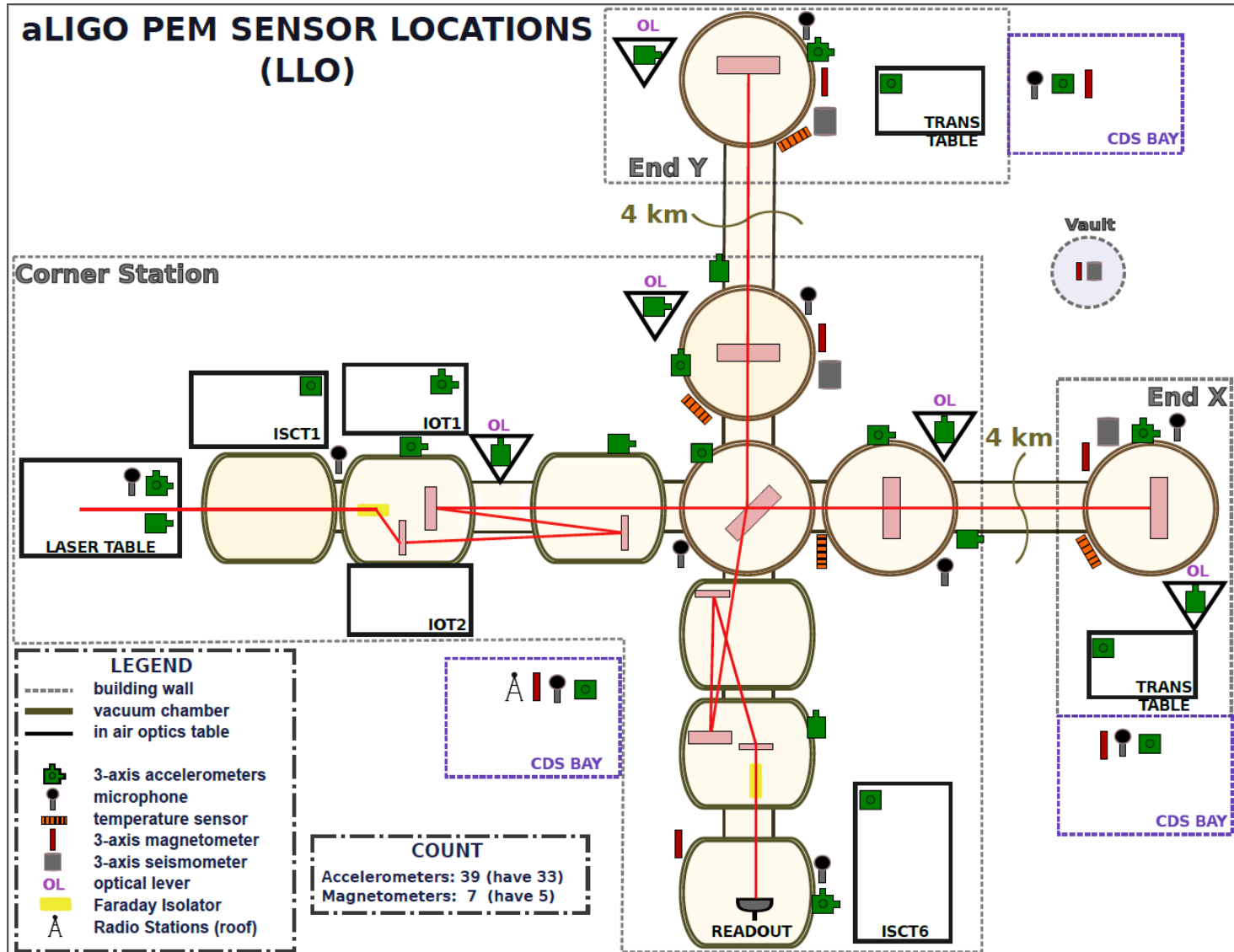

D1200615

- **Accelerometers**
 - $10^{-8} f^{-2} \text{ m Hz}^{-1/2}$
 - 10-200Hz (256Hz, 16bit)
- **Seismometers**
 - $3 \times 10^{-10} f^{-2} \text{ m Hz}^{-1/2}$
 - 0-10 Hz (256Hz, 16bit, 3 axis)
- **Microphones**
 - $10 \text{ Pa Hz}^{-1/2}$
 - 10-1000Hz (2048Hz, 16bit)
- **RF receivers**
 - $10 \mu\text{V/m}$
 - 1.3GHz (2048Hz, 6x16bit)
- **Residual Gas in Vacuum System**
- **Vacuum contamination Monitor**
- **Weather Station**
 - T (1K), RH (10%), precipitation (10%), Wind (1mph)

- **Tiltmeters**
 - $2 \times 10^{-9} f^{-2} \text{ rad Hz}^{-1/2}$
 - 0-10Hz (256Hz, 16bit, 2 axis)
- **Dust Monitors**
- **Muon (Charged Particle) Detector**
 - $10^{-4} \mu/\text{s}/\text{m}^2$
 - 1 msec (2048Hz, 16bit)
- **Cosmic Rays**
- **Magnetometer**
 - $2 \times 10^{-11} \text{ T.Hz}^{-1/2}$
 - 1 kHz (2048Hz, 3x16bit)
- **Coil magnetometer**
 - $2 \times 10^{-12} \text{ T.Hz}^{-1/2}$
 - 1 kHz (2048Hz, 16bit)
- **Scintillator detector**
- **Power Line Monitor**

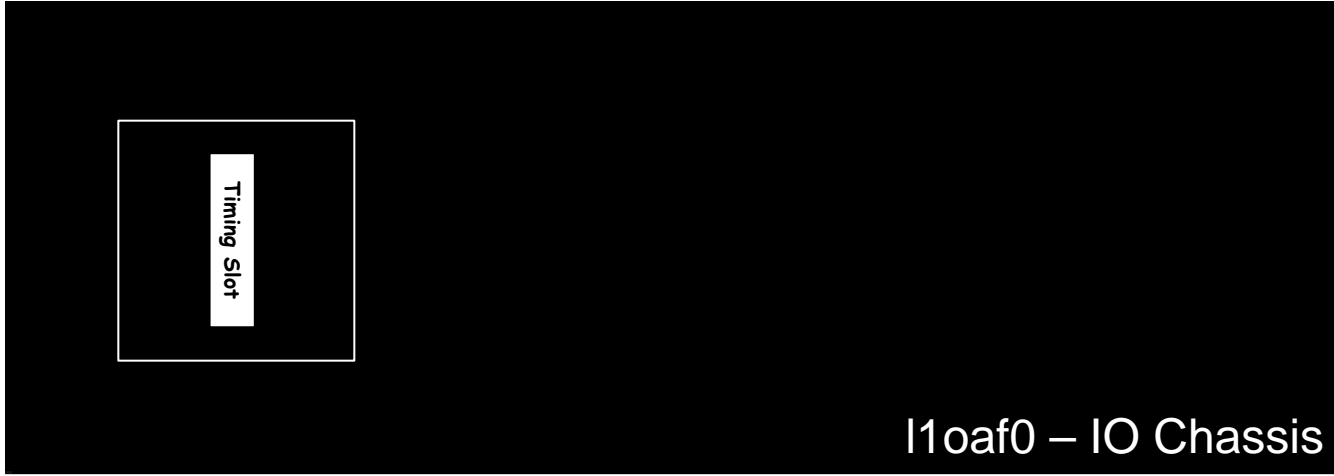

D1001715

Front

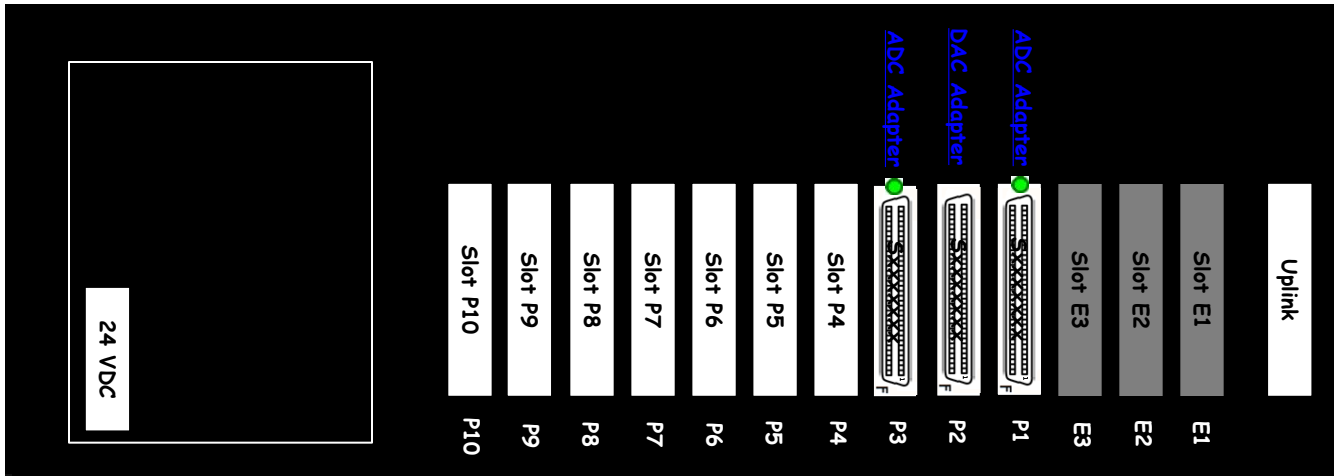

S1103894

Rear

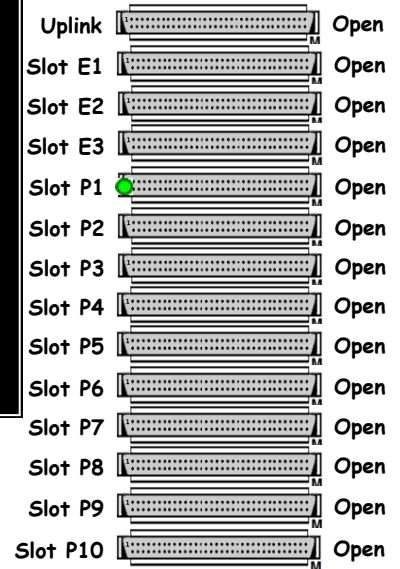

PCIe to Fiber Cable Adapter



Accelerometers (1)

1X5
1X20
1Y20

Isotron Power Supply Model 2793 has 16 channels
This model does NOT come with a DC option.
There is a 3-channel Power Supply that has a DC option,
but it has many other features not desired.

It appears that a short (6") 10-32 to BNC cable can be ordered, but
care should be given to strain relief considerations.

Only Wilcoxon Accelerometers are used for PEM

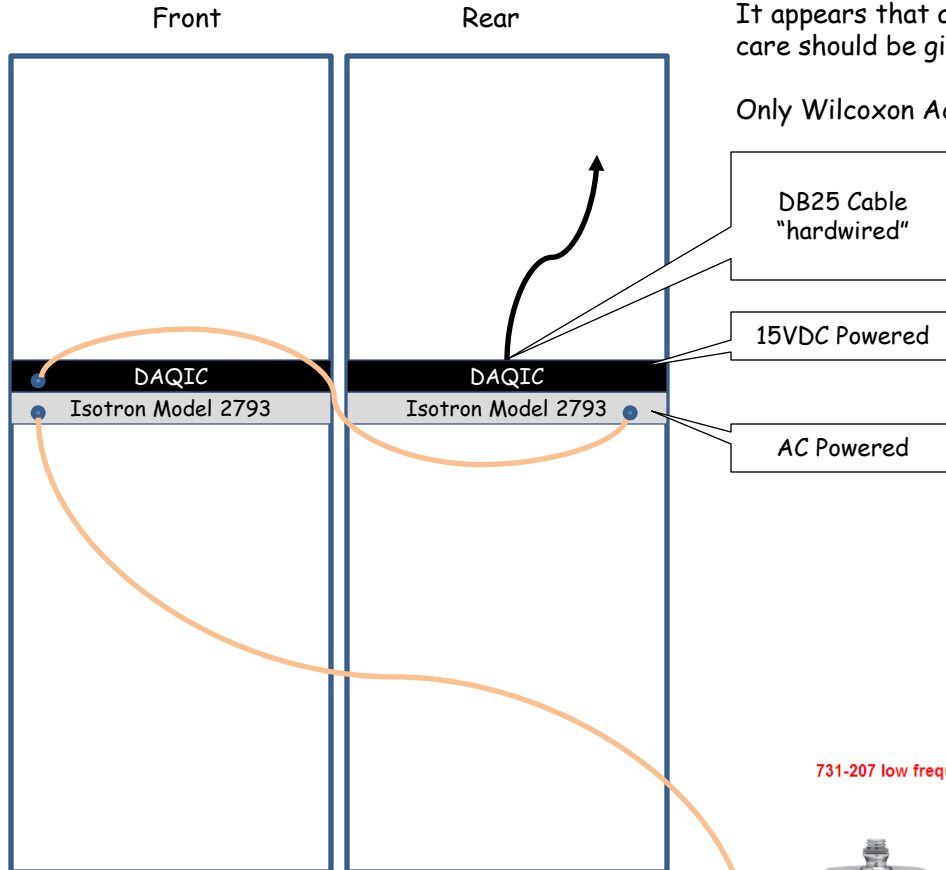

Accelerometer locations:

- | | |
|-----------------------|-------------------|
| 1) PSL X | 16) BSC1 X |
| 2) PSL Y | 17) BSC1 Y |
| 3) PSL Z | 18) BSC1 Z |
| 4) ISCT1 X | 19) BSC2 X |
| 5) ISCT1 Y | 20) BSC2 Y |
| 6) ISCT1 Z | 21) BSC2 Z |
| 7) HAM1 X | 22) BSC3 X |
| 8) HAM1 Y aka HAM6 X | 23) BSC3 Y |
| 9) HAM1 Z | 24) BSC3 Z |
| 10) HAM2 X | 25) HAM6 X |
| 11) HAM2 Y aka HAM6 Y | 26) HAM6 Y |
| 12) HAM2 Z | 27) HAM6 Z |
| 13) HAM3 X | 28) BSC4 X (VEAX) |
| 14) HAM3 Y aka HAM6 Z | 29) BSC4 Y (VEAX) |
| 15) HAM3 Z | 30) BSC4 Z (VEAX) |
| | 31) BSC5 X (VEAY) |
| | 32) BSC5 Y (VEAY) |
| | 33) BSC5 Z (VEAY) |

731-207 low frequency seismic accelerometer

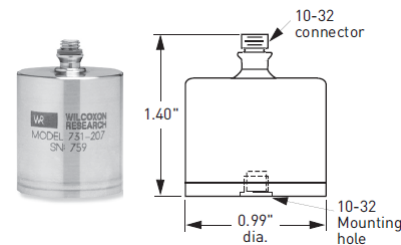

Accelerometer
(in the field)

731-207 low frequency seismic accelerometer

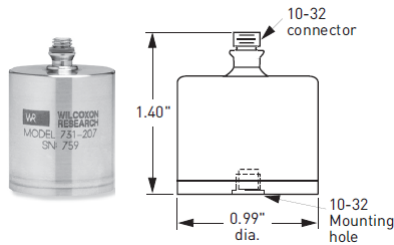

3061

The Endevo model 3061 cable is a non-low noise treated version of the 3090CM12 cable assembly. This cable has a male 10-32 miniature coax connector at one end and a male BNC at the other. The model 3061 is temperature rated from -85°F to +350°F.

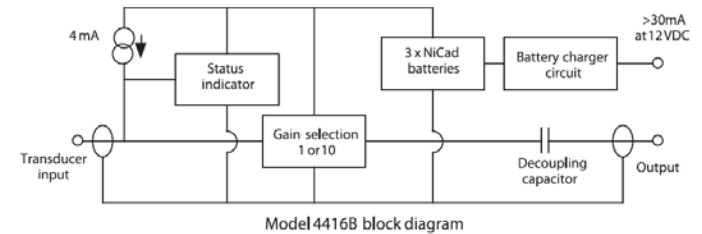
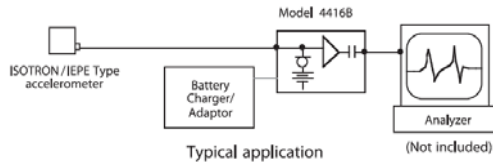
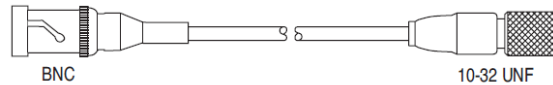

Notes:

1. For ultra-low noise application, model 4416BM1 offers the same basic design without the gain stage.

Avoiding ground loops

In order to provide proper shielding and prevent ground loops, shield and common grounding should be carefully considered. Ground loops are developed when a common line (i.e. signal return/shield) is grounded at two points of differing electrical potential.

For sensors with coaxial cable, the center conductor carries the signal and power, while the outer braiding provides the shielding and signal return. Normally the cable shield is electrically isolated from the sensor housing. This isolates the shield from the mounting point of the machine and prevents ground loops. If a non-isolated sensor is used, it is recommended that an isolated mounting pad be used to break up possible ground loops.

For sensors using two conductor/shielded cable, the signal and power are carried on one lead and the signal common on the other. The cable shield serves to protect the signal from Electrostatic Discharge (ESD) and Electromagnetic Interference (EMI). The shield should be grounded at only one point, normally to the readout equipment.

In all cases, it is very important that the cable shield terminations be properly grounded. Failure to do so in high ESD/EMI environments can result in damage to the sensor electronics.

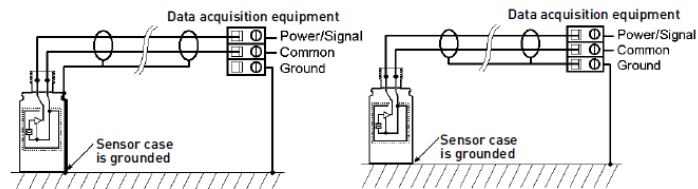

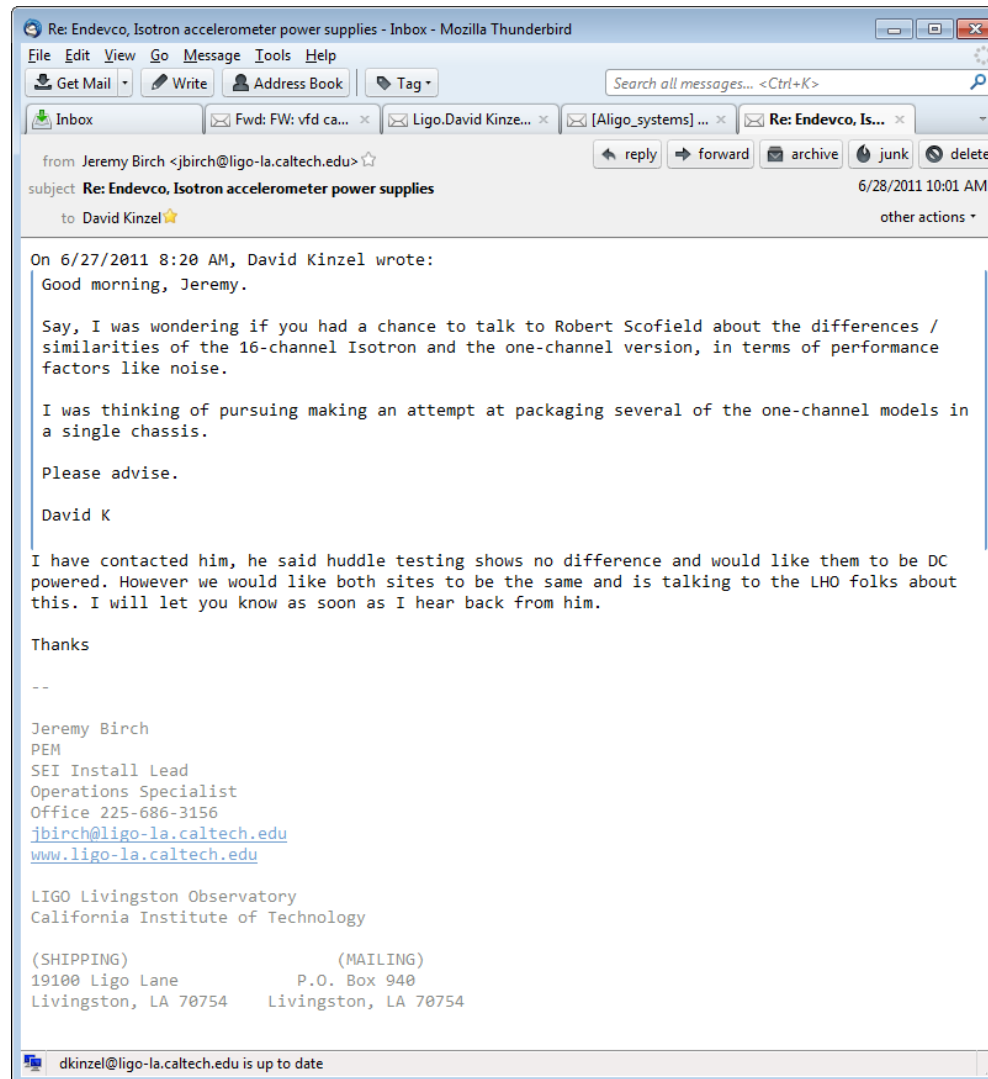

Re: Endevo, Isotron accelerometer power supplies - Inbox - Mozilla Thunderbird

File Edit View Go Message Tools Help

Get Mail Write Address Book Tag Search all messages... <Ctrl+K>

Inbox Fwd: FW: vfd ca... Ligo.David Kinze... [Aligo_systems] ... Re: Endevo, Is...

from Jeremy Birch <jbirch@ligo-la.caltech.edu> ☆

subject Re: Endevo, Isotron accelerometer power supplies

to David Kinzel ☆

6/28/2011 10:01 AM

reply forward archive junk delete other actions

On 6/27/2011 8:20 AM, David Kinzel wrote:

Good morning, Jeremy.

Say, I was wondering if you had a chance to talk to Robert Scofield about the differences / similarities of the 16-channel Isotron and the one-channel version, in terms of performance factors like noise.

I was thinking of pursuing making an attempt at packaging several of the one-channel models in a single chassis.

Please advise.

David K

I have contacted him, he said huddle testing shows no difference and would like them to be DC powered. However we would like both sites to be the same and is talking to the LHO folks about this. I will let you know as soon as I hear back from him.

Thanks

--

Jeremy Birch
PEM
SEI Install Lead
Operations Specialist
Office 225-686-3156
jbirch@ligo-la.caltech.edu
www.ligo-la.caltech.edu

LIGO Livingston Observatory
California Institute of Technology

(SHIPPING) (MAILING)
19100 Ligo Lane P.O. Box 940
Livingston, LA 70754 Livingston, LA 70754

dkinzel@ligo-la.caltech.edu is up to date

- There are two antennas of interest.
- 1) Roof Antenna
 - 2) CDS High-bay Antenna

The Roof Antenna

- 1) Receiver is located in the MSR
- 2) 219.84 MHz FM

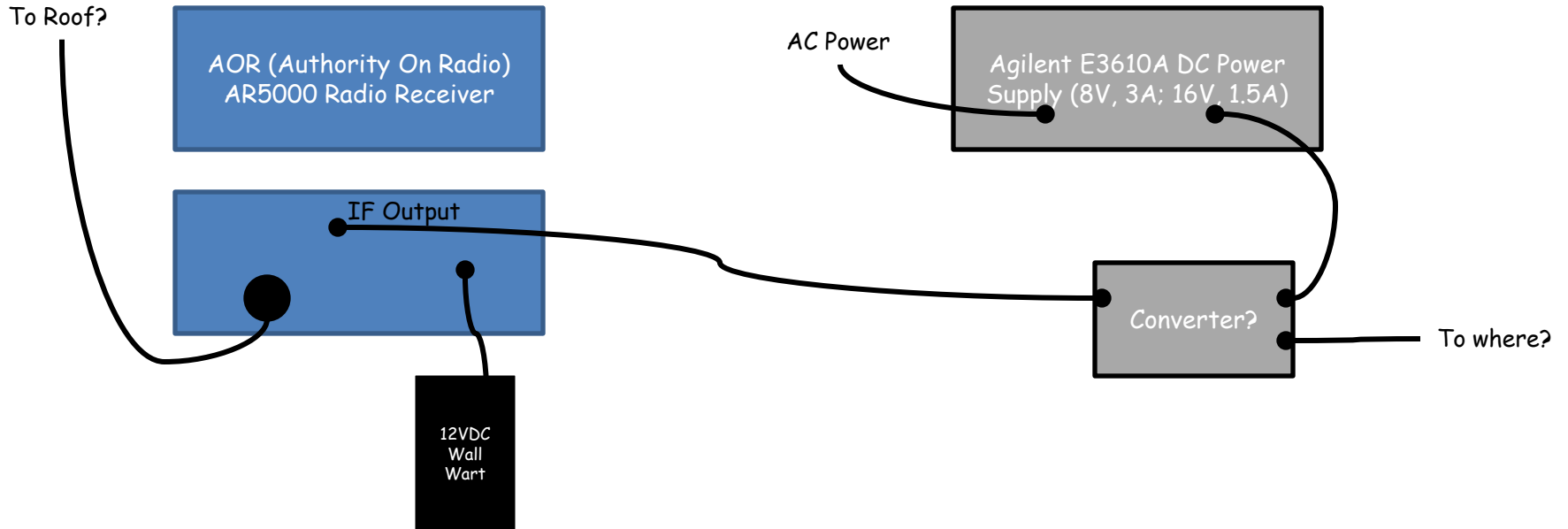



Humidity sensor locations
1) Room 172 - LDR Changing Room

Relative Humidity/Temperature Transmitter with dual Voltage or Current Output, Compact Size
Discontinued Product! See Note Below

HX93 Series



- 4-20mA or 0-1V Output
- RH and Temperature Output
- Compact Size for Mounting Versatility
- Watertight Enclosure
- Accurate to 2.5% RH and 0.6°C

Click for [larger image](#).

[To Order](#) [Specs](#)

The HX93 Series is no longer available. Please see the [HX93A Series](#) as a substitute or contact Sales/Temperature Engineering.

(J.) David Barker says this is the Siemens System



Magnetometer (1)

Magnetometer: Bartington Instruments
MAG-03MC

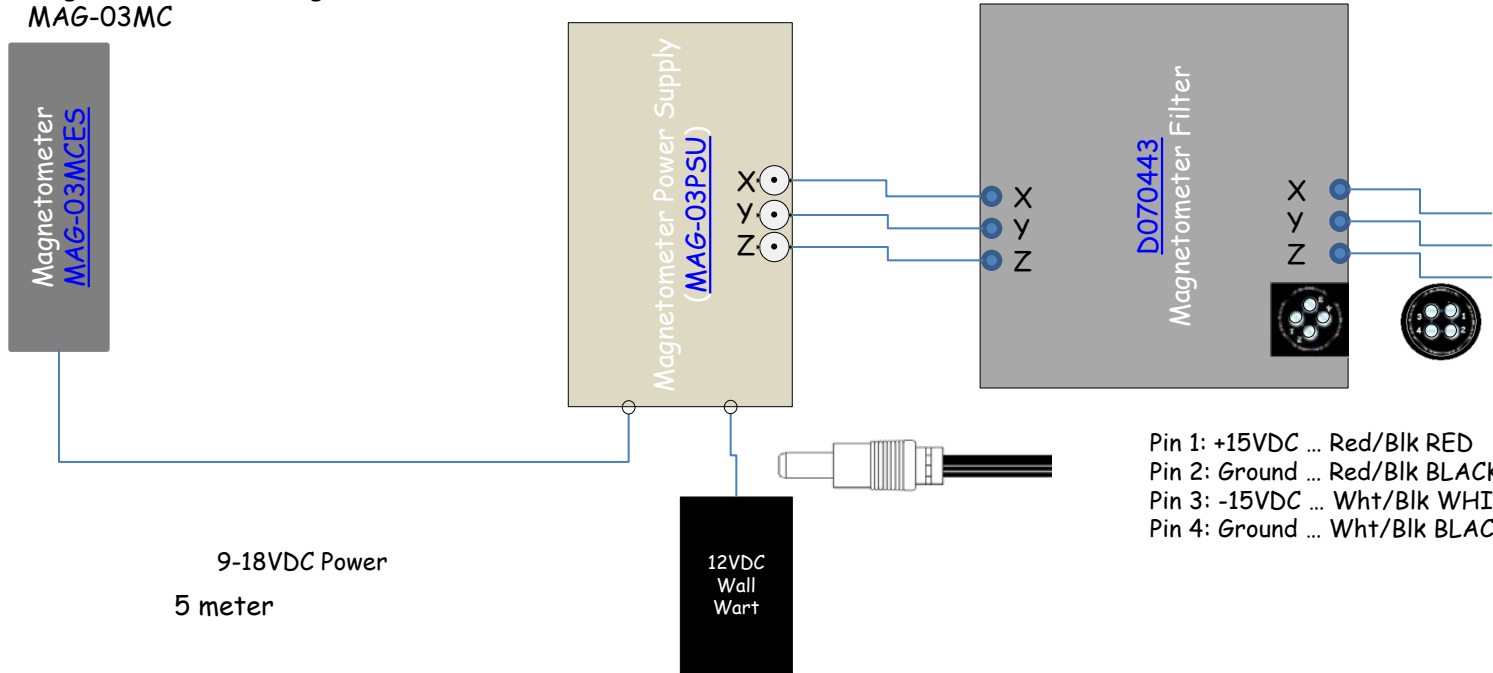

Pin 1: +15VDC ... Red/Blk RED
Pin 2: Ground ... Red/Blk BLACK
Pin 3: -15VDC ... Wht/Blk WHITE
Pin 4: Ground ... Wht/Blk BLACK



D030574
T1100382

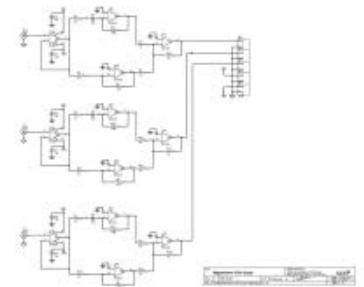

Magnetometers (2) Filter Schematic

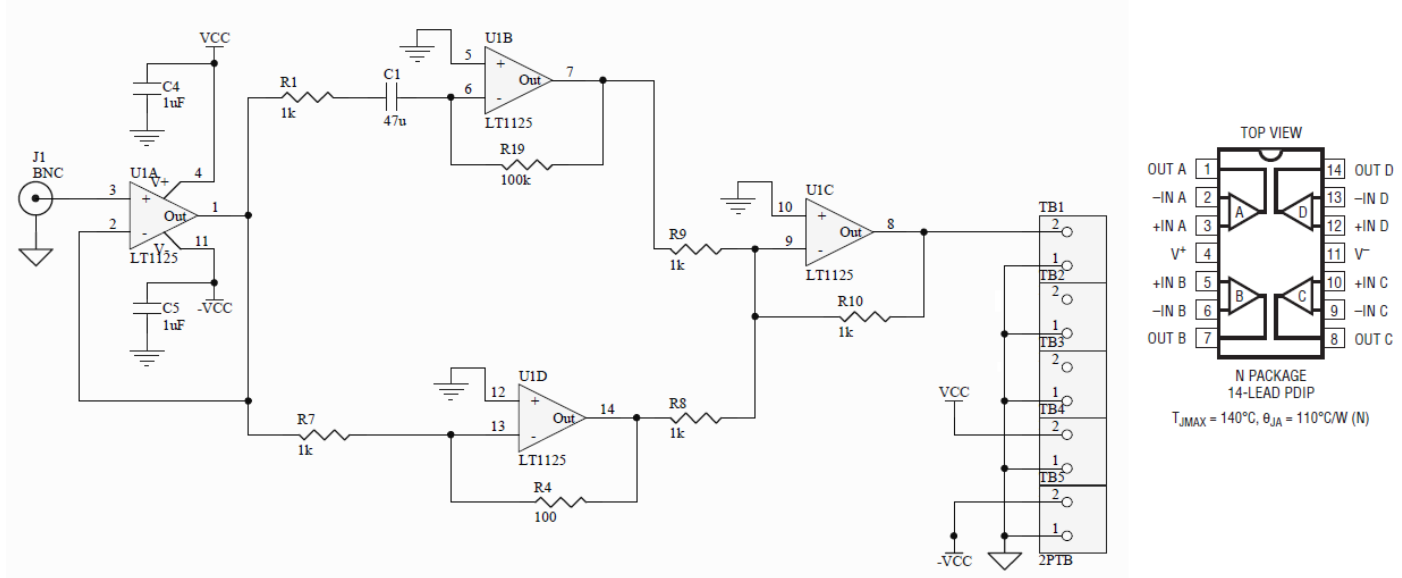

[D030574](#)

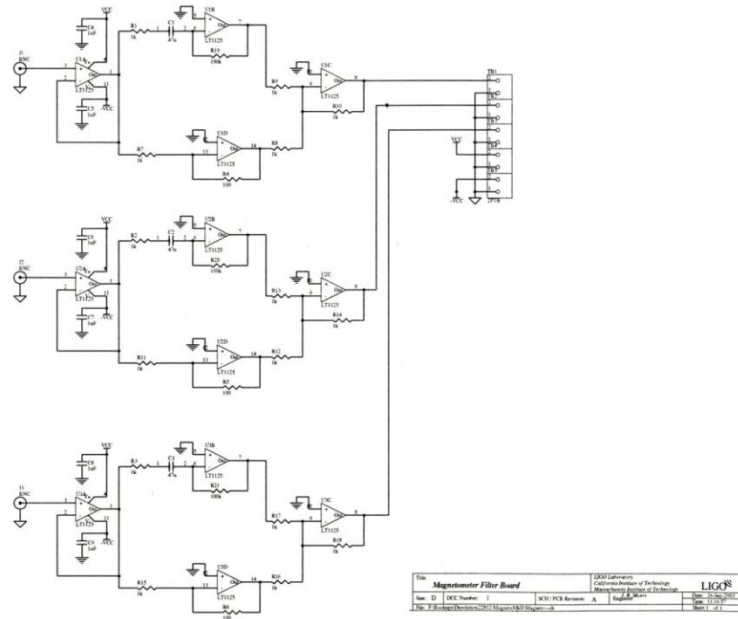

Magnetometers (3) Amplifier Sketch

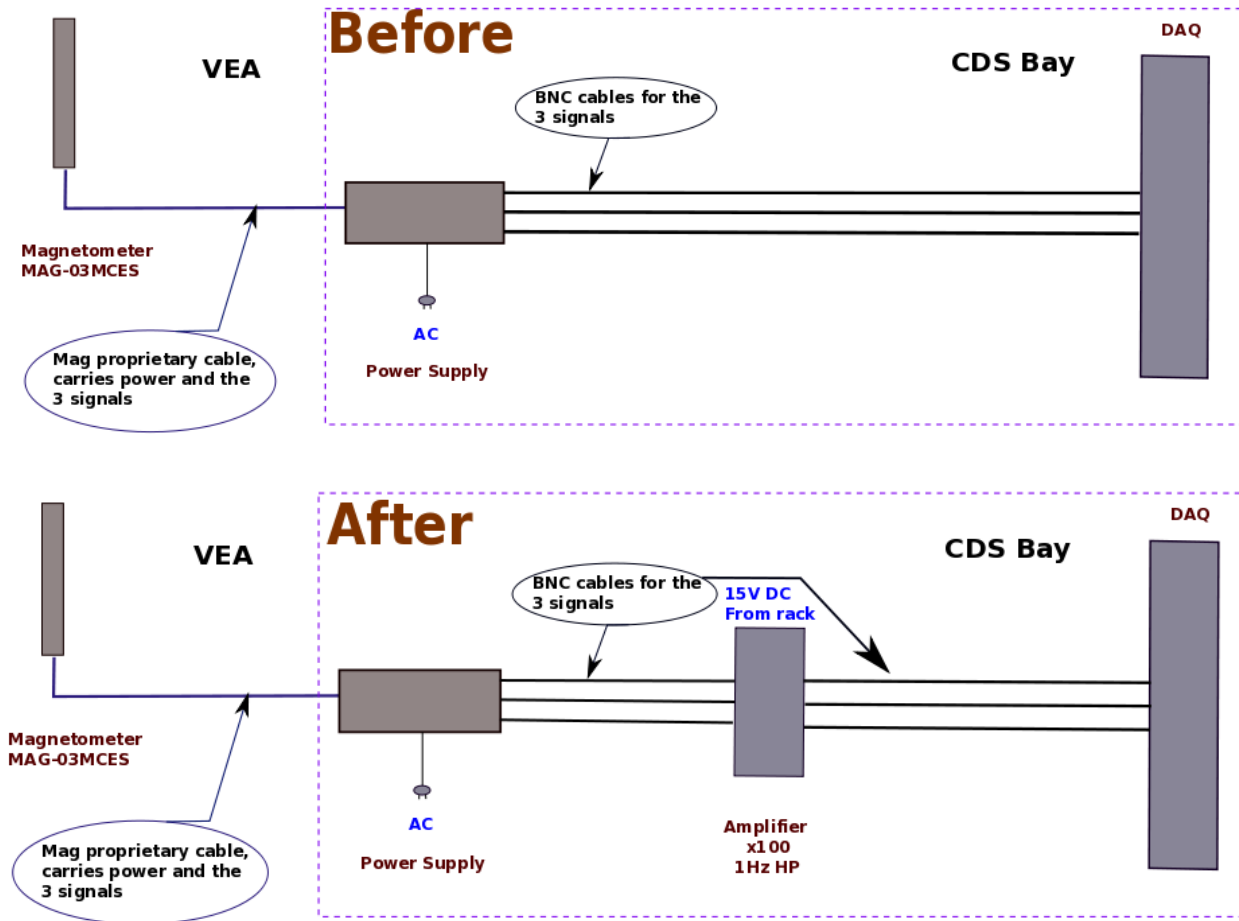

Microphone locations / Pair

- 1) PSL / ISCT1
- 2) ISCT1 / PSL
- 3) HAM1 / HAM3
- 4) HAM3 / HAM1
- 5) BSC2 (aka LVEA) / HAM6
- 6) BSC1 / BSC3
- 7) BSC3 / BSC1
- 8) HAM6 / LVEA
- 9) BSC4 (X) / not paired
- 10) BSC5 (Y) / not paired
- 11) LSR (aka CDS High-bay) / not paired
- 12) VEAX Bay Mic / not paired
- 13) VEAY Bay Mic / not paired

The Manufacturer is Bruel & Kjaer

Since the power supply handles two microphones, the microphones are 'paired' in certain places.

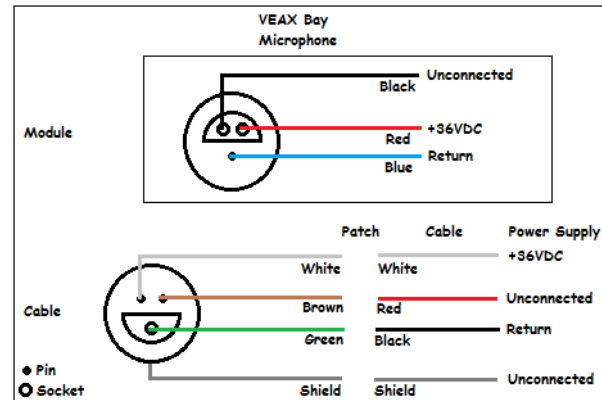

Extension cables are available - 3m, 10m, and 30m

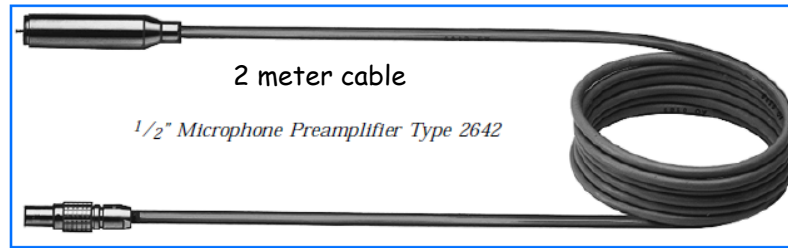

Microphones - Power Adaptor Cable

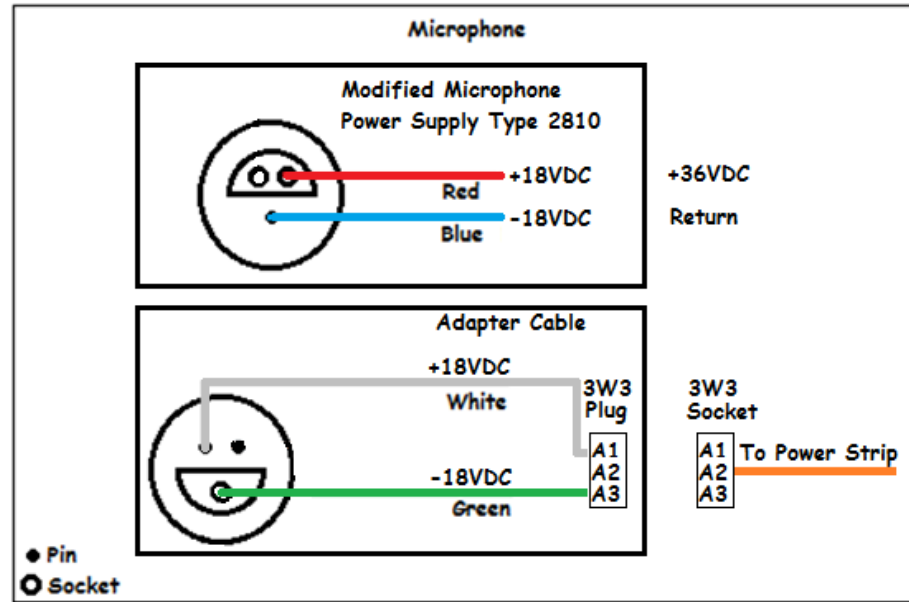

Particle Counters (Dust Monitors)

Dust Monitors are not on during Science Mode due to the acoustic noise. This noise is the air pump. It is always on.

The manufacturer is Pacific Scientific
 Old ones (being replaced) are MET One 227B. (9VDC)
 New ones (replacements) are MET One GT-321. (9VDC, 2A)

These are scattered throughout the LVEA and usually two of them share a power supply via a cable to a junction box. They are powered from the serial interface port. Not sure if this is a homemade adaptation.

The Junction Box needs documentation.

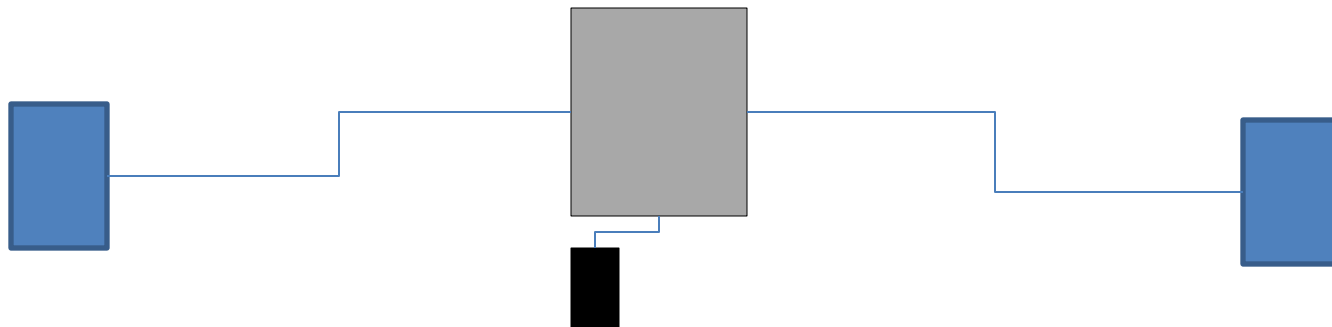
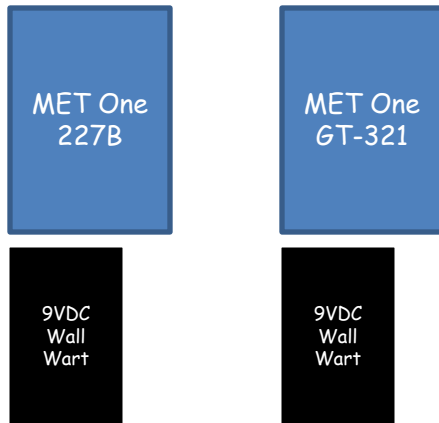

Control DeviceMaster with DB9 Ports

Control DeviceMaster 4 with DB9 Ports

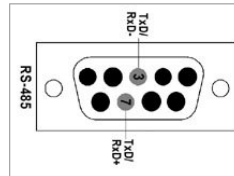
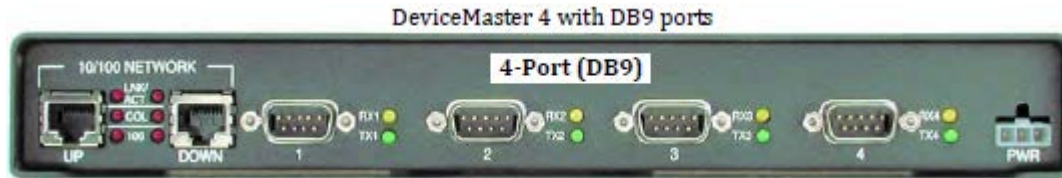

4-Port Power Supply

This table provides the specifications for the power supply shipped with the DeviceMaster 4-port.

Control Power Supply: 4-Port	
Input line frequency	47 - 63 Hz
Input line voltage	90 - 260 VAC
Output voltage	24VDC
Output current	500 mA @ 24VDC



Housing Molex P/N:
39-01-4030
Pins Molex P/N:
44485-1211



3M Shell 3357-9209



2.1mm Socket
(Note polarity)

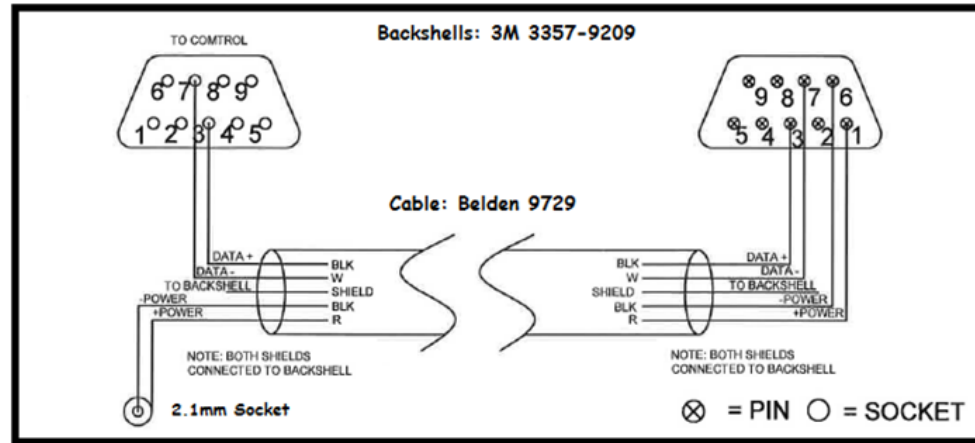

3M Shell 3357-9209

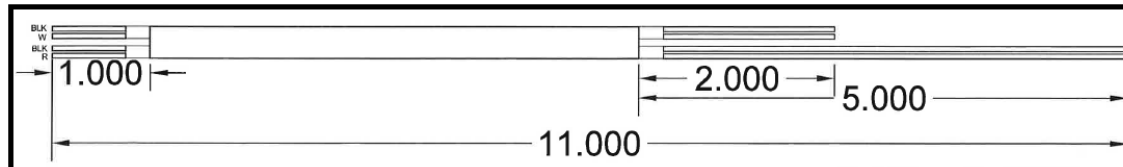

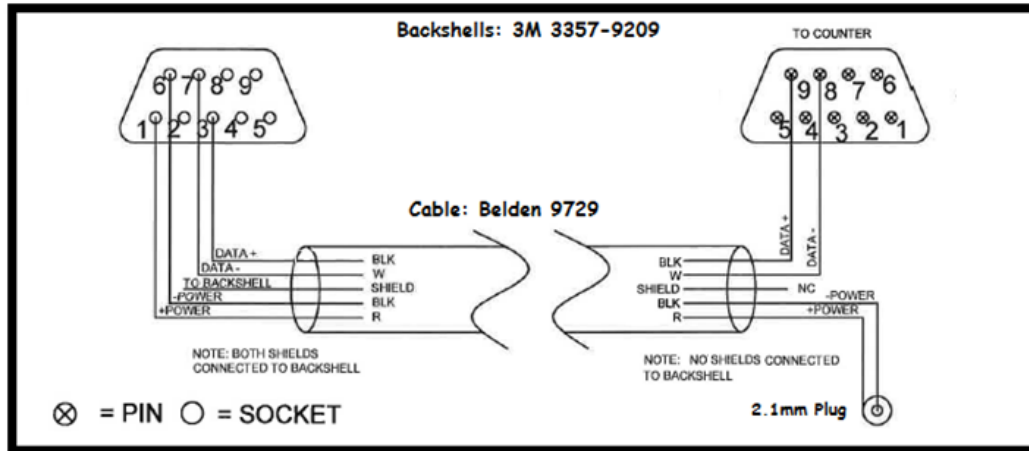

2.1mm Plug
(Note polarity)

This cable is configured to carry both DC Power and RS485 Signals. The 2.1mm Plug can come from a commercially available 2.1mm Cable Assembly. Note the center conductor of the 2.1mm is NEGATIVE. And both shields are tied together and are tied only to the backshell that connects to the cable. The backshell connected to the Particle Counter is NOT tied to the shields.

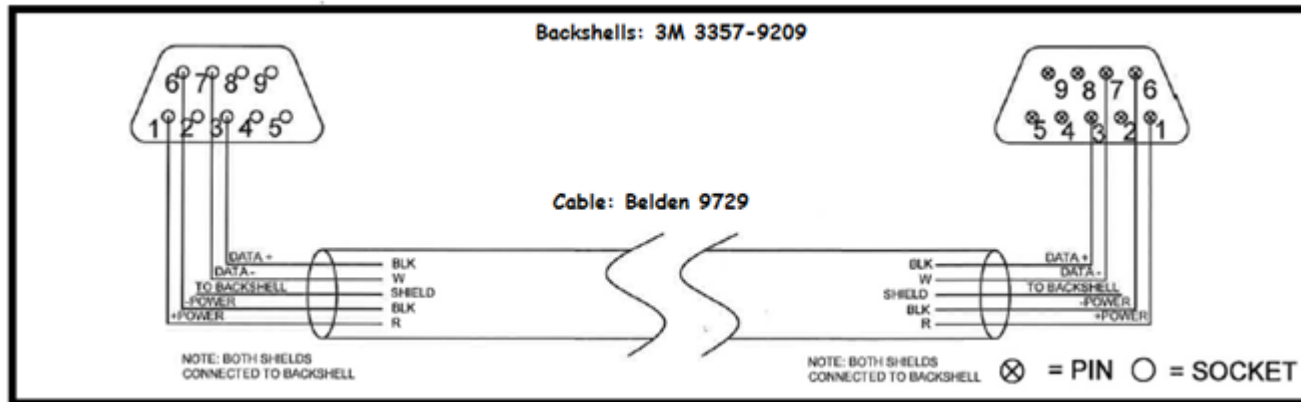

This cable is configured to carry both DC Power and RS485 Signals. Note that both shields are tied together and tied to both backshells.

It is 70' from the L1-FAC-XC1 Rack to the knee of the waterfall in the VEAX.

It is 65' from the L1-FAC-YC1 Rack to the knee of the waterfall in the VEAY.

3M Backshell Assembly

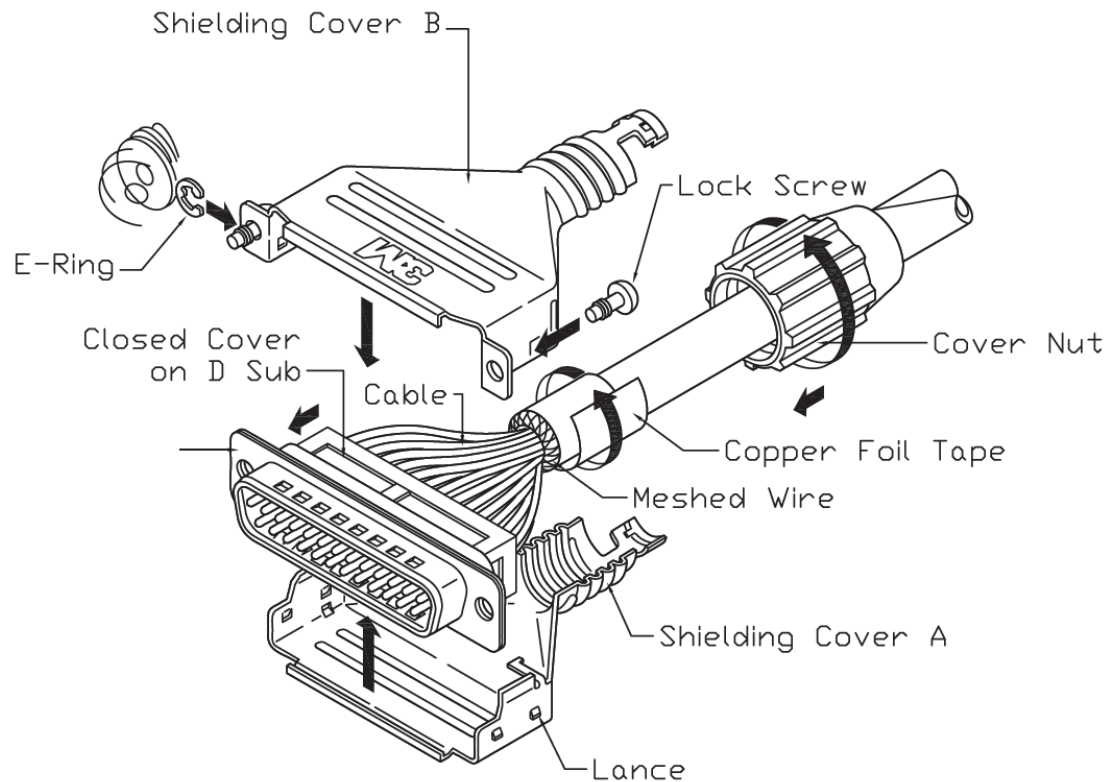

This is a sample drawing of the 3M backshell showing how the E-Ring is attached to the Lock Screw, and showing how the Cover Nut holds the backshell in place.

Particle Counters (Met One 227B)



Model 227 Series Hand-Held Particle Counter
With Temperature/Relative Humidity Probe

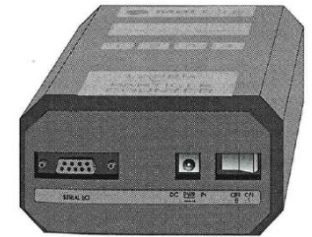
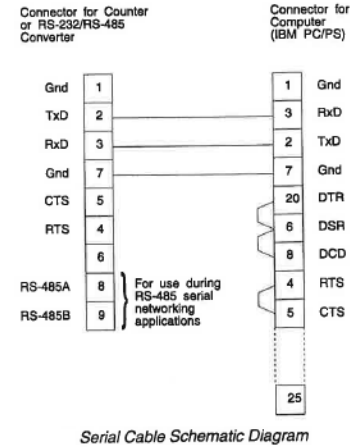

3M Shell 3357-9209

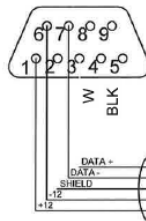

Belden 9729

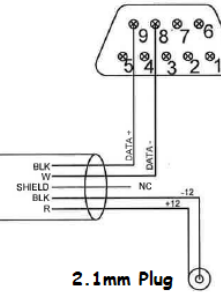

3M Shell 3357-9209

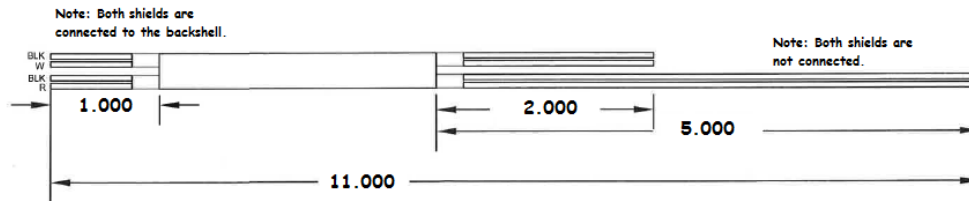

⊗ = PIN ○ = SOCKET



2.1mm Plug
(Note polarity)

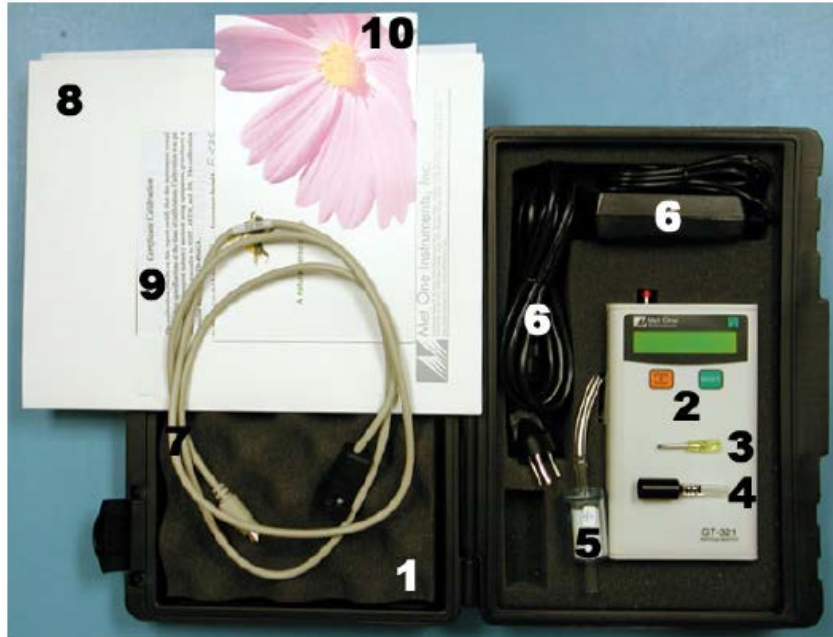

1. Carrying case
2. GT-321 Hand Held Particle Counter
3. Miniature screwdriver
4. Iso-kinetic Sample Probe with a short piece of tubing
5. Zero Particulate Filter (Met One Part Number G3111)
6. Universal AC to DC converter module with IEC AC power cord
7. RS-232 Serial Cable
8. Operation Manual
9. GT-321 Calibration Certificate
10. Color Brochure (optional)

Temperature Sensors

LIGO

- Temperature Sensor locations
- 1) BSC1 (LVEA) - one old, one new
 - 2) BSC3 (LVEA)
 - 3) BSC4 (VEAX)
 - 4) BSC5 (VEAY)

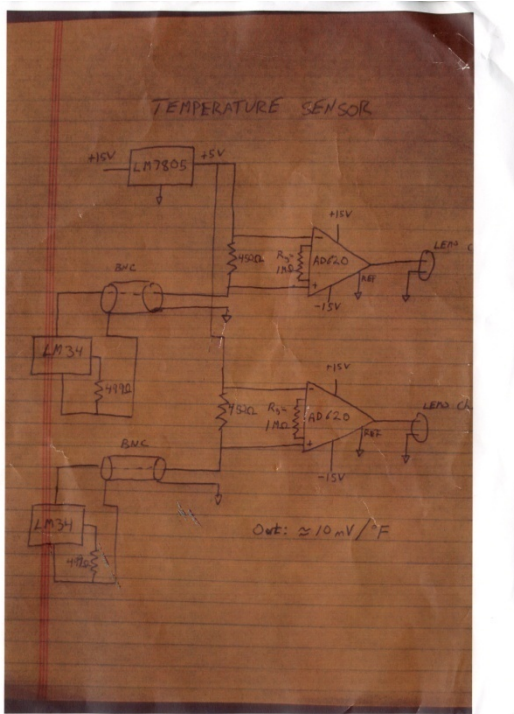

Temperature Sensors include thermocouples:

- 1) Are there any read in the chiller lines? TCS, PSL?
- 2) There are thermocouples in the vacuum system for the N2 tanks.

10:05:43
Tue Jan 9 2007
(Local)

Topic: Commissioning Author: Valera Frolov Tue Jan 9 16:05:43 2007 UTC

Thermocouple readout

According to Rus the thermocouple goes straight to ADC.
The 12 bit ADC is not sensitive enough for the K type Omega thermocouple that has EMF/temp ~40 uV/C.

- Valera Frolov <http://log.ligo-la.caltech.edu/> (ref:1)

NO_KEYWORD Add or Remove Keyword:

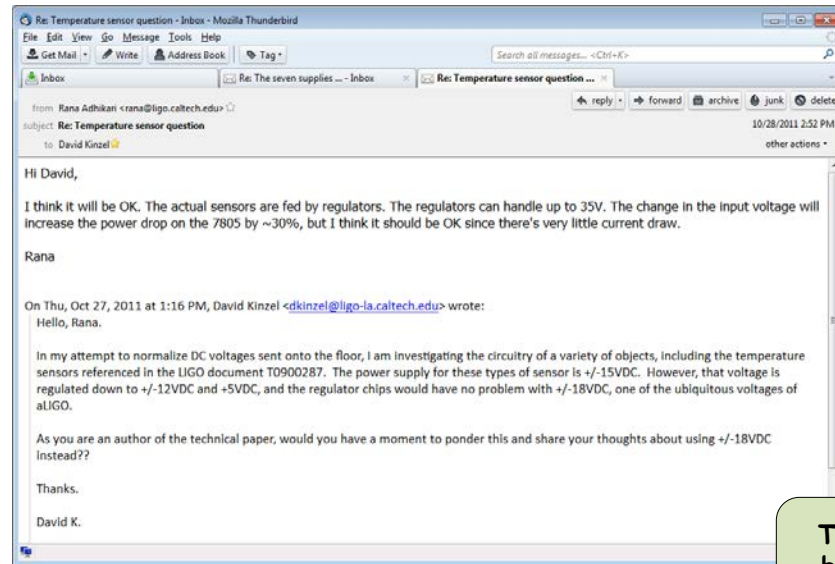
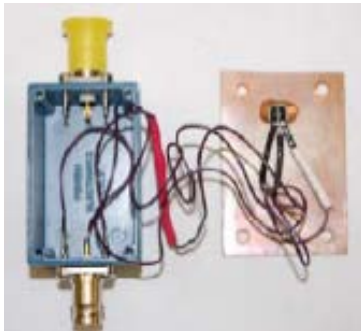

These cables can be replaced with standard +/-18VDC

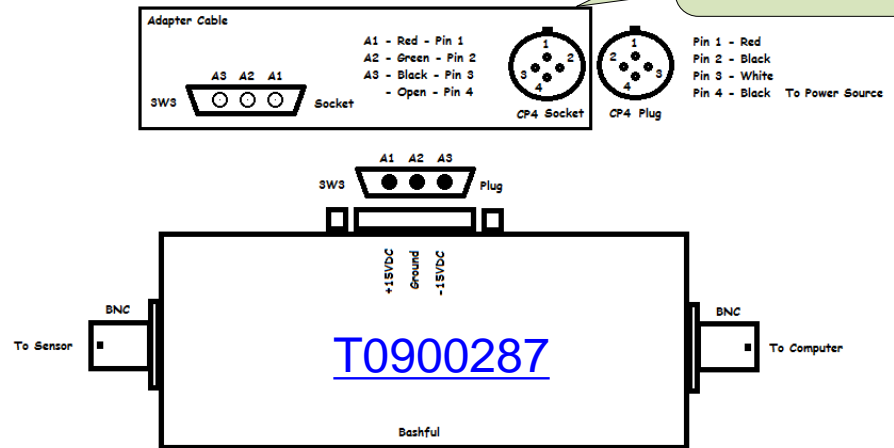

Comments as of 20100525

PEM Voltage Monitor locations:

- 1) LVEA - Rack 1X5 - DAQIC2, BNC Port 13
- 2) VEAX - Rack 1X20 - DAQIC2, BNC Port ?
- 3) VEAY - Rack 1Y20 - DAQIC2, BNC Port 10

This monitor is labeled, "PEM Voltage Monitor No. CAS-Vxx." The circuit board inside says, "LHO EE Power Monitor Board D000TBD." Documentation is scarce. This device is probably OK for monitoring the single balanced power into which it is plugged in Rack 1X5. It is intended to record the differential between the two phases of the balanced power. But if it is used on any 'real' AC circuit, it creates the potential for a $\frac{1}{2}$ line voltage ground loop between neutral and ground, and another between hot and ground.

Additionally, even in the balanced power situation, NEUTRAL is the wrong designation, for none of the conductors is neutral in a balanced power circuit: it is the negative AC power.

The circuit ties all shields together, so current loops exist between 2 potentially different AC circuits.

And also the cable ties all shields together, creating the same problem.

And most ironic, the monitor in Rack 1X5 is NOT being read at all: there is no signal name, but it is plugged in. (This was NOT true in September 2009 when inventory of the DAQIC signals was last taken.)

At the Y-end, the AC cable has only three BNC connectors. Two are connected to the Voltage Monitor box.

At the X-end, the AC cable has all four BNC connectors, but they are cross-connected to the Voltage Monitor Box: Cable HOT1, NEU1, HOT2, NEU2 are connected to Box HOT2, NEU2, HOT1, NEU1 and I did not check the cable for accuracy. I did note it only has 2 wires coming into the CP4 port, however, but which two is not clear.



LHO EE
Power
Monitor
Board
D000TBD?

Voltage Monitor (2)

Photos as of 20100525



Internal Design and Interfaces as of 20100525

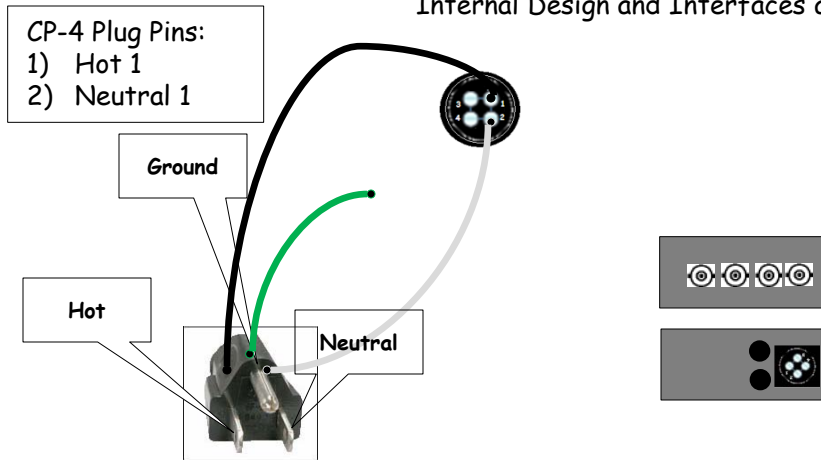

- CP-4 Socket Pins:
 1) Hot 1 - fused
 2) Neutral 1
 3) Hot 2 - fused
 4) Neutral 2
- $R1, R3, R5, R7 = 1M\Omega$
 $R2, R4, R6, R8 = 1k\Omega$
 Fuse_{1,2} = 250V, $\frac{1}{4}A$

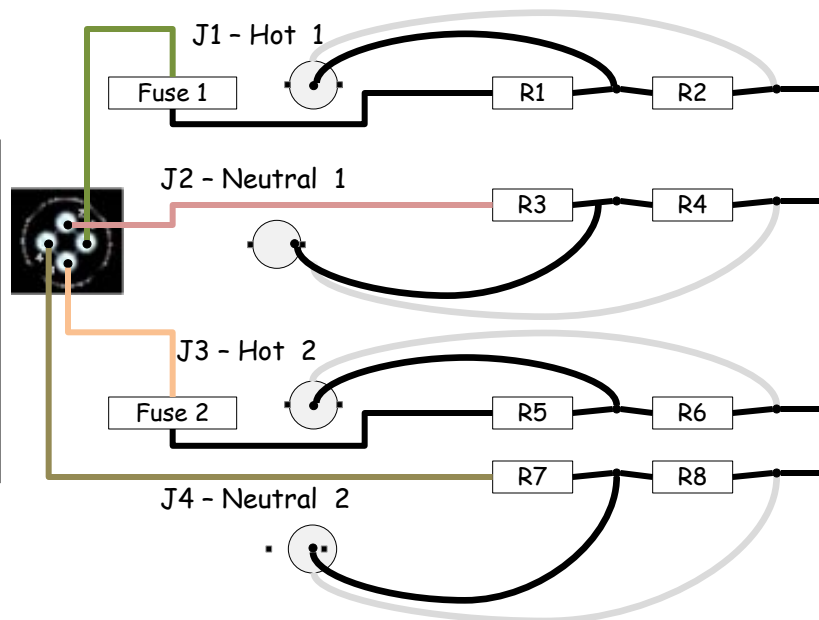

AC Power (input to monitor)
 2 - Fuses - 250V $\frac{1}{4}A$

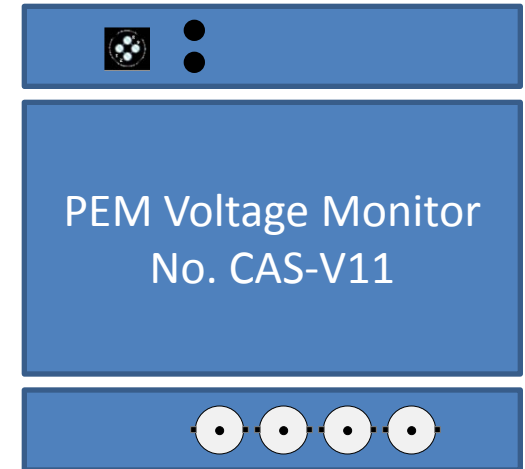

J4 - Neutral 2
 J3 - Hot 2
 J2 - Neutral 1
 J1 - Hot 1

Outputs

Voltage Monitor (4)

Cable design as of 20100525

Cable: From 4 BNC connectors to 4-Pin Lemo on DAQIC-2

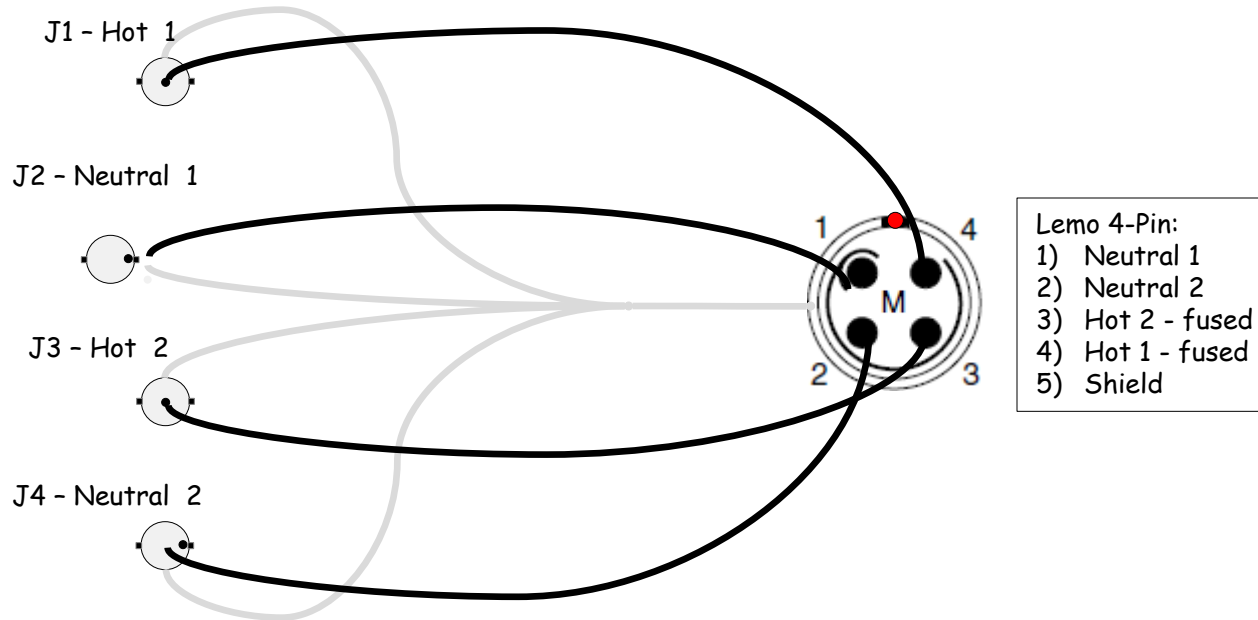

- Lights
- Vacuum Equipment
- Rechargeable Flashlights
- Computer Monitors
- Optical Isolators
- Trouble Lights
- Warning Signs
- Laser Hazard Status Signs
- Laser Danger Signs
- Loudspeakers
- Telephones

Weather Sensor locations

LLO network



LSU network

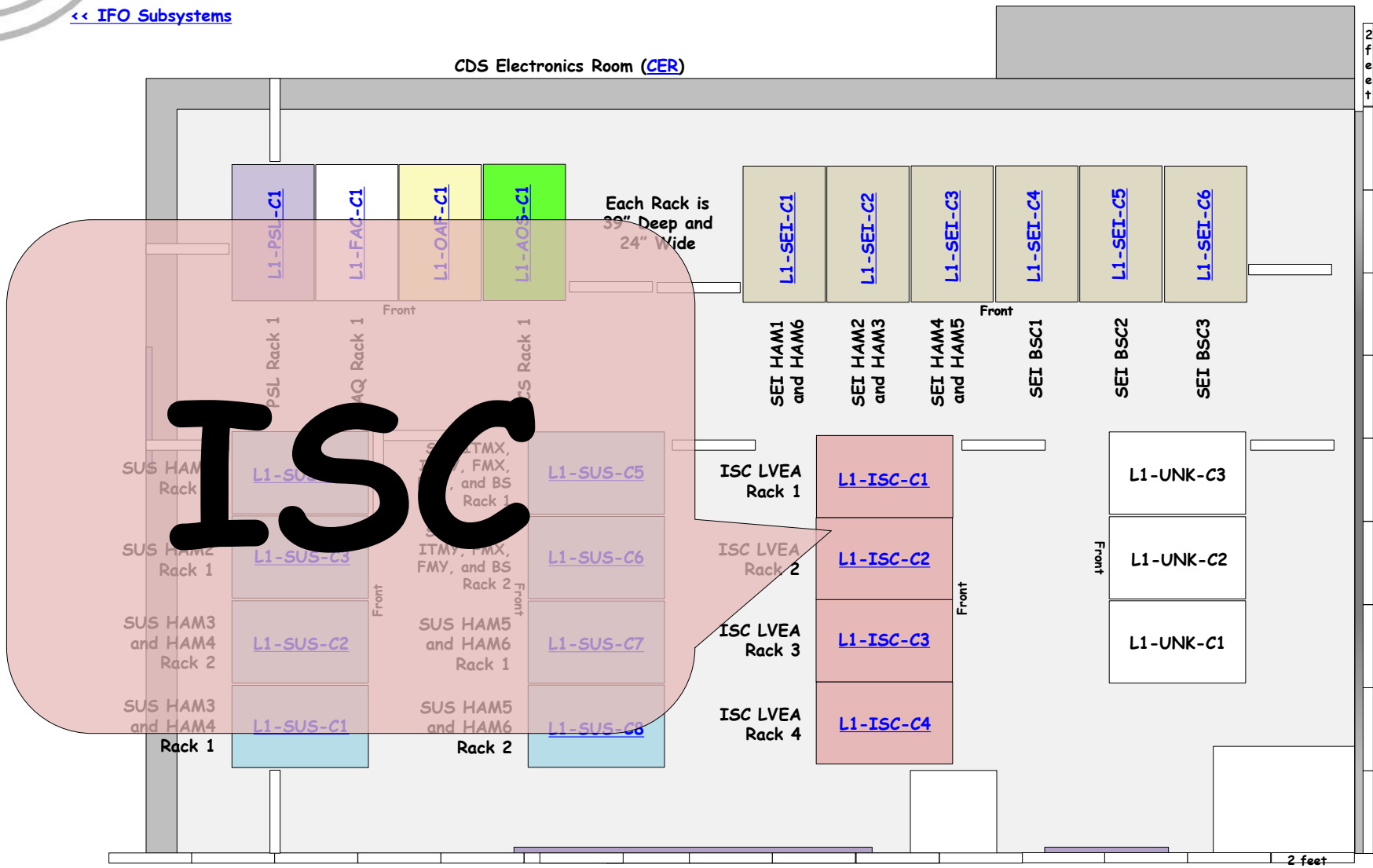

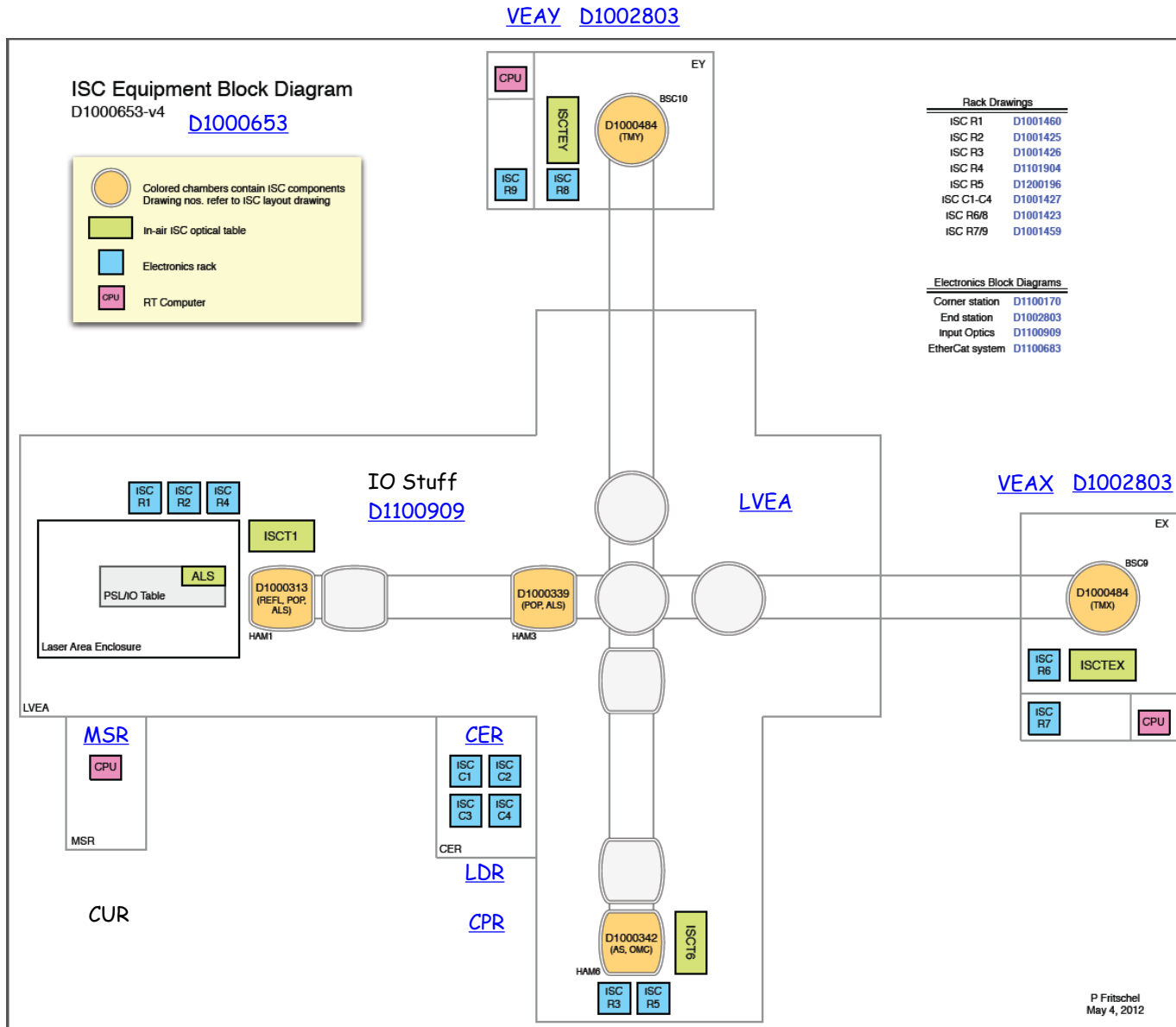

L1-ISC-C1

ISC LVEA Rack 1 Layout ([D1200949](#)) ([S1201186](#))

Beam Diverter Controller	Dxxxxxxx	42	Sxxxxxx	+?@1A
Beam Diverter Controller	Dxxxxxxx	41	Sxxxxxx	+?@1A
OMC Piezo Driver	Dxxxxxxx	40	Sxxxxxx	+?@1A
Anti-Alias Chassis (ASC)	D0902783	39	Sxxxxxx	+?@1A
Anti-Alias Chassis (ASC)	D0902783	38	S1102773	±18@0.5A
Anti-Alias Chassis (ASC)	D0902783	37	S1102772	±18@0.5A
Anti-Alias Chassis (ASC)	D0902783	36	S1102767	±18@0.5A
Anti-Alias Chassis (ASC)	D0902783	35	S1102769	±18@0.5A
Anti-Alias Chassis (ASC)	D0902783	34	S1102775	±18@0.5A
Anti-Alias Chassis (ASC)	D0902783	33	S1102771	±18@0.5A
Anti-Alias Chassis (ASC)	D0902783	32	S1102708	±18@0.5A
Anti-Alias Chassis (ASC)	D0902783	31	Sxxxxxx	±18@0.5A
ISC HAM-A Coil Driver (Tip/Tilt REFL)	D1100687	30	Sxxxxxx	±18@0.25A
ISC HAM-A Coil Driver (Tip/Tilt REFL)	D1100687	29	S1100610	±18@0.25A
ISC HAM-A Coil Driver (Tip/Tilt OMC)	D1100687	28	S1100607	±18@0.25A
ISC HAM-A Coil Driver (Tip/Tilt OMC)	D1100687	27	S1100603	±18@0.25A
ISC HAM-A Coil Driver (Tip/Tilt OMC)	D1100687	26	S1106047	±18@0.25A
ISC Anti-Image Chassis (ASC)	D070081	25	Sxxxxxx	±18@0.5A
ISC Anti-Image Chassis (ASC)	D070081	24	S1102756	±18@0.5A
11asc0 I/O Extension Chassis	D1001715	23	S1106300	+24@5A
ISC Anti-Alias Chassis (LSC)	D0902783	22	S1102768	±18@0.5A
ISC Anti-Alias Chassis (LSC)	D0902783	21	S1102779	±18@0.5A
ISC Anti-Image Chassis (LSC)	D070081	20	S1102757	±18@0.5A
11lsc0 I/O Extension Chassis	D1001715	19	S1106342	+24@5A
		18		
		17		
		16		
		15		
		14		
		13		
		12		
		11		
		10		
		9		
		8		
		7		
		6		
		5		
		4		
		3		
		2		
		1		

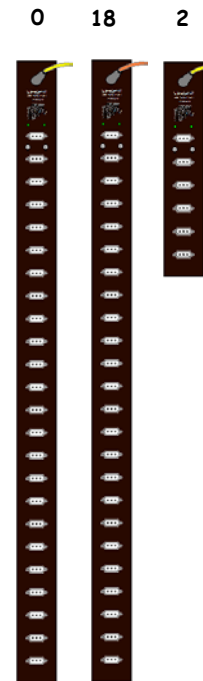

ISC-C1 is part of [D1001427](#).
 IO Diagram: [D1100909](#)
 Vertex ISC: [D1100170](#)

Front

Rear

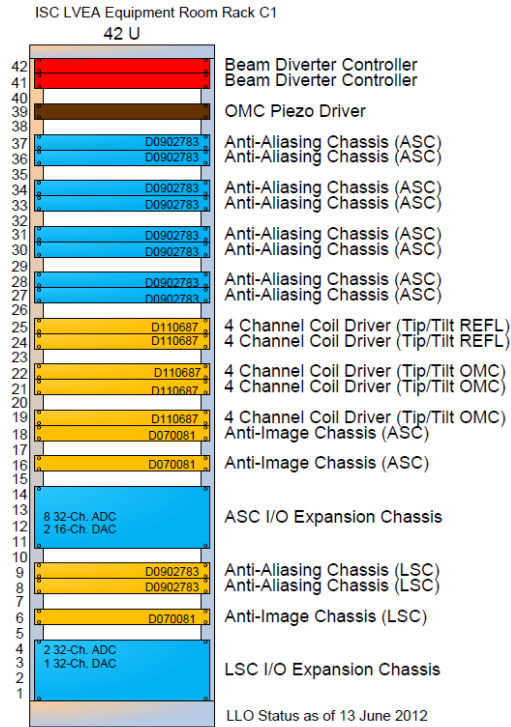

LIGO-D1001427-v13

([D1001427](#))

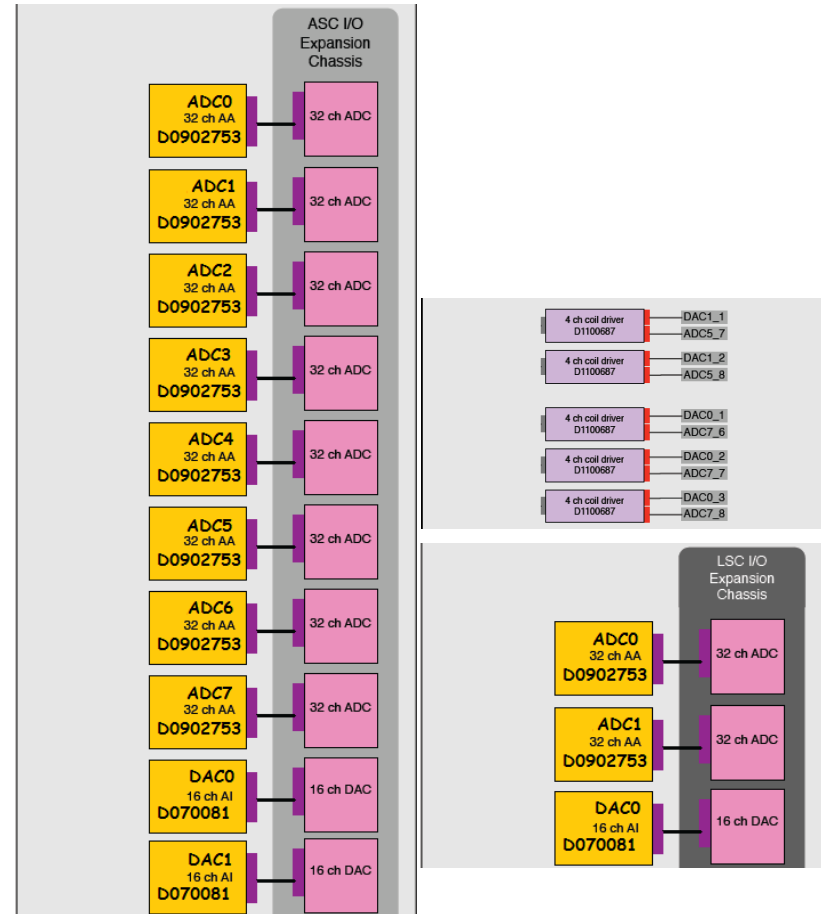

([D1100170](#))

L1-ISC-C1 Details

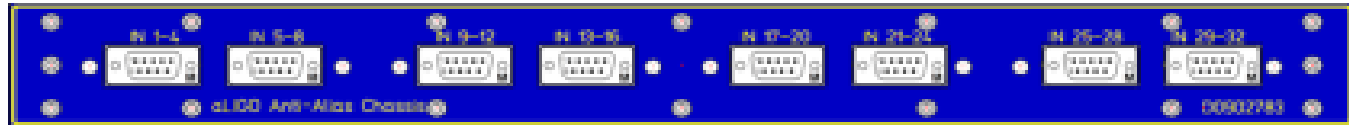

[D0902783](#)

Front

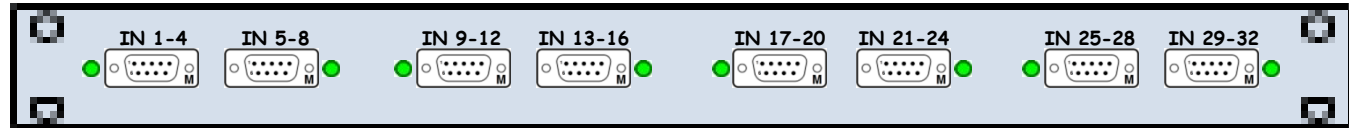

[D070081](#)

Front

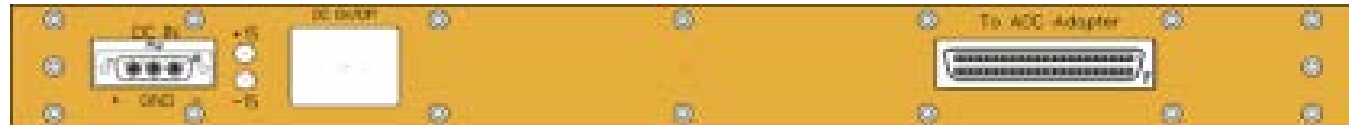
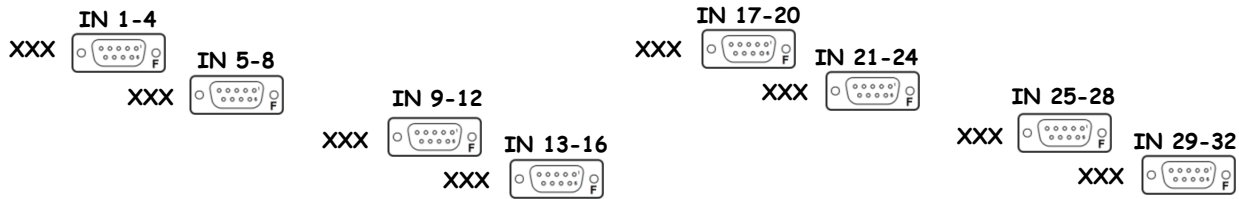

[S1102773](#)

Rear

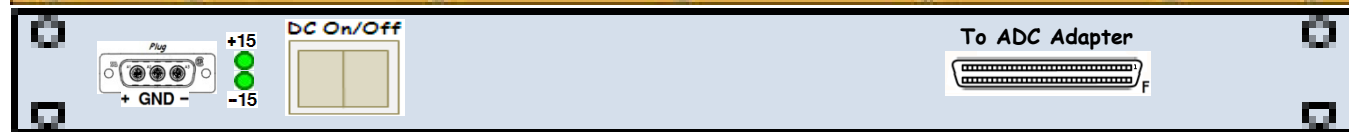

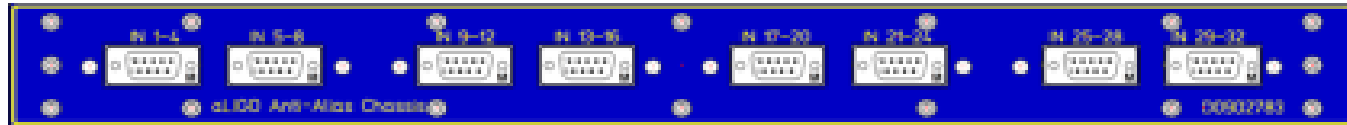

D0902783

Front

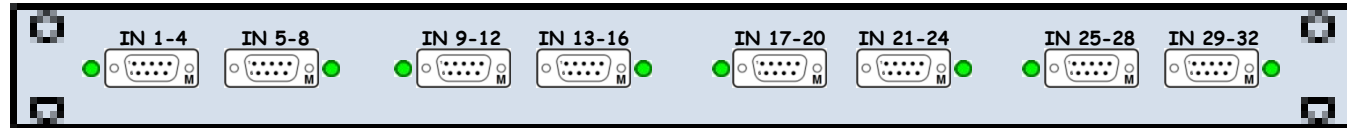

D070081

Front

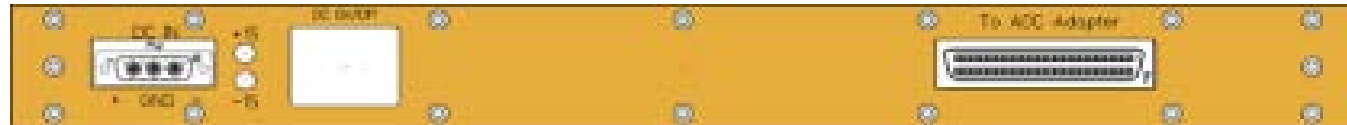
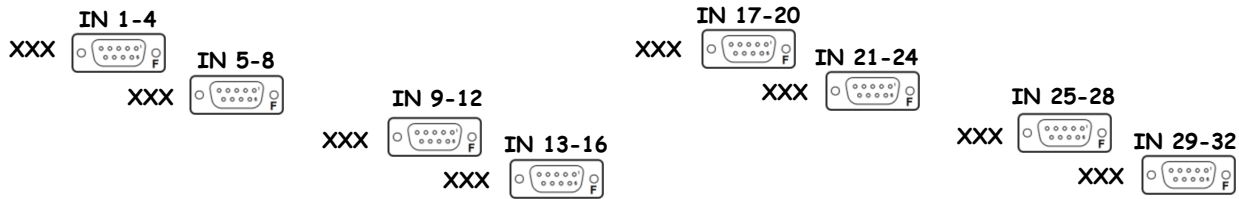

S1102772

Rear

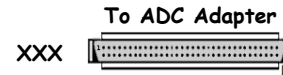
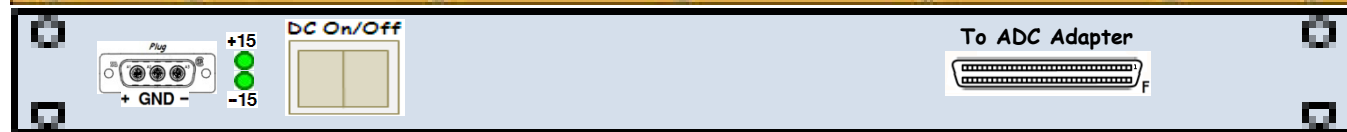

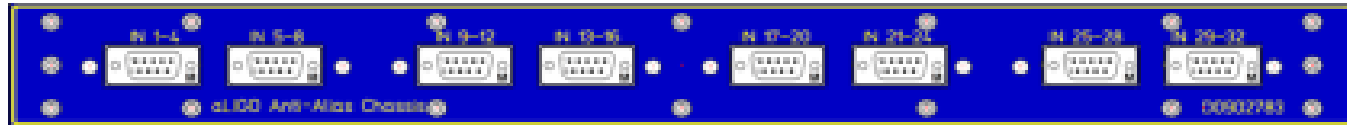

[D0902783](#)

Front

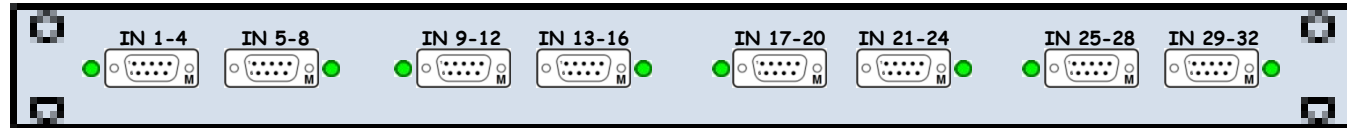

[D070081](#)

Front

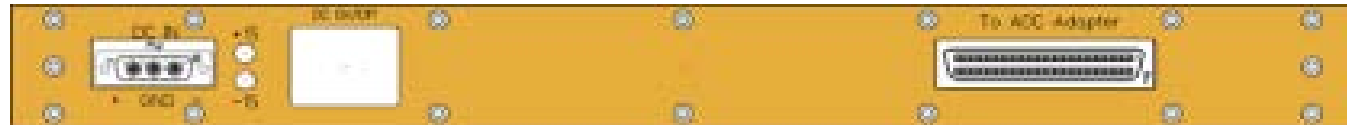
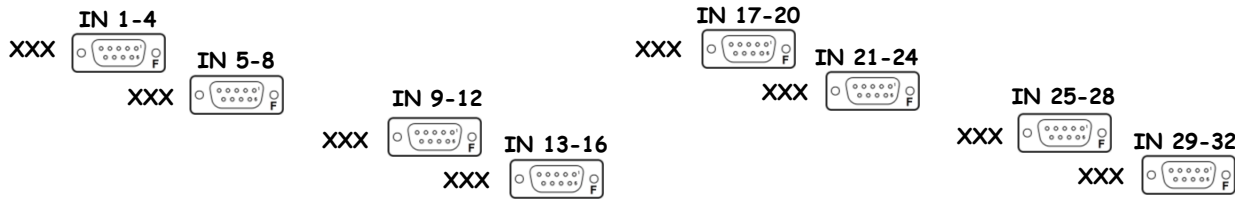

[S1102767](#)

Rear

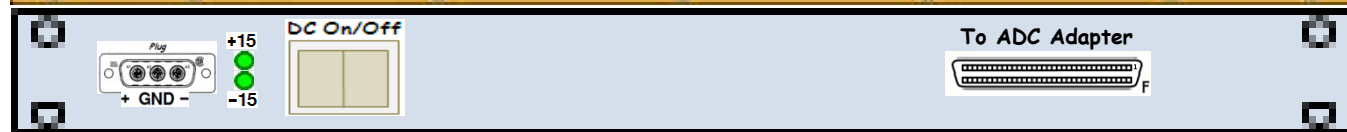

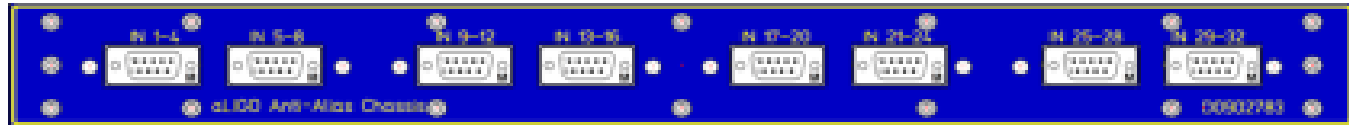

D0902783

Front

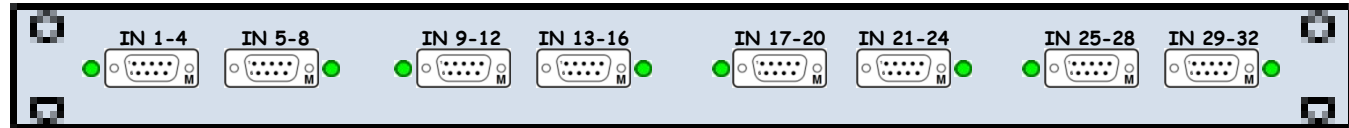

D070081

Front

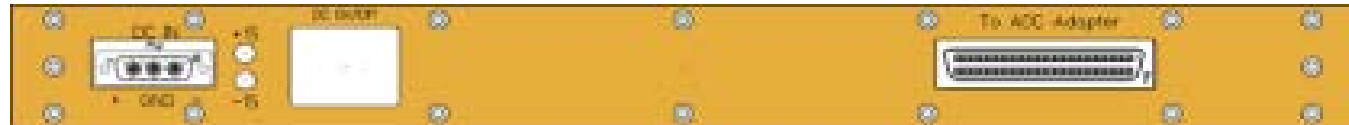
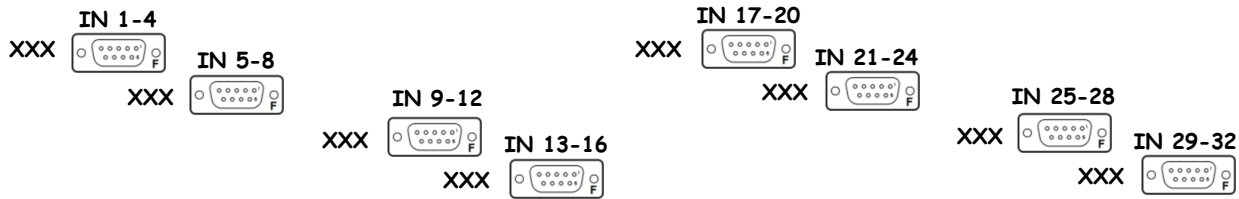

S1102769

Rear

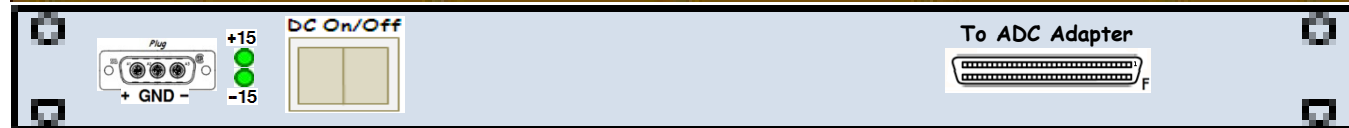

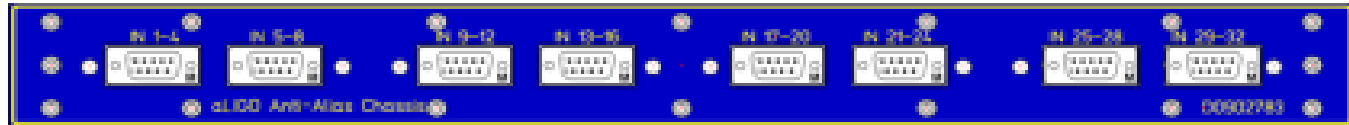

D0902783

Front

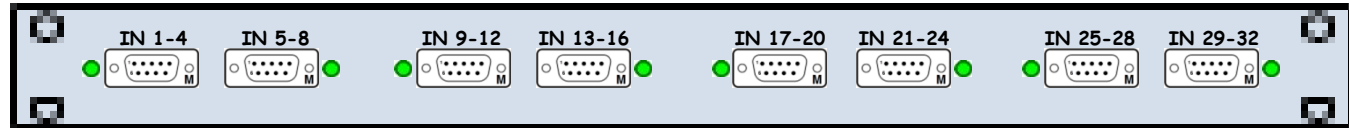

D070081

Front

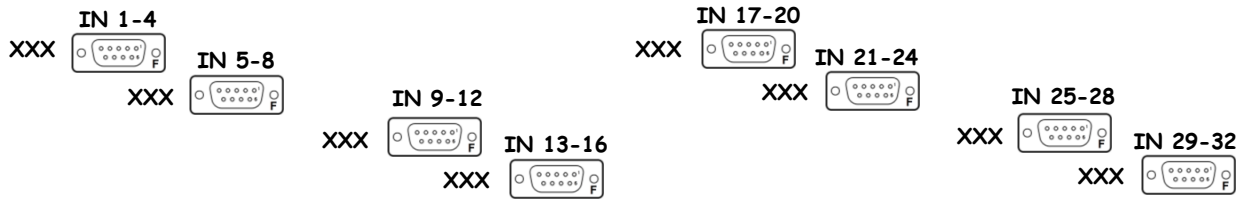

S1102775

Rear

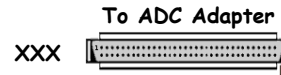
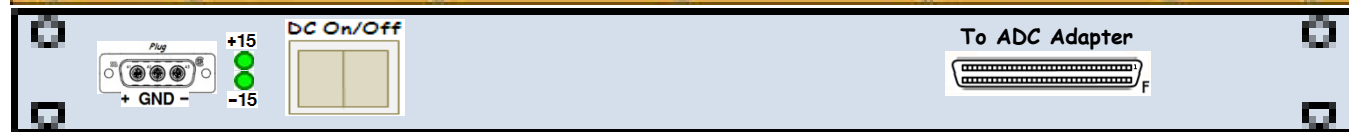

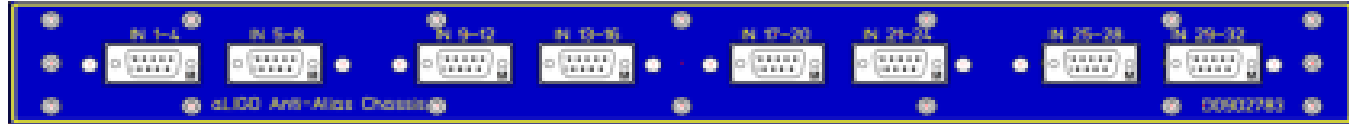

[D0902783](#)

Front

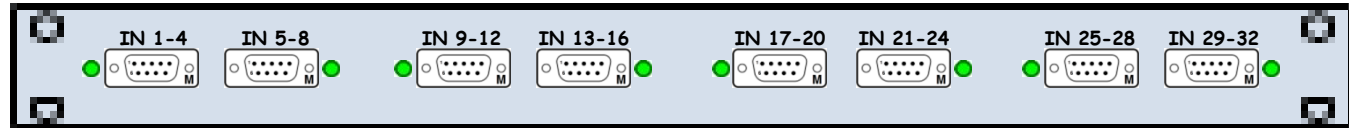

[D070081](#)

Front

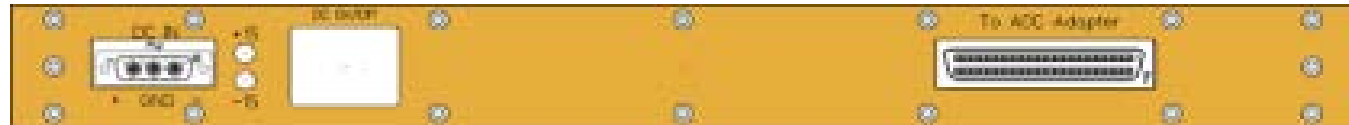
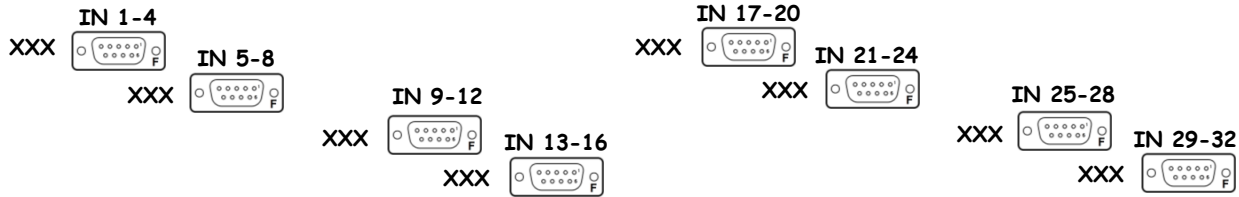

[S1102771](#)

Rear

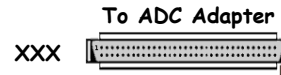
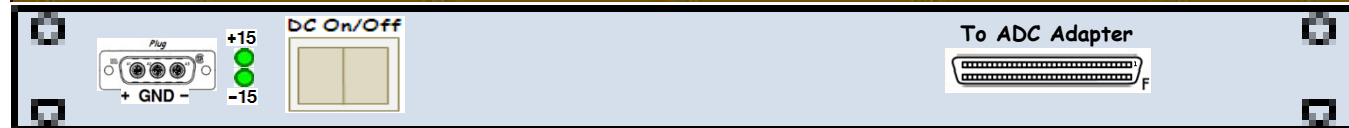

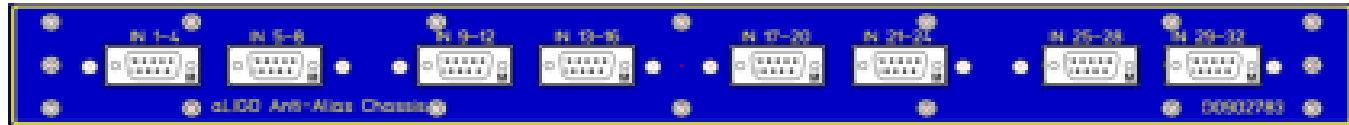

D0902783

Front

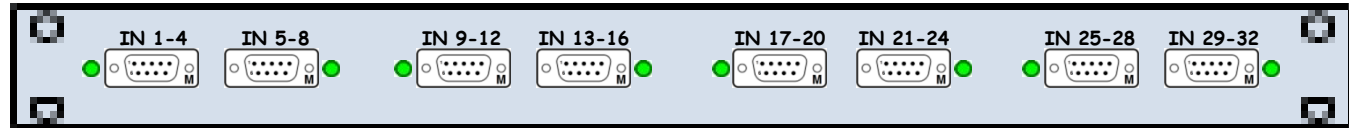

D070081

Front

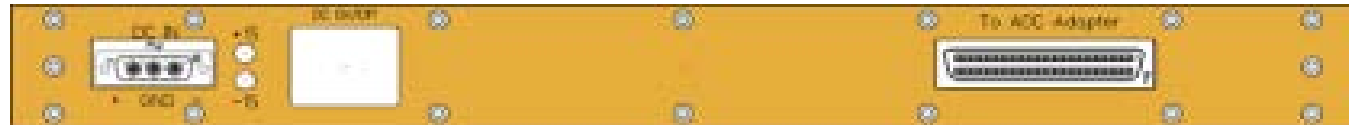
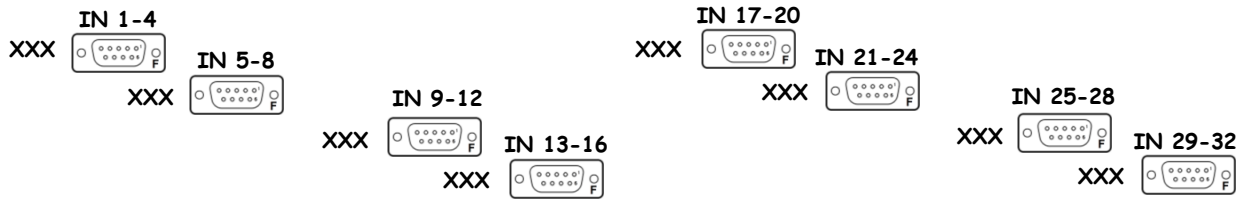

S1102708

Rear

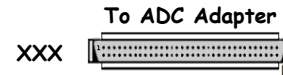
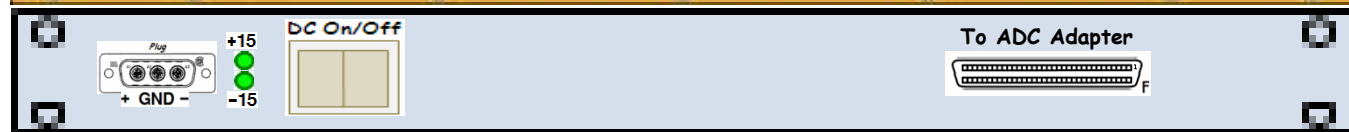

<< L1-ISC-C1

Anti-Alias Chassis (ASC) D0902783 Sxxxxxxx ±18@0.5A

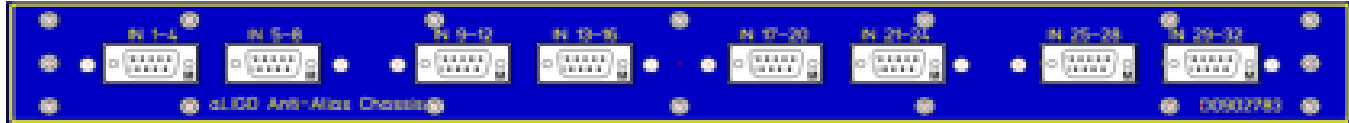

D0902783

Front

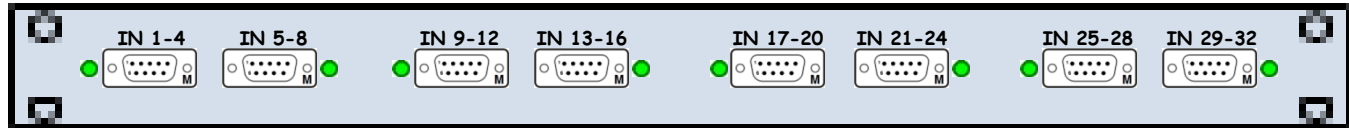

D070081

Front

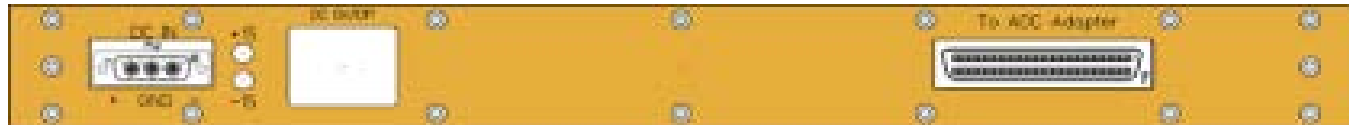
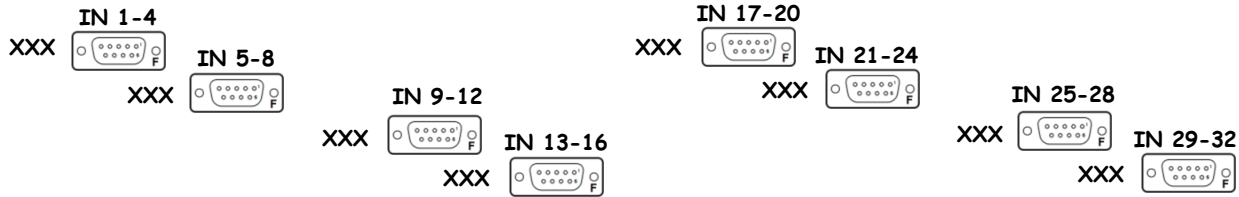

Sxxxxxxx

Rear

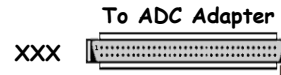
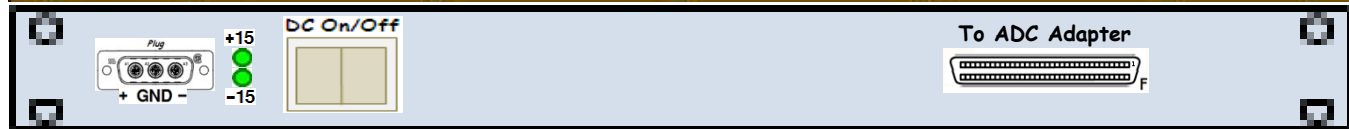

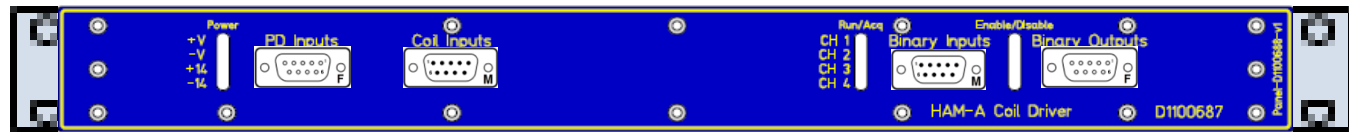

D1100687

Front

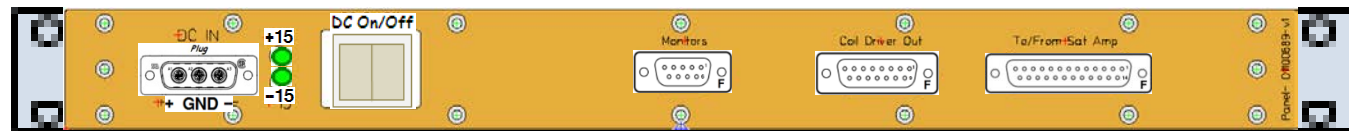
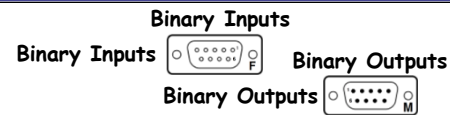
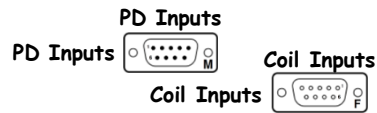

Sxxxxxxx

Rear

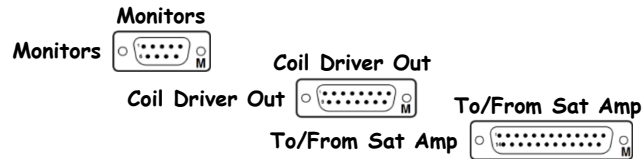

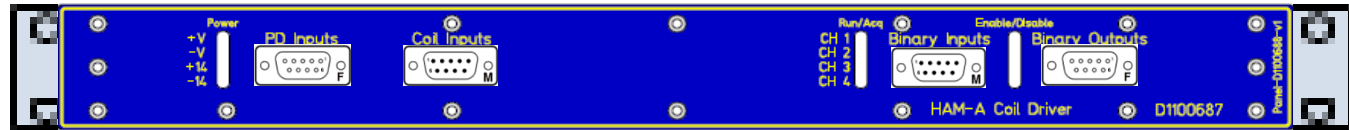

D1100687

Front

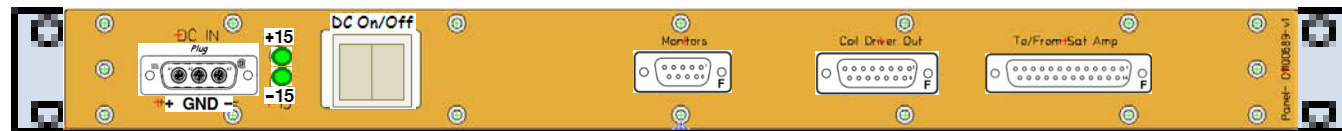
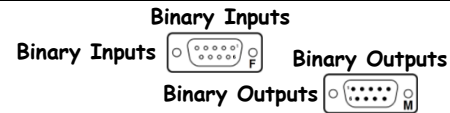
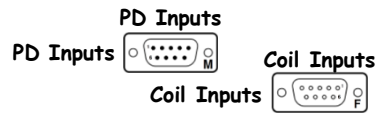

S1100610

Rear

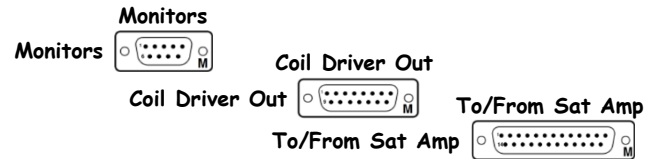

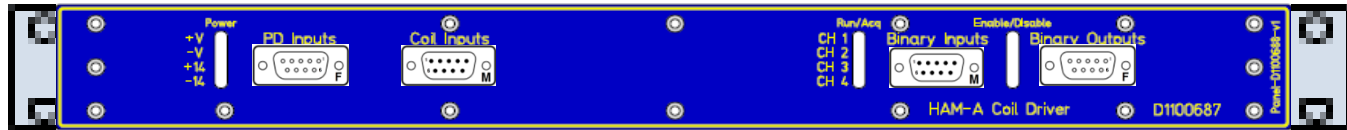

D1100687

Front

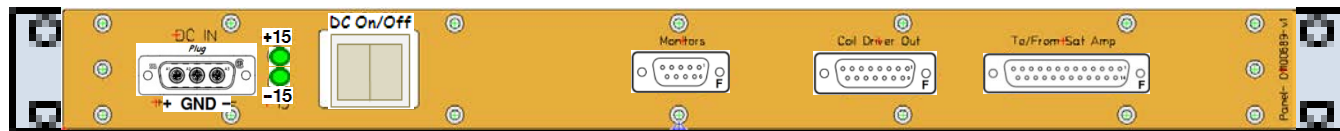
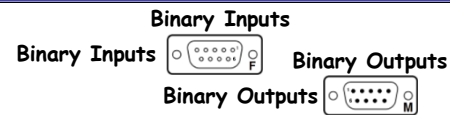
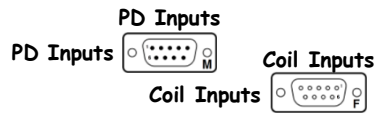

S1100607

Rear

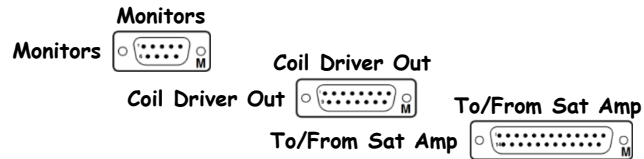

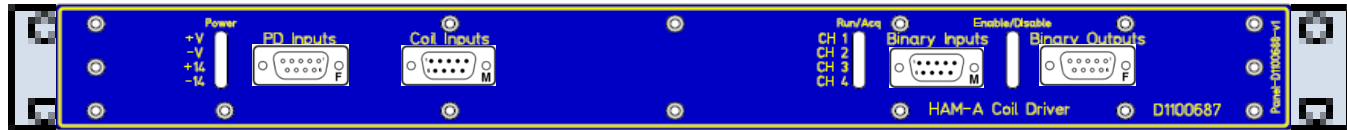

D1100688

Front

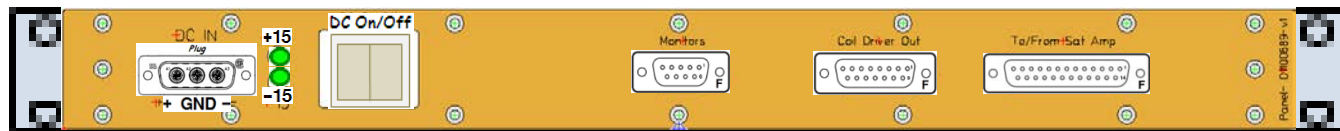
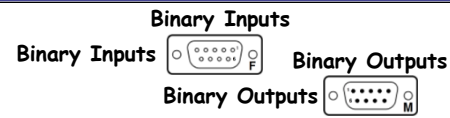
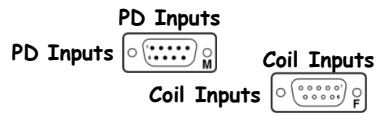

S1100603

Rear

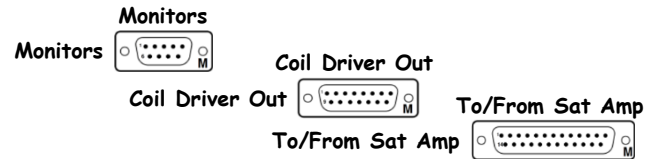

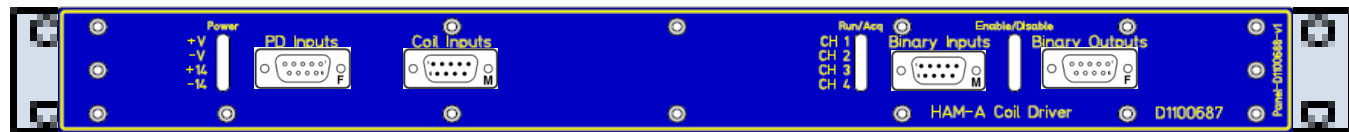

D1100687

Front

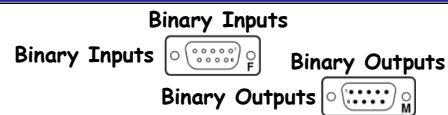
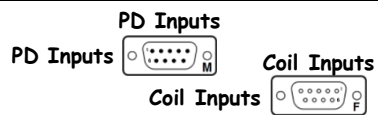

S1106047

Rear

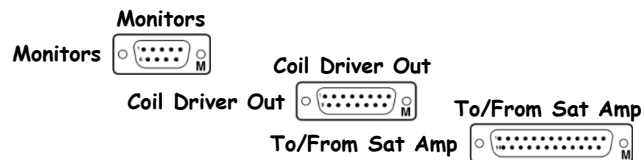

ISC Anti-Image Chassis (ASC) D070081 SN: ±18@0.5A

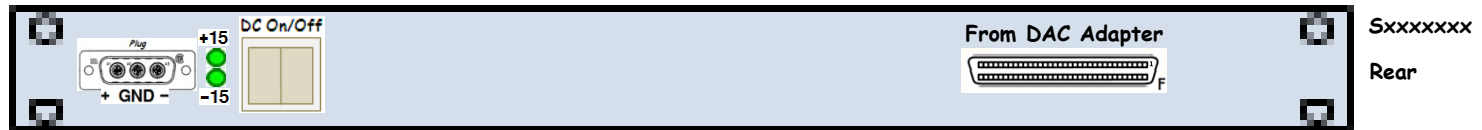

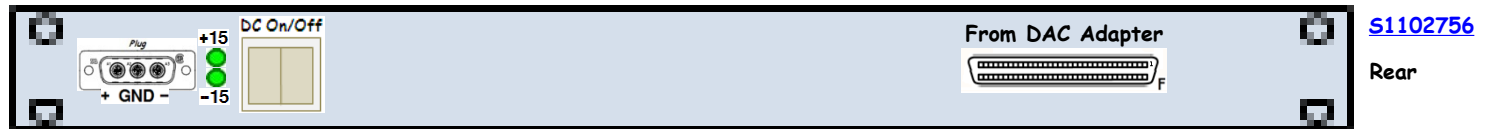



[D1001715](#)

Front

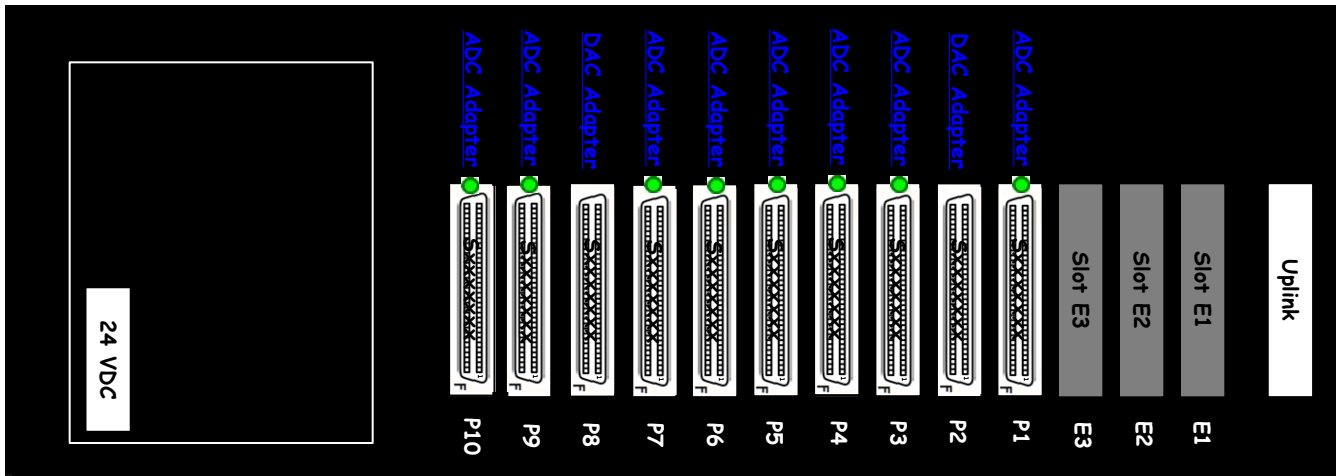

[S1106300](#)

Rear

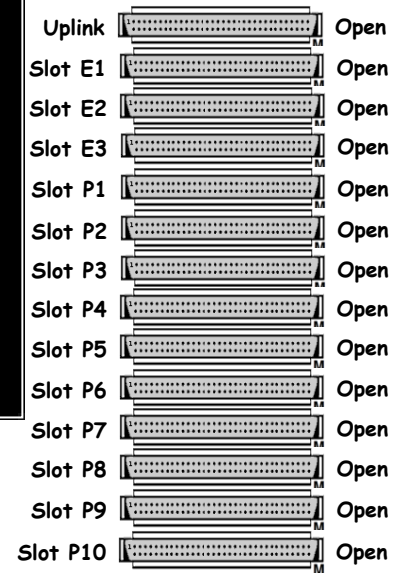

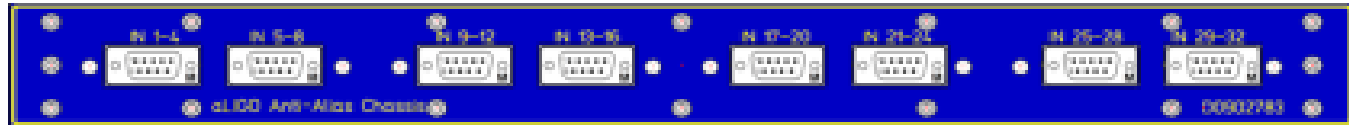

[D0902783](#)

Front

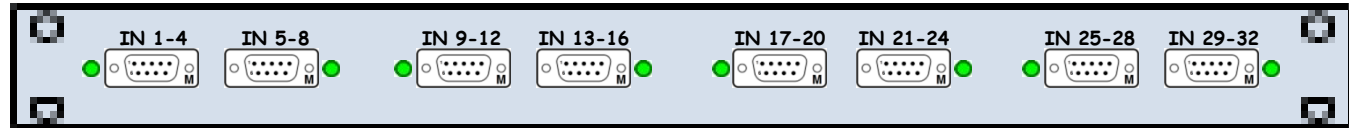

[D070081](#)

Front

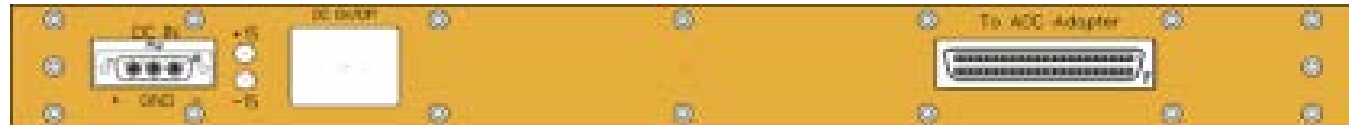
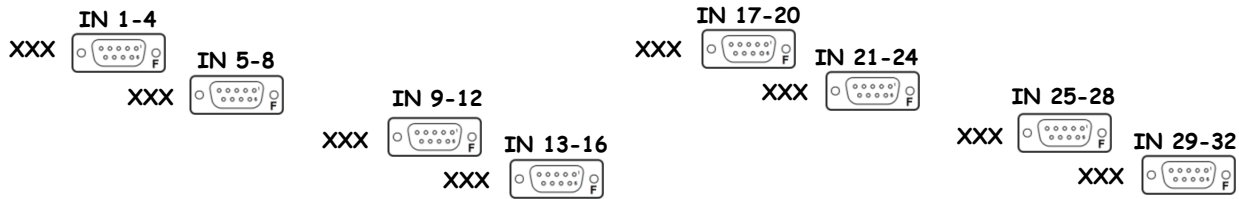

[S1102768](#)

Rear

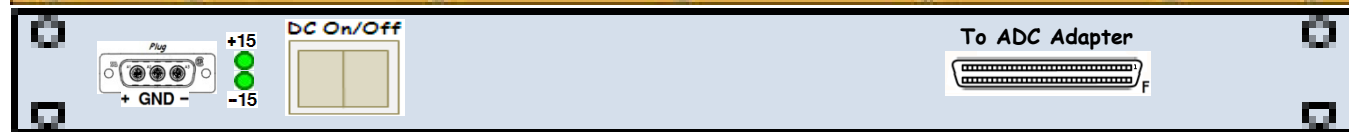

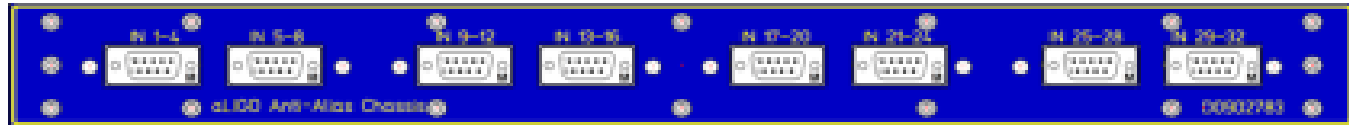

[D0902783](#)

Front

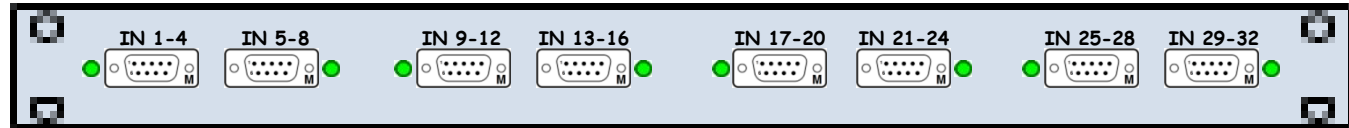

[D070081](#)

Front

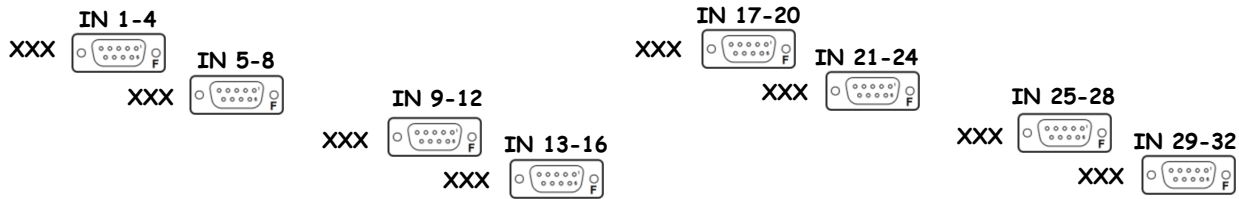

[S1102779](#)

Rear

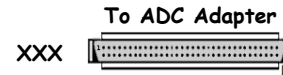
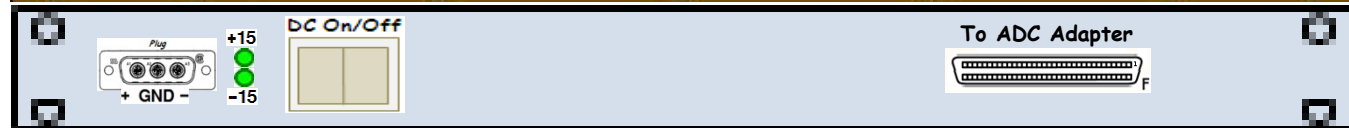

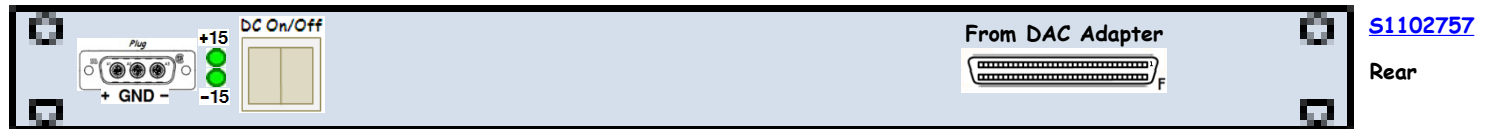

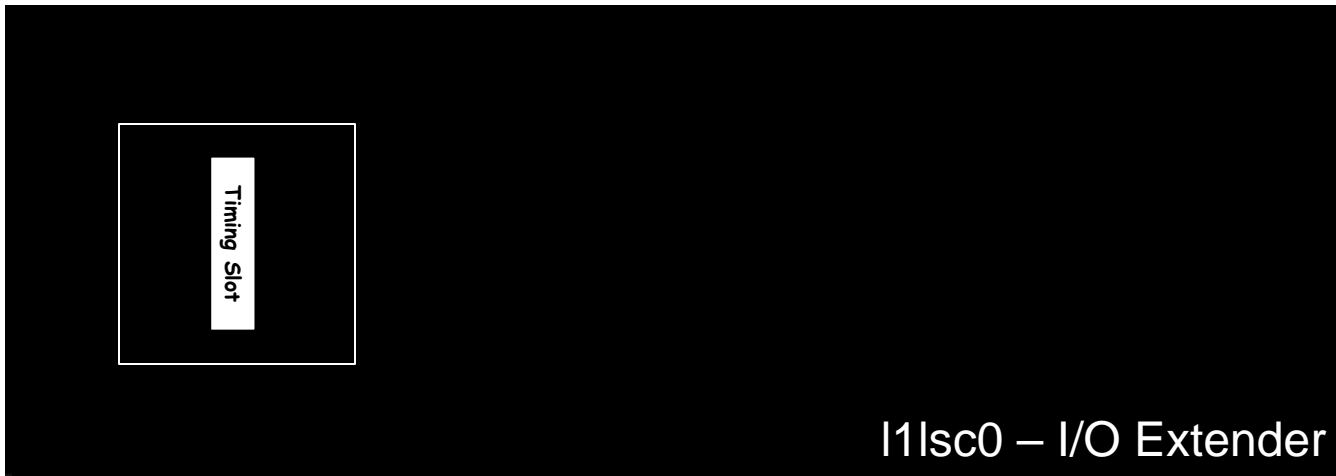

[D1001715](#)

Front

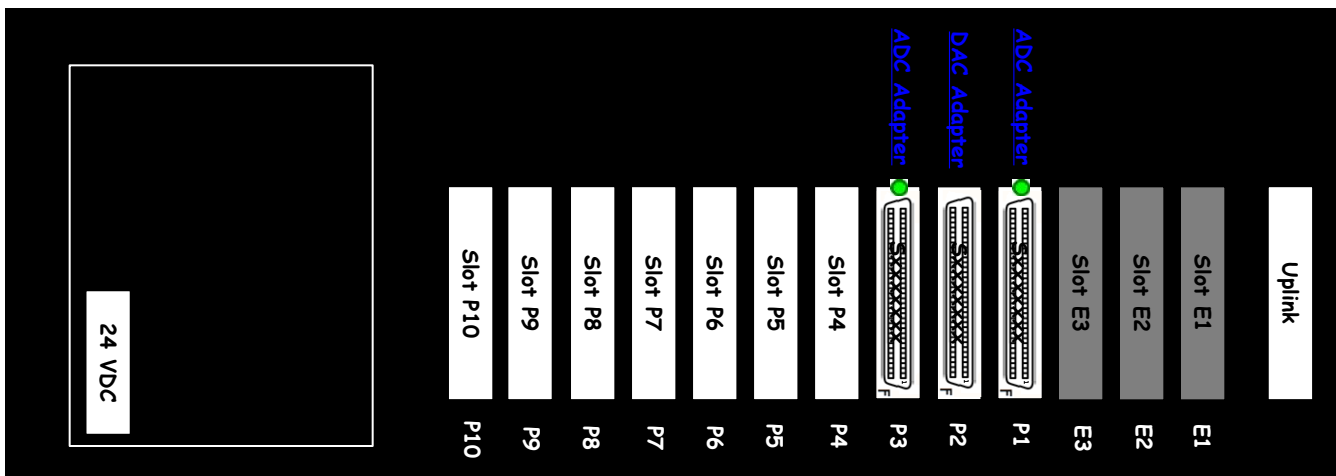

[S1106342](#)

Rear

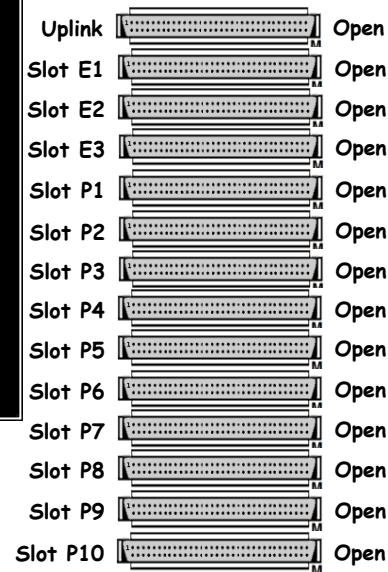

L1-ISC-C2

ISC LVEA Rack 2 Layout ([D1200975](#)) ([S1201187](#))

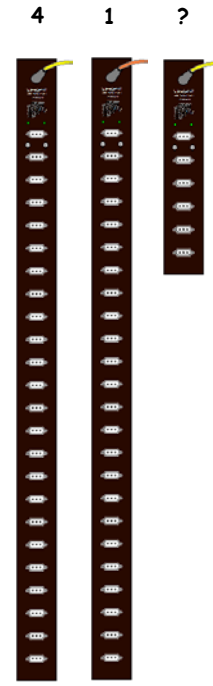
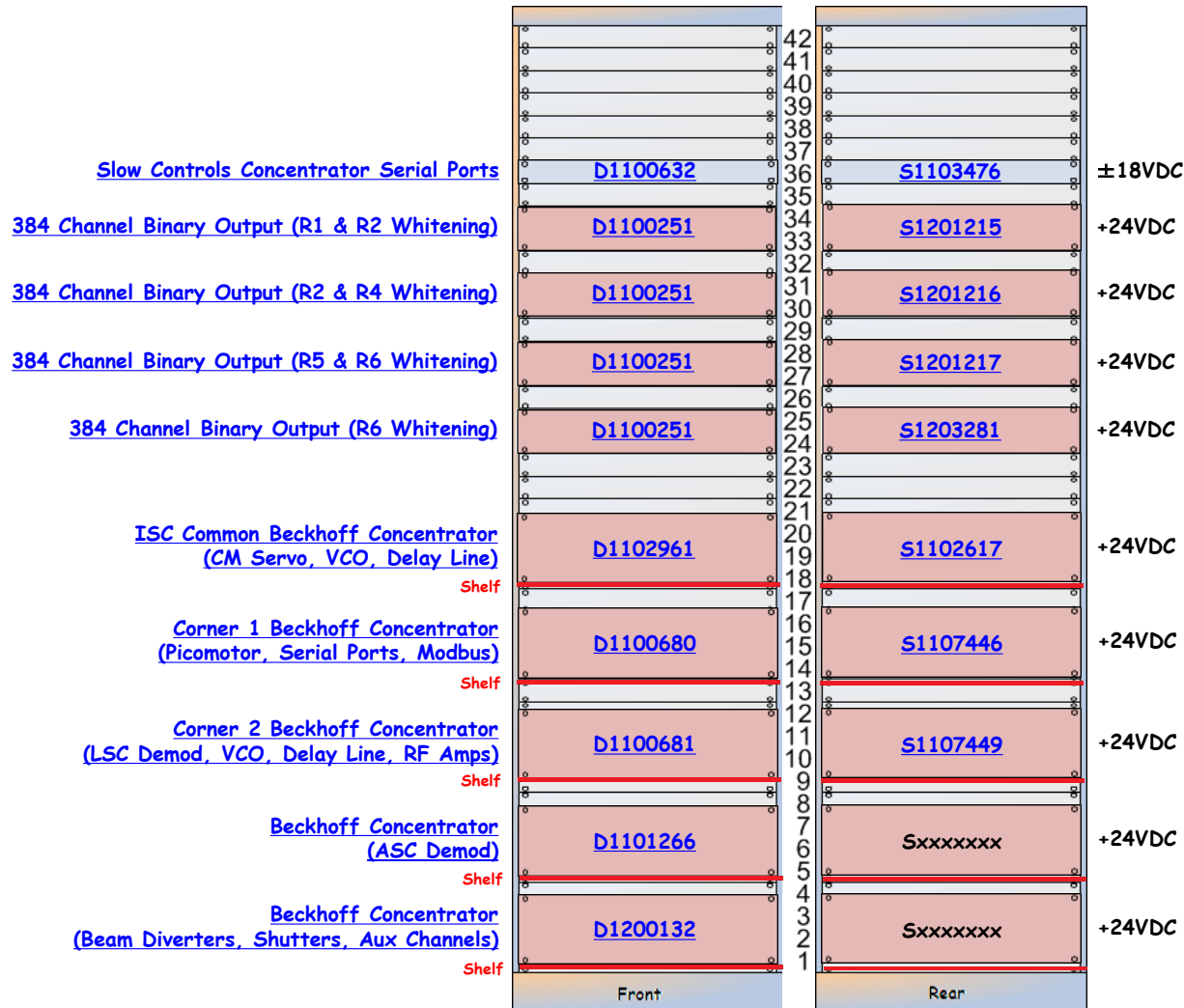

ISC-C2 is part of [D1001427](#).

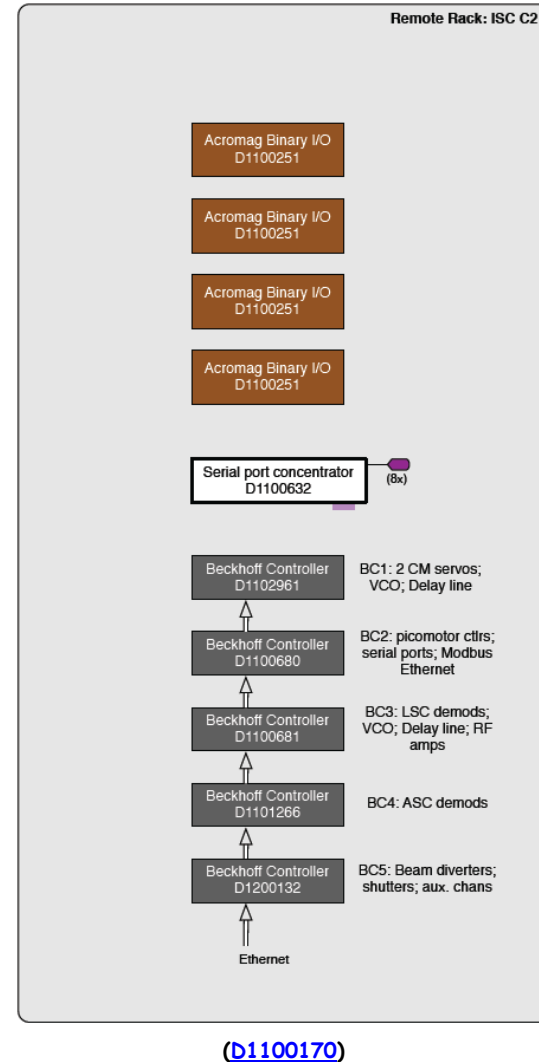
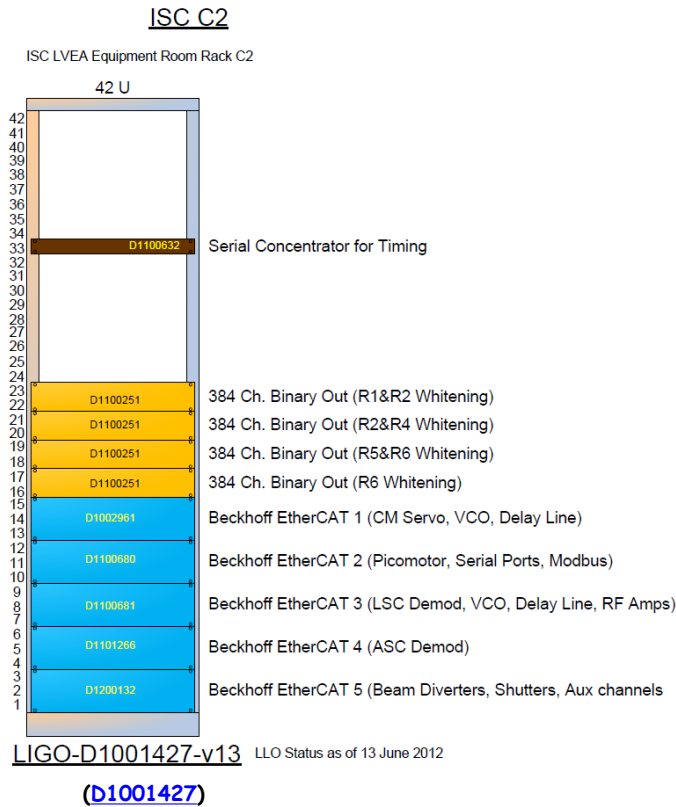

L1-ISC-C2 Details

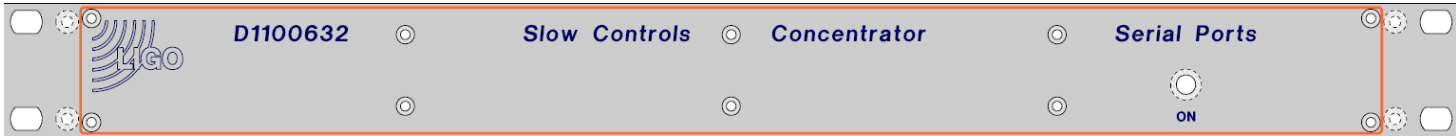

[D1100632](#)

Front

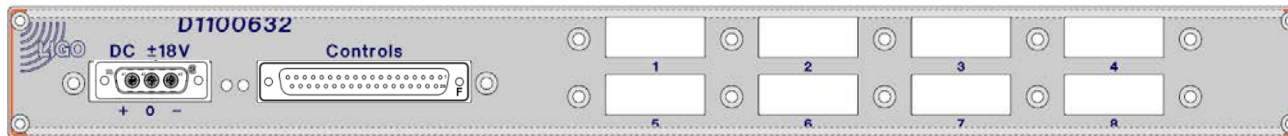

[S1103476](#)

Rear



384 Channel Binary Output (R1 & R2 Whitening)

D1100251

S1201215

+24VDC

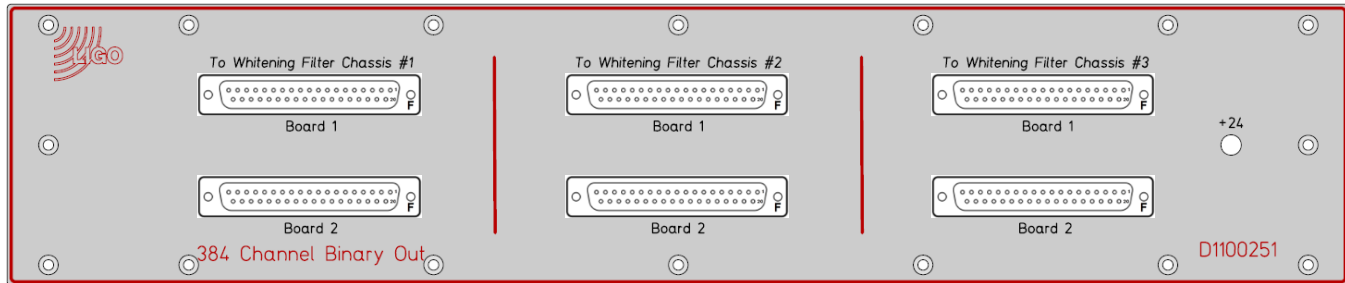

D1100251

Front

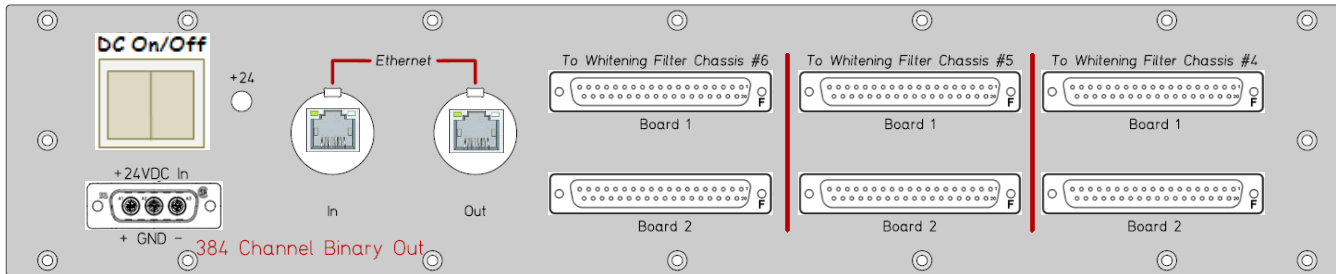
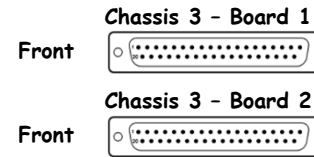
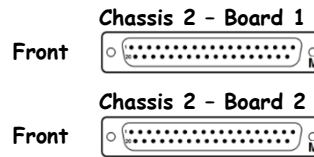
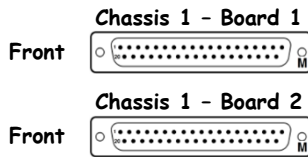

S1201215

Rear

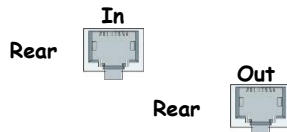
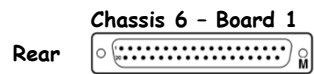
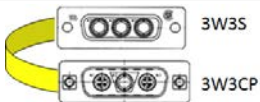

384 Channel Binary Output (R2 & R4 Whitening)

D1100251

S1201216

+24VDC

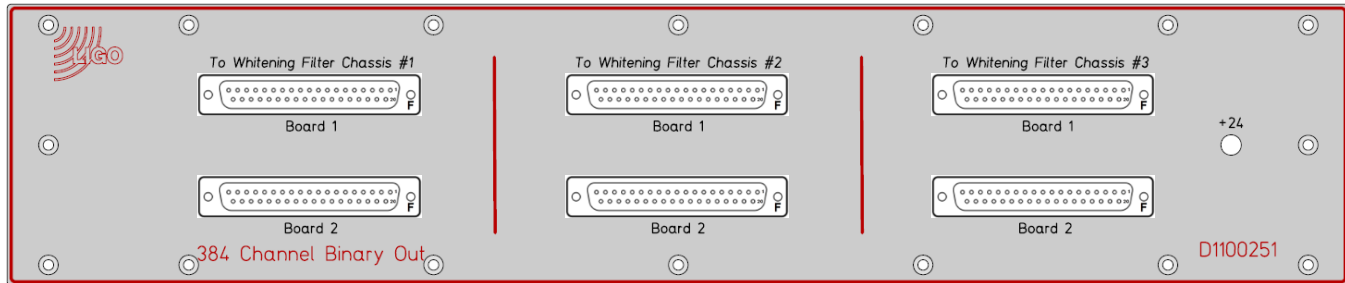

D1100251

Front

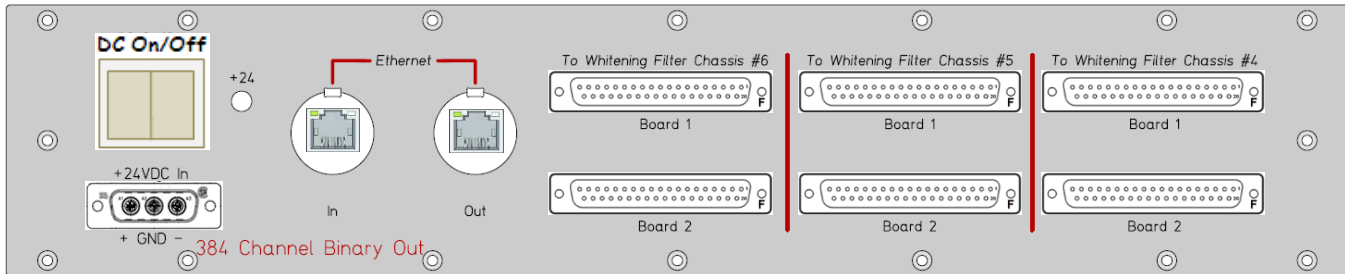
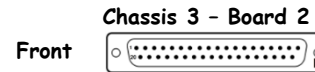
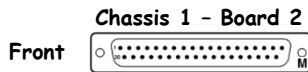
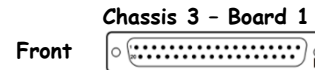
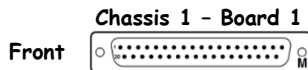

S1201216

Rear

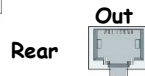
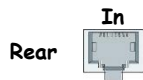
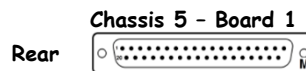
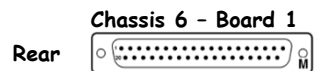
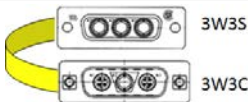

384 Channel Binary Output (R5 & R6 Whitening)

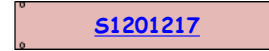
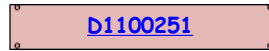

+24VDC

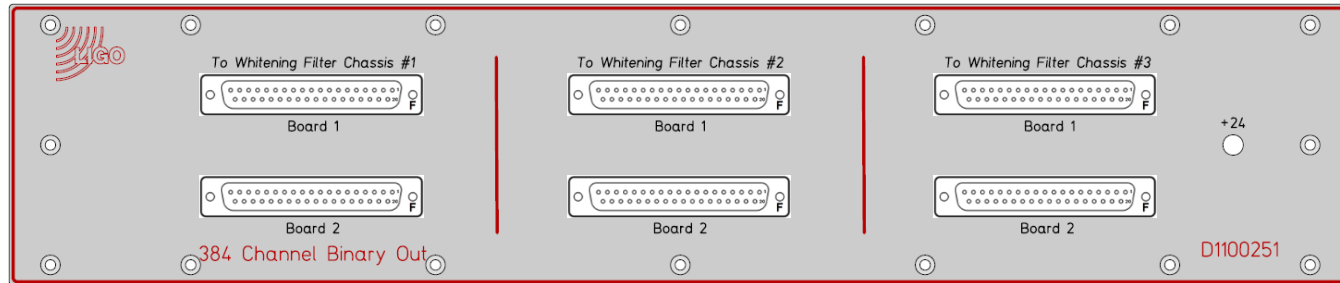

D1100251

Front

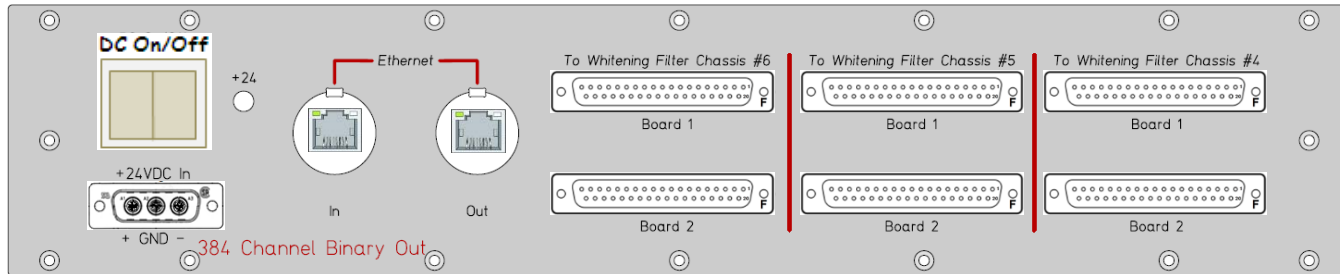
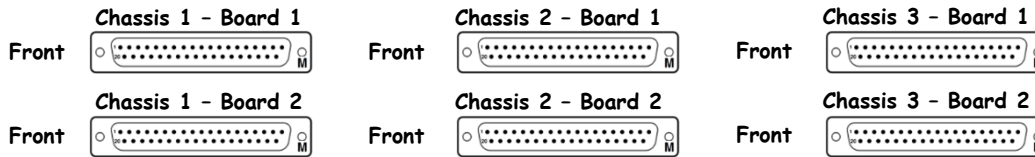

S1201217

Rear

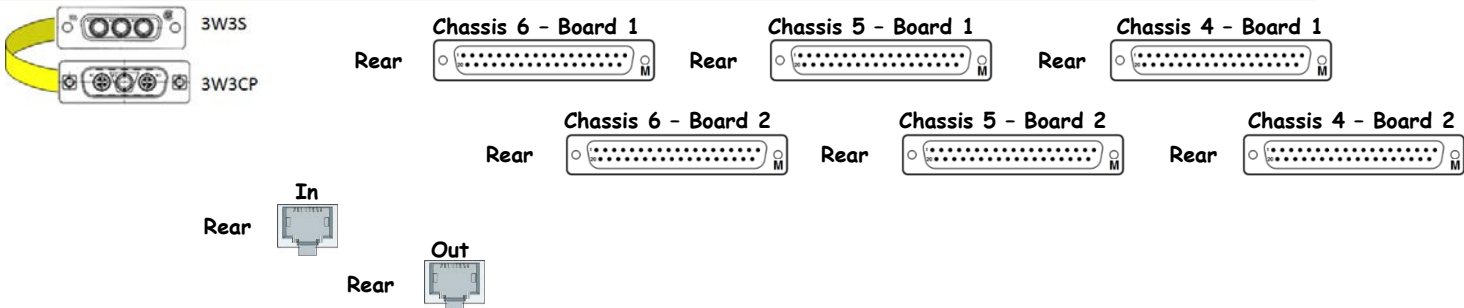

384 Channel Binary Output (R6 Whitening)

D1100251

S1203281

+24VDC

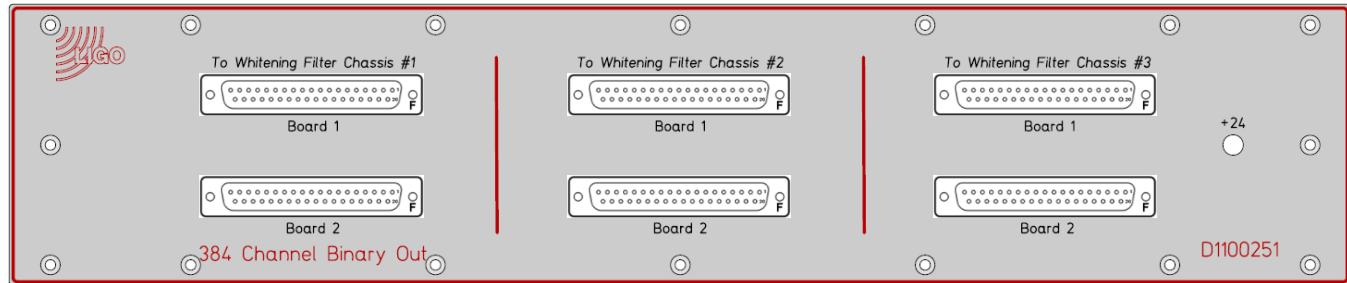

D1100251

Front

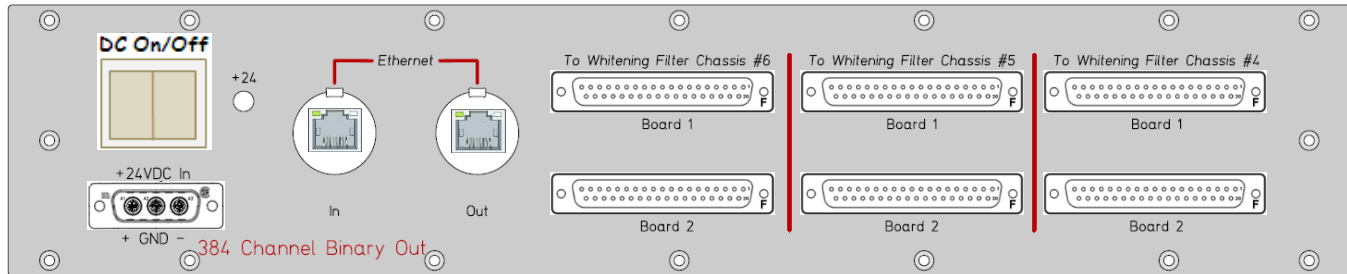
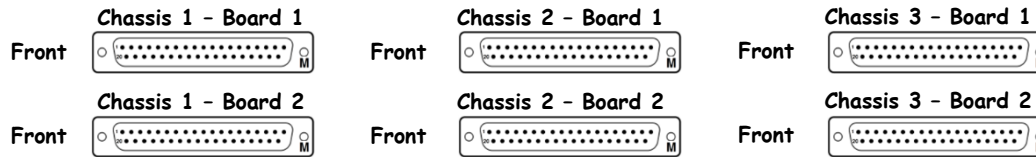

S1203281

Rear

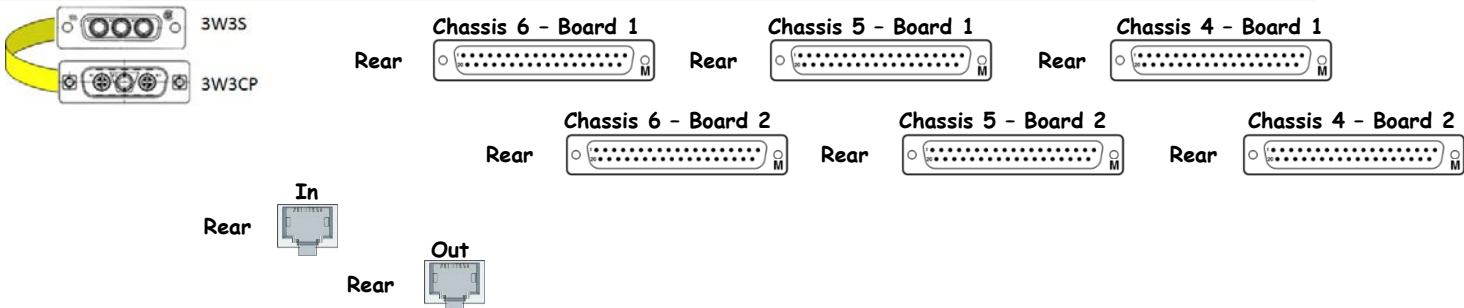

<< [L1-ISC-C2](#)

ISC Common Beckhoff Concentrator
(CM Servo, VCO, Delay Line)

[D1102961](#)

[S1102617](#)

Power

[D1102961](#)

Front

[S1102617](#)

Rear

DC On/Off

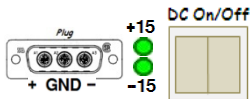

From DAC Adapter

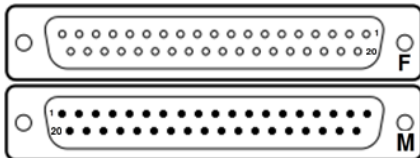

<< [L1-ISC-C2](#)

Corner 1 Beckhoff Concentrator
(Picomotor, Serial Ports, Modbus)

[D1100680](#)

[S1107446](#)

Power

[D1100680](#)

Front

[S1107446](#)

Rear

DC On/Off

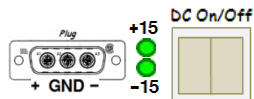

From DAC Adapter

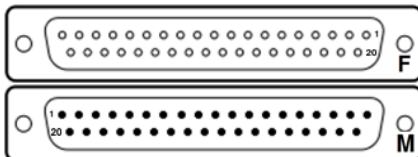
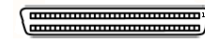

<< [L1-ISC-C2](#)

Corner 2 Beckhoff Concentrator
(LSC Demod, VCO, Delay Line, RF Amps)

[D1100681](#)

[S1107449](#)

Power

[D1100681](#)

Front

[S1107449](#)

Rear

DC On/Off

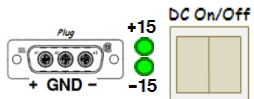

From DAC Adapter

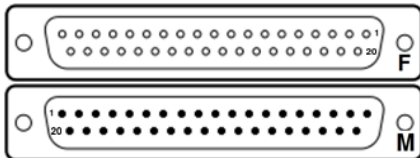

<< [L1-ISC-C2](#)

Beckhoff Concentrator
(ASC Demod)

[D1101266](#)

Sxxxxxxx

Power

[D1101266](#)

Front

Sxxxxxxx

Rear

DC On/Off

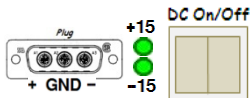

From DAC Adapter

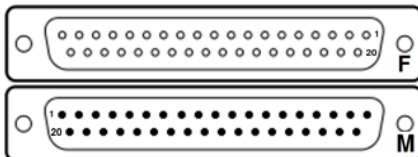

<< [L1-ISC-C2](#)

Beckhoff Concentrator
(Beam Diverters, Shutters, Aux Channels)

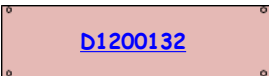

Power

[D1200132](#)

Front

DC On/Off

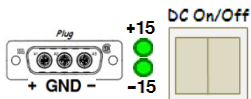

Sxxxxxxx

Rear

From DAC Adapter

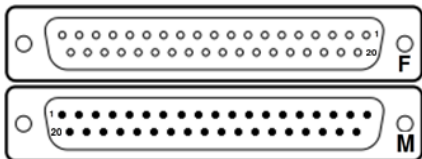
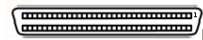



RF Patch Panel 7
RF Patch Panel 8
RF Patch Panel 9 (TCS)

[21.5 MHz RF Source](#)
[21.5 MHz Distribution Amplifier](#)
[35.5 MHz RF Source](#)
[35.5 MHz Distribution Amplifier](#)

[80 MHz RF Source](#)
[80 MHz Distribution Amplifier](#)
[40 MHz Frequency Divider](#)
[40 MHz Distribution Amplifier](#)
[10 MHz Frequency Divider](#)
[10 MHz Distribution Amplifier](#)

[RF Amplifier Concentrator 1](#)
[RF Amplifier Concentrator 2](#)

[Timing Comparator / Frequency Counter](#)
[Timing Fanout Module](#)

	Dxxxxxxx	42	Sxxxxxxx	No Power
		41		
	Dxxxxxxx	40	Sxxxxxxx	No Power
		39		
	Dxxxxxxx	38	Sxxxxxxx	No Power
		37		
		36		
		35		
		34		
		33		
	D080702	32	S1000546	+12VDC, ±24VDC
	D1000124	31		
	D1000124	30	S1000649	±17VDC, ±24VDC
		29		
	D080702	28	S1000551	+12VDC, ±24VDC
	D1000124	27	S1000650	±17VDC, ±24VDC
		26		
	D080702	25	S1000567	+12VDC, ±24VDC
	D1000124	24		
	D1002182	23	S1000654	±17VDC, ±24VDC
	D1000124	22	S1000751	±17VDC, ±24VDC
	D1100974	21	S1000655	±17VDC, ±24VDC
	D1000124	20	S1103488	±17VDC, ±24VDC
		19	S1000671	±17VDC, ±24VDC
		18		
	D1100262	17	S1103461	±18VDC
	D1100262	16		
		15	S1103460	±18VDC
		14		
		13		
	D1001370	12	Sxxxxxxx	+12VDC
	D070011	11	Sxxxxxxx	+12VDC
		10		
		9		
		8		
		7		
		6		
		5		
		4		
		3		
		2		
		1		
Front			Rear	

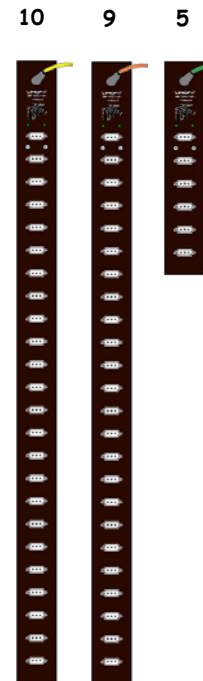

ISC-C3 is part of [D1001427](#).

ISC C3

ISC LVEA Equipment Room Rack C3

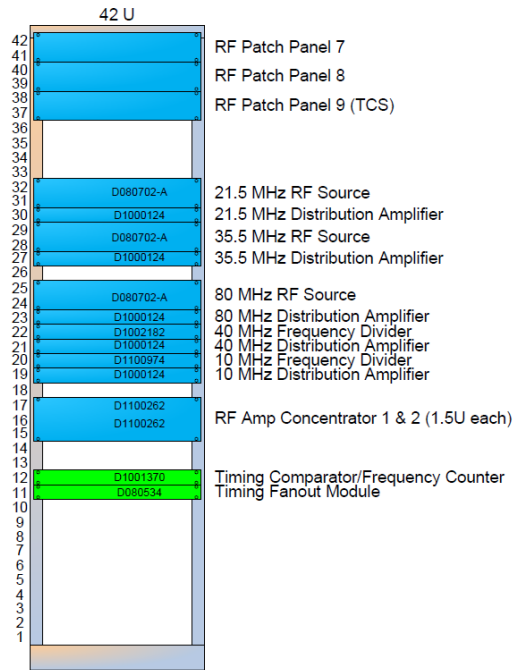

LIGO-D1001427-v13 Status as of 13 June 2012

([D1001427](#))

Remote Rack: ISC C3

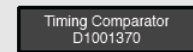
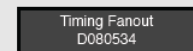
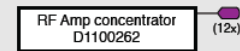
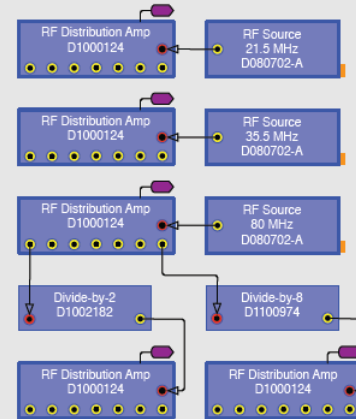

([D1100170](#))

L1-ISC-C3 Details

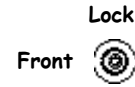
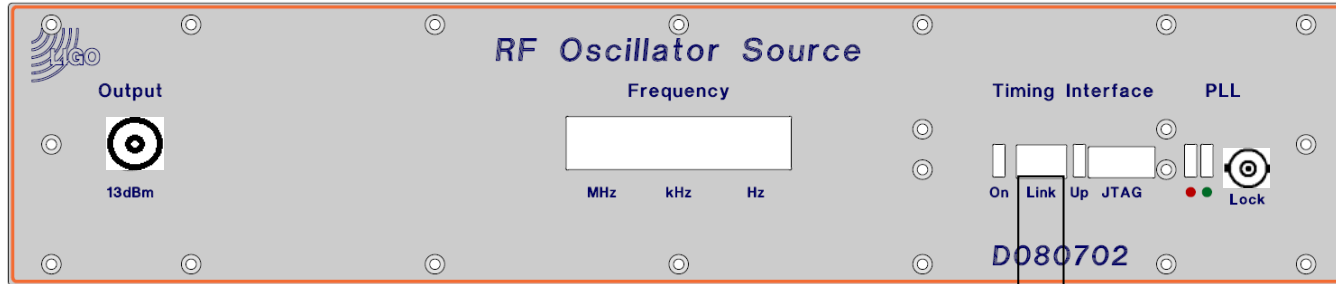

To ...

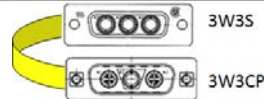
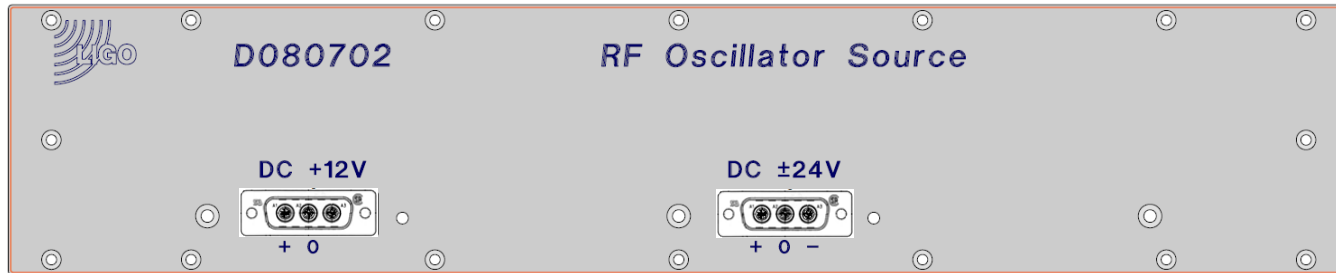

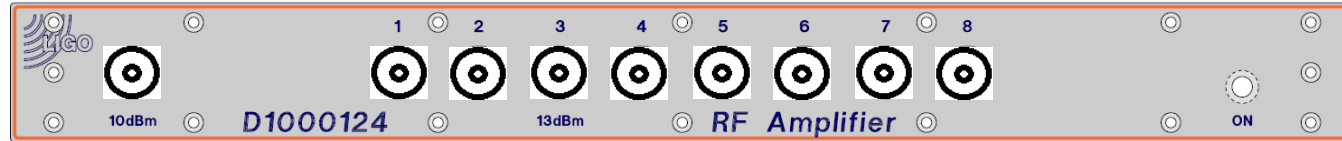

D1000124

Front

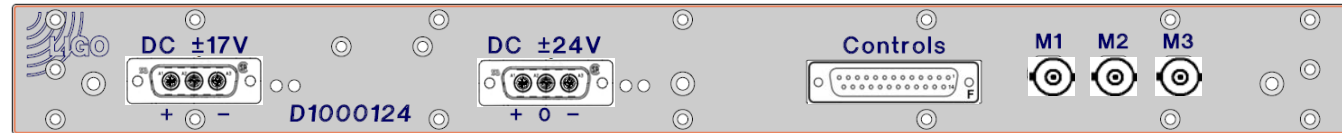
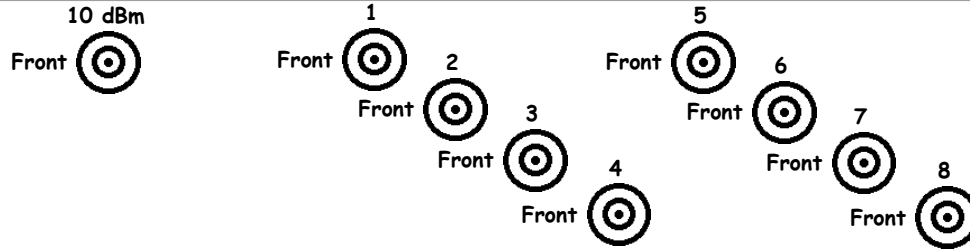

S1000649

Rear

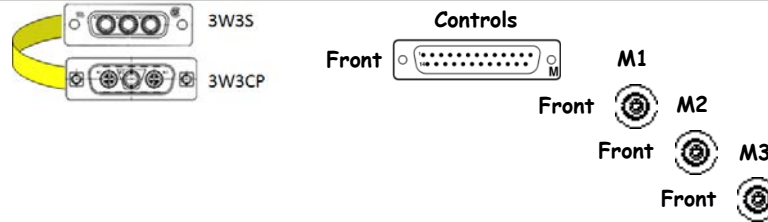

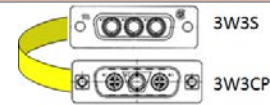
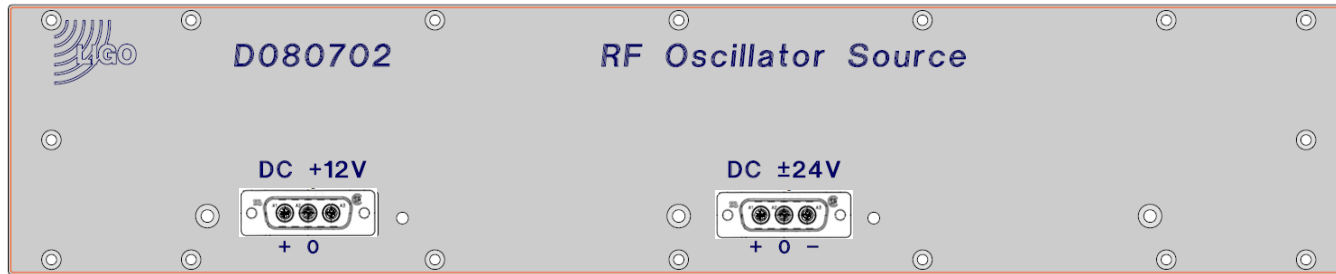
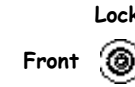
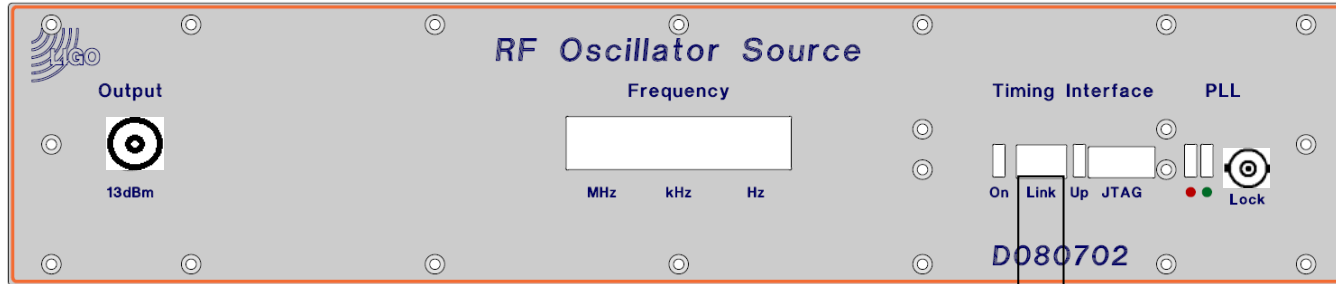

D080702

Front

S1000551

Rear

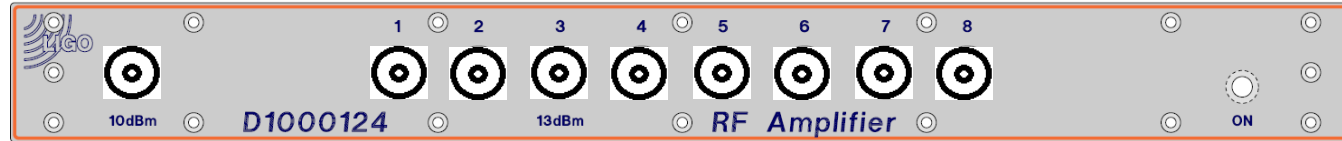

D1000124

Front

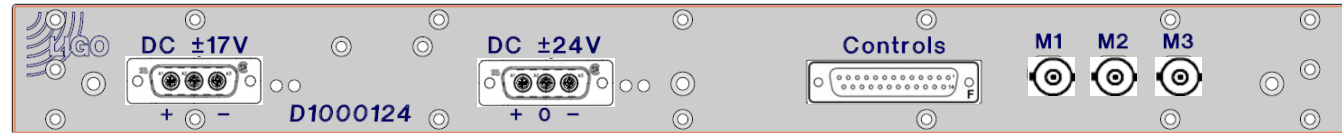
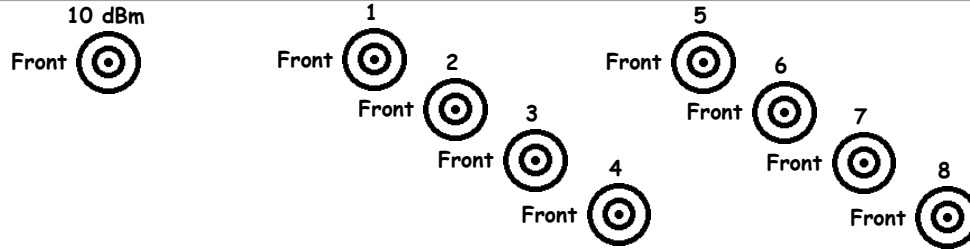

S1000650

Rear

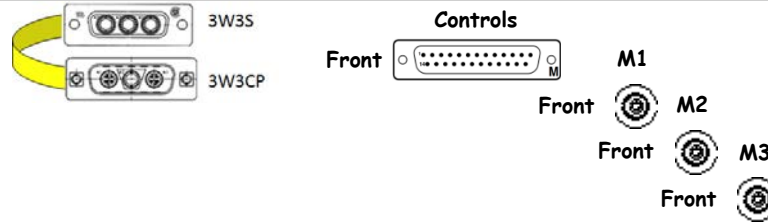

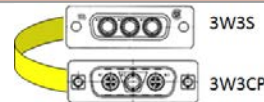
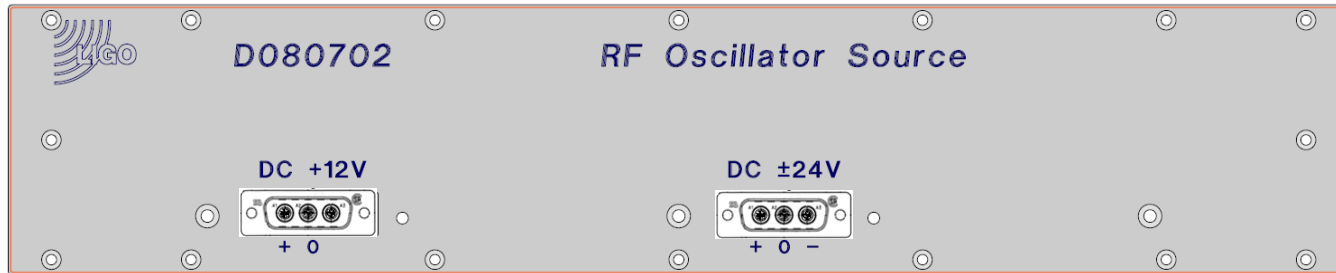
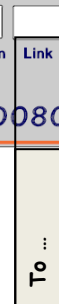
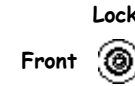
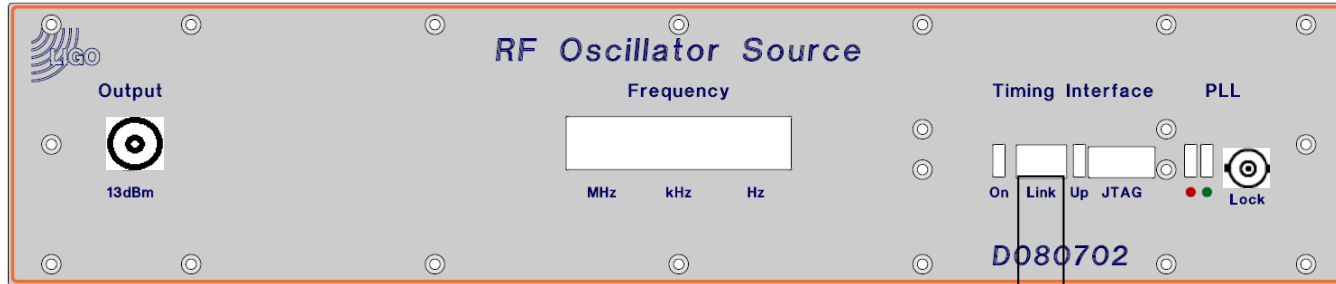

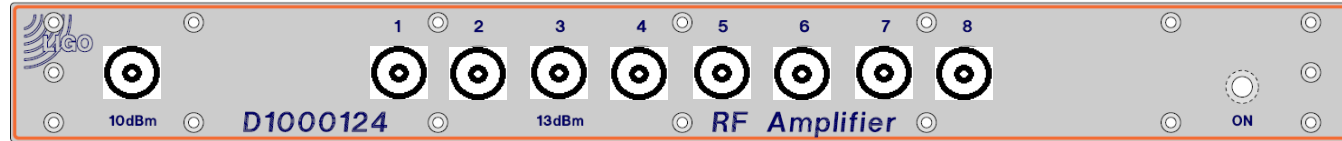

D1000124

Front

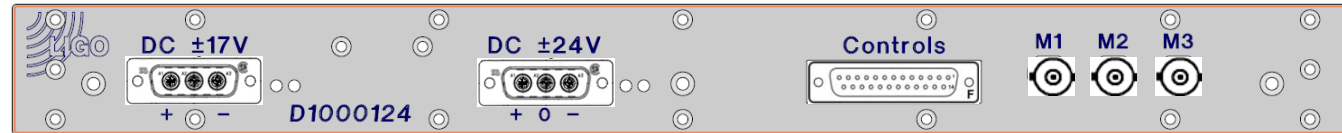
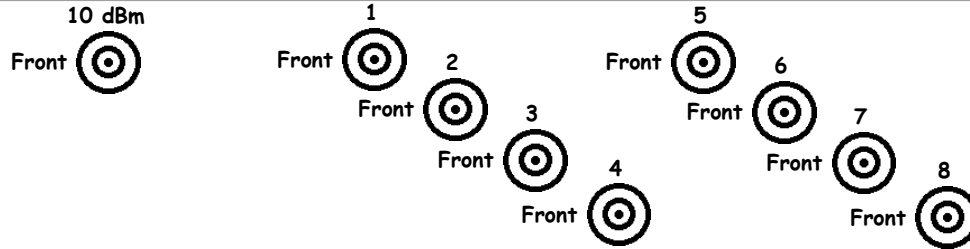

S1000650

Rear

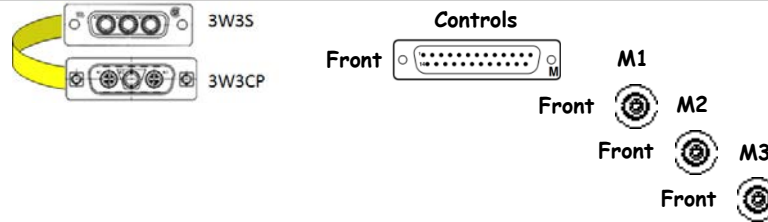

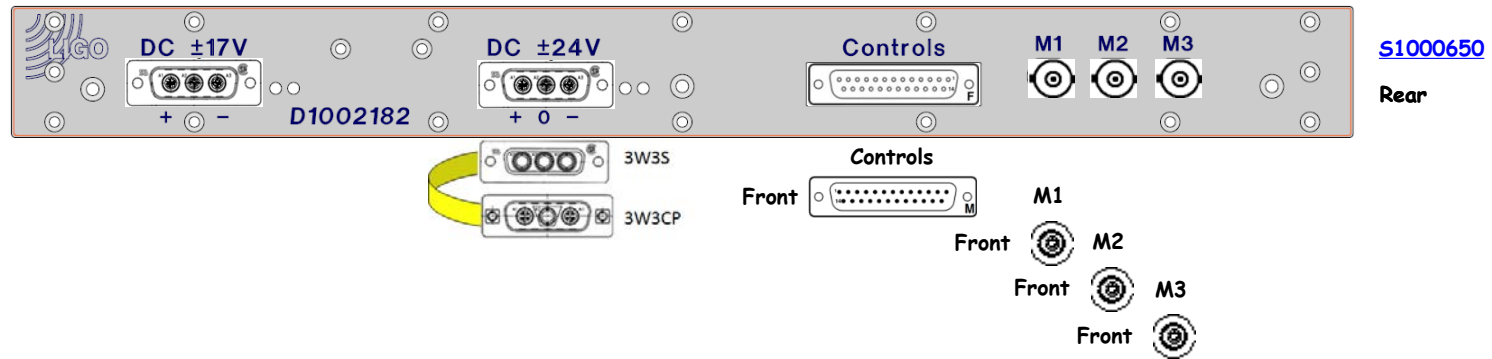
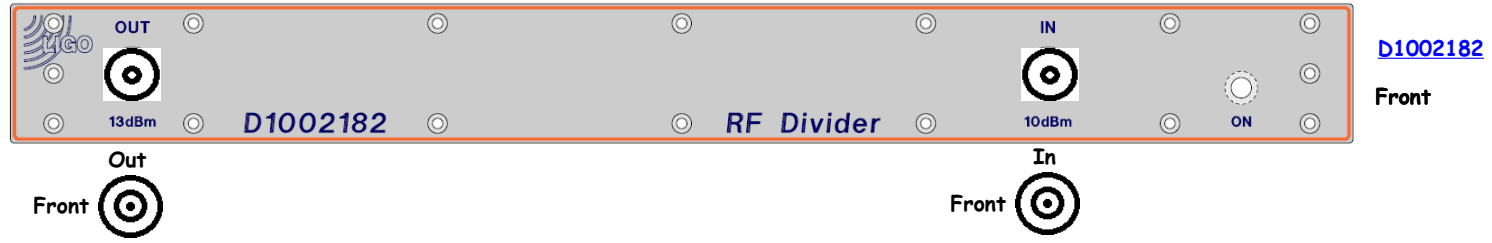

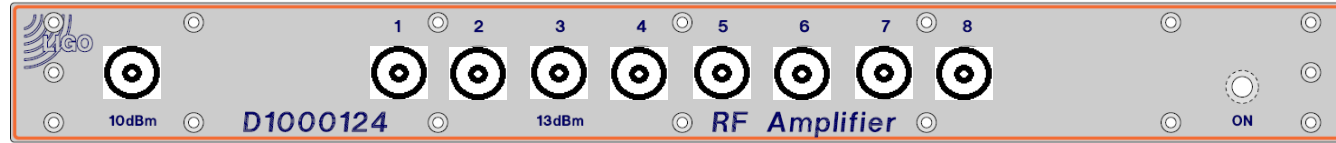

D1000124

Front

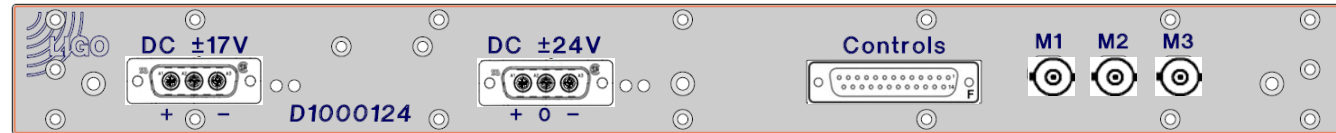
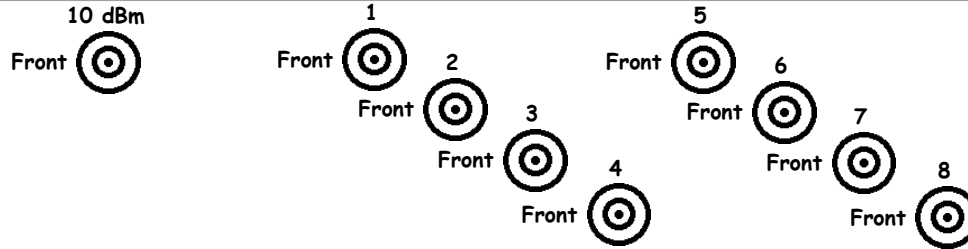

S1000650

Rear

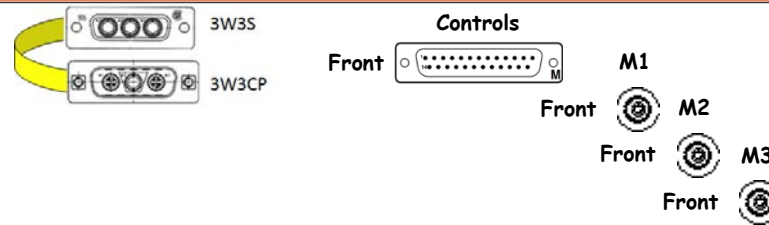

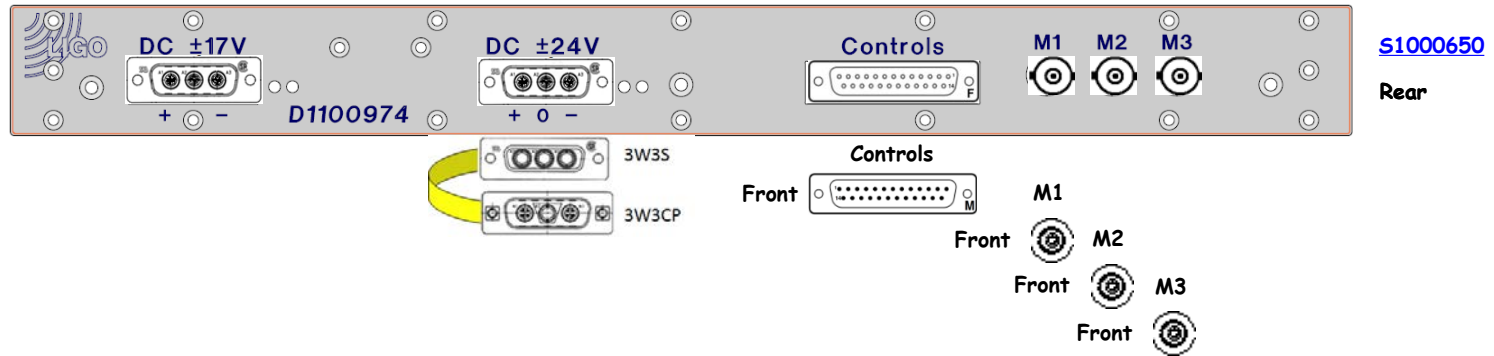
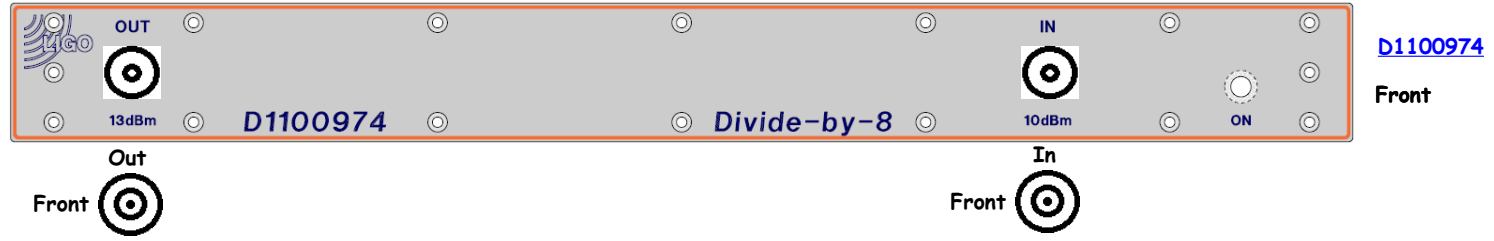

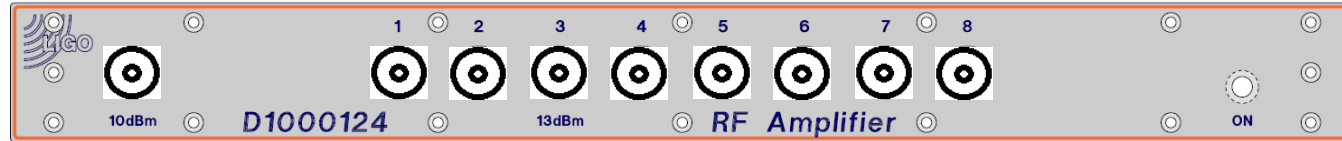

D1000124

Front

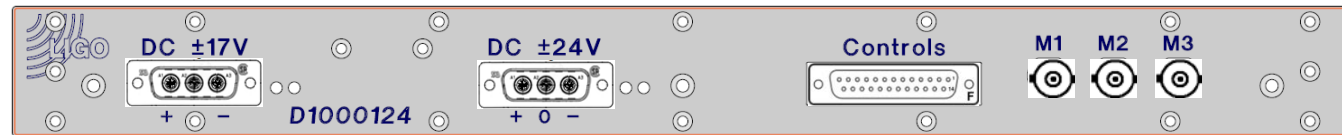
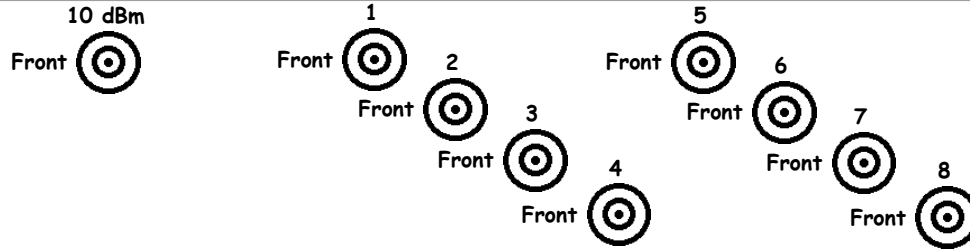

S1000650

Rear

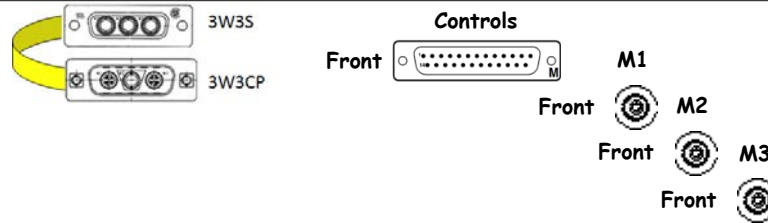



[D1100262](#)

Front

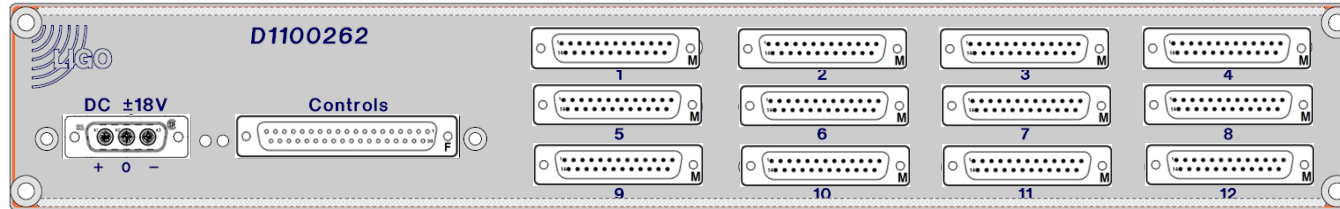

[S1001232](#)

Rear

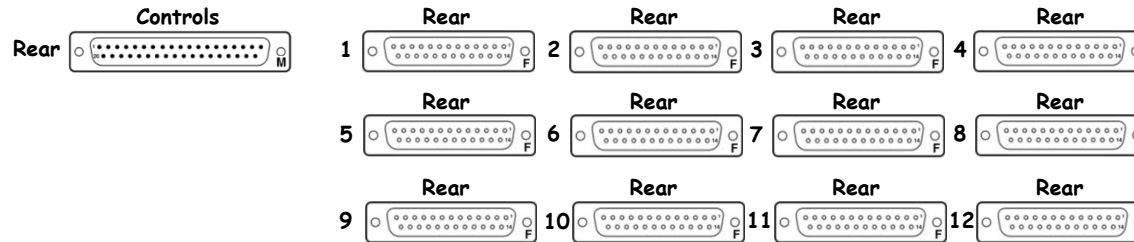



[D1100262](#)

Front

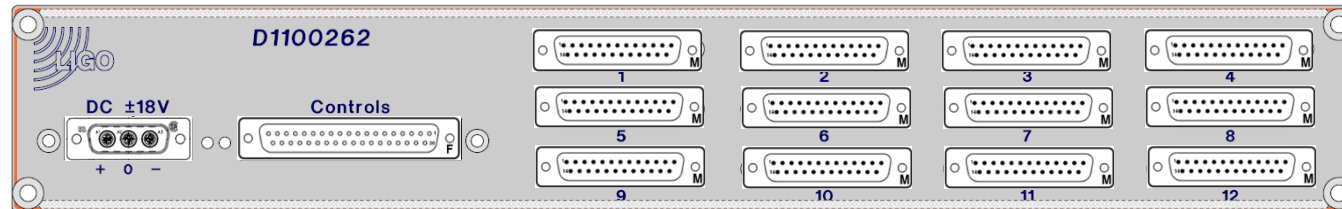

[S1001232](#)

Rear

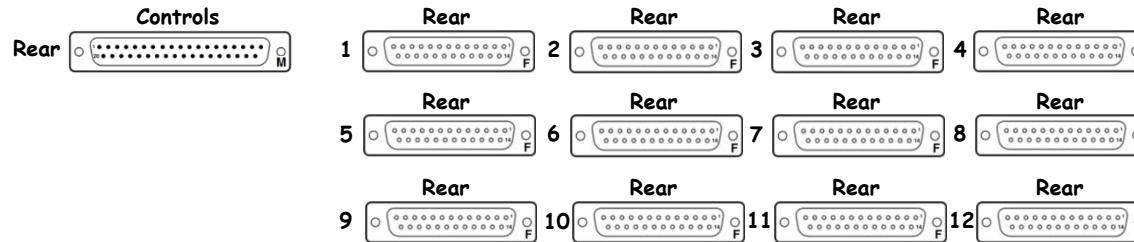

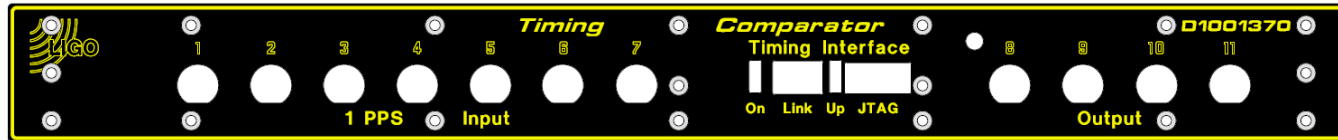

[D1001370](#)

Front

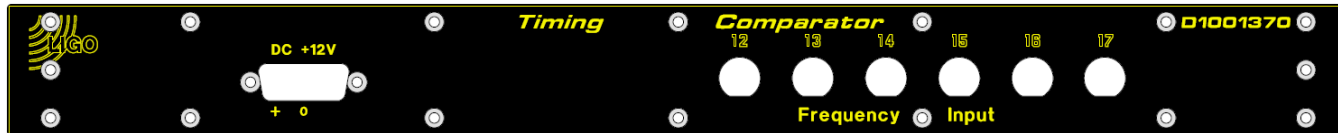

[S1001232](#)

Rear

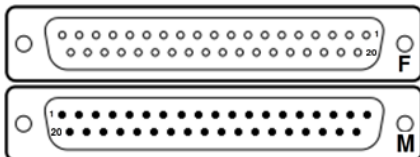

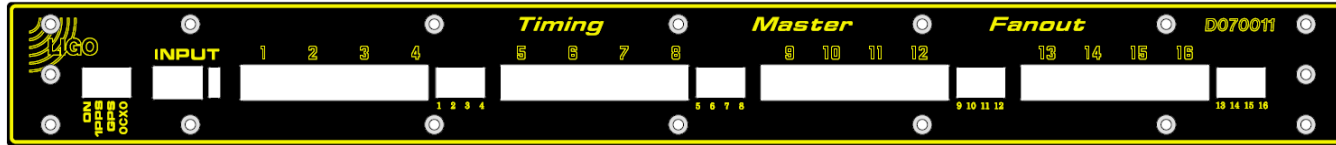

[D080534](#)

D070011

Front

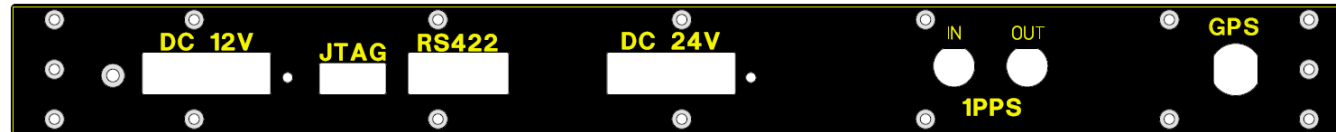

Master

[S1001232](#)

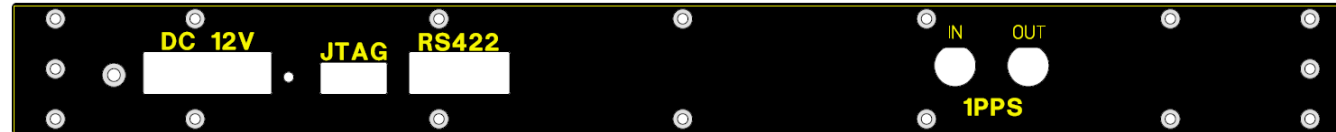

Fanout

Rear

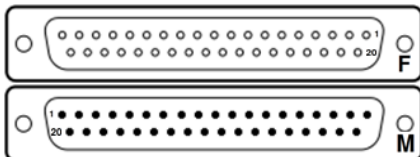

L1-ISC-C4

ISC LVEA Rack 4 Layout ([D1200977](#)) ([S1201189](#))

[D1200757](#)
Sequencer



[S1202562](#)

RF Patch Panel 1	Dxxxxxxx	42	Sxxxxxxx	No Power
RF Patch Panel 2	Dxxxxxxx	41	Sxxxxxxx	No Power
RF Patch Panel 3	Dxxxxxxx	40	Sxxxxxxx	No Power
RF Patch Panel 4	Dxxxxxxx	39	Sxxxxxxx	No Power
RF Patch Panel 5	Dxxxxxxx	38	Sxxxxxxx	No Power
RF Patch Panel 6	Dxxxxxxx	37	Sxxxxxxx	No Power
Aeroflex 2023A Diagnostics	Dxxxxxxx	36	Sxxxxxxx	No Power
9.099 / 8.684 MHz RF Source	D080702	35	Sxxxxxxx	No Power
9.099 / 8.684 MHz Distribution Amplifier	D1000124	34	Sxxxxxxx	No Power
9.099 / 8.684 MHz Harmonic Generator	Dxxxxxxx	33	Sxxxxxxx	No Power
9.099 / 8.684 MHz Harmonic Power Supply	D1002735	32	Sxxxxxxx	No Power
18 MHz Distribution Amplifier	D1000124	31	Sxxxxxxx	No Power
27 MHz Distribution Amplifier	D1000124	30	Sxxxxxxx	Power
36 MHz Distribution Amplifier	D1000124	29	Sxxxxxxx	+12VDC, ±24VDC
45 MHz Distribution Amplifier	D1000124	28	Sxxxxxxx	±17VDC, ±24VDC
90 MHz Distribution Amplifier	D1000124	27	Sxxxxxxx	
135 MHz Distribution Amplifier	D1000124	26	Sxxxxxxx	
		25	Sxxxxxxx	
		24	Sxxxxxxx	
		23	Sxxxxxxx	From D1002735
		22	Sxxxxxxx	±17VDC, ±24VDC
		21	Sxxxxxxx	±17VDC, ±24VDC
		20	Sxxxxxxx	±17VDC, ±24VDC
		19	Sxxxxxxx	±17VDC, ±24VDC
		18	Sxxxxxxx	±17VDC, ±24VDC
		17	Sxxxxxxx	±17VDC, ±24VDC
		16	Sxxxxxxx	±17VDC, ±24VDC
		15	Sxxxxxxx	
		14	Sxxxxxxx	
24.078 / 22.993 MHz RF Source	D080702	13	Sxxxxxxx	+12VDC, ±24VDC
24.078 / 22.993 MHz Distribution Amplifier	D1000124	12	Sxxxxxxx	±17VDC, ±24VDC
71 MHz RF Source	D080702	11	Sxxxxxxx	+12VDC, ±24VDC
71 MHz Distribution Amplifier	D1000124	10	Sxxxxxxx	±17VDC, ±24VDC
		9	Sxxxxxxx	
		8	Sxxxxxxx	
		7	Sxxxxxxx	
		6	Sxxxxxxx	
		5	Sxxxxxxx	
		4	Sxxxxxxx	
		3	Sxxxxxxx	
		2	Sxxxxxxx	
		1	Sxxxxxxx	

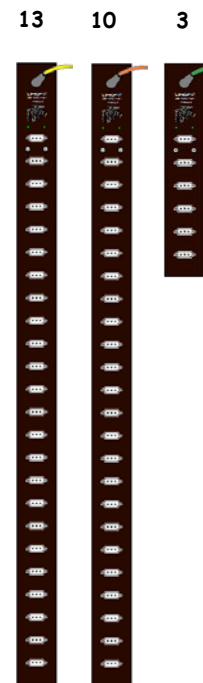

ISC-C4 is part of [D1001427](#).

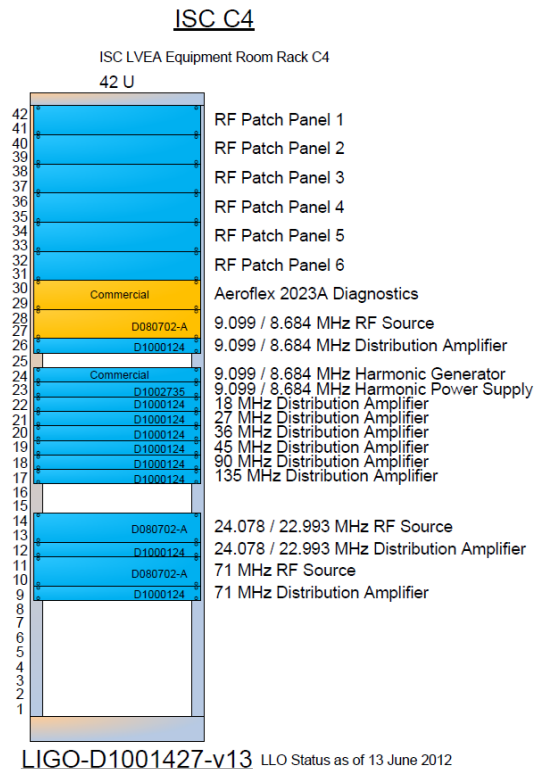

([D1001427](#))

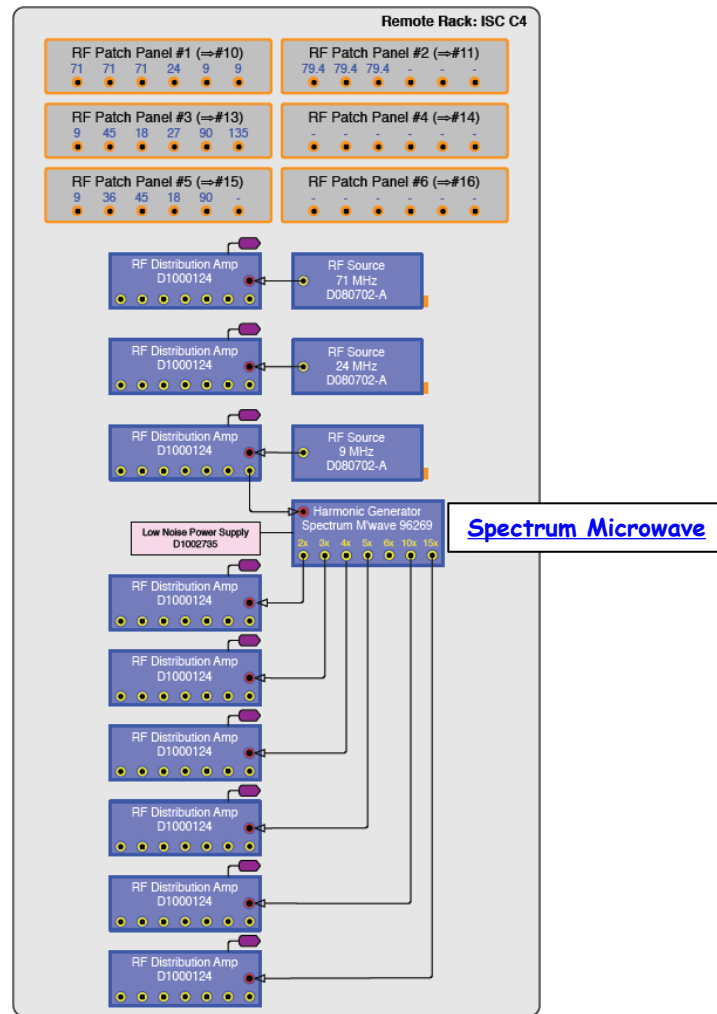

([D1100170](#))

L1-ISC-C4 Details

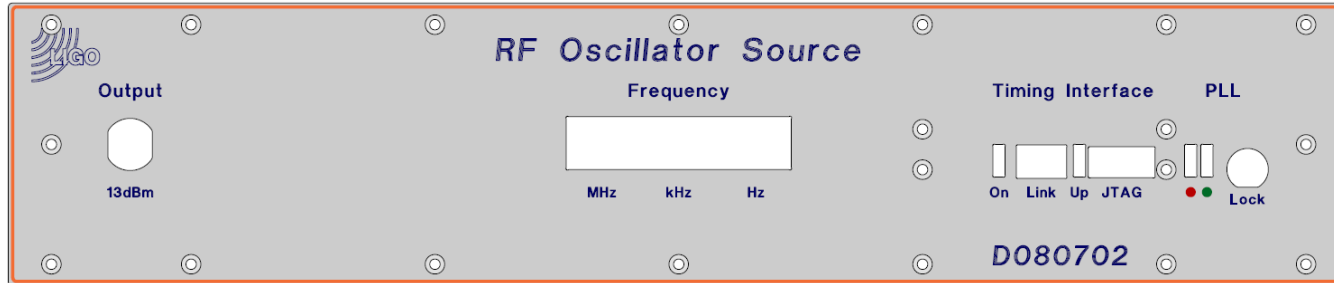

[D080702](#)

Front

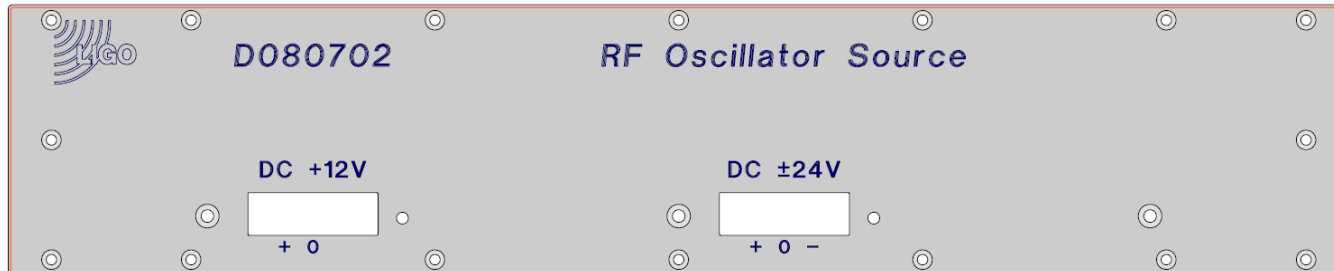

[S1001232](#)

Rear

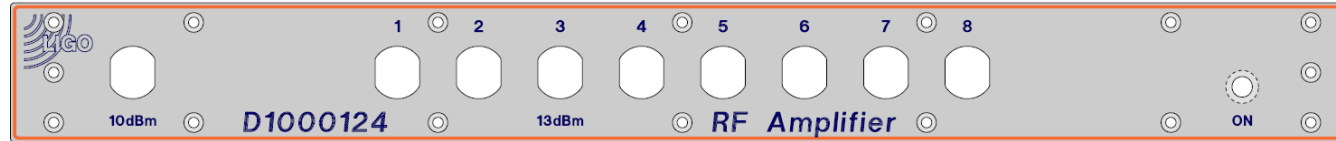

[D1000124](#)

Front

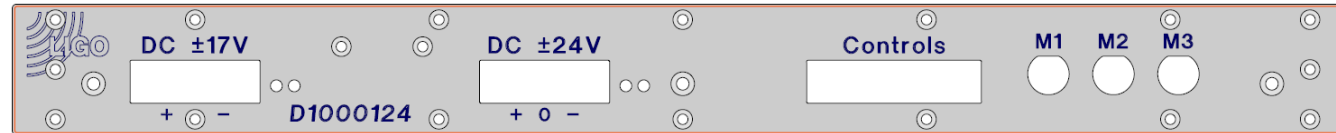

[S1001232](#)

Rear

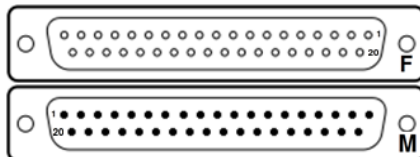

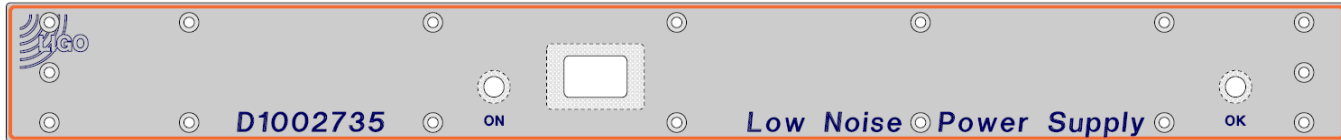

D1002735

Front

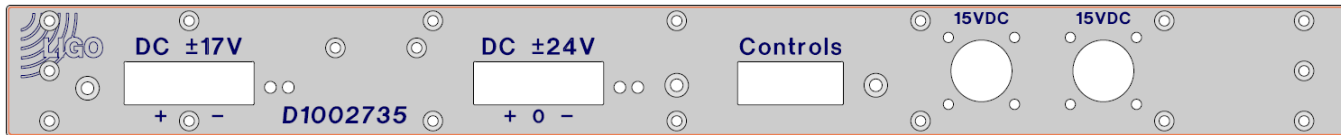

Sxxxxxxx

Rear

From DAC Adapter

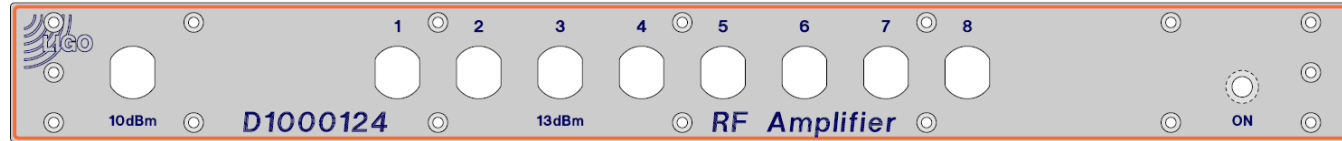

[D1000124](#)

Front

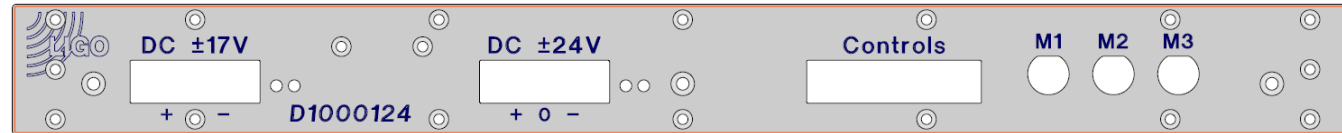

[S1001232](#)

Rear

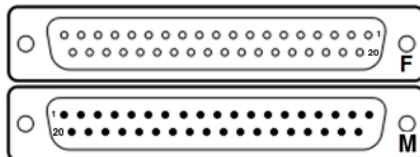

D1000124 - Sxxxxxxx

<< [L1-ISC-C4](#)

27 MHz Distribution Amplifier ±17VDC, ±24VDC

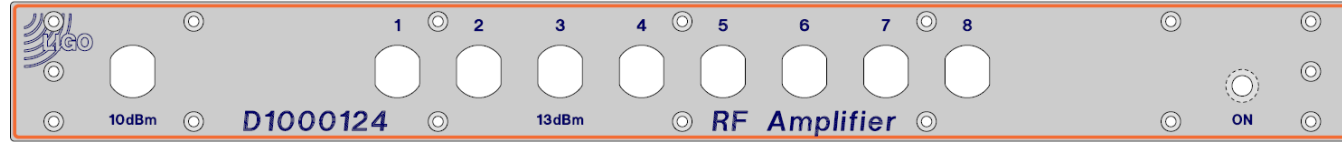

[D1000124](#)

Front

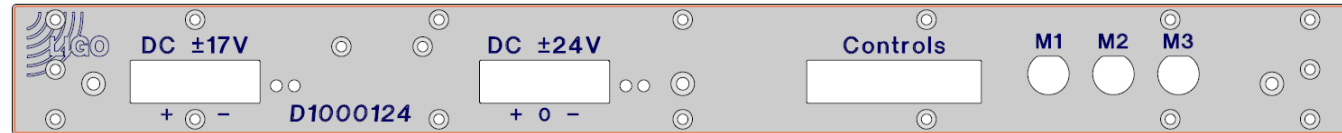

[S1001232](#)

Rear

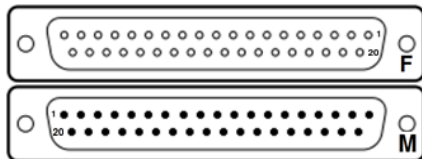

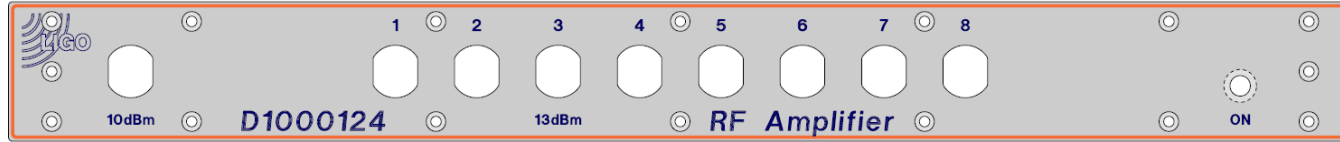

[D1000124](#)

Front

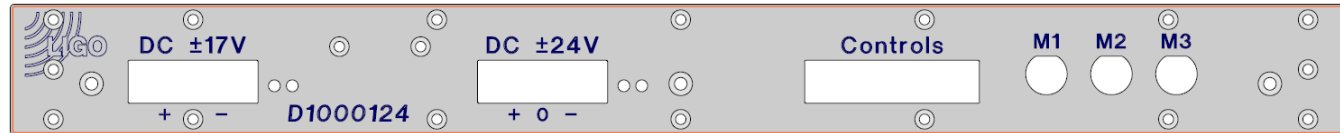

[S1001232](#)

Rear

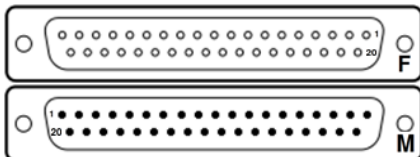

D1000124 - Sxxxxxxx

<< [L1-ISC-C4](#)

45 MHz Distribution Amplifier ±17VDC, ±24VDC

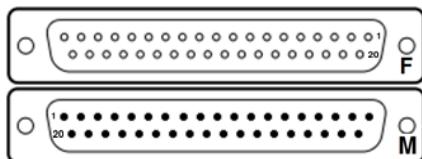
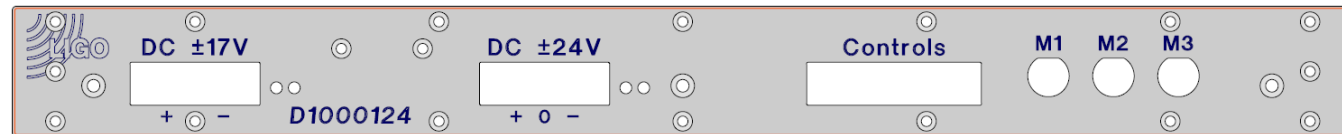
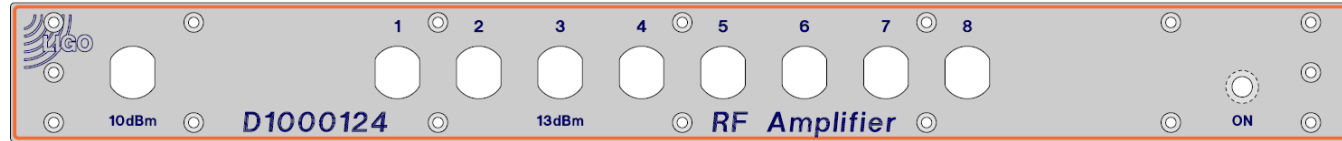

D1000124 - Sxxxxxxx

<< [L1-ISC-C4](#)

90 MHz Distribution Amplifier ±17VDC, ±24VDC

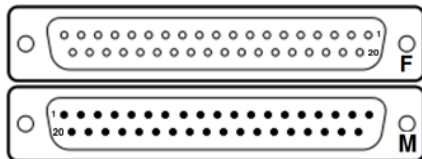
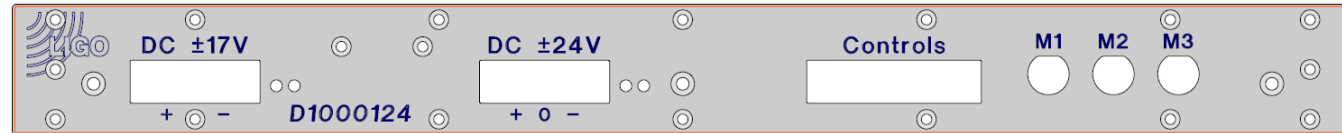
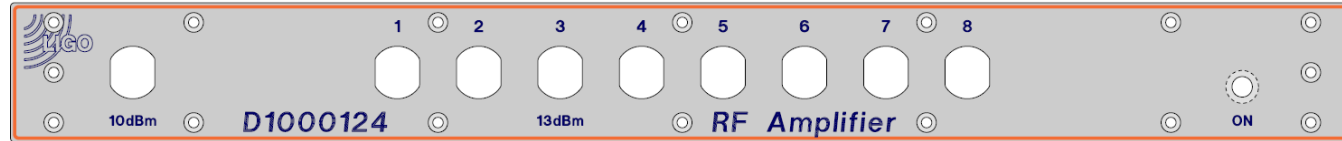

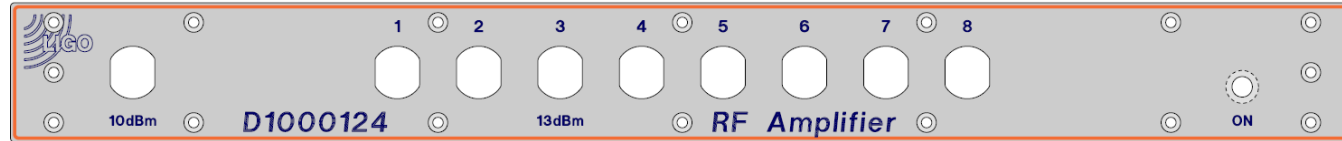

[D1000124](#)

Front

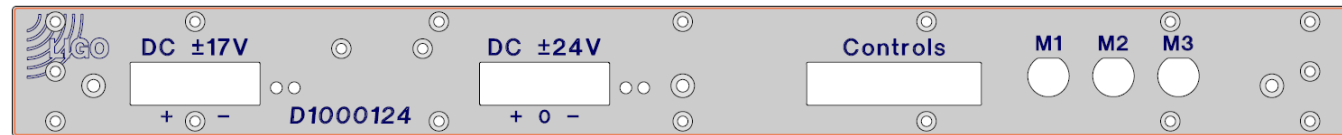

[S1001232](#)

Rear

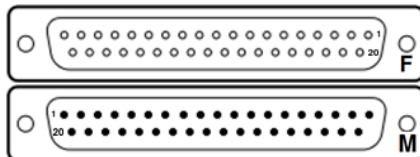

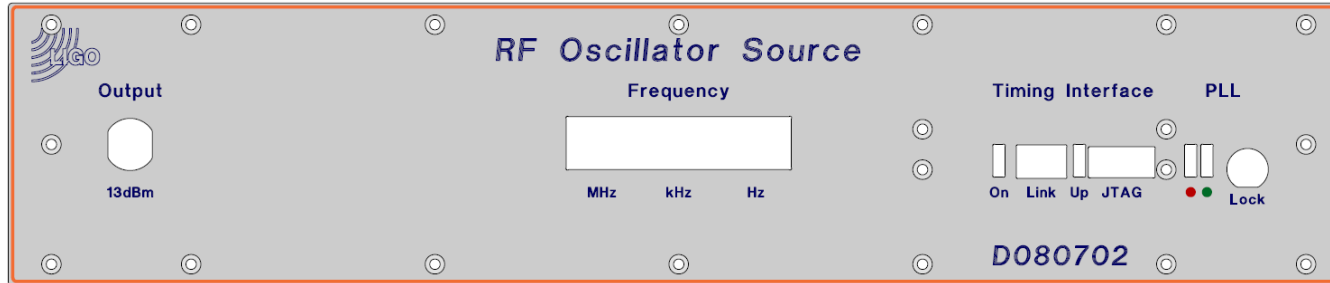

[D080702](#)

Front

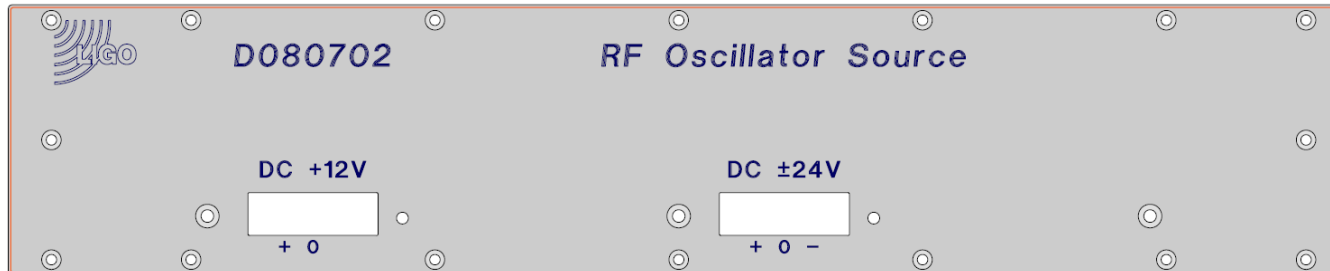

[S1001232](#)

Rear

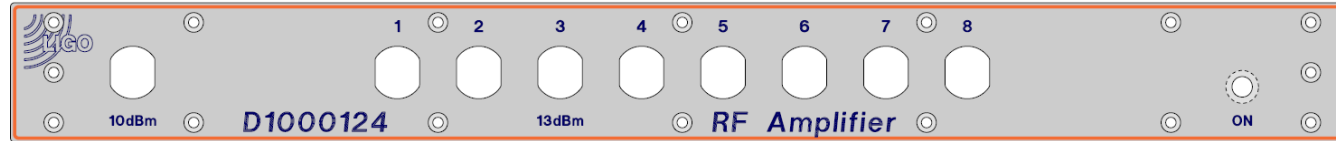

[D1000124](#)

Front

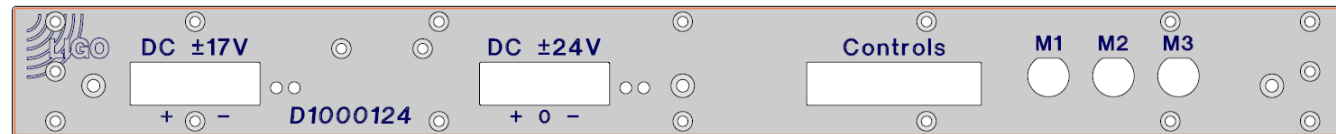

[S1001232](#)

Rear

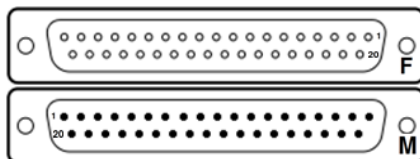

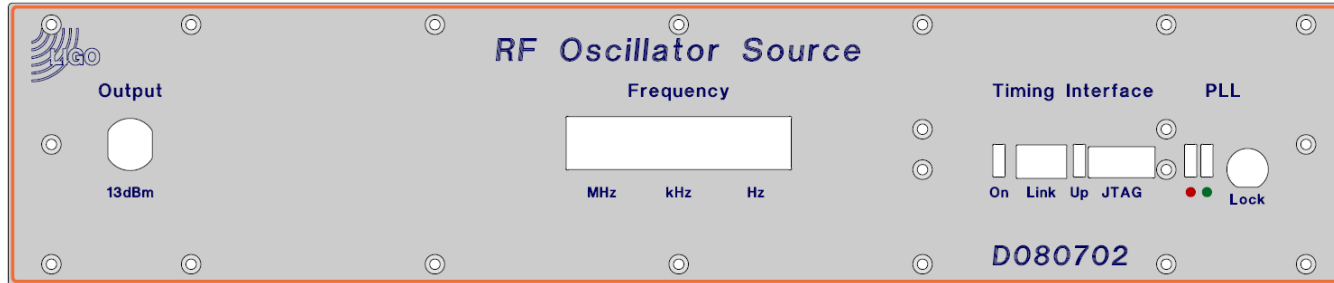

[D080702](#)

Front

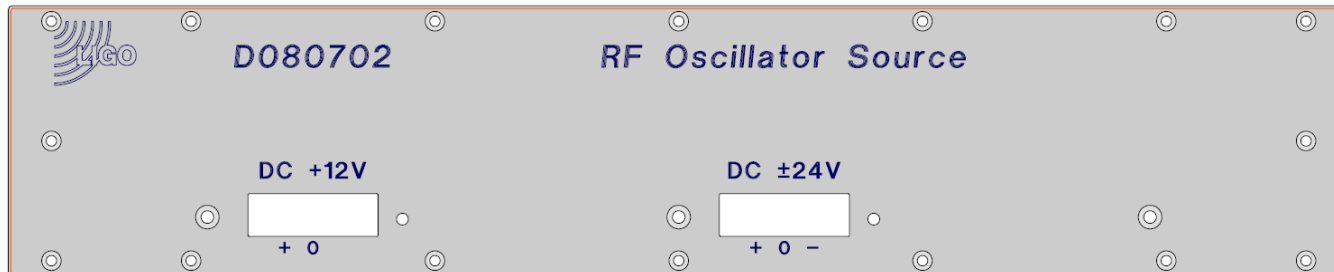

[S1001232](#)

Rear

D1000124 - Sxxxxxxx

<< [L1-ISC-C4](#)

71 MHz Distribution Amplifier ±17VDC, ±24VDC

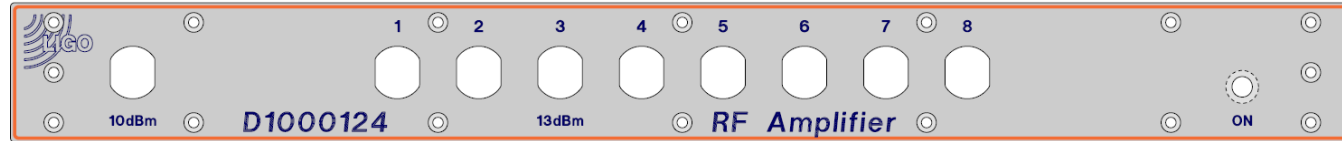

[D1000124](#)

Front

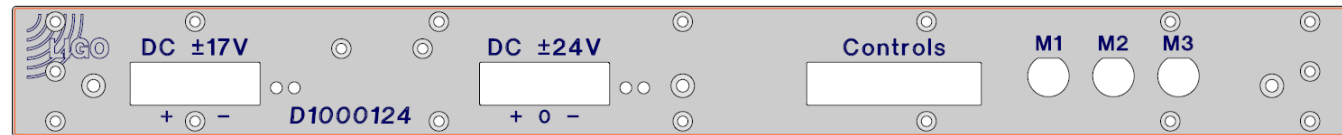

[S1001232](#)

Rear

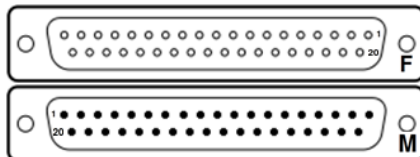

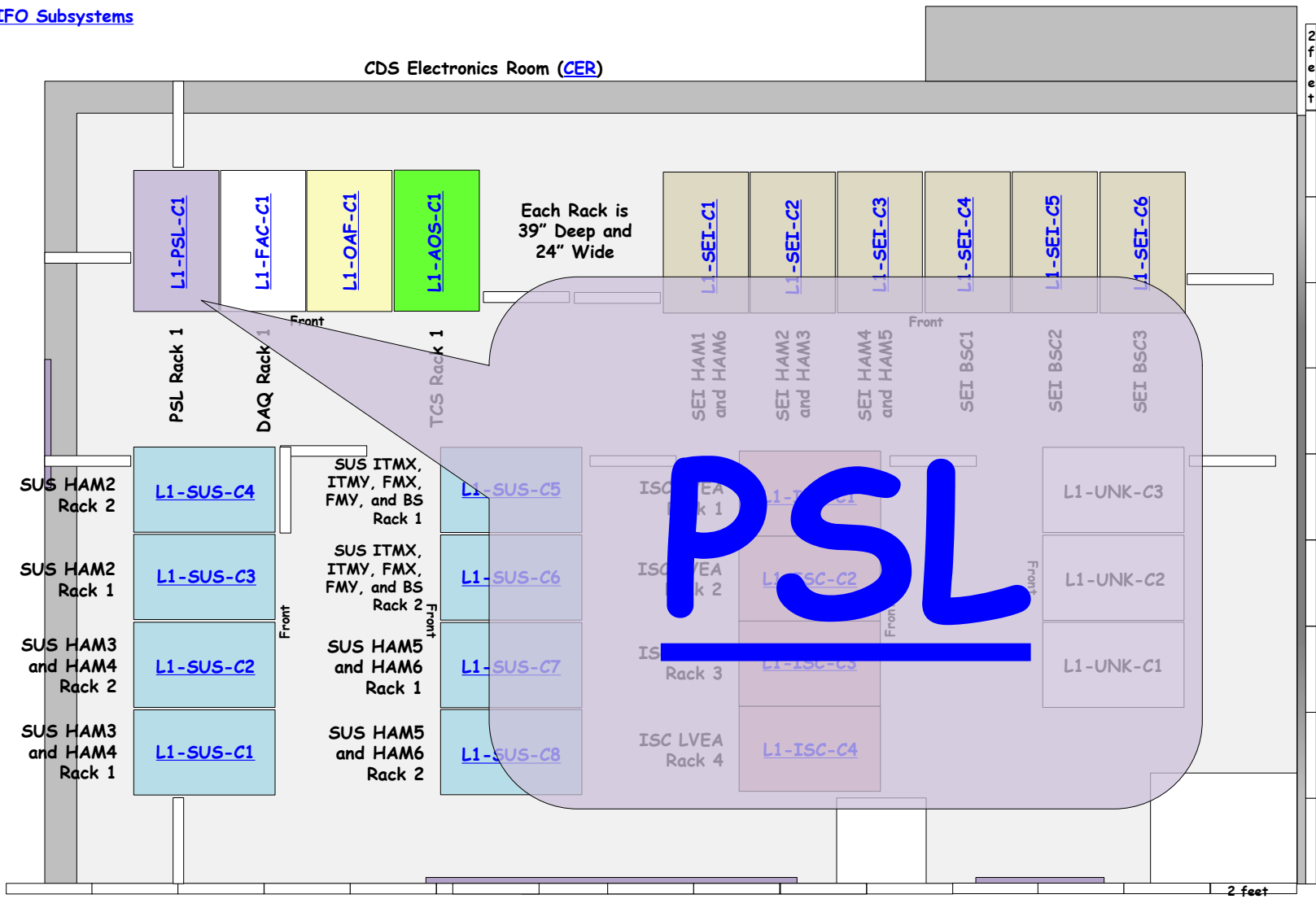

PSL Component List: [LIGO-T0900633](#)

PSL Table Layout: [LIGO-T0900610](#)

L1-PSL-C1

PSL Rack 1 Layout (LIGO-Dxxxxxxx)

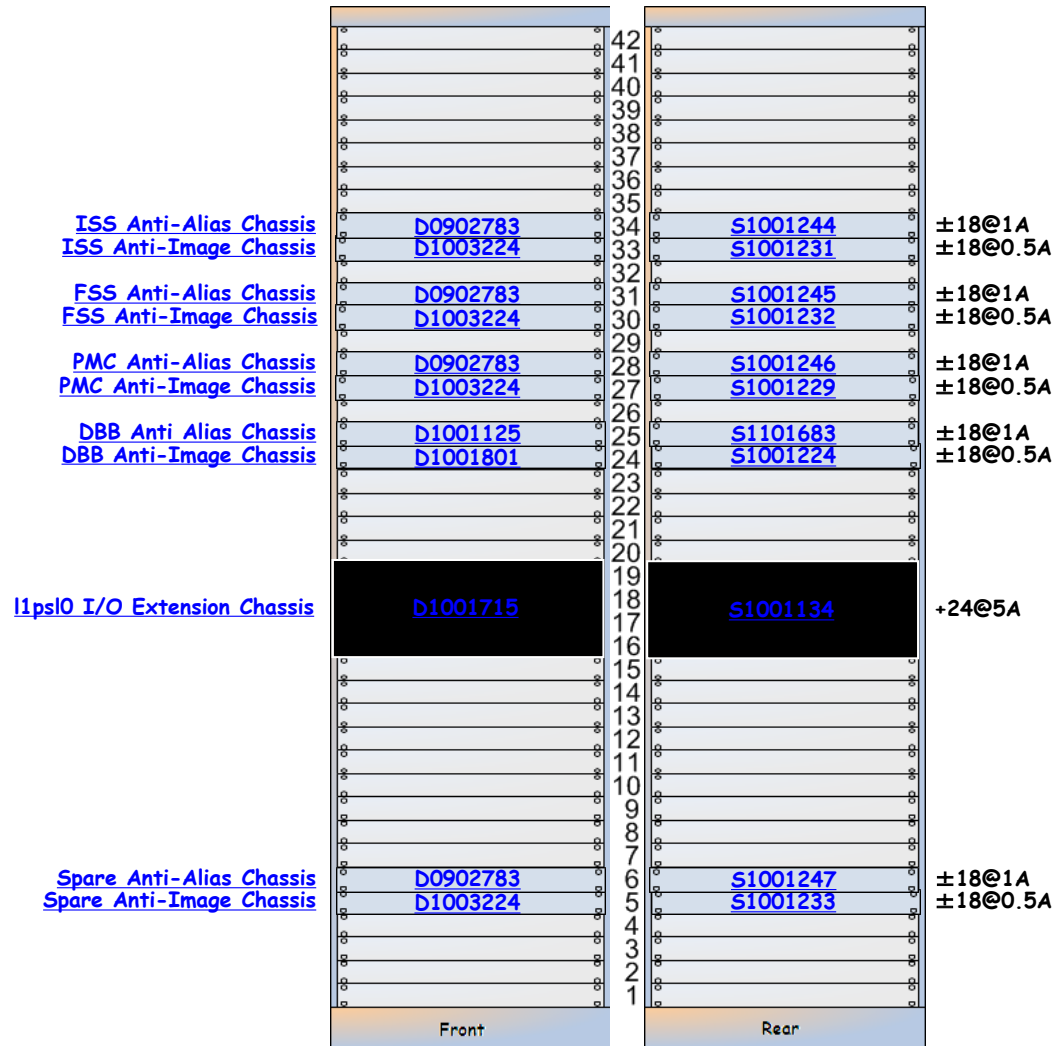

PSY-009



PSO-018

L1-PSL-C1 Details

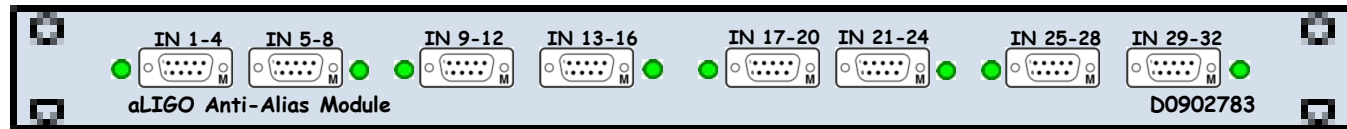
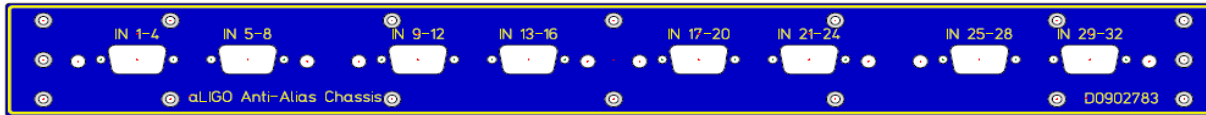

[D1003224](#)

Front

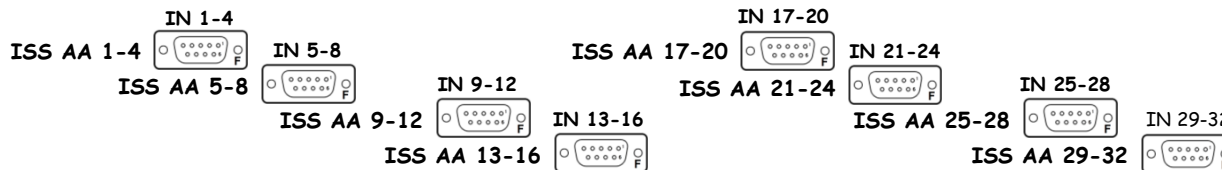

[S1001244](#)

Rear

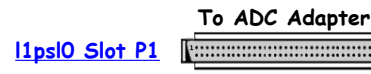

[1psIO Slot P1](#)

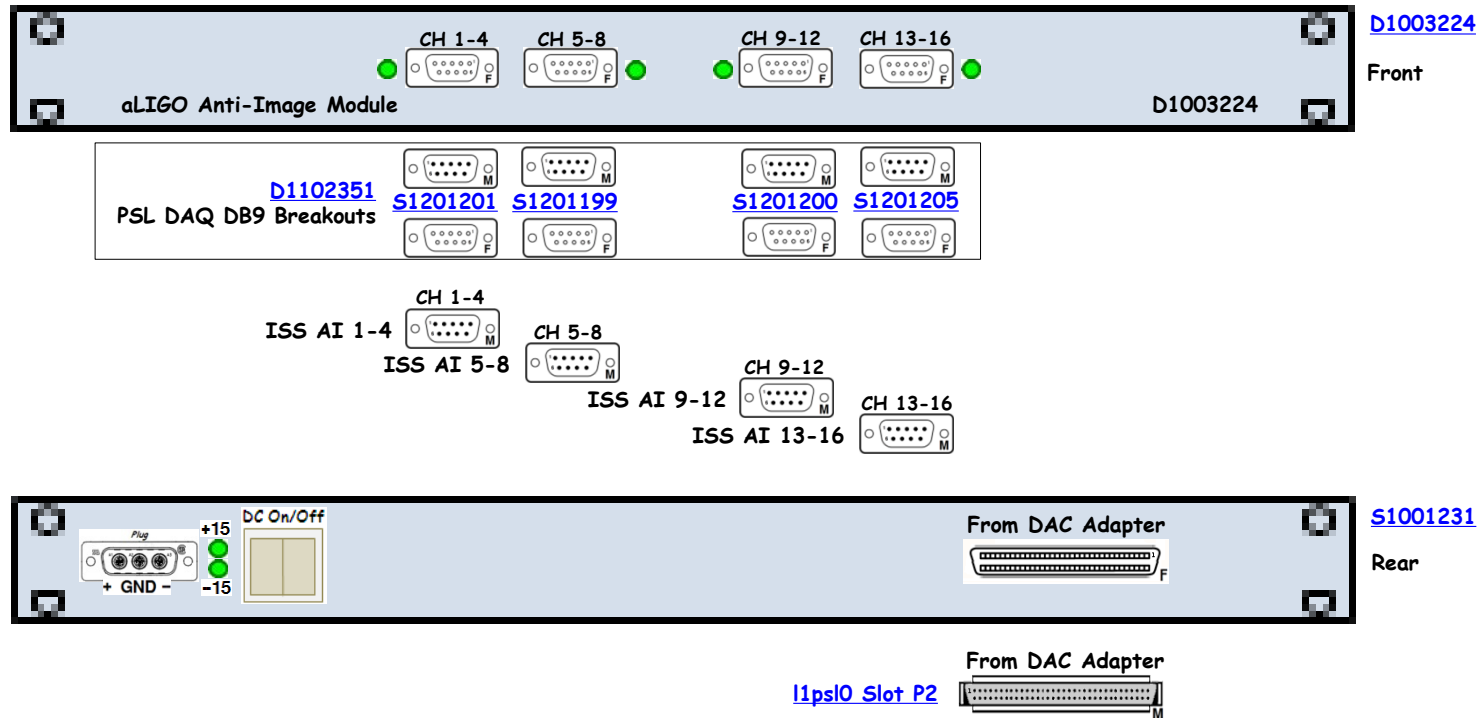

D0902783 - S1001245



<< L1-PSL-C1

FSS Anti-Alias Chassis D0902783 S1001245 ±18@1.0A

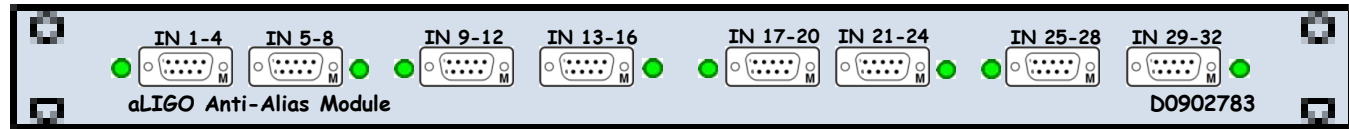

[D1003224](#)

Front

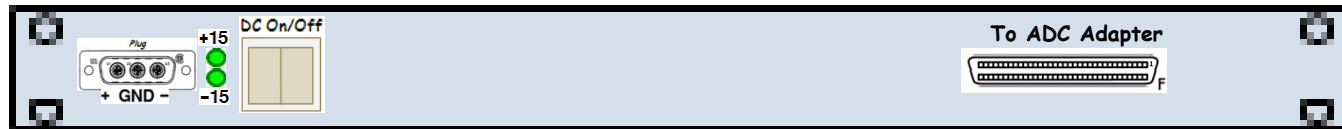
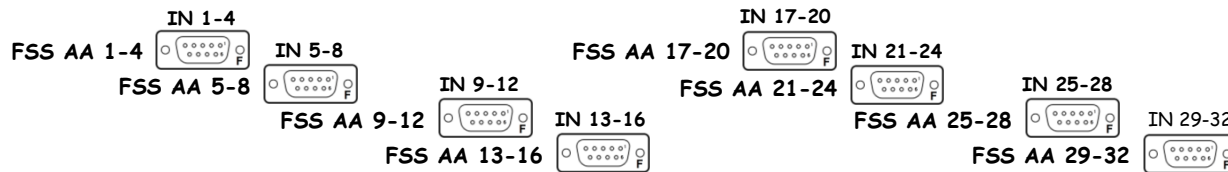

[S1001245](#)

Rear



[1psIO Slot P3](#)

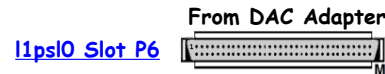
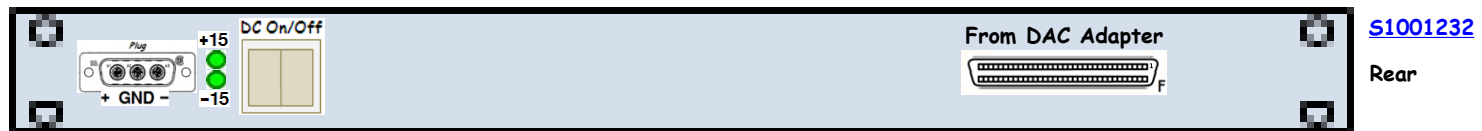
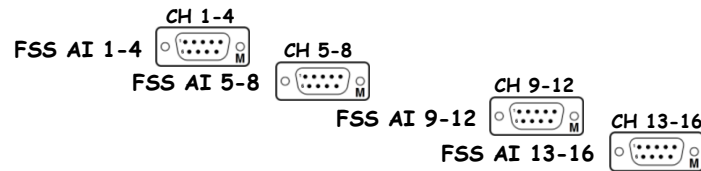
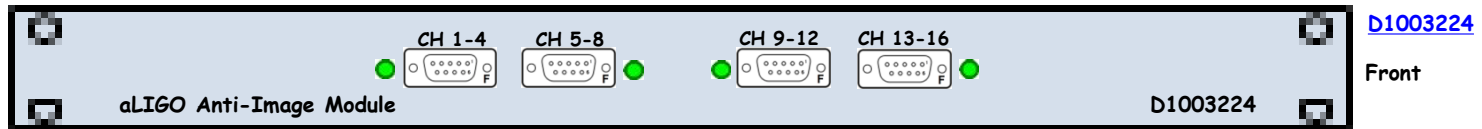

D0902783 - S1001246



<< L1-PSL-C1

PMC Anti-Image Chassis D0902783 S1001246 ±18@1.0A

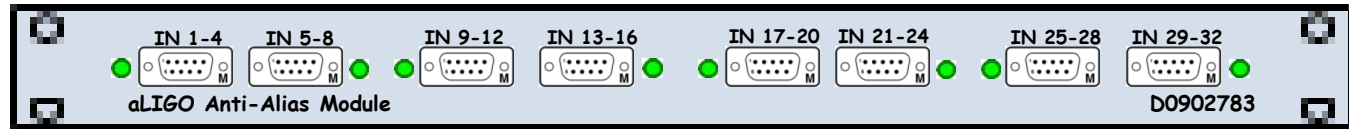

[D1003224](#)

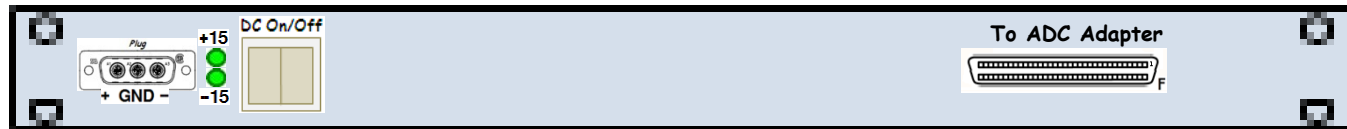
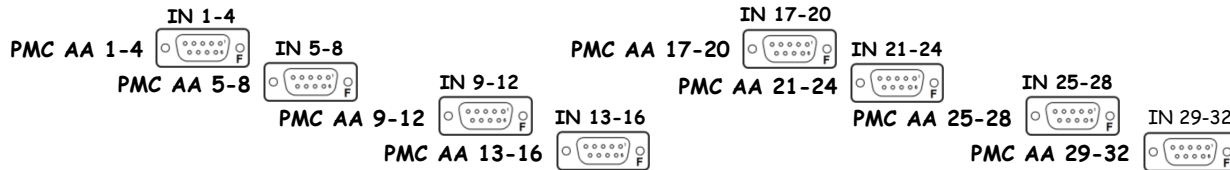

[S1001246](#)



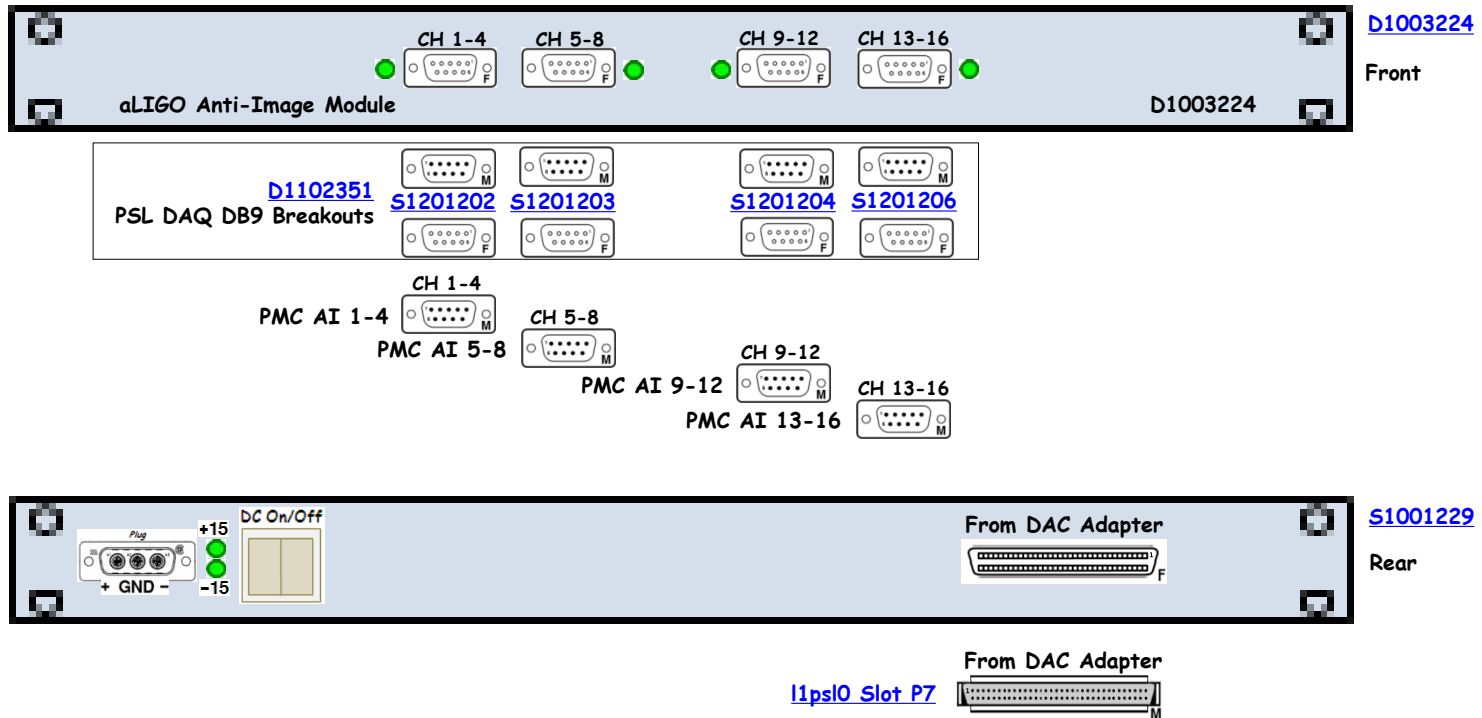

DBB Anti-Alias Chassis ±18@1.0A

AI Module aLIGO PSL DBB Assembly Drawing [D1100292](#)

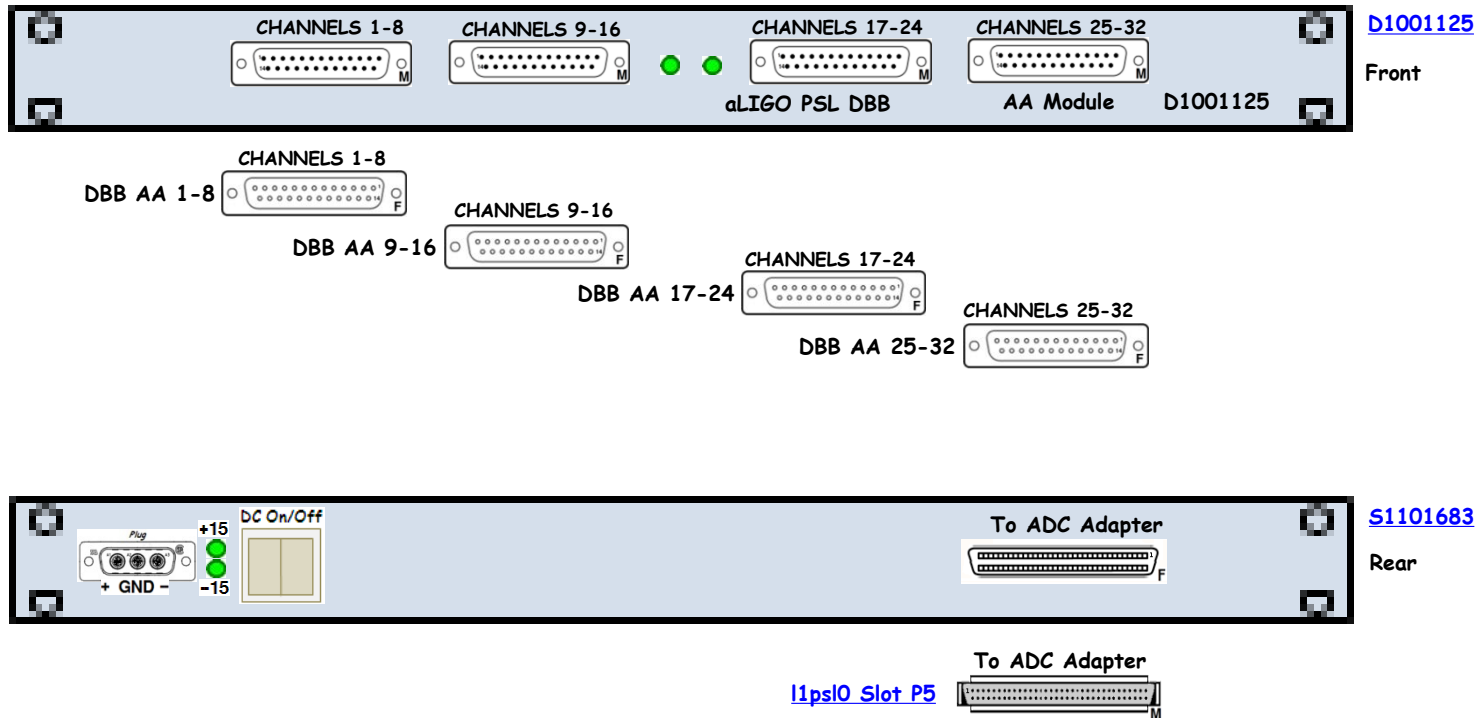

DBB Anti-Image Chassis ±18@0.5A

AI Module aLIGO PSL DBB Assembly Drawing [D1002103](#)

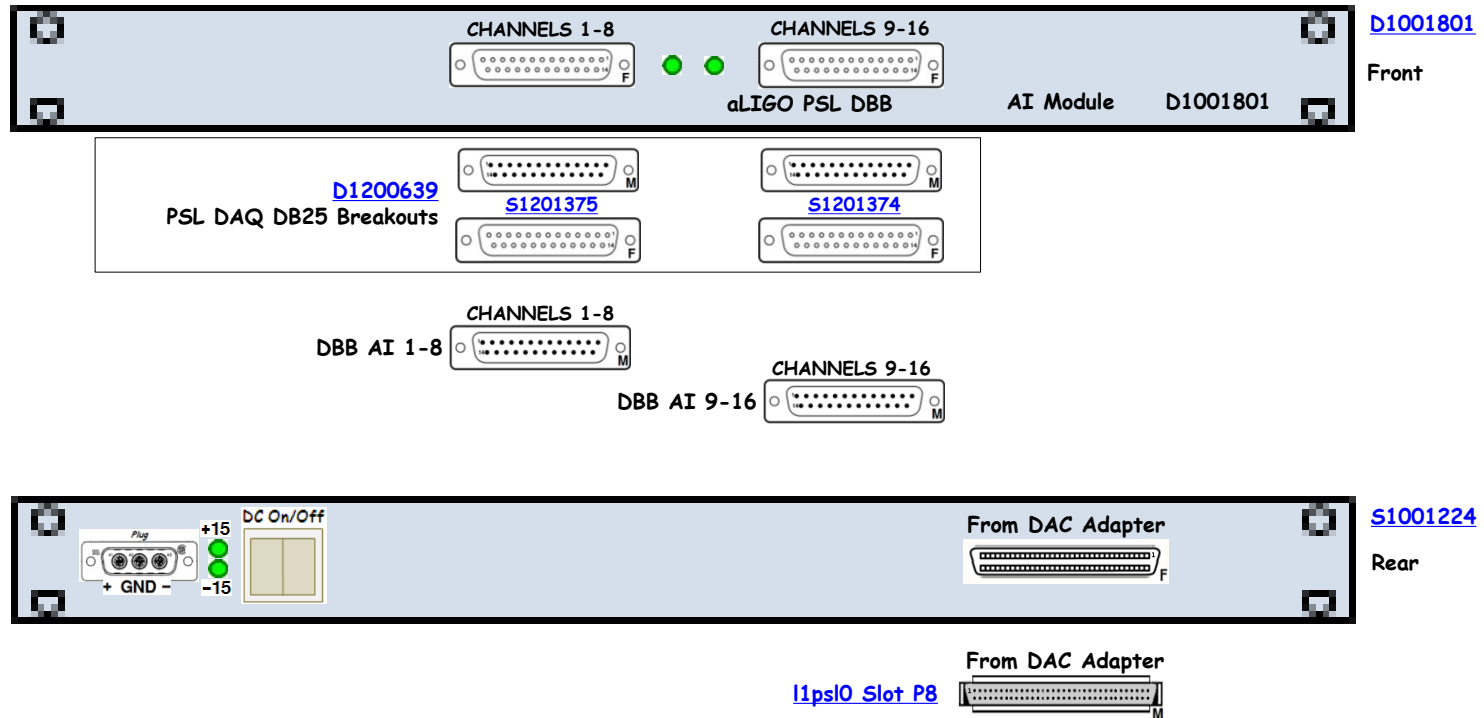

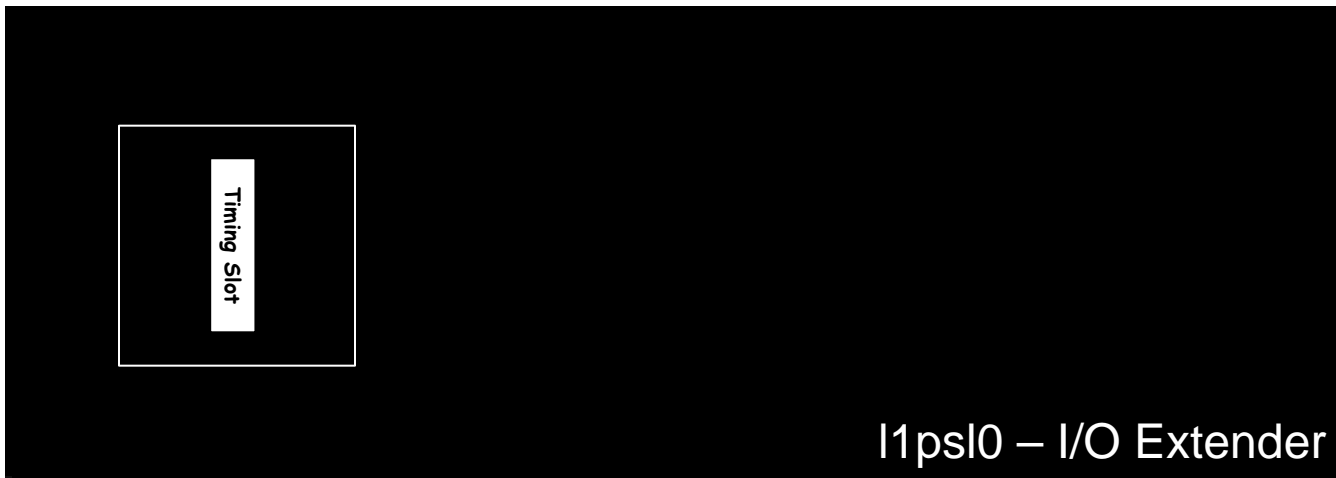

[D1001715](#)

Front

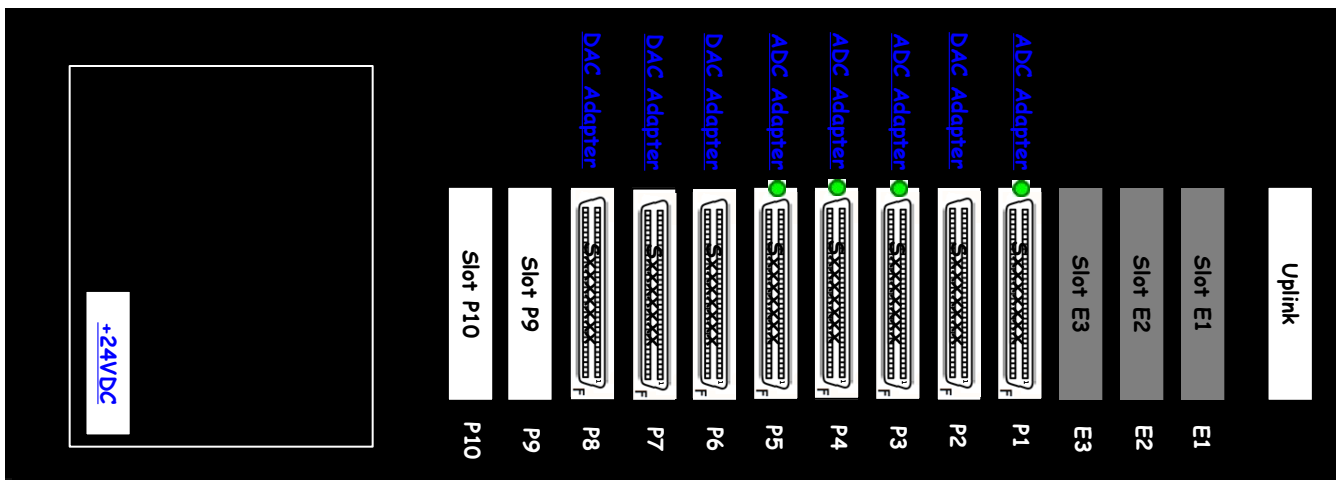

[S1001134](#)

Rear

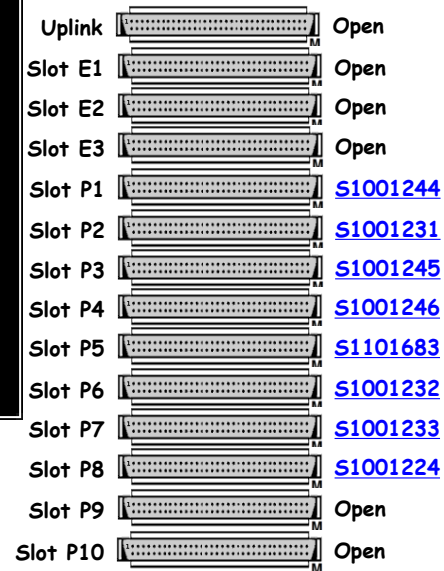

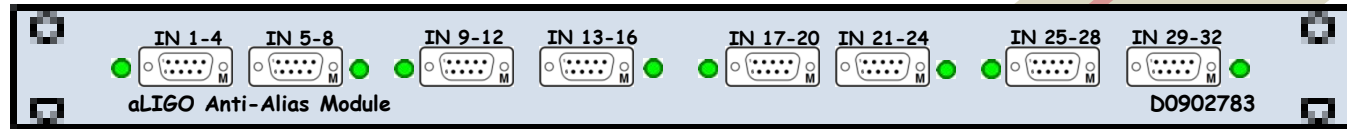
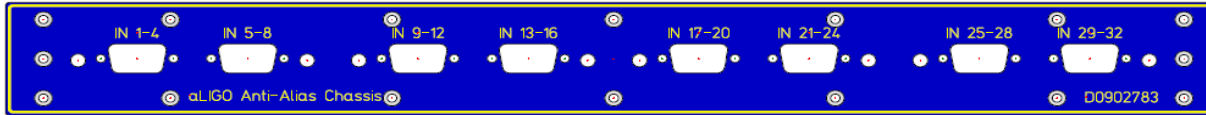

D1003224

Front

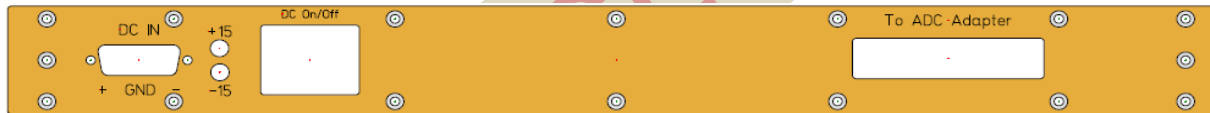
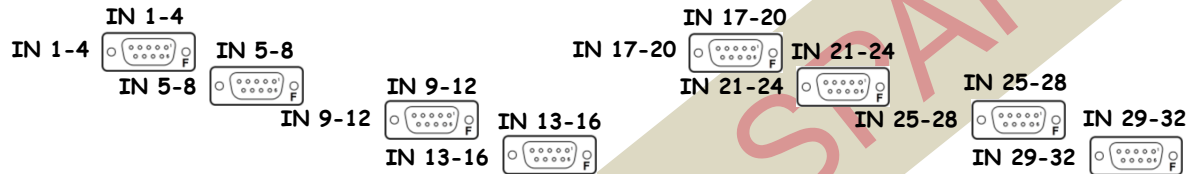

S1001247

Rear



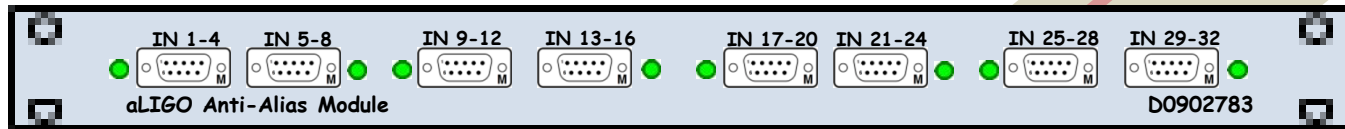
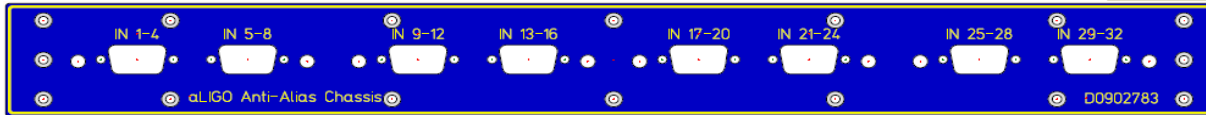

D1003224

Front

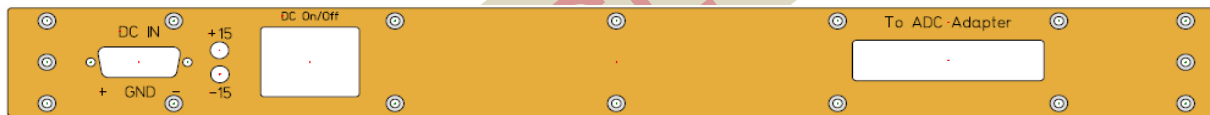
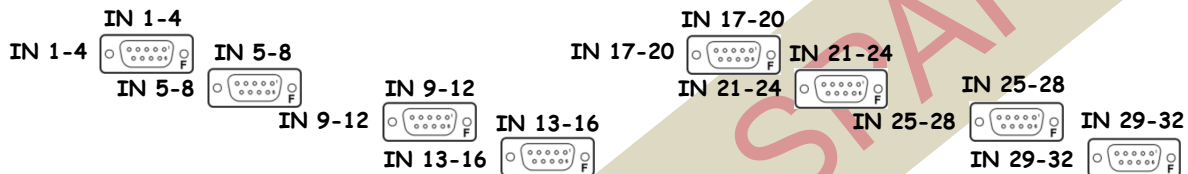

S1001248

Rear

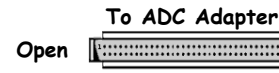

Anti-Image Chassis ±18@0.5A

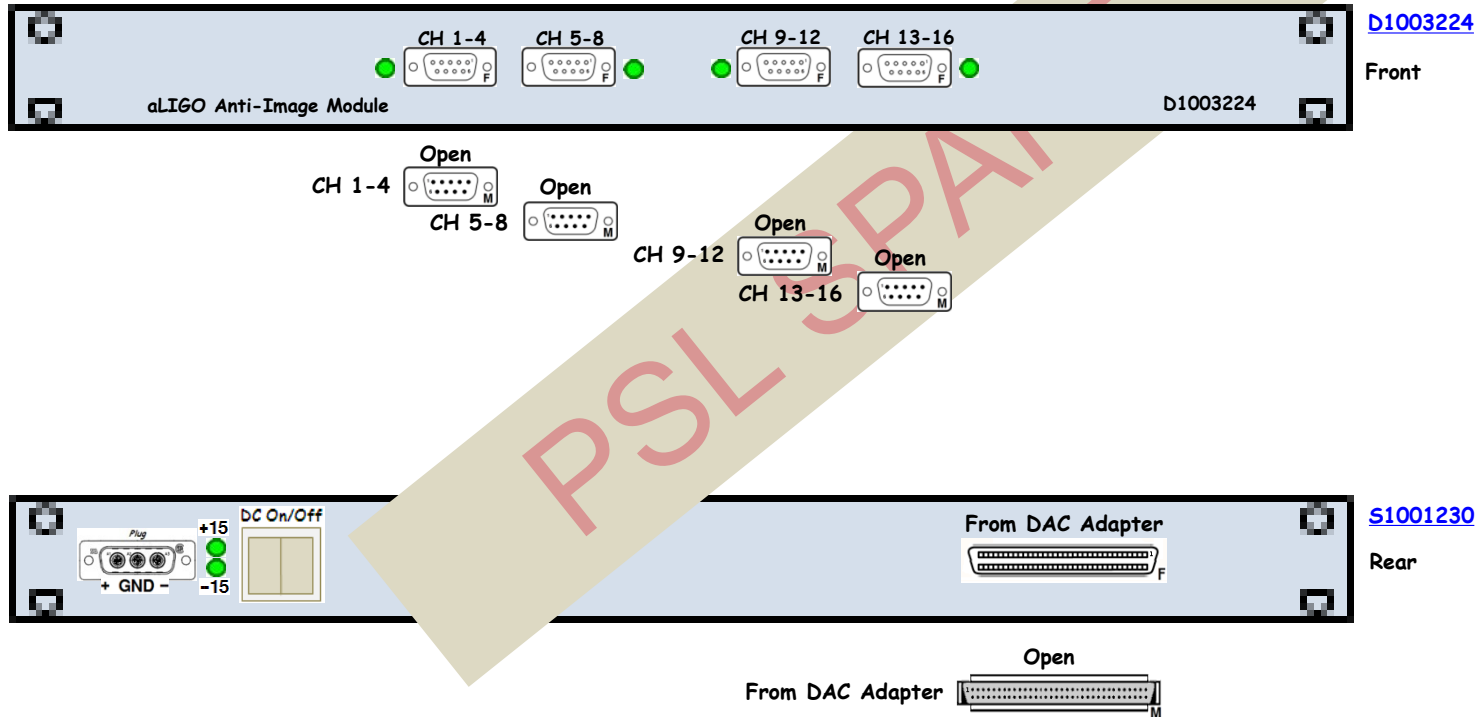

Anti-Image Chassis D1003224 S1001233 ±18@0.5A

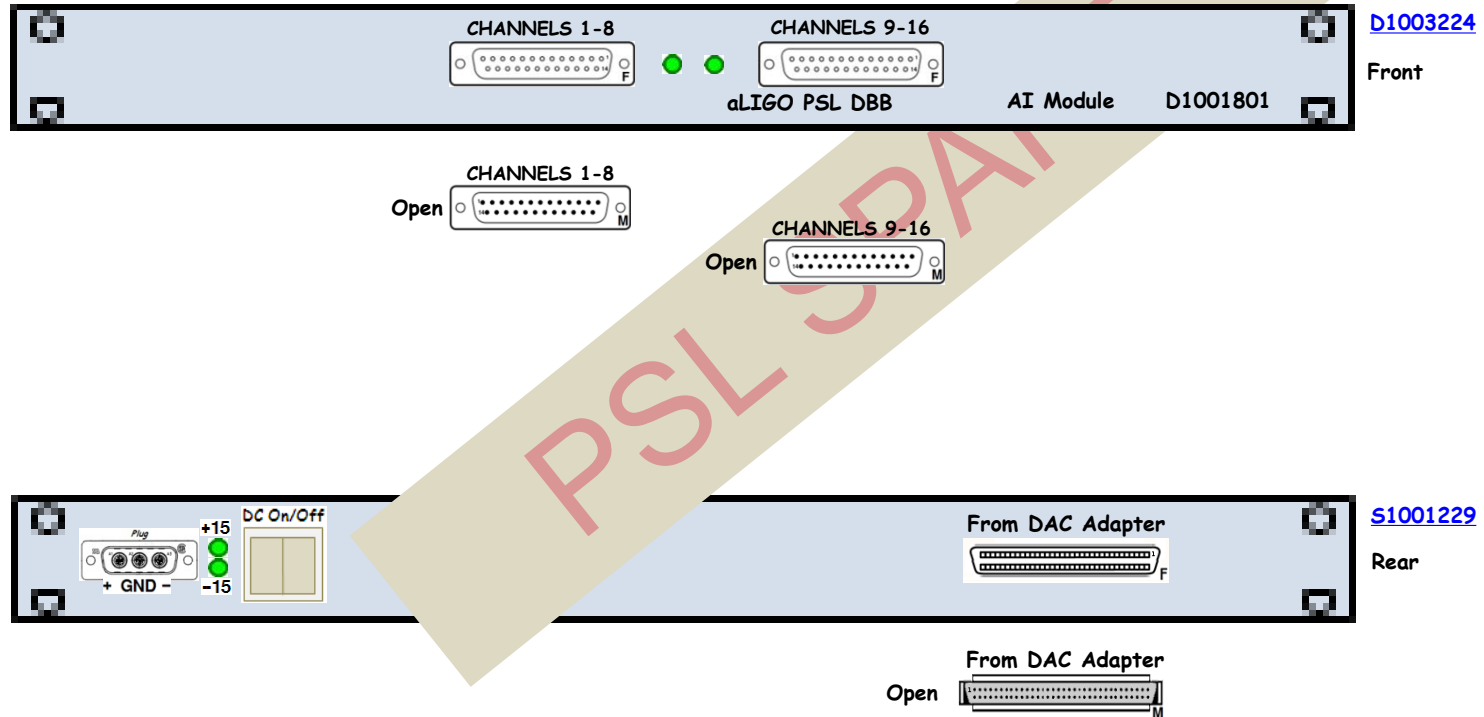

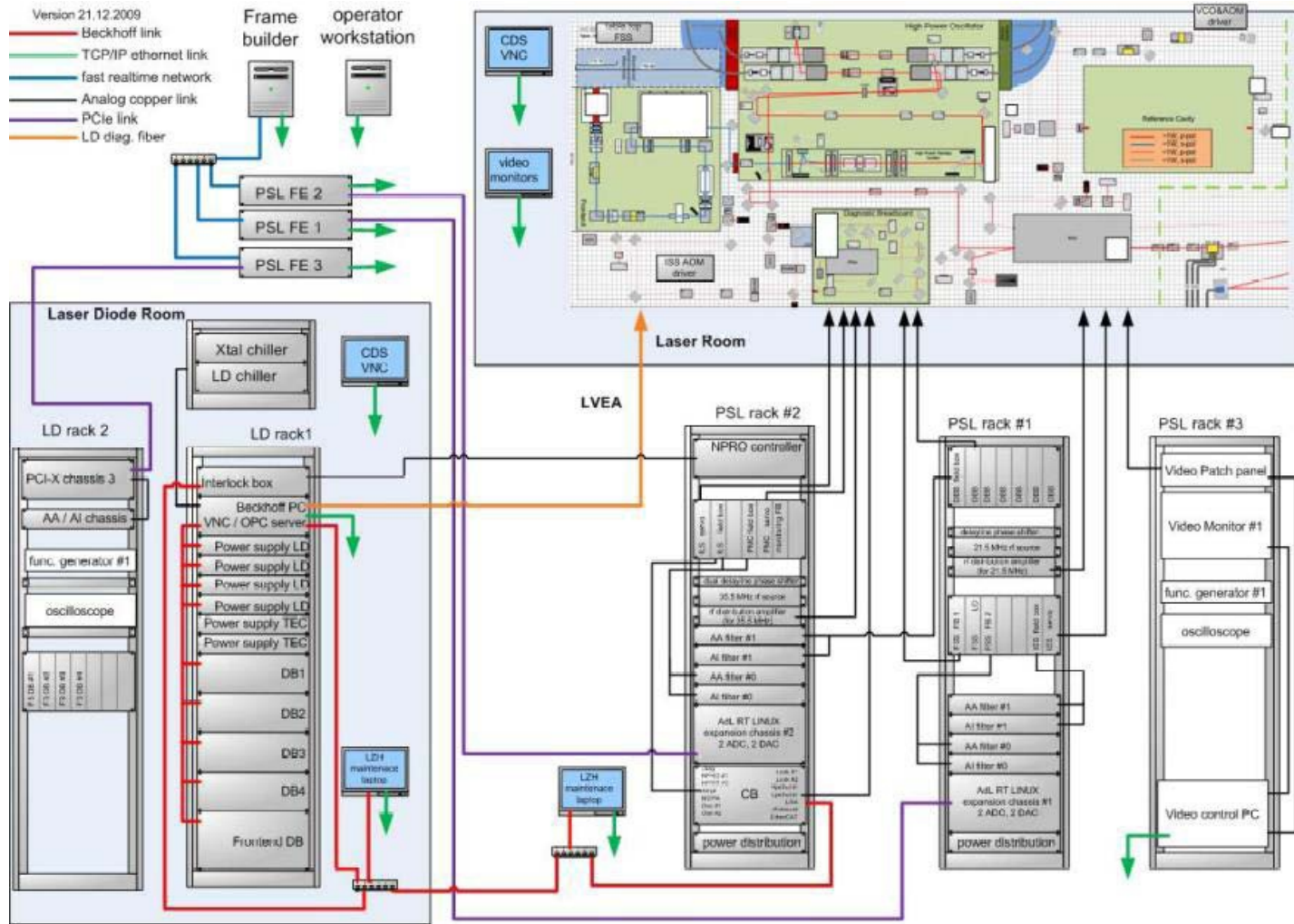

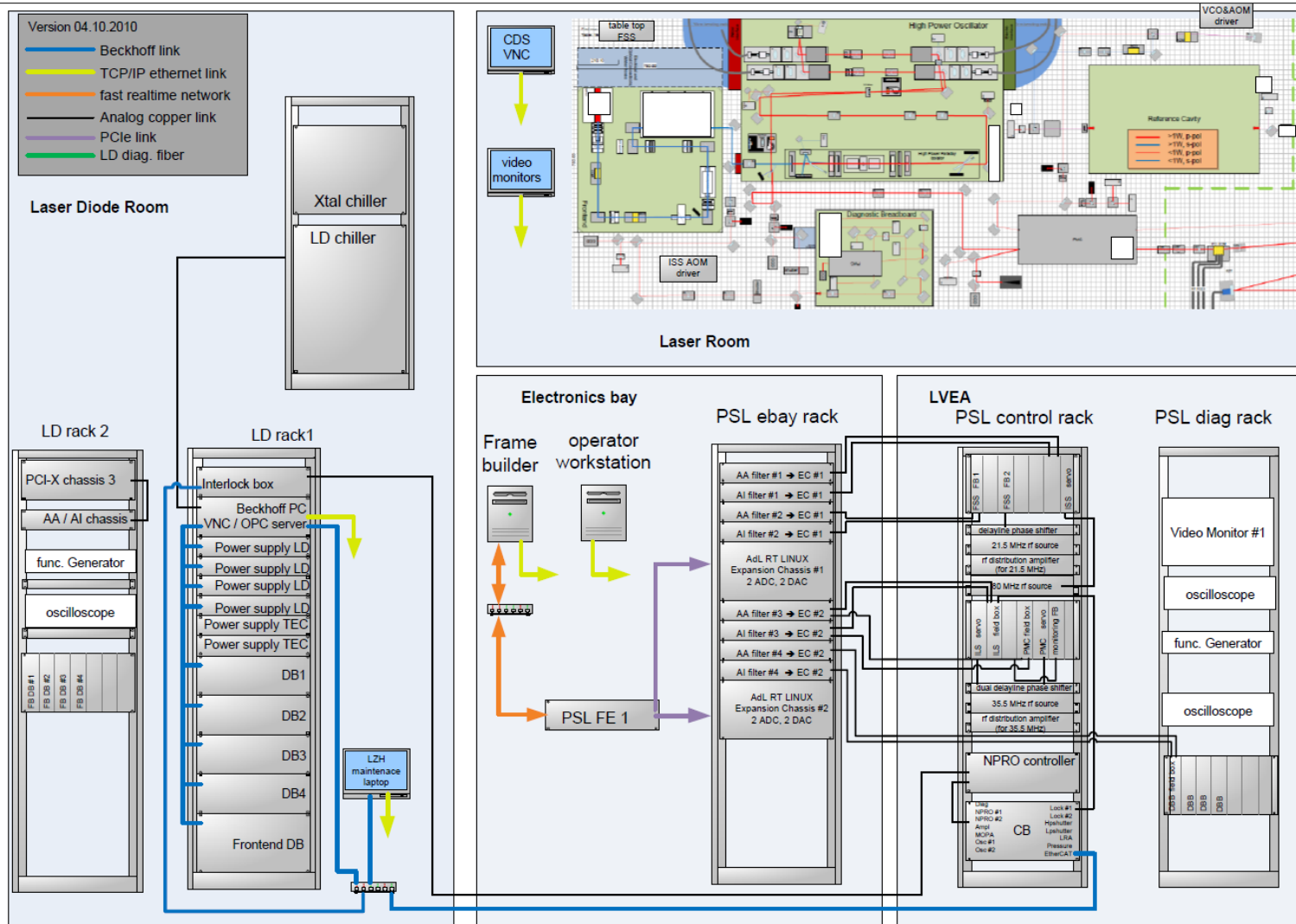

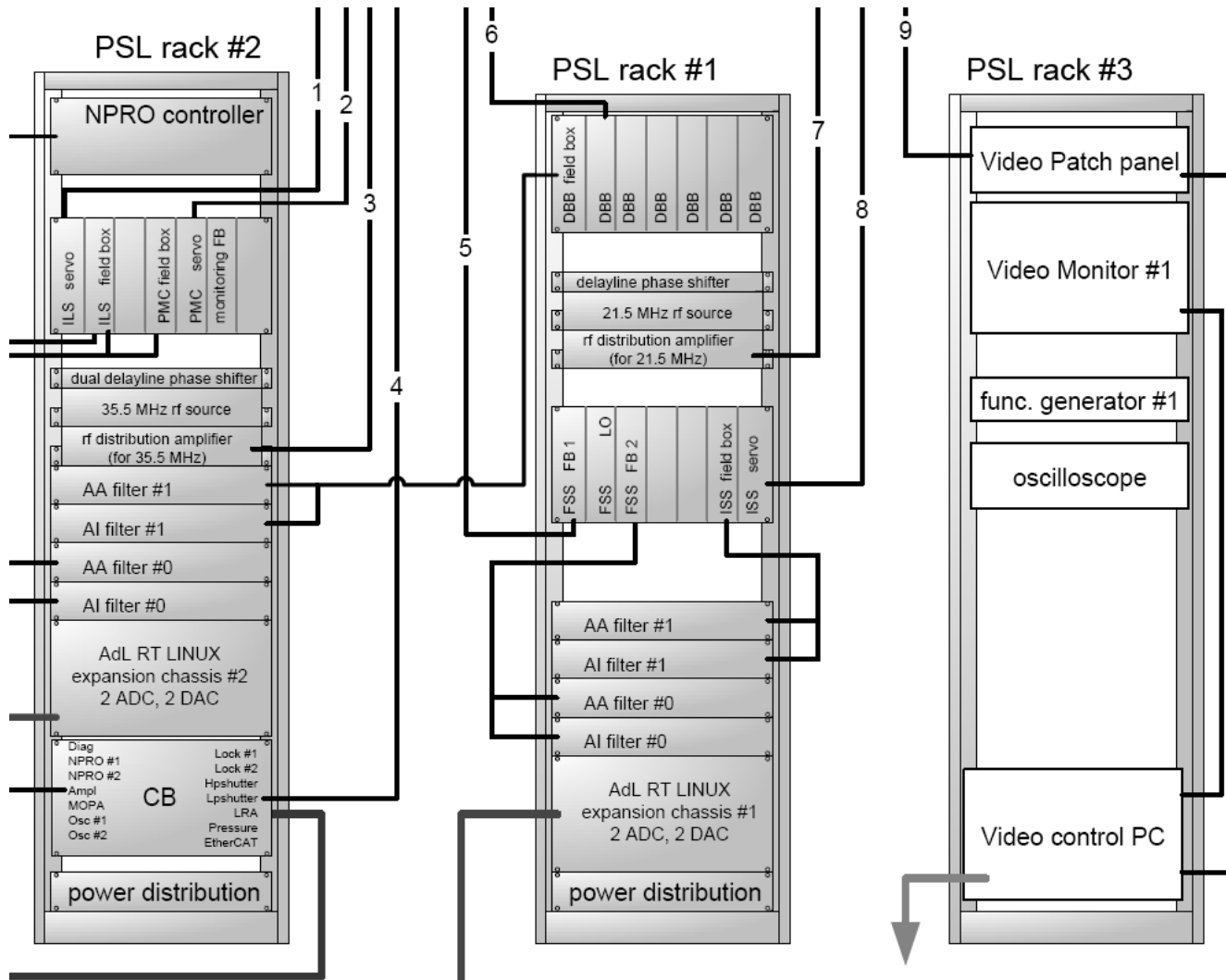

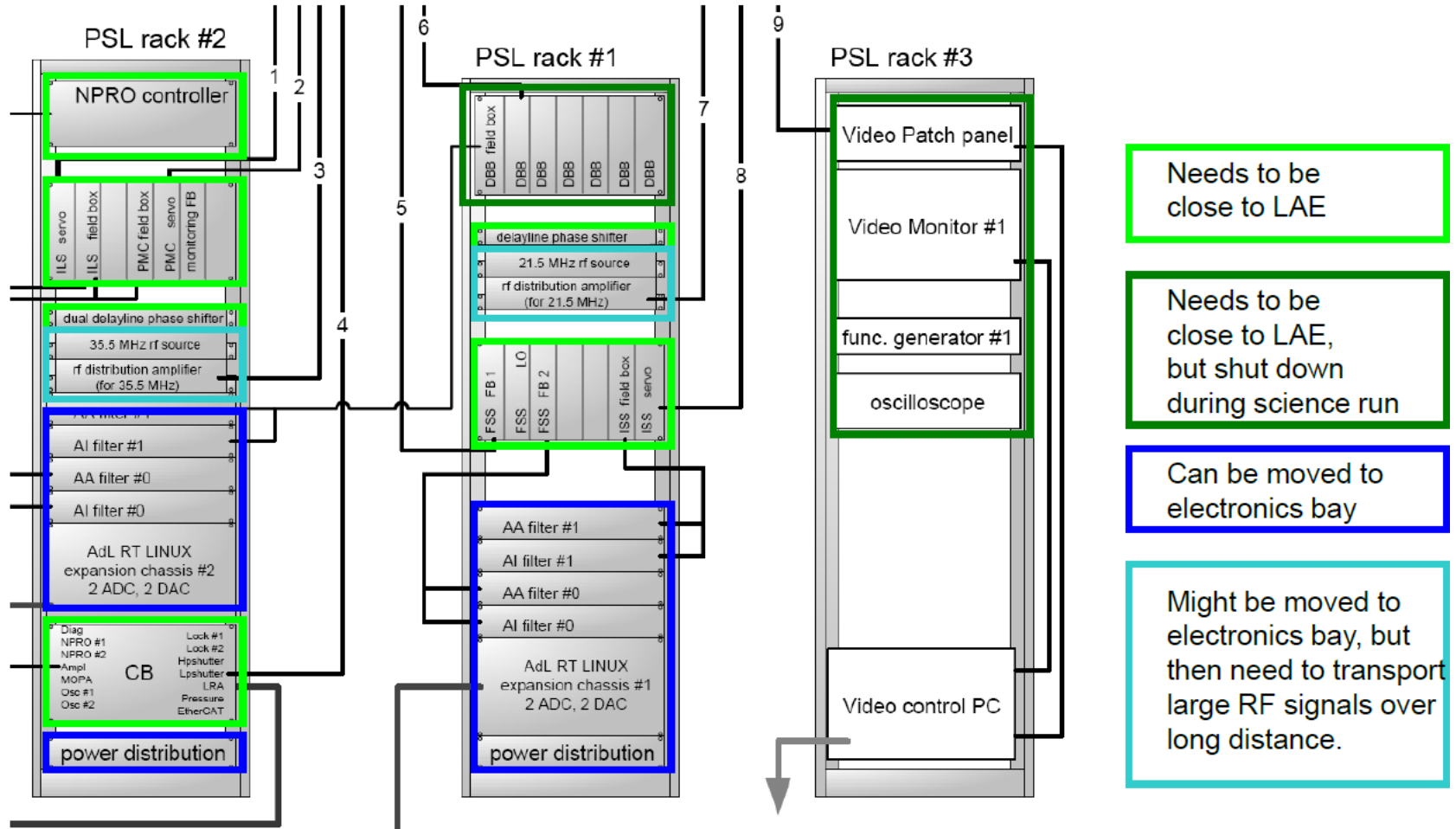



PSL RACKS - L1-PSL-01 - ILS and PMC

L1-PSL-01
Front NPRO
Controller

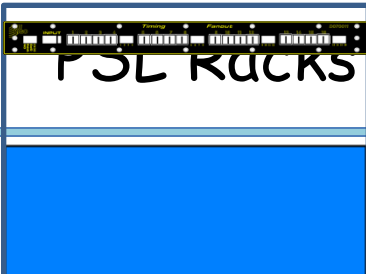

Eurocard
Crate
ECC-1 (ILS
and PMC)

DXXXXXXXX Delay Line Chassis

DXXXXXXXX 35.5MHz Amplifier Chassis

DXXXXXXXX 35.5MHz Amplifier Chassis

D1000305 AI Chassis
D1000305 AI Chassis
D0902783 AA Chassis
D0902783 AA Chassis

I/O Extension
2 ADC
2 DAC

Control Box
(CB)

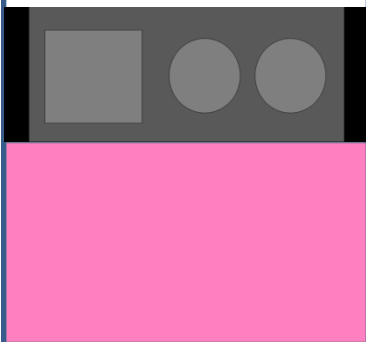

L1-PSL-01
Rear NPRO
Controller

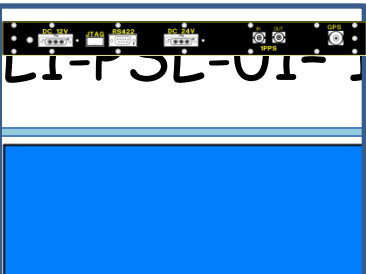

Eurocard
Crate
ECC-1 (ILS
and PMC)

DXXXXXXXX SYYYYYYYYY

DXXXXXXXX SYYYYYYYYY

DXXXXXXXX SYYYYYYYYY

D1000305 SYYYYYYYYY
D1000305 SYYYYYYYYY
D0902783 SYYYYYYYYY
D0902783 SYYYYYYYYY

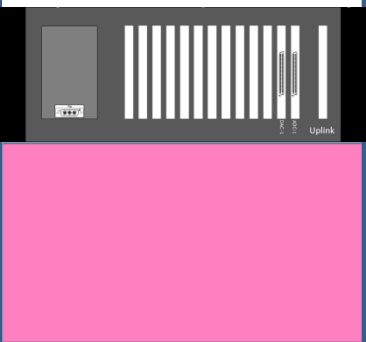

Control Box
(CB)

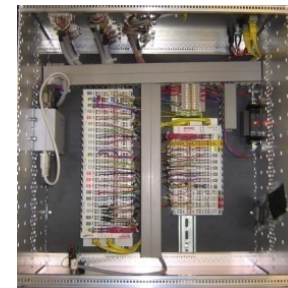
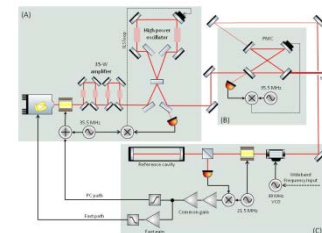

PSL Racks - L1-PSL-1-ECC-1 (ILS and PMC)

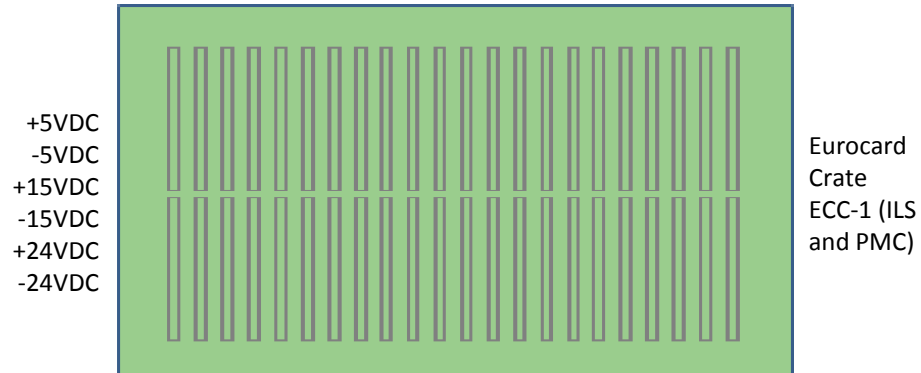
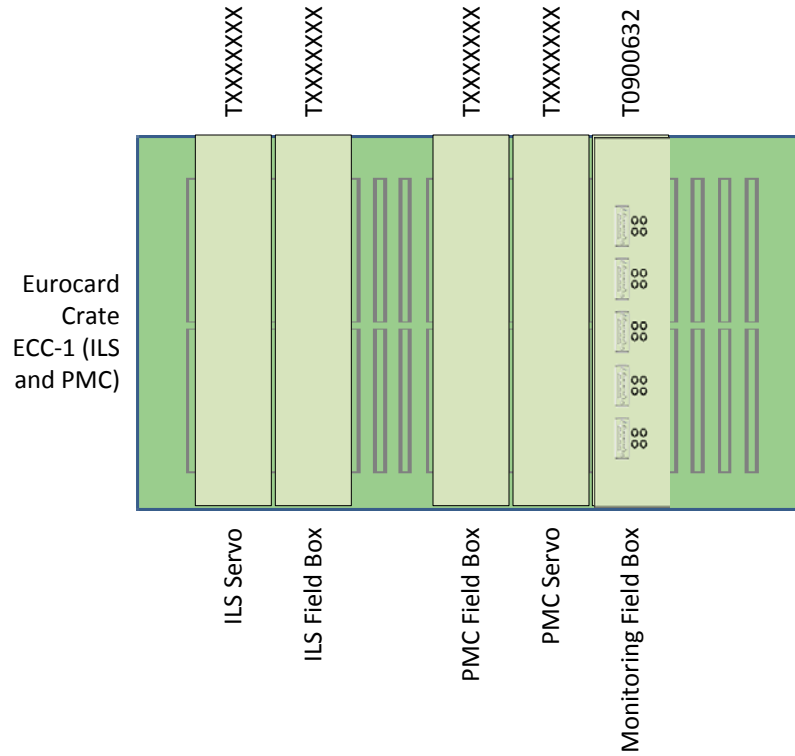



PSL RACKS - L1-PSL-02 (DBB, FSS, and ISS)

L1-PSL-02 (DBB, FSS, and ISS)

L1-PSL-02
Front Eurocard
Crate
ECC-1 (DBB)

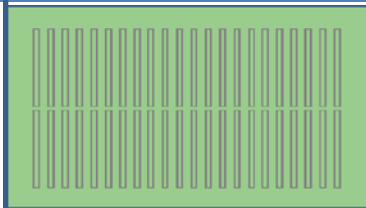

Eurocard
Crate
ECC-2 (FSS
and ISS)

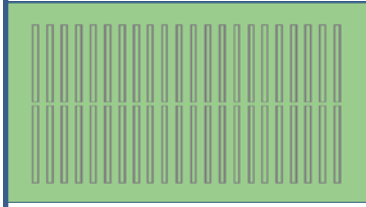

L1-PSL-02
Rear Eurocard
Crate
ECC-1 (DBB)

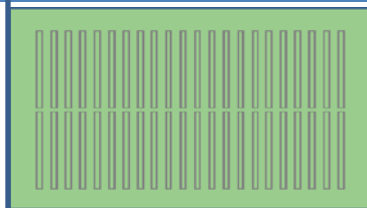

Eurocard
Crate
ECC-2 (FSS
and ISS)

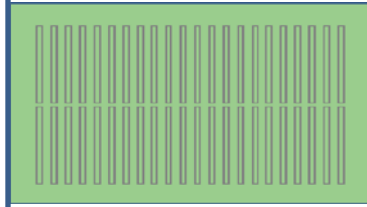

DXXXXXXXXX Delay Line Chassis



DXXXXXXXXX SYYYYYYYYY

DXXXXXXXXX 21.5MHz Amplifier Chassis



DXXXXXXXXX SYYYYYYYYY

DXXXXXXXXX 21.5MHz Amplifier Chassis



DXXXXXXXXX SYYYYYYYYY

D1000305 AI Chassis
D1000305 AI Chassis
D0902783 AA Chassis
D0902783 AA Chassis

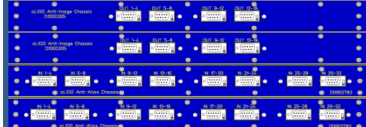

D1000305 SYYYYYYYYY
D1000305 SYYYYYYYYY
D0902783 SYYYYYYYYY
D0902783 SYYYYYYYYY

I/O Extension
2 ADC
2 DAC



Frequency Stabilization Servo
Intensity Stabilization Servo
Diagnostic Breadboard

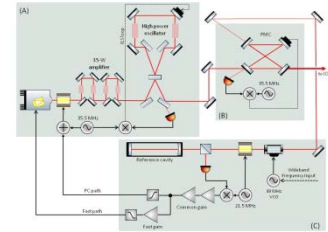

L1-PSL-02-ECC-1 (DBB)

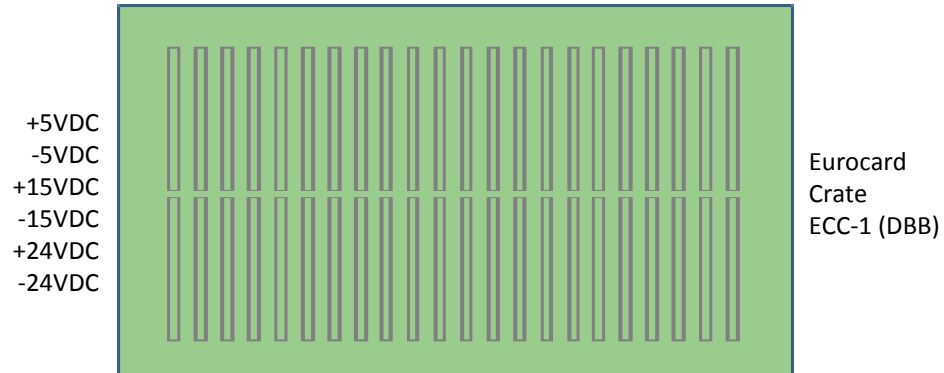
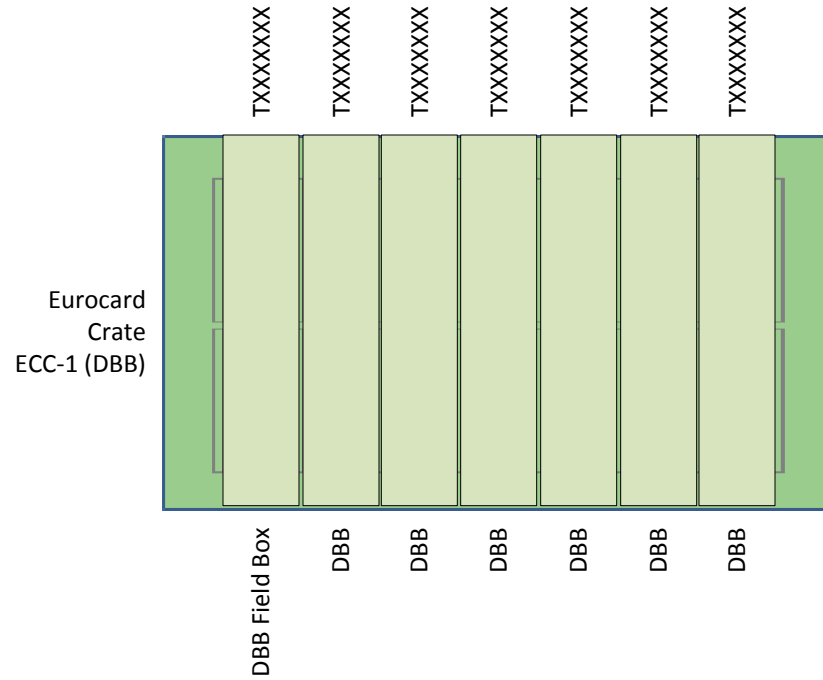

L1-PSL-02-ECC-2 (FSS and ISS)

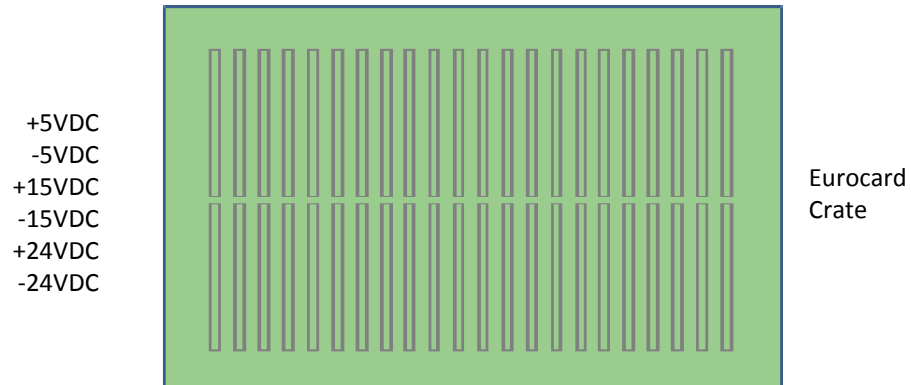
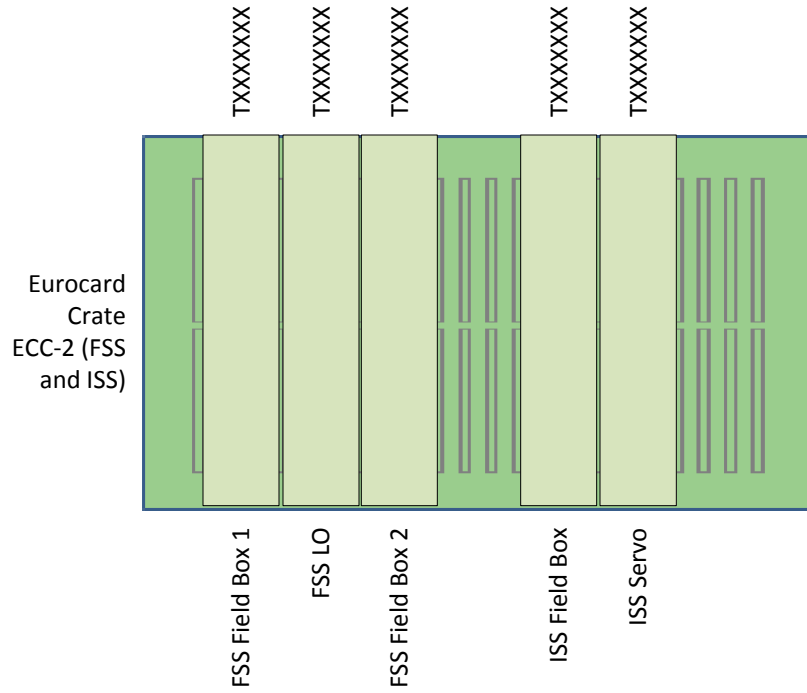



NPRO Controller

L1-PSL-01 Front

Eurocard Crate ECC-1 (DBB)

Eurocard Crate ECC-2 (FSS and ISS)

Eurocard Crate ECC-3 (ILS and PMC)

DXXXXXXXXX Delay Line Chassis

DXXXXXXXXX 21.5MHz Amplifier Chassis

DXXXXXXXXX 21.5MHz Amplifier Chassis

DXXXXXXXXX Delay Line Chassis

DXXXXXXXXX 35.5MHz Amplifier Chassis

DXXXXXXXXX 35.5MHz Amplifier Chassis

Control Box (CB)

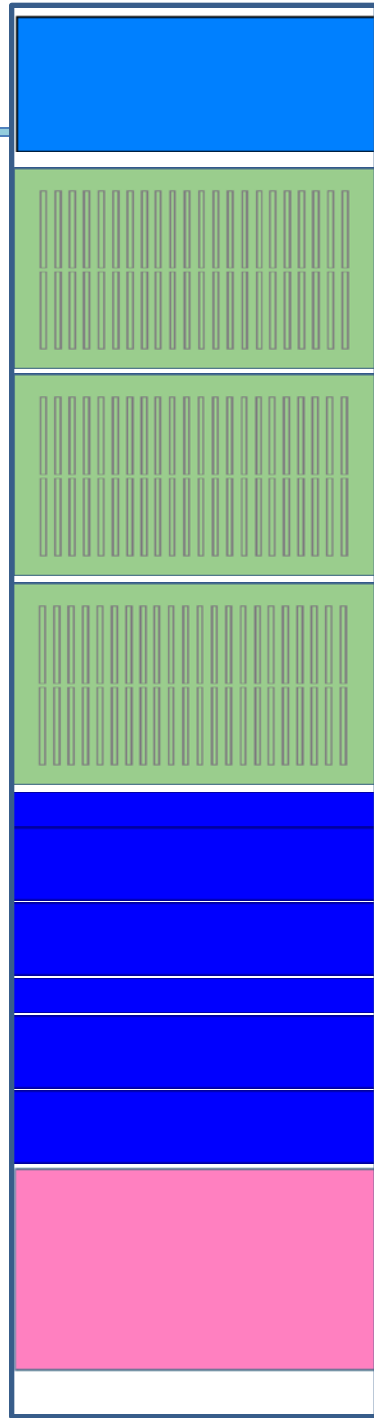

NPRO Controller

L1-PSL-01 Rear

Eurocard Crate ECC-1 (DBB)

Eurocard Crate ECC-2 (FSS and ISS)

Eurocard Crate ECC-3 (ILS and PMC)

DXXXXXXXXX SYYYYYYYYY

DXXXXXXXXX SYYYYYYYYY

DXXXXXXXXX SYYYYYYYYY

DXXXXXXXXX SYYYYYYYYY

DXXXXXXXXX SYYYYYYYYY

DXXXXXXXXX SYYYYYYYYY

Control Box (CB)

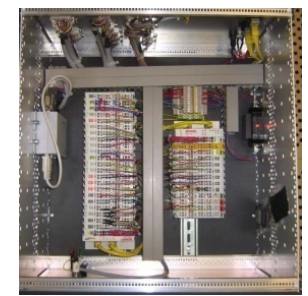
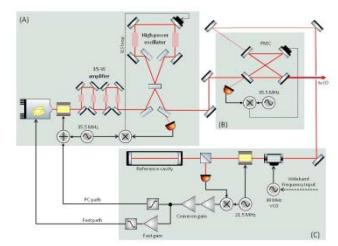
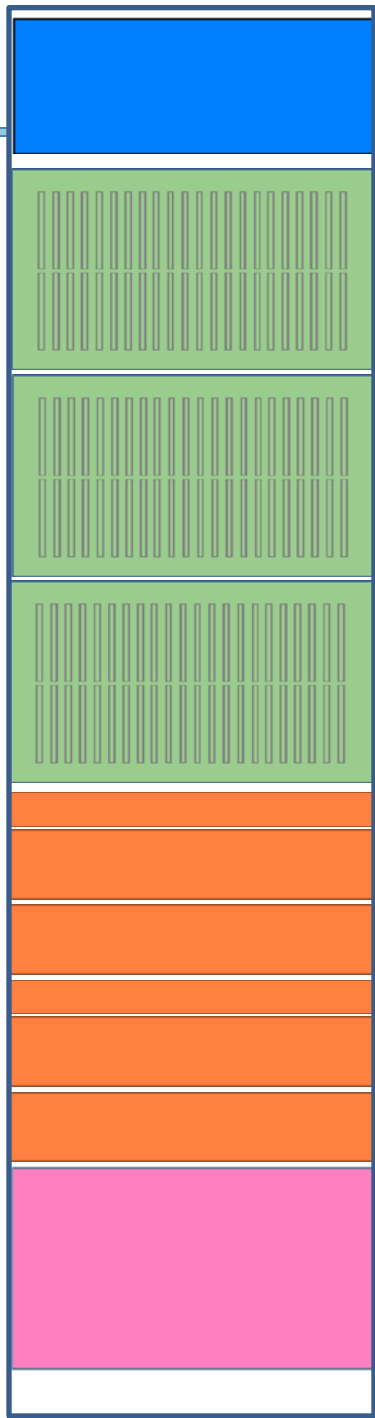



PSL Table

[T0900610](#)

LDR Rack 1 Layout (LIGO-Dxxxxxxx)

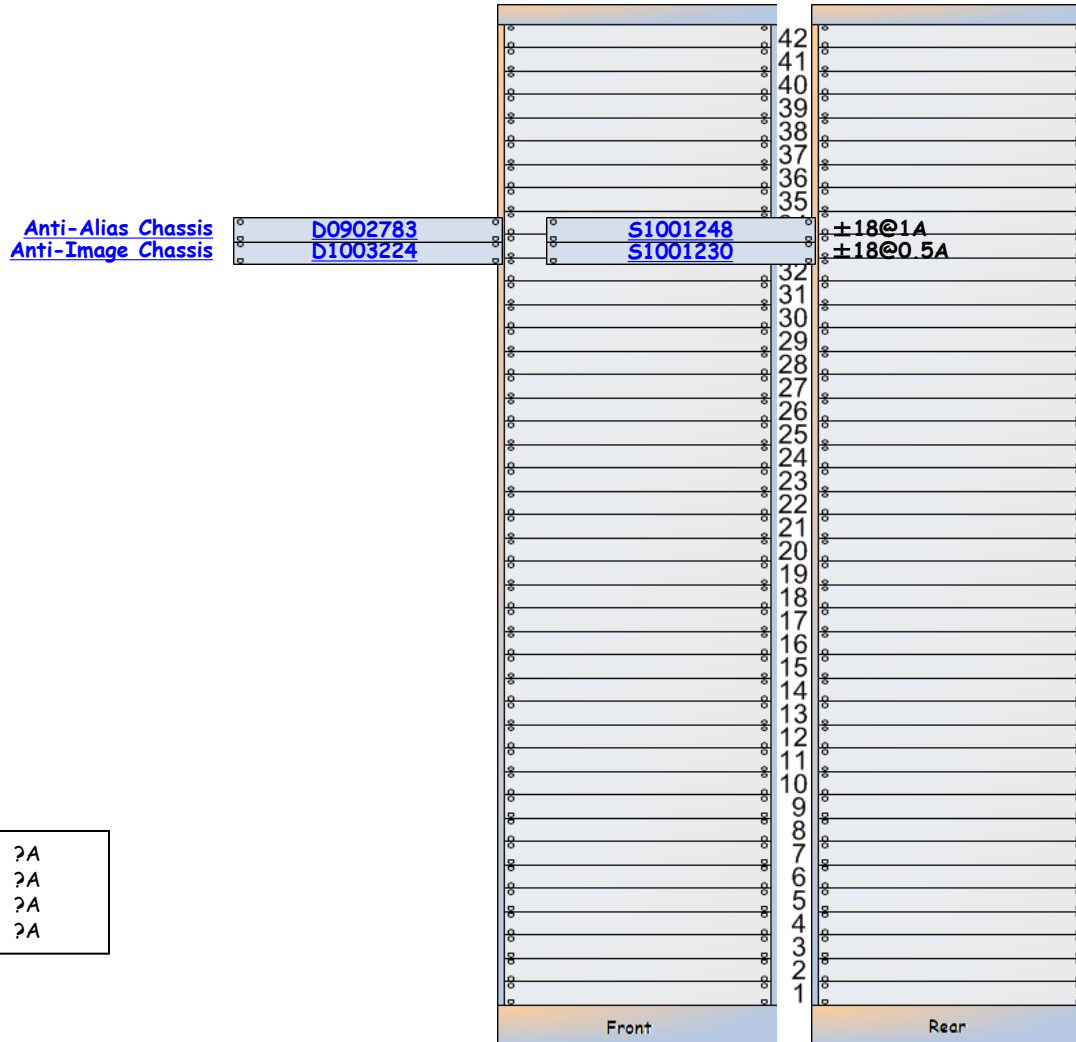

+18VDC	?A
-18VDC	?A
+24VDC	?A
-24VDC	?A



L1-LDR-C2

LDR Rack 2 Layout (LIGO-Dxxxxxxx)



+18VDC	?A
-18VDC	?A
+24VDC	?A
-24VDC	?A

L1-LDR-C3

LDR Rack 3 Layout (LIGO-Dxxxxxxx)



+18VDC	?A
-18VDC	?A
+24VDC	?A
-24VDC	?A

LDR Chiller

LDR Rack 4 Layout (Chillers) (LIGO-Dxxxxxxx)

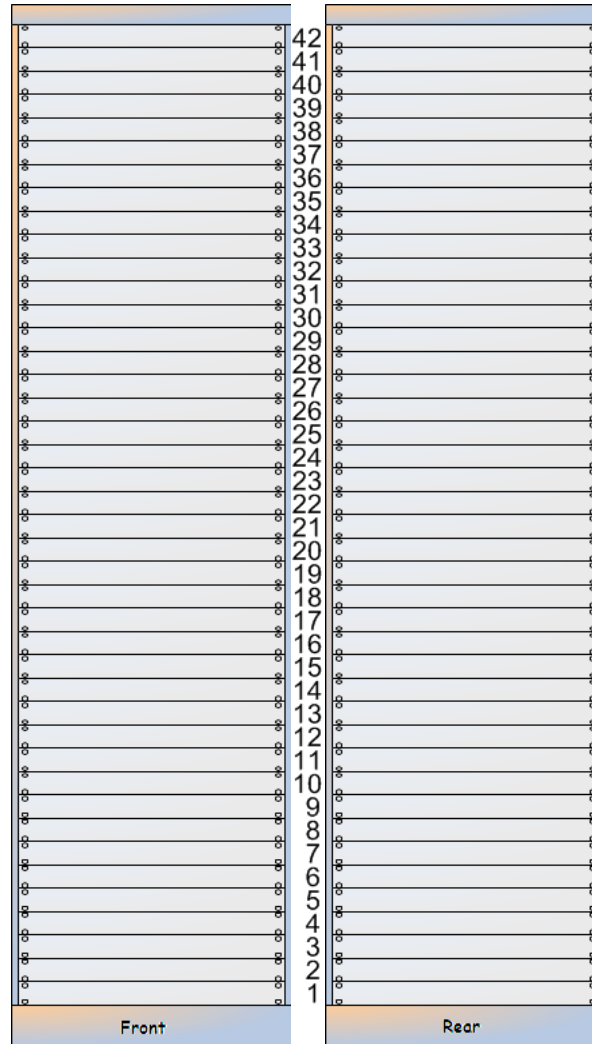

+18VDC	?A
-18VDC	?A
+24VDC	?A
-24VDC	?A

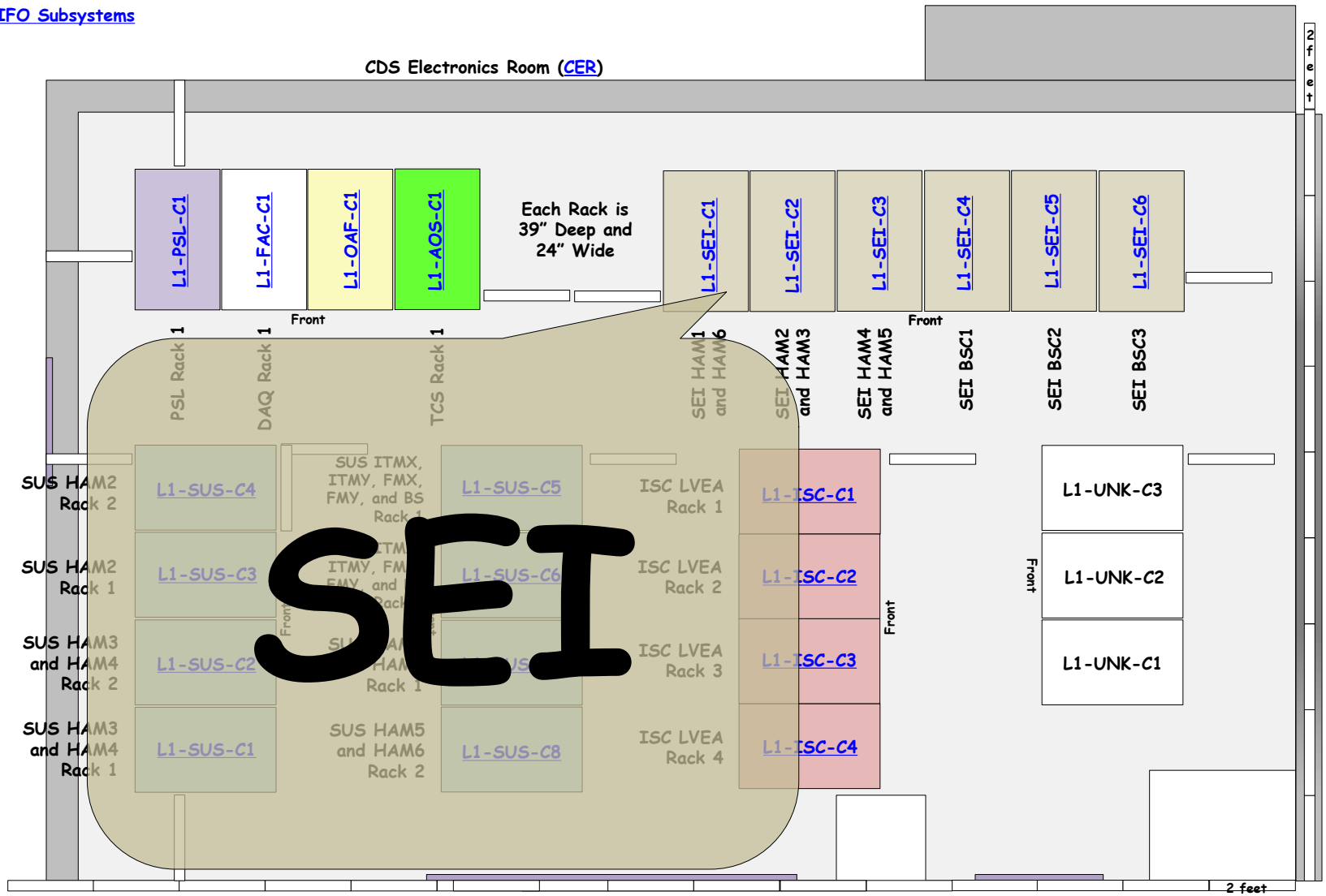

HAM2 HEPI 8-Channel Valve Driver	<input type="text" value="D0900117"/>	<input type="text" value="S0900275"/>	+18V@0.72A, -18V@0.72A
HAM3 HEPI 8-Channel Valve Driver	<input type="text" value="D0900117"/>	<input type="text" value="S0900290"/>	+18V@0.72A, -18V@0.72A

HAMs 1&6 L1-SEI-C1

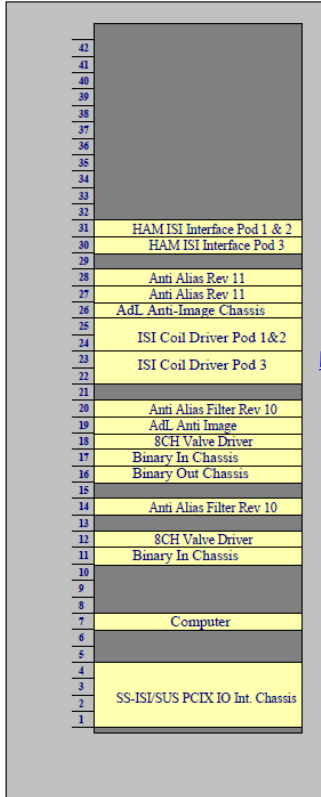

- ISI 6
 - HAM6 ISI Interface Chassis
 - HAM6 ISI Interface Chassis
 - Anti-Alias Chassis
 - Anti-Alias Chassis
 - Anti-Image Chassis
 - HAM6 ISI Coil Driver Pod 1 and Pod 2
 - HAM6 ISI Coil Driver Pod 3
 - HAM6 ISI Coil Driver Pod 3
- HEPI 1
 - Anti-Image Chassis
 - Anti-Alias Chassis
 - HAM1 HEPI 8-Channel Valve Driver
- HEPI 6
 - Binary Input Chassis
 - Binary Output Chassis
 - Anti-Alias Chassis
 - HAM6 HEPI 8-Channel Valve Driver

l1seiham1-6 I/O Extension Chassis

SEI-C1 is part of [D1101584](#)

42		
41		
40		
39		
38		
37		
36		
35		
34		
33		
32		
31	D100067	Serial
30	D100067	Serial
29		
28	Dnumber	Serial
27	Dnumber	Serial
26	Dnumber	Serial
25	D0902744	SN:
24		
23	D0902744	SN:
22		
21	Dnumber	Serial
20	Dnumber	Serial
19	D020373	S1000842
18	Dxxxxxxx	SN:
17	Dxxxxxxx	SN:
16		
15		
14	Dnumber	Serial
13		
12	D0901338	Serial
11		
10		
9		
8		
7		
6		
5		
4		
3		
2		
1		

- +18V@0.32A, -18V@0.33
- +18V@0.32A, -18V@0.33
- ±18@1A
- ±18@1A
- ±18@0.5A
- +24V@1.2A, -24V@0.8A (+10A)
- +24V@1.2A, -24V@0.8A (+10A)
- ±18@0.5A
- ±18@1A
- +18V@0.72A, -18V@0.72A
- ±18@0.5A
- ±18@0.5A
- ±18@1A
- +18V@0.72A, -18V@0.72A

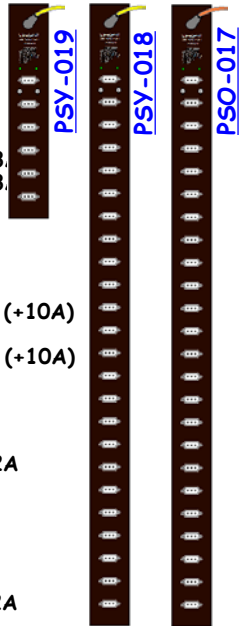

+18VDC	9A
-18VDC	9A
+24VDC	?A
-24VDC	?A

Front

Rear

+24@5A

L1-SEI-C1 Details

SEI-C1 is part of [D1101584](#)

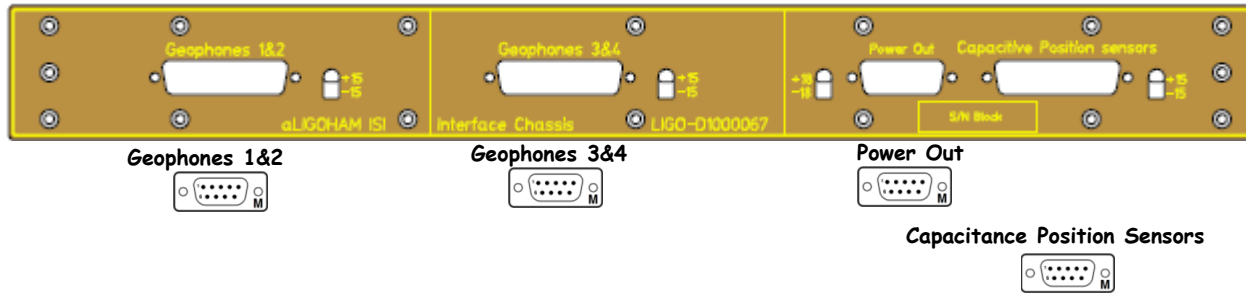

[D1000067](#)

Front

Sxxxxxxx

Rear

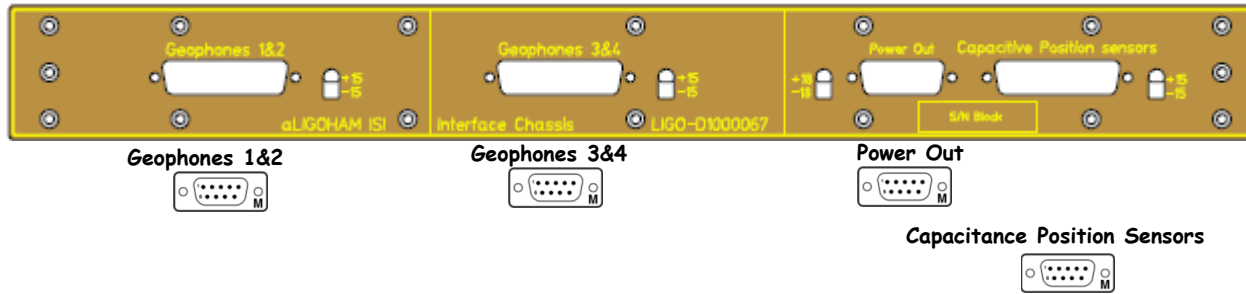

[D1000067](#)

Front

Sxxxxxxx

Rear

<< L1-SEI-C1

HAM6 ISI Coil Driver Pod 1 and Pod 2

D0902744

Sxxxxxxx

+24V@1.2A, -24V@0.8A (+10A)

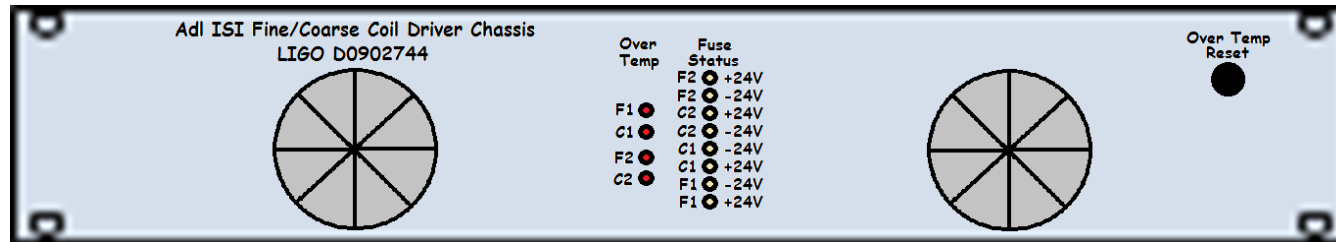

D0902744

Front

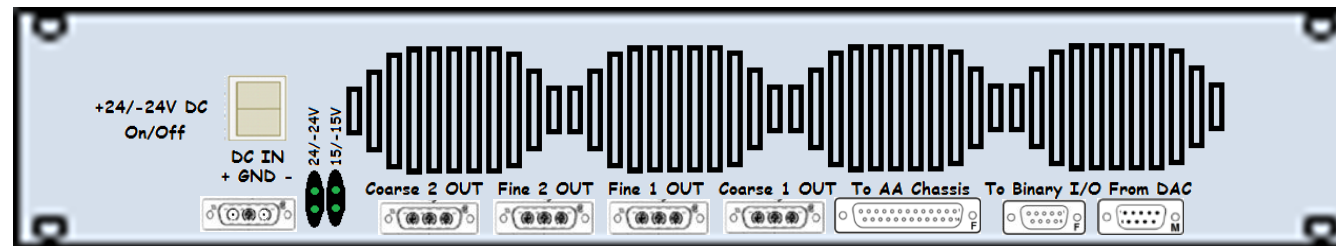

Sxxxxxxx

Rear

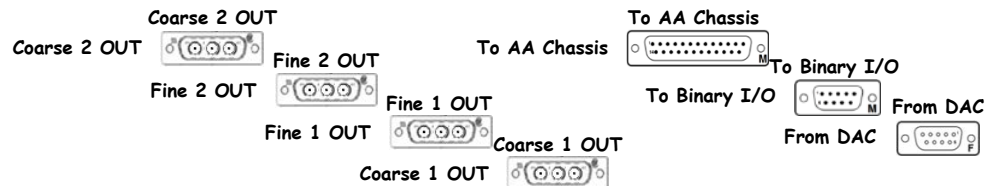

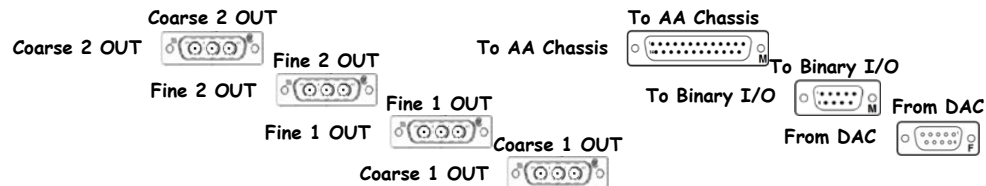
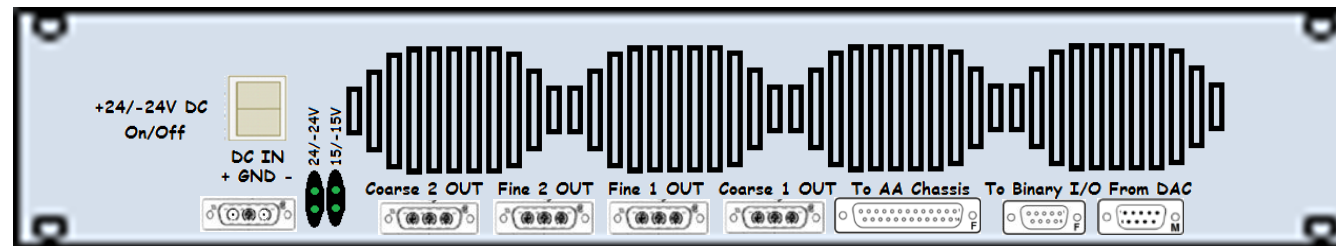
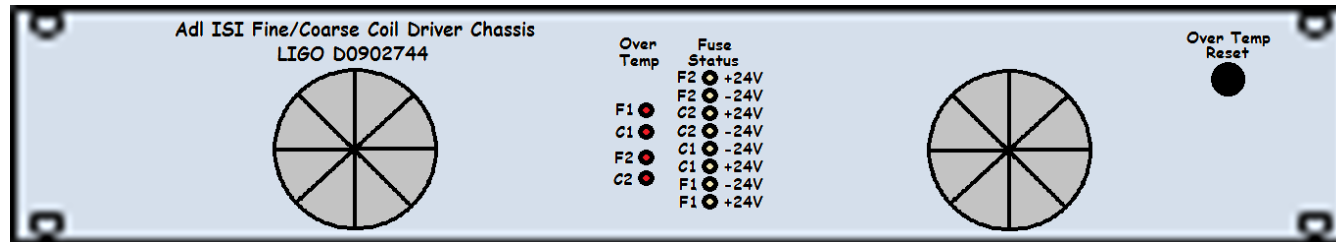

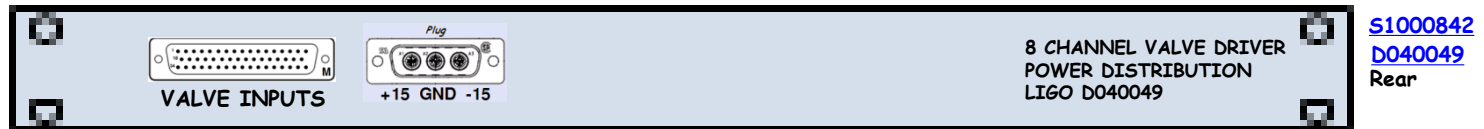
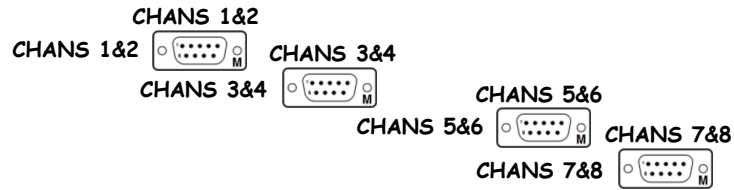
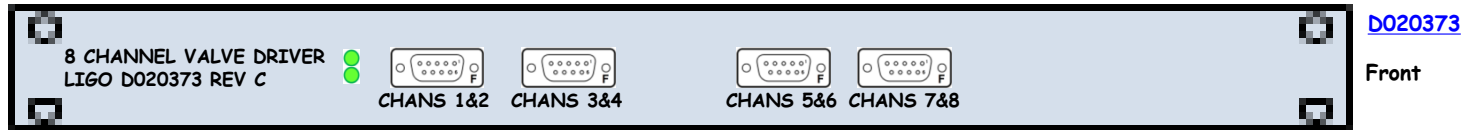

<< L1-SEI-C1

HEPI6 8-Channel Valve Driver Power

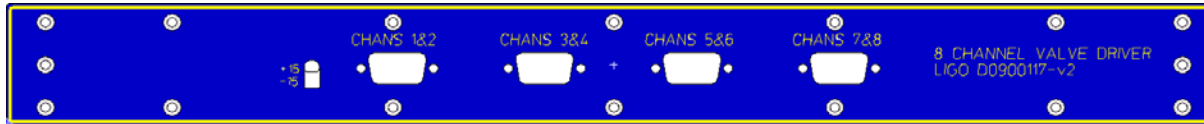

[D0901338](#)

Front

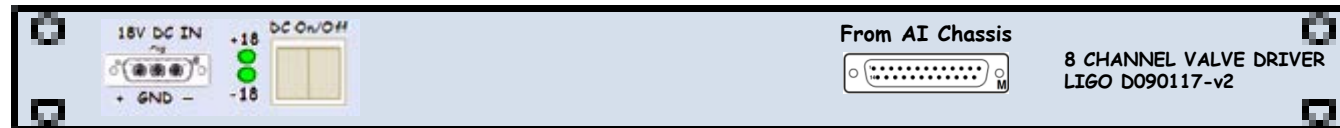
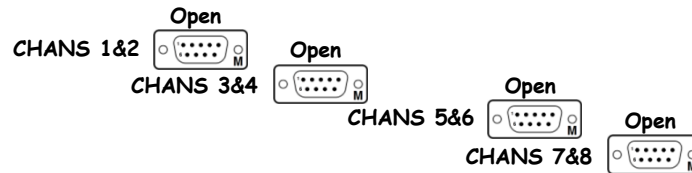

SN:

Rear





D1001715

Front

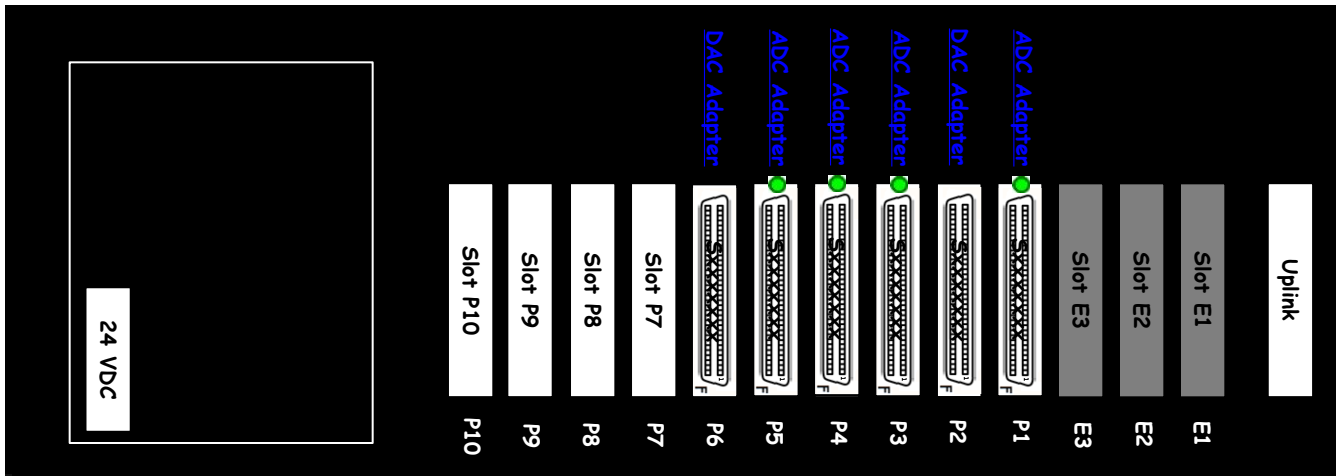

S1001144

Rear

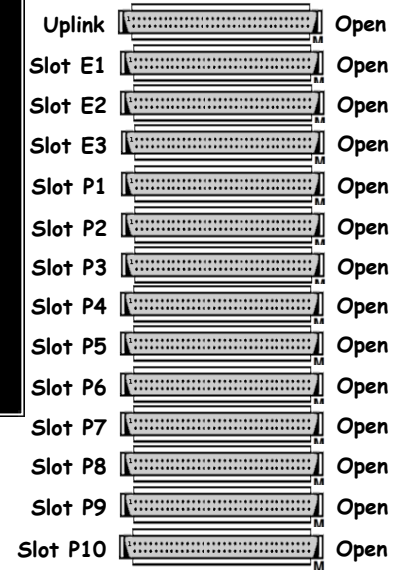



SEI Racks

L1-SEI-01

L1-SEI-01
Front

L1-SEI-01
Rear

Dxxxxxx ISI IF Chassis
 Dxxxxxx ISI IF Chassis
 Dxxxxxx ISI IF Chassis
 D0902783 AA Chassis
 D0902783 AA Chassis
 D0902783 AA Chassis
 Dxxxxxx BO Chassis
 Dxxxxxx BO Chassis
 Dxxxxxx BI Chassis
 Dxxxxxx BI Chassis

D0902783 AA Chassis
 D1000305 AI Chassis
 Dxxxxxx 8 Valve Chassis
 Dxxxxxx BO Chassis
 Dxxxxxx BI Chassis

Dxxxxxx T240 IF Chassis
 Dxxxxxx T240 IF Chassis
 Dxxxxxx T240 IF Chassis

I/O Extension
 4 ADC
 2 DAC
 4 Binary

D1000305 AI Chassis
 Dxxxxxx ISI Coil Chassis
 Dxxxxxx ISI Coil Chassis
 Dxxxxxx ISI Coil Chassis

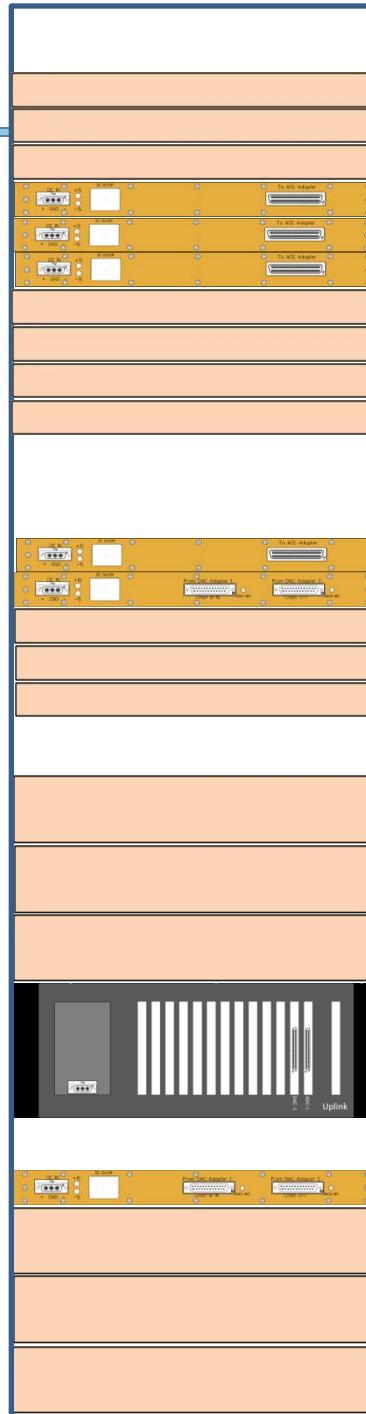
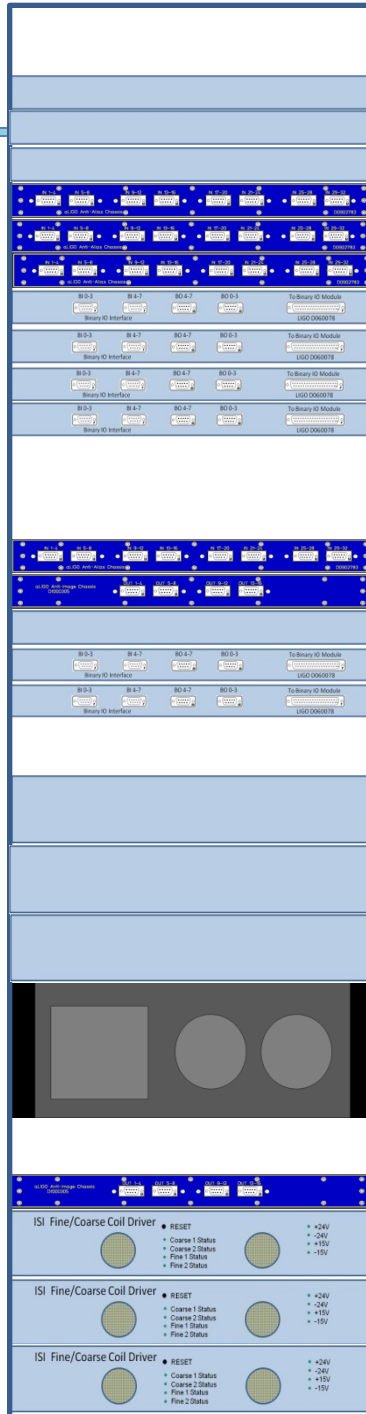

D0902783 SYYYYYYY
 D0902783 SYYYYYYY
 D0902783 SYYYYYYY

D0902783 SYYYYYYY
 D1000305 SYYYYYYY

D1000305 SYYYYYYY

1	Tuning Slave
2	
3	ISI Interface Pod 1
4	ISI Interface Pod 2
5	ISI Interface Pod 3
6	
7	Ann Alias Rev 12
8	Ann Alias Rev 12
9	
10	Ann Alias Rev 12
11	Ann Alias Rev 8 HEPI
12	
13	Binary In/Out Chassis
14	Binary In/Out Chassis
15	
16	AdL Anti-Image Chassis HEPI
17	
18	8 CH VALVE DRIVER HEPI
19	Binary I/O Chassis HEPI
20	
21	T-240 Interface Pod 1
22	T-240 Interface Pod 2
23	
24	T-240 Interface Pod 3
25	
26	
27	
28	
29	
30	ISI PCIX IO Interface Chassis 1
31	
32	ISI Control CPU
33	
34	AdL Anti-Image Chassis
35	
36	ISI Coil Driver Pod 1
37	ISI Coil Driver Pod 2
38	ISI Coil Driver Pod 2
39	
40	ISI Coil Driver Pod 3
41	

LIGO-D0601301

42	HAM ISI Interface Pod 1 & 2
41	HAM ISI Interface Pod 3
40	
39	Anti Alias Rev 11
38	Anti Alias Rev 11
37	HEPI Anti-Image
36	ISI Coil Driver Pod 1 & 2
35	ISI Coil Driver Pod 3
34	ISI Coil Driver Pod 3
33	
32	
31	HAM ISI Interface Pod 1 & 2
30	HAM ISI Interface Pod 3
29	
28	Anti Alias Rev 11
27	Anti Alias Rev 11
26	HEPI Anti-Image
25	ISI Coil Driver Pod 1&2
24	ISI Coil Driver Pod 3
23	ISI Coil Driver Pod 3
22	
21	
20	Anti Alias Filter Rev 10
19	
18	8CH Valve Driver
17	Binary In Chassis
16	Binary Out Chassis
15	
14	Anti Alias Filter Rev 10
13	
12	8CH Valve Driver
11	
10	
9	
8	
7	
6	
5	
4	
3	SS-ISI/SUS PCIX IO Int. Chassis
2	
1	

DCC Number: D1101576
Date: 8/11/2011 Revision: V2

HAM2 ISI Interface Chassis
HAM2 ISI Interface Chassis

HAM2 ISI Anti-Alias Chassis
HAM2 ISI Anti-Alias Chassis
HAM2 HEPI Anti-Image Chassis

HAM2 ISI Coil Driver Pod 1 and Pod 2
HAM2 ISI Coil Driver Pod 3

HAM3 ISI Interface Chassis
HAM3 ISI Interface Chassis

HAM3 ISI Anti-Alias Chassis
HAM3 ISI Anti-Alias Chassis
HAM3 HEPI Anti-Image Chassis

HAM3 ISI Coil Driver Pod 1 and Pod 2
HAM3 ISI Coil Driver Pod 3

HEPI 3
HAM2 HEPI Anti-Alias Chassis

HAM2 HEPI 8-Channel Valve Driver
Binary Input Chassis
Binary Output Chassis

HEPI 3
HAM3 HEPI Anti-Alias Chassis

HAM3 HEPI 8-Channel Valve Driver

I/O Extension Chassis

Dnumber	42
	41
	40
D1000269	39
D1000269	38
D1100202	37
D0902744	36
	35
D0902744	34
	33
Dnumber	32
Dnumber	31
	30
	29
D1000269	28
D1000269	27
D1100202	26
D0902744	25
	24
D0902744	23
	22
	21
D1000272	20
	19
D020373	18
D1001726	17
D1001728	16
	15
D1000272	14
	13
D020373	12
	11
	10
	9
	8
	7
	6
	5
	4
	3
	2
	1

Front

D1001715

Serial	42
Serial	41
	40
S1104621	39
S1104638	38
S1104572	37
S1103318	36
	35
S1103332	34
	33
Serial	32
Serial	31
	30
	29
S1104632	28
S1104635	27
S1104573	26
S1103306	25
	24
S1103304	23
	22
S1104616	20
	19
S1000843	18
S1101286	17
S1101321	16
	15
S1104615	14
	13
S1000844	12
	11
	10
	9
	8
	7
	6
	5
	4
	3
	2
	1

Rear

S1001145

+18V@0.32A, -18V@0.33A
+18V@0.32A, -18V@0.33A

±18@1A
±18@1A
±18@0.5A

+24V@1.2A, -24V@0.8A
+24V@1.2A, -24V@0.8A

+18V@0.32A, -18V@0.33A
+18V@0.32A, -18V@0.33A

±18@1A
±18@1A
±18@0.5A

+24V@1.2A, -24V@0.8A (+10A)
+24V@1.2A, -24V@0.8A (+10A)

±18@1A

+18V@0.72A, -18V@0.72
±18@0.5A
±18@0.5A

±18@1A

+18V@0.72A, -18V@0.72A

+24@5A



+18VDC	11A
-18VDC	11A
+24VDC	?A
-24VDC	?A

SEI-C2 is part of [D1101576](#)

L1-SEI-C2 Details

HAM2 ISI Anti-Alias Chassis D1000269 S1104621 ±18@1A

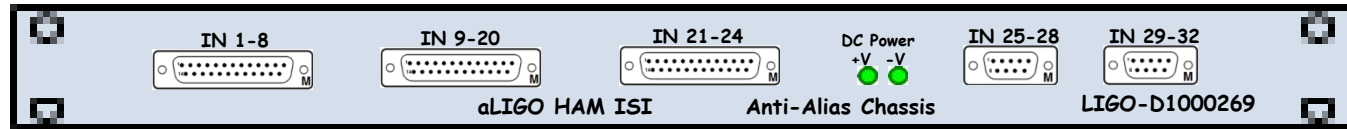

[D1000269](#)

Front

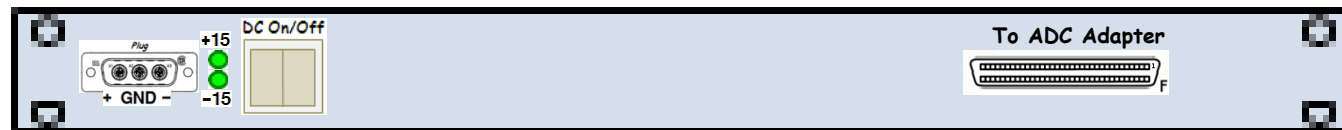
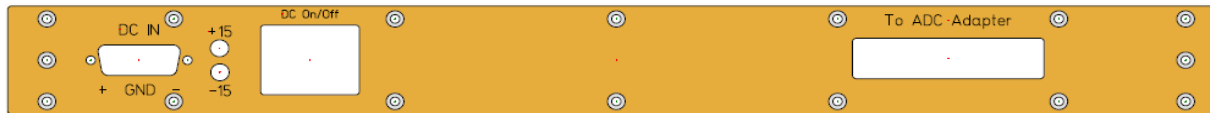
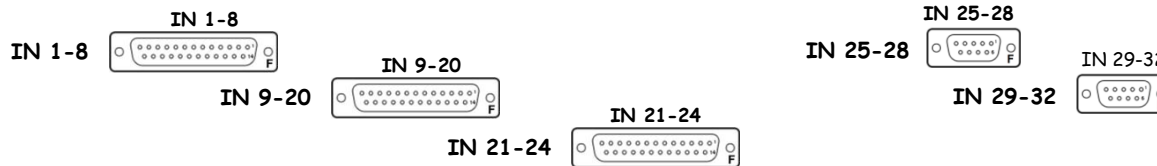

[S1104621](#)

Rear



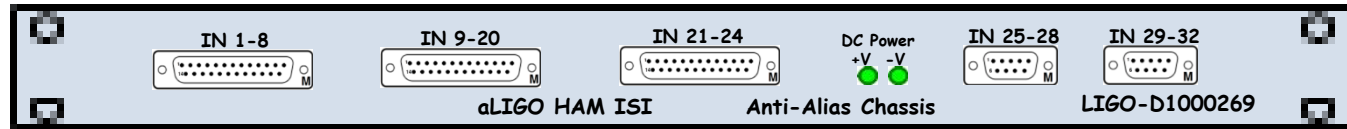

[D1000269](#)

Front

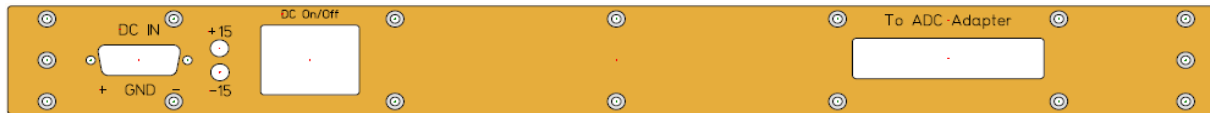
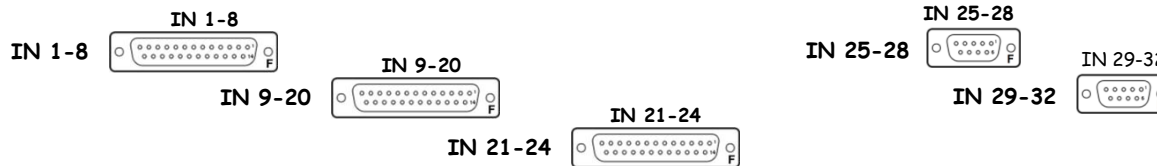

[S1104638](#)

Rear



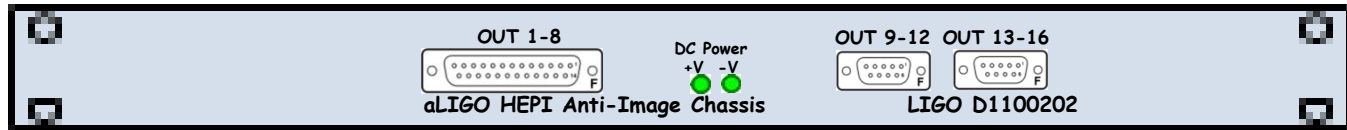

[D1100202](#)

Front

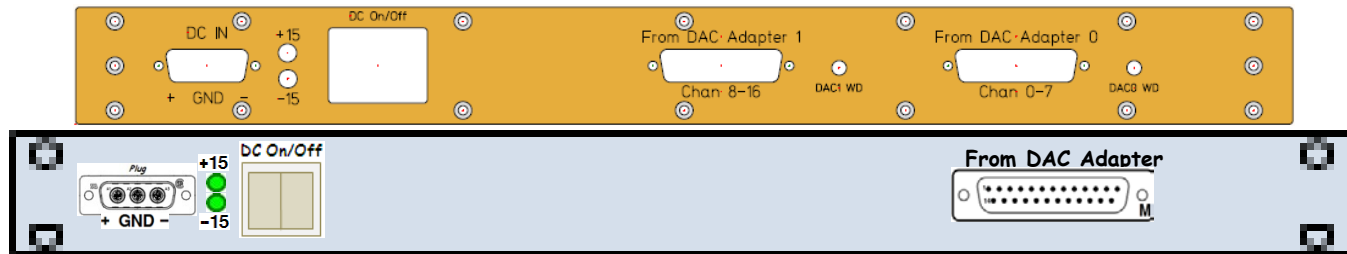

[S1104572](#)

Rear



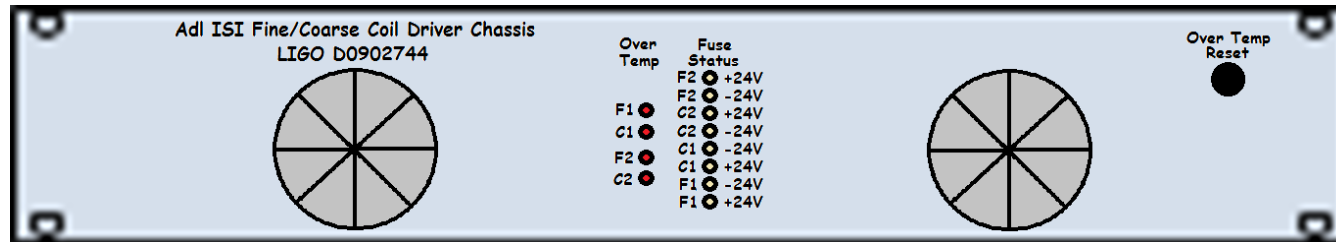

D0902744

Front

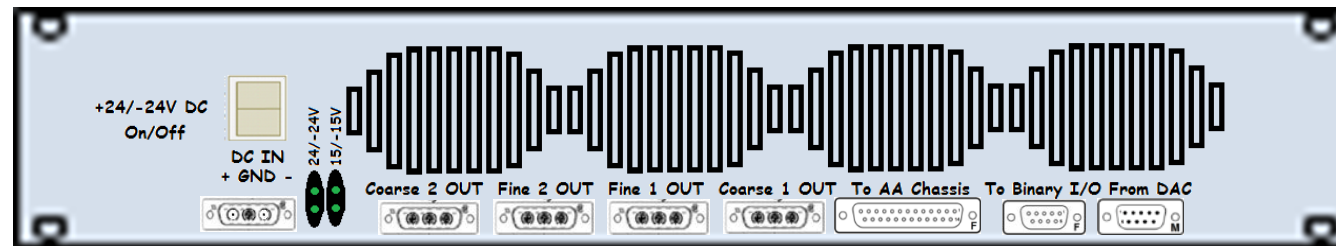

S1103318

Rear

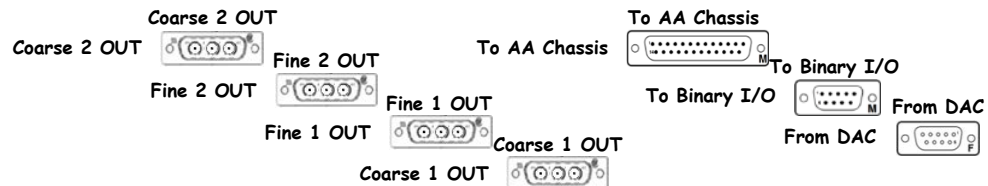

D0902744 - S1103332



<< L1-SEI-C2

HAM2 ISI Coil Driver Pod 3

D0902744

S1103332

+24V@1.2A, -24V@0.8A (+10A)

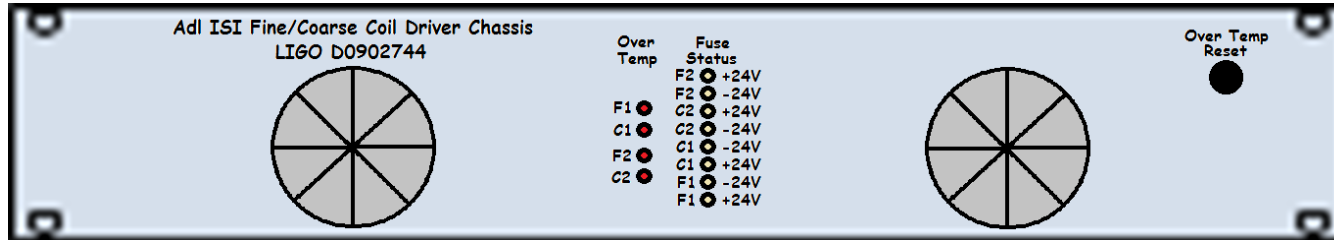

D0902744

Front

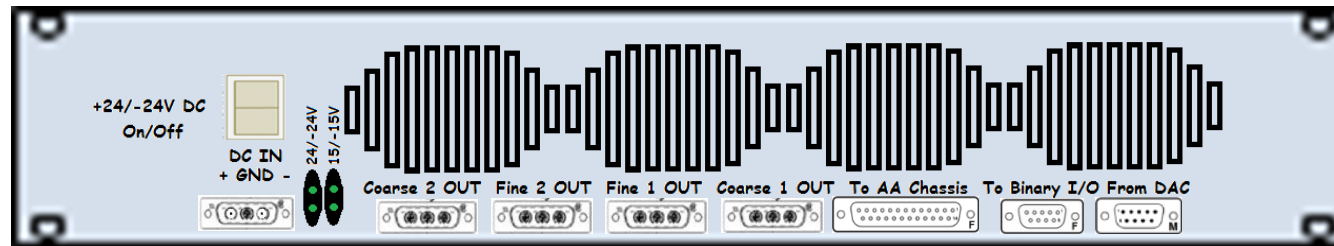

S1103332

Rear

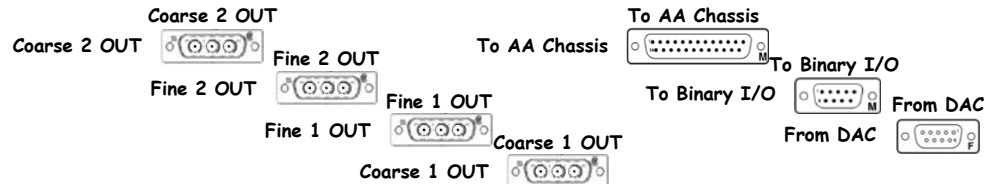

HAM3 ISI Anti-Alias Chassis D1000269 S1104632 ±18@1A

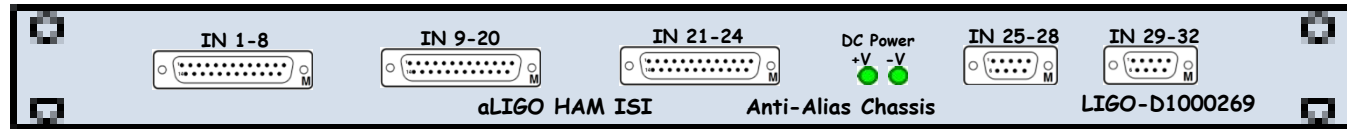

[D1000269](#)

Front

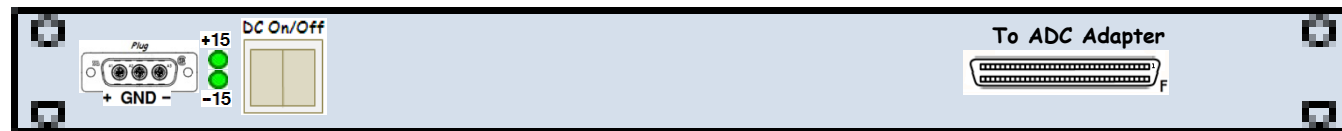
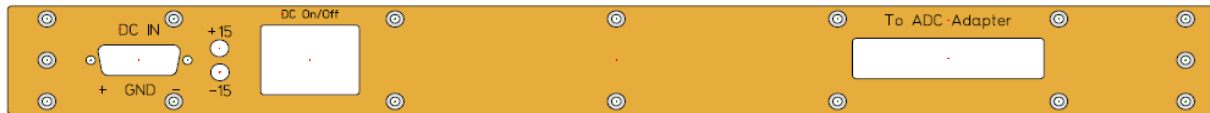
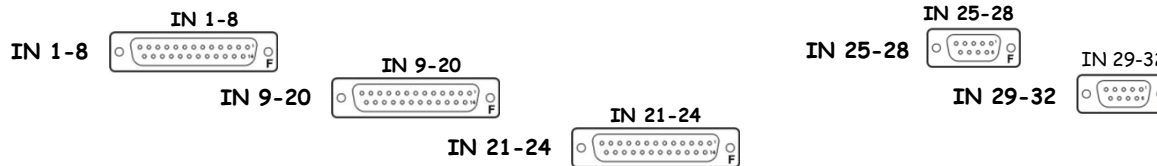

[S1104632](#)

Rear



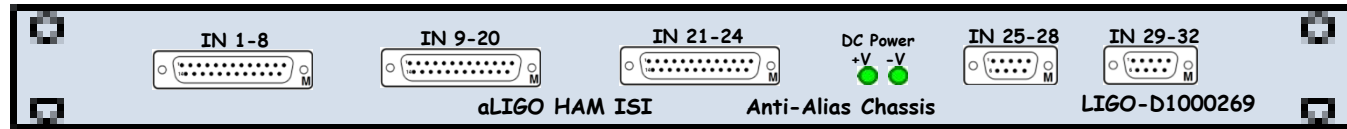

[D1000269](#)

Front

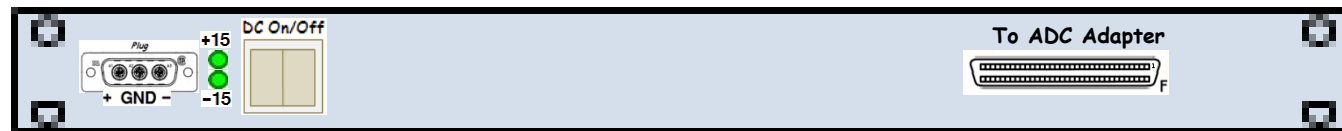
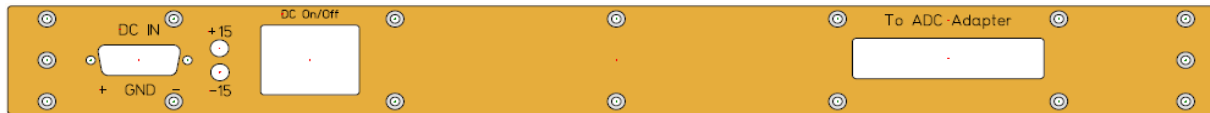
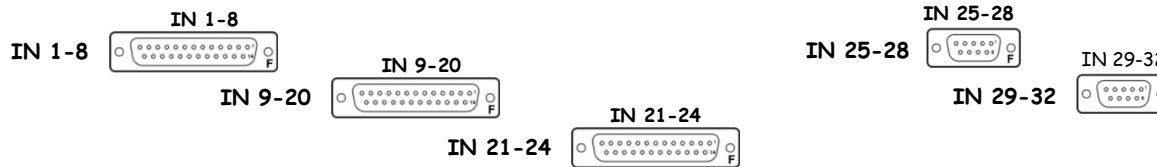

[S1104635](#)

Rear



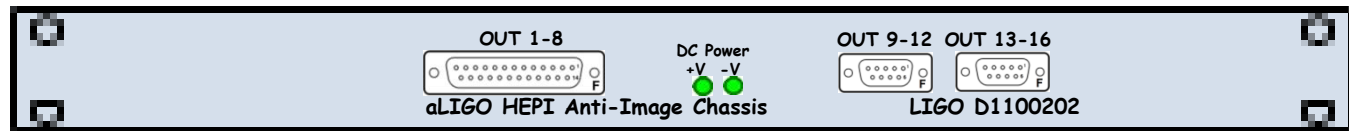

[D1100202](#)

Front

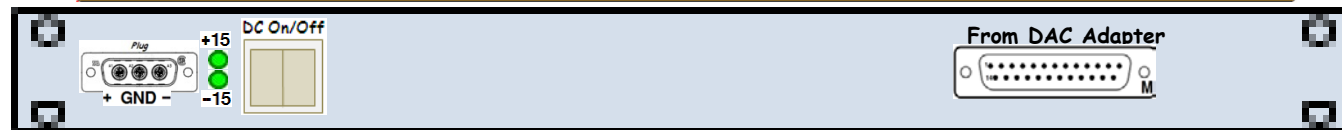
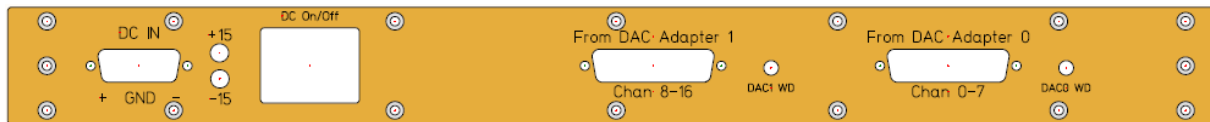

[S1104573](#)

Rear



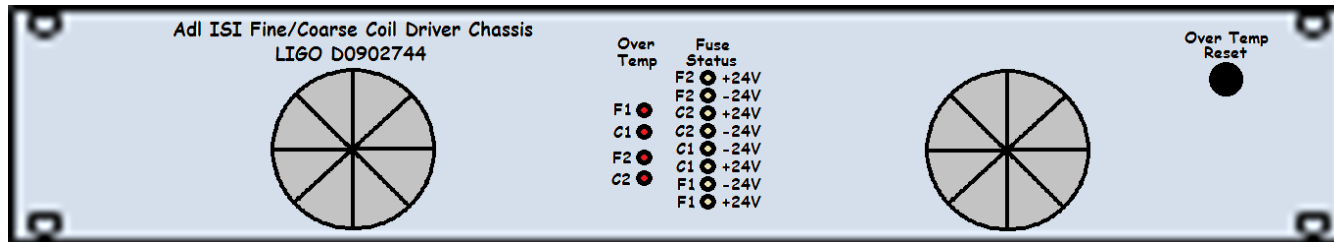

D0902744

Front

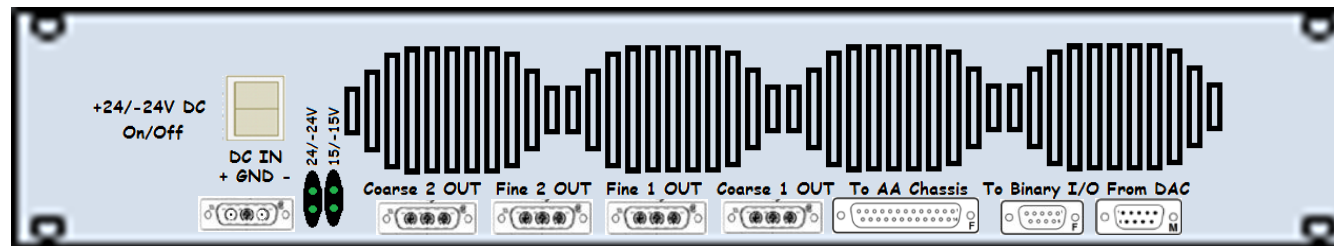

S1103306

Rear

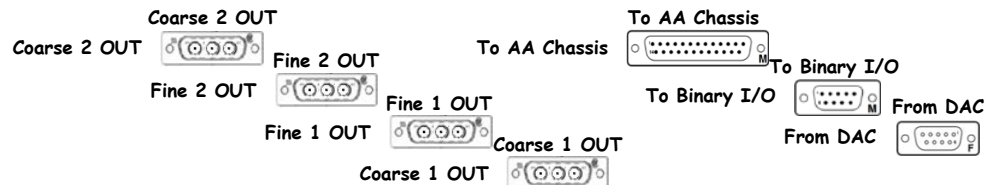

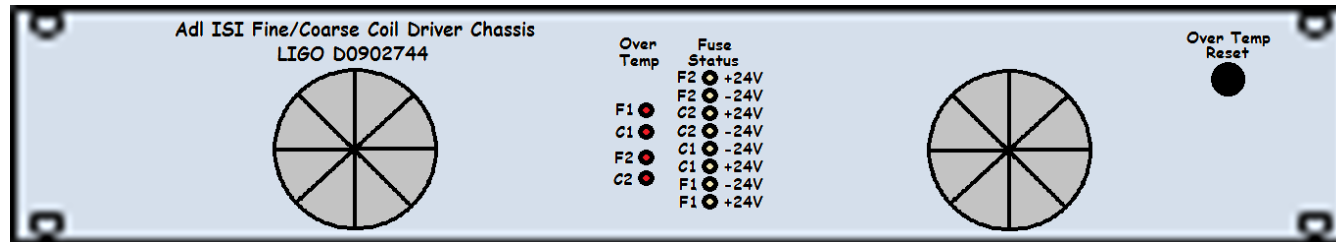

D0902744

Front

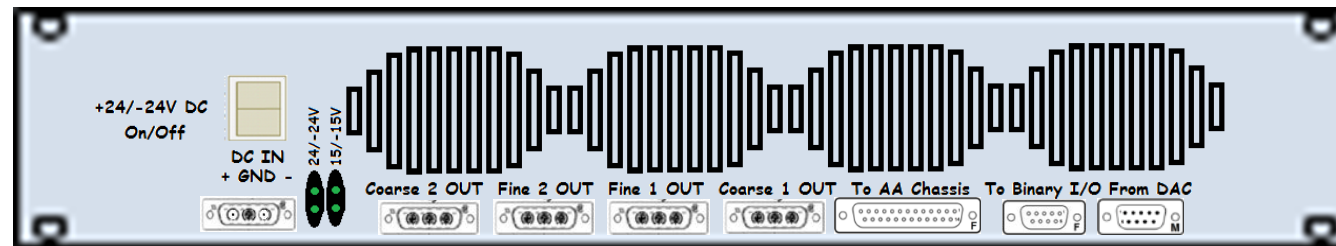

S1103304

Rear

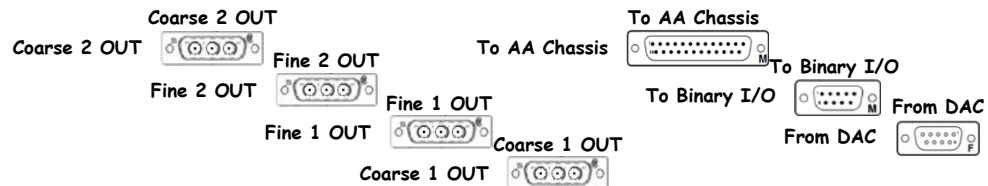

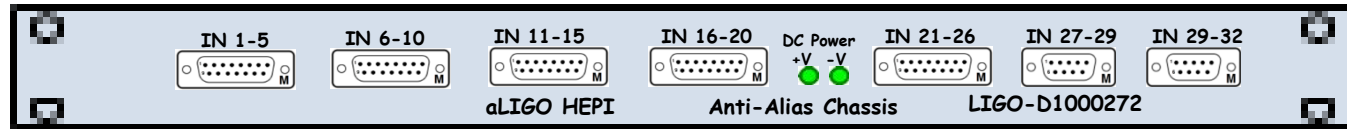
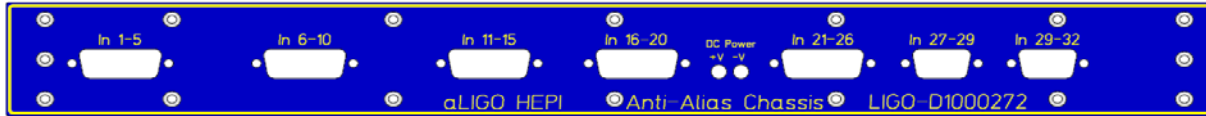

D1000269

Front

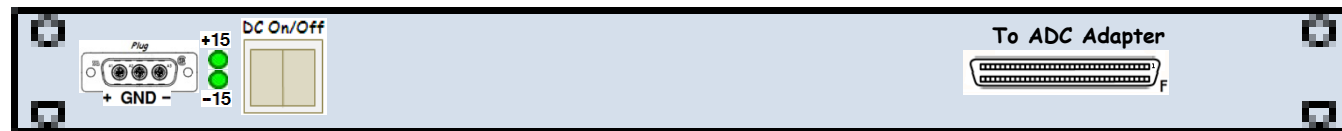
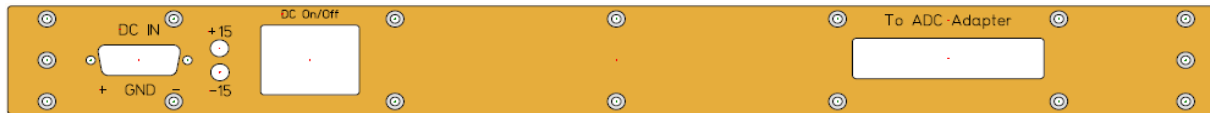
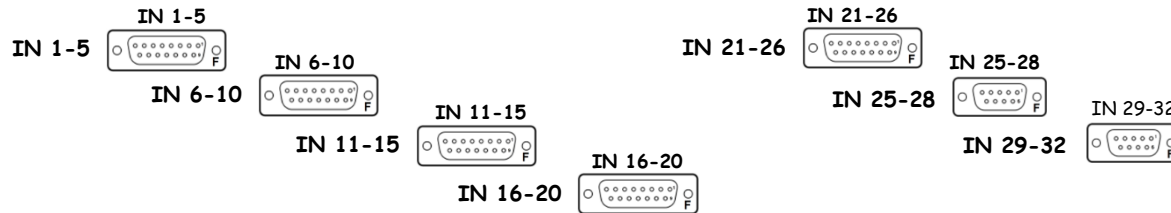

S1104616

Rear



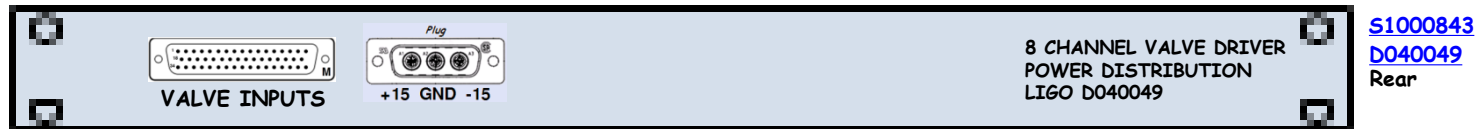
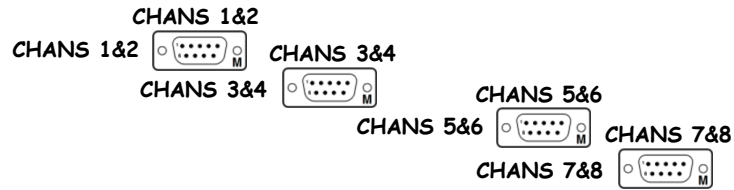
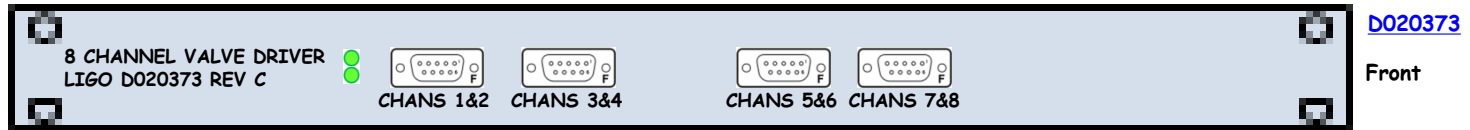

Binary Input Chassis D1001726 S1101286 ±18@0.5A

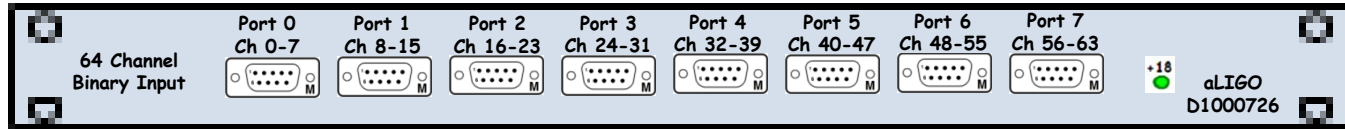
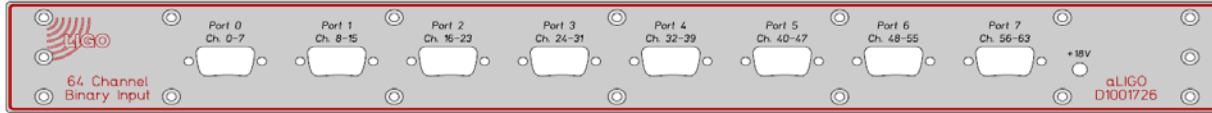

[D1001726](#)

Front

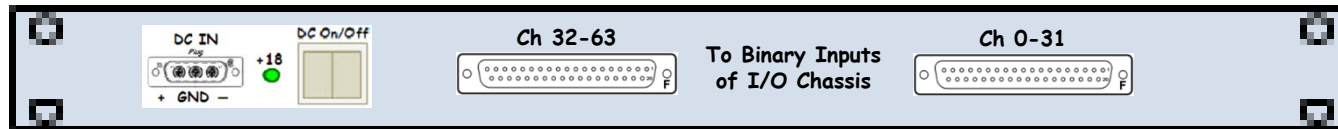
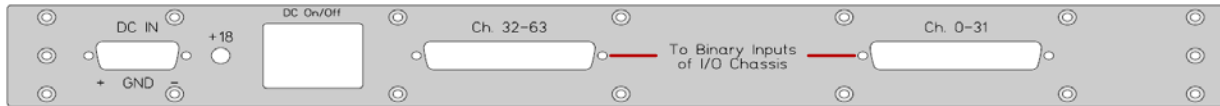
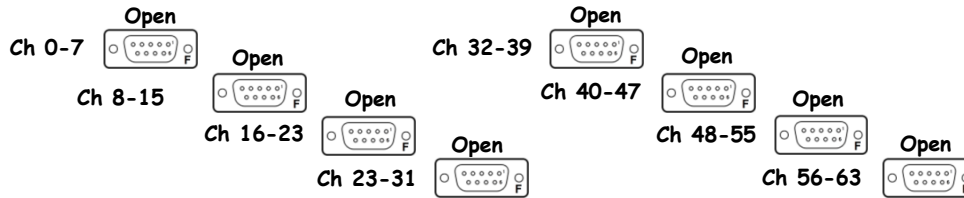

[S1101286](#)

Rear



Binary Output Chassis D1001728 S1101321 ±18@0.5A

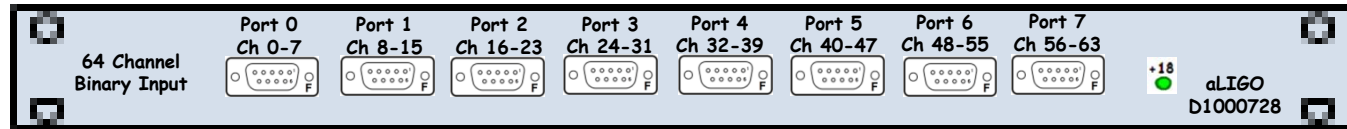
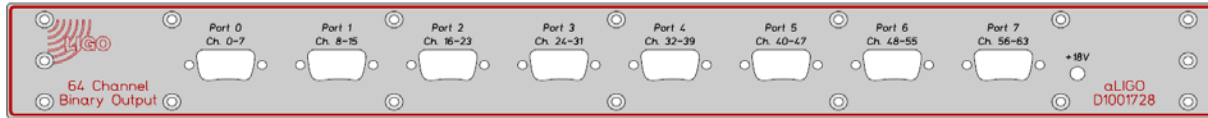

[D1001728](#)

Front

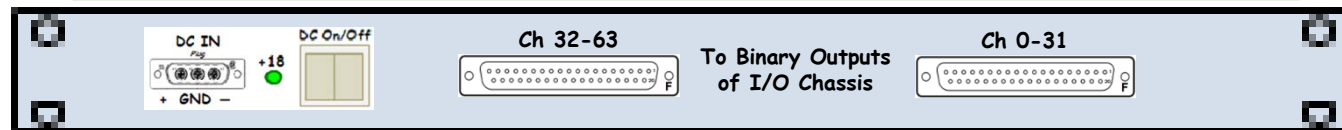
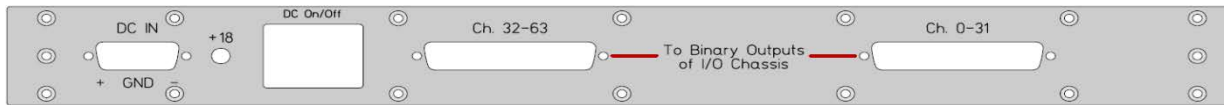
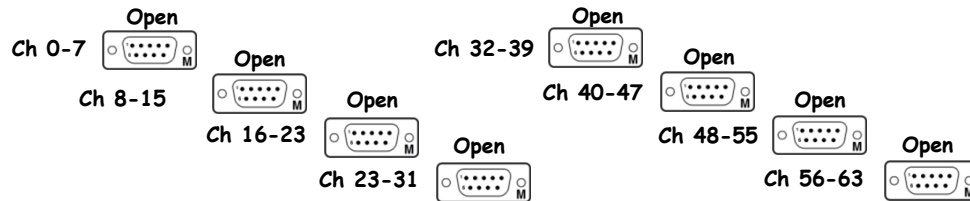

[S1101321](#)

Rear



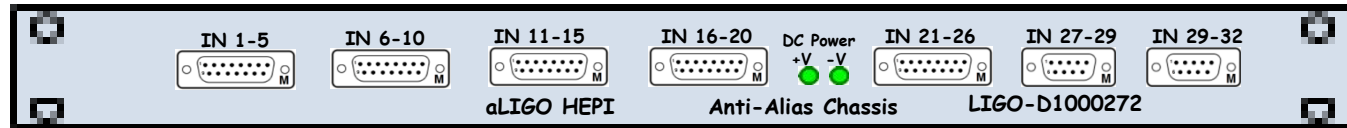
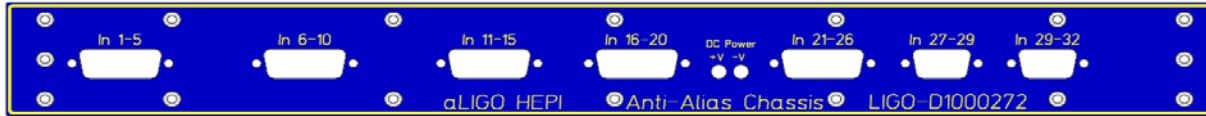

D1000269

Front

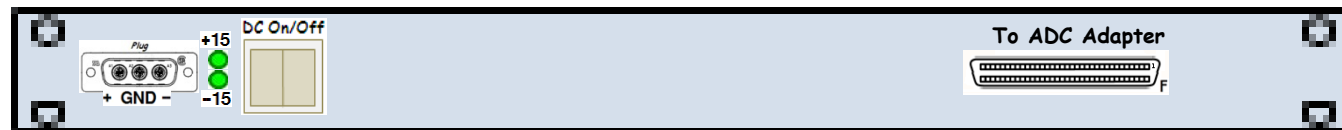
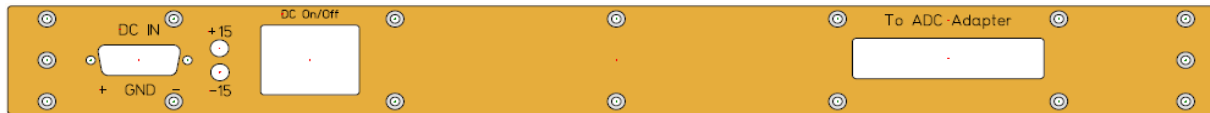
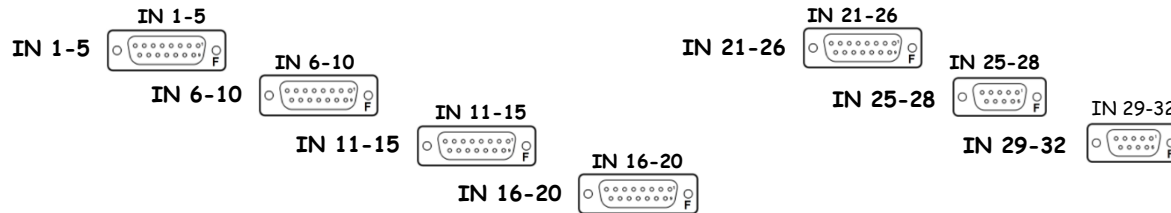

S1101321

Rear



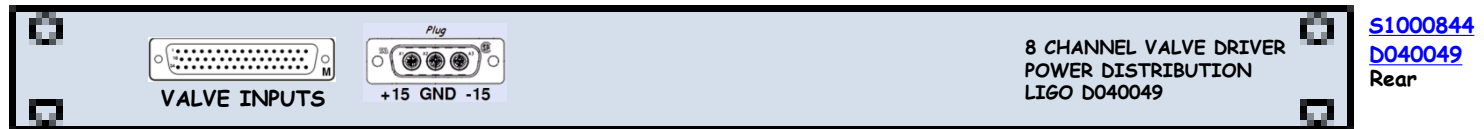
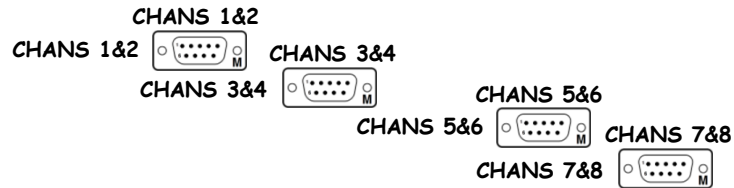
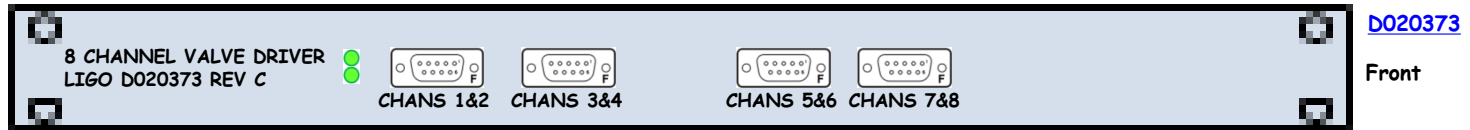

D1001715 - S1001145

I1seiham2-3 - I/O Extension Chassis

D1001715

S1001145

24 VDC



D1001715

Front

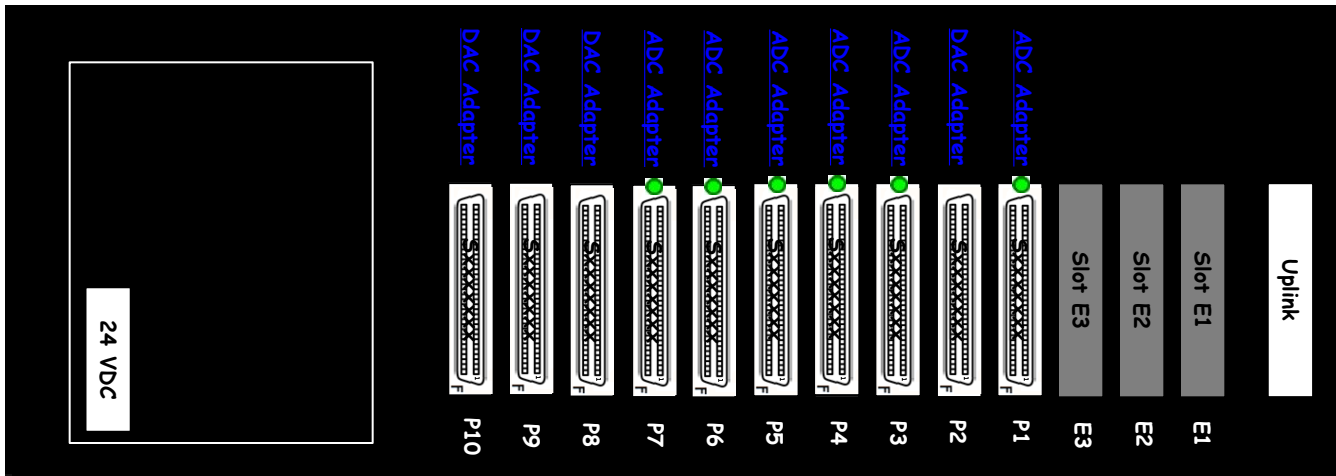

S1001145

Rear

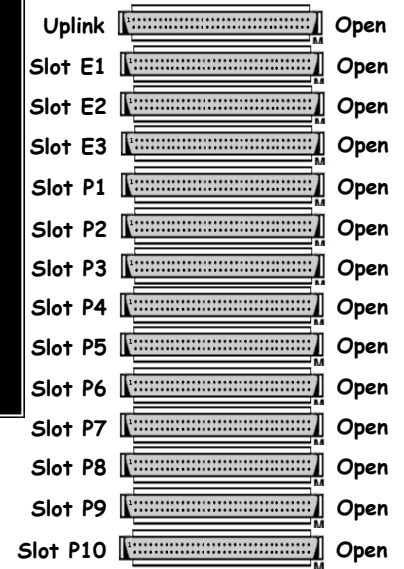

HAMs 4&5 L1-SEI-C3

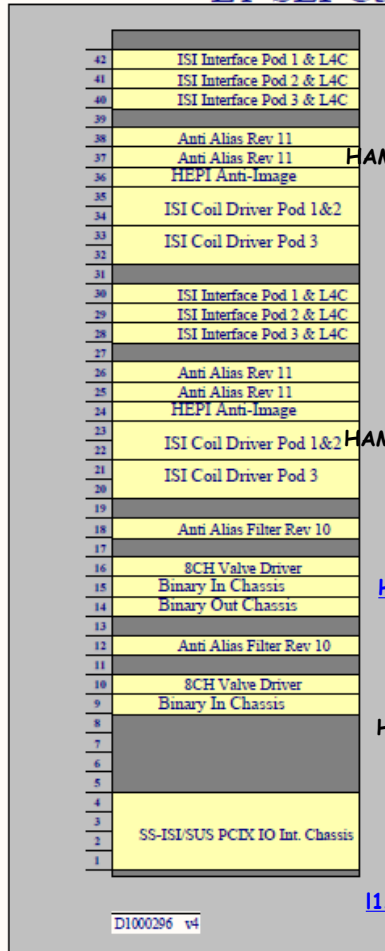

HAM4 ISI Interface Chassis
 HAM4 ISI Interface Chassis
 HAM4 ISI Interface Chassis

HAM4 ISI Anti-Alias Chassis
 HAM4 ISI Anti-Alias Chassis
 HAM4 HEPI Anti-Image Chassis

HAM4 ISI Coil Driver Pod 1 and Pod 2

HAM4 ISI Coil Driver Pod 3

HAM5 ISI Interface Chassis
 HAM5 ISI Interface Chassis
 HAM5 ISI Interface Chassis

ISI 5 Anti-Alias Chassis
 Anti-Alias Chassis
 Anti-Image Chassis

HAM5 ISI Coil Driver Pod 1 and Pod 2

HAM5 ISI Coil Driver Pod 3

HEPI 4 Anti-Alias Chassis
 HAM4 HEPI 8-Channel Valve Driver
 Binary Input Chassis
 Binary Output Chassis

HEPI 5 Anti-Alias Chassis

HAM5 HEPI 8-Channel Valve Driver
 Binary Input Chassis

l1seiham4-5 - I/O Extension Chassis

D1000296 v4

SEI-C3 is part of D1000298

Dnumber	Serial
42	Serial
41	Serial
40	Serial
39	Serial
38	S1104621
37	S1104638
36	S1104572
35	SN:
34	SN:
33	SN:
32	SN:
31	Serial
30	Serial
29	Serial
28	Serial
27	Serial
26	Serial
25	Serial
24	Serial
23	SN:
22	SN:
21	SN:
20	SN:
19	Serial
18	Serial
17	S1000845
16	SN:
15	SN:
14	SN:
13	Serial
12	Serial
11	SN:
10	SN:
9	SN:
8	SN:
7	SN:
6	SN:
5	SN:
4	SN:
3	SN:
2	SN:
1	SN:

+18V@0.32A, -18V@0.33A
 +18V@0.32A, -18V@0.33A
 +18V@0.32A, -18V@0.33A

±18@1A
 ±18@1A
 ±18@0.5A

+24V@1.2A, -24V@0.8A
 +24V@1.2A, -24V@0.8A

+18V@0.32A, -18V@0.33A
 +18V@0.32A, -18V@0.33A
 +18V@0.32A, -18V@0.33A

±18@1A
 ±18@1A
 ±18@0.5A

+24V@1.2A, -24V@0.8A (+10A)
 +24V@1.2A, -24V@0.8A (+10A)

±18@1A
 +18V@0.72A, -18V@0.72A
 ±18@0.5A
 ±18@0.5A

±18@1A
 +18V@0.72A, -18V@0.72A
 ±18@0.5A

+24@5A

+18VDC	12A
-18VDC	12A
+24VDC	?A
-24VDC	?A

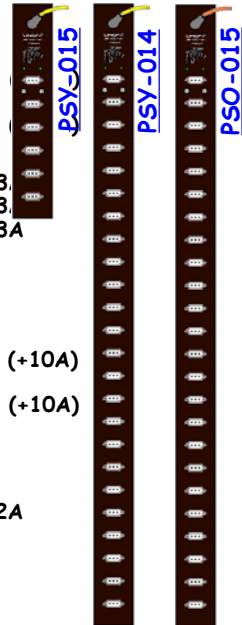

D1001715

S1001146

Front

Rear

L1-SEI-C3 Details

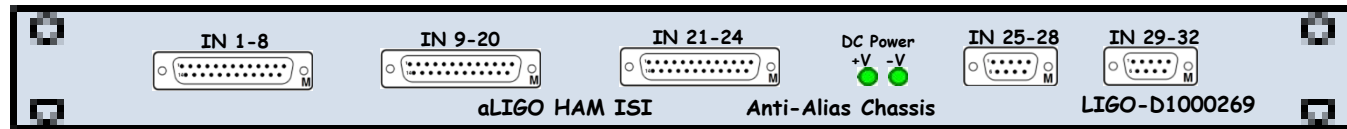

[D1000269](#)

Front

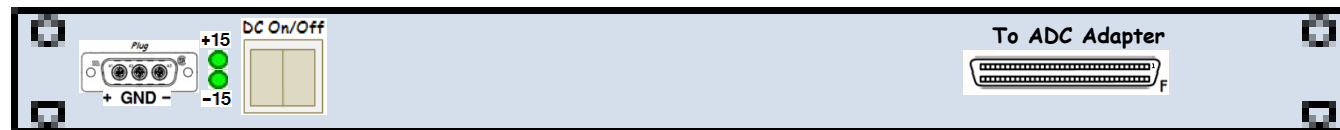
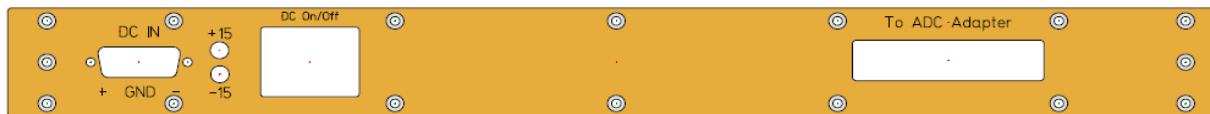
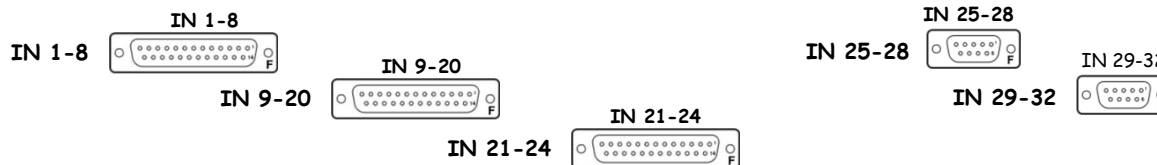

[S1104621](#)

Rear



HAM4 ISI Anti-Alias Chassis D1000269 S1104638 ±18@1A

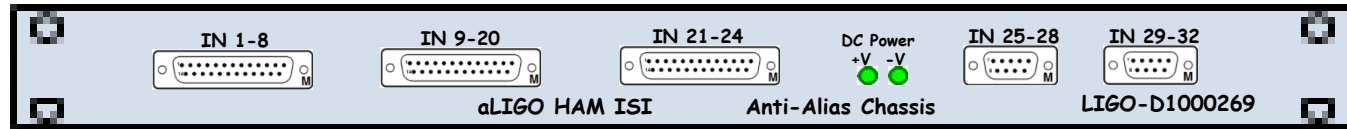

[D1000269](#)

Front

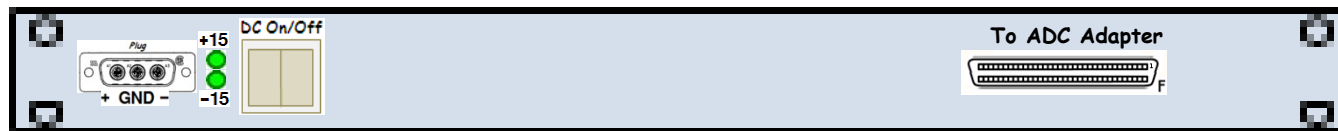
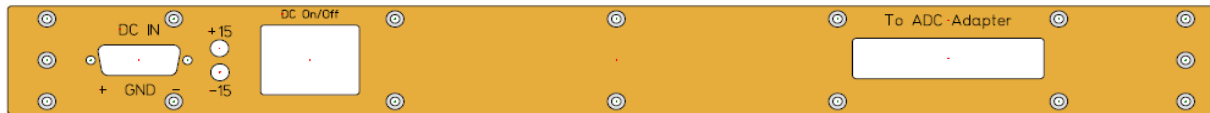
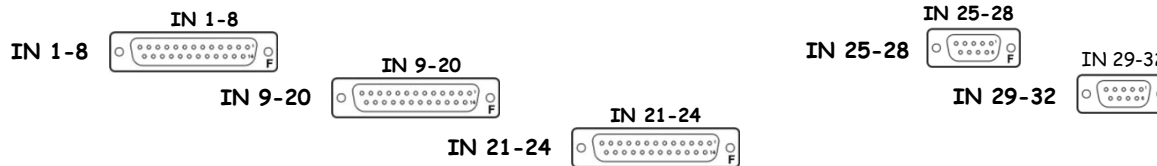

[S1104638](#)

Rear



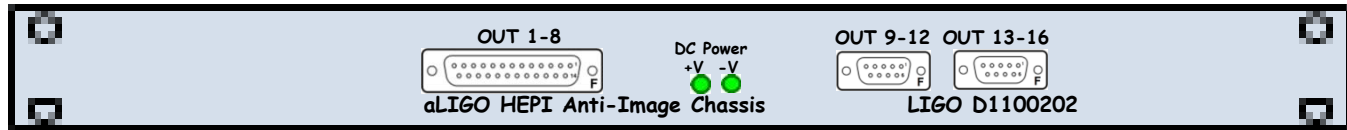

[D1100202](#)

Front

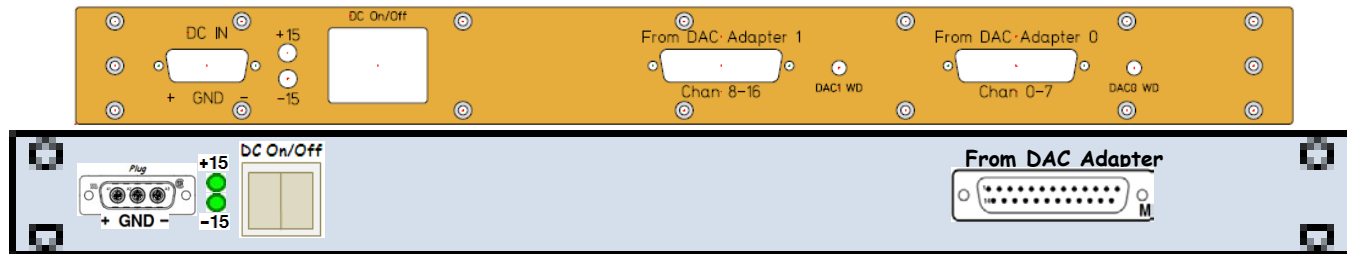

[S1104572](#)

Rear



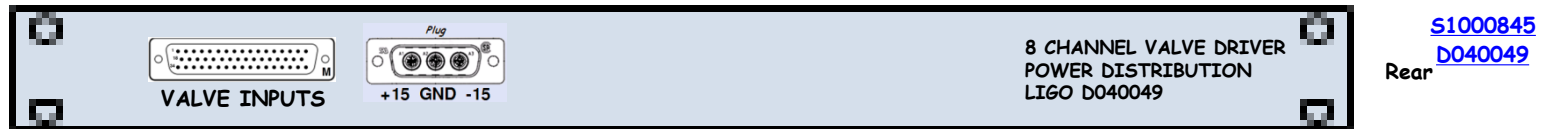
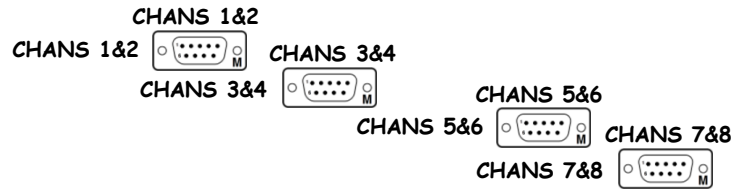
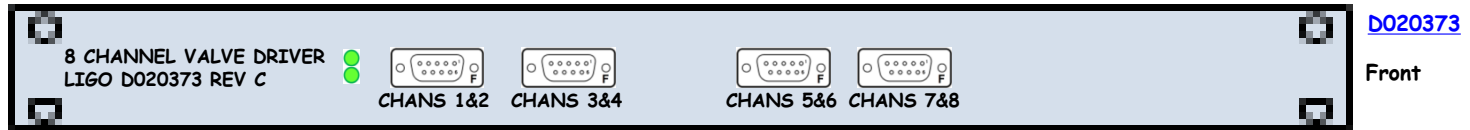

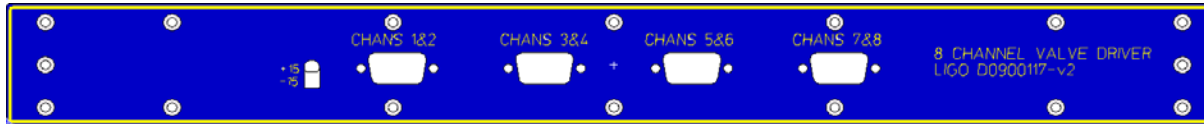

[D0901338](#)

Front

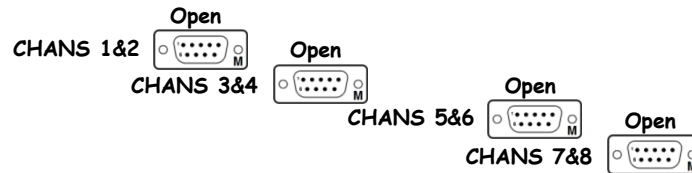

SN:

Rear





S1001146
Front

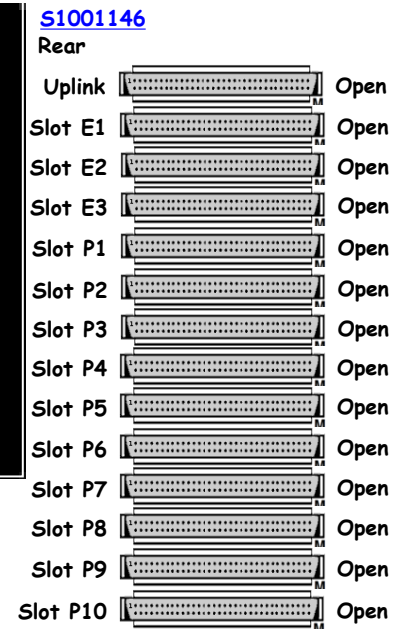
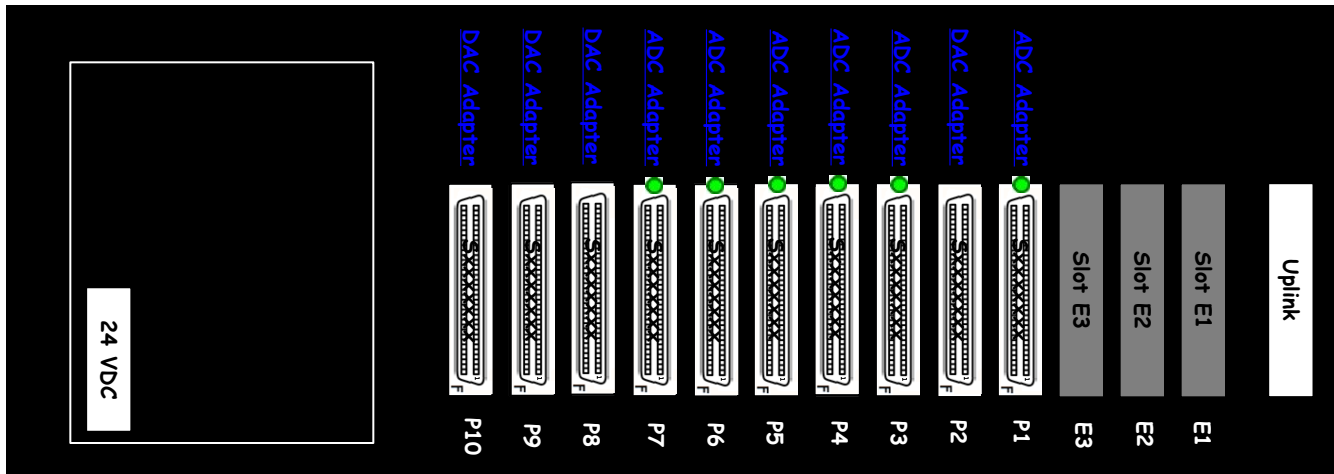

BSC 1,2,3,4&5

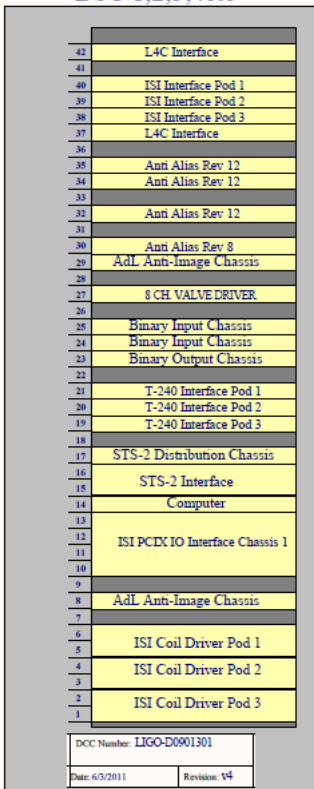

BSC1 L4C Interface Chassis

BSC1 ISI Interface Chassis Pod 1
 BSC1 ISI Interface Chassis Pod 2
 BSC1 ISI Interface Chassis Pod 3
 BSC1 L4C Interface Chassis

BSC1 BSC Anti-Alias Chassis
 Anti-Alias Chassis

Anti-Alias Chassis

Anti-Alias Chassis
 Anti-Image Chassis

HEPI Components
 BSC1 HEPI 8-Channel Valve Driver

Binary Input Chassis
 Binary Input Chassis

Binary Output Chassis

STS-2 Input / Distribution
 BSC1 T-240 Interface Chassis Pod 1
 BSC1 T-240 Interface Chassis Pod 2

BSC1 T-240 Interface Chassis Pod 3

1lseibsc1 - I/O Extension Chassis

Anti-Image Chassis

BSC1 ISI Coil Driver Pod 1

BSC1 ISI Coil Driver Pod 2

BSC1 ISI Coil Driver Pod 3

SEI-C4 is part of [D0901301](#)

	42		
Dnumber	41	Serial	
	40		
Dnumber	39	Serial	
Dnumber	38	Serial	
Dnumber	37	Serial	
Dnumber	36	Serial	
	35		
D1002693	34	Serial	
Dnumber	33	Serial	
	32		
Dnumber	31	Serial	
	30		
Dnumber	29	Serial	
Dnumber	28	Serial	
	27		
D020373	26	SN:	
	25		
Dxxxxxxx	24	SN:	
Dxxxxxxx	23	SN:	
	22		
Dxxxxxxx	21	SN:	
	20		
Dnumber	19	Serial	
	18		
Dnumber	17	Serial	
	16		
Dnumber	15	Serial	
	14		
	13		
D1001715	12	S1001147	
	11		
	10		
Dnumber	9	Serial	
	8		
	7		
D0902744	6	SN:	
	5		
D0902744	4	SN:	
	3		
D0902744	2	SN:	
	1		
Front		Rear	

+18V@0.32A, -18V@0.33A

+18V@0.32A, -18V@0.33A
 +18V@0.32A, -18V@0.33A
 +18V@0.32A, -18V@0.33A
 +18V@0.32A, -18V@0.33A

±18@1A
 ±18@1A

±18@1A

±18@1A
 ±18@0.5A

+18V@0.72A, -18V@0.72A

±18@0.5A
 ±18@0.5A

±18@0.5A

+18V@0.32A, -18V@0.33A

+18V@0.32A, -18V@0.33A

+18V@0.32A, -18V@0.33A

+24@5A

±18@0.5A

+24V@1.2A, -24V@0.8A (+10A)

+24V@1.2A, -24V@0.8A (+10A)

+24V@1.2A, -24V@0.8A (+10A)

+18VDC	10A
-18VDC	10A
+24VDC	?A
-24VDC	?A

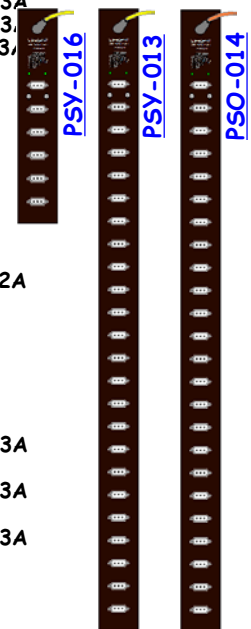

L1-SEI-C4 Details

<< L1-SEI-C4

BSC1 BSC Anti-Alias Chassis D1002693 Sxxxxxxx ±18@1A

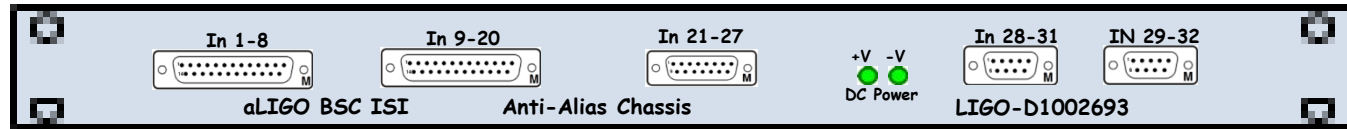

D1002693

Front

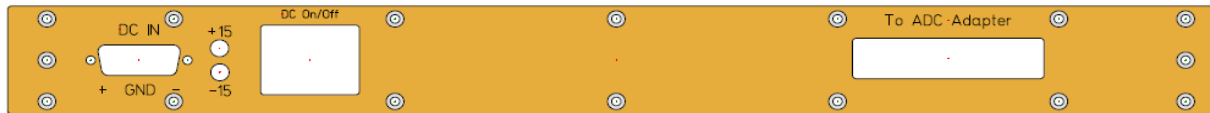
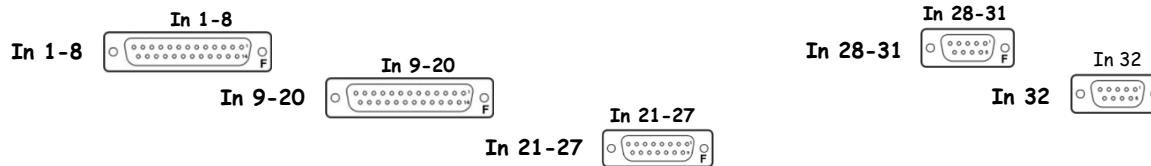

Sxxxxxxx

Rear



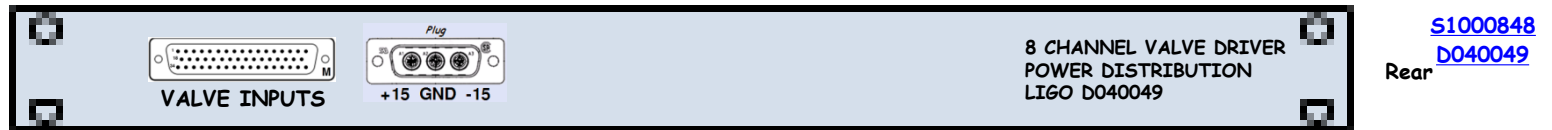
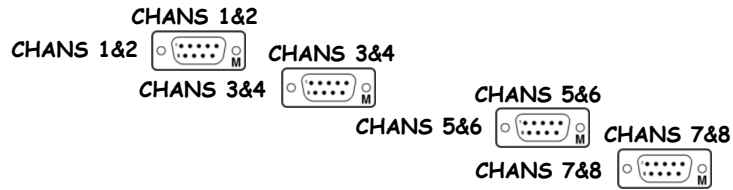
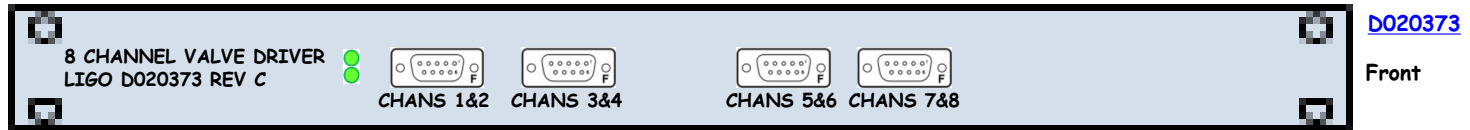



D1001715

Front

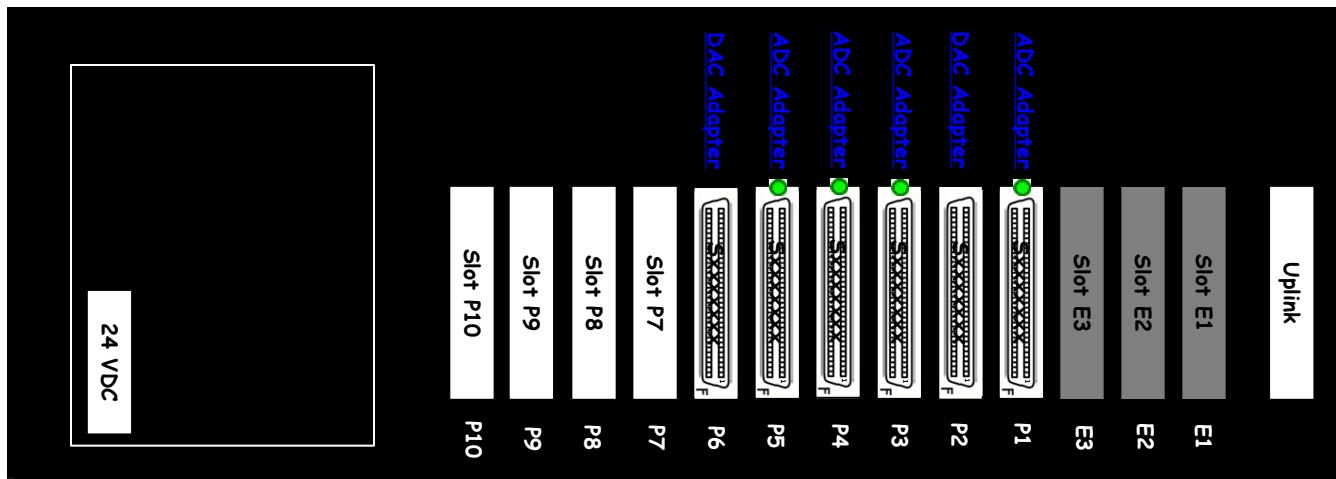

S1001147

Rear

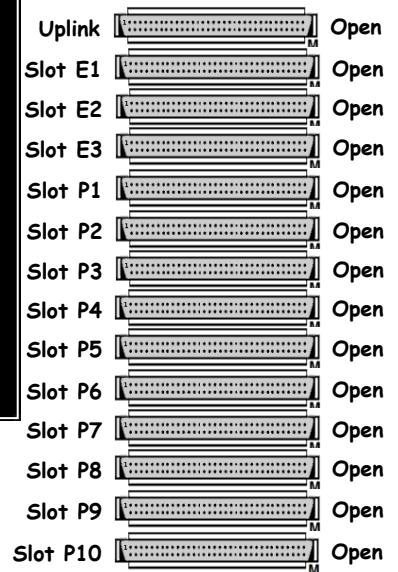

L1-SEI-C5 Details

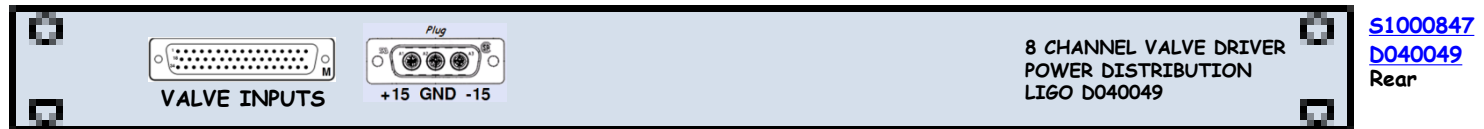
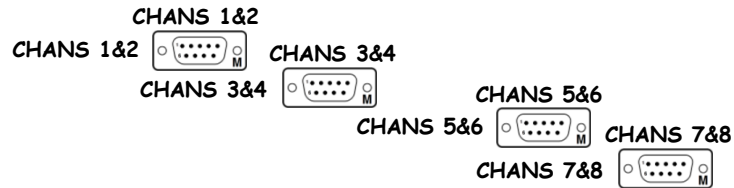
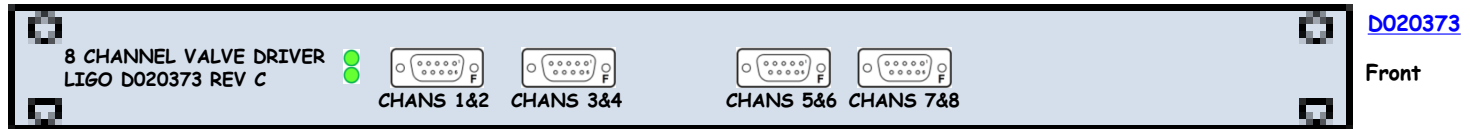



D1001715
Front

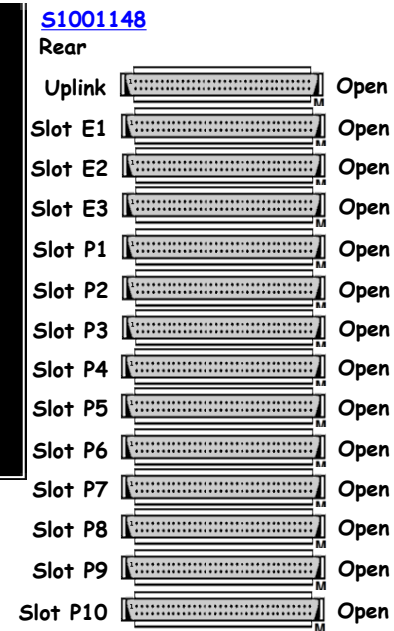
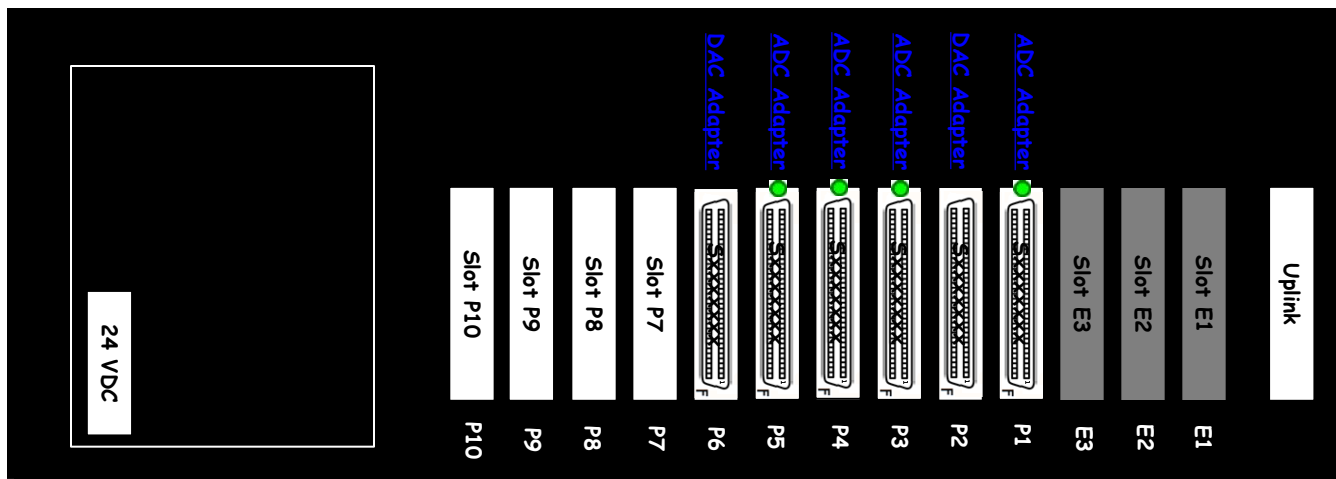

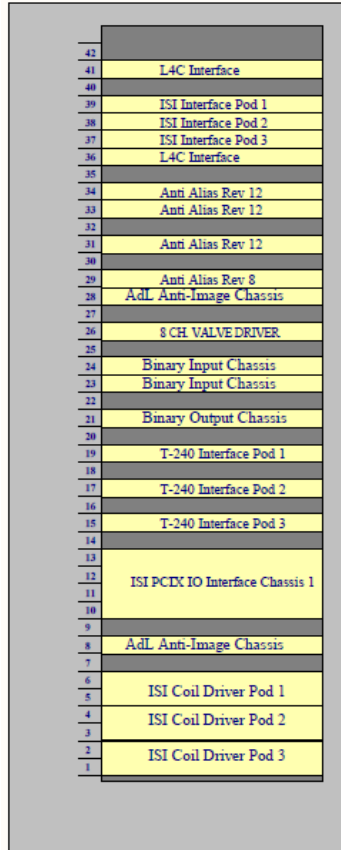

BSC 1,2,3,4&5

BSC2 L4C Interface Chassis

BSC2 ISI Interface Chassis Pod 1
 BSC2 ISI Interface Chassis Pod 2
 BSC2 ISI Interface Chassis Pod 3
 BSC2 L4C Interface Chassis

Anti-Alias Chassis
 Anti-Alias Chassis

Anti-Alias Chassis

Anti-Alias Chassis
 Anti-Image Chassis

BSC2 HEPI 8-Channel Valve Driver
 HEPI Components

Binary Input Chassis
 Binary Input Chassis

Binary Output Chassis

BSC2 T-240 Interface Chassis Pod 1

BSC2 T-240 Interface Chassis Pod 2

BSC2 T-240 Interface Chassis Pod 3

[I1seibsc2 - I/O Extension Chassis](#)

Anti-Image Chassis

BSC2 ISI Coil Driver Pod 1

BSC2 ISI Coil Driver Pod 2

BSC2 ISI Coil Driver Pod 3

SEI-C5 is part of [D0901301](#)

	42		
Dnumber	41	Serial	
Dnumber	40	Serial	
Dnumber	39	Serial	
Dnumber	38	Serial	
Dnumber	37	Serial	
Dnumber	36	Serial	
Dnumber	35	Serial	
Dnumber	34	Serial	
Dnumber	33	Serial	
Dnumber	32	Serial	
Dnumber	31	Serial	
Dnumber	30	Serial	
Dnumber	29	Serial	
Dnumber	28	Serial	
D020373	27	SN:	
Dxxxxxxx	26	SN:	
Dxxxxxxx	25	SN:	
Dxxxxxxx	24	SN:	
Dxxxxxxx	23	SN:	
Dxxxxxxx	22	SN:	
Dxxxxxxx	21	SN:	
Dnumber	20	Serial	
Dnumber	19	Serial	
Dnumber	18	Serial	
Dnumber	17	Serial	
Dnumber	16	Serial	
Dnumber	15	Serial	
D1001715	14	S1001148	
D1001715	13	S1001148	
D1001715	12	S1001148	
D1001715	11	S1001148	
D1001715	10	S1001148	
D1001715	9	S1001148	
Dnumber	8	Serial	
Dnumber	7	Serial	
D0902744	6	SN:	
D0902744	5	SN:	
D0902744	4	SN:	
D0902744	3	SN:	
D0902744	2	SN:	
D0902744	1	SN:	
Front		Rear	

+18V@0.32A, -18V@0.33A

+18V@0.32A, -18V@0.33A

+18V@0.32A, -18V@0.33A

+18V@0.32A, -18V@0.33A

+18V@0.32A, -18V@0.33A

±18@1A

±18@1A

±18@1A

±18@1A

±18@0.5A

+18V@0.72A, -18V@0.72A

±18@0.5A

±18@0.5A

±18@0.5A

+18V@0.32A, -18V@0.33A

+18V@0.32A, -18V@0.33A

+18V@0.32A, -18V@0.33A

+24@5A

±18@0.5A

+24V@1.2A, -24V@0.8A (+10A)

+24V@1.2A, -24V@0.8A (+10A)

+24V@1.2A, -24V@0.8A (+10A)

+18VDC	10A
-18VDC	10A
+24VDC	?A
-24VDC	?A

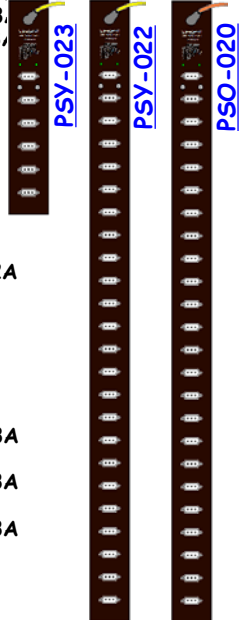

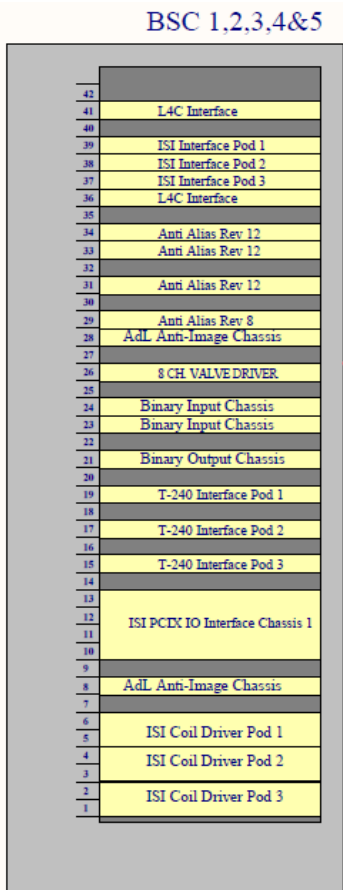

BSC 1,2,3,4&5

BSC3 L4C Interface Chassis

BSC3 ISI Interface Chassis Pod 1
 BSC3 ISI Interface Chassis Pod 2
 BSC3 ISI Interface Chassis Pod 3
 BSC3 L4C Interface Chassis

Anti-Alias Chassis
 Anti-Alias Chassis

Anti-Alias Chassis

Anti-Alias Chassis
 Anti-Image Chassis

BSC3 HEPI 8-Channel Valve Driver
 HEPI Components

Binary Input Chassis
 Binary Input Chassis

Binary Output Chassis

BSC3 T-240 Interface Chassis Pod 1

BSC3 T-240 Interface Chassis Pod 2

BSC3 T-240 Interface Chassis Pod 3

ISI PCIx IO Interface Chassis 1

AdL Anti-Image Chassis

Anti-Image Chassis

BSC3 ISI Coil Driver Pod 1

BSC3 ISI Coil Driver Pod 2

BSC3 ISI Coil Driver Pod 3

SEI-C6 is part of [D0901301](#)

	42		
Dnumber	41	Serial	
Dnumber	40	Serial	
Dnumber	39	Serial	
Dnumber	38	Serial	
Dnumber	37	Serial	
Dnumber	36	Serial	
Dnumber	35	Serial	
Dnumber	34	Serial	
Dnumber	33	Serial	
Dnumber	32	Serial	
Dnumber	31	Serial	
Dnumber	30	Serial	
Dnumber	29	Serial	
Dnumber	28	Serial	
Dnumber	27	SN:	
Dnumber	26	SN:	
Dnumber	25	SN:	
Dnumber	24	SN:	
Dnumber	23	SN:	
Dnumber	22	SN:	
Dnumber	21	SN:	
Dnumber	20	Serial	
Dnumber	19	Serial	
Dnumber	18	Serial	
Dnumber	17	Serial	
Dnumber	16	Serial	
Dnumber	15	Serial	
Dnumber	14	Serial	
Dnumber	13	Serial	
Dnumber	12	Serial	
Dnumber	11	Serial	
Dnumber	10	Serial	
Dnumber	9	Serial	
Dnumber	8	Serial	
Dnumber	7	Serial	
Dnumber	6	SN:	
Dnumber	5	SN:	
Dnumber	4	SN:	
Dnumber	3	SN:	
Dnumber	2	SN:	
Dnumber	1	SN:	
Front		Rear	

+18V@0.32A, -18V@0.33A

+18V@0.32A, -18V@0.33A
 +18V@0.32A, -18V@0.33A
 +18V@0.32A, -18V@0.33A
 +18V@0.32A, -18V@0.33A

±18@1A
 ±18@1A

±18@1A

±18@1A
 ±18@0.5A

+18V@0.72A, -18V@0.72A

±18@0.5A
 ±18@0.5A

±18@0.5A

+18V@0.32A, -18V@0.33A

+18V@0.32A, -18V@0.33A

+18V@0.32A, -18V@0.33A

+24@5A

±18@0.5A

+24V@1.2A, -24V@0.8A (+10A)

+24V@1.2A, -24V@0.8A (+10A)

+24V@1.2A, -24V@0.8A (+10A)

+18VDC	10A
-18VDC	10A
+24VDC	?A
-24VDC	?A

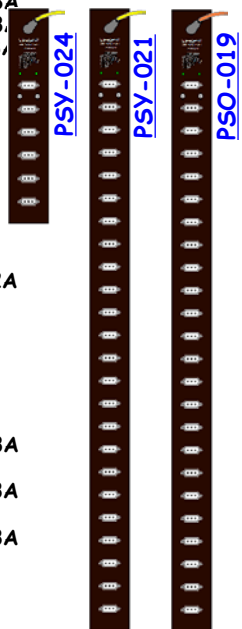

L1-SEI-C6 Details

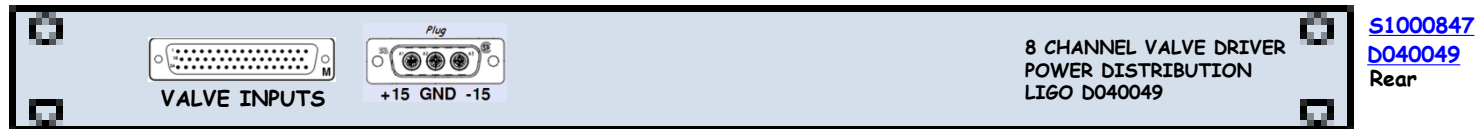
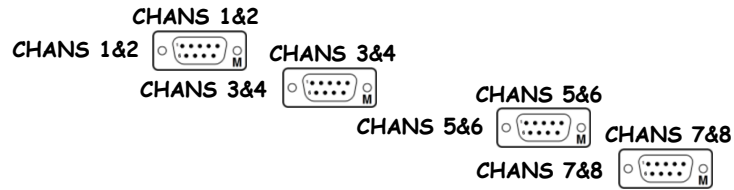
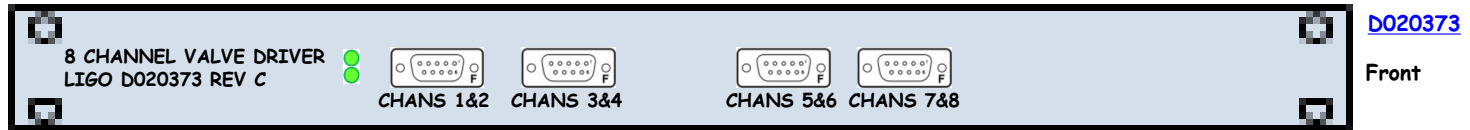



D1001715

Front

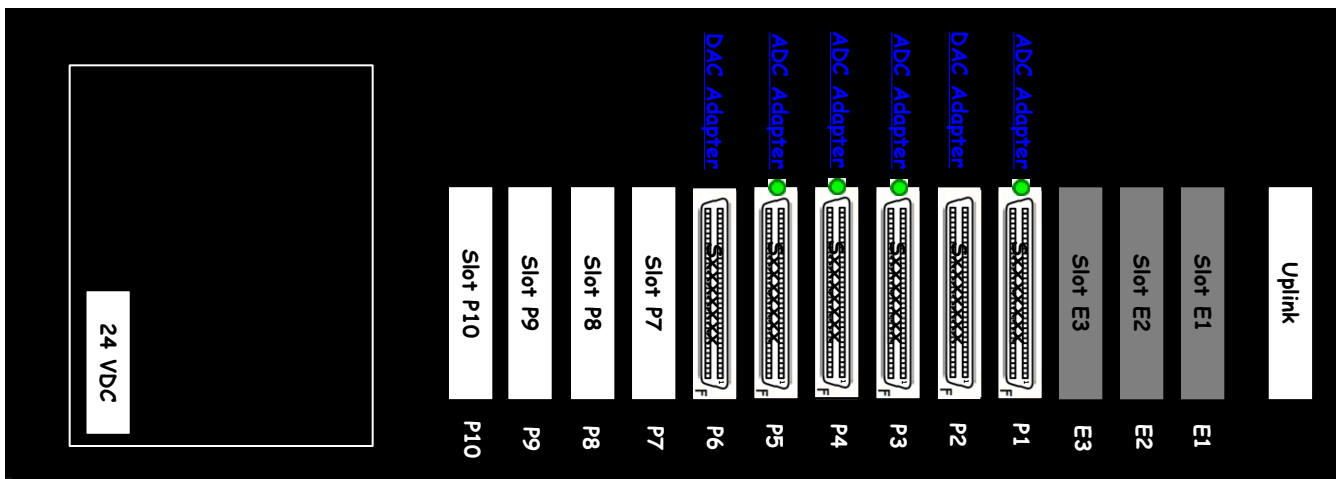

S1100946

Rear

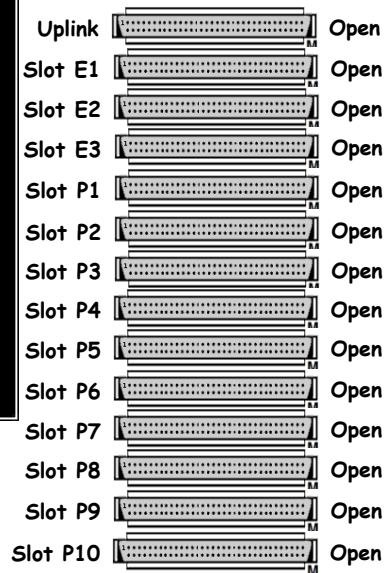

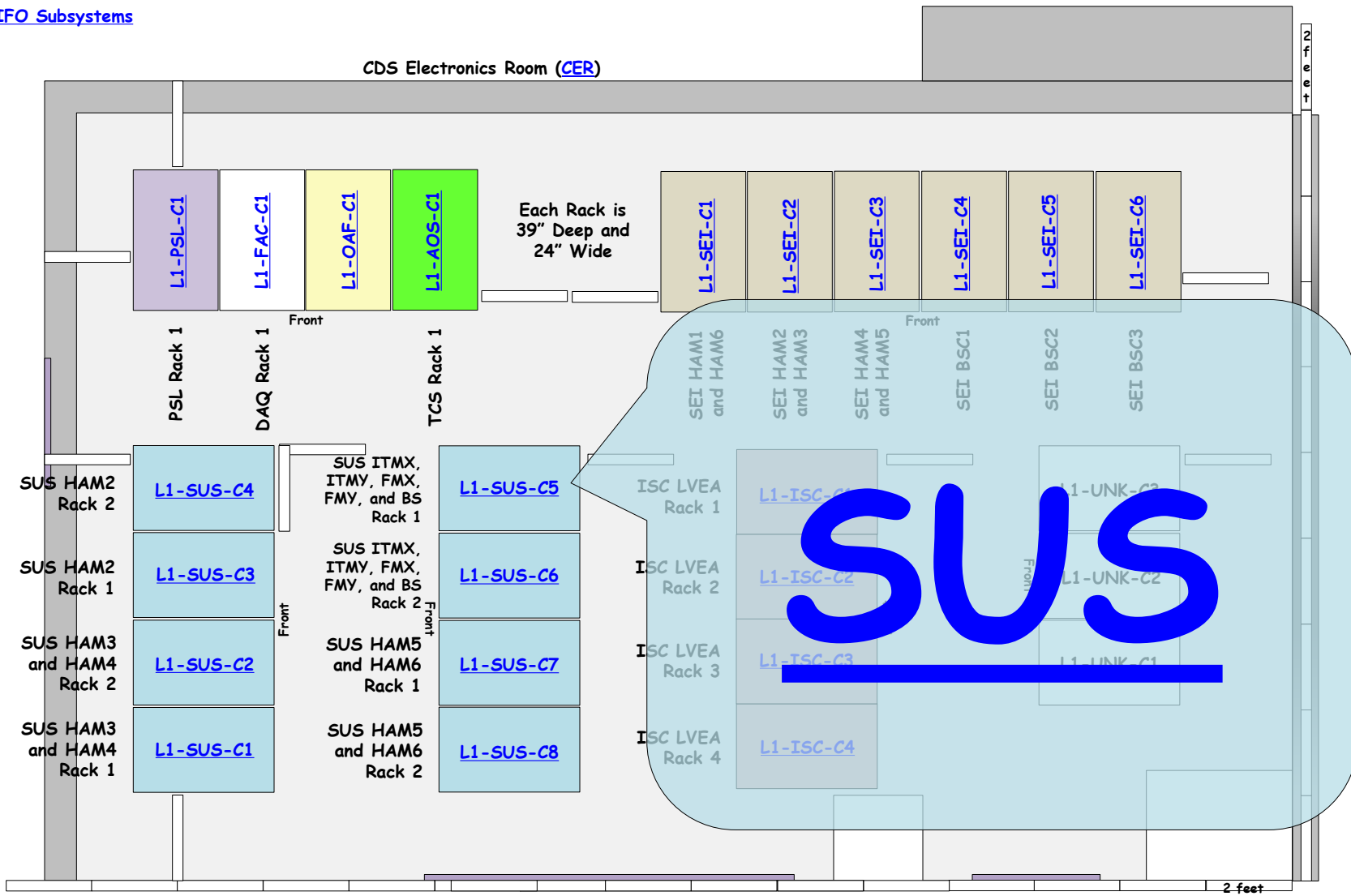

[MC2-PR2 Triple Top Coil Driver Chassis](#)
[MC2-PR2 Triple Top Coil Driver Chassis](#)
[MC2-PR2 Triple Top Coil Driver Chassis](#)

[SR2 Triple Top Coil Driver Chassis](#)
[SR2 Triple Top Coil Driver Chassis](#)

[FE ADC0 Anti-Alias Chassis](#)
[FE ADC1 Anti-Alias Chassis](#)

[FE DAC0, FE DAC1 Anti-Image Chassis](#)
[FE DAC2, FE DAC3 Anti-Image Chassis](#)

[MC2 Mid Triple Acq Driver Chassis](#)
[MC2 Bot Triple Acq Driver Chassis](#)
[PR2 Mid Triple Acq Driver Chassis](#)

[FE DAC4, FE DAC5 Anti-Image Chassis](#)

[PR2 Bot Triple Acq Driver Chassis](#)
[SR2 Mid Triple Acq Driver Chassis](#)
[SR2 Bot Triple Acq Driver Chassis](#)

[BIO1 Binary Output Chassis](#)
[BIO1 Binary Input Chassis](#)
[BIO2 Binary Output Chassis](#)
[BIO2 Binary Input Chassis](#)

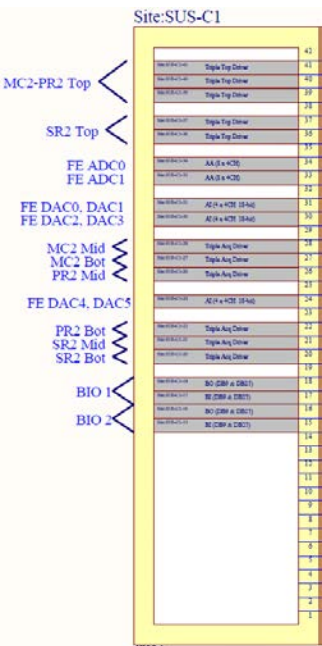

Front	Rear	Power
D1001242	S1000260	±18@1A
D1001242	S1000264	±18@1A
D1001242	S1000721	±18@1A
D1001242	S1000722	±18@1A
D1001242	S1000273	±18@1A
D0902783	S1001157	±18@1A
D0902783	S1100327	±18@1A
D1000305	S1001197	±18@0.5A
D1000305	S1001198	±18@0.5A
D0900006	S1000347	±18@1A
D0900006	S1000348	±18@1A
D0900006	S1000349	±18@1A
D1000305	S1101815	±18@0.5A
D0900006	S1001186	±18@1A
D0900006	S1001187	±18@1A
D0900006	S1001188	±18@1A
D1000725	S1101781	±18@0.5A
D1000726	S1101805	±18@0.5A
D1000725	S1101782	±18@0.5A
D1000726	S1101802	±18@0.5A



PSO-008

L1-SUS-C1 Details

D1001242 - S1000260



<< L1-SUS-C1

MC2-PR2 Triple Top Coil Driver Chassis D1001242 S1000260 ±18@0.5A

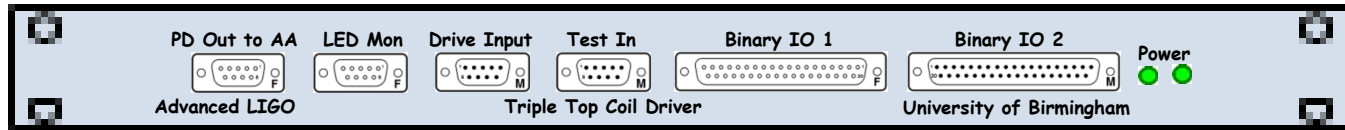

[D0902747](#)
[D070480](#)
Front

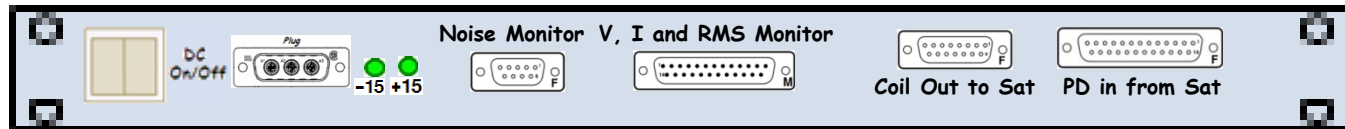
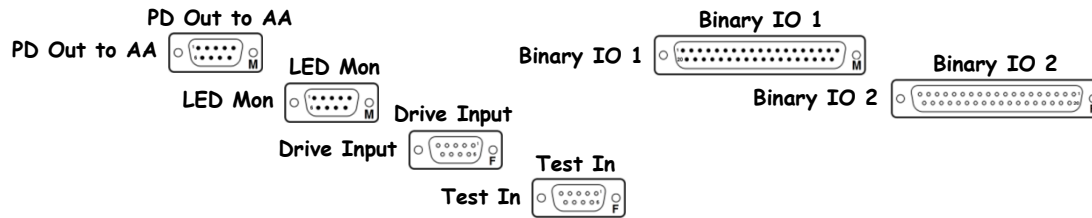

[S1000260](#)
Rear

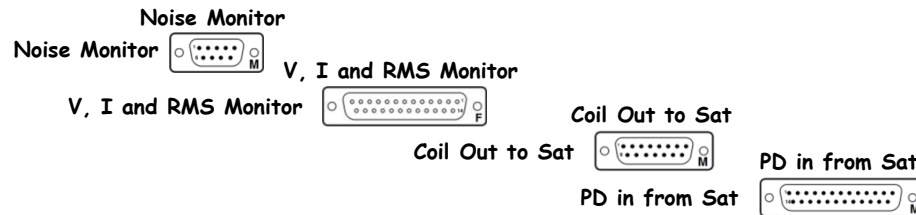

D1001242 - S1000264



<< L1-SUS-C1

MC2-PR2 Triple Top Coil Driver Chassis D1001242 S1000264 ±18@0.5A

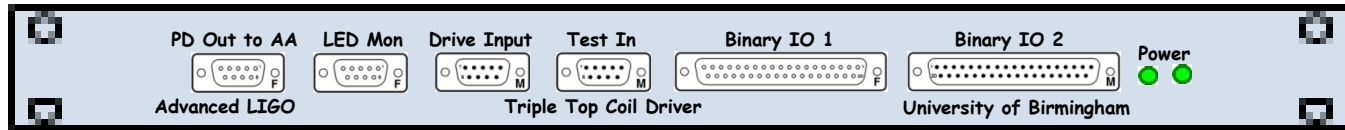

[D0902747](#)
[D070480](#)
Front

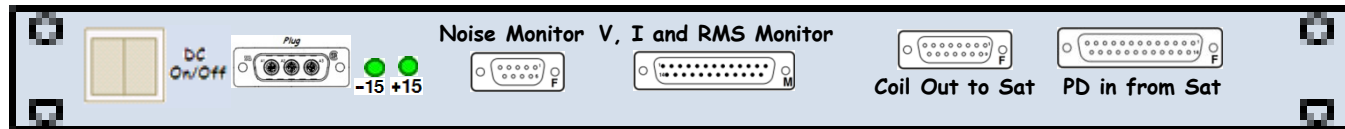
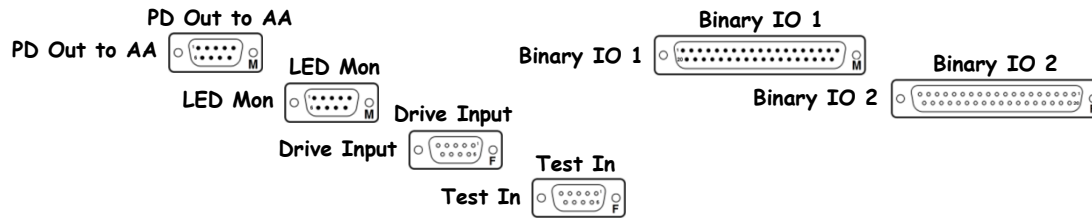

[S1000264](#)
Rear

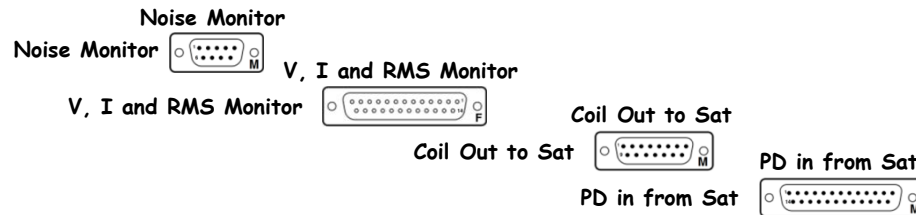

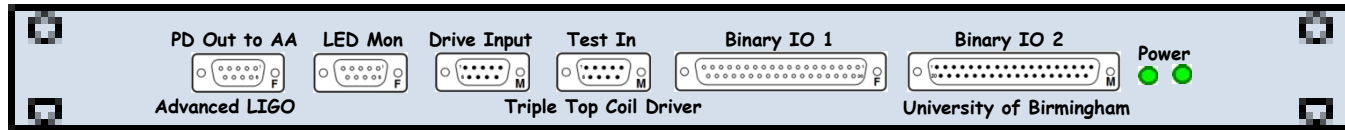

[D0902747](#)
[D070480](#)
 Front

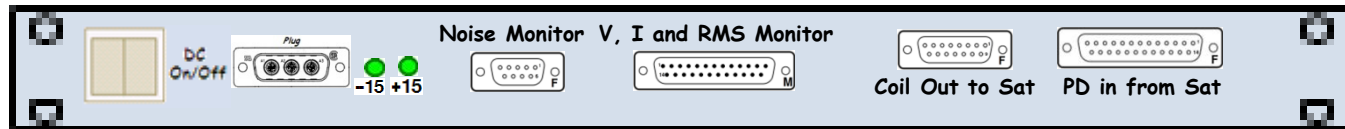
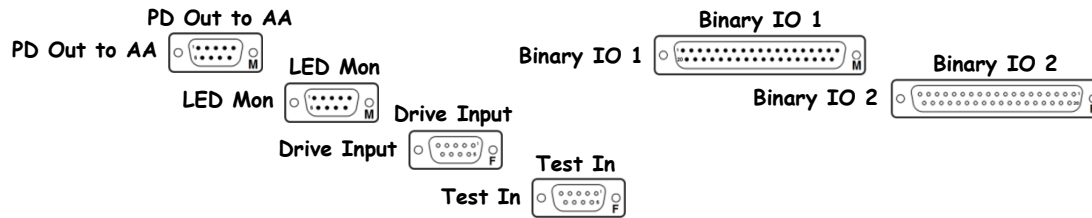

[S1000721](#)
 Rear

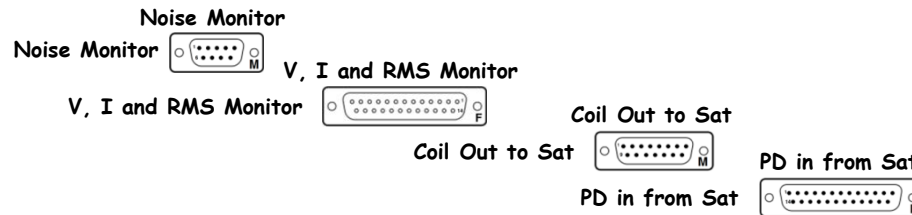

D1001242 - S1000722



<< L1-SUS-C1

SR2 Triple Top Coil Driver Chassis D1001242 S1000722 ±18@0.5A

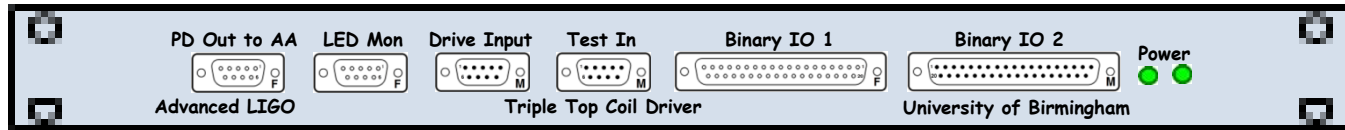

[D0902747](#)
[D070480](#)
Front

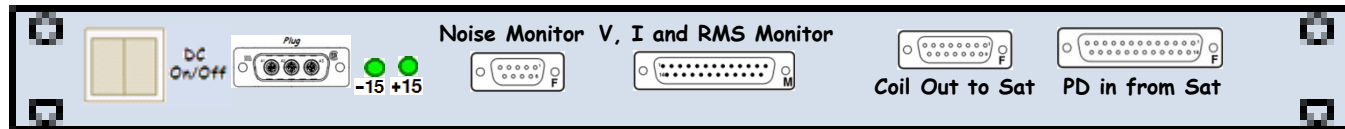
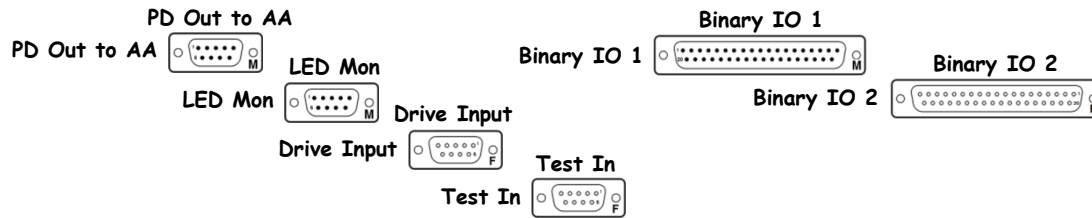

[S1000722](#)
Rear

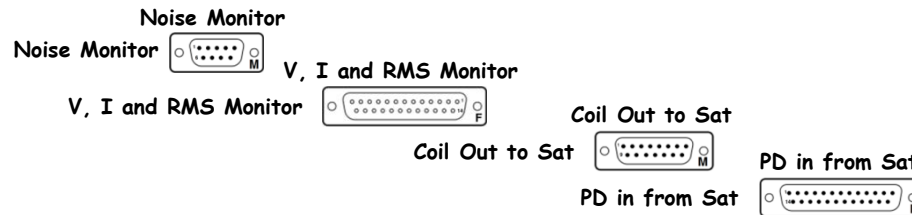

D1001242 - S1000273



<< L1-SUS-C1

SR2 Triple Top Coil Driver Chassis D1001242 S1000273 ±18@0.5A

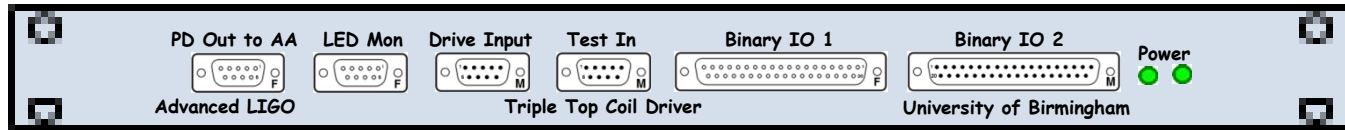

[D0902747](#)
[D070480](#)
Front

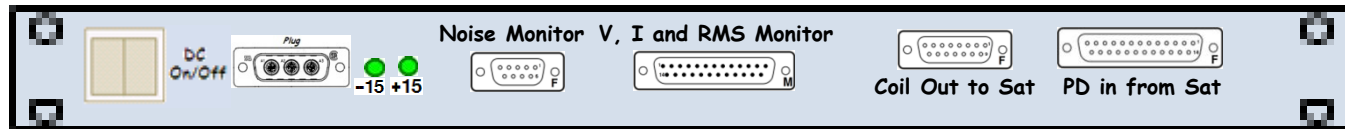
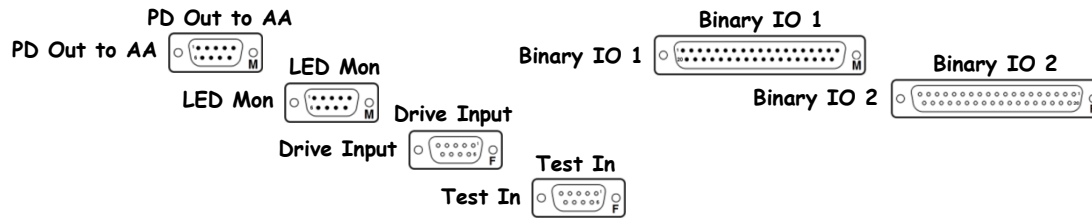

[S1000273](#)
Rear

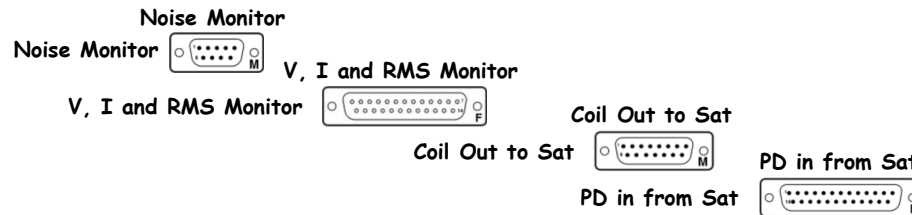

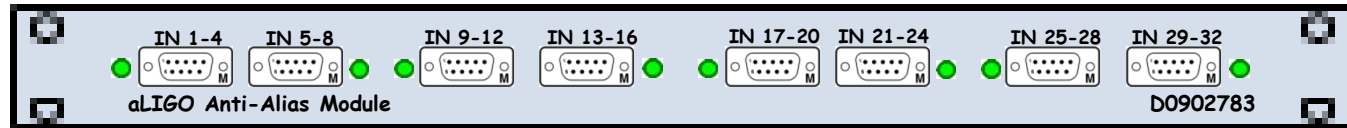
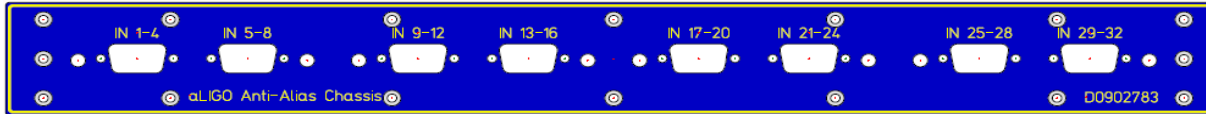

D0902783

Front

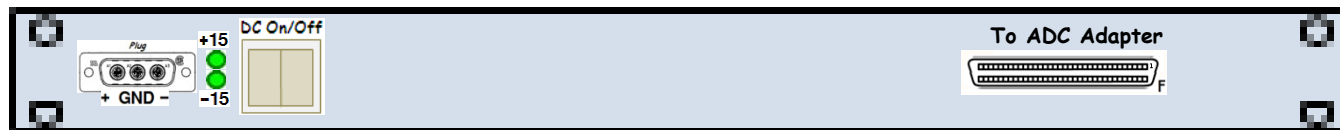
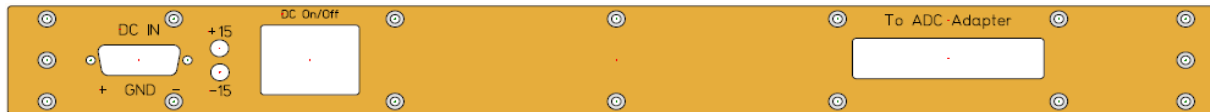
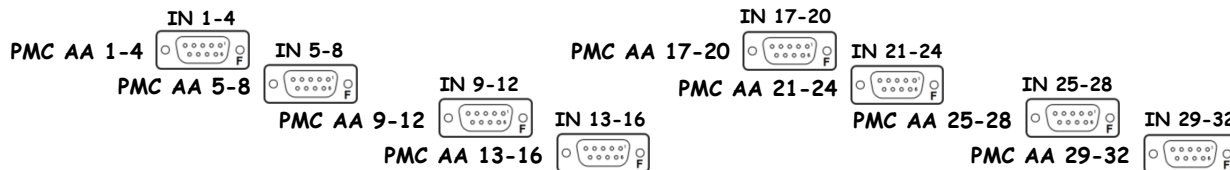

S1001157

Rear



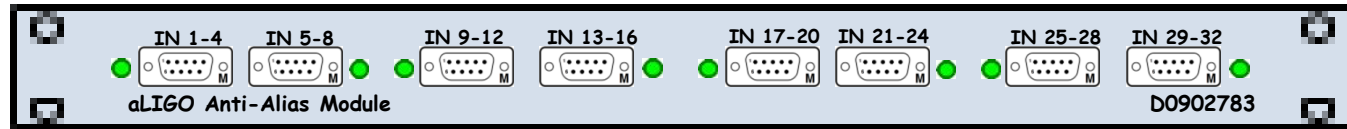
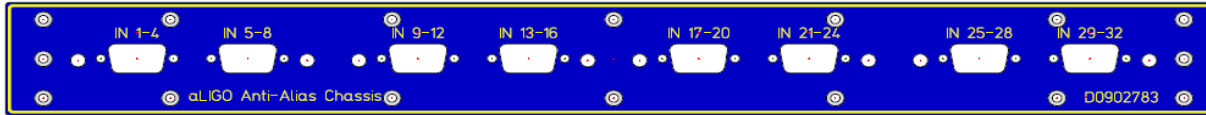

D0902783

Front

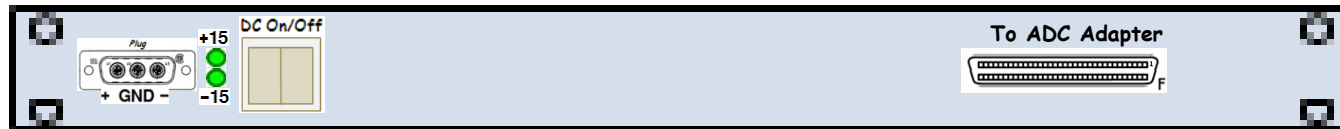
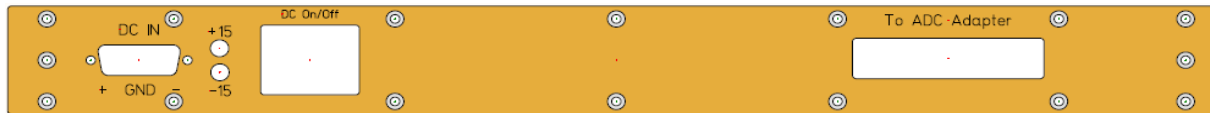
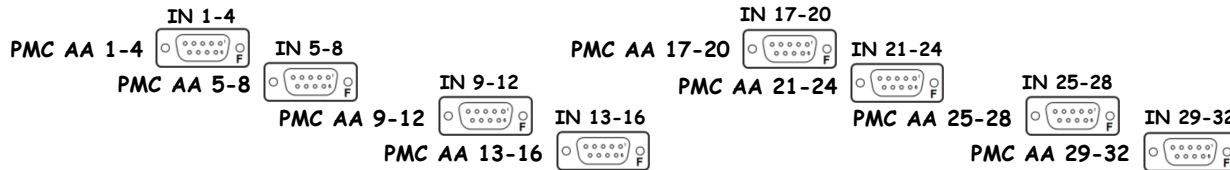

S1100327

Rear



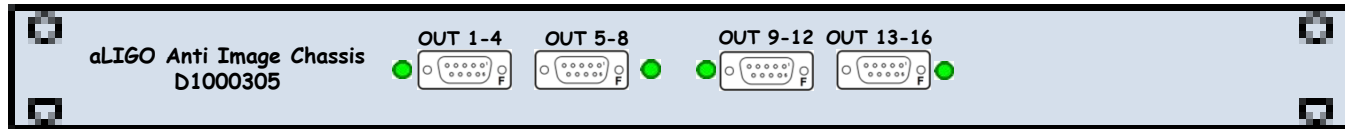
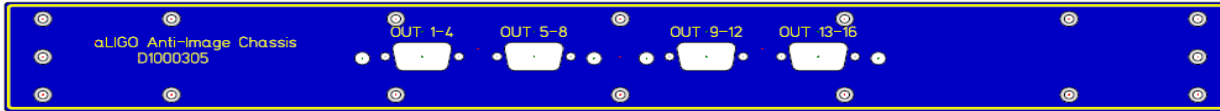

D1000305

Front

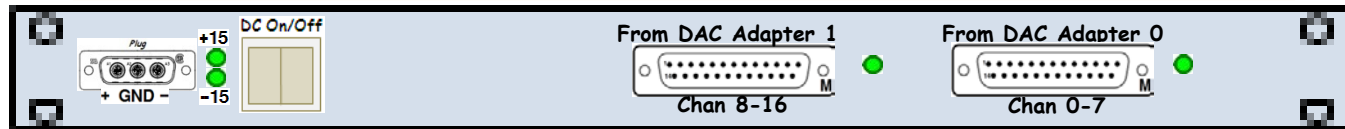
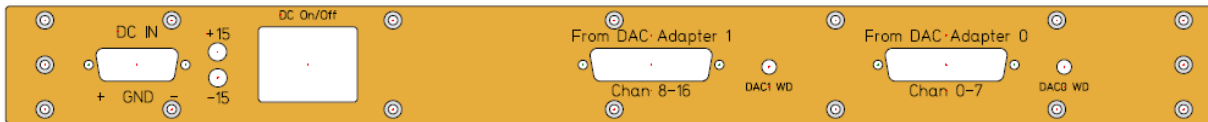

S1001197

Rear

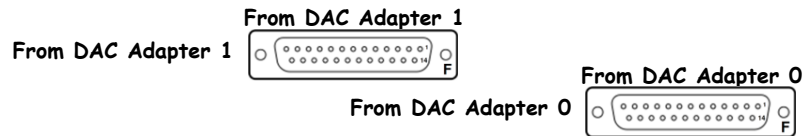

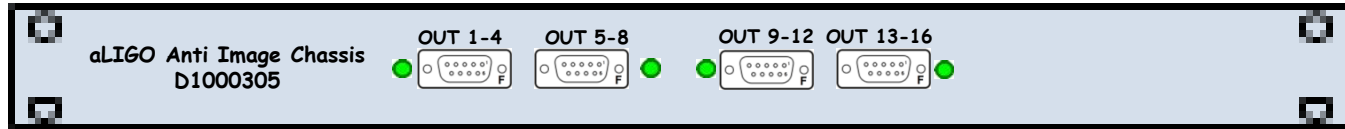
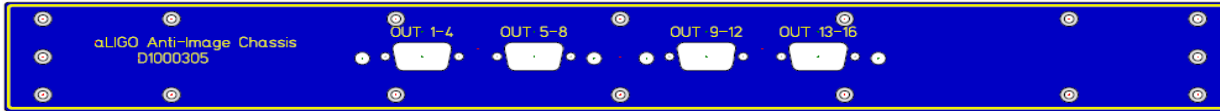

D1000305

Front

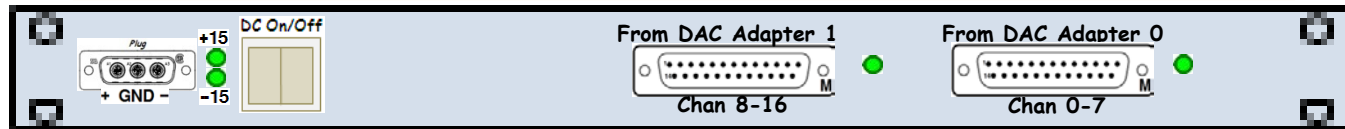
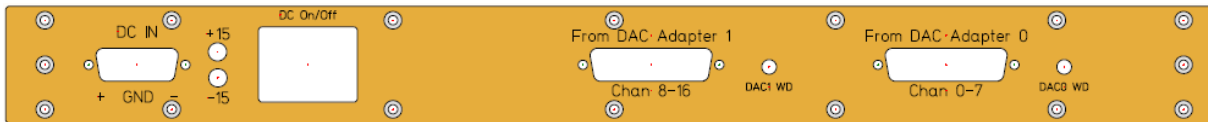

S1001198

Rear

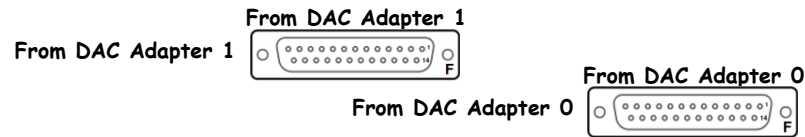

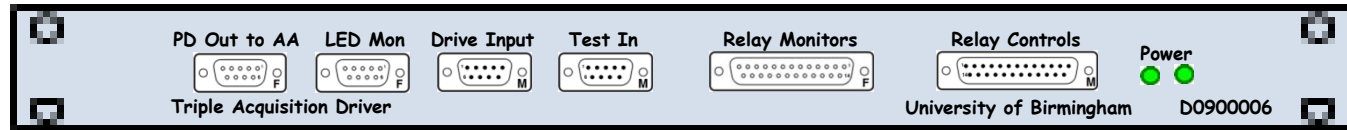

[D0901047](#)
[D070480](#)
Front

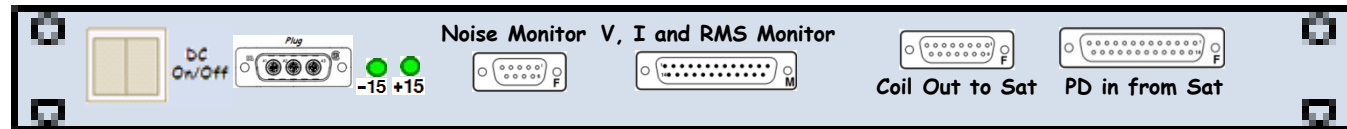
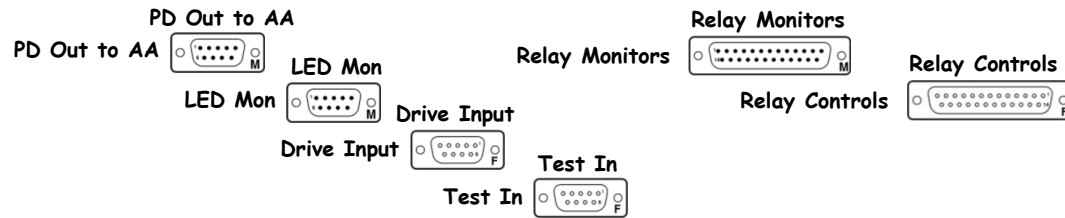

[S1000347](#)
Rear

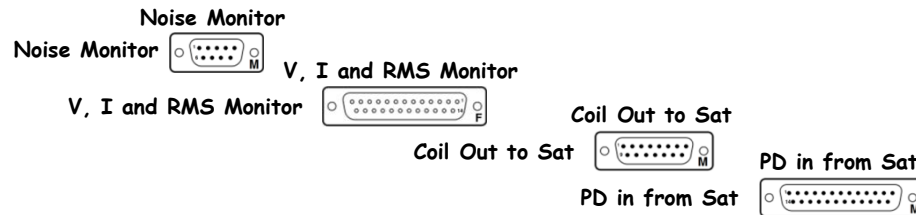

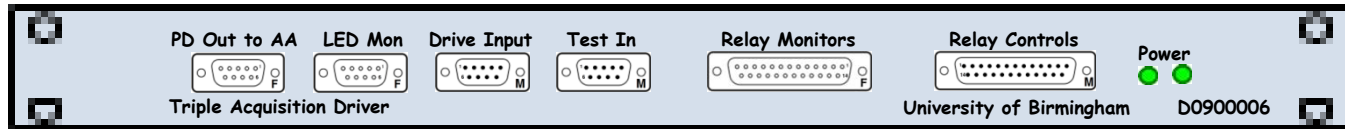

[D0901047](#)
[D070480](#)
Front

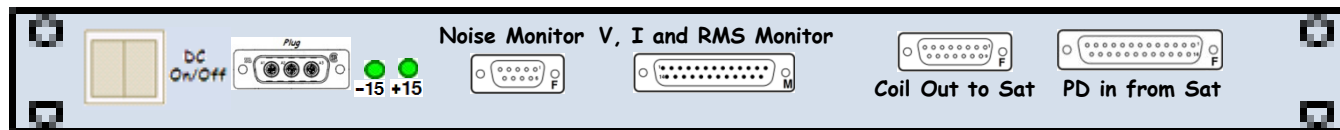
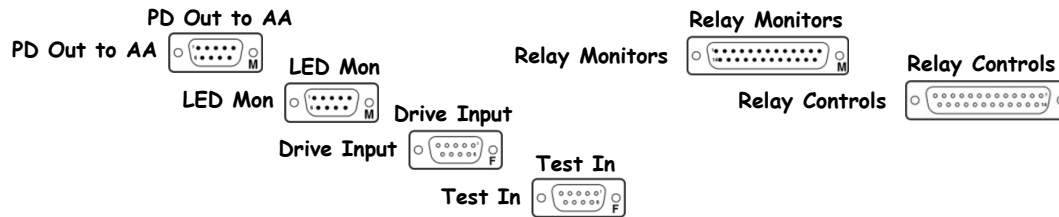

[S1000348](#)
Rear

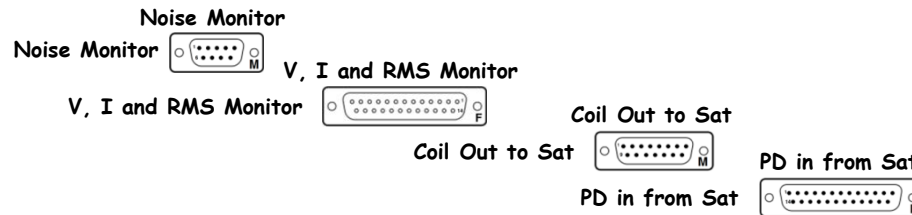

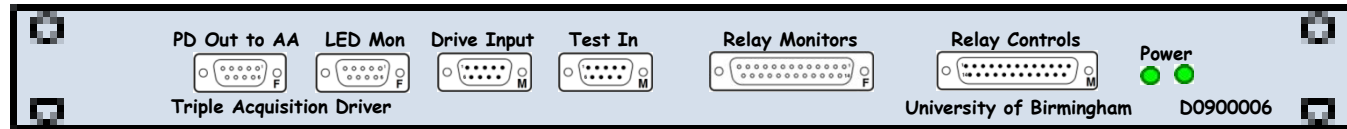

[D0901047](#)
[D070480](#)
Front

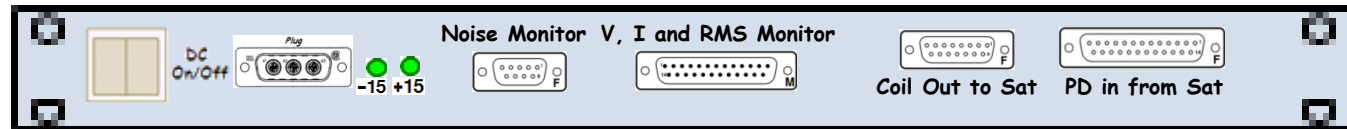
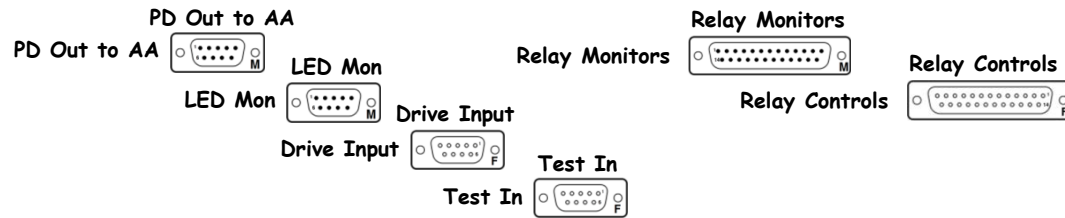

[S1000349](#)
Rear

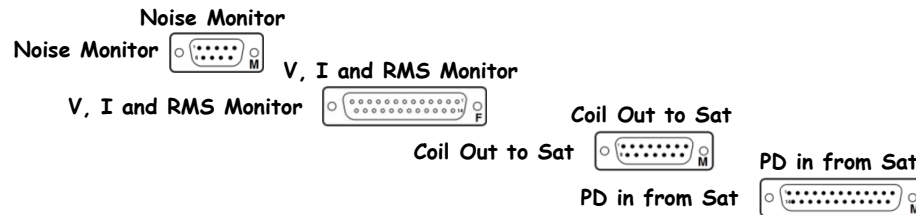

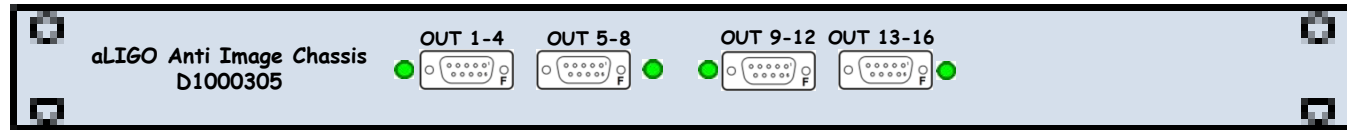
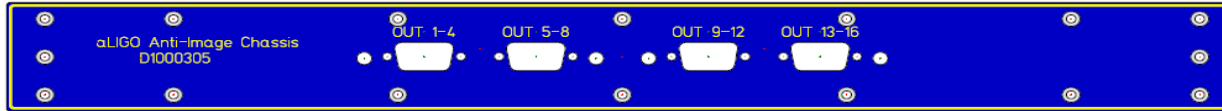

D1000305

Front

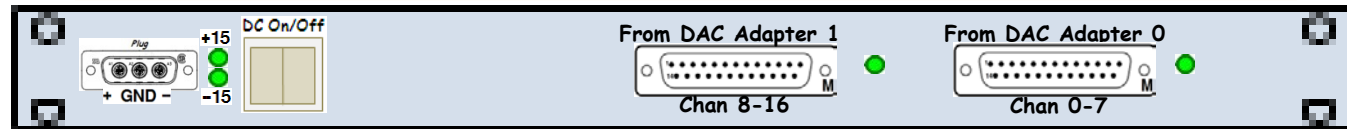
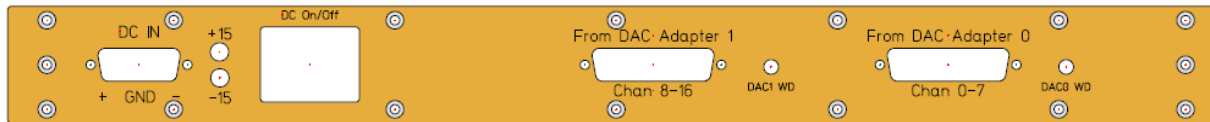

S1101815

Rear

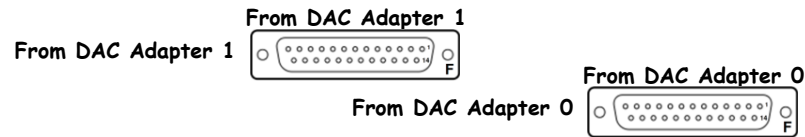

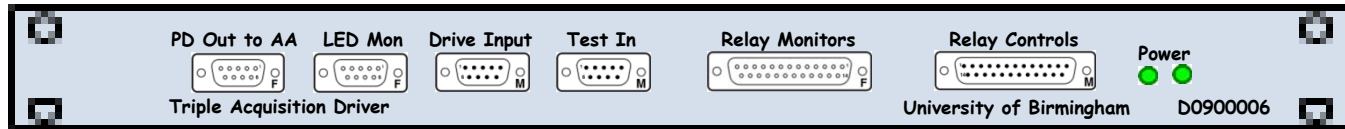

[D0901047](#)
[D070480](#)
Front

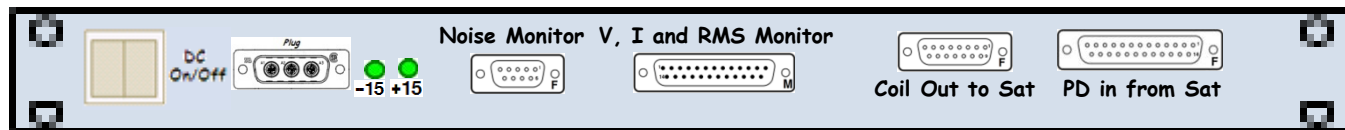
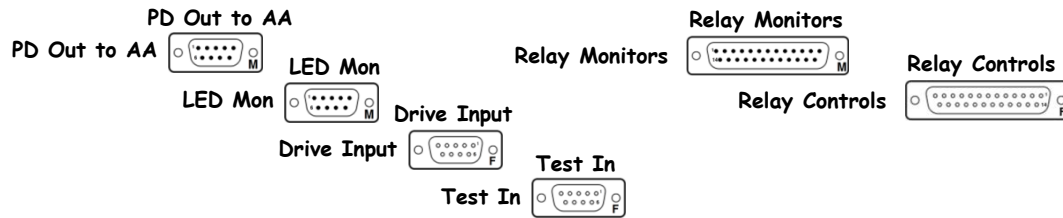

[S1001186](#)
Rear

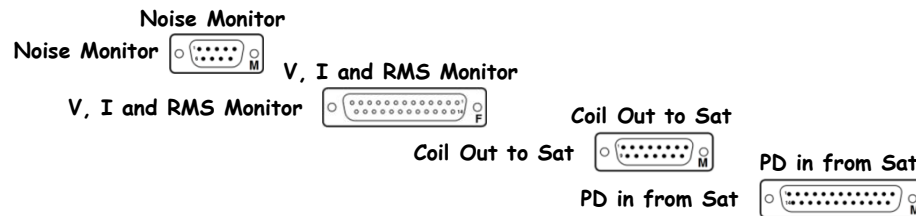

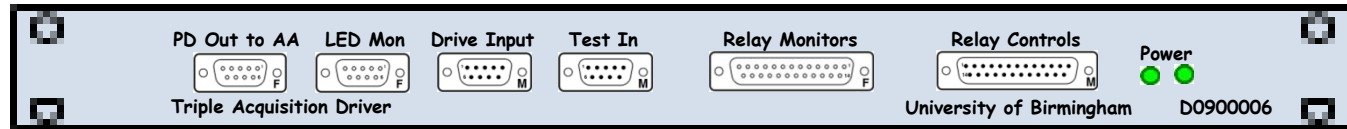

[D0901047](#)
[D070480](#)
Front

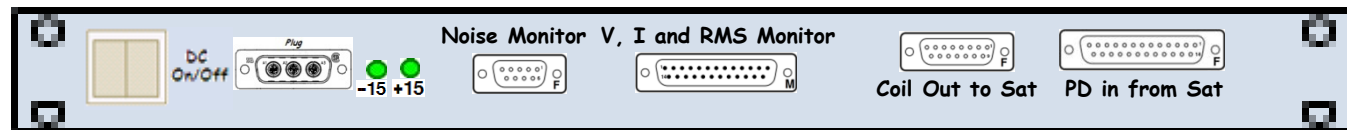
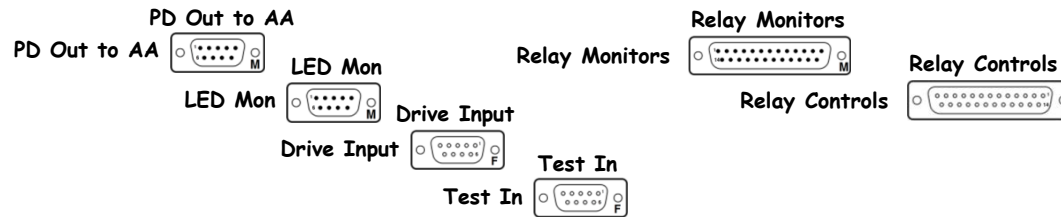

[S1001187](#)
Rear

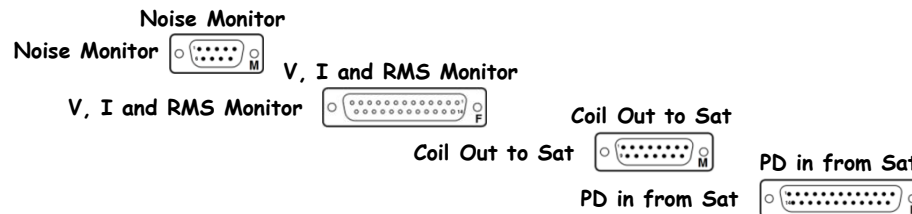

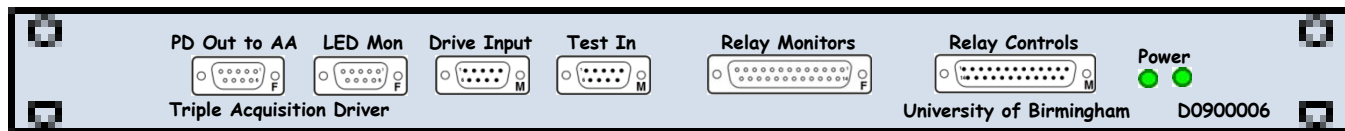

[D0901047](#)
[D070480](#)
 Front

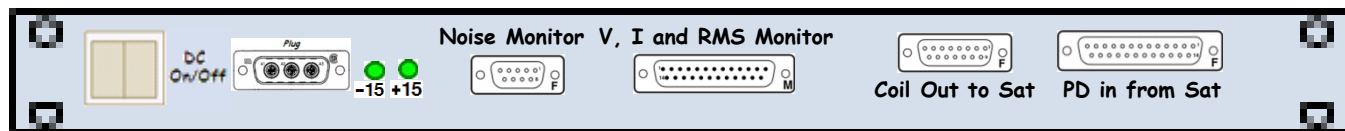
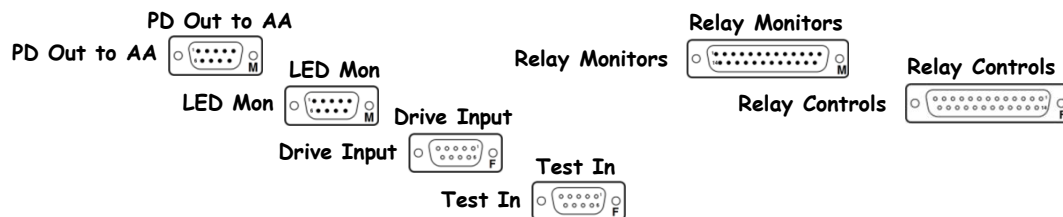

[S1001188](#)
 Rear

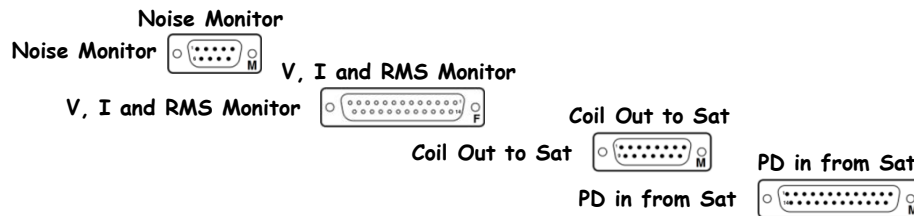

BIO1 Binary Output Chassis D1000725 S1101781 ±18@0.5A

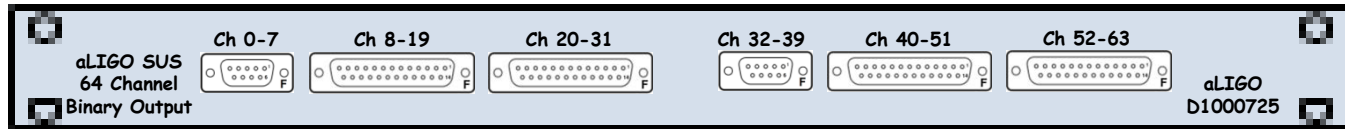
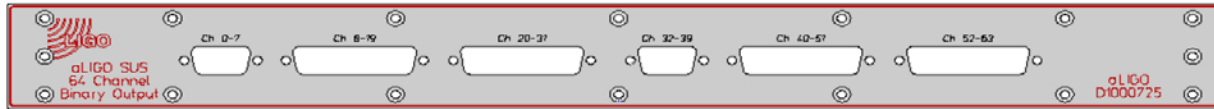

[D1000725](#)

Front

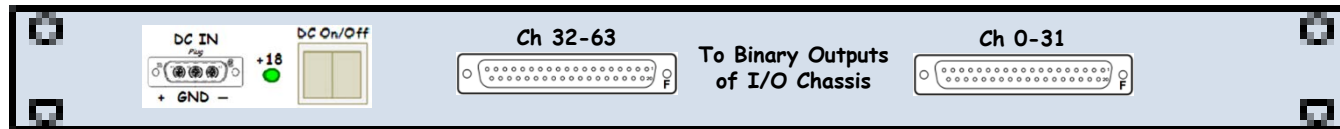
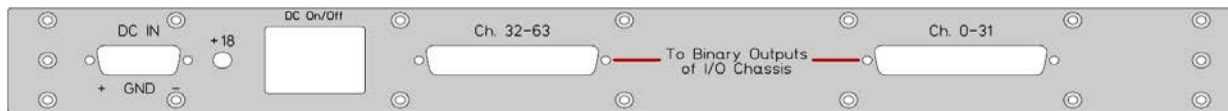
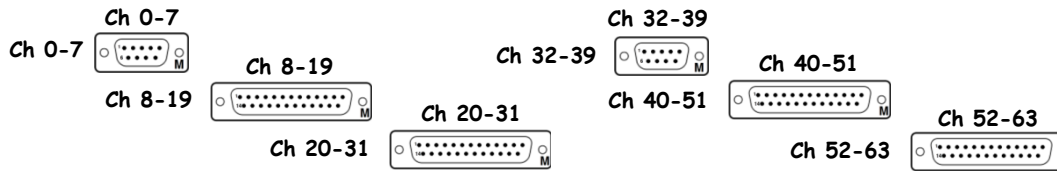

[S1101781](#)

Rear



BIO1 Binary Input Chassis D1000726 S1101805 ±18@0.5A

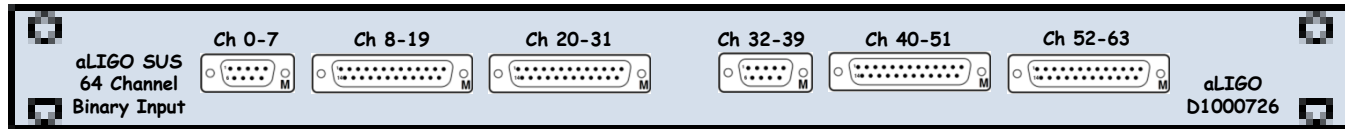
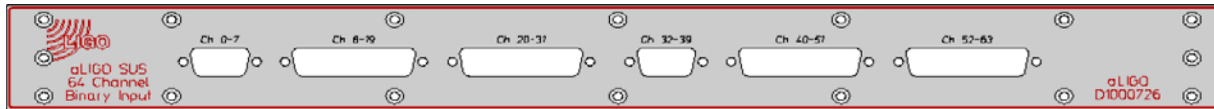

[D1000726](#)

Front

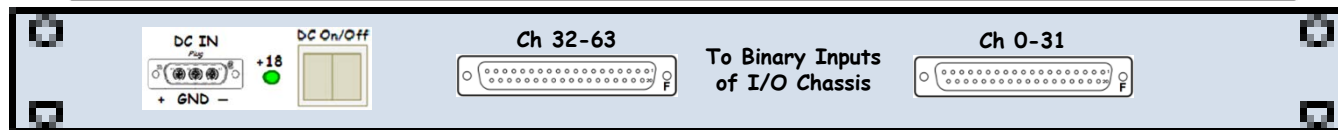
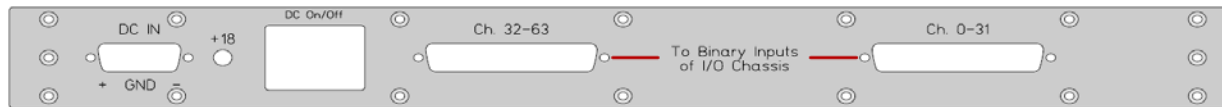
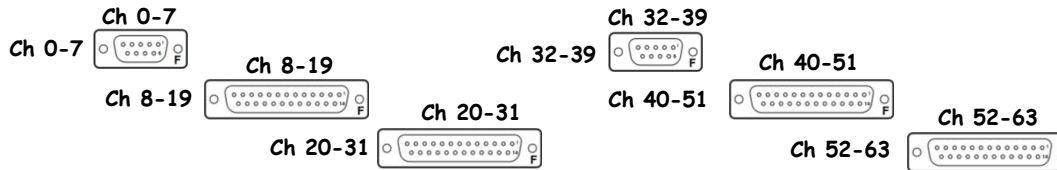

[S1101805](#)

Rear



BI02 Binary Output Chassis D1000725 S1101782 ±18@0.5A

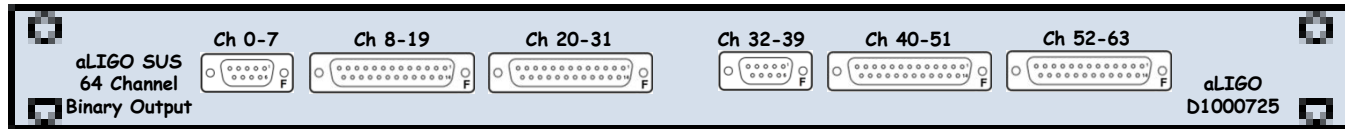
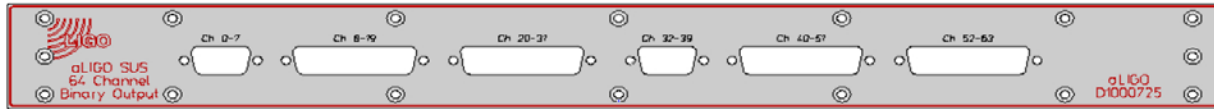

[D1000725](#)

Front

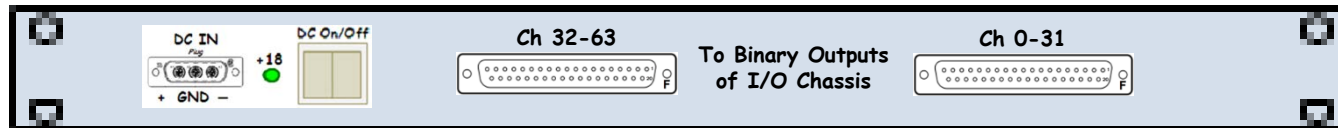
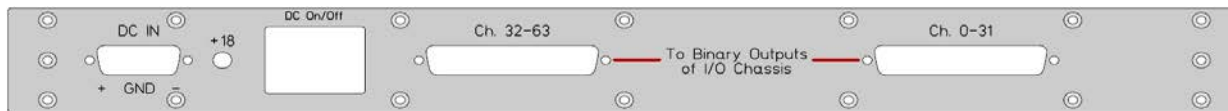
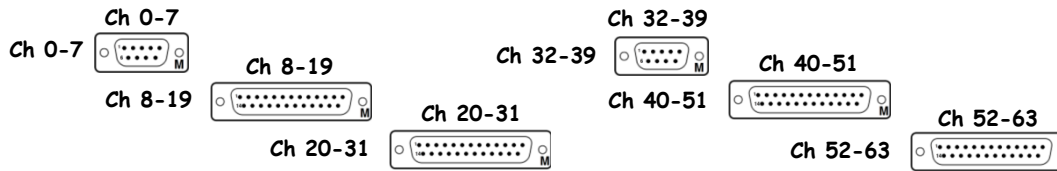

[S1101782](#)

Rear



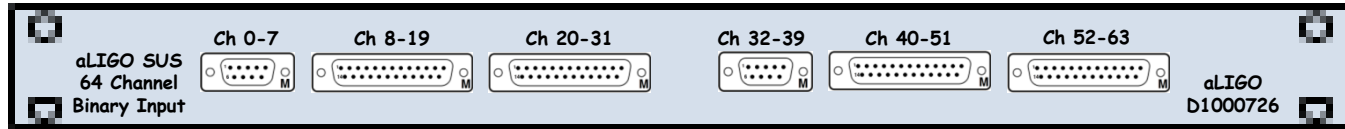
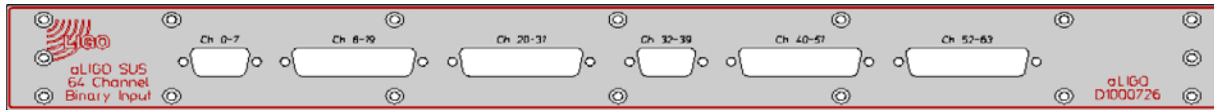

D1000726

Front

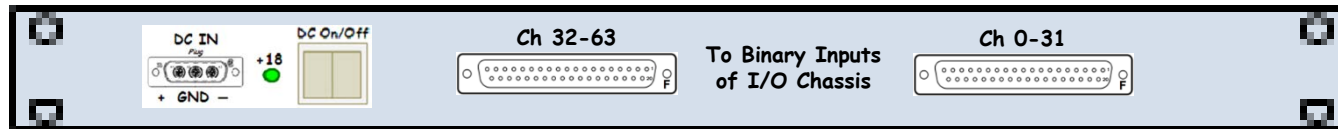
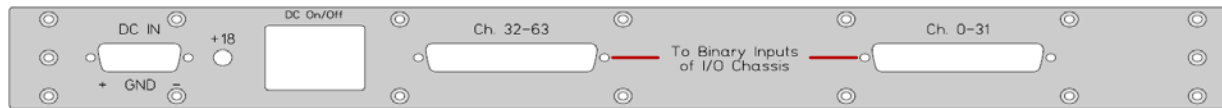
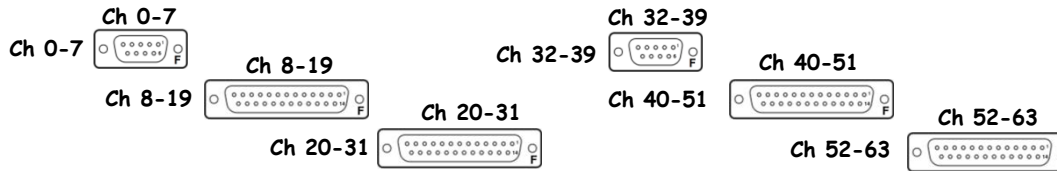

S1101802

Rear



[MON ADC0 Anti-Alias Chassis](#)
[MON ADC1 Anti-Alias Chassis](#)

[MON ADC2 Anti-Alias Chassis](#)
[MON ADC3 Anti-Alias Chassis](#)

[MON ADC4 Anti-Alias Chassis](#)
[MON ADC5 Anti-Alias Chassis](#)

[1susauxham3-4 MON I/O Extension Chassis](#)

[1susham3-4 FE I/O Extension Chassis](#)

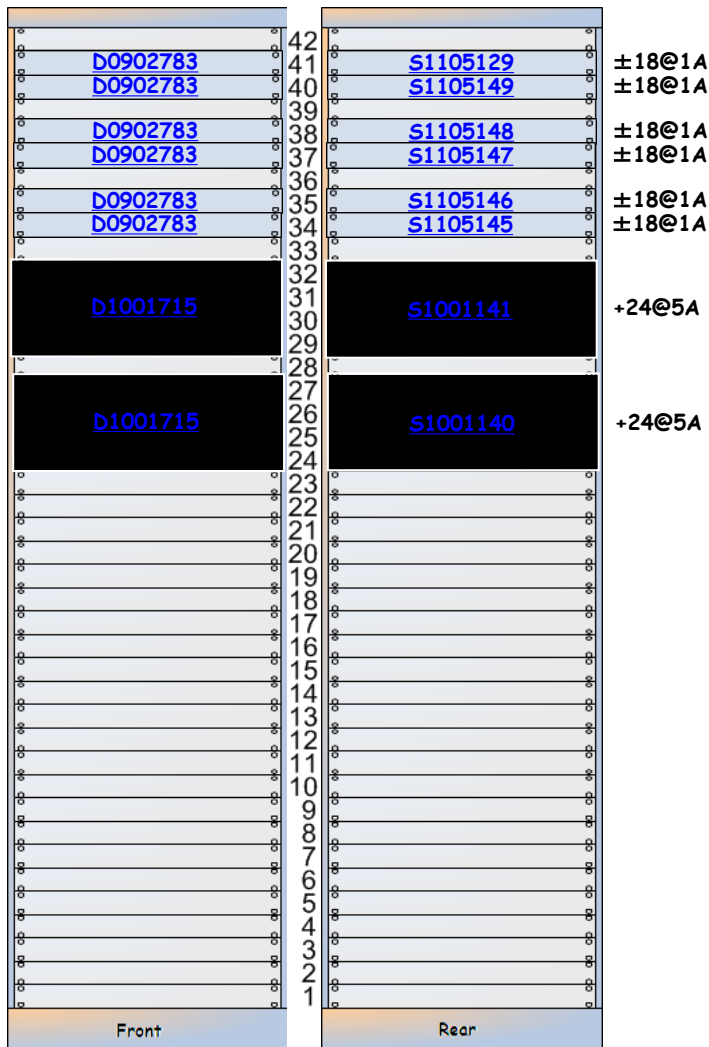
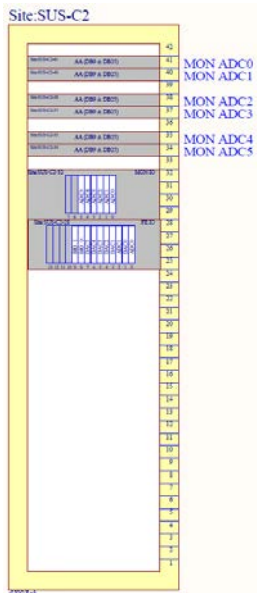

L1-SUS-C2 Details

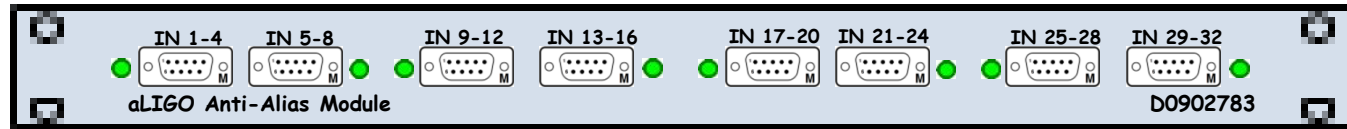
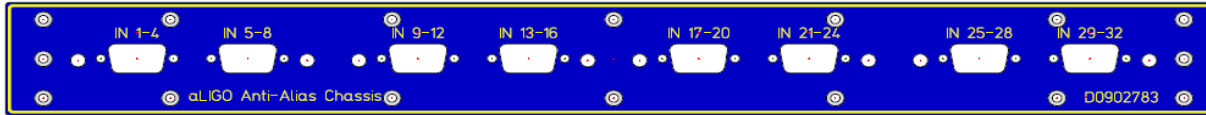

D0902783

Front

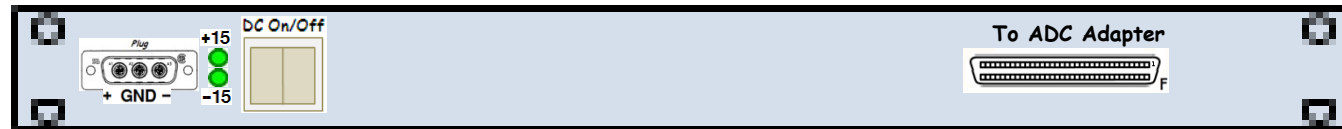
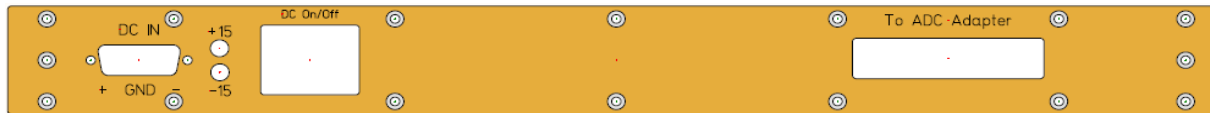
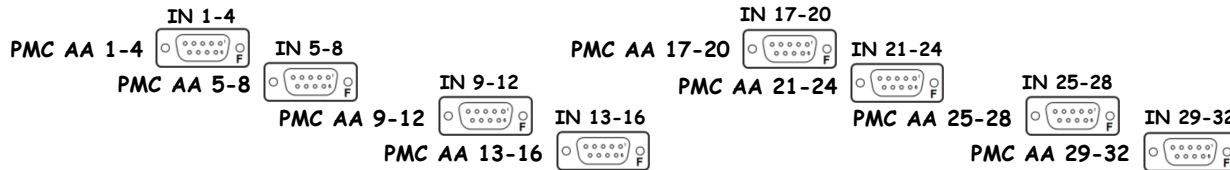

S1105129

Rear



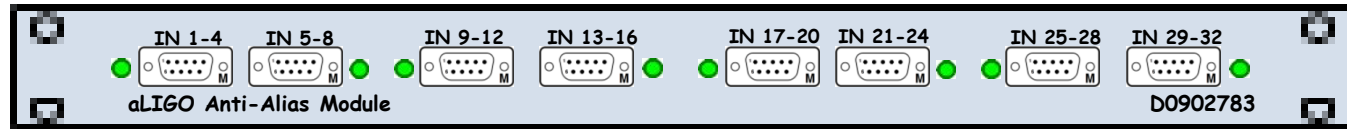
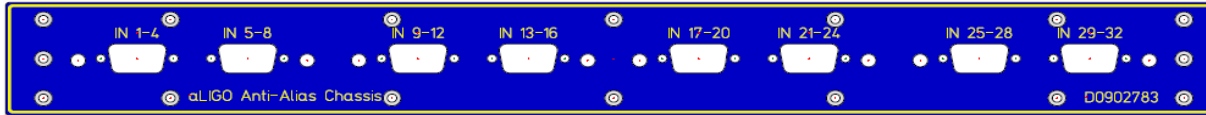

D0902783

Front

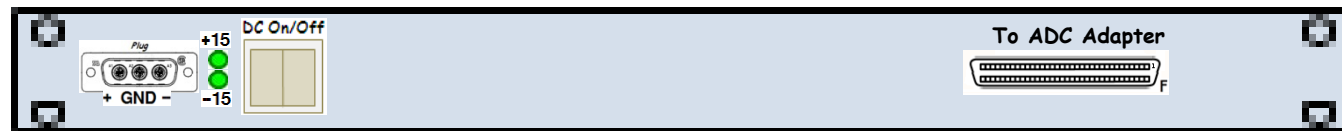
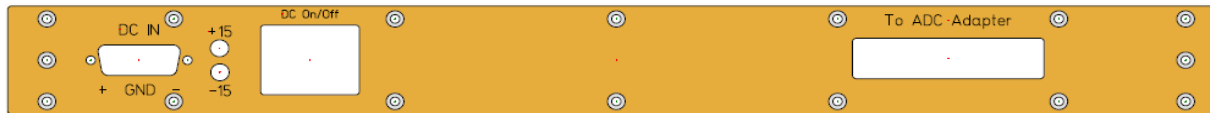
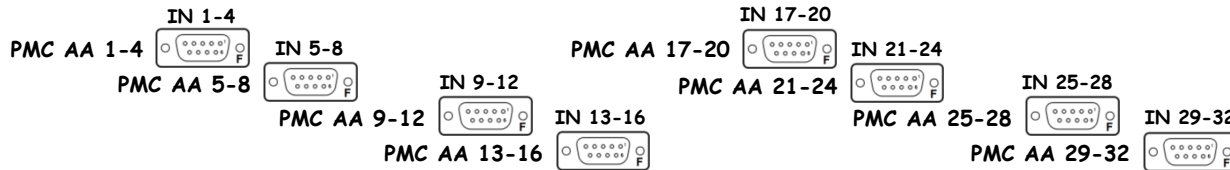

S1105149

Rear



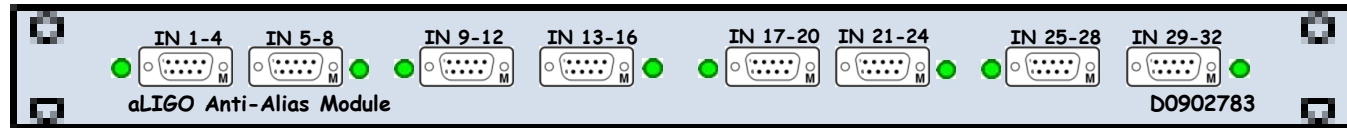
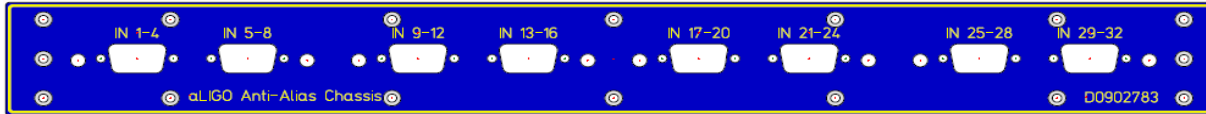

D0902783

Front

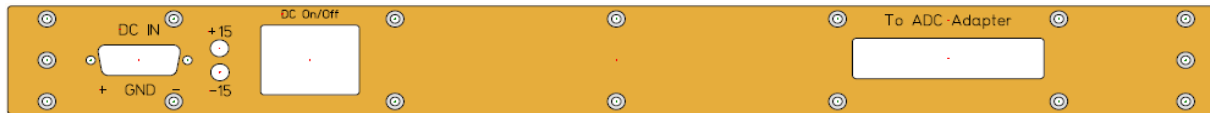
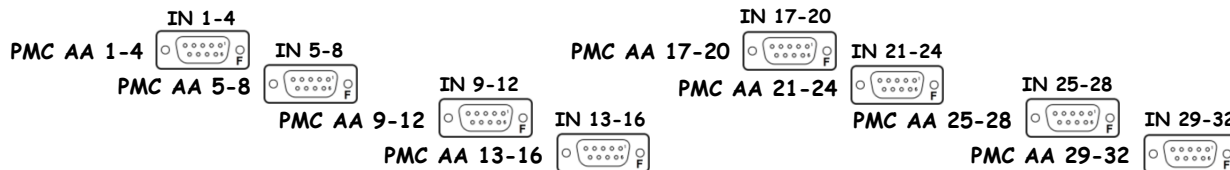

S1105148

Rear



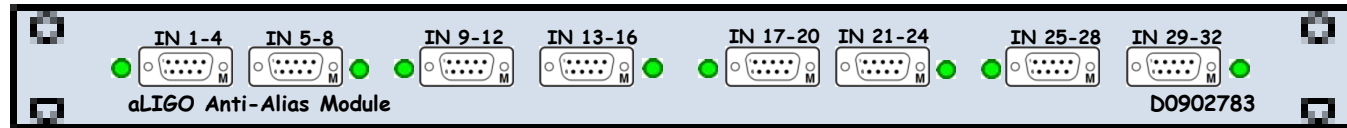
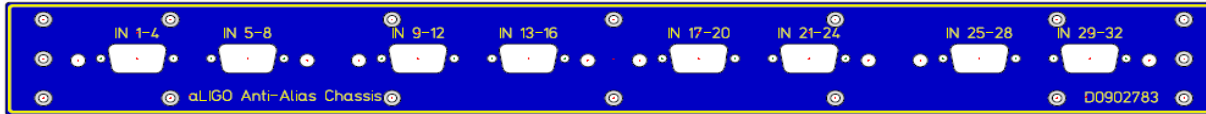

D0902783

Front

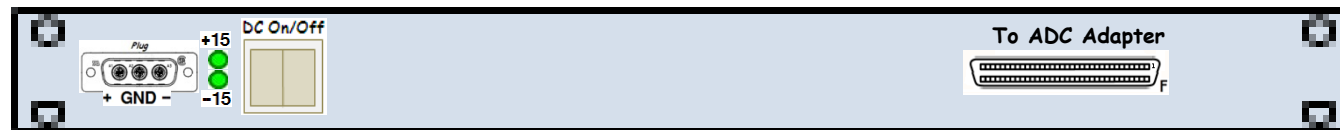
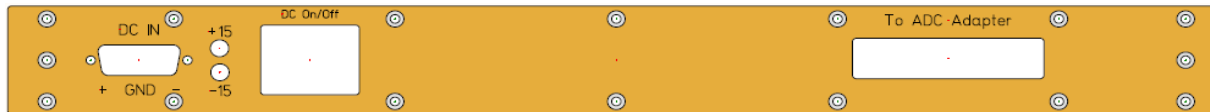
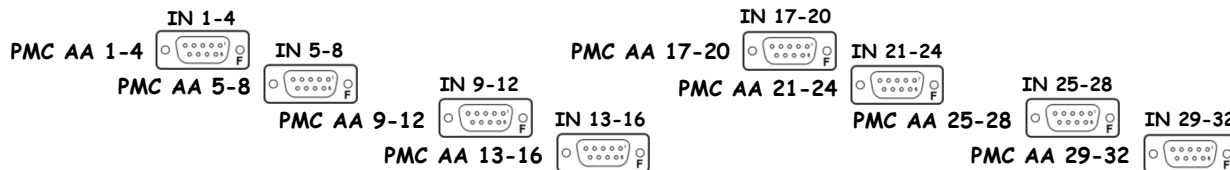

S1105147

Rear



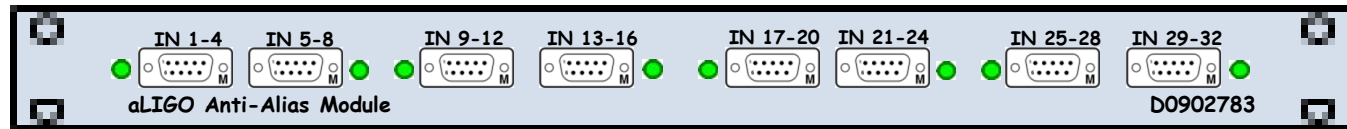
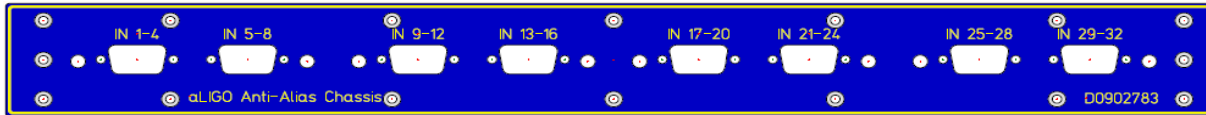

D0902783

Front

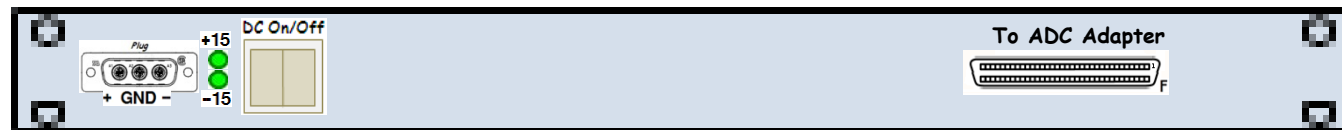
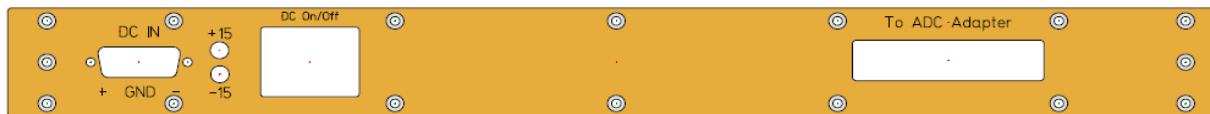
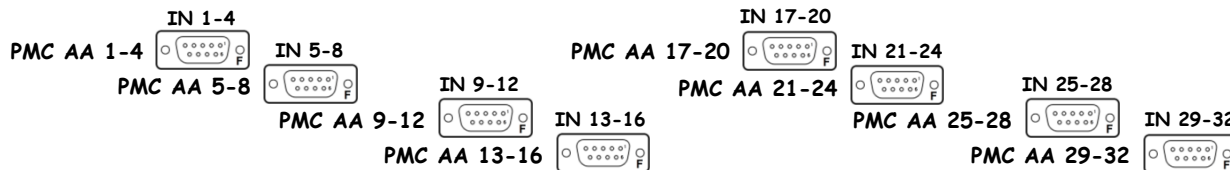

S1105146

Rear



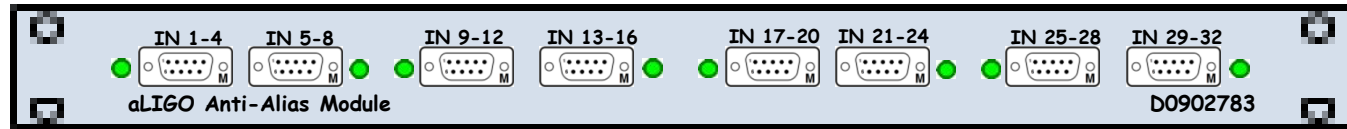
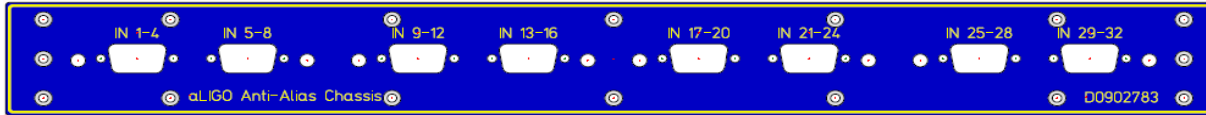

D0902783

Front

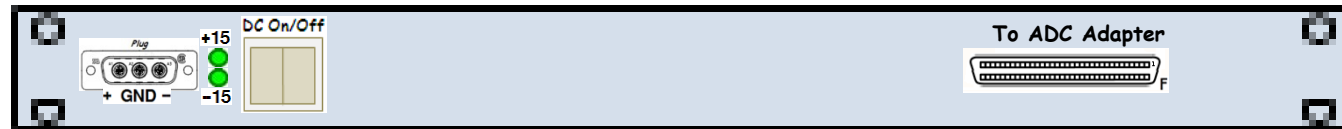
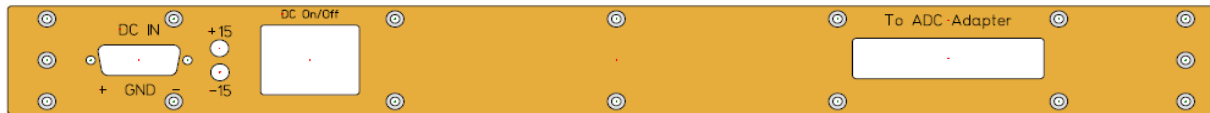
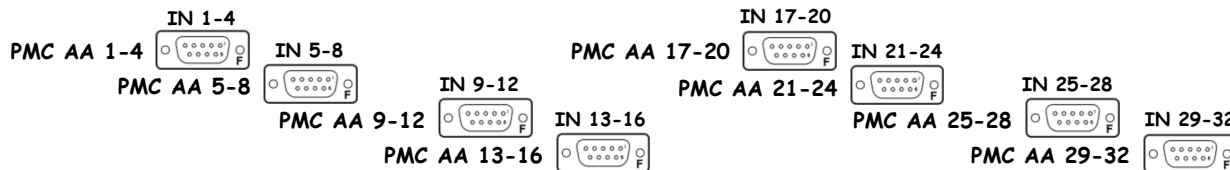

S1105145

Rear





D1001715

Front

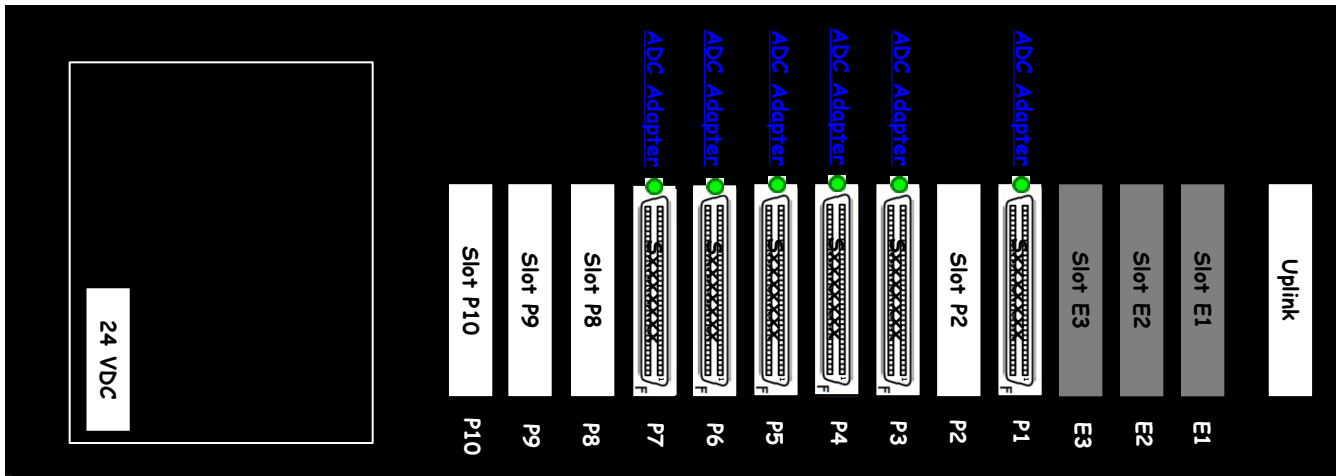

S1001141

Rear

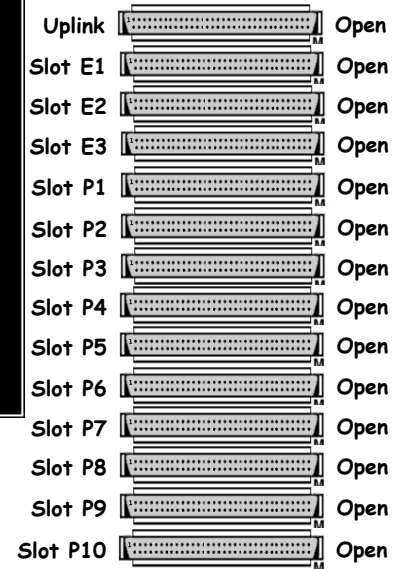



D1001715

Front

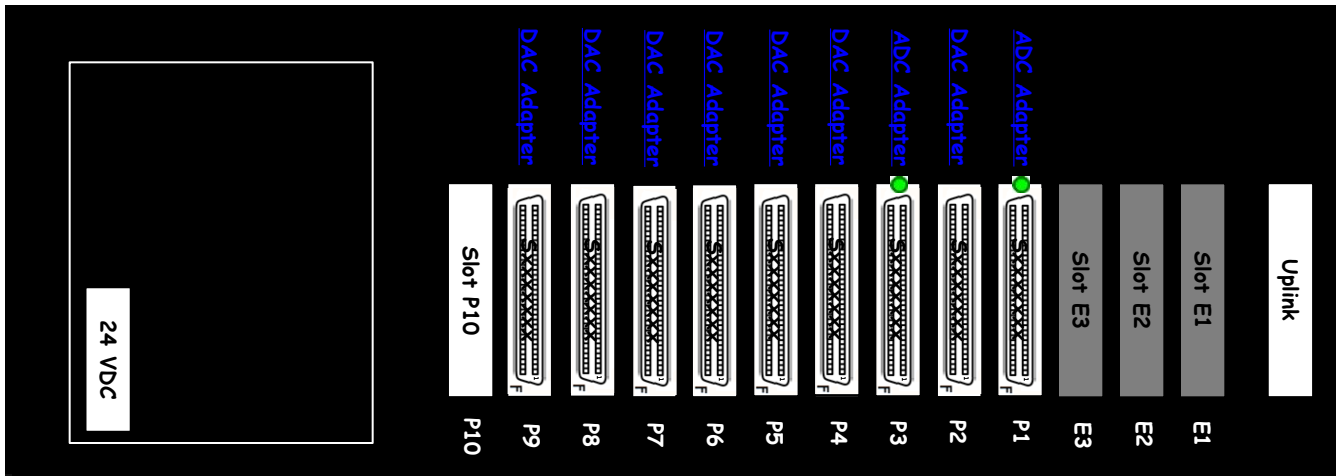

S1001140

Rear

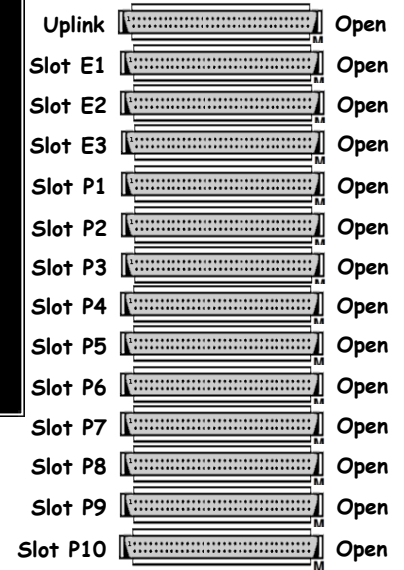

MON ADC0 Anti-Alias Chassis
 MON ADC1 Anti-Alias Chassis
 MON ADC2 Anti-Alias Chassis
 MON ADC3 Anti-Alias Chassis
 MON ADC4 Anti-Alias Chassis
 MON ADC5 Anti-Alias Chassis
 MON ADC6 Anti-Alias Chassis
 MON ADC7 Anti-Alias Chassis

[l1susauxham2 MON I/O Extension Chassis](#)

[l1susham2a FE I/O Extension Chassis](#)

[l1susham2b FE I/O Extension Chassis](#)

BIO 0 Binary Output Chassis
 BIO 0 Binary Input Chassis
 BIO 1 Binary Output Chassis
 BIO 1 Binary Input Chassis
 BIO 2 Binary Output Chassis
 BIO 2 Binary Input Chassis

BIO 0 Binary Output Chassis
 BIO 0 Binary Input Chassis

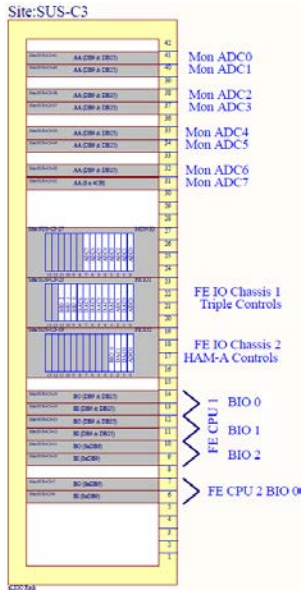
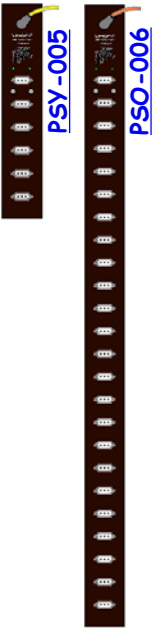
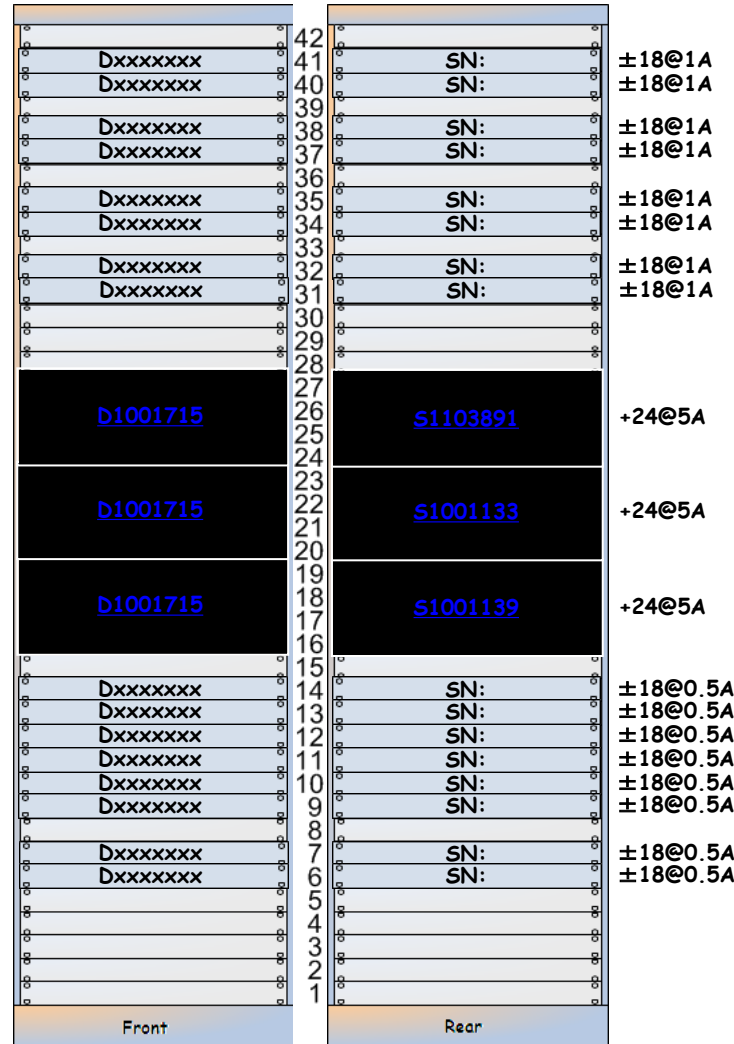

L1-SUS-C3 Details

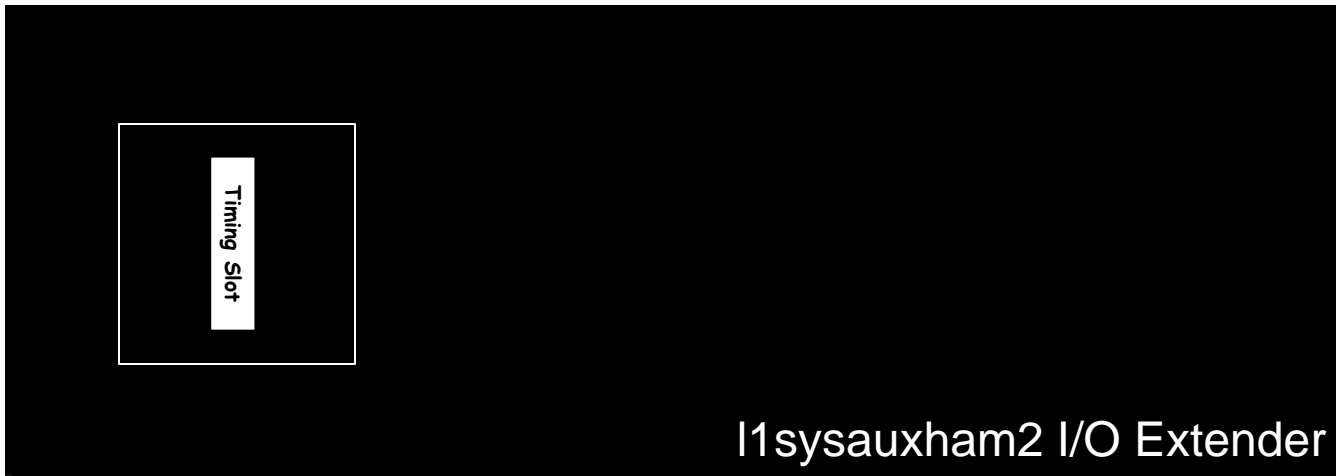

[D1001715](#)

Front

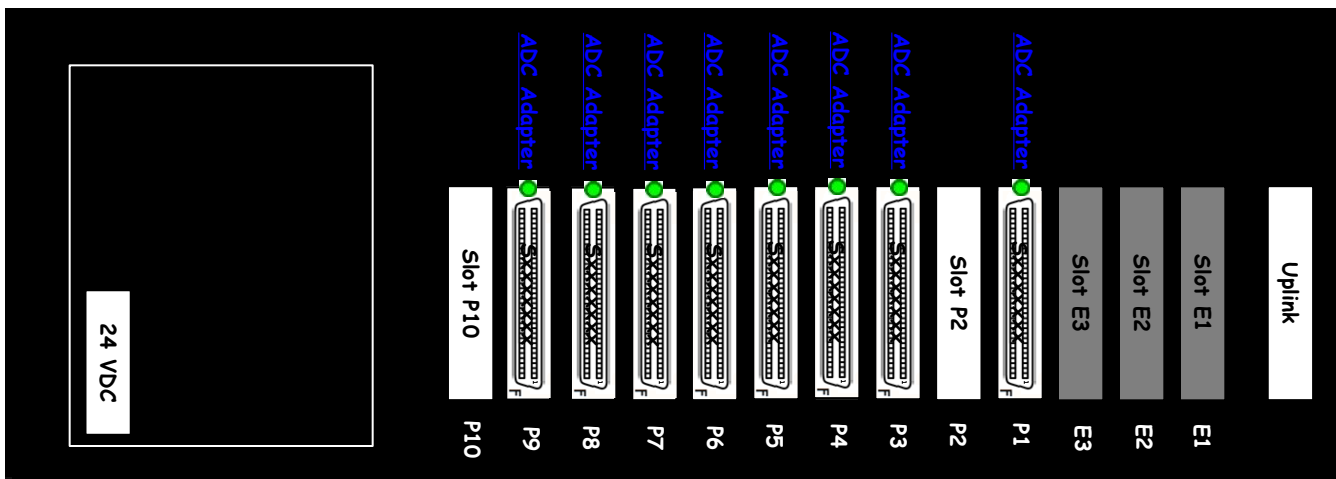

[S1003891](#)

Rear

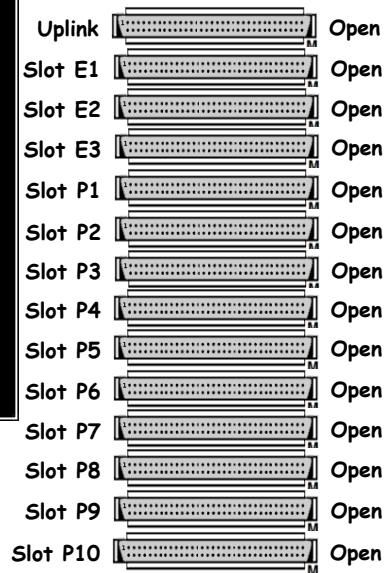



[D1001715](#)

Front

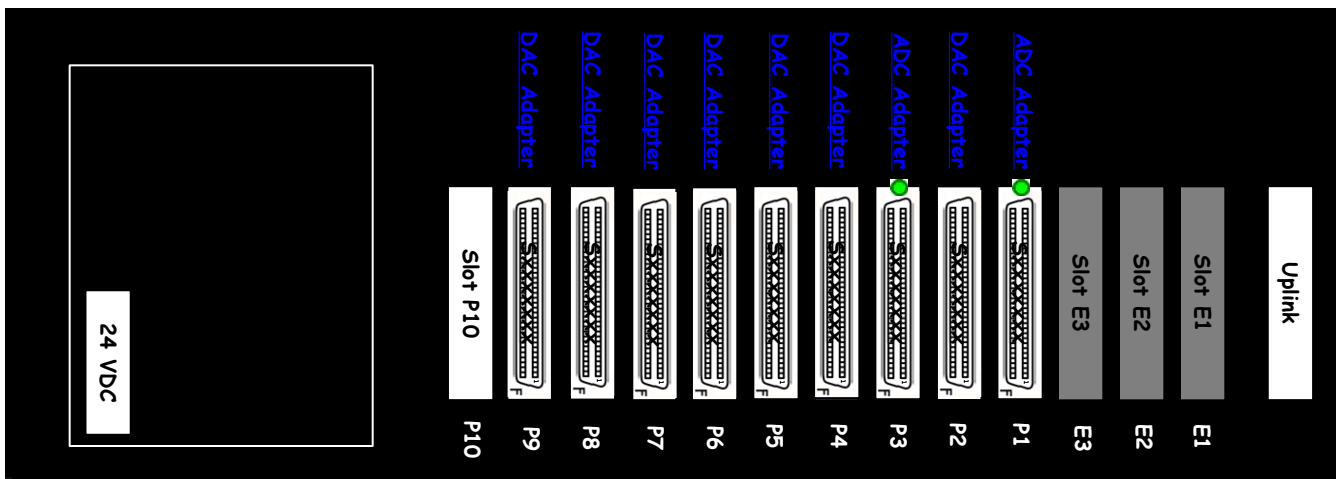

[S1001133](#)

Rear

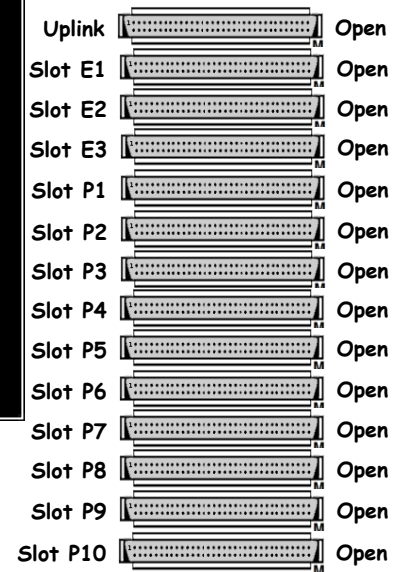



[D1001715](#)

Front

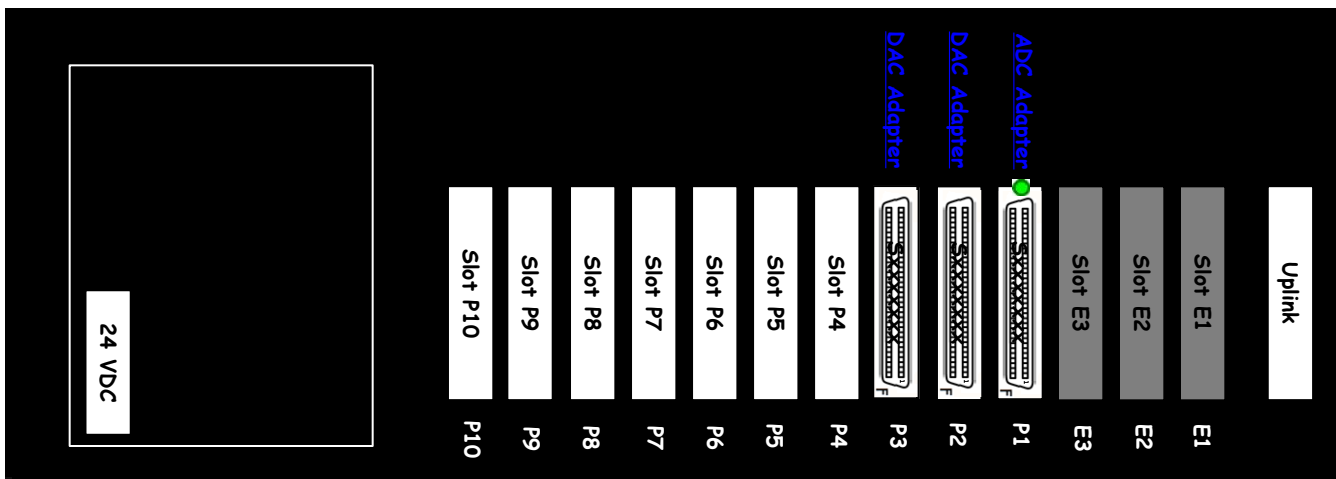

[S1001139](#)

Rear

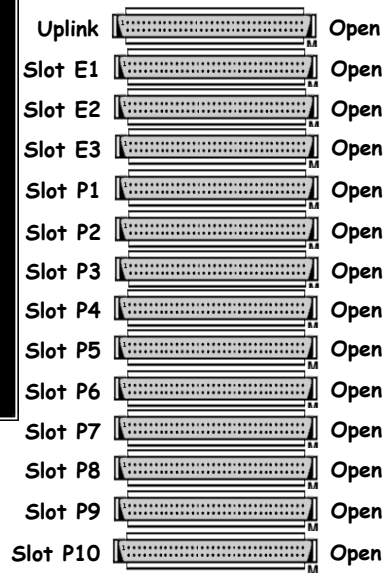

Binary Input Chassis D1001726 Sxxxxxxx ±18@0.5A

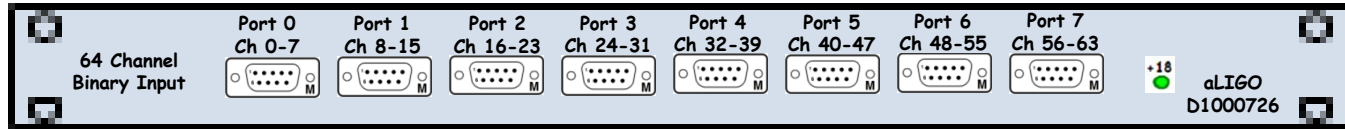
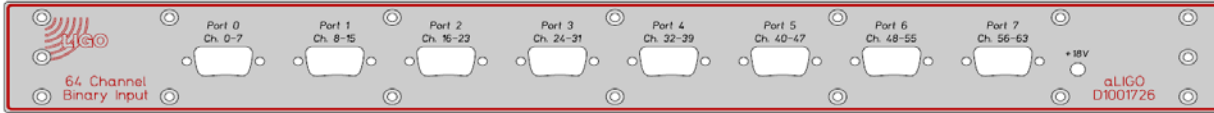

D1001726

Front

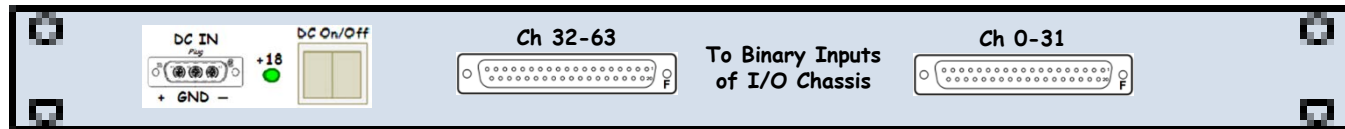
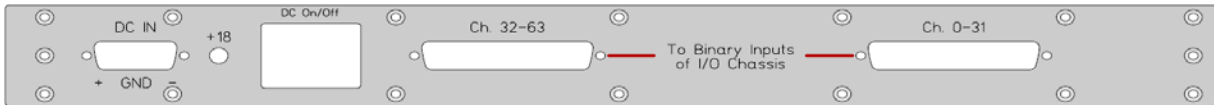
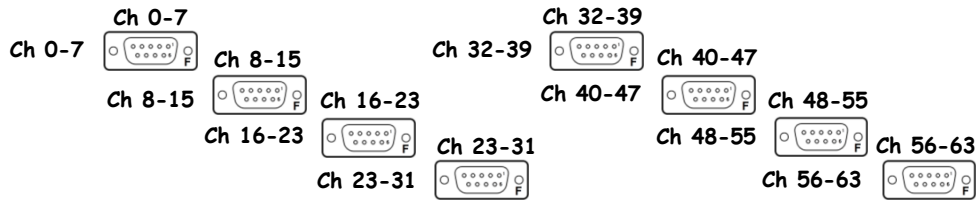

Sxxxxxxx

Rear



Binary Output Chassis ±18@0.5A

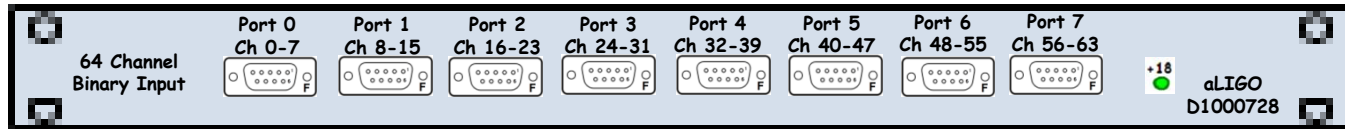
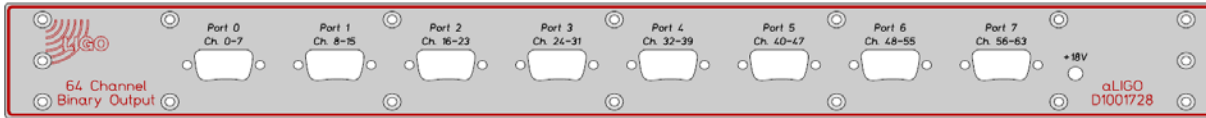

D1001728

Front

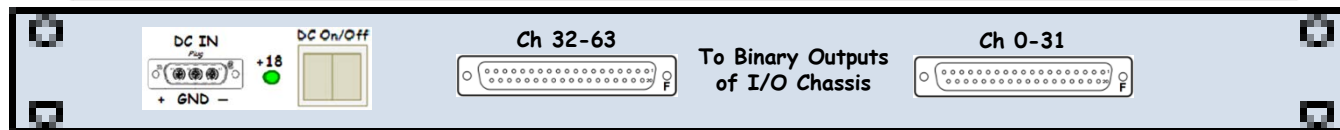
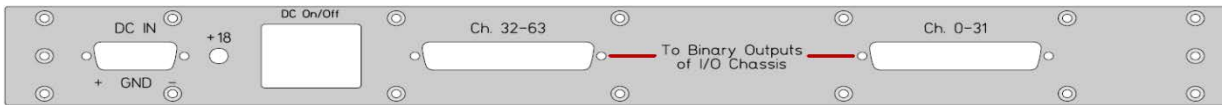
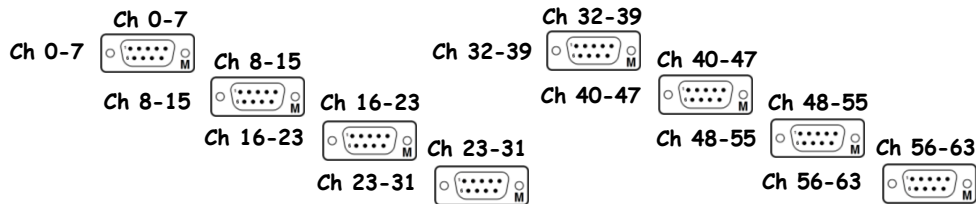

Sxxxxxxx

Rear



[MC1-MC3 Triple Top Coil Driver Chassis](#)
[MC1-MC3 Triple Top Coil Driver Chassis](#)
[MC1-MC3 Triple Top Coil Driver Chassis](#)

[PRM-PR3 Triple Top Coil Driver Chassis](#)
[PRM-PR3 Triple Top Coil Driver Chassis](#)
[PRM-PR3 Triple Top Coil Driver Chassis](#)

FE1 ADC0 Anti-Alias Chassis
 FE1 ADC1 Anti-Alias Chassis

FE1 DAC0, FE1 DAC1 Anti-Image Chassis
 FE1 DAC2, FE1 DAC3 Anti-Image Chassis

MC1 Mid Triple Acq Driver Chassis
 MC1 Bot Triple Acq Driver Chassis
 MC3 Mid Triple Acq Driver Chassis
 MC3 Bot Triple Acq Driver Chassis

FE1 DAC4, FE1 DAC5 Anti-Image Chassis
 FE1 DAC6 Anti-Image Chassis

PRM Mid Triple Acq Driver Chassis
 PRM Bot Triple Acq Driver Chassis
 PR3 Mid Triple Acq Driver Chassis
 PR3 Bot Triple Acq Driver Chassis

SM2 8-Channel Coil Driver Chassis
 SM2 8-Channel Coil Driver Chassis

FE2 ADC0 Anti-Alias Chassis
 FE2 DAC0 Anti-Image Chassis

PMMT1 8-Channel Coil Driver Chassis
 PMMT2 8-Channel Coil Driver Chassis

	42				
	41	D1001242	S1000253	±18@1A	
	40	D1001242	S1000261	±18@1A	
	39	D1001242	S1000262	±18@1A	
	38				
	37	D1001242	S1000257	±18@1A	
	36	D1001242	S1000259	±18@1A	
	35	D1001242	S1000723	±18@1A	
	34				
	33	Dxxxxxxx	SN:	±18@1A	
	32	Dxxxxxxx	SN:	±18@1A	
	31				
	30	Dxxxxxxx	SN:	±18@0.5A	
	29	Dxxxxxxx	SN:	±18@0.5A	
	28				
	27	D0900006	SN:	±18@1A	
	26	D0900006	SN:	±18@1A	
	25	D0900006	SN:	±18@1A	
	24	D0900006	SN:	±18@1A	
	23				
	22	Dxxxxxxx	SN:	±18@0.5A	
	21	Dxxxxxxx	SN:	±18@0.5A	
	20				
	19	D0900006	SN:	±18@1A	
	18	D0900006	SN:	±18@1A	
	17	D0900006	SN:	±18@1A	
	16	D0900006	SN:	±18@1A	
	15				
	14	Dxxxxxxx	SN:	±18@1A	
	13	Dxxxxxxx	SN:	±18@1A	
	12				
	11	Dxxxxxxx	SN:	±18@1A	
	10	Dxxxxxxx	SN:	±18@0.5A	
	9				
	8	Dxxxxxxx	SN:	±18@1A	
	7	Dxxxxxxx	SN:	±18@1A	
	6				
	5				
	4				
	3				
	2				
	1				
		Front	Rear		

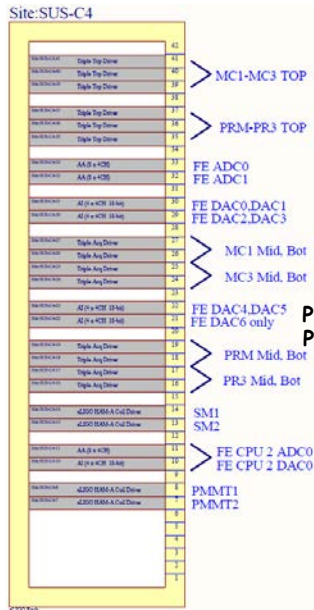
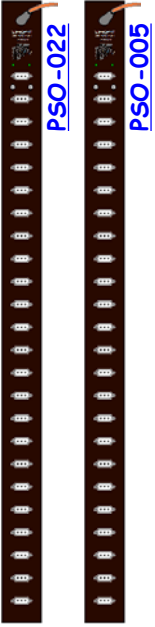

L1-SUS-C4 Details

D1001242 - S1000253



<< L1-SUS-C4

MC1-MC3 Triple Top Coil Driver Chassis

D1001242

S1000253

±18@0.5A

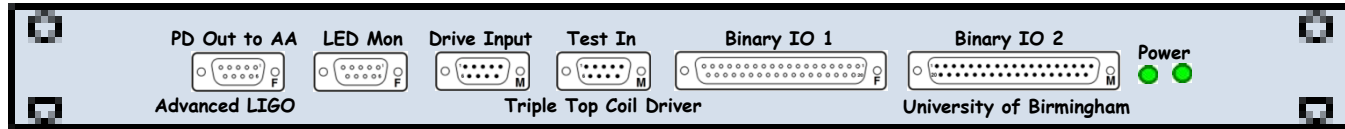

D0902747
D070480
Front

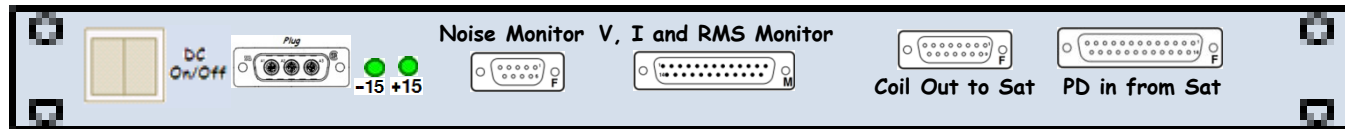
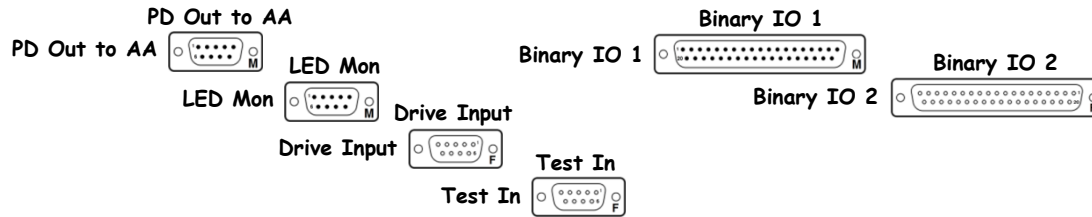

S1000253
Rear

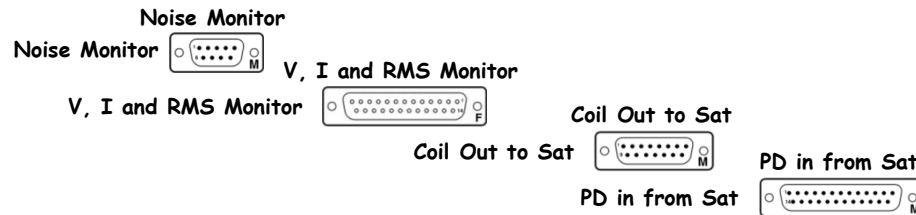

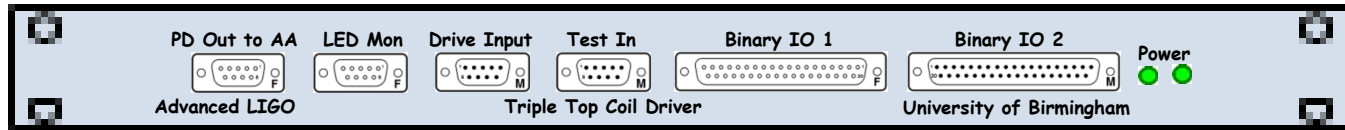

[D0902747](#)
[D070480](#)
Front

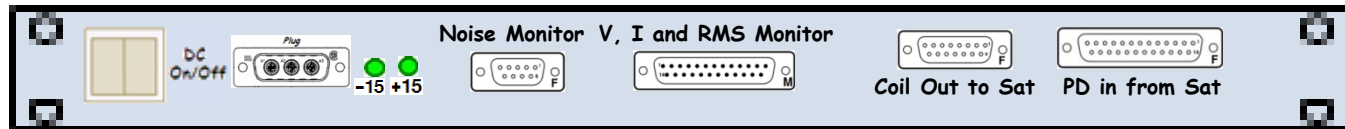
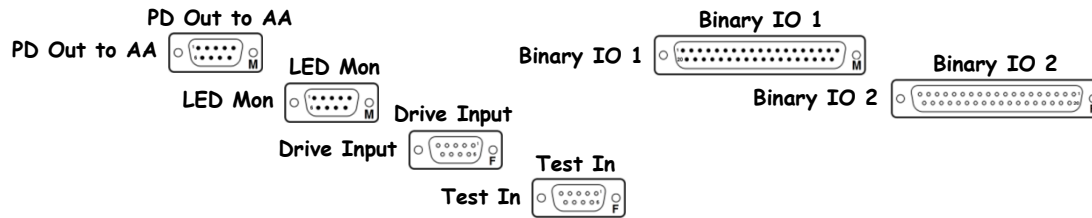

[S1000261](#)
Rear

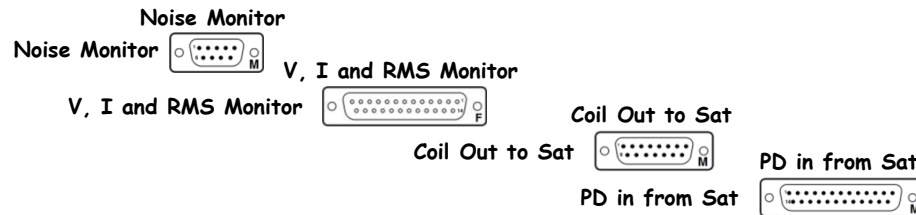

D1001242 - S1000262



<< L1-SUS-C4

MC1-MC3 Triple Top Coil Driver Chassis D1001242 S1000262 ±18@0.5A

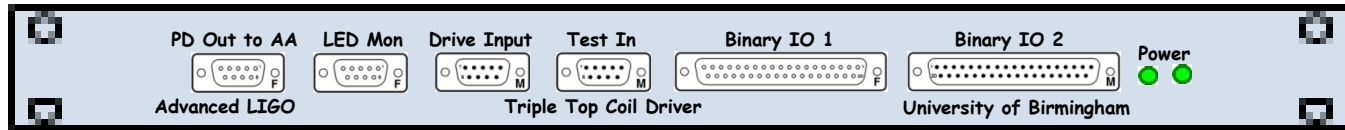

[D0902747](#)
[D070480](#)
Front

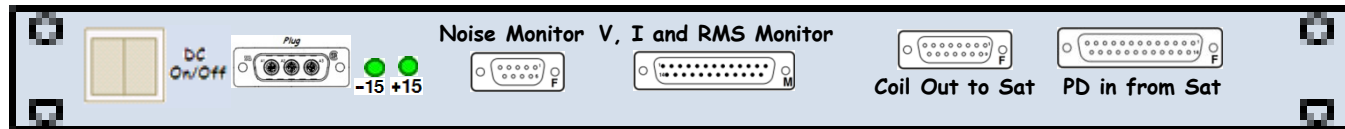
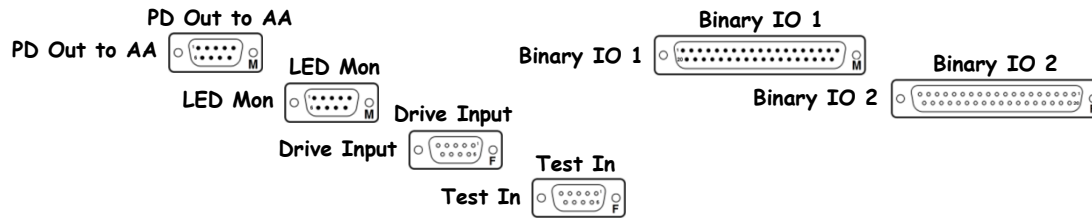

[S1000262](#)
Rear

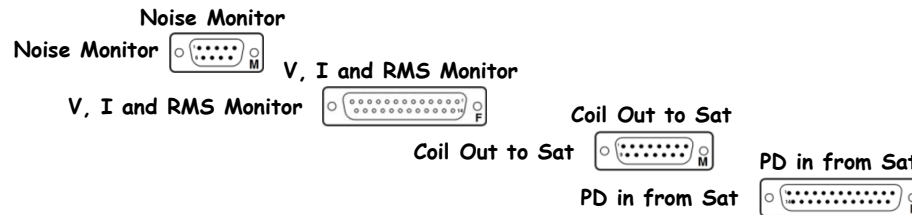

D1001242 - S1000257



<< L1-SUS-C4

PRM-PR3 Triple Top Coil Driver Chassis D1001242 S1000257 ±18@0.5A

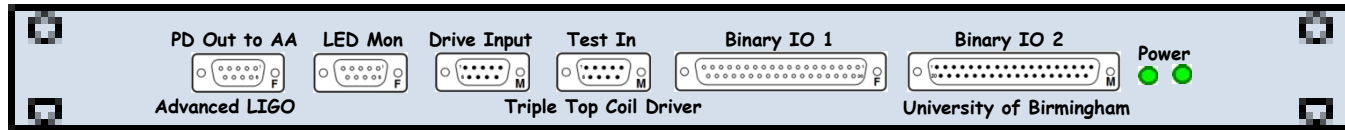

[D0902747](#)
[D070480](#)
Front

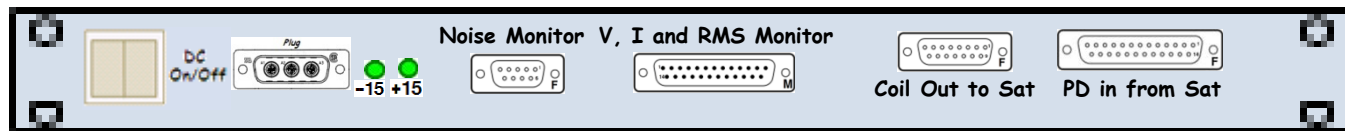
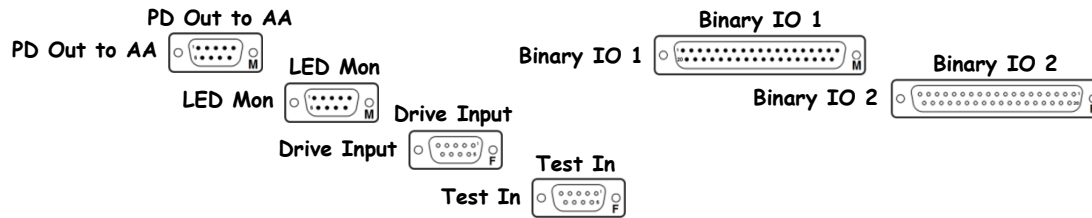

[S1000257](#)
Rear

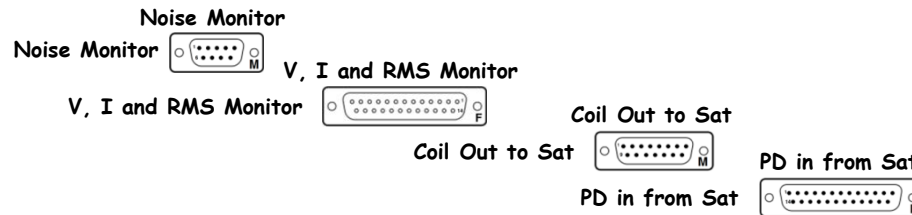

D1001242 - S1000259



<< L1-SUS-C4

PRM-PR3 Triple Top Coil Driver Chassis D1001242 S1000259 ±18@0.5A

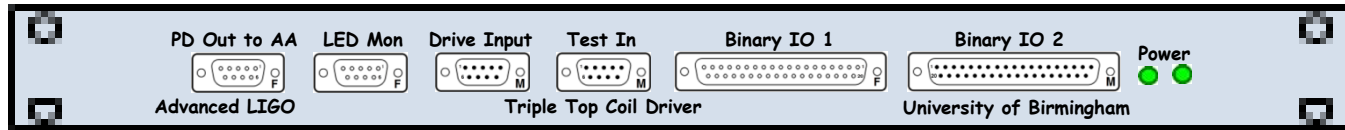

[D0902747](#)
[D070480](#)
Front

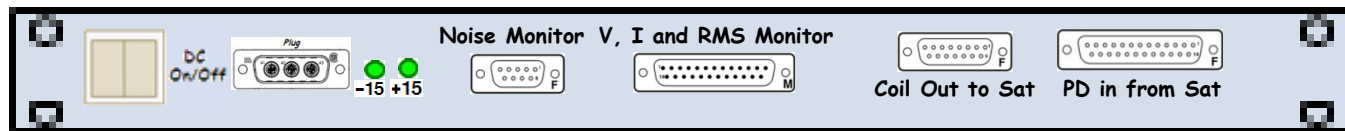
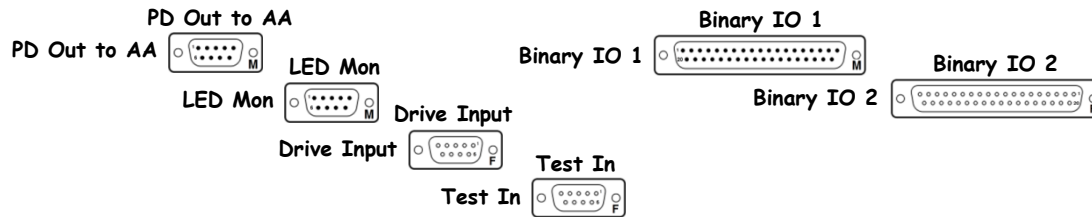

[S1000259](#)
Rear

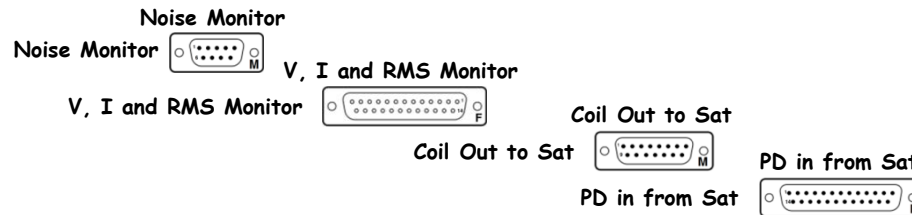

D1001242 - S1000723



<< L1-SUS-C4

PRM-PR3 Triple Top Coil Driver Chassis D1001242 S1000723 ±18@0.5A

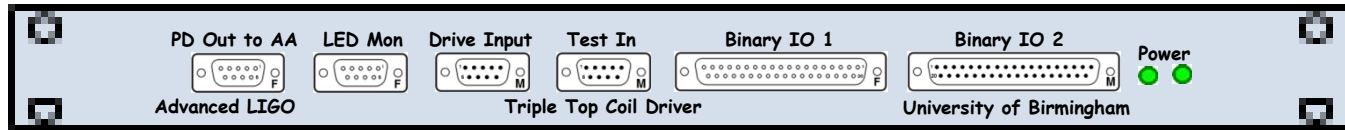

[D0902747](#)
[D070480](#)
Front

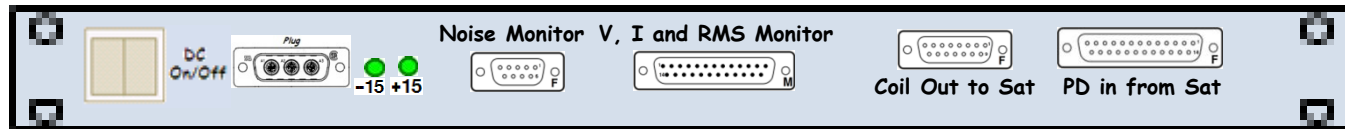
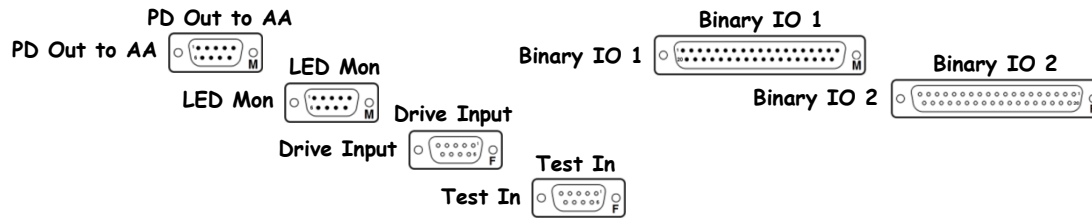

[S1000723](#)
Rear

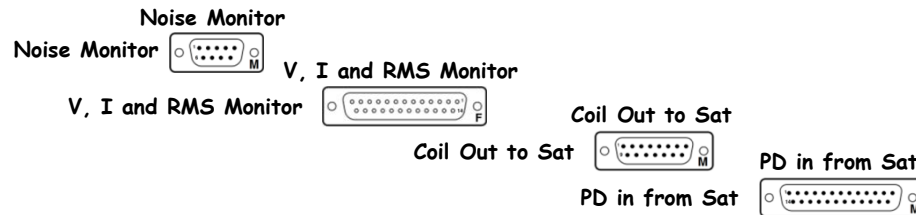

L1-SUS-C5 - S1105375

SUS ITMX, ITMY, and BS Rack 1 (of 2) Layout ([LIGO-D1100022](#)) ([S1105375](#))

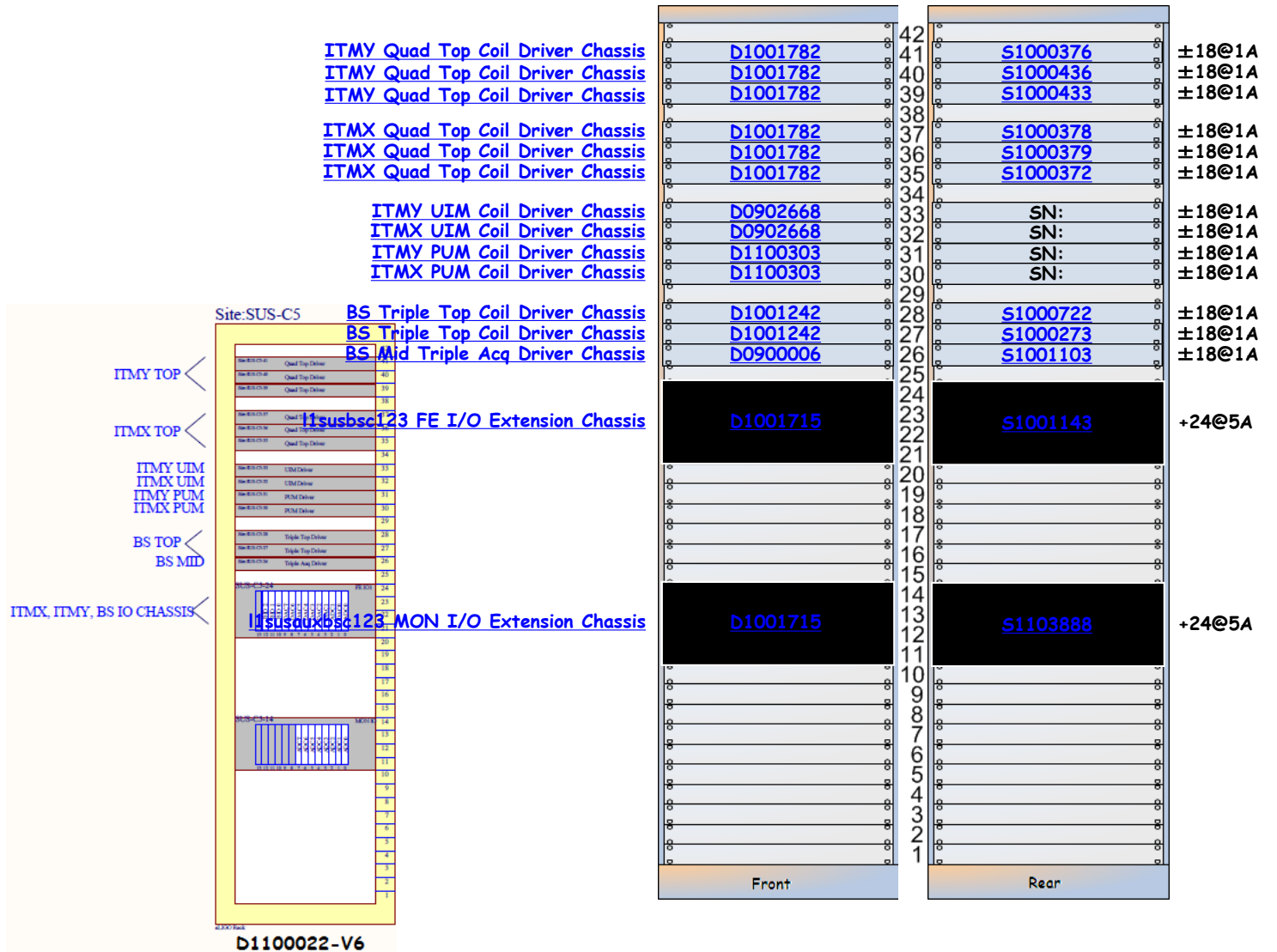

H2-SUS-C5 - S1105375

SUS ITMX, ITMY, BS, FMX, and FMY Rack 1 (of 2) Layout (LIGO-D1001725) (S1105375)

ITMY Quad Top Coil Driver Chassis
 ITMY Quad Top Coil Driver Chassis
 ITMY Quad Top Coil Driver Chassis

ITMX Quad Top Coil Driver Chassis
 ITMX Quad Top Coil Driver Chassis
 ITMX Quad Top Coil Driver Chassis

ITMY UIM Coil Driver Chassis
 ITMX UIM Coil Driver Chassis
 ITMY PUM Coil Driver Chassis
 ITMX PUM Coil Driver Chassis

ITMY TOP <
 ITMX TOP <
 ITMY UIM
 ITMX UIM
 ITMY PUM
 ITMX PUM
 BS TOP <
 BS MID <
 ITMX, ITMY, BS IO CHASSIS <
 FMX, FMY IO CHASSIS
 ITM and BS Opt Levers <
 FMY TOP <
 FMY MID <
 FMX TOP <
 FMX MID <

Site: SUS-C5

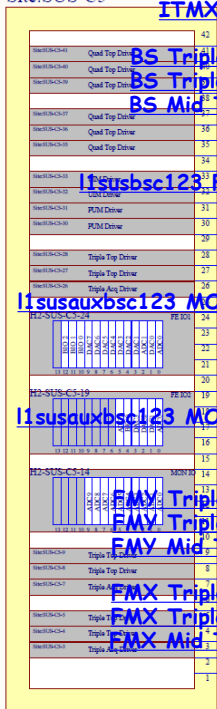

D1001725-v7

42					
41	D1001782		S1000376		±18@1A
40	D1001782		S1000436		±18@1A
39	D1001782		S1000433		±18@1A
38					
37	D1001782		S1000378		±18@1A
36	D1001782		S1000379		±18@1A
35	D1001782		S1000372		±18@1A
34					
33	D0902668		SN:		±18@1A
32	D0902668		SN:		±18@1A
31	D1100303		SN:		±18@1A
30	D1100303		SN:		±18@1A
29					
28	D1001242		S1000722		±18@1A
27	D1001242		S1000273		±18@1A
26	D0900006		S1001103		±18@1A
25					
24					
23	D1001715		S1001143		+24@5A
22					
21					
20					
19					
18	D1001715		S1103888		+24@5A
17					
16					
15					
14	D1001715		S1103888		+24@5A
13					
12					
11					
10					
9	D1001242		S1000722		±18@1A
8	D1001242		S1000273		±18@1A
7	D0900006		S1001103		±18@1A
6					
5	D1001242		S1000722		±18@1A
4	D1001242		S1000273		±18@1A
3	D0900006		S1001103		±18@1A
2					
1					
	Front		Rear		

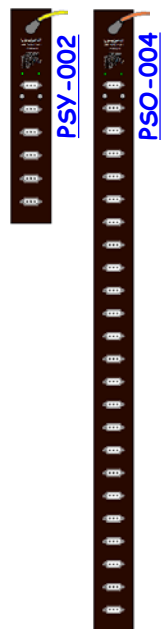

+18VDC	13A
-18VDC	13A
+24VDC	15A

L1-SUS-C5 Details

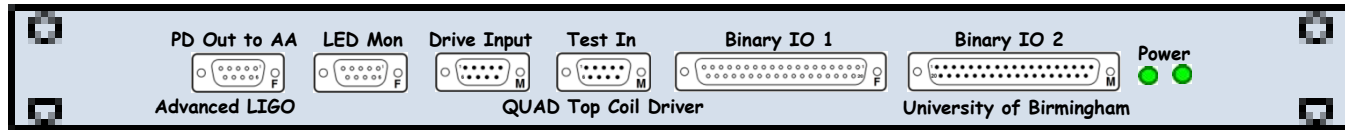

[D0902747](#)
[D070480](#)
Front

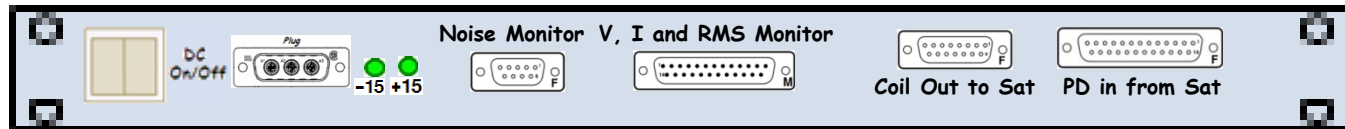
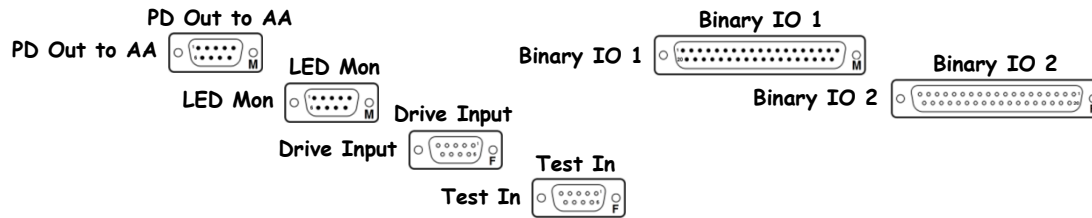

[S1000376](#)
Rear

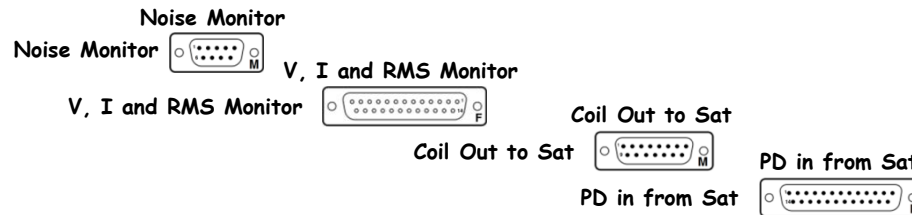

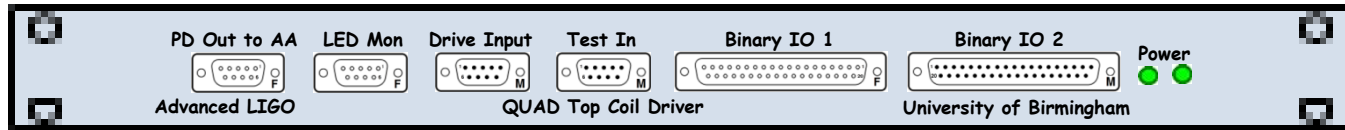

[D0902747](#)
[D070480](#)
 Front

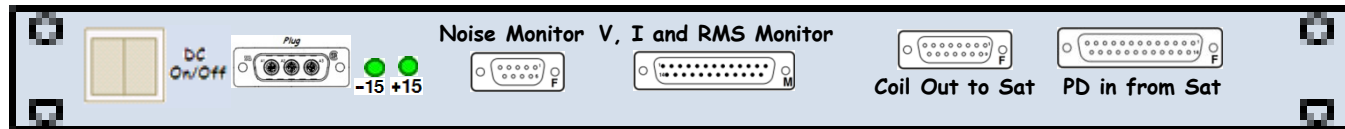
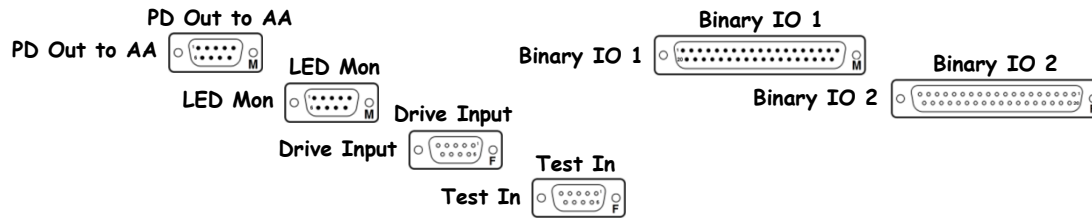

[S1000376](#)
 Rear

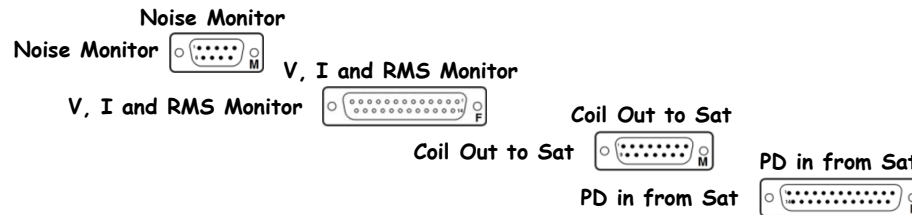

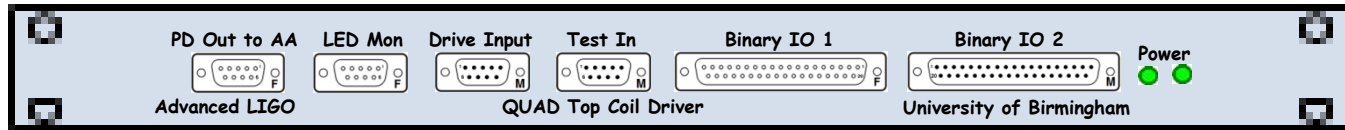

[D0902747](#)
[D070480](#)
Front

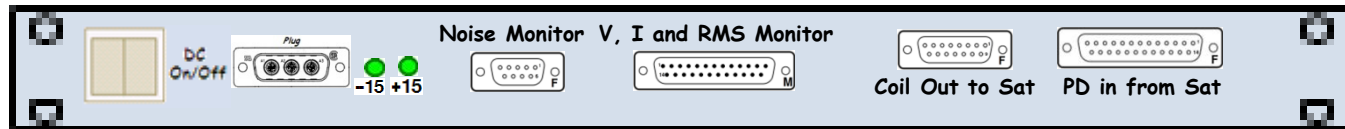
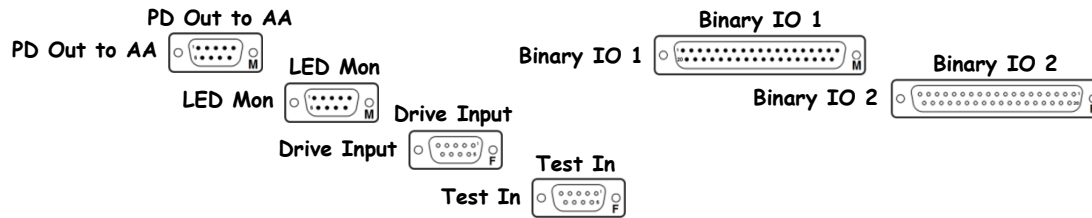

[S1000376](#)
Rear

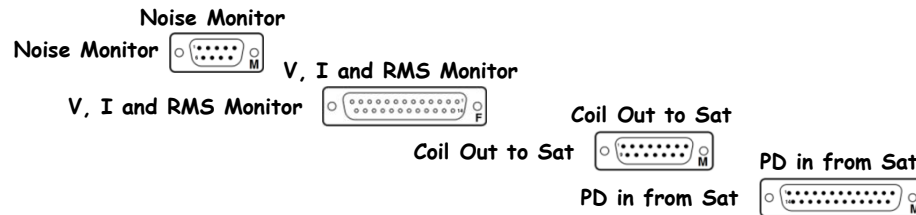

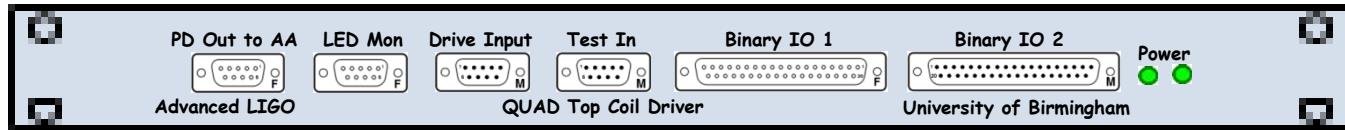

[D0902747](#)
[D070480](#)
 Front

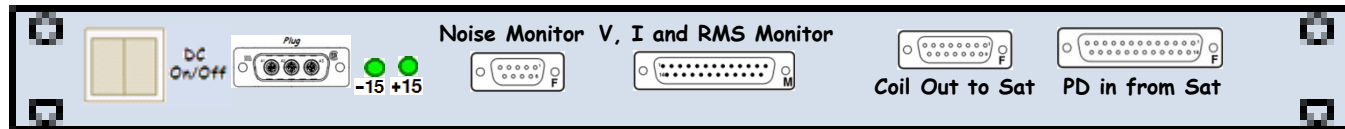
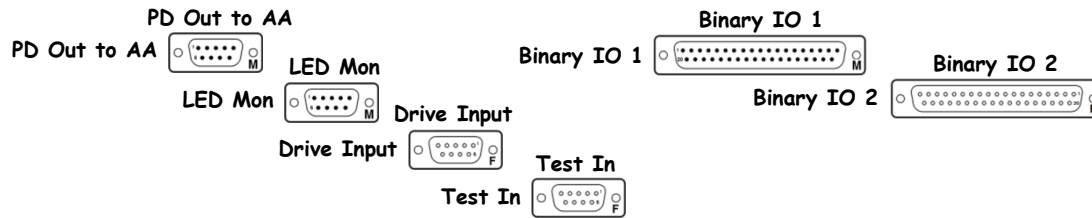

[S1000376](#)
 Rear

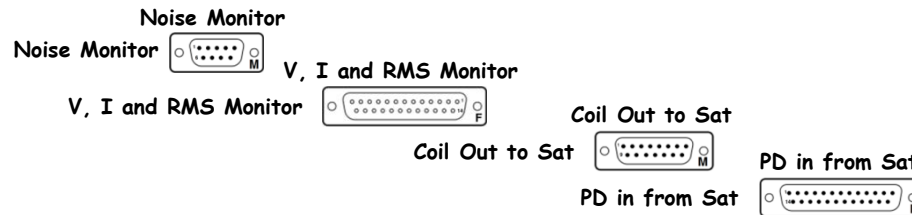

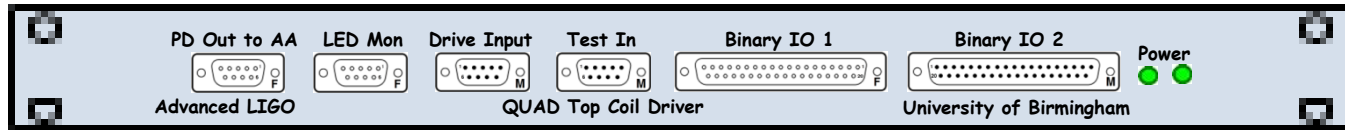

[D0902747](#)
[D070480](#)
Front

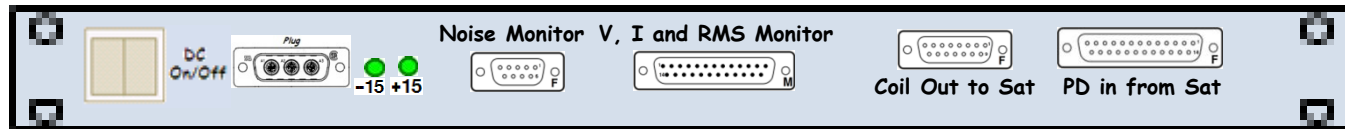
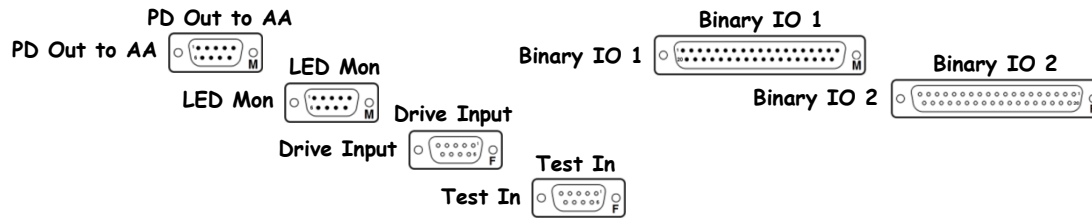

[S1000376](#)
Rear

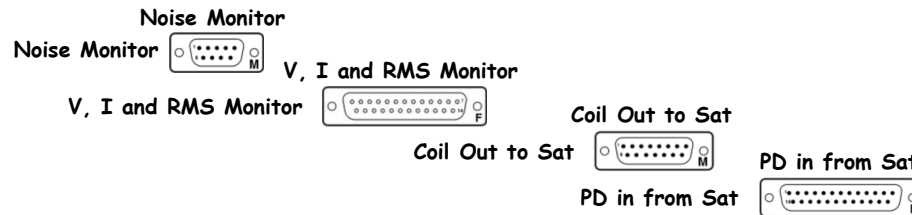

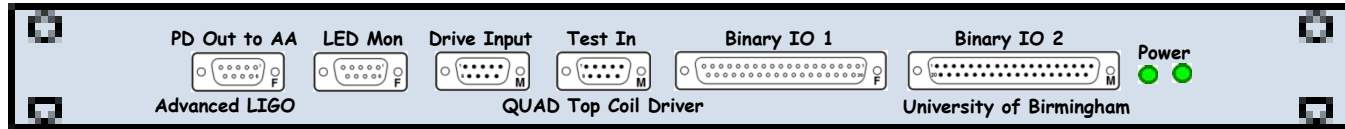

[D0902747](#)
[D070480](#)
Front

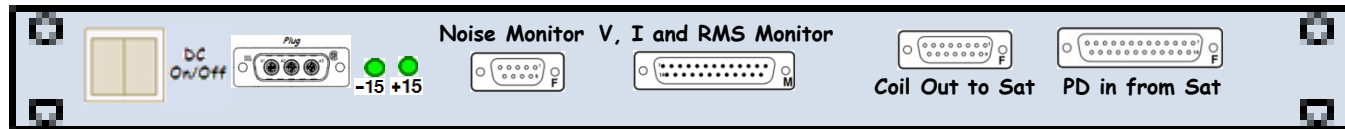
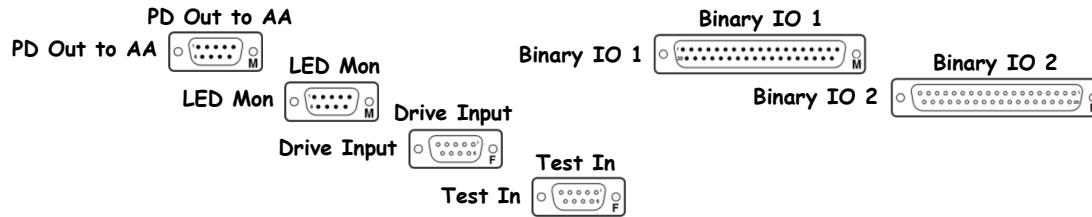

[S1000376](#)
Rear

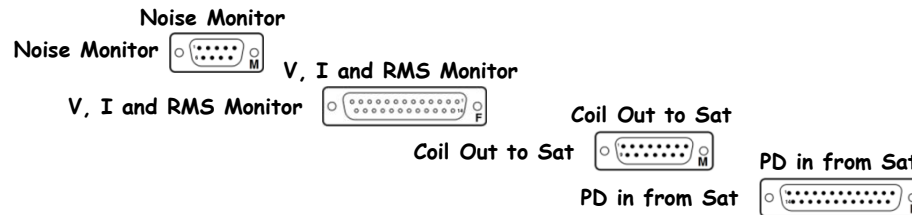

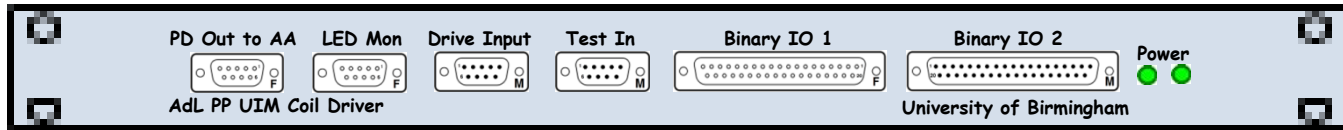

[D070481](#)
[D070480](#)
Front

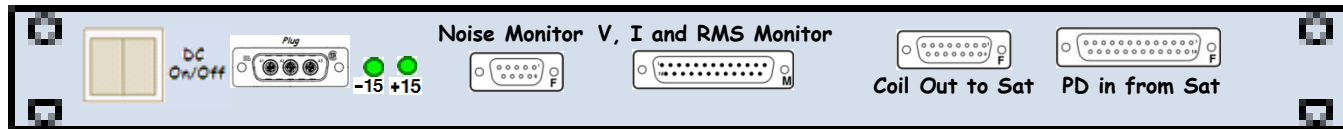
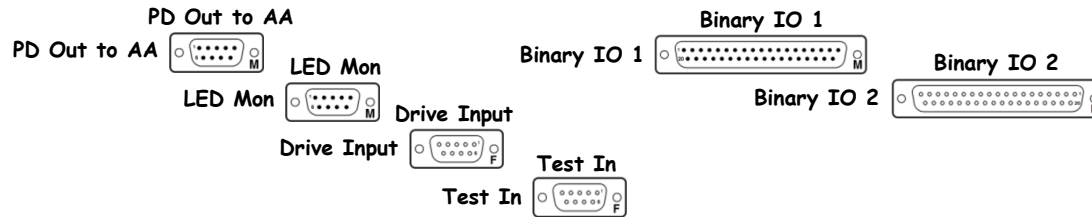

[S1000376](#)
Rear

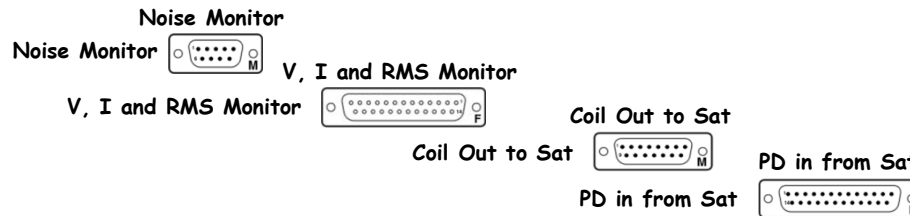

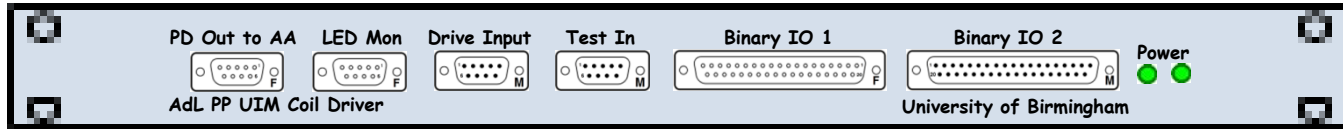

[D070481](#)
[D070480](#)
Front

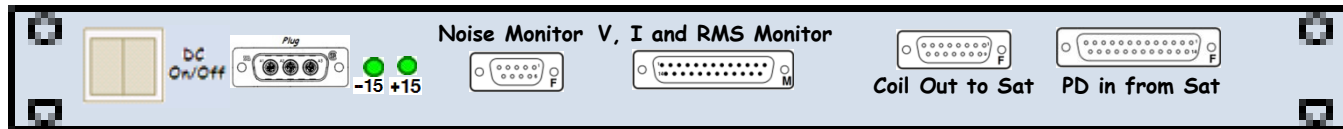
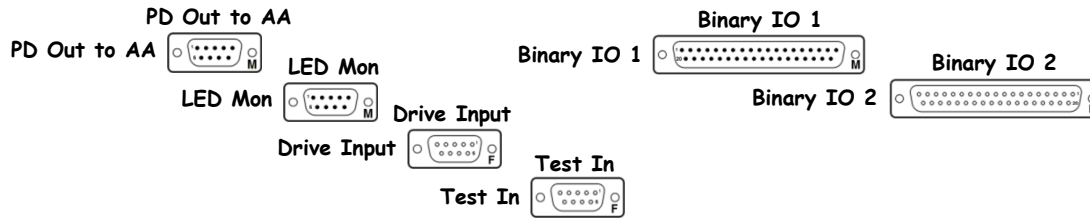

[S1000376](#)
Rear

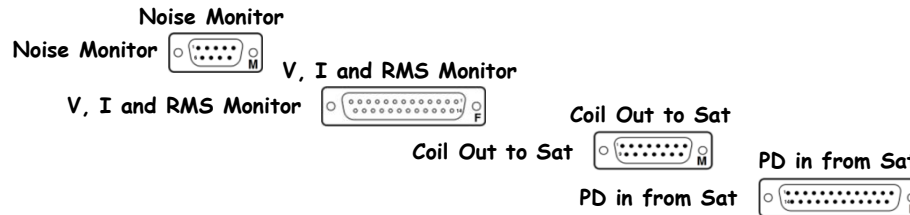

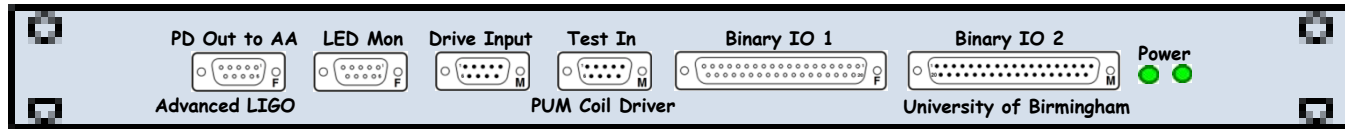

[D070483](#)
[D070480](#)
Front

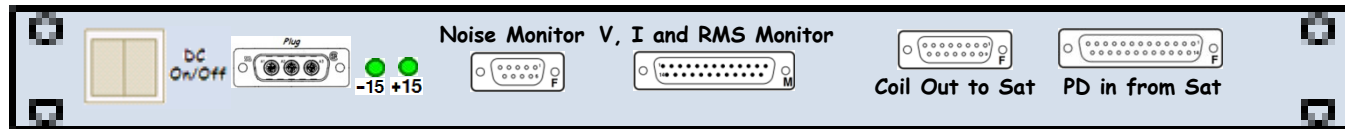
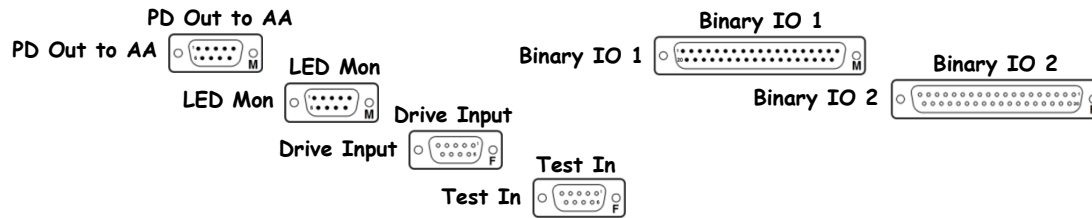

SN:
Rear

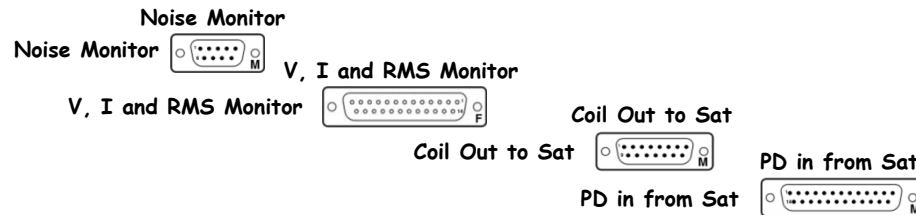

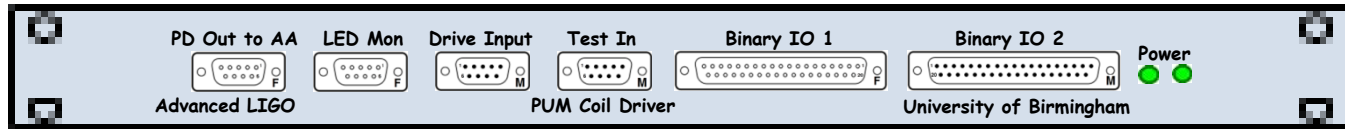

[D070483](#)
[D070480](#)
Front

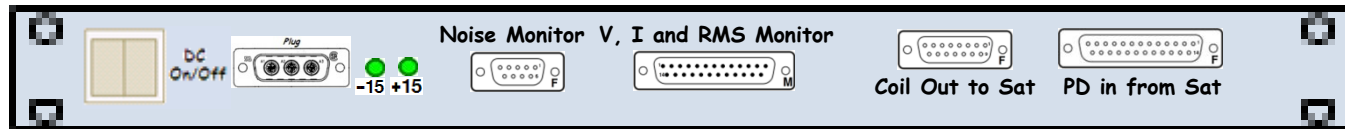
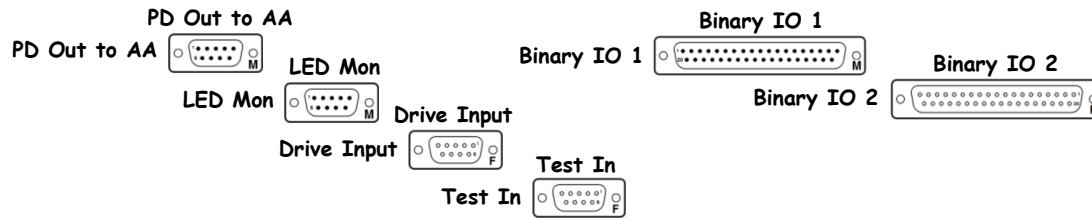

SN:
Rear

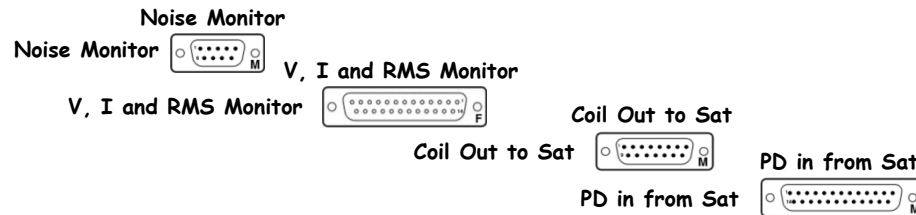

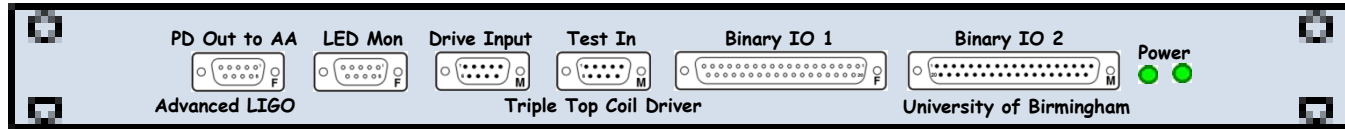

[D0902747](#)
[D070480](#)
Front

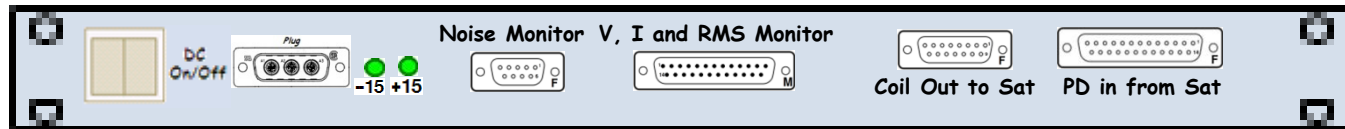
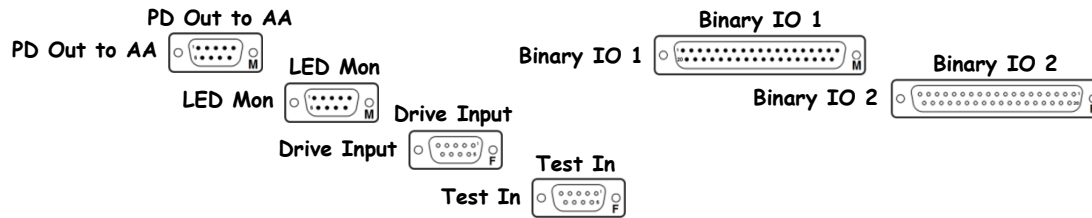

[S1000722](#)
Rear

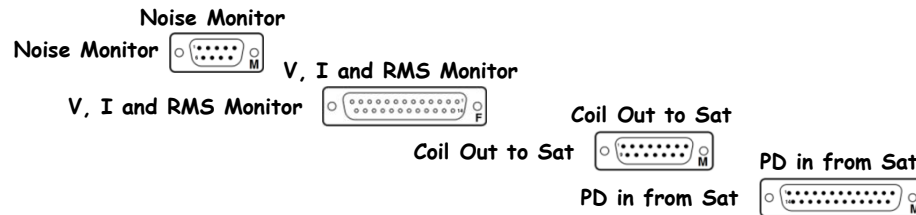

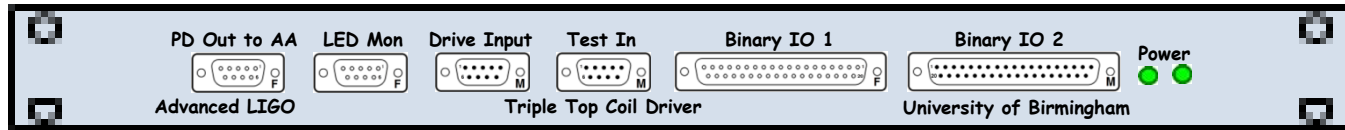

[D0902747](#)
[D070480](#)
Front

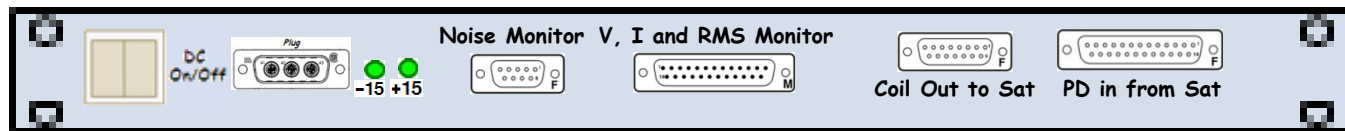
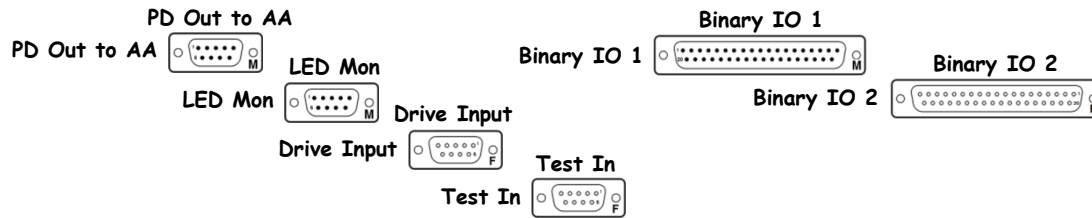

[S1000273](#)
Rear

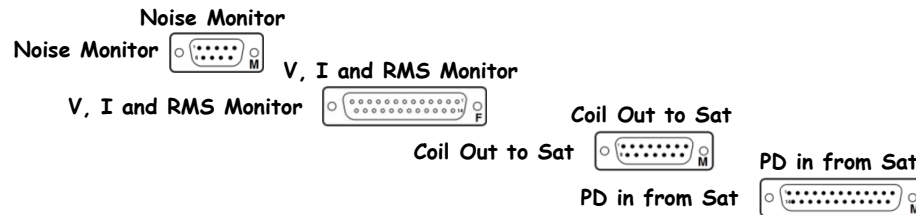

This number is actually correct. The DocDB part number is erroneously D090006 because it got assigned before the Wizards decided there would be 5 digits, and they won't fix it. I've asked.

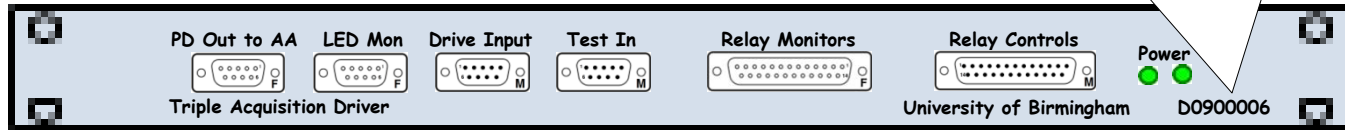

[D0901047](#)
[D070480](#)
Front

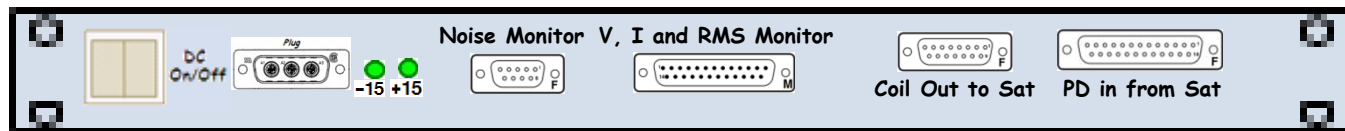
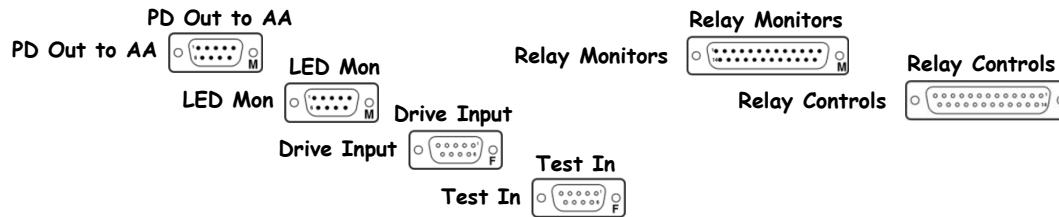

[S1001103](#)
Rear

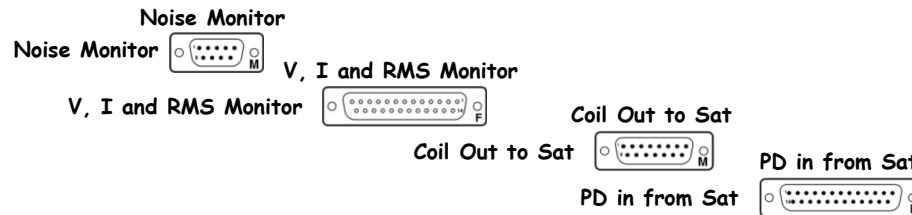



D1001715
Front

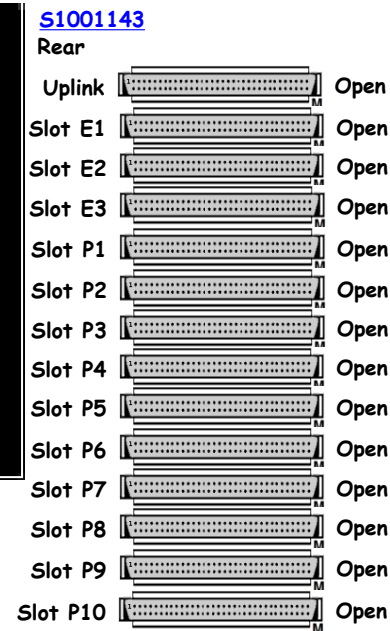
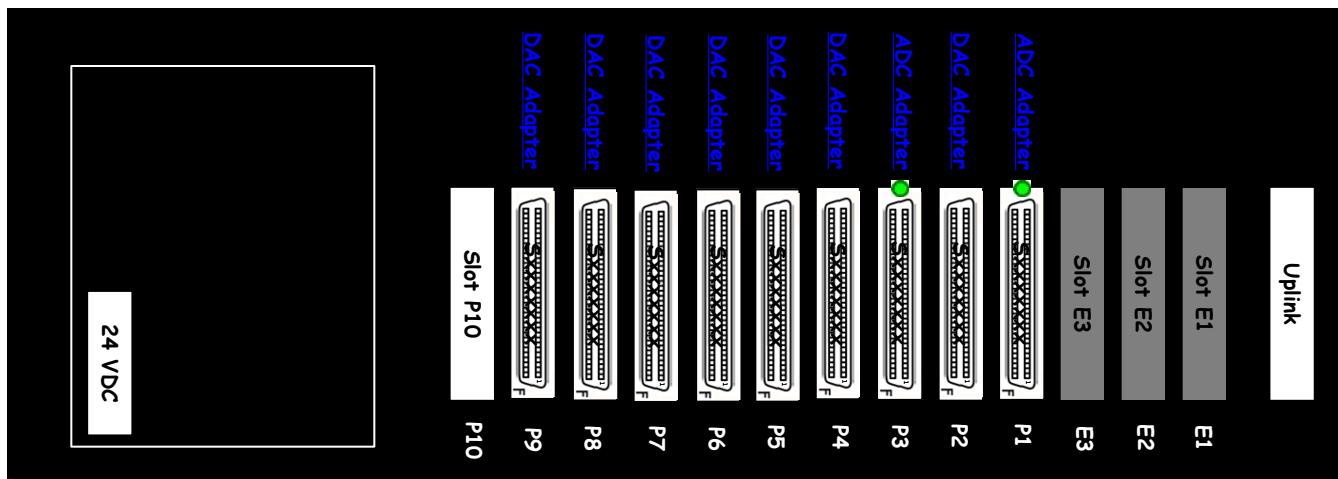



D1001715

Front

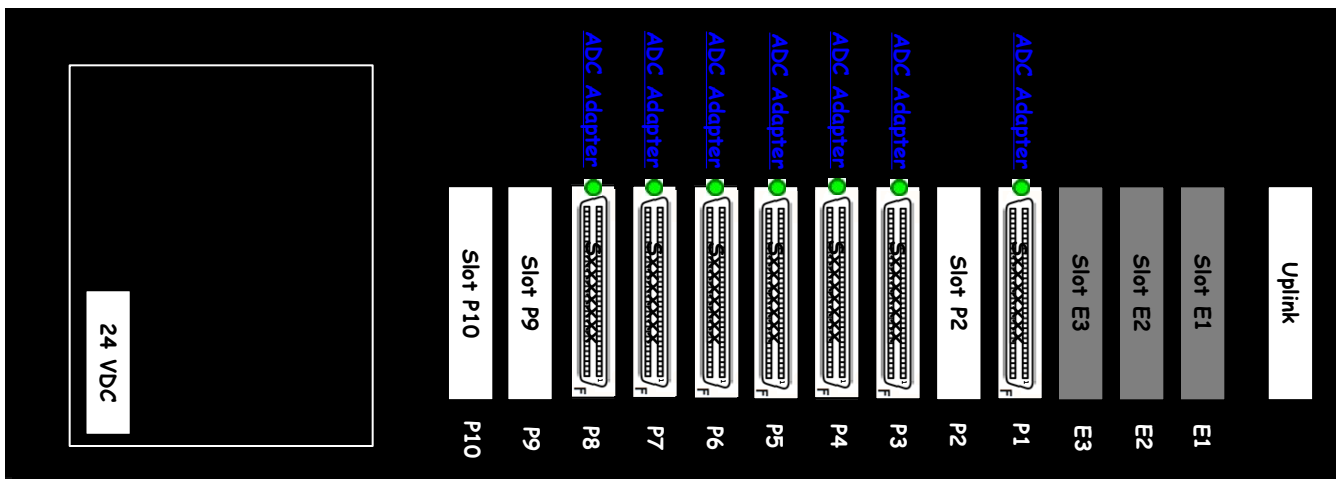

S1103888

Rear

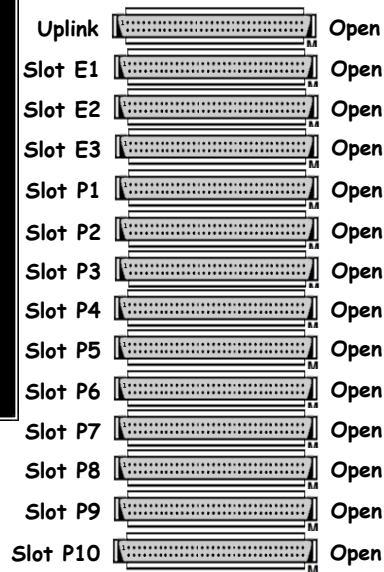

L1-SUS-C6 - S1105376

SUS ITMX, ITMY, and BS Rack 2 (of 2) Layout ([LIGO-D1100022](#)) ([S1105376](#))

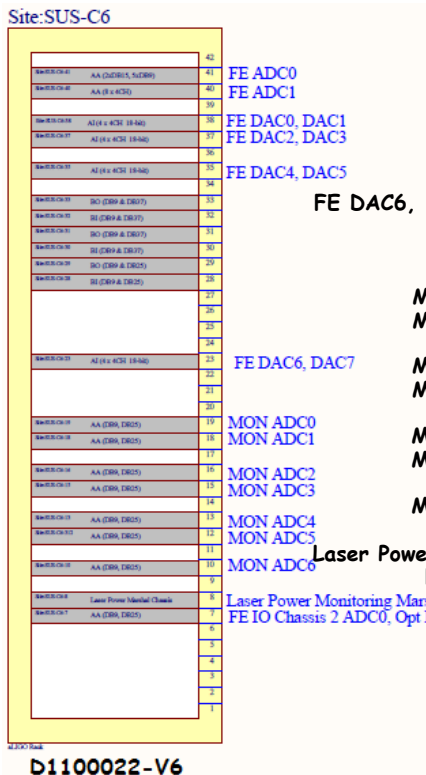

FE ADC0 Anti-Alias Chassis
 FE ADC1 Anti-Alias Chassis
 FE DAC0, FE DAC1 Anti-Image Chassis
 FE DAC2, FE DAC3 Anti-Image Chassis
 FE DAC4, FE DAC5 Anti-Image Chassis
 Binary Output Chassis
 Binary Input Chassis
 Binary Output Chassis
 Binary Input Chassis
 Binary Output Chassis
 Binary Input Chassis

FE DAC6, FE DAC7 Anti-Image Chassis

MON ADC0 Anti-Alias Chassis
 MON ADC1 Anti-Alias Chassis
 MON ADC2 Anti-Alias Chassis
 MON ADC3 Anti-Alias Chassis
 MON ADC4 Anti-Alias Chassis
 MON ADC5 Anti-Alias Chassis
 MON ADC6 Anti-Alias Chassis

Laser Power Monitor Marshaling Chassis
 FE2 ADC0 Anti-Alias Chassis
 Laser Power Monitoring Marshaling Chassis
 FE IO Chassis 2 ADC0, Opt Lever Signals

		42			
	Dxxxxxxx	41	SN:		±18@1A
	Dxxxxxxx	40	SN:		±18@1A
		39			
	Dxxxxxxx	38	SN:		±18@1A
	Dxxxxxxx	37	SN:		±18@1A
		36			
	Dxxxxxxx	35	SN:		±18@1A
		34			
	Dxxxxxxx	33	SN:		±18@0.5A
	Dxxxxxxx	32	SN:		±18@0.5A
	Dxxxxxxx	31	SN:		±18@0.5A
	Dxxxxxxx	30	SN:		±18@0.5A
	Dxxxxxxx	29	SN:		±18@0.5A
	Dxxxxxxx	28	SN:		±18@0.5A
		27			
		26			
		25			
		24			
	Dxxxxxxx	23	SN:		±18@1A
		22			
		21			
		20	SN:		±18@1A
	Dxxxxxxx	19	SN:		±18@1A
	Dxxxxxxx	18	SN:		±18@1A
		17			
	Dxxxxxxx	16	SN:		±18@1A
	Dxxxxxxx	15	SN:		±18@1A
		14			
	Dxxxxxxx	13	SN:		±18@1A
	Dxxxxxxx	12	SN:		±18@1A
		11			
	Dxxxxxxx	10	SN:		±18@1A
		9			
	Dxxxxxxx	8	SN:		±18@1A
	Dxxxxxxx	7	SN:		±18@1A
		6			
		5			
		4			
		3			
		2			
		1			
Front			Rear		

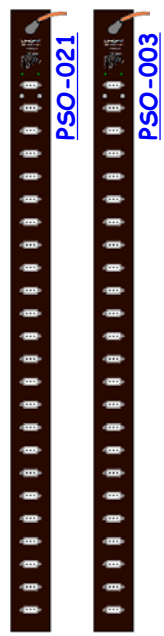

Site:SUS-C6

42	
41	AA (2xDB1, 1xDB9)
40	AA (8 x 4CR)
39	
38	AI (4 x 4CH 18-46)
37	AI (4 x 4CH 18-46)
36	
35	AI (4 x 4CH 18-46)
34	
33	BO (DB9 & DB17)
32	BI (DB9 & DB17)
31	BO (DB9 & DB17)
30	BI (DB9 & DB17)
29	BO (DB9 & DB17)
28	BI (DB9 & DB17)
27	BO (4xDB6, 2xDB17)
26	BI (4xDB6, 2xDB17)
25	
24	AA (8 x 4CR)
23	AI (2xDB1, 1xDB9 18-46)
22	
21	AI (4 x 4CH 18-46)
20	AI (4 x 4CH 18-46)
19	
18	AA (DB9, DB17)
17	AA (DB9, DB17)
16	
15	AA (DB9, DB17)
14	AA (DB9, DB17)
13	
12	AA (DB9, DB17)
11	AA (DB9, DB17)
10	
9	AA (DB9, DB17)
8	AA (DB9, DB17)
7	
6	AA (DB9, DB17)
5	AA (DB9, DB17)
4	AA (DB9, DB17)
3	Laser Power Monitor Chassis
2	AA (8 x 4CR)
1	

- FE ADC0 Anti-Alias Chassis
- FE ADC1 Anti-Alias Chassis
- FE DAC0, FE DAC1 Anti-Image Chassis
- FE DAC2, FE DAC3 Anti-Image Chassis
- FE DAC4, FE DAC5 Anti-Image Chassis
- FM FE ADC0 Anti-Alias Chassis
- FE DAC6, FE DAC7 Anti-Image Chassis
- FE DAC8, FE DAC9 Anti-Image Chassis
- FE DAC10 Anti-Image Chassis
- MON ADC0 Anti-Alias Chassis
- MON ADC1 Anti-Alias Chassis
- MON ADC2 Anti-Alias Chassis
- MON ADC3 Anti-Alias Chassis
- MON ADC4 Anti-Alias Chassis
- MON ADC5 Anti-Alias Chassis
- MON ADC6 Anti-Alias Chassis
- MON ADC7 Anti-Alias Chassis
- MON ADC8 Anti-Alias Chassis
- MON ADC9 Anti-Alias Chassis
- Laser Power Monitor Marshaling Chassis
- FM FE ADC1 Anti-Alias Chassis

42			
41	Dxxxxxxx	SN:	±18@1A
40	Dxxxxxxx	SN:	±18@1A
39			
38	Dxxxxxxx	SN:	±18@1A
37	Dxxxxxxx	SN:	±18@1A
36			
35	Dxxxxxxx	SN:	±18@1A
34			
33	Dxxxxxxx	SN:	±18@0.5A
32	Dxxxxxxx	SN:	±18@0.5A
31	Dxxxxxxx	SN:	±18@0.5A
30	Dxxxxxxx	SN:	±18@0.5A
29	Dxxxxxxx	SN:	±18@0.5A
28	Dxxxxxxx	SN:	±18@0.5A
27	Dxxxxxxx	SN:	±18@0.5A
26	Dxxxxxxx	SN:	±18@0.5A
25			
24	Dxxxxxxx	SN:	±18@1A
23	Dxxxxxxx	SN:	±18@1A
22			
21	Dxxxxxxx	SN:	±18@1A
20	Dxxxxxxx	SN:	±18@1A
19			
18	Dxxxxxxx	SN:	±18@1A
17	Dxxxxxxx	SN:	±18@1A
16			
15	Dxxxxxxx	SN:	±18@1A
14	Dxxxxxxx	SN:	±18@1A
13			
12	Dxxxxxxx	SN:	±18@1A
11	Dxxxxxxx	SN:	±18@1A
10			
9	Dxxxxxxx	SN:	±18@1A
8	Dxxxxxxx	SN:	±18@1A
7			
6	Dxxxxxxx	SN:	±18@1A
5	Dxxxxxxx	SN:	±18@1A
4	Dxxxxxxx	SN:	±18@1A
3	Dxxxxxxx	SN:	±18@1A
2			
1			

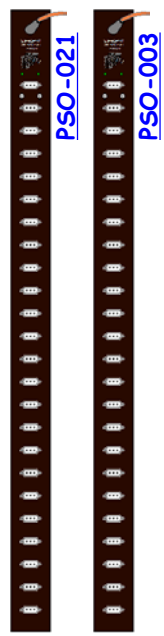

L1-SUS-C6 Details

SR3-SRM Triple Top Coil Driver Chassis
 SR3-SRM Triple Top Coil Driver Chassis
 SR3-SRM Triple Top Coil Driver Chassis

OMC Triple Top Coil Driver Chassis
 OMC Triple Top Coil Driver Chassis

FE ADC0 Anti-Alias Chassis
 FE ADC1 Anti-Alias Chassis

[FE DAC0, FE DAC1 Anti-Image Chassis](#)
[FE DAC2, FE DAC3 Anti-Image Chassis](#)

SR3 Mid Triple Acq Driver Chassis
 SR3 Bot Triple Acq Driver Chassis
 SRM Mid Triple Acq Driver Chassis

[FE DAC4 Anti-Image Chassis](#)

SRM Bot Triple Acq Driver Chassis

Binary Output Chassis
 Binary Input Chassis
 Binary Output Chassis
 Binary Input Chassis

	42			
D1001242	41	SN:	±18@1A	
D1001242	40	SN:	±18@1A	
D1001242	39	SN:	±18@1A	
	38			
D1001242	37	SN:	±18@1A	
D1001242	36	SN:	±18@1A	
	35			
Dxxxxxxx	34	SN:	±18@1A	
Dxxxxxxx	33	SN:	±18@1A	
	32			
D1003224	31	SN:	±18@0.5A	
D1003224	30	SN:	±18@0.5A	
	29			
D0900006	28	SN:	±18@1A	
D0900006	27	SN:	±18@1A	
D0900006	26	SN:	±18@1A	
	25			
D1003224	24	SN:	±18@0.5A	
	23			
D0900006	22	SN:	±18@1A	
	21			
Dxxxxxxx	20	SN:	±18@0.5A	
Dxxxxxxx	19	SN:	±18@0.5A	
Dxxxxxxx	18	SN:	±18@0.5A	
Dxxxxxxx	17	SN:	±18@0.5A	
	16			
	15			
	14			
	13			
	12			
	11			
	10			
	9			
	8			
	7			
	6			
	5			
	4			
	3			
	2			
	1			
Front		Rear		

+18VDC	14.5A
-18VDC	14.5A



L1-SUS-C7 Details

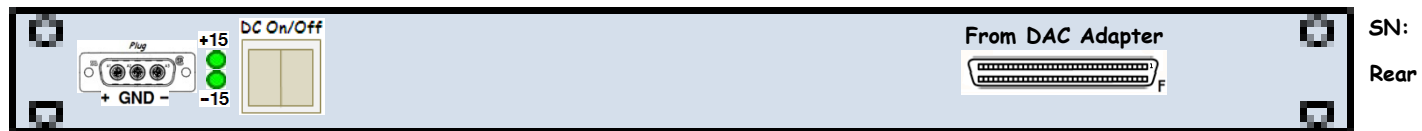
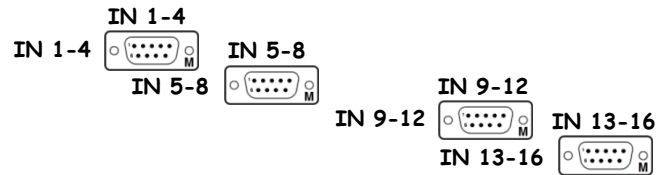
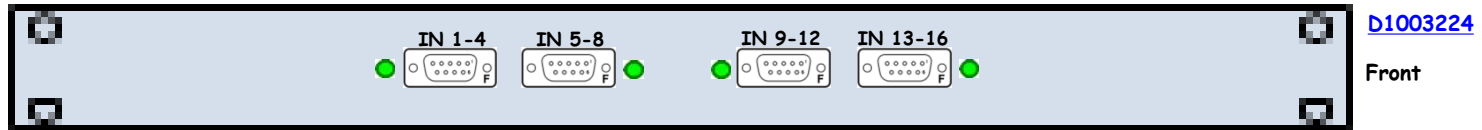

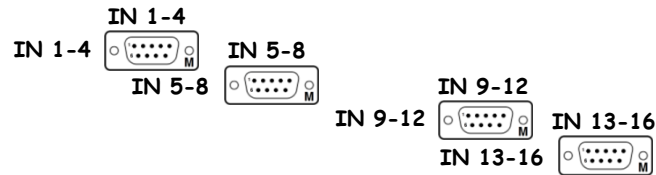
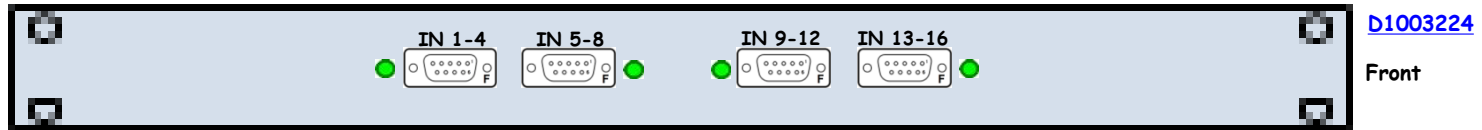

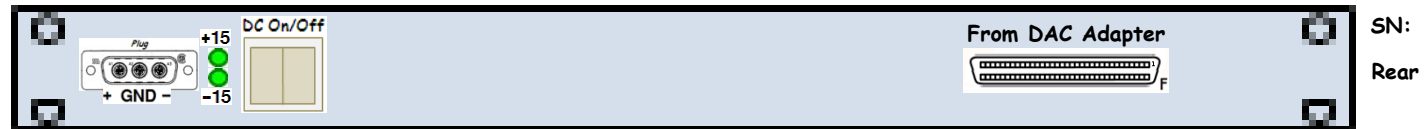
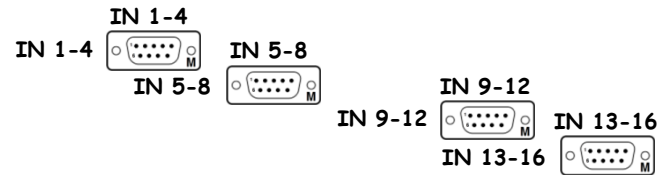
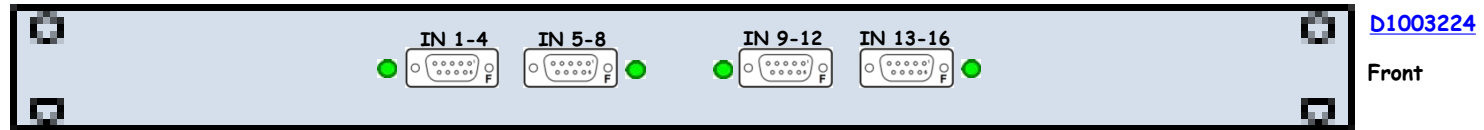

MON ADC0 Anti-Alias Chassis
 MON ADC1 Anti-Alias Chassis
 MON ADC2 Anti-Alias Chassis
 MON ADC3 Anti-Alias Chassis
 MON ADC4 Anti-Alias Chassis

[I1susauxham5-6 MON I/O Extension Chassis](#)

[I1susham5-6 FE I/O Extension Chassis](#)

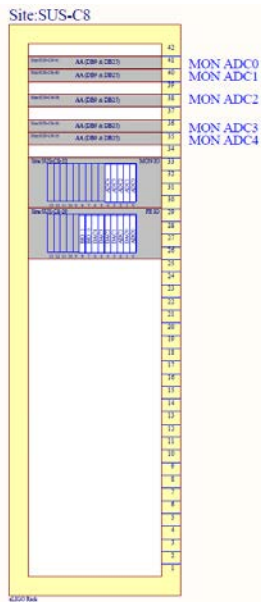
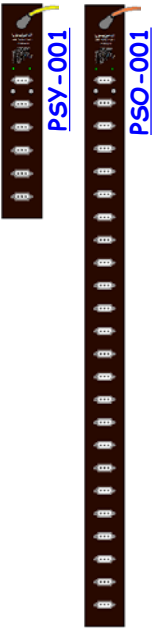
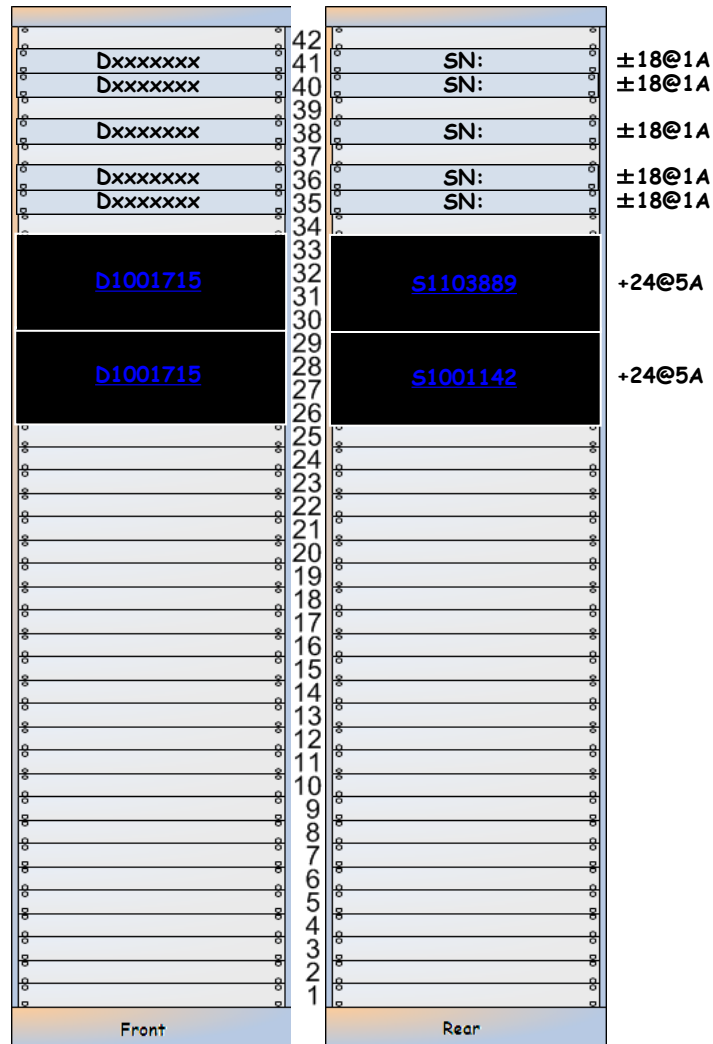

L1-SUS-C8 Details



D1001715

Front

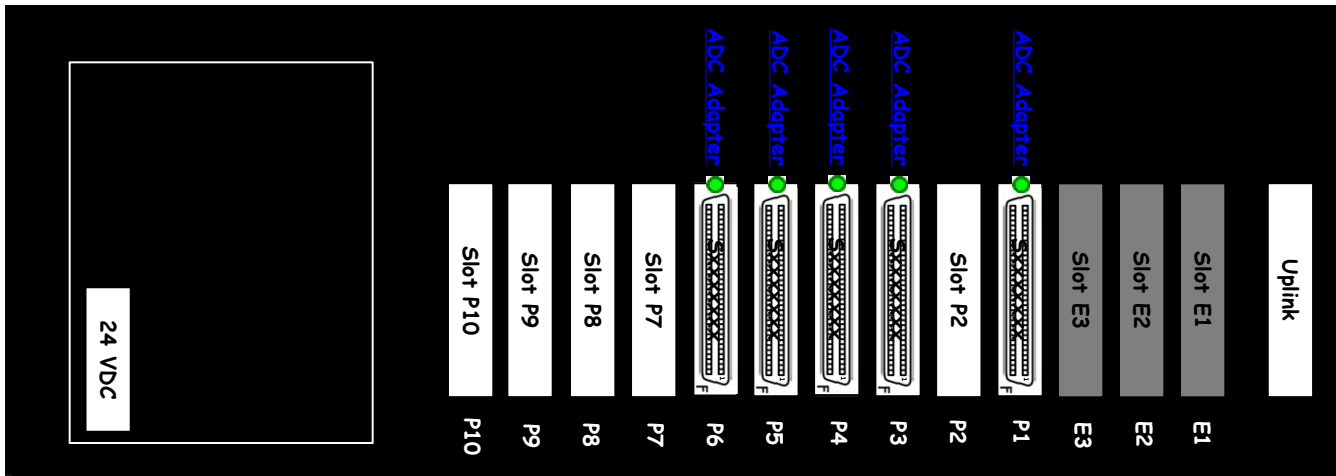

S1103889

Rear

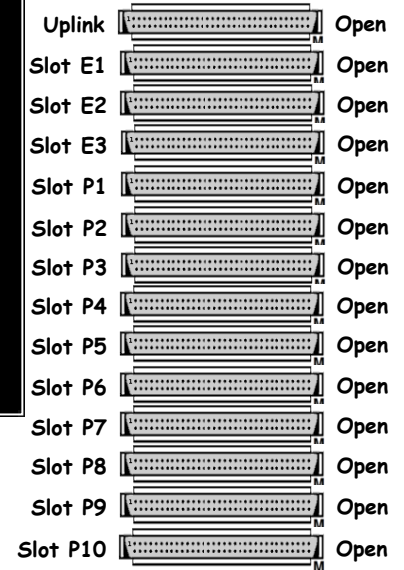

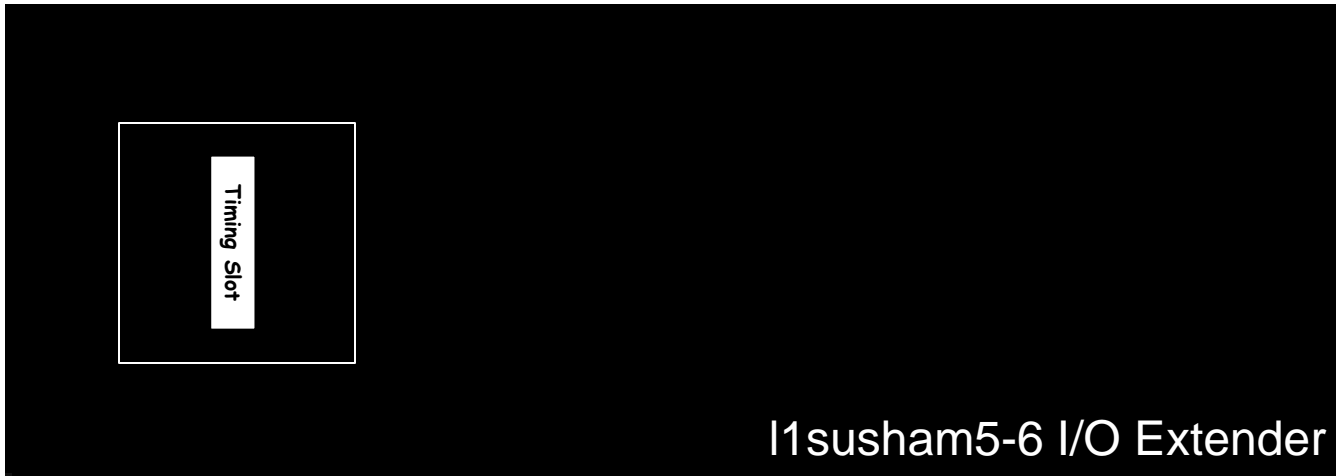

D1001715

Front

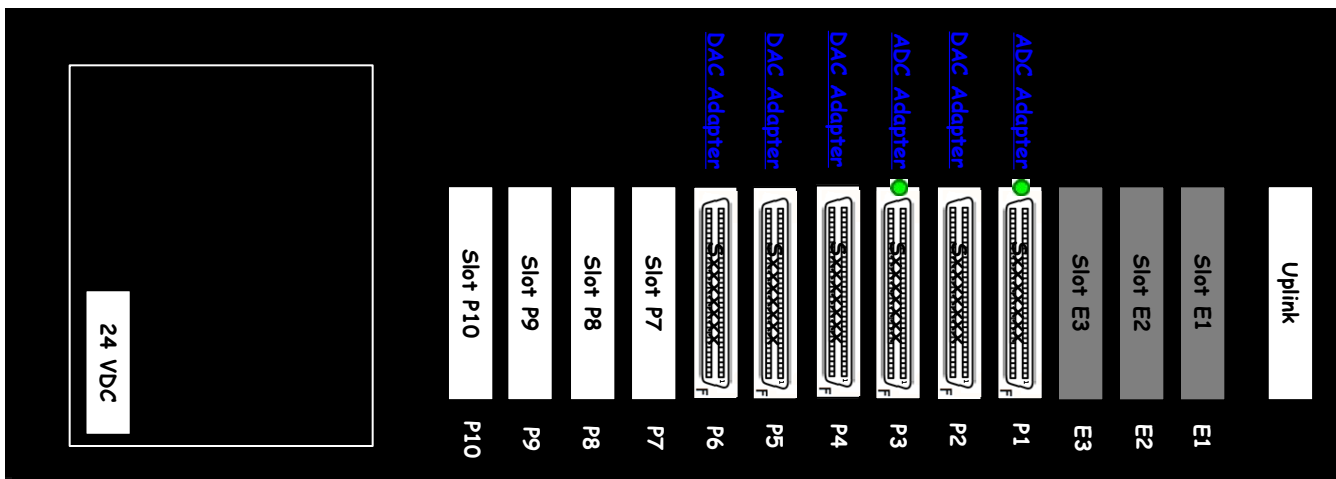

S1001142

Rear

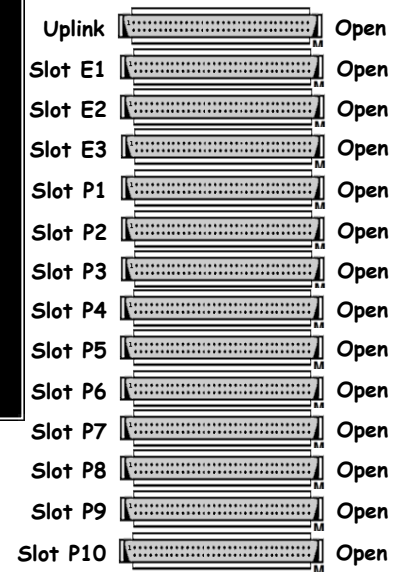

[<< LLO Corner Station](#)

[<< LLO Racks by AREA](#)

[<< LLO CDS Components](#)

LVEA

17 Field Racks are in the LVEA, including the Vacuum Racks.
See [LIGO-D1003141](#)) at LLO and [LIGO-D1002704](#) at LHO.

LVEA Access Points

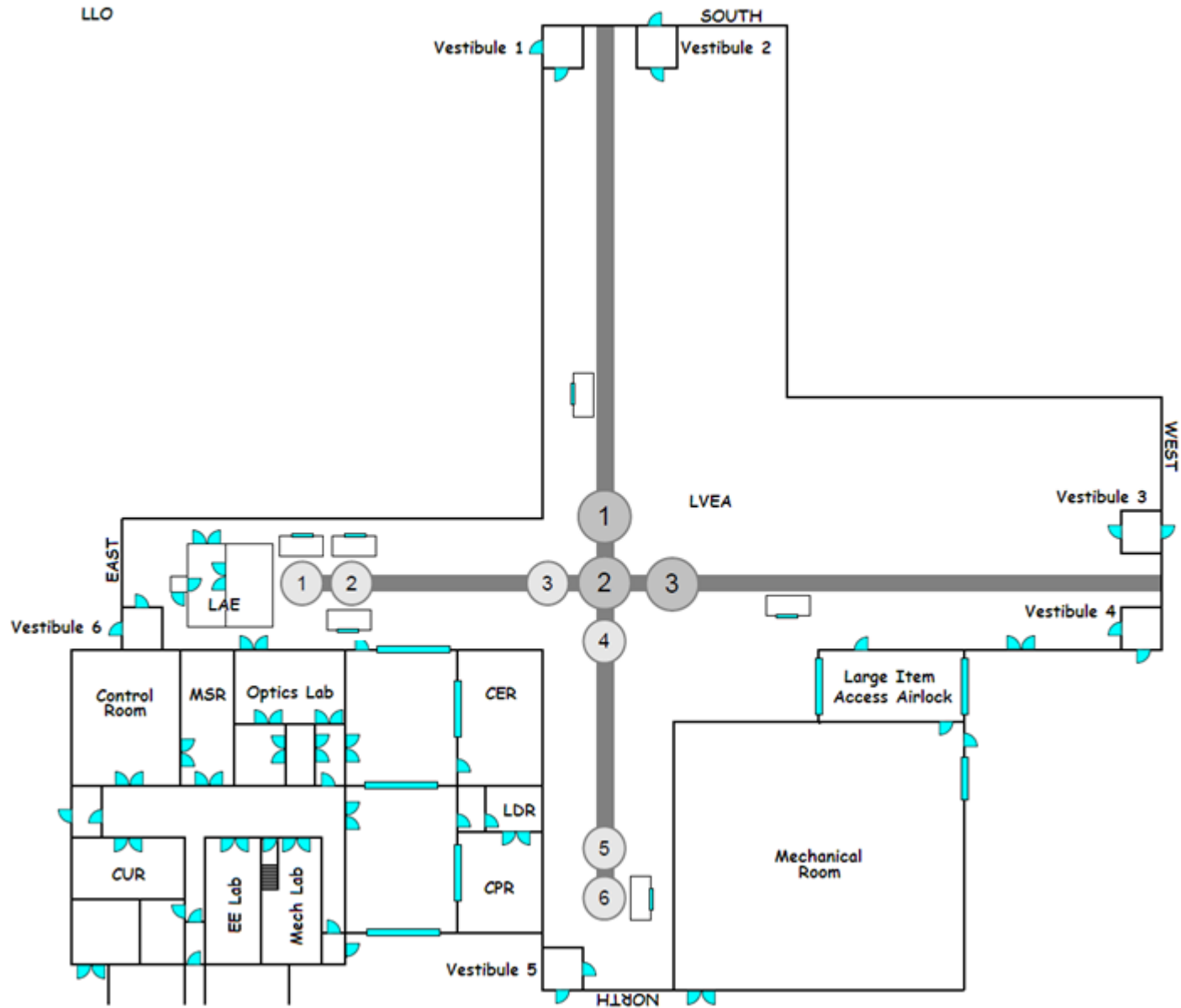

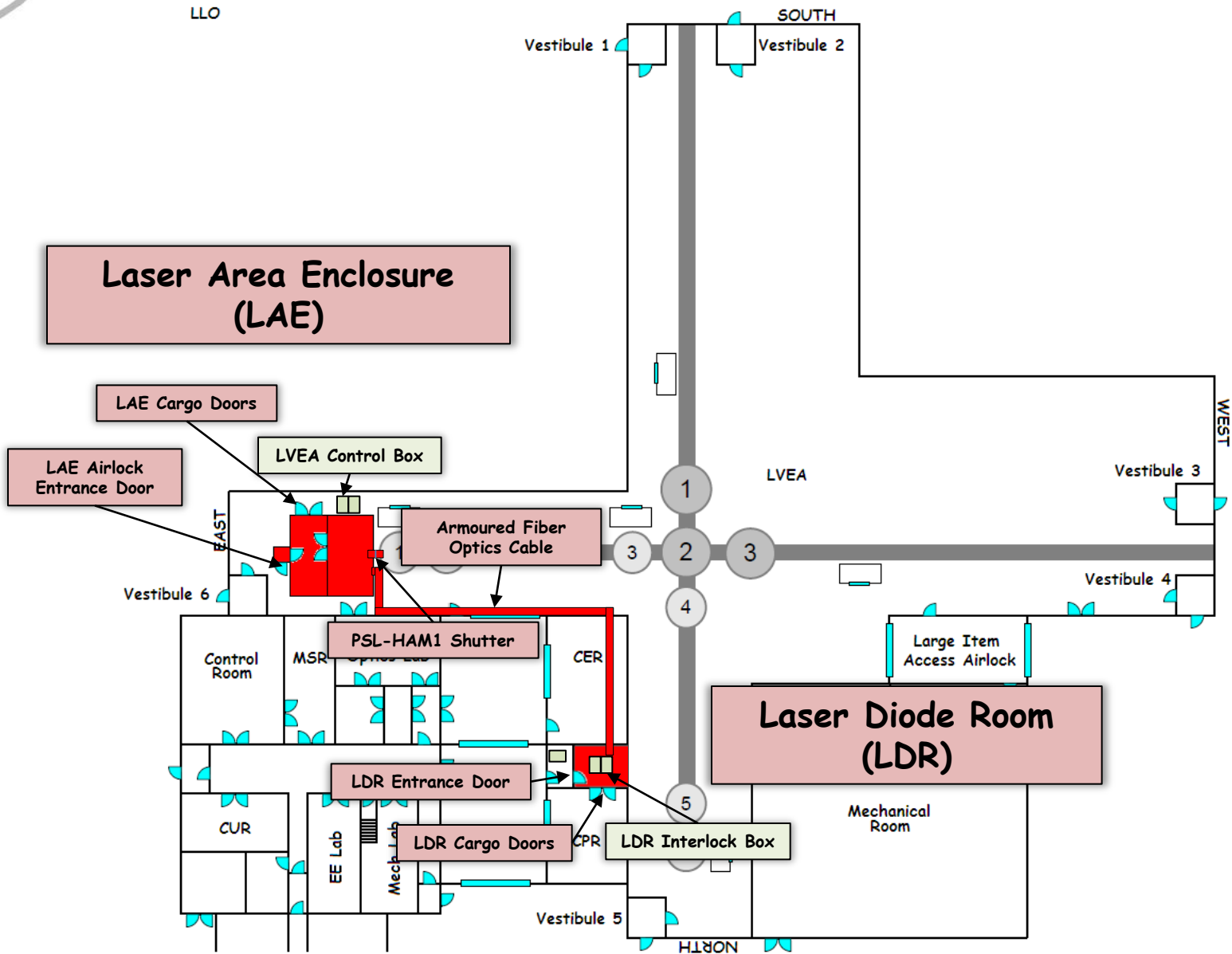

LVEA Racks

18 Field Racks are in the LVEA, including the Vacuum Racks.
See [LIGO-D1003141](#)) at LLO and [LIGO-D1002704](#) at LHO.

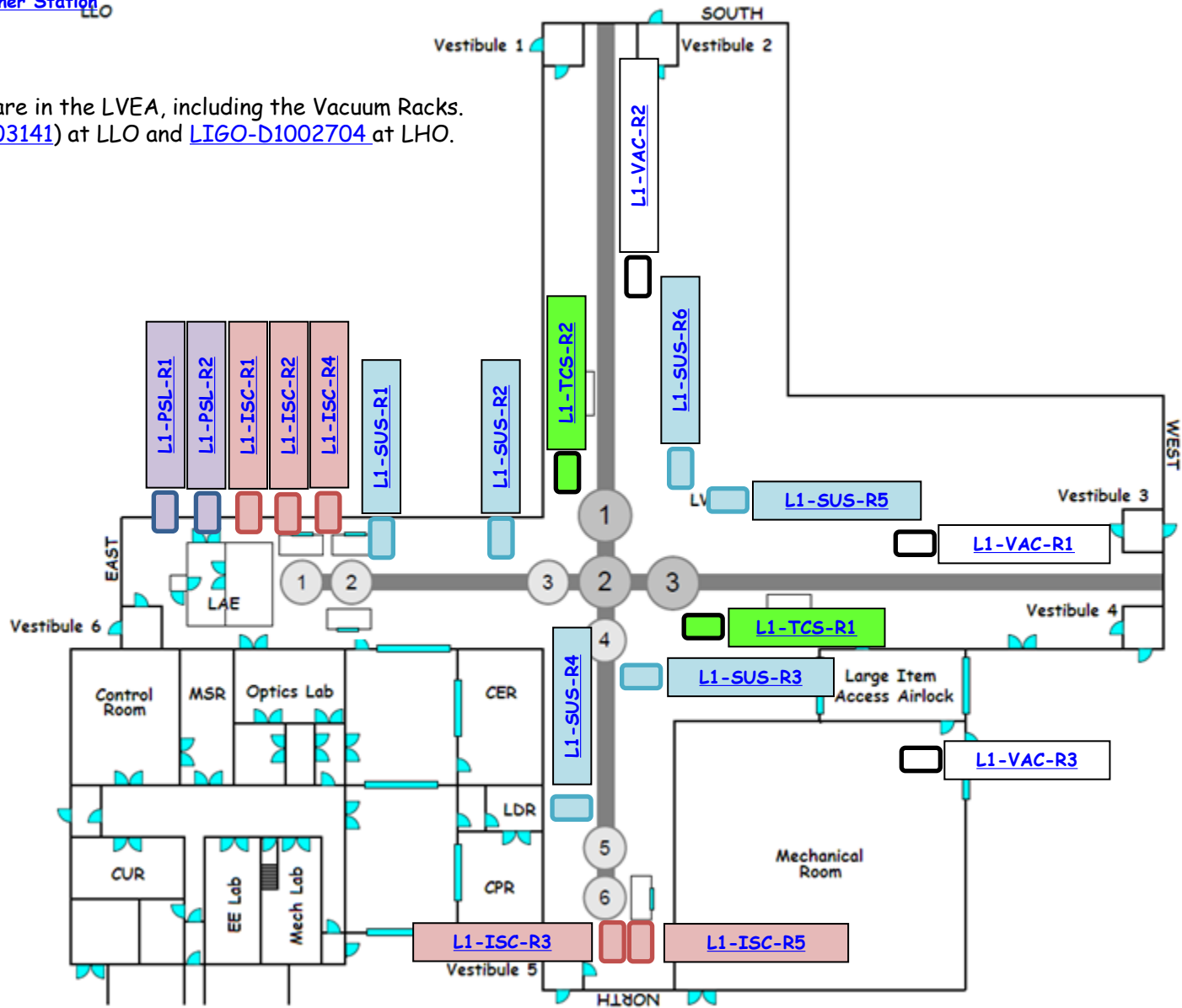

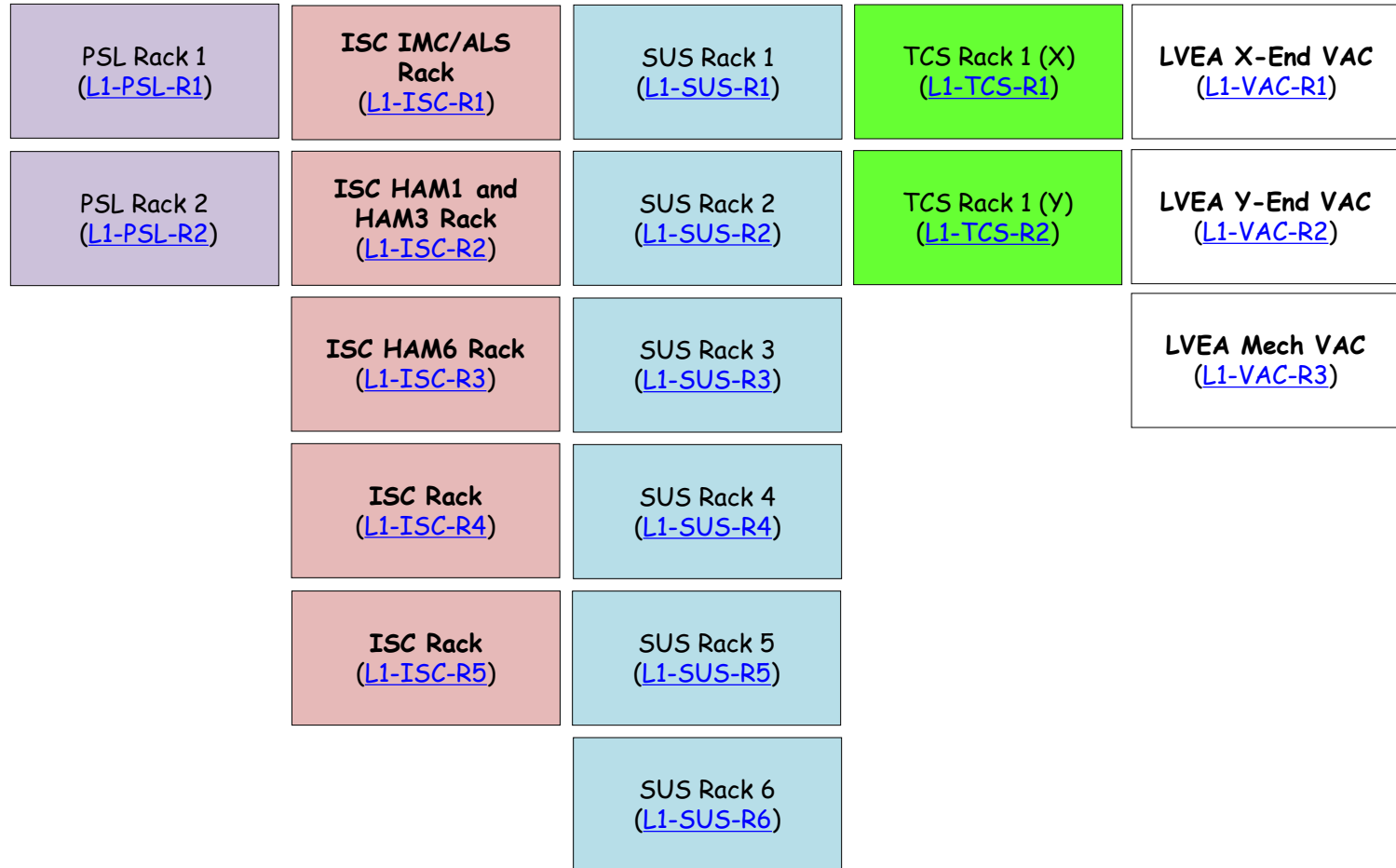

<< LLO Corner Station
LLO

18 Field Racks are in the LVEA, including the Vacuum Racks.
See [D1003141](#)) at LLO and [D1002704](#) at LHO.

Tables are named in [E1200808](#).

Tables Patch Panels are listed in [E1200613](#).

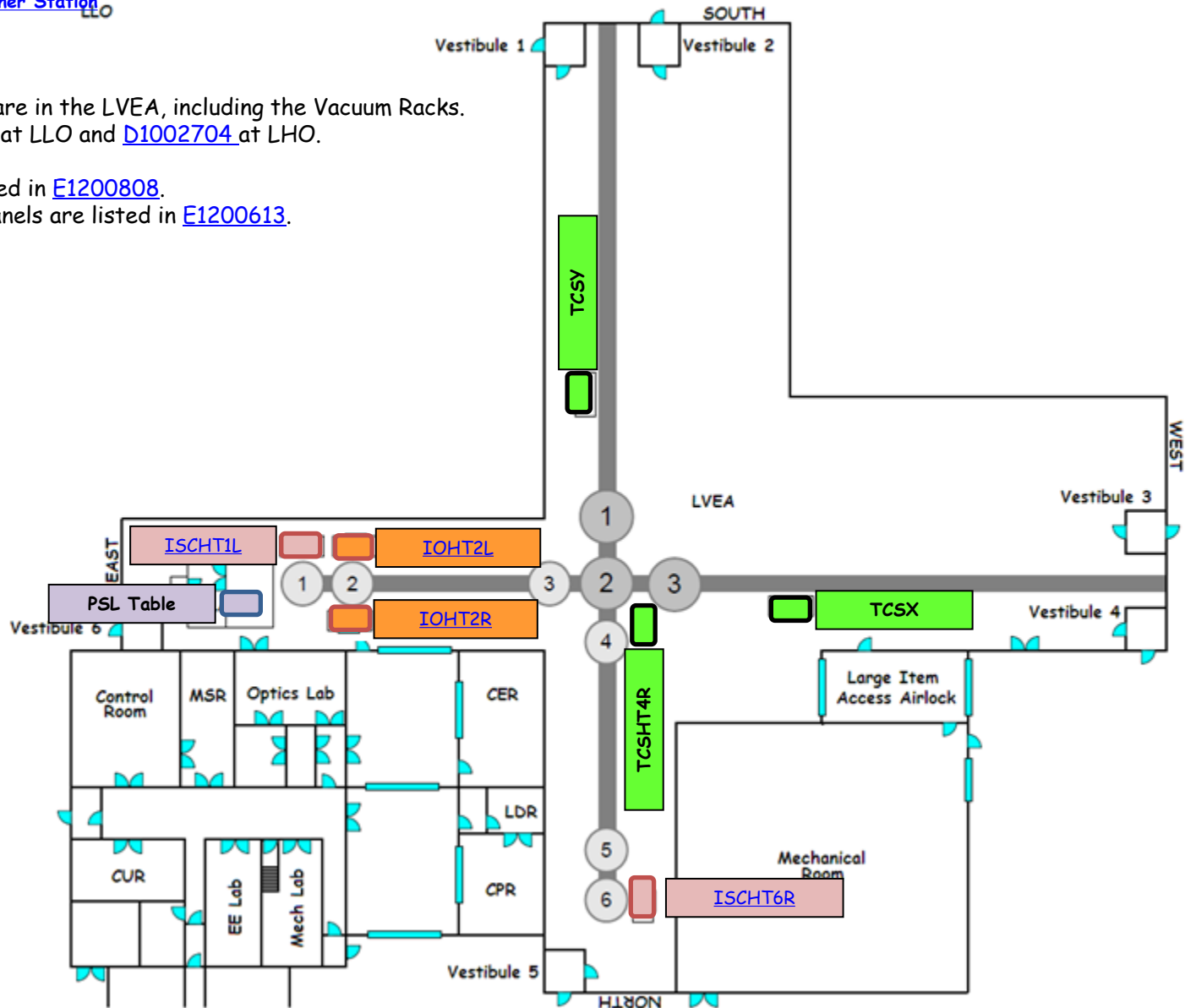

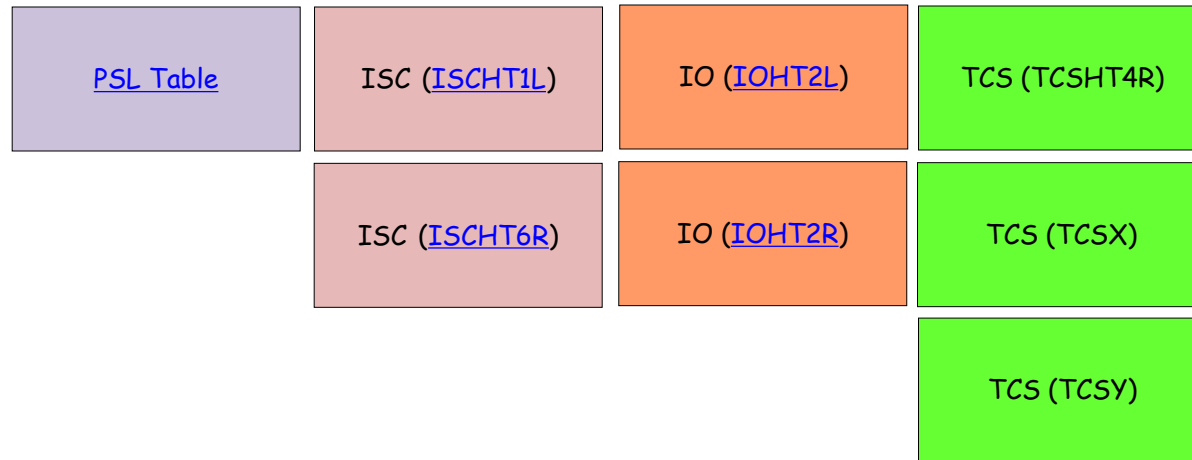

3' X 5' Table Layout ([D1200973](#))

4' X 8' Table Layout ([D1201022](#))

L1-PSL-R1

PSL Rack 1 Layout (LIGO-Dxxxxxxx)

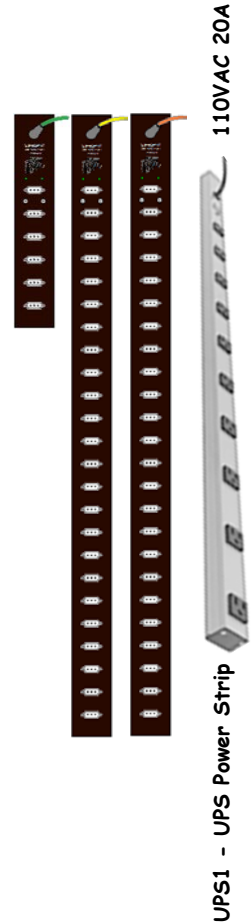
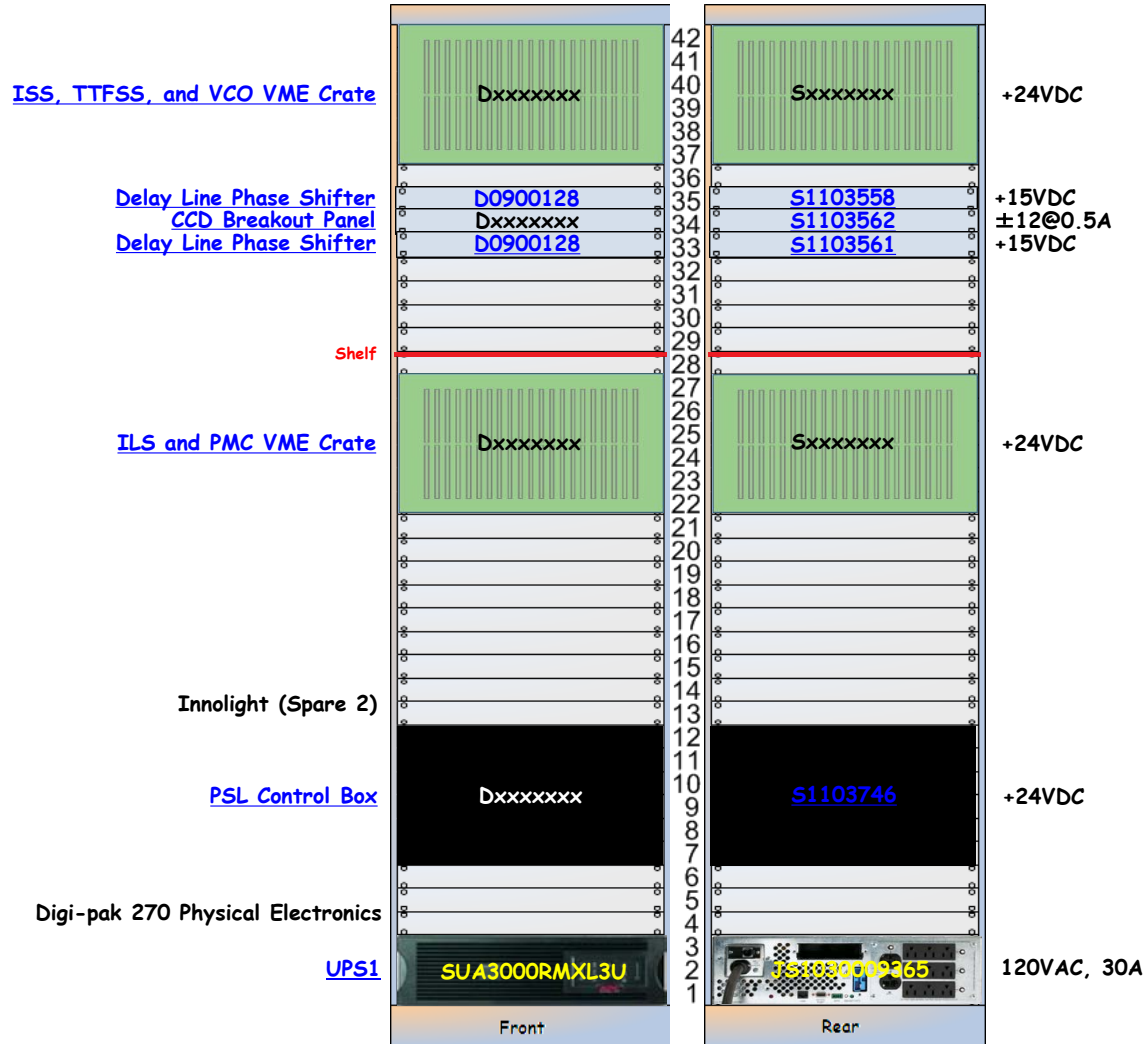

UPS1 - UPS Power Strip 110VAC 20A

ISS, TTFSS, and VCO VME Crate

<< [L1-PSL-R1](#)

ISS, TTFSS, and VCO VME Crate

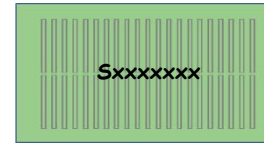
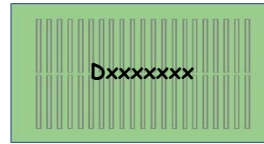

+24VDC

[S1103557](#)

[S1103554](#)

[S1103263](#)

[S1103555](#)

VME Crate

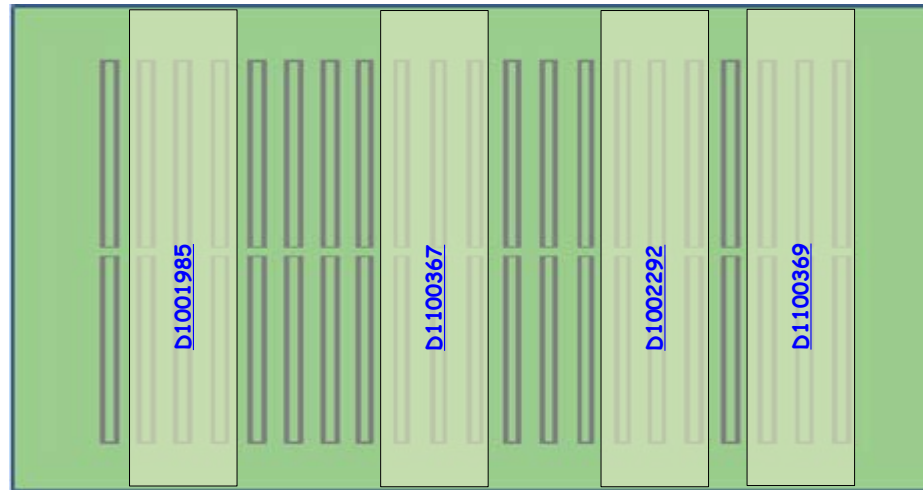

Intensity Stabilization
Servo Module

TTFSS Field Box

Monitoring Field Box Module

PSL VCO Field Box

[D1001985](#)

[D1100367](#)

[D1002292](#)

[D1100369](#)

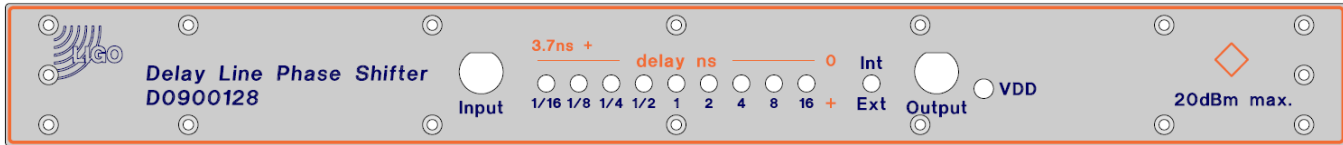

D0900128

Front

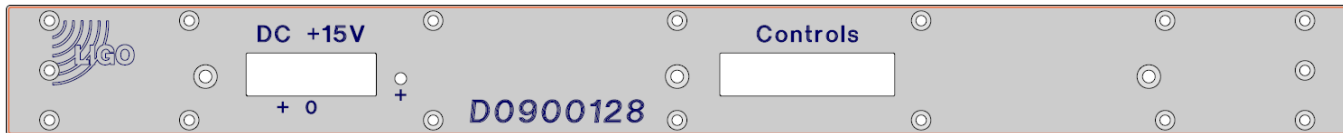
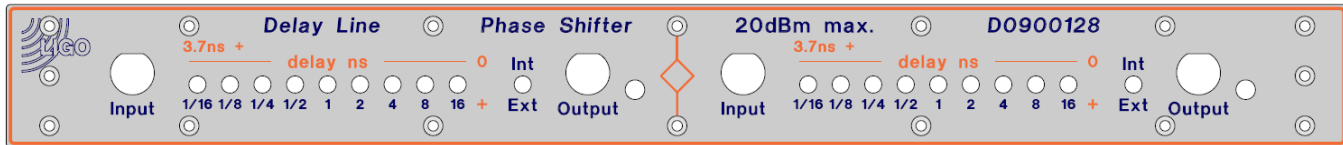

S1103558

Rear



[<< L1-PSL-R1](#)

CCD Breakout Panel ±12@0.5A

<< L1-PSL-R1

Delay Line Phase Shifter +15VDC

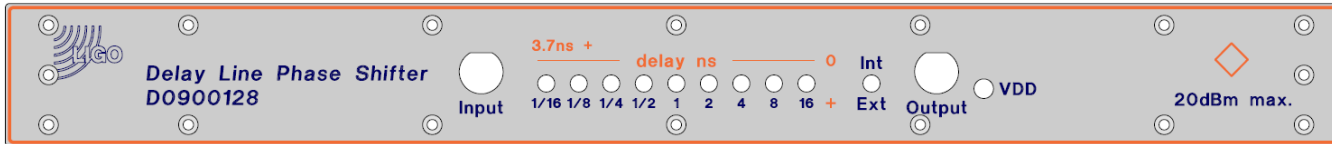

[D0900128](#)

Front

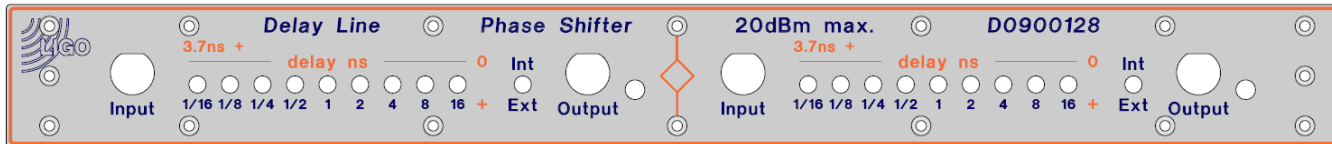

[S1103561](#)

Rear



<< L1-PSL-R1

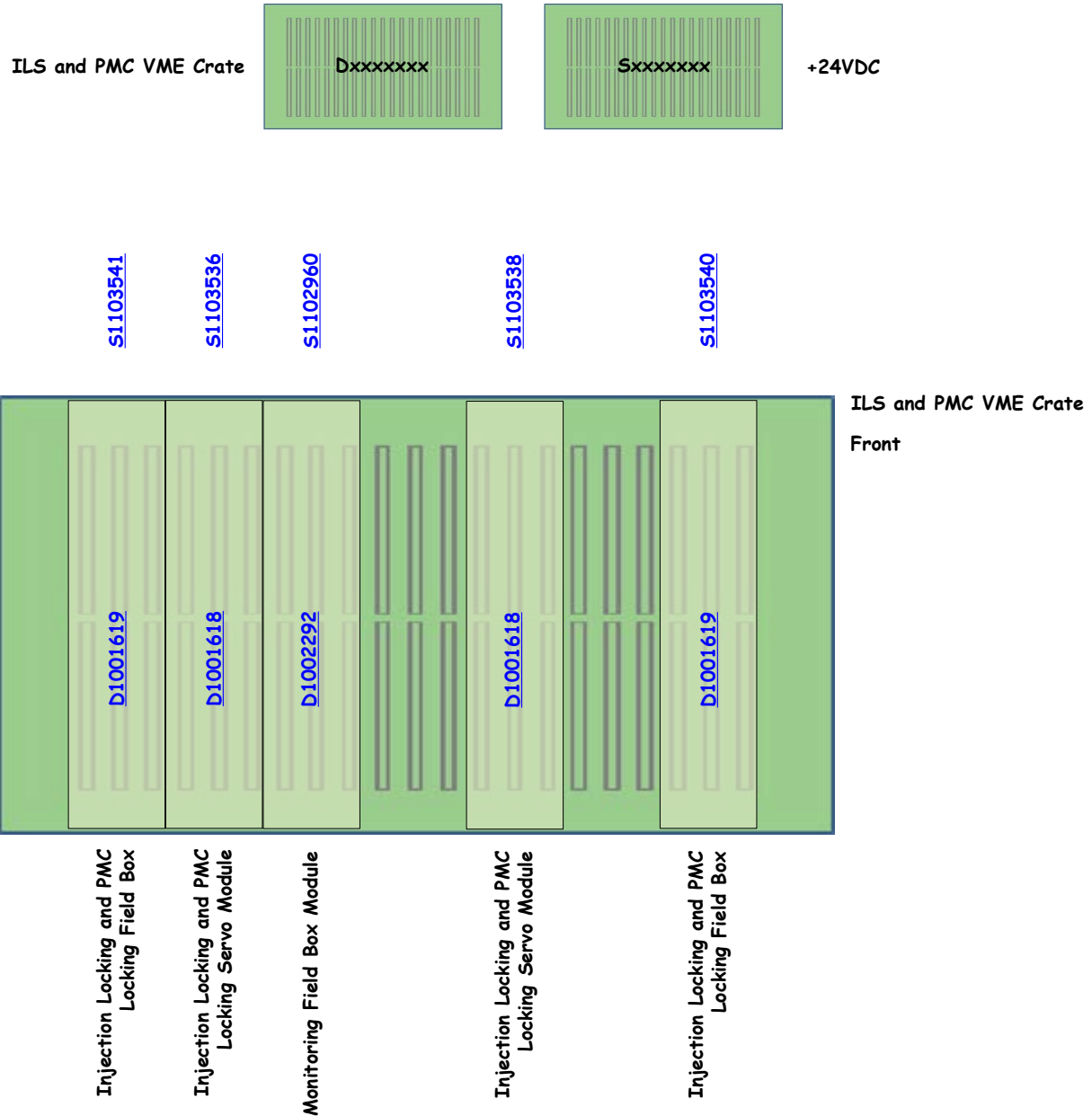

[<< L1-PSL-R1](#)

PSL Control Box

Dxxxxxxx

[S1103746](#)

+24VDC

PSL Control Box

[S1103746](#)

Front

<< L1-PSL-R1

UPS1

SUA3000RMXL3U

JS1030009365

120VAC, 30A



NEMA L5-30P

Camera Power Supplies ...

Panasonic 990 - LVEA1
Panasonic 990 - LVEA2

Agilent E4400B Signal Generator
IFR 2023A Signal Generator

Shelf

Tektronix TDS220

Stanford Research DS345
IFR 2023A Signal Generator

Shelf

Control
Shelf

Diagnostics Breadboard
(DBB) 0208 Crate



Diagnostics Breadboard (DBB) 0208
Shelf

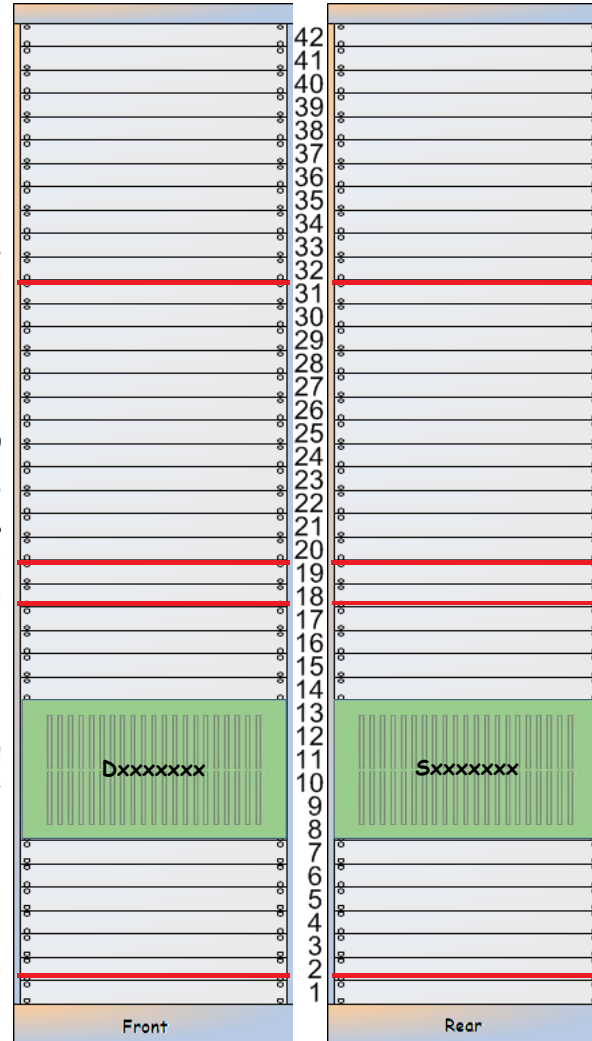

35.5MHz, 14.6dBm
80MHz, 32dBm

+ -19VDC, + -9VDC

CP5 Connector:
Pin 1: -19VDC
Pin 2: -9VDC
Pin 3: Ground
Pin 4: +9VDC
Pin 5: +19VDC

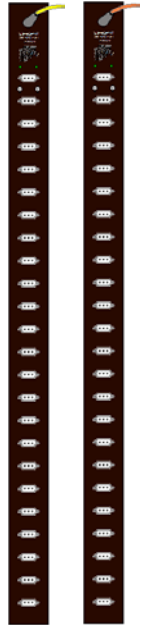

<< L1-PSL-R2

Diagnostics Breadboard
(DBB) VME Crate

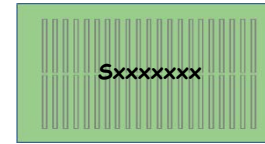
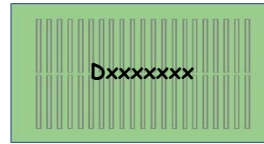

+24VDC

[S1103544](#)

[S1103546](#)

[S1103548](#)

[S1103550](#)

[S1103551](#)

Diagnostics Breadboard
(DBB) VME Crate

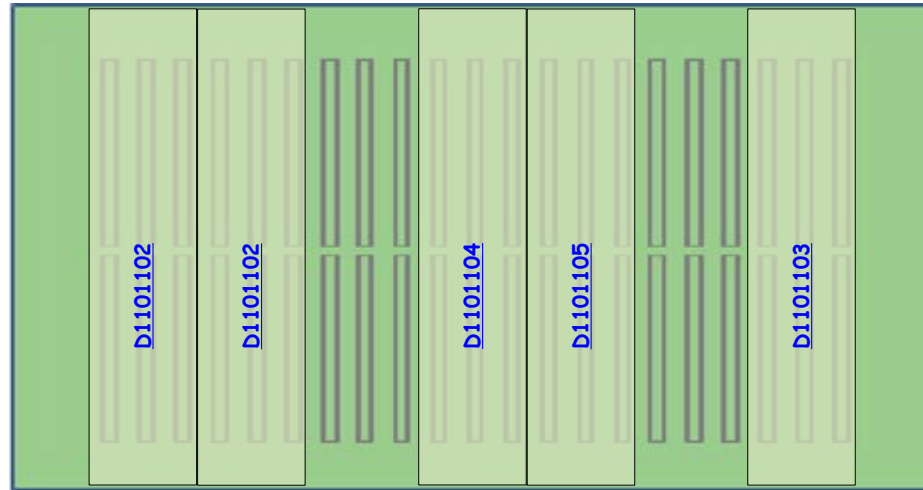

Diagnostics Breadboard
(DBB) VME Crate
Front

PSL Diagnostics Breadboard
High Voltage Module

PSL Diagnostics Breadboard
Field Box

PSL Diagnostics Breadboard
Demodulator Module

PSL Diagnostics Breadboard
Miscellaneous Module

PSL Diagnostics Breadboard
Calibration Module



ISC R1

LVEA IMC ALS Rack R1 Layout

41 U

2 U	RF Patch Panel 10	RF Patch Panel 10
2 U	RF Patch Panel 11	RF Patch Panel 11
2 U	RF Patch Panel 12	RF Patch Panel 12
1 U	D1000124	24.078 MHz Distribution Amplifier (Concentrator in C3)
2 U	D0900605	79.4 MHz VCO (ALS) (to Beckhoff in C2)
1 U	D1002178	158.8 MHz Frequency Doubler
1 U	D1002476	158.8 / 79.4 MHz 2-Channel PF Discriminator
2 U	D0900605	79.4 MHz VCO (ALS) (to Beckhoff in C2)
2 U	D0900605	79.4 MHz VCO (PSL) (to Beckhoff in C2)
1 U	D1002178	158.8 MHz Frequency Doubler
1 U	D0900128	24.078 MHz Dual Delay Line
1 U	D1000181	24.078 MHz 2-Channel Demodulator
1 U	D0901781	Mode Cleaner Servo
1 U	D1100691	LSC Demod Concentrator 1
1 U	D1100696	ASC Demod Concentrator 1
1 U	D1102079	LSC RFPD Interface
1 U	D1101865	WFS Interface
1 U	D1002559	ISC Whitening Chassis (ASC IMC WFS_A 24MHz)
1 U	D0902796	WFS I/Q Demodulator (ASC IMC WFS_A 24MHz)
1 U	D1100905	Demodulator Patch Panel
1 U	D0902796	WFS I/Q Demodulator (ASC IMC WFS_B 24MHz)
1 U	D1002559	ISC Whitening Chassis (ASC IMC WFS_A 24MHz)

LIGO-D1001460-v7

[ISC Whitening Chassis \(ASC IMC WFS_A 24MHz\)](#)

[WFS I/Q Demodulator \(ASC IMC WFS_A 24MHz\)](#)

[Demodulator Patch Panel](#)

[WFS I/Q Demodulator \(ASC IMC WFS_B 24MHz\)](#)

[ISC Whitening Chassis \(ASC IMC WFS_A 24MHz\)](#)

RF Patch Panel 10

RF Patch Panel 11

RF Patch Panel 12

[24.078 MHz Distribution Amplifier](#)

[158.8 MHz Frequency Doubler](#)

[79.4 MHz VCO \(ALS\)](#)

[158.8 / 79.4 MHz 2-Channel PF Discriminator](#)

[79.4 MHz VCO \(ALS\)](#)

[79.4 MHz VCO \(PSL\)](#)

[158.8 MHz Frequency Doubler](#)

[24.078 MHz Dual Delay Line](#)

[24.078 MHz 2-Channel Demodulator](#)

[79.4 MHz VCO \(PSL\)](#)

[158.8 MHz Frequency Doubler](#)

[24.078 MHz Dual Delay Line](#)

[24.078 MHz 2-Channel Demodulator](#)

[Mode Cleaner Servo](#)

[LSC Demod Concentrator 1](#)

[ASC Demod Concentrator 1](#)

[LSC RFPD Interface](#)

[WFS Interface](#)

[WFS I/Q Demodulator \(ASC IMC WFS_A 24MHz\)](#)

[Demodulator Patch Panel](#)

[WFS I/Q Demodulator \(ASC IMC WFS_B 24MHz\)](#)

[ISC Whitening Chassis \(ASC IMC WFS_A 24MHz\)](#)

Dxxxxxxx	42	Sxxxxxxx	No Power
Dxxxxxxx	41	Sxxxxxxx	No Power
Dxxxxxxx	40	Sxxxxxxx	No Power
Dxxxxxxx	39	Sxxxxxxx	No Power
Dxxxxxxx	38	Sxxxxxxx	No Power
Dxxxxxxx	37	Sxxxxxxx	No Power
Dxxxxxxx	36	Sxxxxxxx	No Power
D1000124	35	Sxxxxxxx	±17VDC, ±24VDC
D1000124	34	Sxxxxxxx	±17VDC, ±24VDC
D0900605	33	Sxxxxxxx	±17VDC, ±24VDC
D0900605	32	Sxxxxxxx	±17VDC, ±24VDC
D1002178	31	Sxxxxxxx	±17VDC, ±24VDC
D1002476	30	Sxxxxxxx	±17VDC, ±24VDC
D1002476	29	Sxxxxxxx	±17VDC, ±24VDC
D0900605	28	Sxxxxxxx	±17VDC, ±24VDC
D0900605	27	Sxxxxxxx	±17VDC, ±24VDC
D0900605	26	Sxxxxxxx	±17VDC, ±24VDC
D0900605	25	Sxxxxxxx	±17VDC, ±24VDC
D0900605	24	Sxxxxxxx	±17VDC, ±24VDC
D1002178	23	Sxxxxxxx	±17VDC, ±24VDC
D0900128	22	Sxxxxxxx	±17VDC, ±24VDC
D1000181	21	Sxxxxxxx	+15VDC
D1000181	20	Sxxxxxxx	±17VDC, ±24VDC
D0901781	19	Sxxxxxxx	±17VDC, ±24VDC
D0901781	18	Sxxxxxxx	±17VDC, ±24VDC
D1100691	17	Sxxxxxxx	±18VDC
D1100696	16	Sxxxxxxx	No Power
D1102079	15	Sxxxxxxx	±18VDC
D1101865	14	Sxxxxxxx	±15VDC
D1101865	13	Sxxxxxxx	±15VDC
D1002559	12	Sxxxxxxx	±15VDC
D1002559	11	Sxxxxxxx	±15VDC
D0902796	10	Sxxxxxxx	±15VDC
D1100905	9	Sxxxxxxx	No Power
D0902796	8	Sxxxxxxx	±15VDC
D0902796	7	Sxxxxxxx	±15VDC
D1002559	6	Sxxxxxxx	±15VDC
D1002559	5	Sxxxxxxx	±15VDC
D1002559	4	Sxxxxxxx	±15VDC
D1002559	3	Sxxxxxxx	±15VDC
D1002559	2	Sxxxxxxx	±15VDC
D1002559	1	Sxxxxxxx	±15VDC

Front

Rear

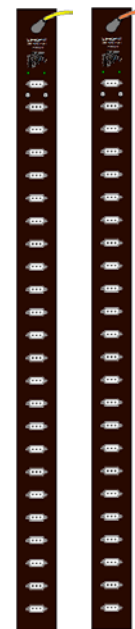

<< LVEA Racks

ISC HAM1 and HAM3 Rack Layout ([LIGO-D1001425](#))

[D1200757](#)
Sequencer

[S1202569](#)



ISC R2

Serving ISC HAM 1 and HAM 3

41 U

2 U	RF Patch Panel 13
2 U	RF Patch Panel 14
1 U	D1000124 45 MHz Distribution Amplifier
1 U	D1000124 9.099 / 8.684 MHz Distribution Amplifier
1 U	D0900128 9.099 / 8.684 MHz Dual Delay Line
1 U	D1000151 9.099 / 8.684 MHz 2-Channel Demodulator
1 U	D1002559 ISC Whitening Chassis (LSC POPAIR A 9&45, LSC REFLAIR A 45)
1 U	D0902796 LSC I/Q Demodulator (LSC POPAIR A 9&45, LSC REFLAIR A 45)
1 U	D1100905 LSC Demodulator Patch Panel
1 U	D0902796 LSC I/Q Demodulator (LSC POPAIR B 18&90, LSC REFLAIR B 27&135)
1 U	D1002559 ISC Whitening Chassis (LSC POPAIR B 18&90, LSC REFLAIR B 27&135)
1 U	D0902796 LSC I/Q Demodulator (LSC POP, LSC REFL)
1 U	D1100905 LSC Demodulator Patch Panel
1 U	D1002559 ISC Whitening Chassis (LSC POP, LSC REFL)
1 U	D1002559 ISC Whitening Chassis (ASC REFLAIR A 9MHz)
1 U	D0902796 WFS I/Q Demodulator (ASC REFLAIR A 9MHz)
1 U	D1100905 WFS Demodulator Patch Panel
1 U	D0902796 WFS I/Q Demodulator (ASC REFLAIR A 45MHz)
1 U	D1002559 ISC Whitening Chassis (ASC REFLAIR A 45MHz)
1 U	D1002559 ISC Whitening Chassis (ASC REFLAIR B 9MHz)
1 U	D0902796 WFS I/Q Demodulator (ASC REFLAIR B 9MHz)
1 U	D1100905 Demodulator Patch Panel
1 U	D0902796 WFS I/Q Demodulator (ASC REFLAIR B 45MHz)
1 U	D1002559 ISC Whitening Chassis (ASC REFLAIR B 45MHz)
1 U	D0902796 WFS I/Q Demodulator (Spare chain for air to vac leapfrog)
1 U	D1100905 Demodulator Patch Panel
1 U	D1002559 ISC Whitening Chassis (Spare chain for air to vac leapfrog)

[LIGO-D1001425-v6](#)

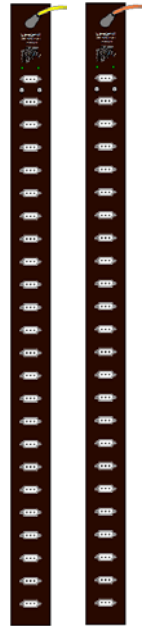
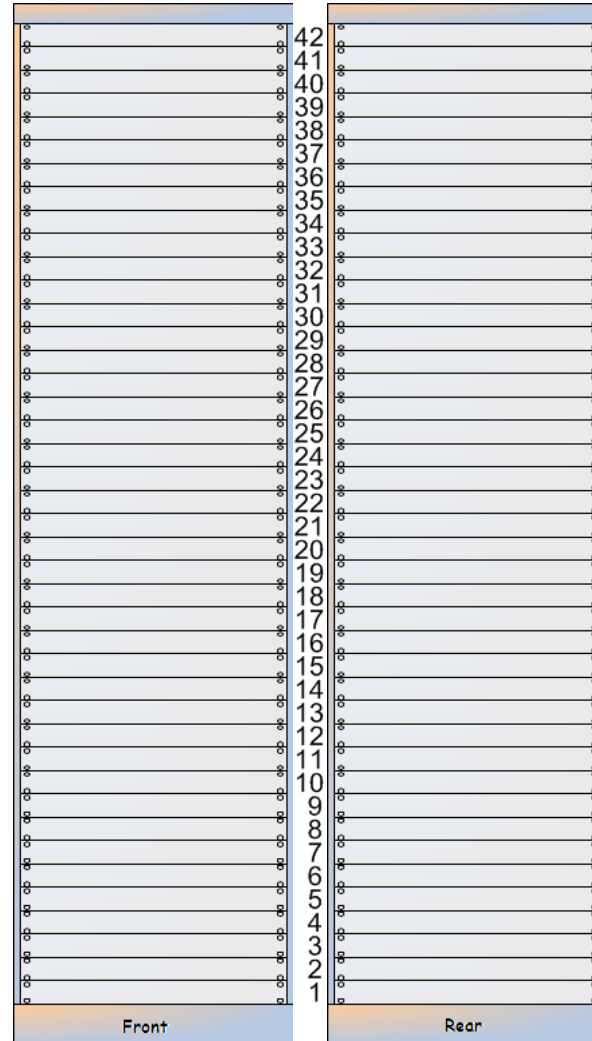

IOHT2L is part of [E1201099](#).

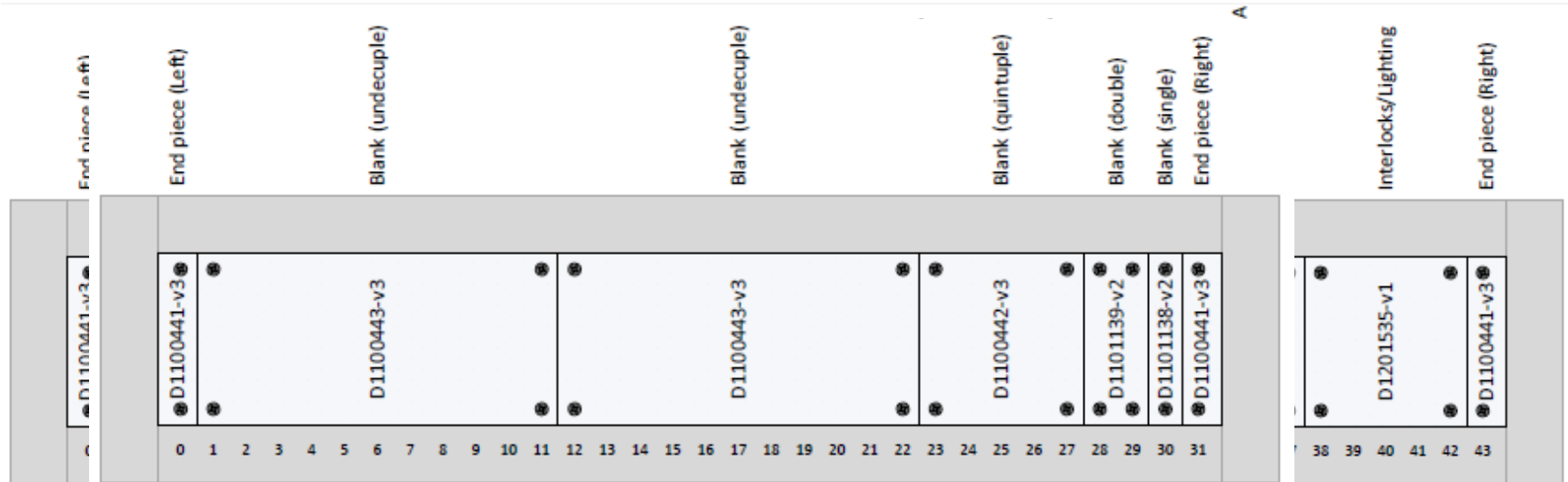

Left Side

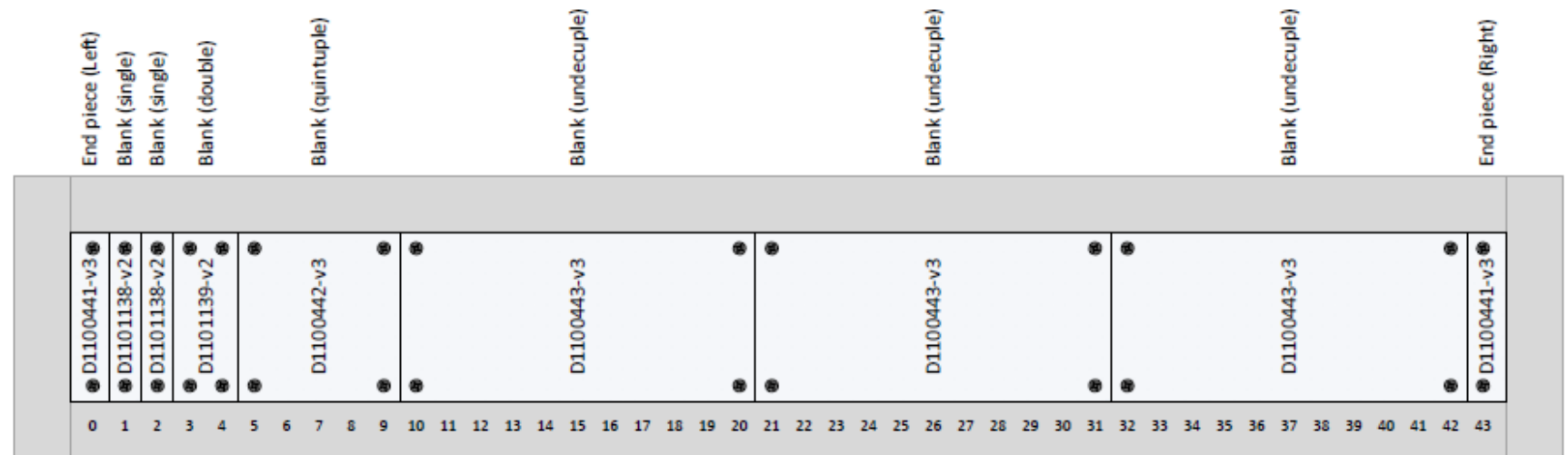

Right Side

IOHT2R is part of [E1201099](#).

L1-IOHT2R Panel Layout

[<< LVEA Tables](#)

IOHT2R Panel Layout ([D1201530](#))

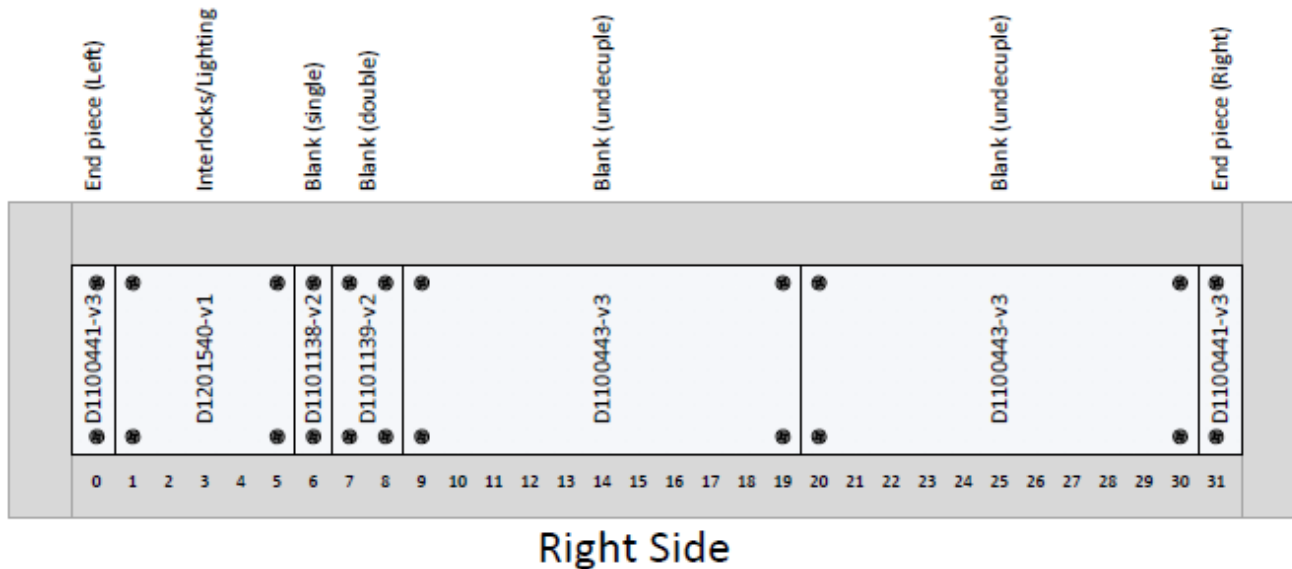
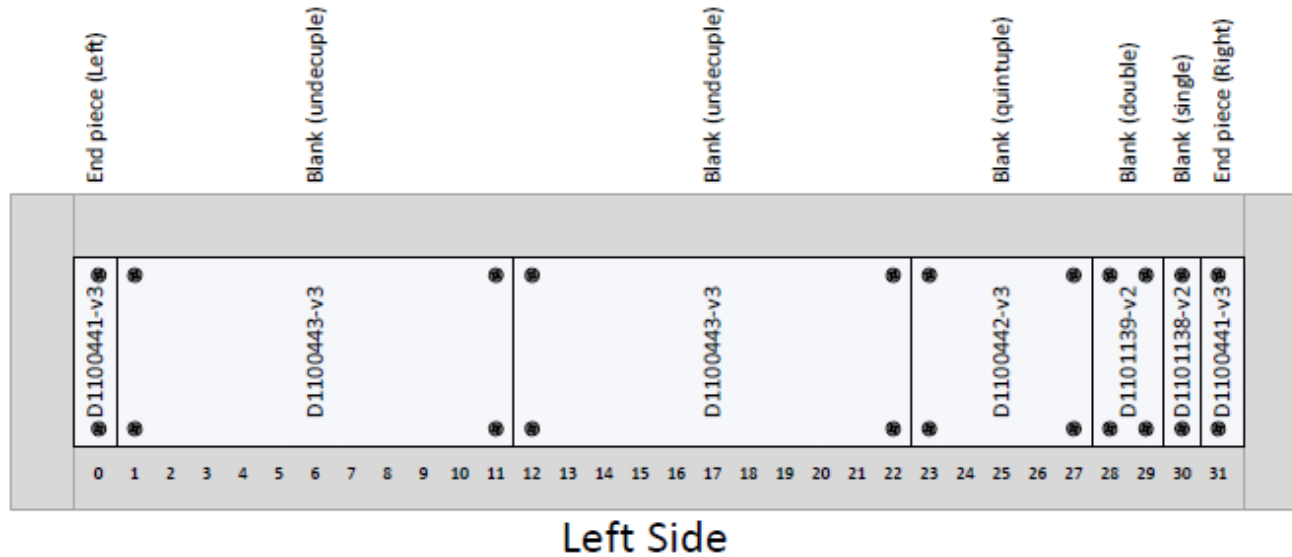



L1-ISCHT1L Table Layout

[<< LVEA Tables](#)

ISCHT1L Table Layout ([D1201499](#)) (Sxxxxxxx)

ISCHT1L is part of [E1201099](#).

L1-ISCHT1L Panel Layout

<< LVEA Tables

ISCHT1L Panel Layout (D1201331)

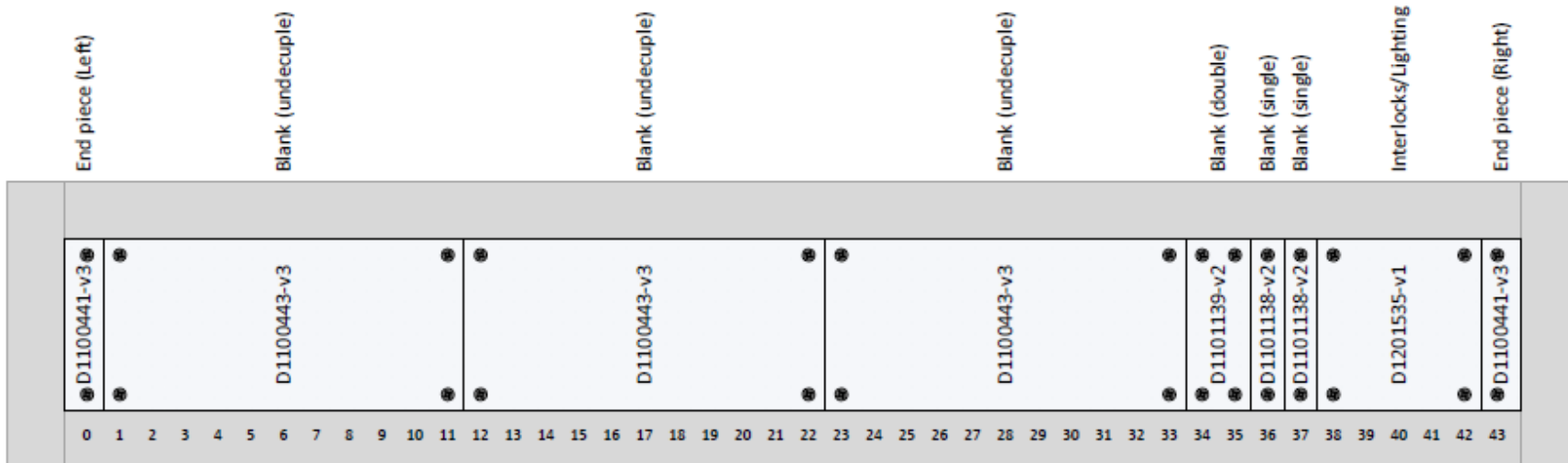

Left Side

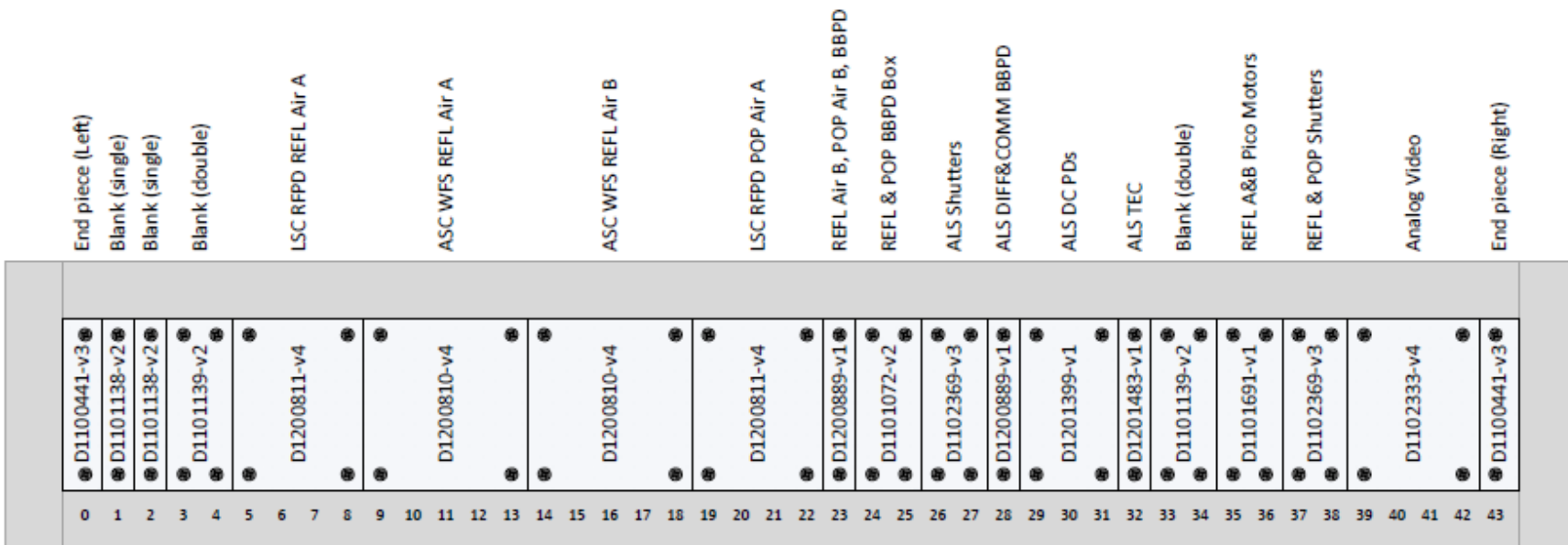

Right Side

ISCHT6R is part of [E1201099](#).

L1-ISCHT6R Panel Layout

[<< LVEA Tables](#)

ISCHT6R Panel Layout ([D1201496](#))

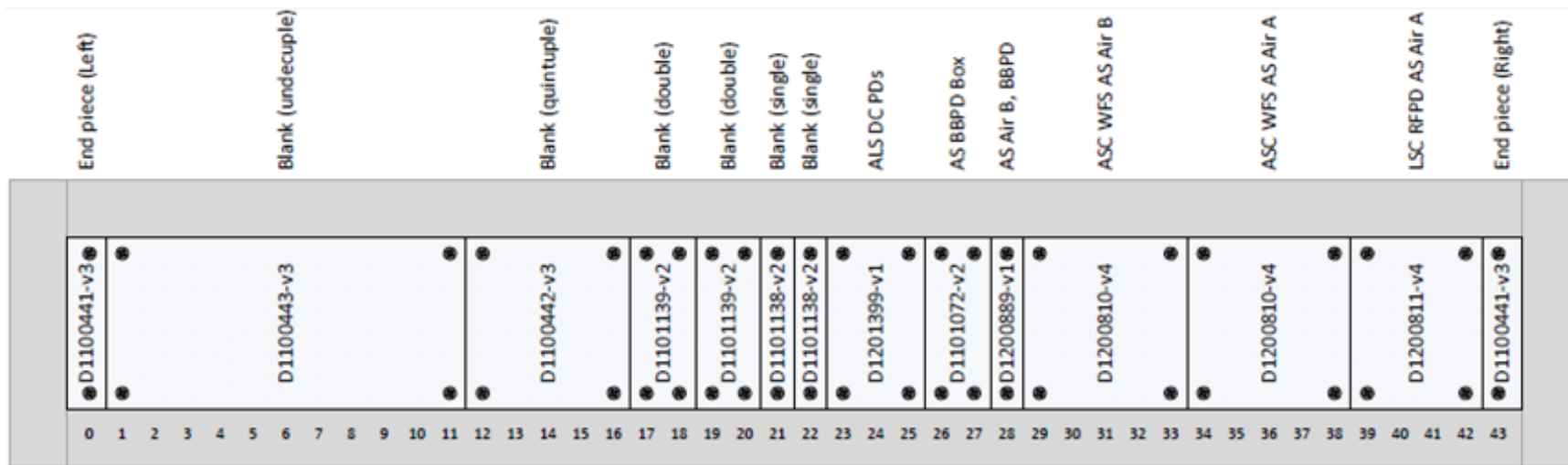

Left Side

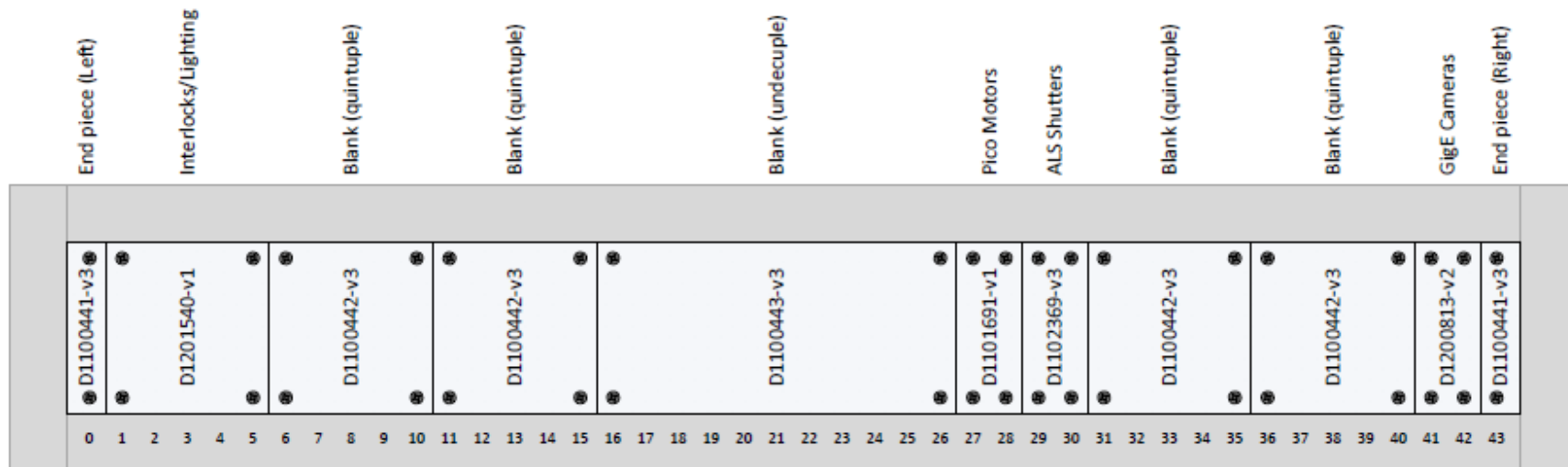

Right Side



L1-ISCBT4R Table Layout

[<< LVEA Tables](#)

ISCHT6R Table Layout ([D1201498](#)) (Sxxxxxxx)

ISCHT6R is part of [E1201099](#).

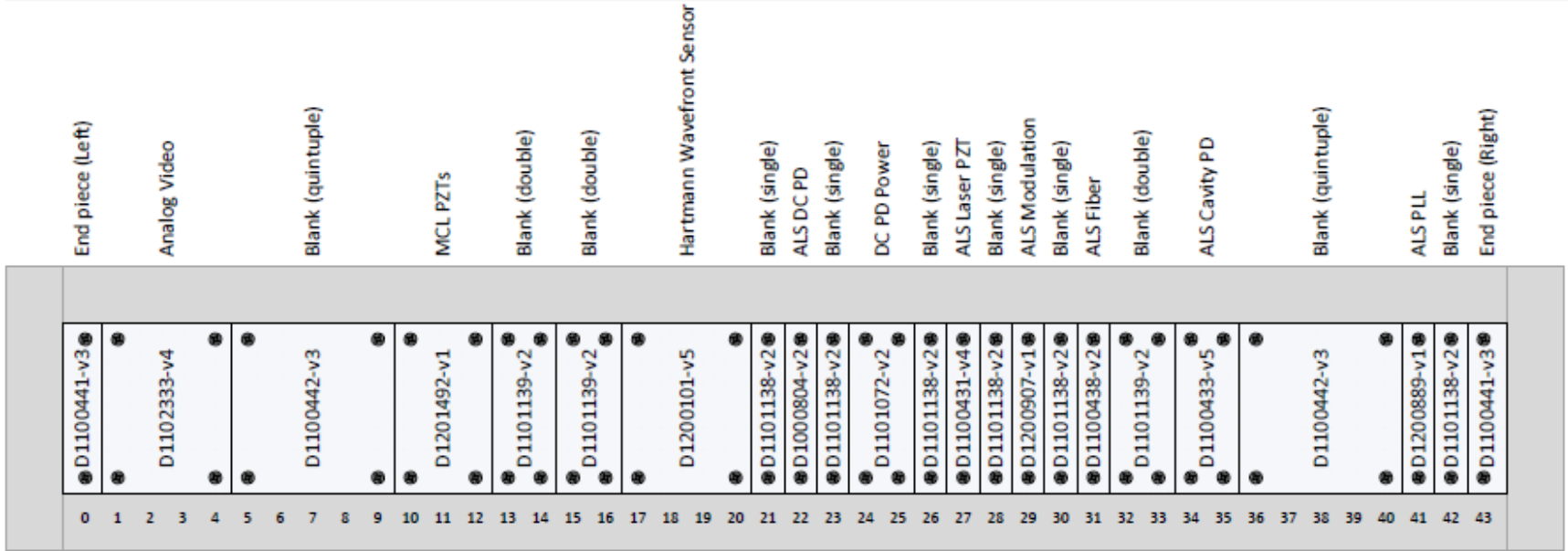

Left Side

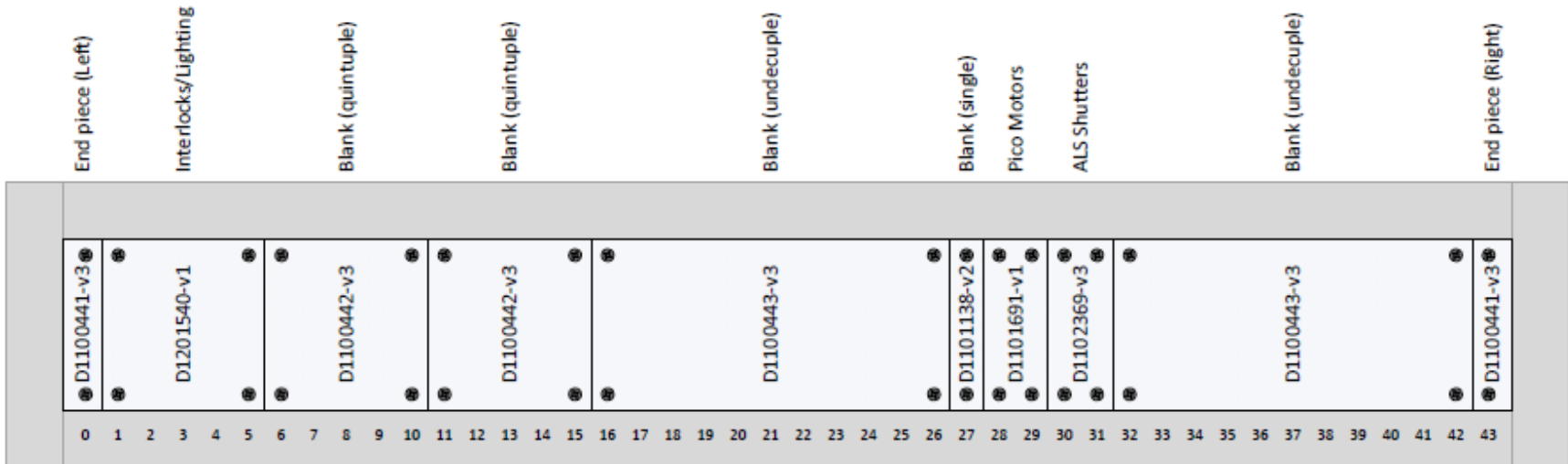

Right Side

ISCHT6R is part of [E1201099](#).

L1-ISCBT5L Panel Layout

<< LVEA Tables

ISCBT5L Panel Layout ([D1101126](#))

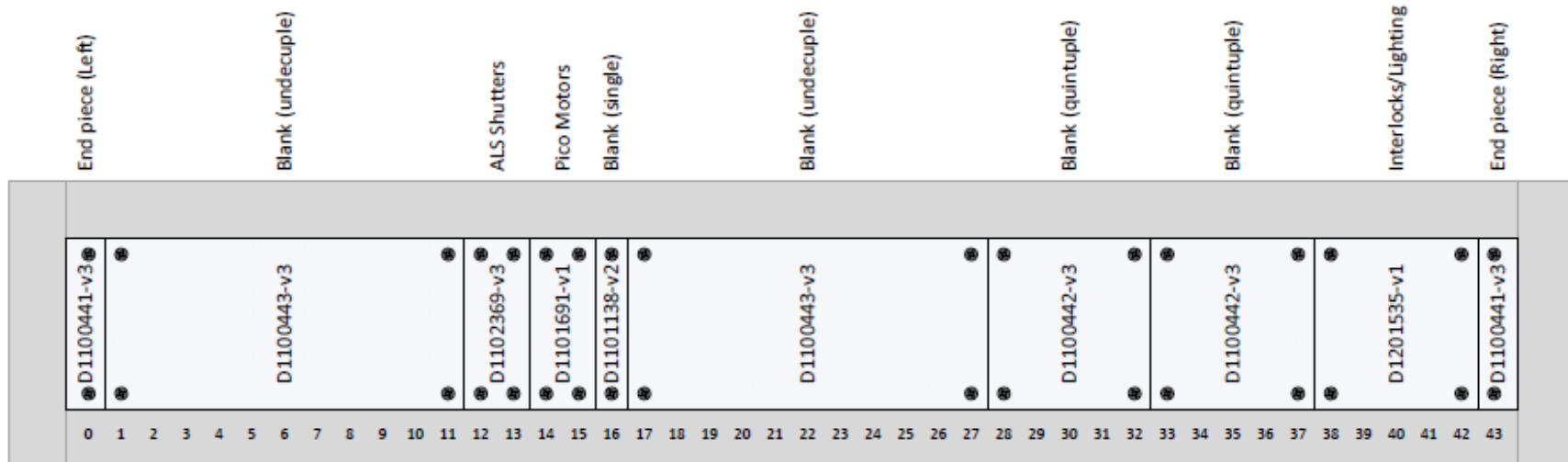

Left Side

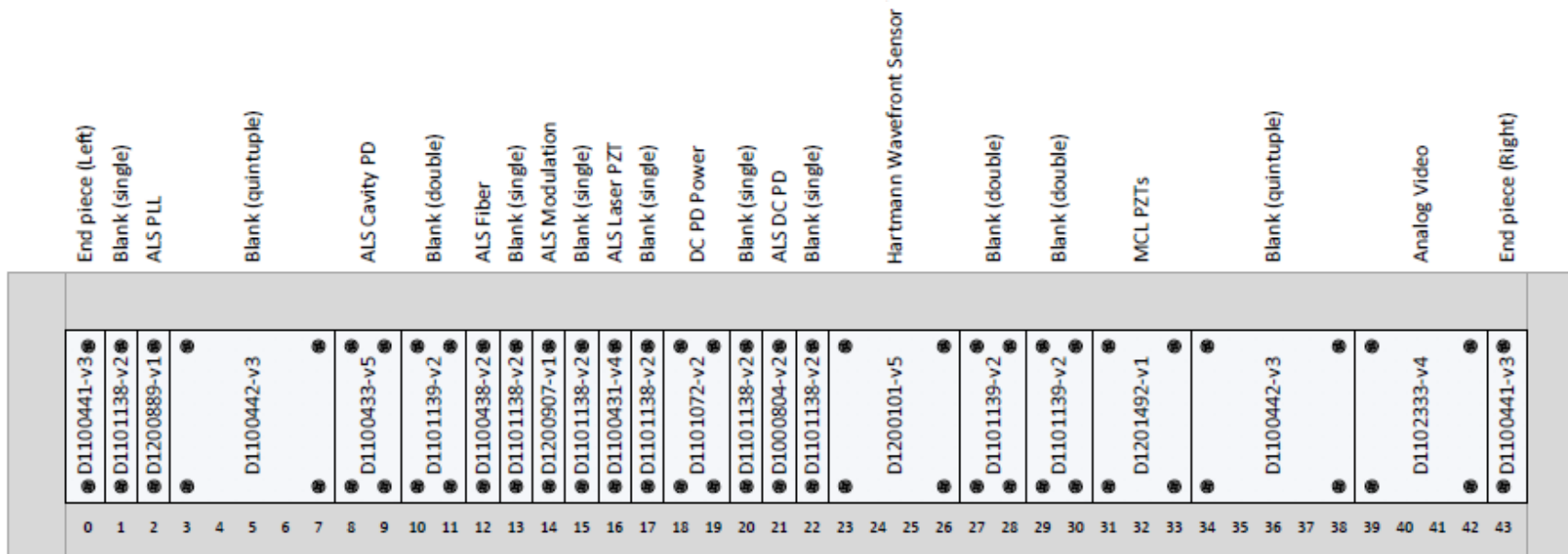

Right Side

End Blank Panel



[D1100441](#)

Single Blank Panel



[D1101138](#)

Double Blank Panel



[D1101139](#)

Quintuple Blank Panel

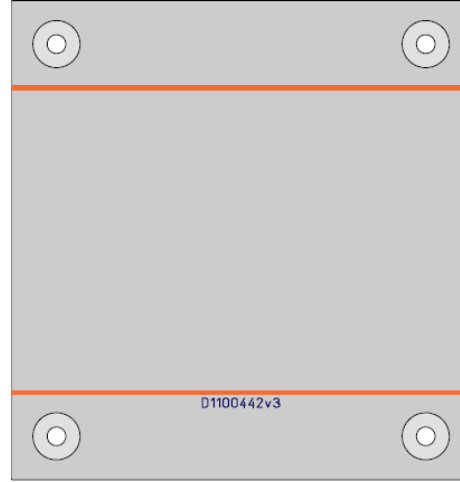

[D1100442](#)

Undecuple Blank Panel

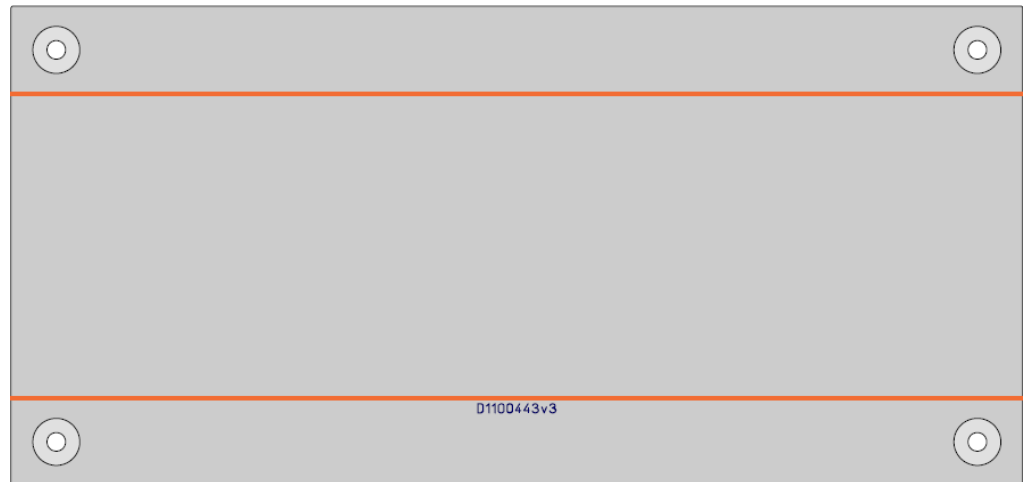

[D1100443](#)

Flipper Mirrors,
Sensor Patch Panel

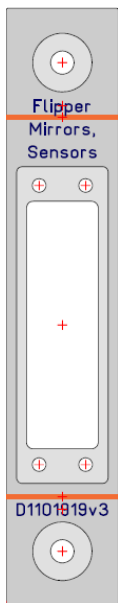

[D1101919](#)

DC Power Patch Panel

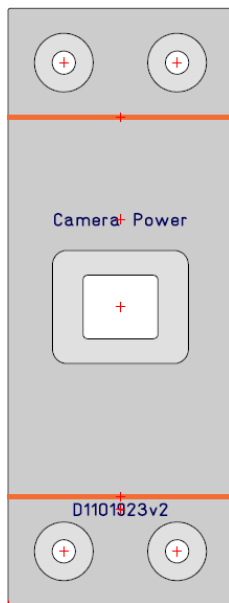

[D1101923](#)

LC Duplex Patch Panel



[D1101924](#)

RTD Sensors Patch Panel

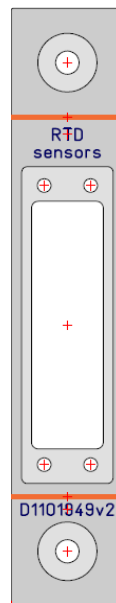

[D1101949](#)

Delrin Insert
for DB25

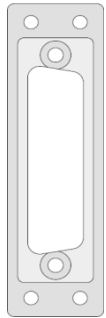

[D1101690](#)

Picomotor
Breakout Front

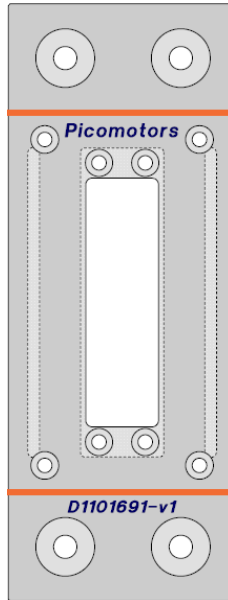

[D1101691](#)

Picomotor
Breakout Rear

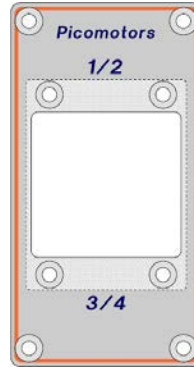

[D1101692](#)

Picomotor
Breakout Side



[D1101693](#)

Delrin Insert
for 2 X DB9

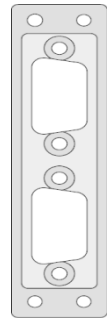

[D1101669](#)

**Delrin Insert
for DB25**

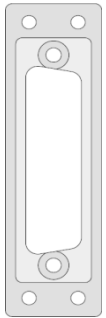

[D1101690](#)

**Delrin Insert
for 2 X DB9(V)**

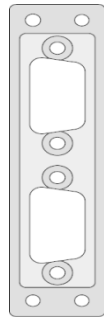

[D1101669](#)

**Delrin Insert
for 2 X DB9(H)**

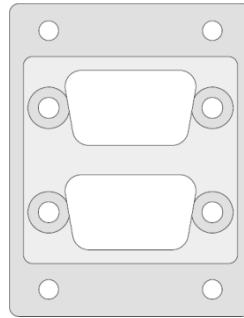

[D1101699](#)

Shutter Logic D1102312 Sxxxxxxx +24VDC

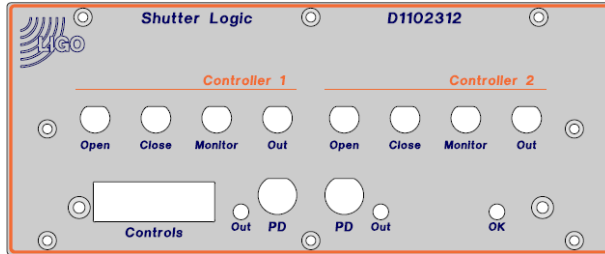

D1102312
Front

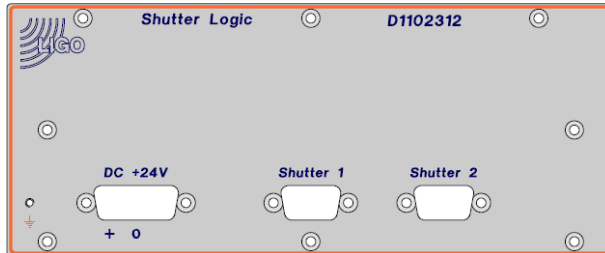

Sxxxxxxx
Rear

ALS Fiber Distribution Chassis D1200136 Sxxxxxxx +-17VDC, +-24VDC

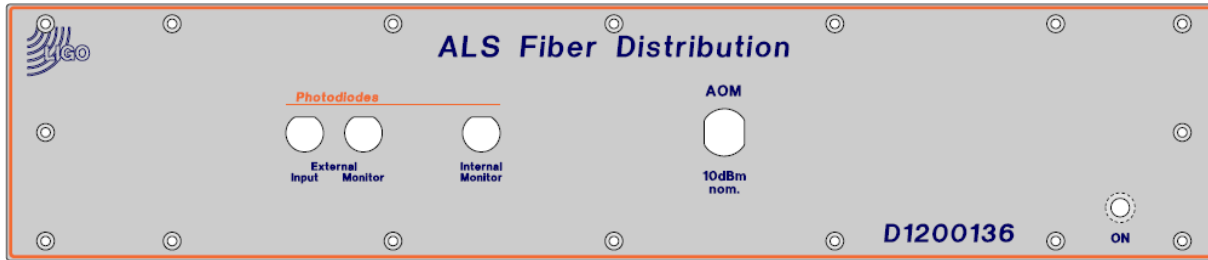

D1200136
Front

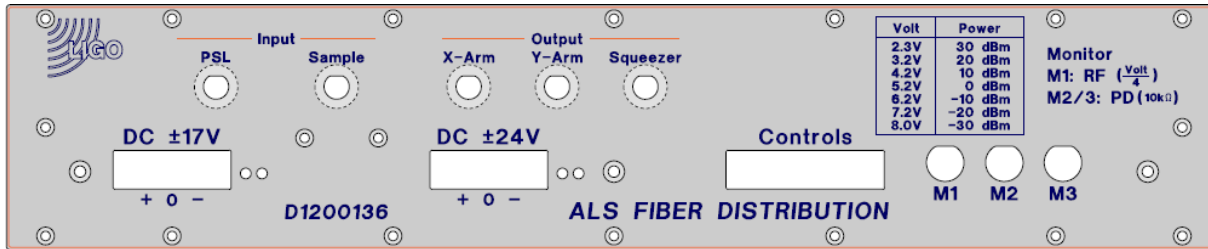

Sxxxxxxx
Rear



ISC R3

ISC LVEA HAM 6

41 U

2 U	RF Patch Panel 15
2 U	RF Patch Panel 16
1 U	D1000134 9.099 / 8.684 MHz Distribution Amplifier
1 U	D1000134 36 MHz Distribution Amplifier
1 U	D1000124 45 MHz Distribution Amplifier
1 U	D1002559 ISC Whitening Chassis (ASC ASAIR A 36MHz)
1 U	D0902796 WFS I/Q Demodulator (ASC ASAIR A 36MHz)
1 U	D1100905 WFS Demodulator Patch Panel
1 U	D0902796 WFS I/Q Demodulator (ASC ASAIR A 45MHz)
1 U	D1002559 ISC Whitening Chassis (ASC ASAIR A 45MHz)
1 U	D1002559 ISC Whitening Chassis (Spare Chain for air to vac leapfrog)
1 U	D0902796 WFS I/Q Demodulator (Spare Chain for air to vac leapfrog)
1 U	D1100905 WFS Demodulator Patch Panel (Spare Chain for air to vac leapfrog)
1 U	D1002559 ISC Whitening Chassis (ASC ASAIR B 36MHz)
1 U	D0902796 WFS I/Q Demodulator (ASC ASAIR B 36MHz)
1 U	D1100905 WFS Demodulator Patch Panel
1 U	D0902796 WFS I/Q Demodulator (ASC ASAIR B 45MHz)
1 U	D1002559 ISC Whitening Chassis (ASC ASAIR B 45MHz)
1 U	D1002559 ISC Whitening Chassis (LSC ASAIR A 45MHz, LSC ASAIRB 19MHz, LSCASAIR B 90 MHz)
1 U	D0902796 LSC I/Q Demodulator (LSC ASAIR A 45MHz, LSC ASAIRB 19MHz, LSCASAIR B 90 MHz)
1 U	D1100905 LSC Demodulator Patch Panel

LIGO-D1001426-v7

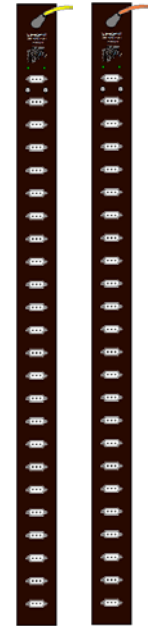
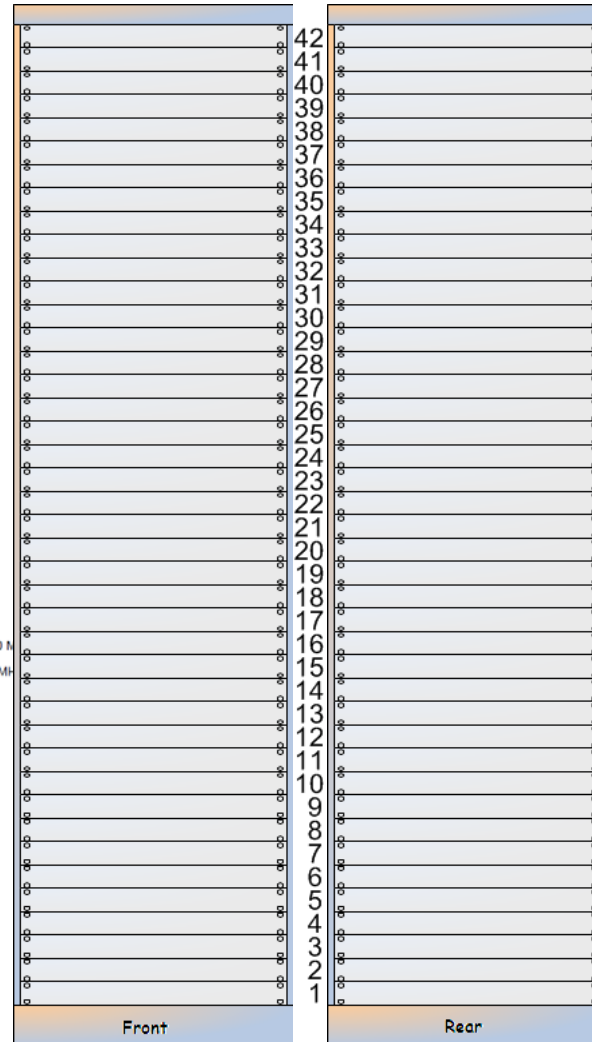



ISC R4

Serves HAM 1 and HAM 3

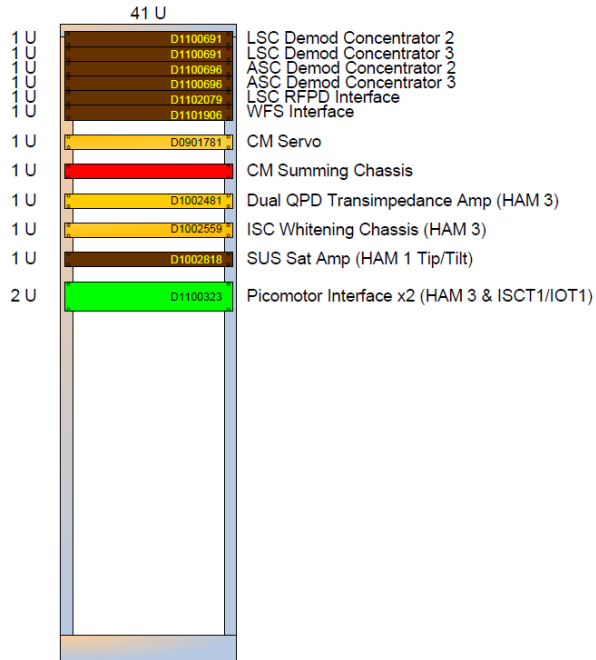

LIGO-D1101904-v4

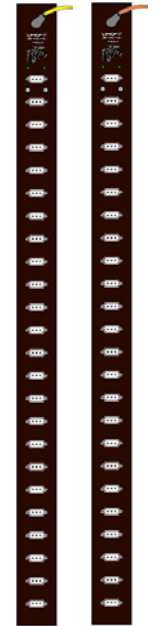
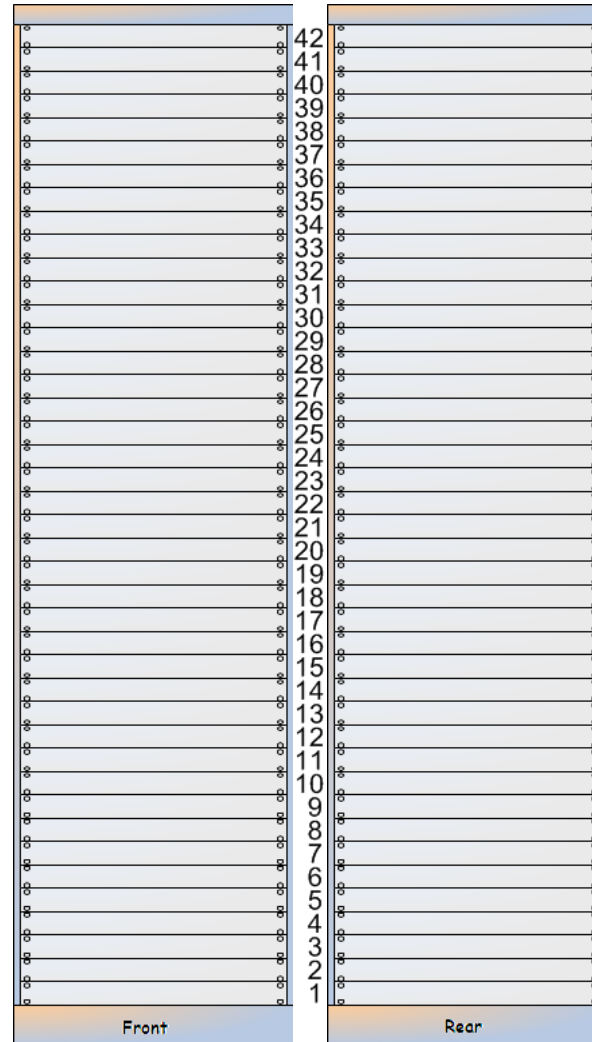



ISC R5

Serves LVEA HAM 6

41 U

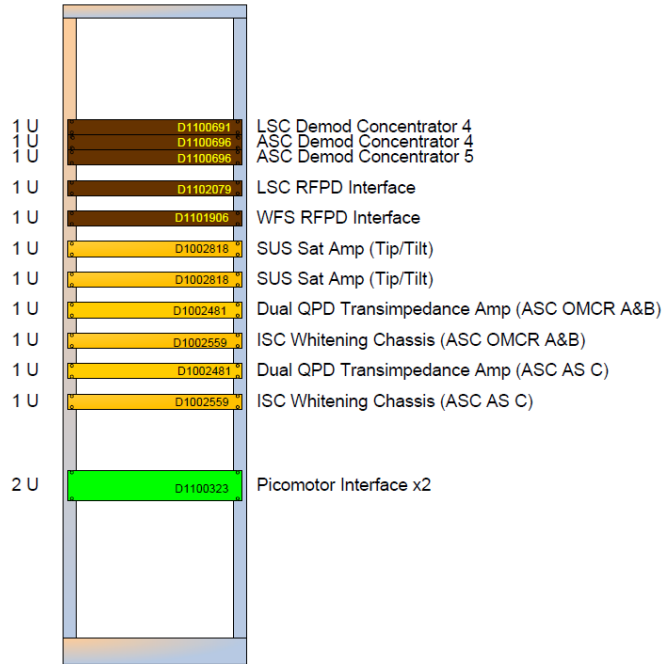

[LIGO-D1200196-v3](#)

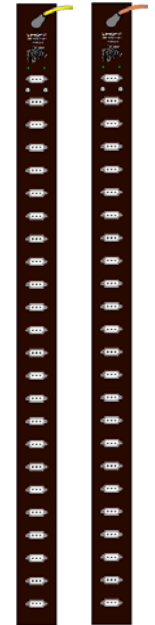
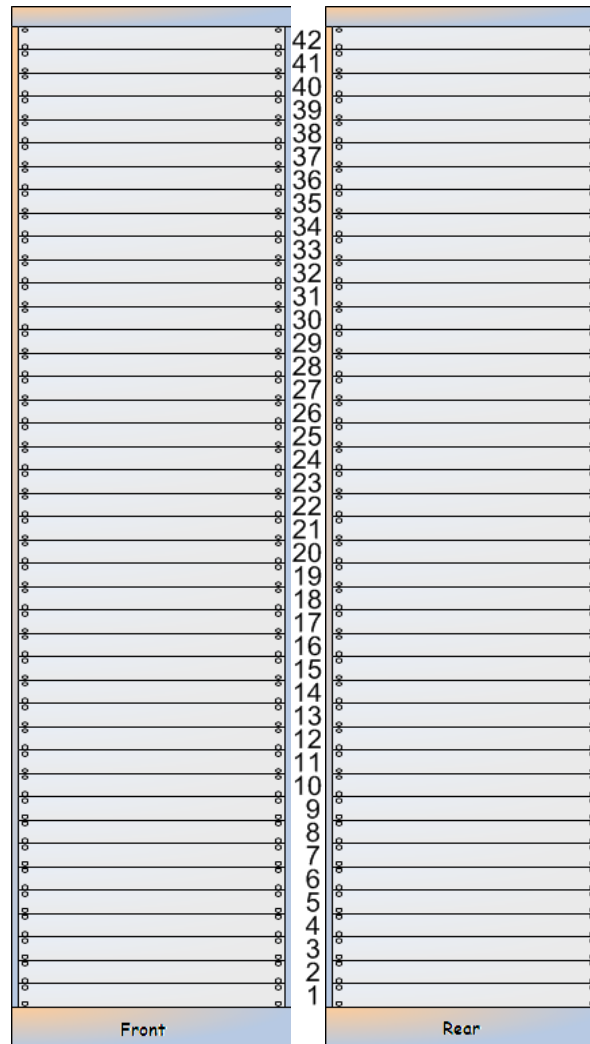

L1-ISC-R1 Details

24.078 MHz Distribution Amplifier D1000124 Sxxxxxxx ±17VDC, ±24VDC

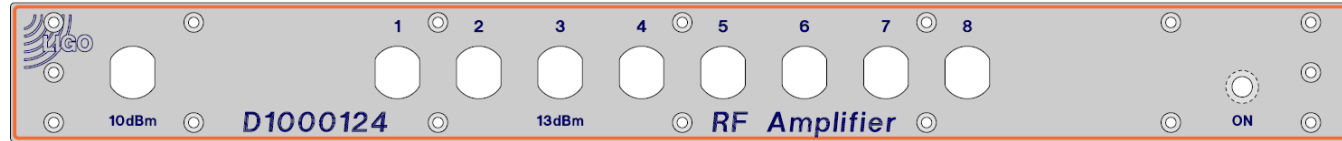

[D1000124](#)

Front

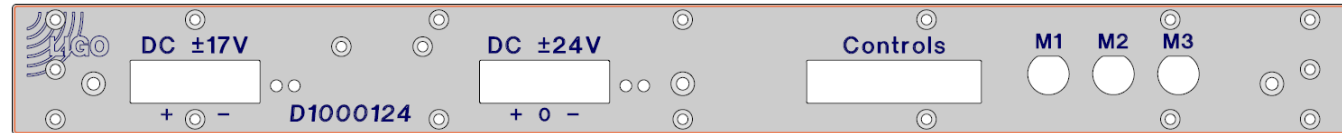

[S1001232](#)

Rear

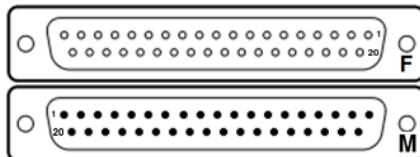

<< L1-ISC-R1

79.4 MHz VCO (ALS)

D0900605

Sxxxxxxx

±17VDC, ±24VDC

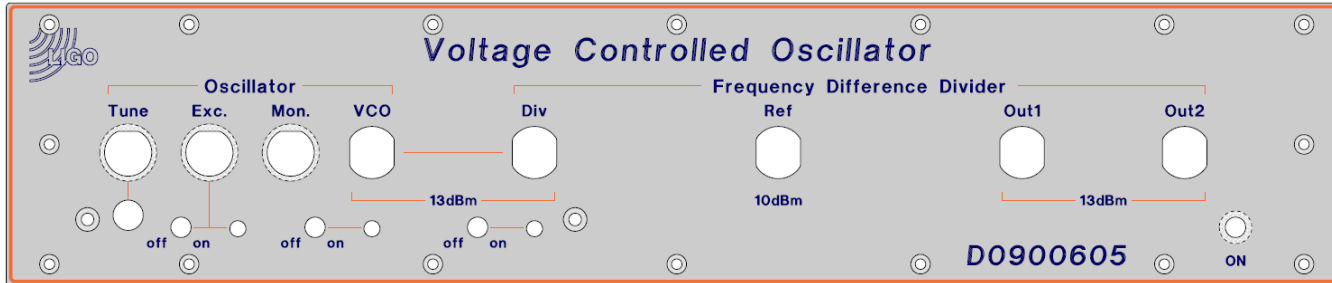

D0900605

Front

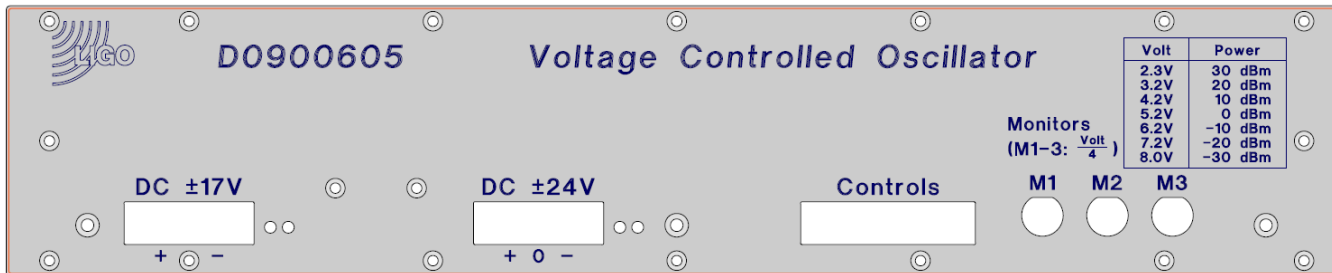

S1001232

Rear

<< [L1-ISC-R1](#)

24.078 MHz Distribution Amplifier

[D1002178](#)

[Sxxxxxxx](#)

±17VDC, ±24VDC

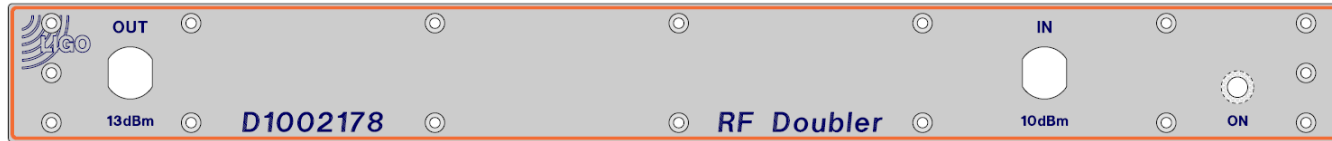

[D1002178](#)

Front

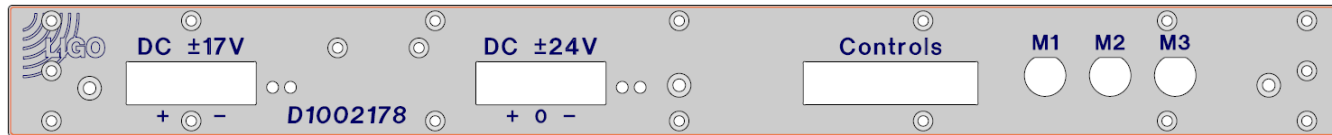

[S1001232](#)

Rear

<< [L1-ISC-R1](#)

158.8 / 79.4 MHz 2-Channel PF Discriminator

[D1002476](#)

[Sxxxxxxx](#)

±17VDC, ±24VDC

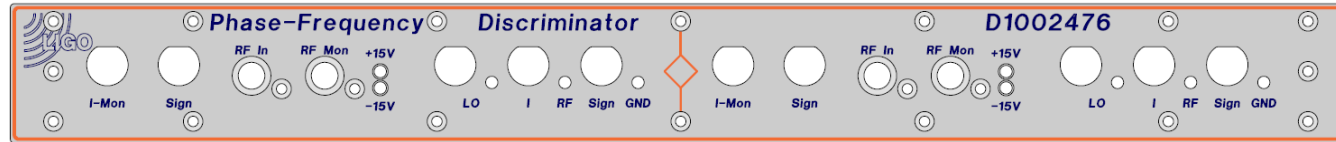

[D1002476](#)

Front

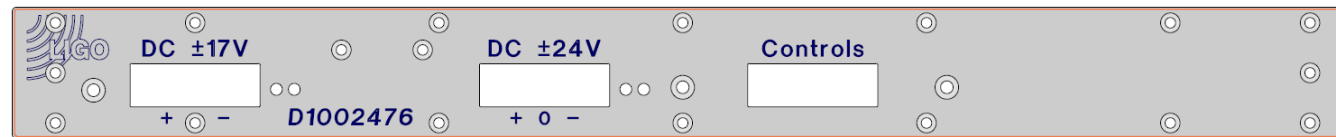

[S1001232](#)

Rear

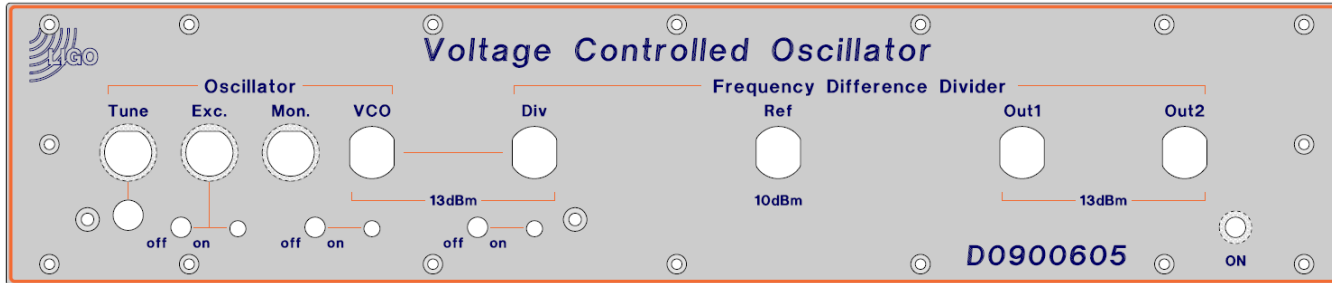

D0900605

Front

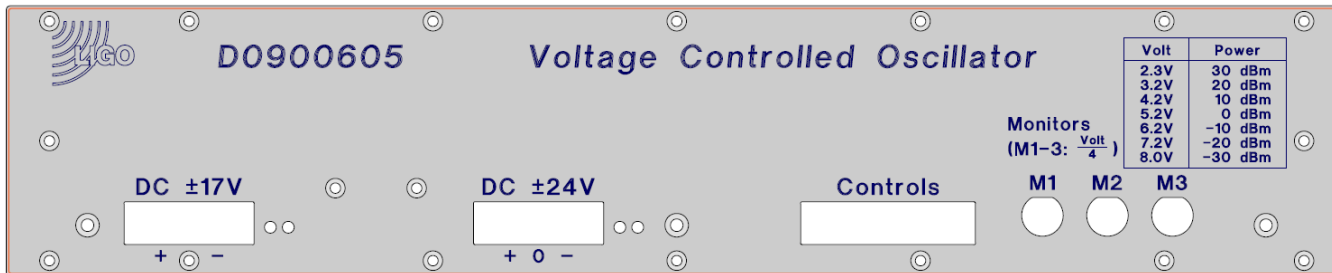

S1001232

Rear

<< L1-ISC-R1

79.4 MHz VCO (ALS)

D0900605

Sxxxxxxx

±17VDC, ±24VDC

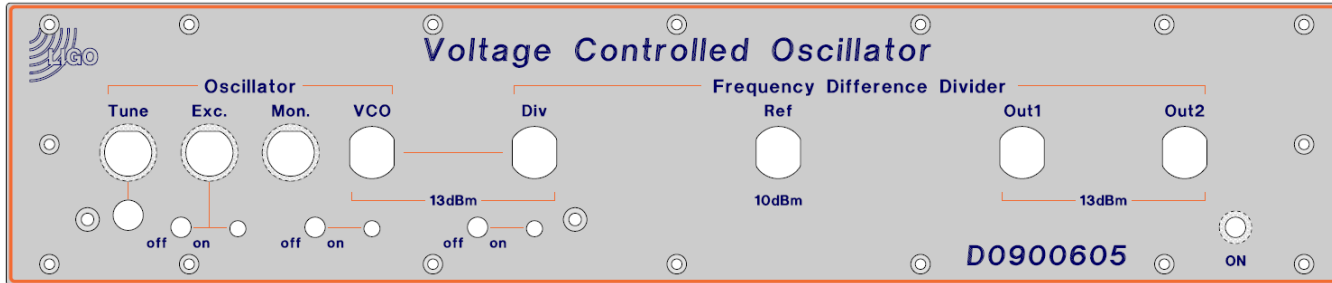

D0900605

Front

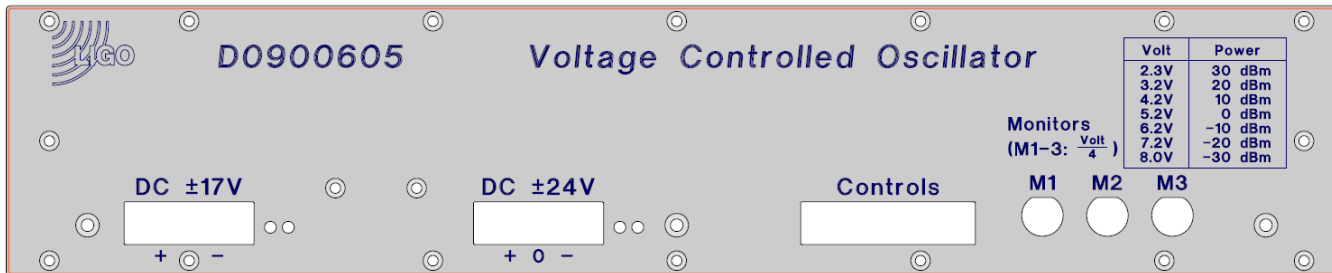

S1001232

Rear

D1002178 - Sxxxxxxx



<< [L1-ISC-R1](#)

24.078 MHz Distribution Amplifier

[D1002178](#)

[Sxxxxxxx](#)

±17VDC, ±24VDC

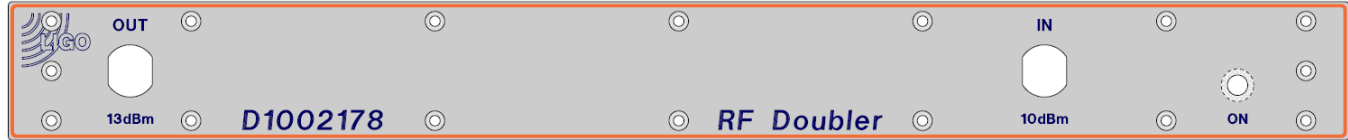

[D1002178](#)

Front

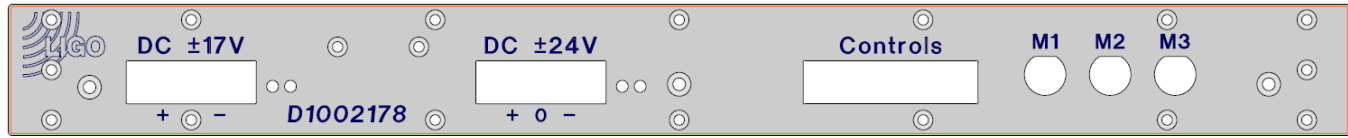

[S1001232](#)

Rear

<< L1-ISC-R1

24.078 MHz Dual Delay Line +15VDC

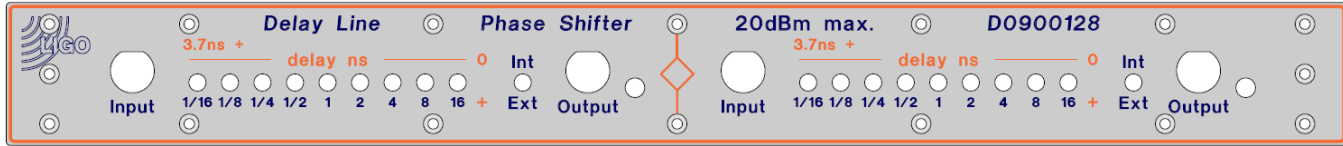

D0900128

Front



Sxxxxxxx

Rear

<< L1-ISC-R1

24.078 MHz 2-Channel Demodulator ±17VDC, ±24VDC

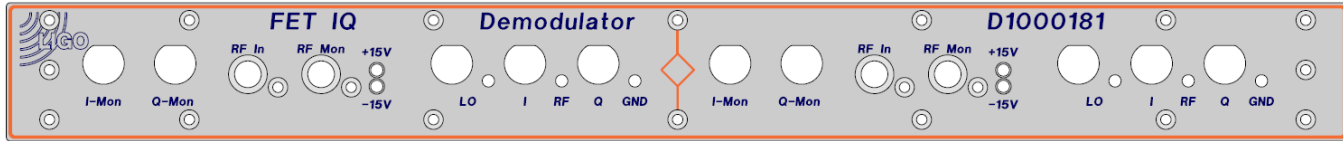

D1000181

Front

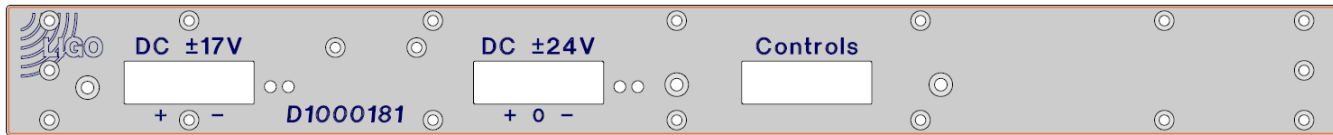

Sxxxxxxx

Rear

D0901781 - Sxxxxxxx



<< L1-ISC-R1

Mode Cleaner Servo ±17VDC, ±24VDC

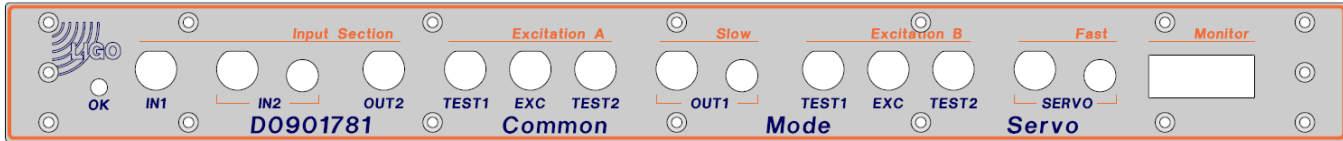

D0901781

Front

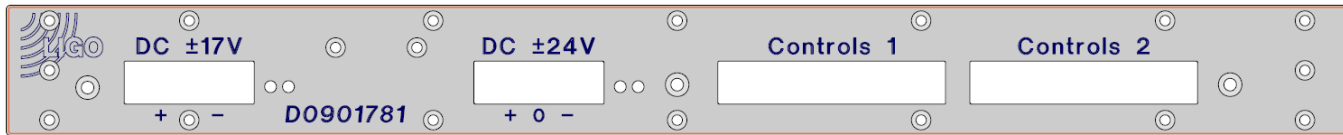

Sxxxxxxx

Rear

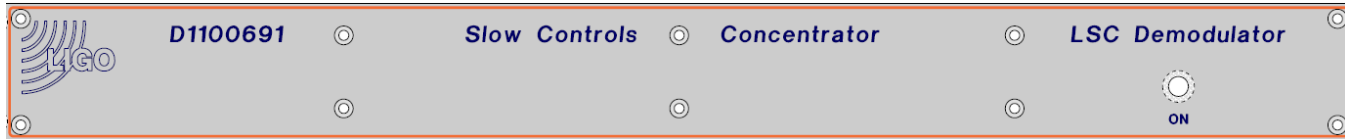

[D1100691](#)

Front

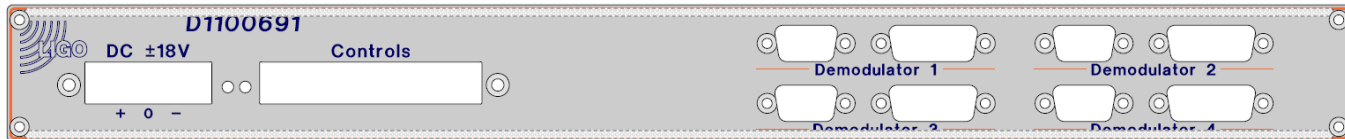

Sxxxxxxx

Rear

D1100696 - Sxxxxxxx



<< L1-ISC-R1

ASC Demod Concentrator 1 ±18VDC

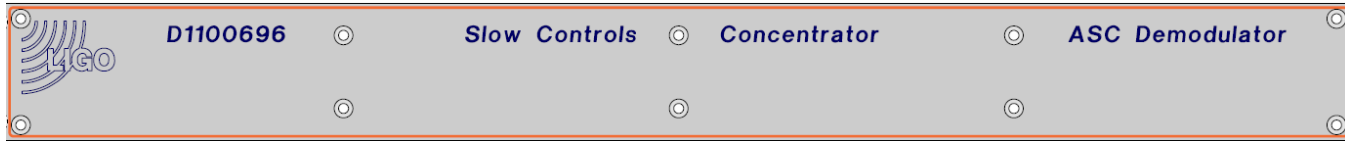

D1100696

Front

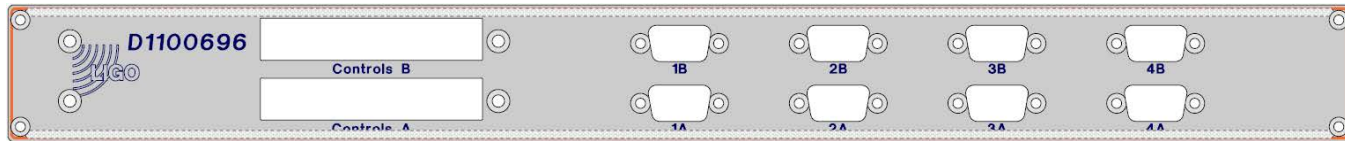

Sxxxxxxx

Rear

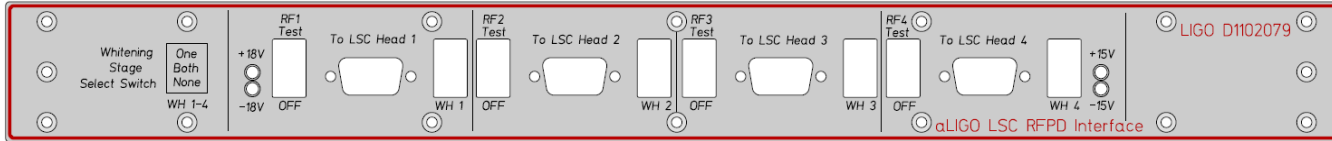

D1102079

Front

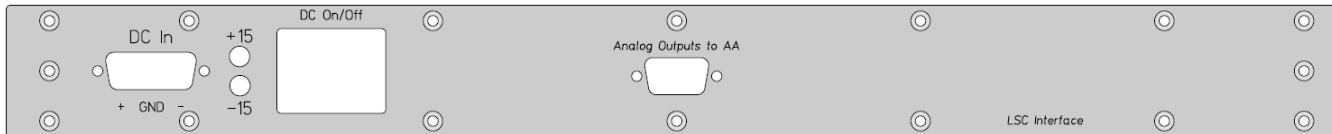

Sxxxxxxx

Rear

<< L1-ISC-R1

WFS Interface D1101865 Sxxxxxxx ±15VDC

D1101905

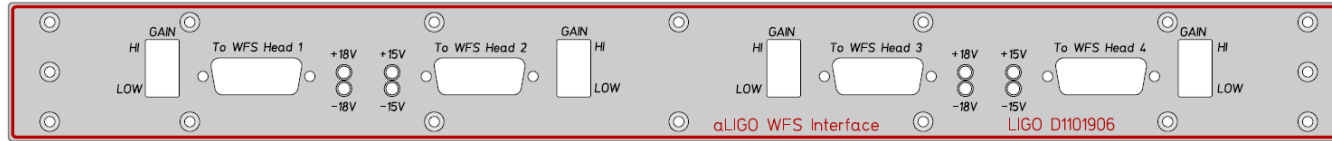

D1101865

Front

D1101908

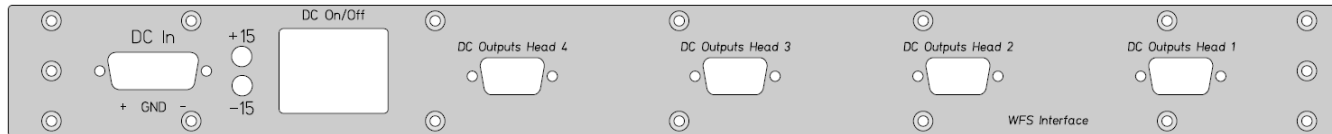

Sxxxxxxx

Rear

<< [L1-ISC-R1](#) ISC Whitening Chassis (ASC IMC WFS_A 24MHz) D1002559 Sxxxxxxx ±15VDC

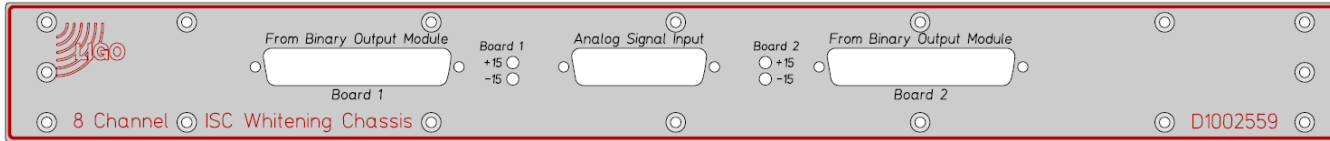

[D1002559](#)

Front

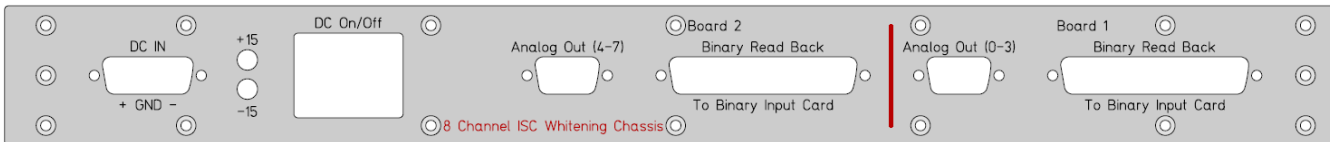

Sxxxxxxx

Rear

<< L1-ISC-R1 ISC Whitening Chassis (ASC IMC WFS_A 24MHz) D0902796 Sxxxxxxx ±15VDC

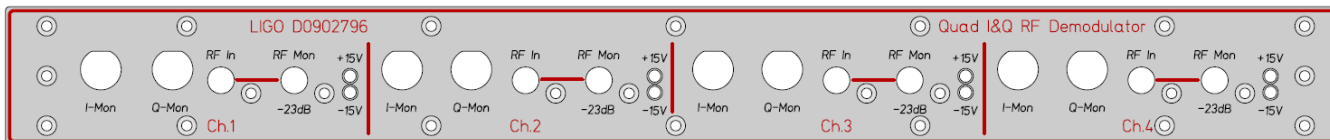

D0902796

Front

D1002032

LSC

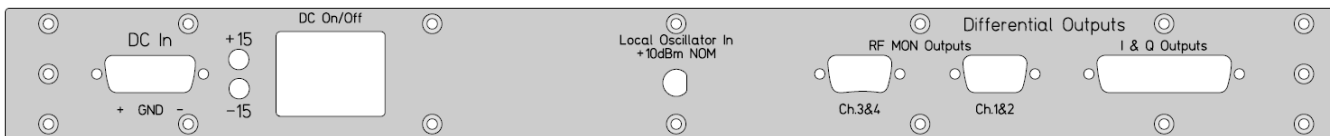

Sxxxxxxx

Rear

D1002031

WFS

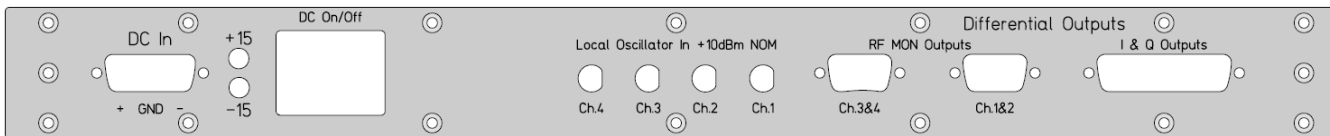

<< [L1-ISC-R1](#)

Demodulator Patch Panel

[D1100905](#)

[Sxxxxxxx](#)

No Power

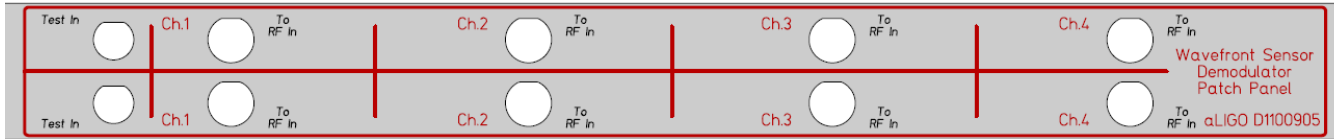

[D1100905](#)

Front

[Sxxxxxxx](#)

<< [L1-ISC-R1](#) ISC Whitening Chassis (ASC IMC WFS_B 24MHz) D0902796 Sxxxxxxx ±15VDC

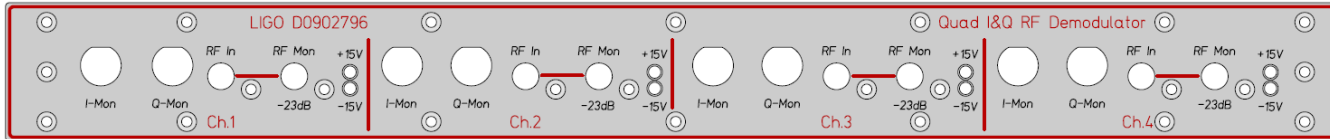

[D0902796](#)

Front

[D1002032](#)

LSC

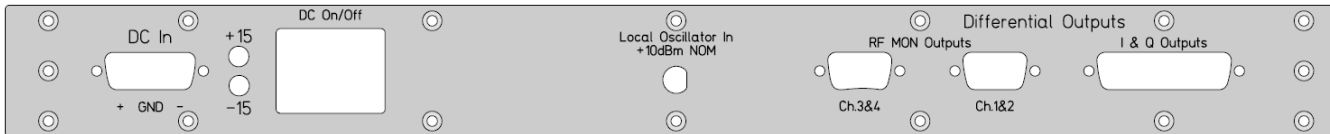

Sxxxxxxx

Rear

[D1002031](#)

WFS

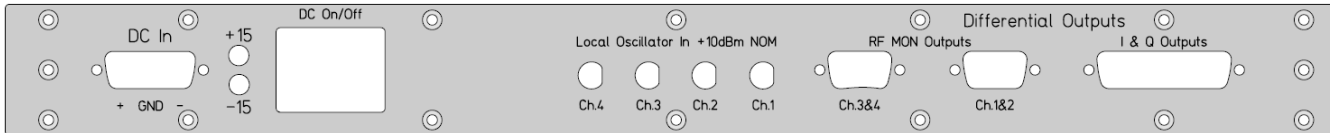

<< [L1-ISC-R1](#) ISC Whitening Chassis (ASC IMC WFS_A 24MHz) D1002559 Sxxxxxxx ±15VDC

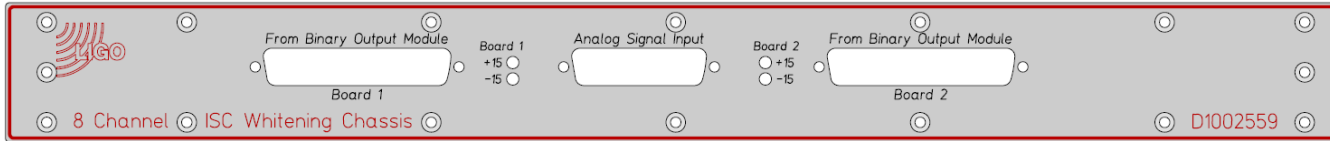

[D1002559](#)

Front

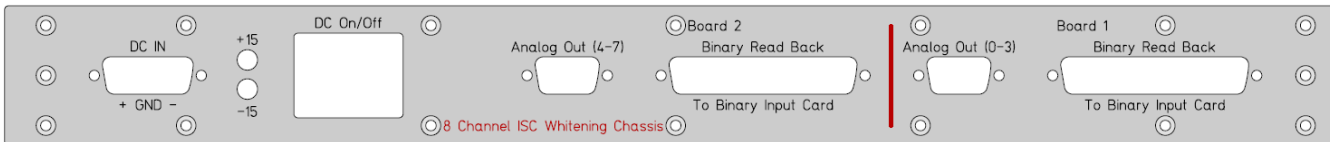

Sxxxxxxx

Rear

L1-ISC-R2 Details

L1-ISC-R3 Details

L1-ISC-R4 Details

L1-ISC-R5 Details

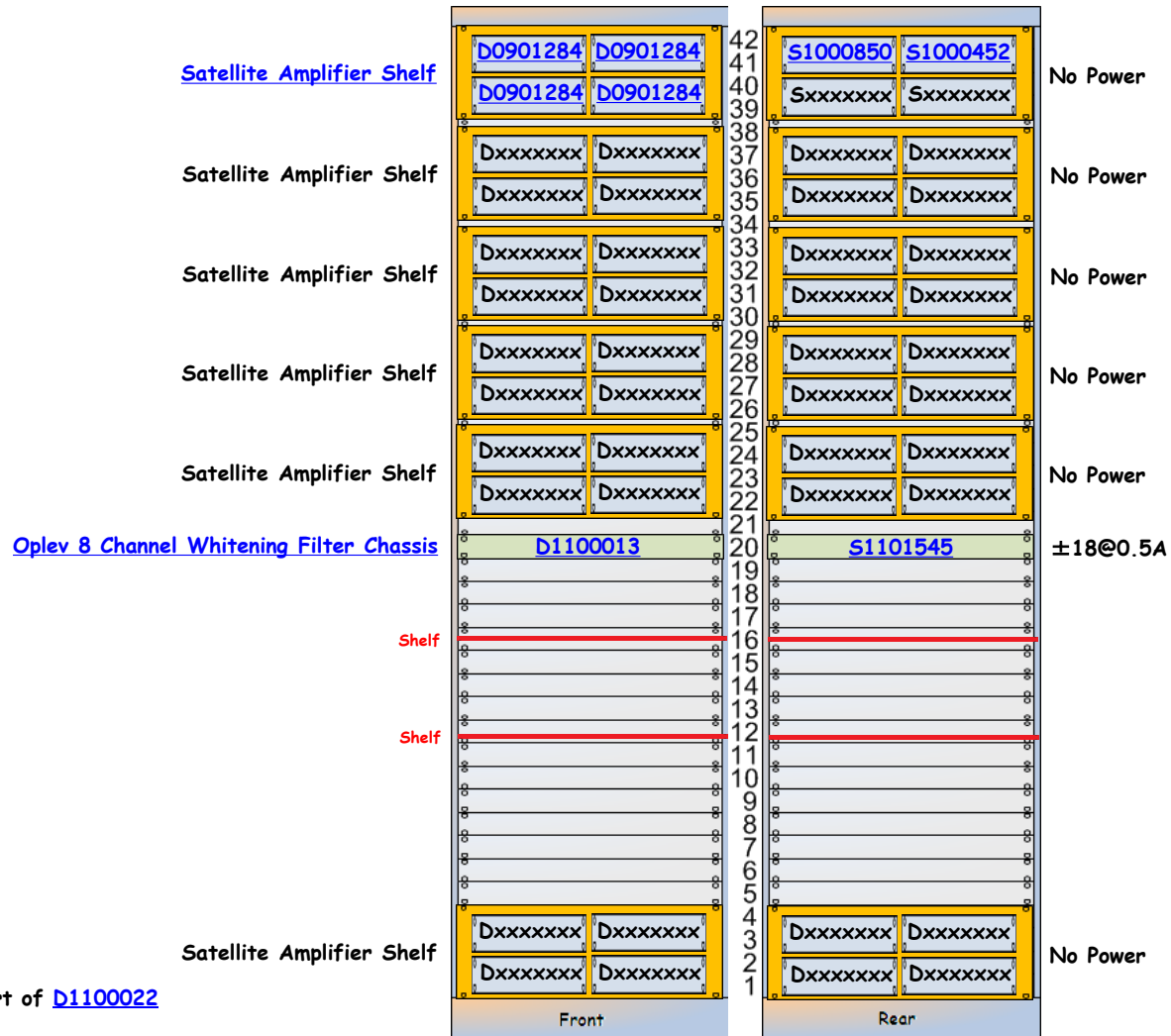

D0901284 Shelf

Satellite Amplifier Shelf

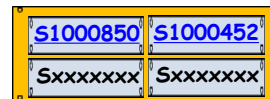
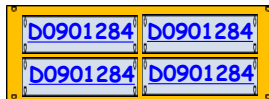

No Power

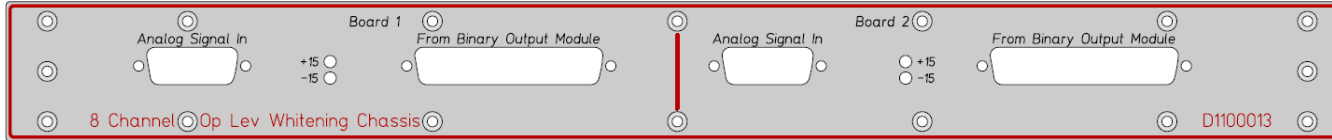

[D1002559](#)

Front

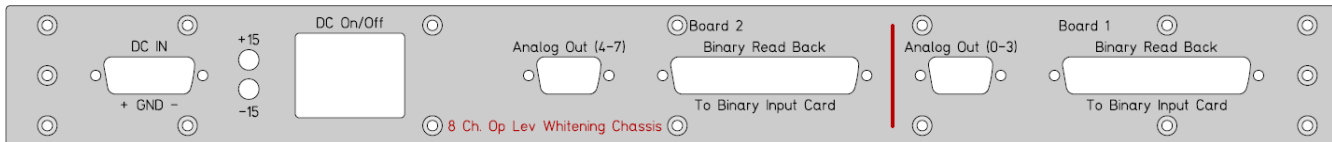
[S1101545](#)

Rear

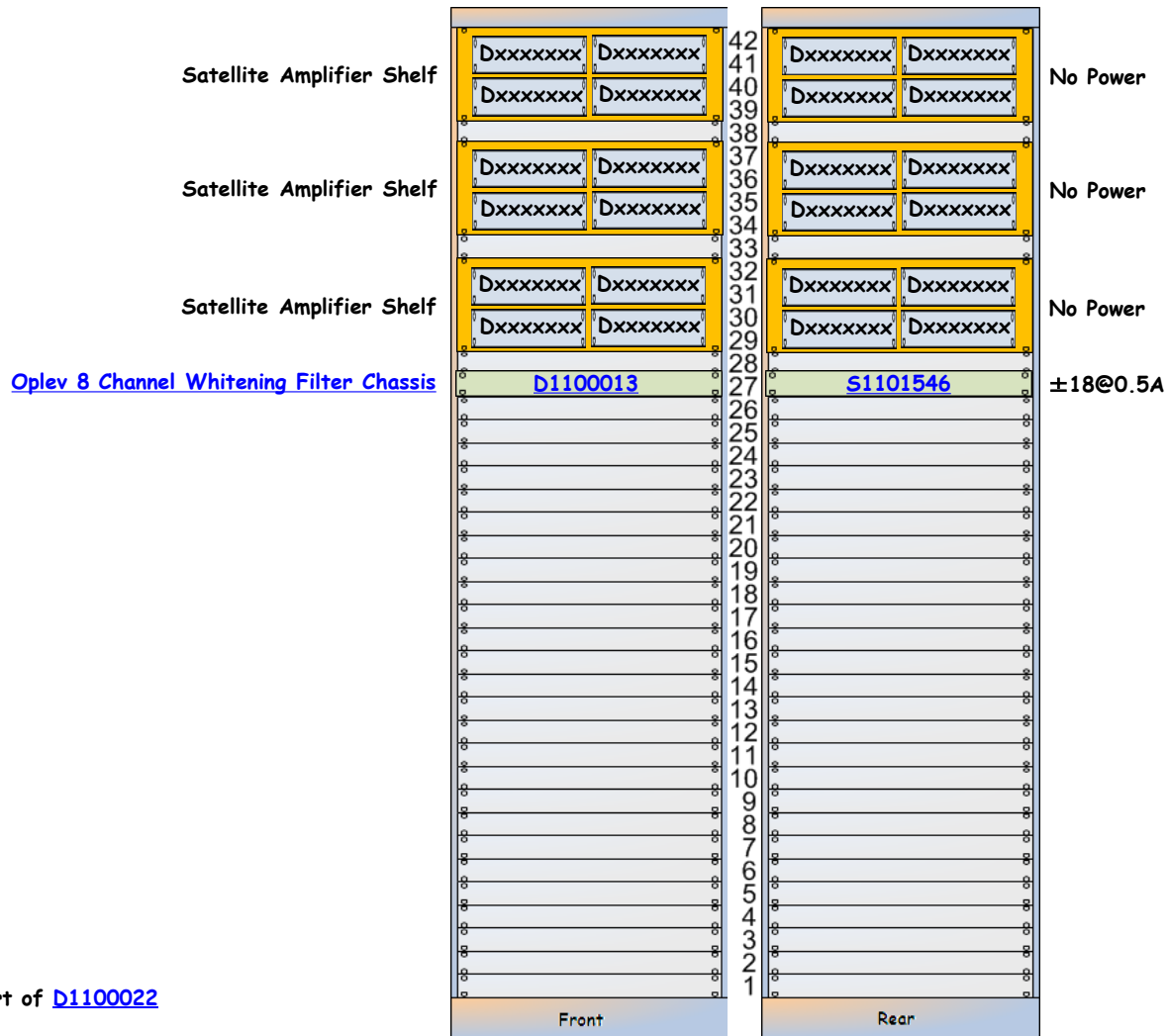

SUS-R2 is part of [D1100022](#)

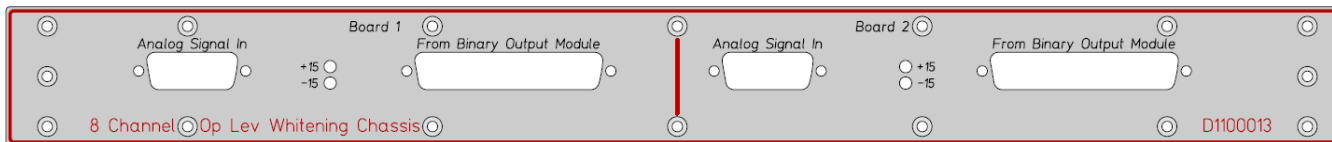

[D1002559](#)

Front

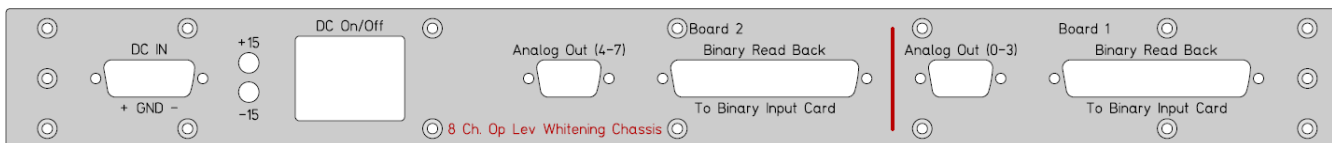
[S1101546](#)

Rear

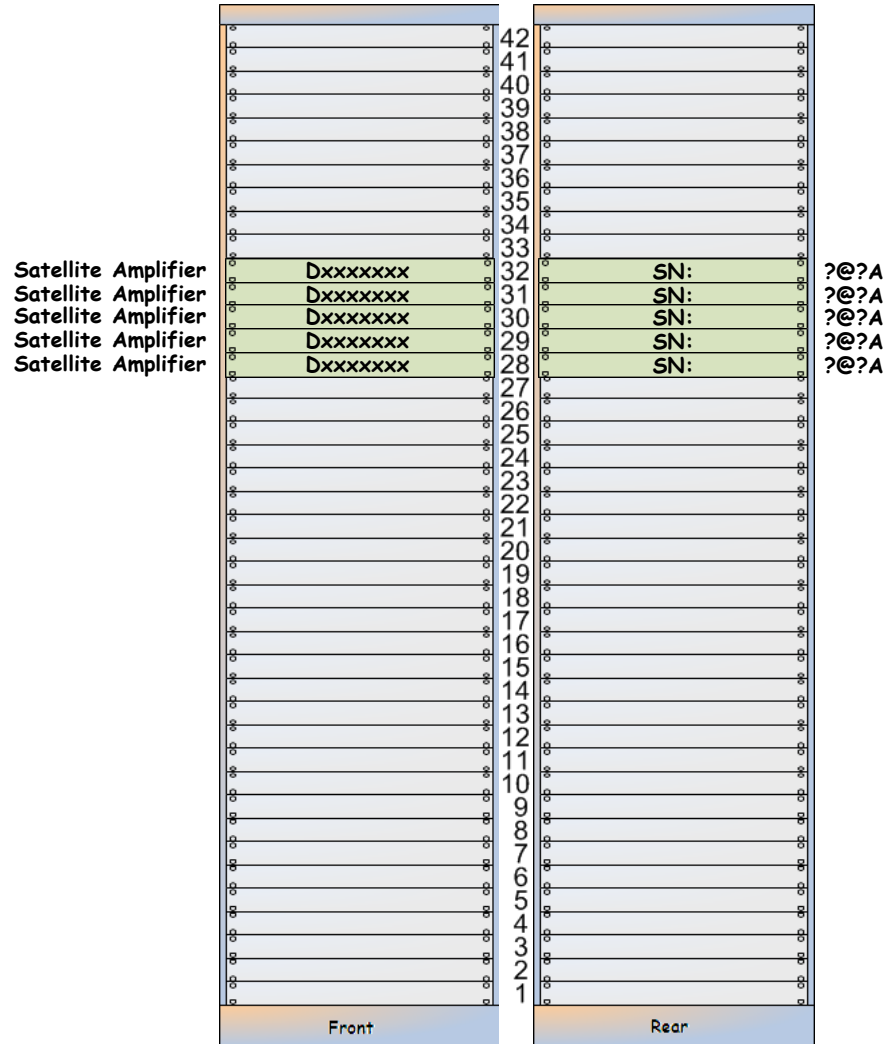

SUS-R3 is part of [D1100022](#)



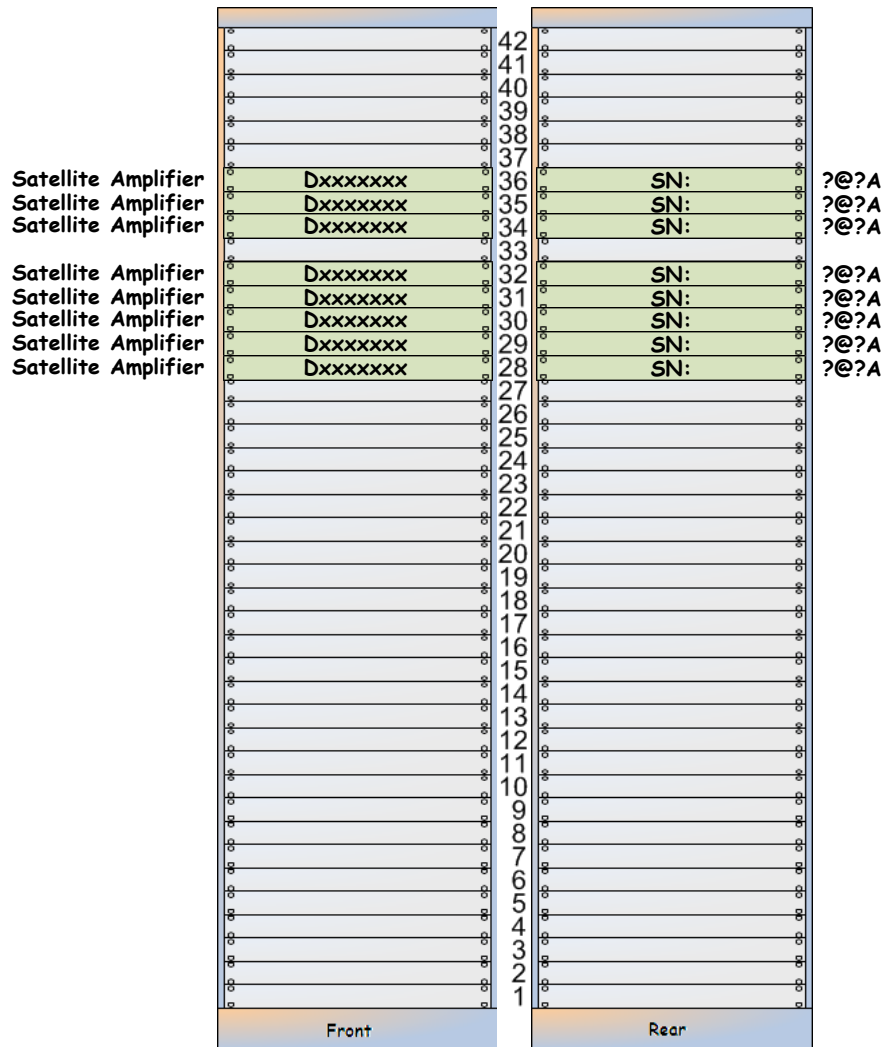

SUS-R4 is part of [D1100022](#)



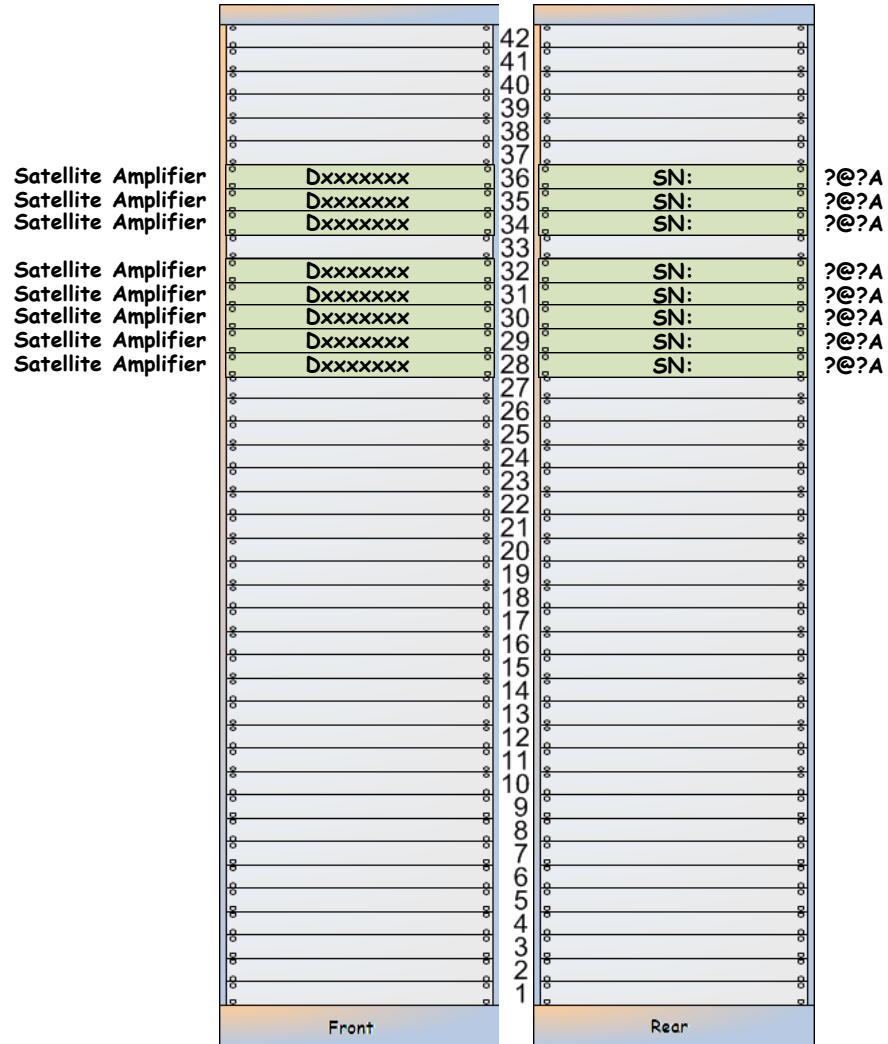

SUS-R5 is part of [D1100022](#)

SUS-R5 is part of [D1001725](#)



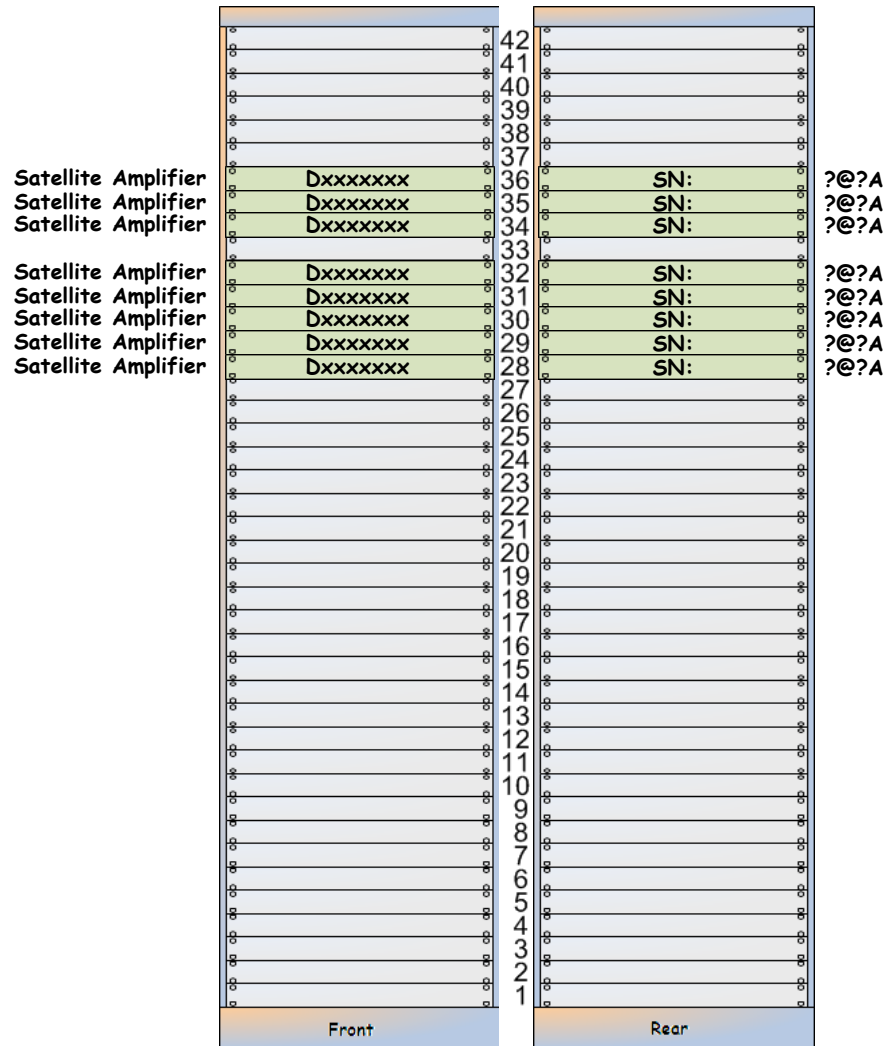

SUS-R6 is part of [D1100022](#)

SUS-R6 is part of [D1001725](#)



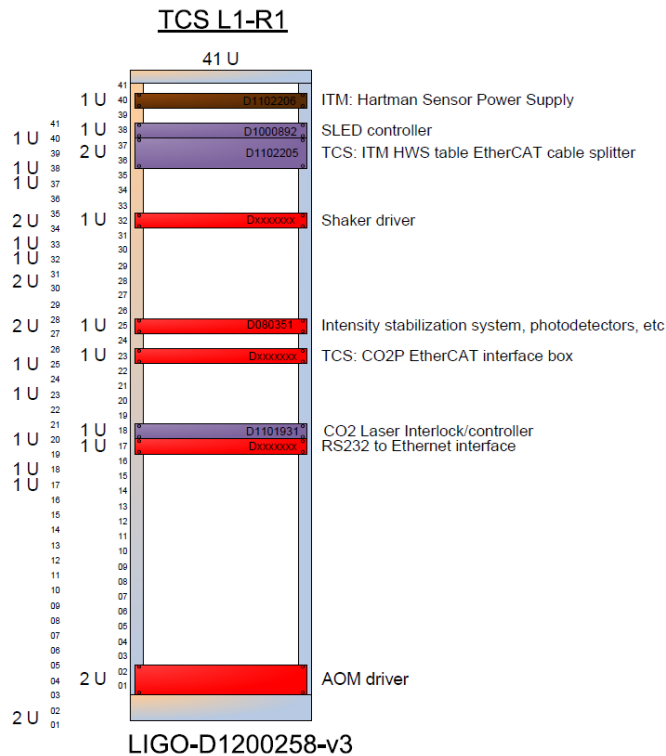

+18VDC	?A
-18VDC	?A
+24VDC	?A

TCS-R1 is part of [D1200258](#)

AOM Driver

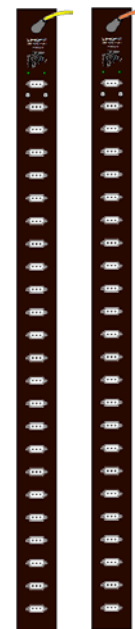
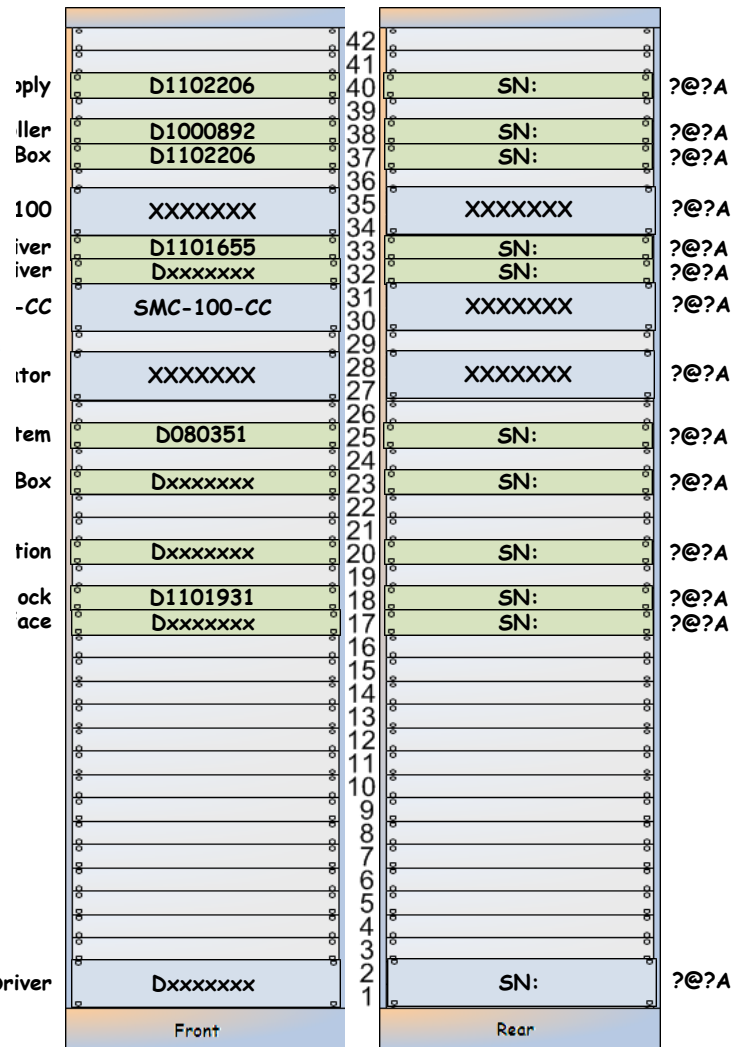

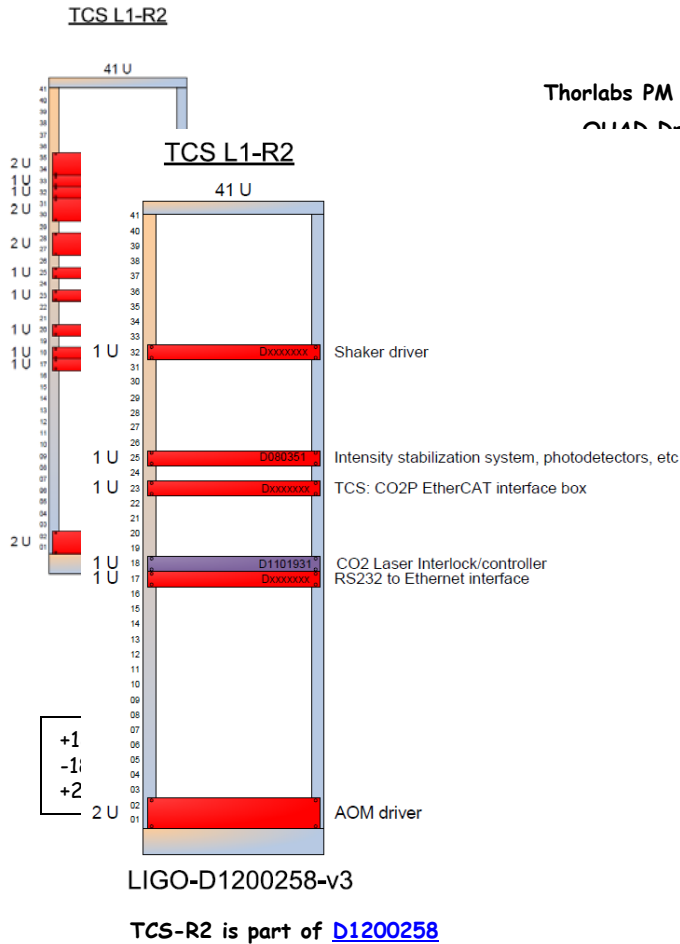

	42		
	41		
	40		
	39		
	38		
	37		
	36		
	35	XXXXXXX	?@?A
	34	D1101655	?@?A
	33	Dxxxxxxx	?@?A
	32	SMC-100-CC	SN: ?@?A
	31		SN: ?@?A
	30	XXXXXXX	XXXXXXX
	29		
	28	XXXXXXX	XXXXXXX
	27		
	26		
	25	D080351	SN: ?@?A
	24	Dxxxxxxx	SN: ?@?A
	23		
	22		
	21	Dxxxxxxx	SN: ?@?A
	20		
	19	D1101931	SN: ?@?A
	18	Dxxxxxxx	SN: ?@?A
	17		
	16		
	15		
	14		
	13		
	12		
	11		
	10		
	9		
	8		
	7		
	6		
	5		
	4		
	3		
	2	Dxxxxxxx	SN: ?@?A
	1		
		Front	Rear



L1-VAC-R1 LVEA Vacuum Rack Layout (Dxxxxxxx)

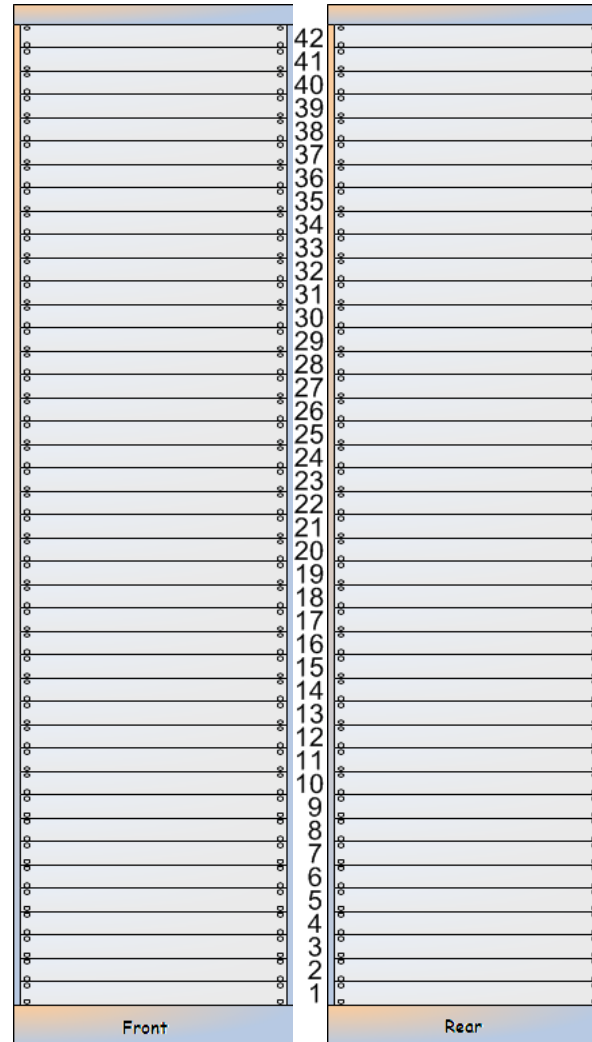

L1-VAC-R2 LVEA Vacuum Rack Layout (Dxxxxxxx)

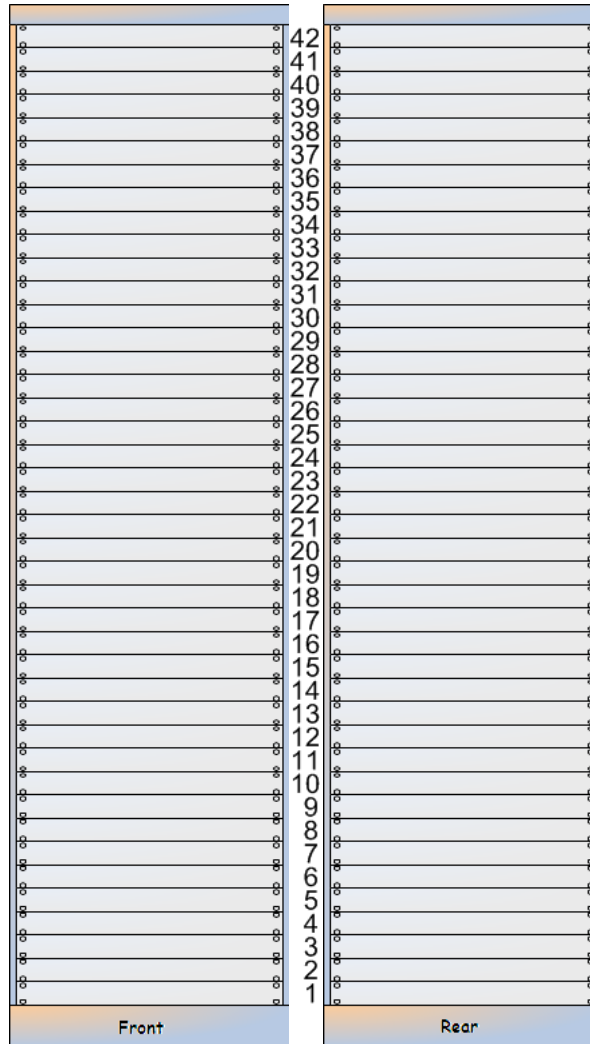

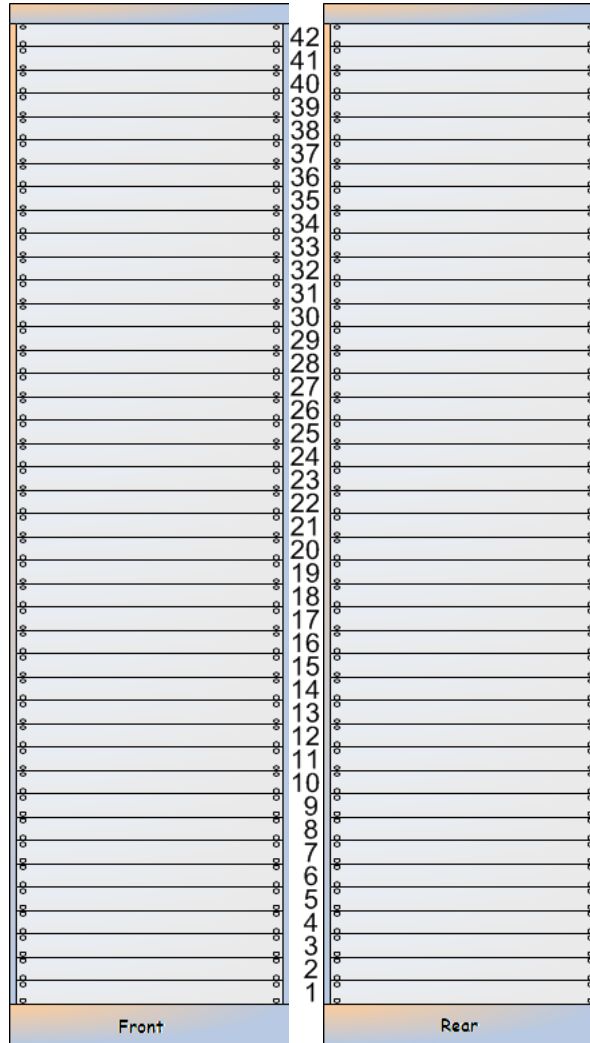

[<< LLO Corner Station](#)

[<< LLO Racks by AREA](#)

[<< LLO CDS Components](#)

VEAX

X-End Station Rack Layout

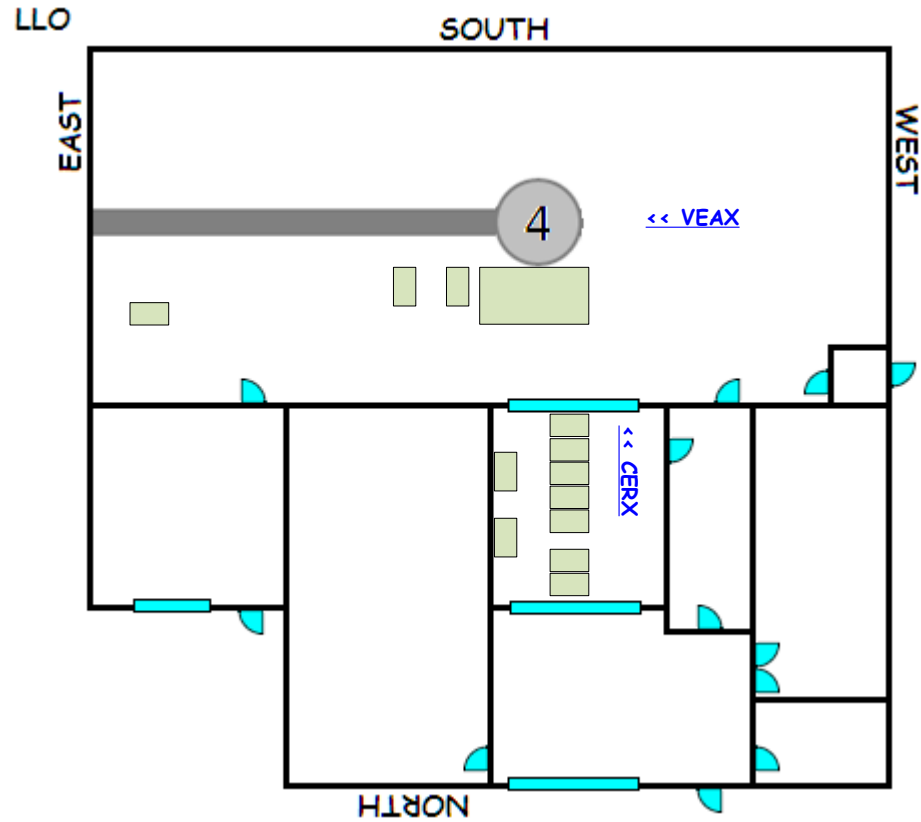

X-End Station Rack Layout

<< LLO Corner Station

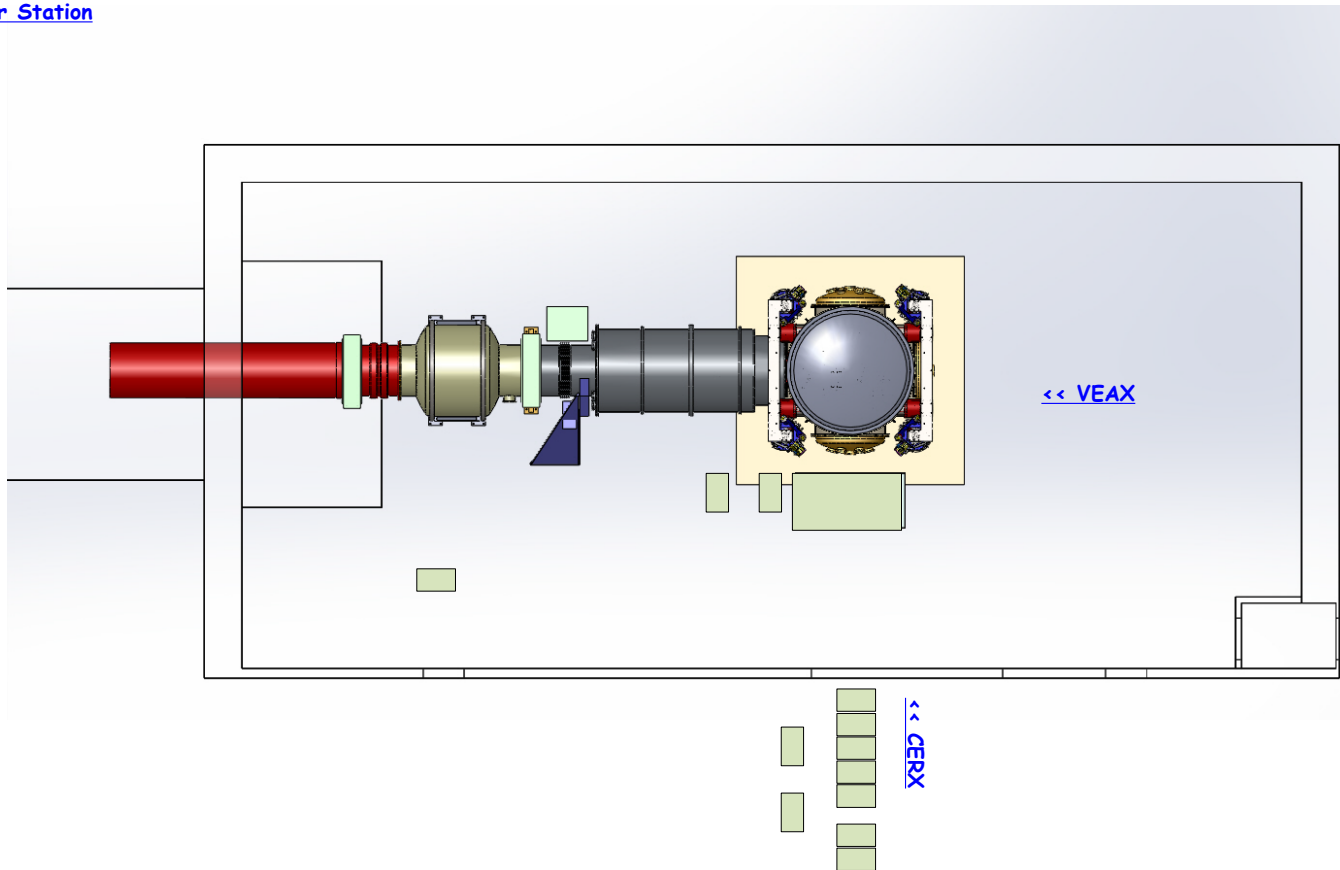

X-End - D0901465

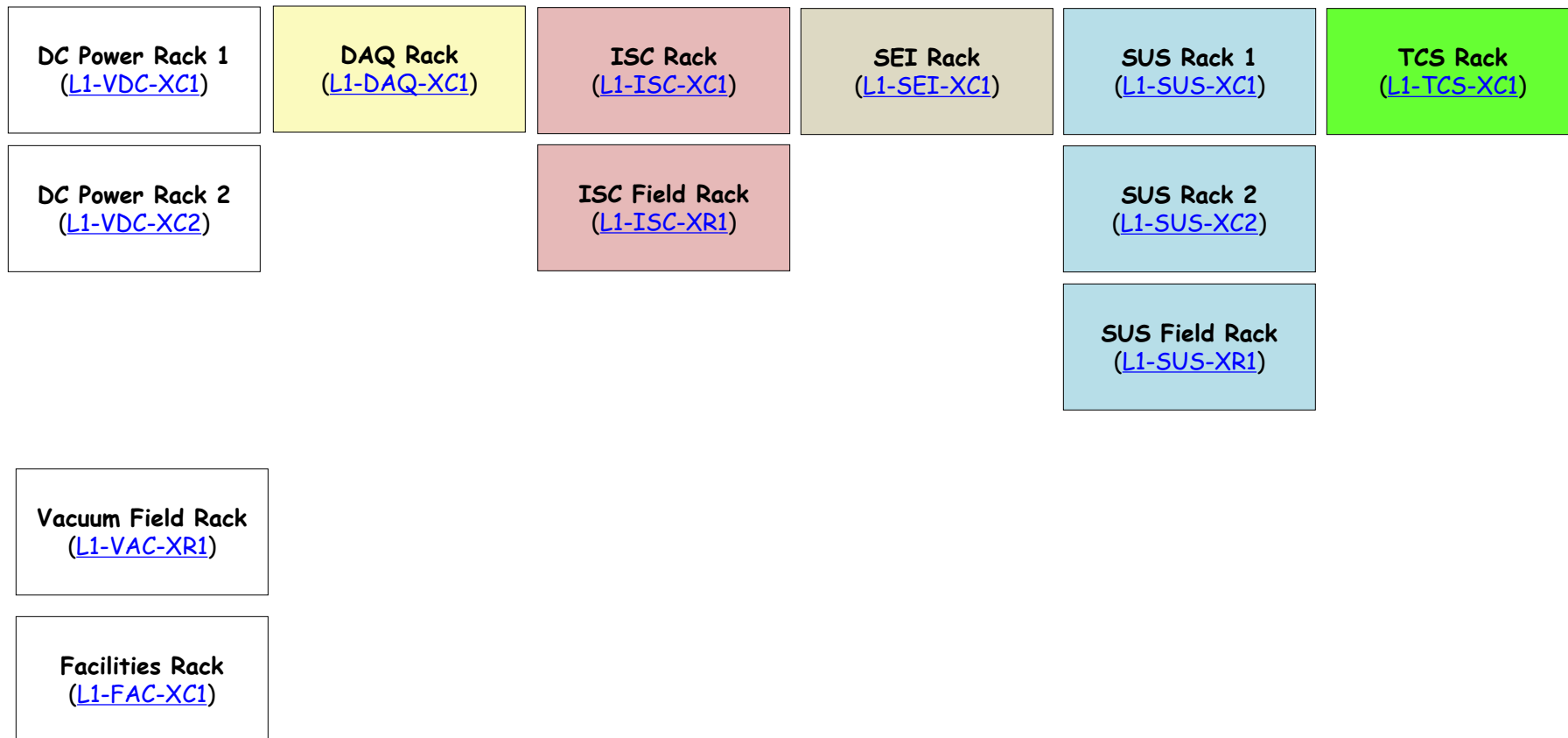

<< X-End Racks

It is 70' from the L1-FAC-XC1 Rack to the knee of the waterfall in the VEAX.

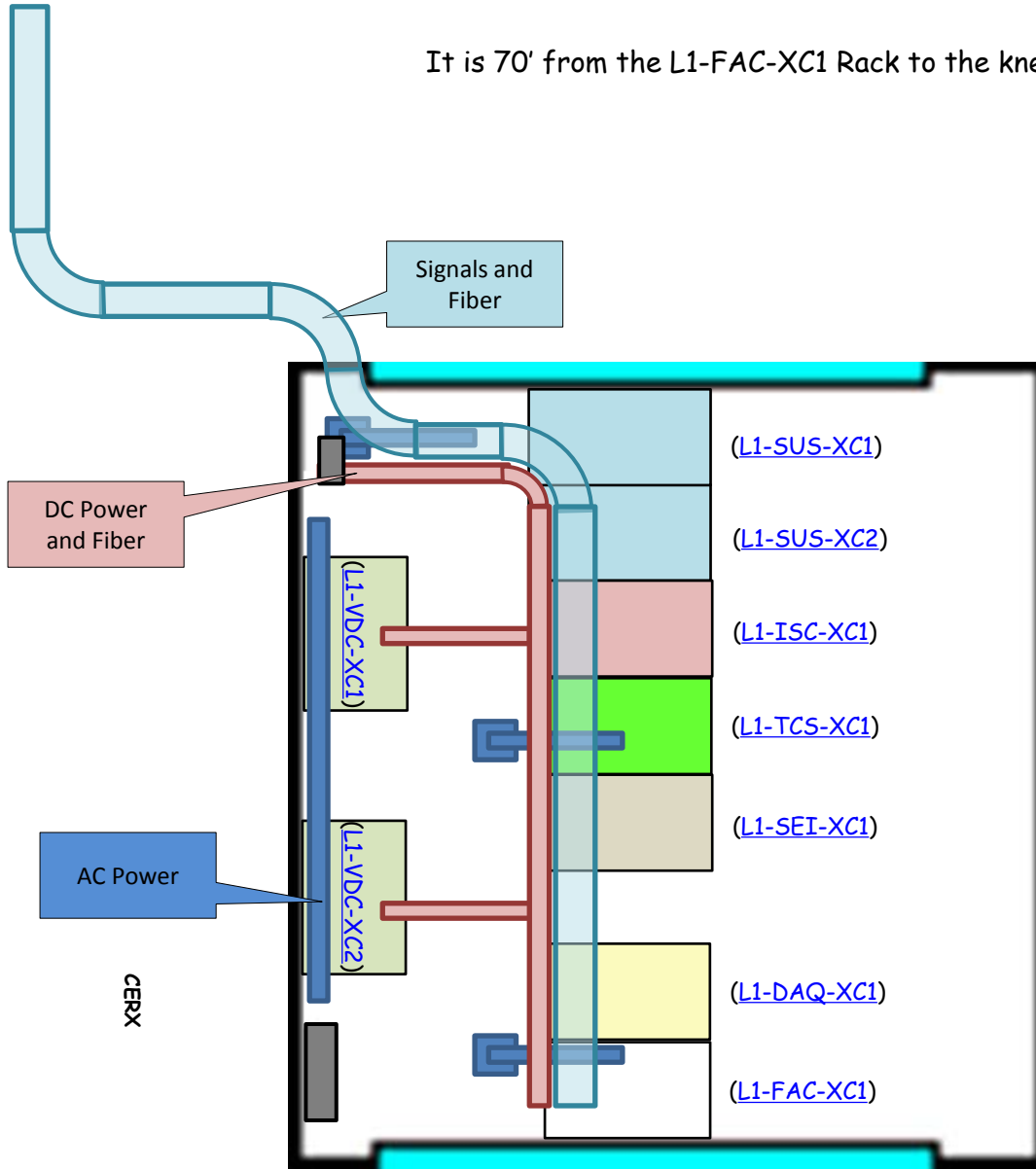

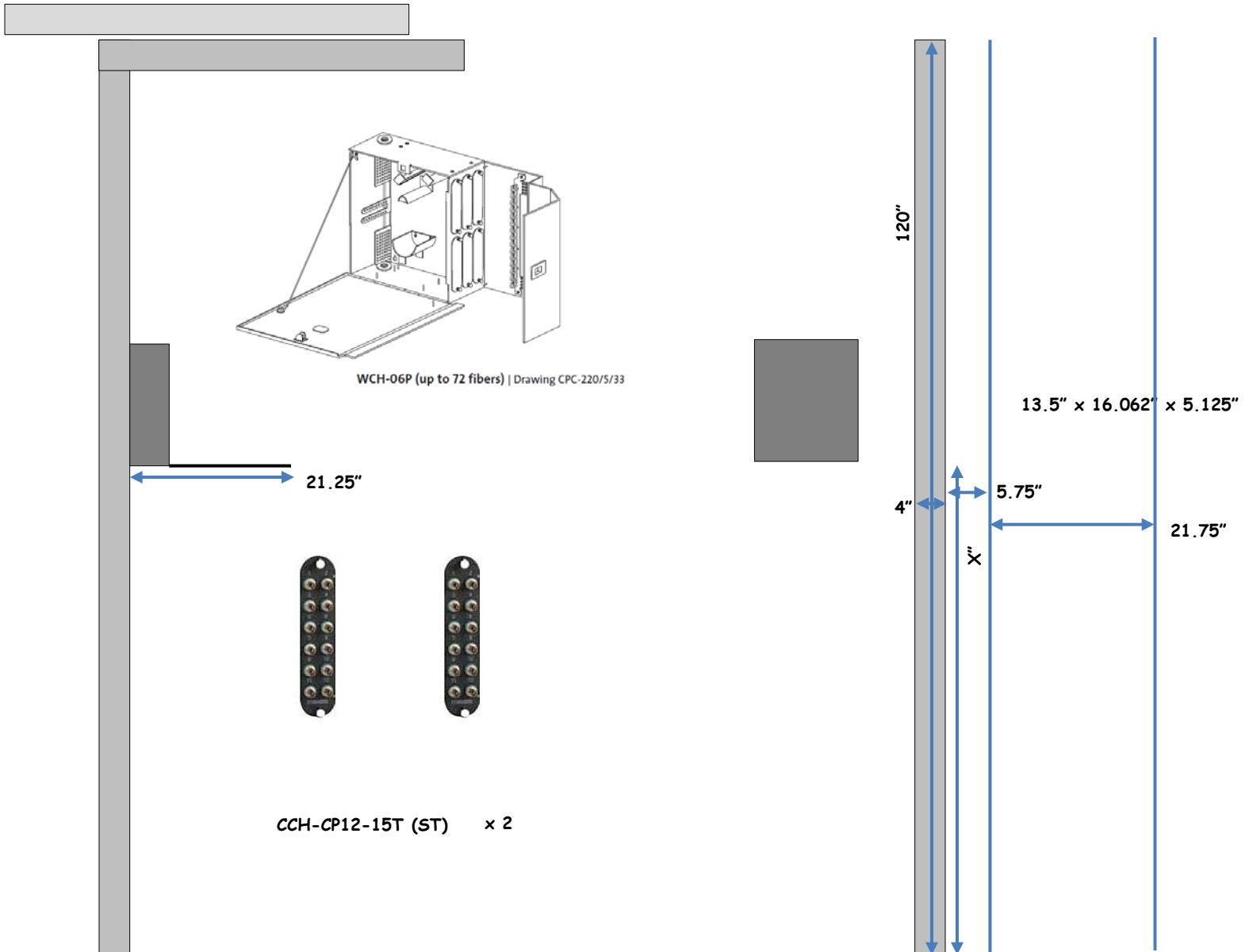

<< 1X23

Patch Panel

Patch Panel

Patch Panel

No Power



FC Connectors

W I1netfedaqx 21F	↔	1-1
Y I1netfedaqx 21F	↔	1-3
TR3030WDM Opt In	↔	1-5
TR3030WDM Opt Out	↔	1-7
Empty	↔	1-9
VT430 Opt In/Out	↔	1-11
T 2402 25F	↔	2-1
N 2402 25F	↔	2-3
W I1lanfex 21F	↔	2-5
Y I1lanfex 21F	↔	2-7
Empty	↔	2-9
Y Brocade Port 1F	↔	2-11

Empty	↔	1-2
S7711DR Opt In/Out	↔	1-4
W ACC-5595 Port 3	↔	1-6
Y ACC-5595 Port 3	↔	1-8
Empty	↔	1-10
Empty	↔	1-12
Empty	↔	2-2
Empty	↔	2-4
W D070011 Fanout Input	↔	2-6
Y D070011 Fanout Input	↔	2-8
W Brocade Port 1F	↔	2-10
Empty	↔	2-12

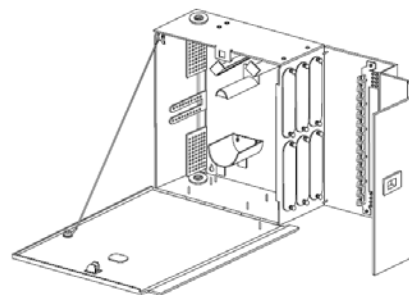

WCH-06P (up to 72 fibers) | Drawing CPC-220/5/33

L1-VDC-XC1 Power Racks - VEAX Field Supplies

<< CERX Racks

L1-VDC-XC1 X-End Station DC Power Rack Layout ([D1200897](#)) ([S1202311](#))

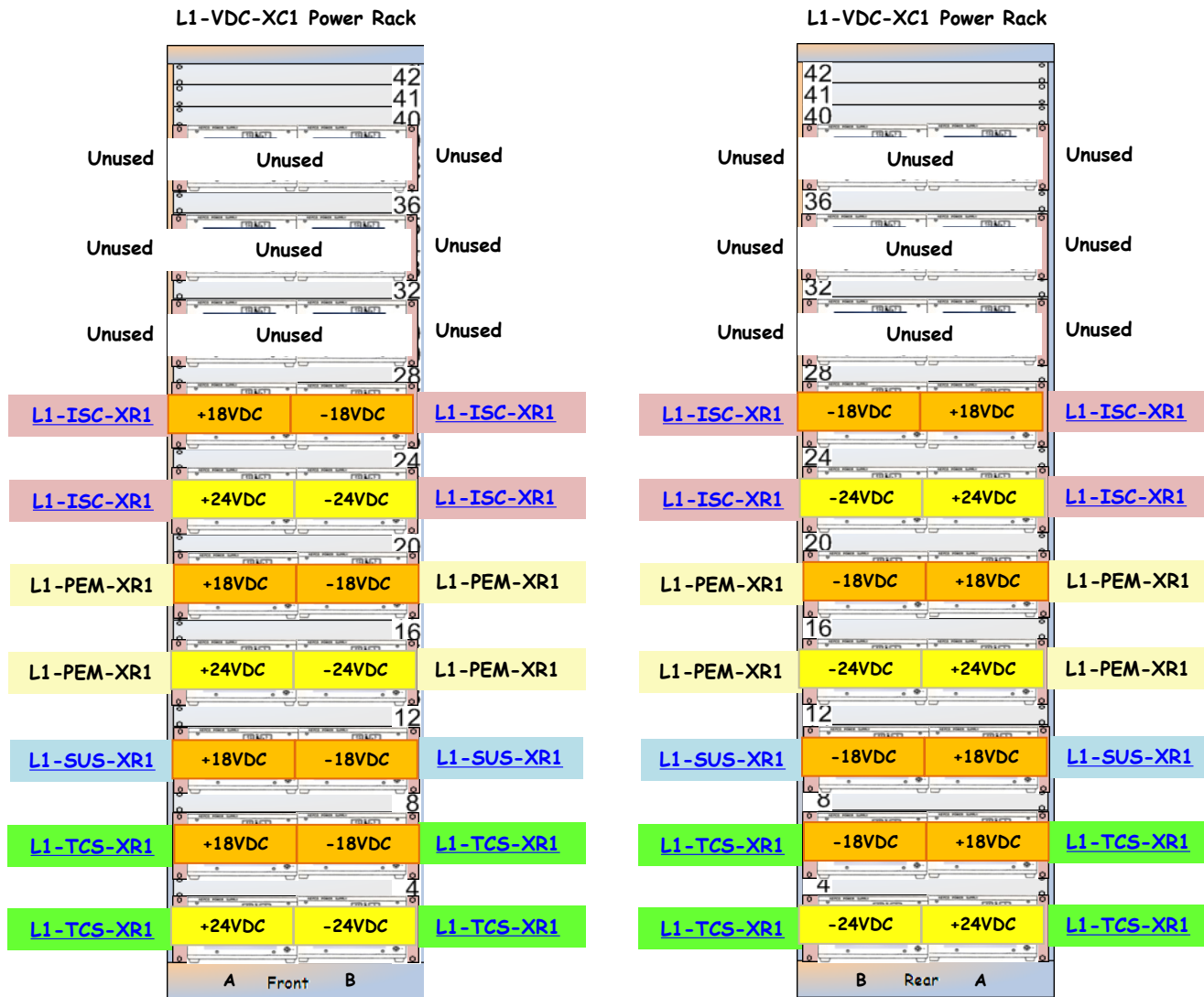

[Cable Runs >>](#)

L1-VDC-XC2 Power Racks - VEAX Supplies

<< CERX Racks

L1-VDC-XC2 X-End Station DC Power Rack Layout ([D1200898](#)) ([S1202312](#))

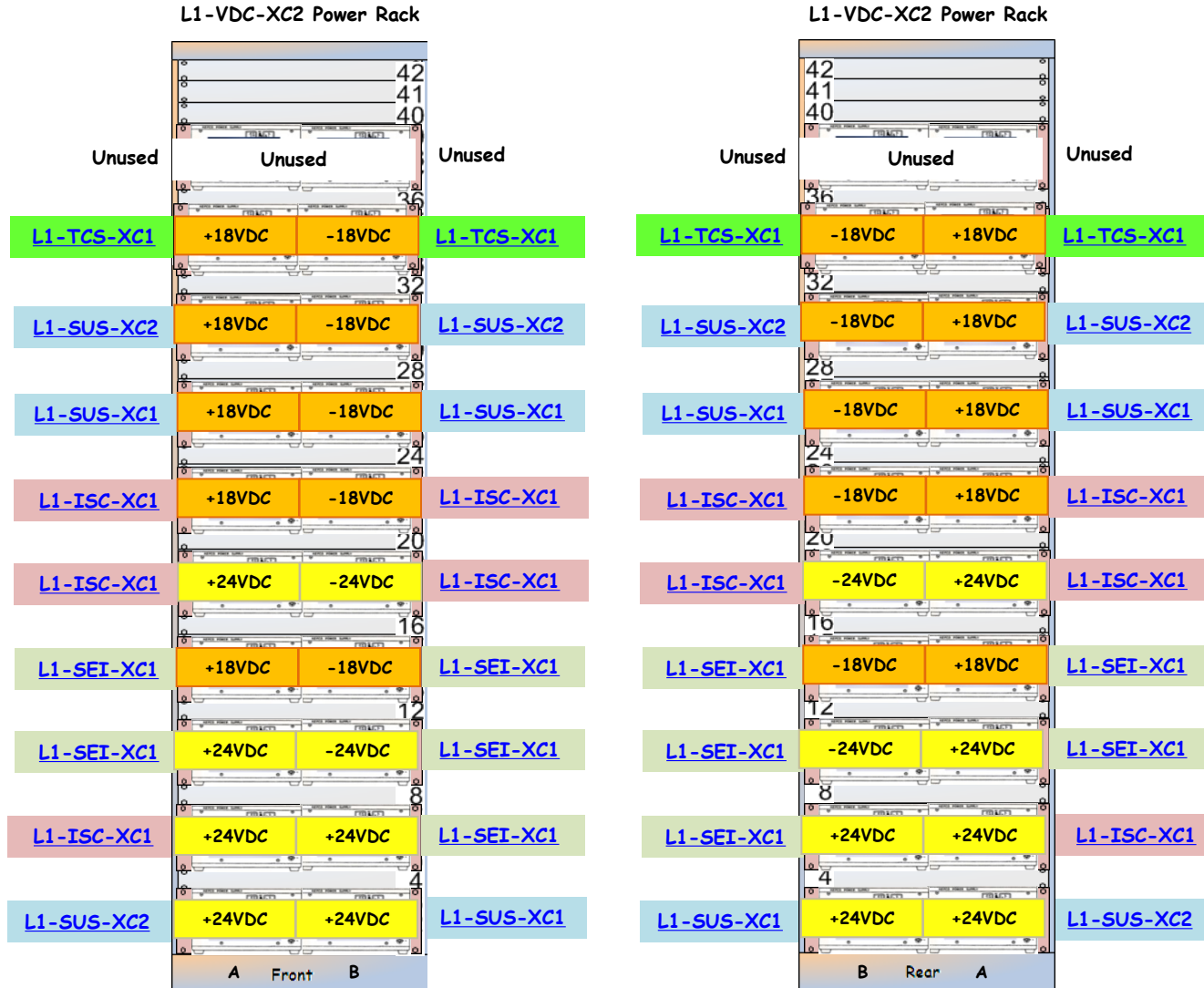

[Cable Runs >>](#)

L1-VDC-XC1 Cable Runs

<< [L1-VDC-XC1](#)

L1-VDC-XC1 X-End Station DC Cable Runs ([D1200897](#)) ([S1202311](#))

L1-VDC-XC1 S1202311	Power Panel	Circuit	DC Power Rack	Outlet	Plug Position	Rack U	Power Supply Model	Power Supply Serial	Polarity	DC Extension Cable	Electronics Rack	DC Power Strip
1	CDS-X		L1-VDC-XC1	8	Top	U37-A (Left)						
2	CDS-X		L1-VDC-XC1	8	Bottom	U37-B (Right)						
3	CDS-X		L1-VDC-XC1	2	Top	U33-A (Left)						
4	CDS-X		L1-VDC-XC1	2	Bottom	U33-B (Right)						
5	CDS-X		L1-VDC-XC1	9	Top	U29-A (Left)	BHK 500V 80mA	A107266	Plus	PBX-003		
6	CDS-X		L1-VDC-XC1	9	Bottom	U29-B (Right)	BHK 500V 80mA	A107260	Minus	PBX-003		
7	CDS-X		L1-VDC-XC1	3	Top	U25-A (Left)	JQE 25V 20A		Plus	PTO-038	L1-ISC-XR1	PSO-038
8	CDS-X		L1-VDC-XC1	3	Bottom	U25-B (Right)	JQE 25V 20A		Minus	PTO-038	L1-ISC-XR1	PSO-038
9	CDS-X		L1-VDC-XC1	10	Top	U21-A (Left)	JQE 25V 20A		Plus	PTY-028	L1-ISC-XR1	PSY-028
10	CDS-X		L1-VDC-XC1	10	Bottom	U21-B (Right)	JQE 25V 20A		Minus	PTY-028	L1-ISC-XR1	PSY-028
11	CDS-X		L1-VDC-XC1	4	Top	U17-A (Left)	JQE 25V 20A		Plus	PTO-039	L1-OAF-XR1	PSO-039
12	CDS-X		L1-VDC-XC1	4	Bottom	U17-B (Right)	JQE 25V 20A		Minus	PTO-039	L1-OAF-XR1	PSO-039
13	CDS-X		L1-VDC-XC1	11	Top	U13-A (Left)	JQE 25V 20A		Plus	PTY-029	L1-OAF-XR1	PSY-029
14	CDS-X		L1-VDC-XC1	11	Bottom	U13-B (Right)	JQE 25V 20A		Minus	PTY-029	L1-OAF-XR1	PSY-029
15	CDS-X		L1-VDC-XC1	5	Top	U09-A (Left)	JQE 25V 20A		Plus	PTO-040	L1-SUS-XR1	PSO-040
16	CDS-X		L1-VDC-XC1	5	Bottom	U09-B (Right)	JQE 25V 20A		Minus	PTO-040	L1-SUS-XR1	PSO-040
17	CDS-X		L1-VDC-XC1	12	Top	U05-A (Left)	JQE 25V 20A		Plus	PTO-041	L1-TCS-XR1	PSO-041
18	CDS-X		L1-VDC-XC1	12	Bottom	U05-B (Right)	JQE 25V 20A		Minus	PTO-041	L1-TCS-XR1	PSO-041
19	CDS-X		L1-VDC-XC1	6	Top	U01-A (Left)	JQE 25V 20A		Plus	PTY-030	L1-TCS-XR1	PSY-030
20	CDS-X		L1-VDC-XC1	6	Bottom	U01-B (Right)	JQE 25V 20A		Minus	PTY-030	L1-TCS-XR1	PSY-030
D1200897												

L1-VDC-XC2 Cable Runs

<< [L1-VDC-XC2](#)

L1-VDC-XC2 X-End Station DC Cable Runs ([D1200898](#)) ([S1202312](#))

L1-VDC-XC2 S1202312	Power Panel	Circuit	DC Power Rack	Outlet	Plug Position	Rack U	Power Supply Model	Power Supply Serial	Polarity	DC Extension Cable	Electronics Rack	DC Power Strip
1	CDS-X		L1-VDC-XC2	8	Top	U37-A (Left)						
2	CDS-X		L1-VDC-XC2	8	Bottom	U37-B (Right)						
3	CDS-X		L1-VDC-XC2	2	Top	U33-A (Left)	JQE 25V 20A		Plus	PTO-044	L1-TCS-XC1	
4	CDS-X		L1-VDC-XC2	2	Bottom	U33-B (Right)	JQE 25V 20A		Minus	PTO-044	L1-TCS-XC1	
5	CDS-X		L1-VDC-XC2	9	Top	U29-A (Left)	JQE 25V 20A	H236497	Plus	PTO-042	L1-SUS-XC2	PSO-042
6	CDS-X		L1-VDC-XC2	9	Bottom	U29-B (Right)	JQE 25V 20A	H236515	Minus	PTO-042	L1-SUS-XC2	PSO-042
7	CDS-X		L1-VDC-XC2	3	Top	U25-A (Left)	JQE 25V 20A	H236501	Plus	PTO-043	L1-SUS-XC1	PSO-043
8	CDS-X		L1-VDC-XC2	3	Bottom	U25-B (Right)	JQE 25V 20A	H236473	Minus	PTO-043	L1-SUS-XC1	PSO-043
9	CDS-X		L1-VDC-XC2	10	Top	U21-A (Left)	JQE 25V 20A	H236510	Plus	PTO-044	L1-ISC-XC1	PSO-044
10	CDS-X		L1-VDC-XC2	10	Bottom	U21-B (Right)	JQE 25V 20A	H236511	Minus	PTO-044	L1-ISC-XC1	PSO-044
11	CDS-X		L1-VDC-XC2	4	Top	U17-A (Left)	JQE 25V 20A	H236493	Plus	PTY-031	L1-ISC-XC1	PSY-031
12	CDS-X		L1-VDC-XC2	4	Bottom	U17-B (Right)	JQE 25V 20A	H236517	Minus	PTY-031	L1-ISC-XC1	PSY-031
13	CDS-X		L1-VDC-XC2	11	Top	U13-A (Left)	JQE 25V 20A	H236505	Plus	PTO-045	L1-SEI-XC1	PSO-045
14	CDS-X		L1-VDC-XC2	11	Bottom	U13-B (Right)	JQE 25V 20A	H236494	Minus	PTO-045	L1-SEI-XC1	PSO-045
15	CDS-X		L1-VDC-XC2	5	Top	U09-A (Left)	JQE 25V 20A	H236509	Plus	PTY-032	L1-SEI-XC1	PSY-032
16	CDS-X		L1-VDC-XC2	5	Bottom	U09-B (Right)	JQE 25V 20A	H236492	Minus	PTY-032	L1-SEI-XC1	PSY-032
17	CDS-X		L1-VDC-XC2	12	Top	U05-A (Left)	JQE 25V 20A	H236482	Plus	PTY-033	L1-ISC-XC1	PSY-033
18	CDS-X		L1-VDC-XC2	12	Bottom	U05-B (Right)	JQE 25V 20A	H236481	Plus	PTY-034	L1-SEI-XC1	PSY-034
19	CDS-X		L1-VDC-XC2	6	Top	U01-A (Left)	JQE 25V 20A	H236498	Plus	PTY-035	L1-SUS-XC2	PSY-035
20	CDS-X		L1-VDC-XC2	6	Bottom	U01-B (Right)	JQE 25V 20A	H236514	Plus	PTY-036	L1-SUS-XC1	PSY-036
D1200898												

Serial to Internet Converter

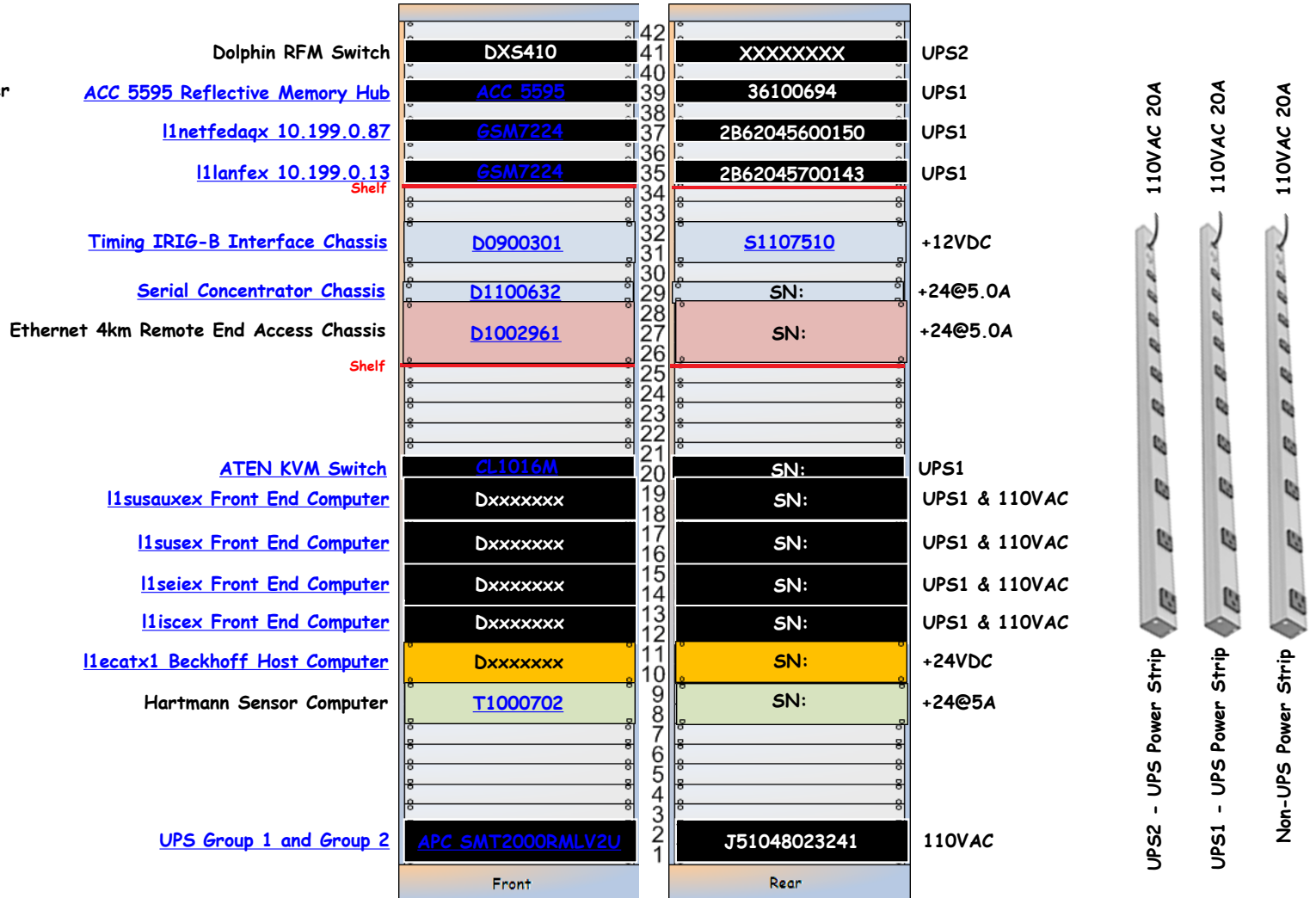

110VAC 20A

110VAC 20A

110VAC 20A

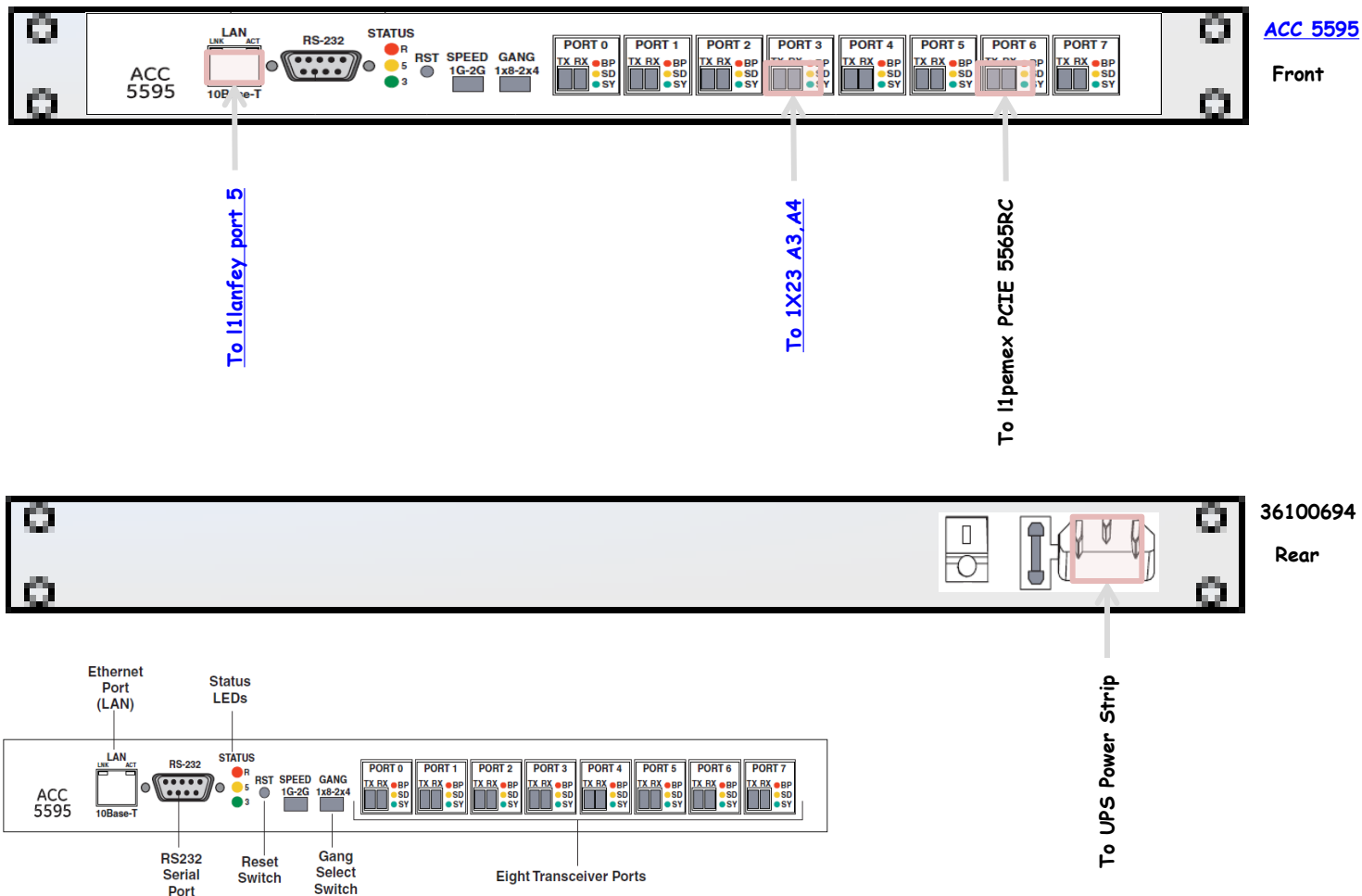

ACC 5595

Front

36100694

Rear

l1netfedaqy - GSM7224

LIGO

<< L1-DAQ-XC1

l1netfedaqy 10.199.0.87

GSM7224

2B62045600150

110VAC



GSM7224

Front

CO:3F:0E:86:88:E0

3 - To FE NET Port

21F - To 1X23 PP B1, B2



2B62045600150

Rear

To UPS Power Strip

I1lanfex - GSM7224

I1lanfey 10.199.0.13

GSM7224

2B62045700143

110VAC



GSM7224

Front

CO:3F:0E:86:88:AC



3 - To FE LAN Port

5 - To 5595 LAN 10BaseT

21F - To 1X23 PP E3,E4



2B62045700143

Rear

To UPS Power Strip

Timing IRIG-B Interface Chassis

D0900301

S1107510

+12VDC

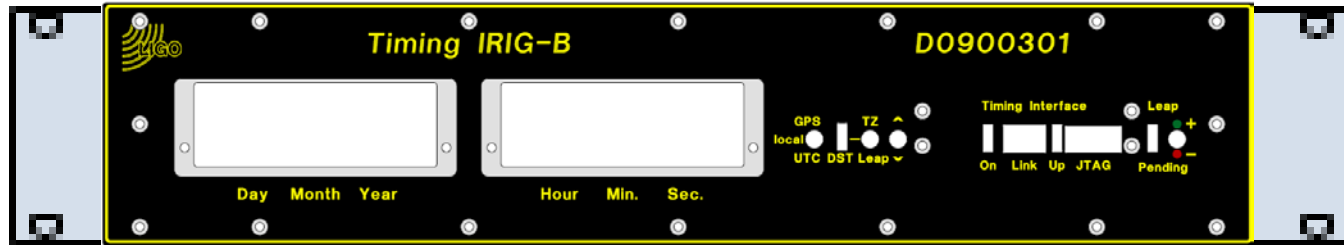

D0900301

Front

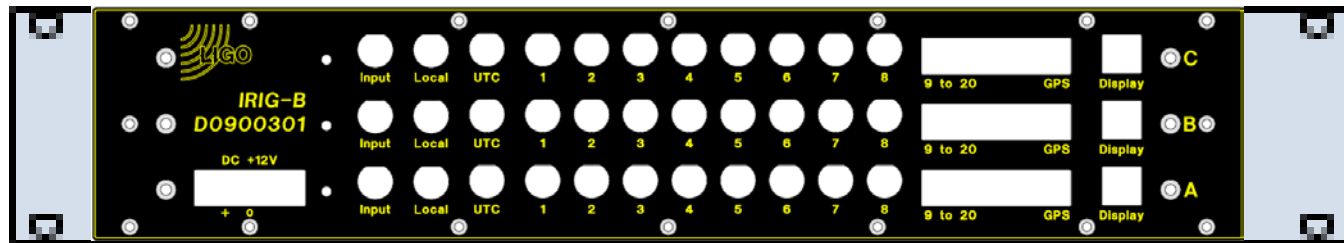

S1107510

Rear

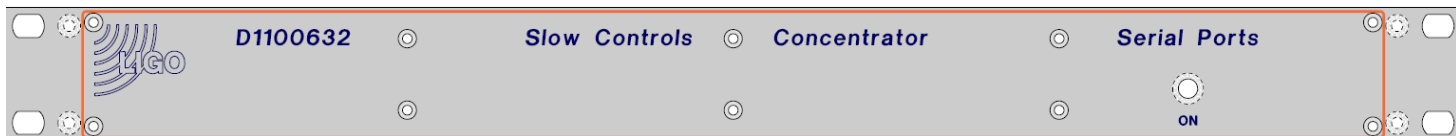

D1100632

Front

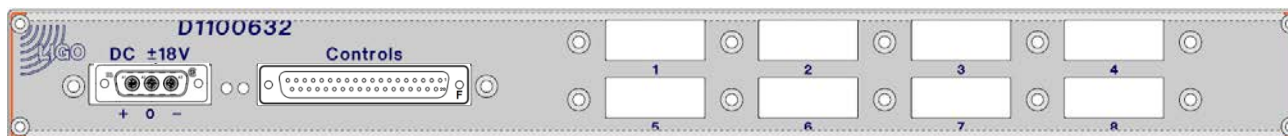

Sxxxxxxx

Rear

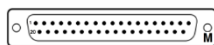



CL1016M

Front



Z8A6Y132ANQ0010

Rear

To UPS Power Strip

To I1 pemex Front End

<< L1-DAQ-XC1

KEPCO Power Supplies

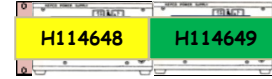

UPS1

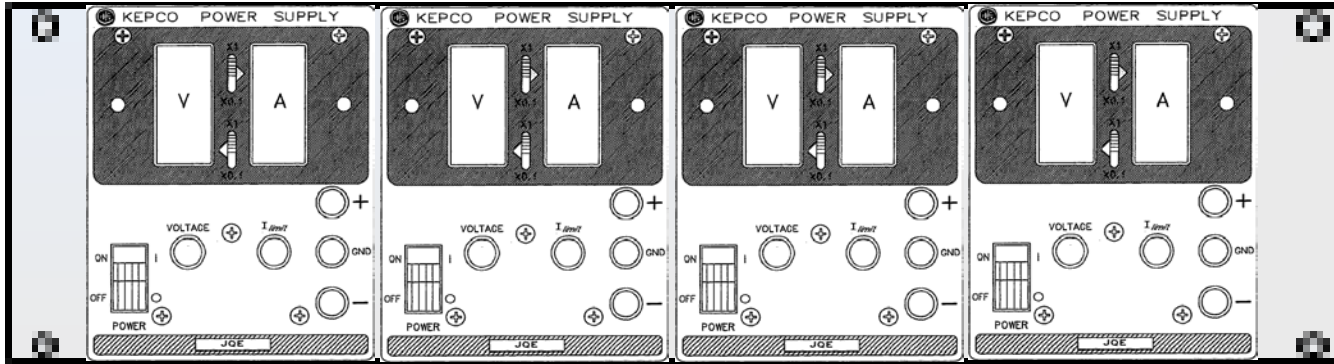

JQE

Front

KEPCO JQE 15-6:
OFF (Not Used)

KEPCO JQE 15-6:
+12VDC

KEPCO JQE 25-4:
-18VDC

KEPCO JQE 25-4:
+18VDC

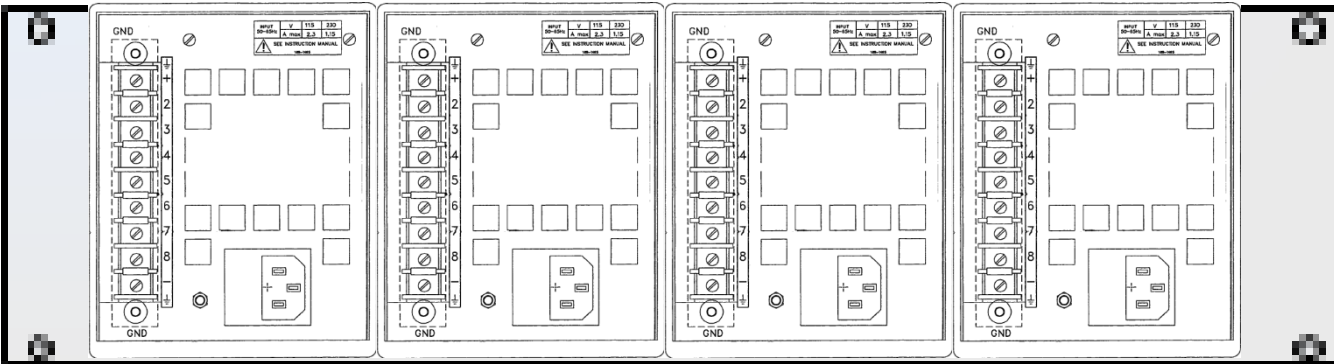

SN:

Rear

KEPCO JQE 25-4

KEPCO JQE 25-4

KEPCO JQE 15-6

KEPCO JQE 15-6

APC SMX2000RMLV2U

UPS

[APC SMX2000RMLV2U](#)

JS1048019433

110VAC



[APC SMX2000RMLV2U](#)

Front

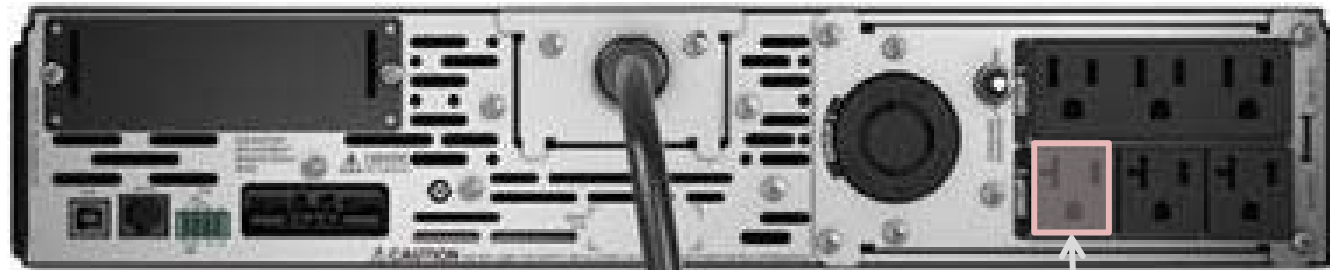

JS1048019433

Rear

[To UPS Power Strip](#)

L1-FAC-XC1

L1-FAC-XC1 Facilities X-End Station Remote Rack Layout ([D1201086](#)) ([S1202950](#))

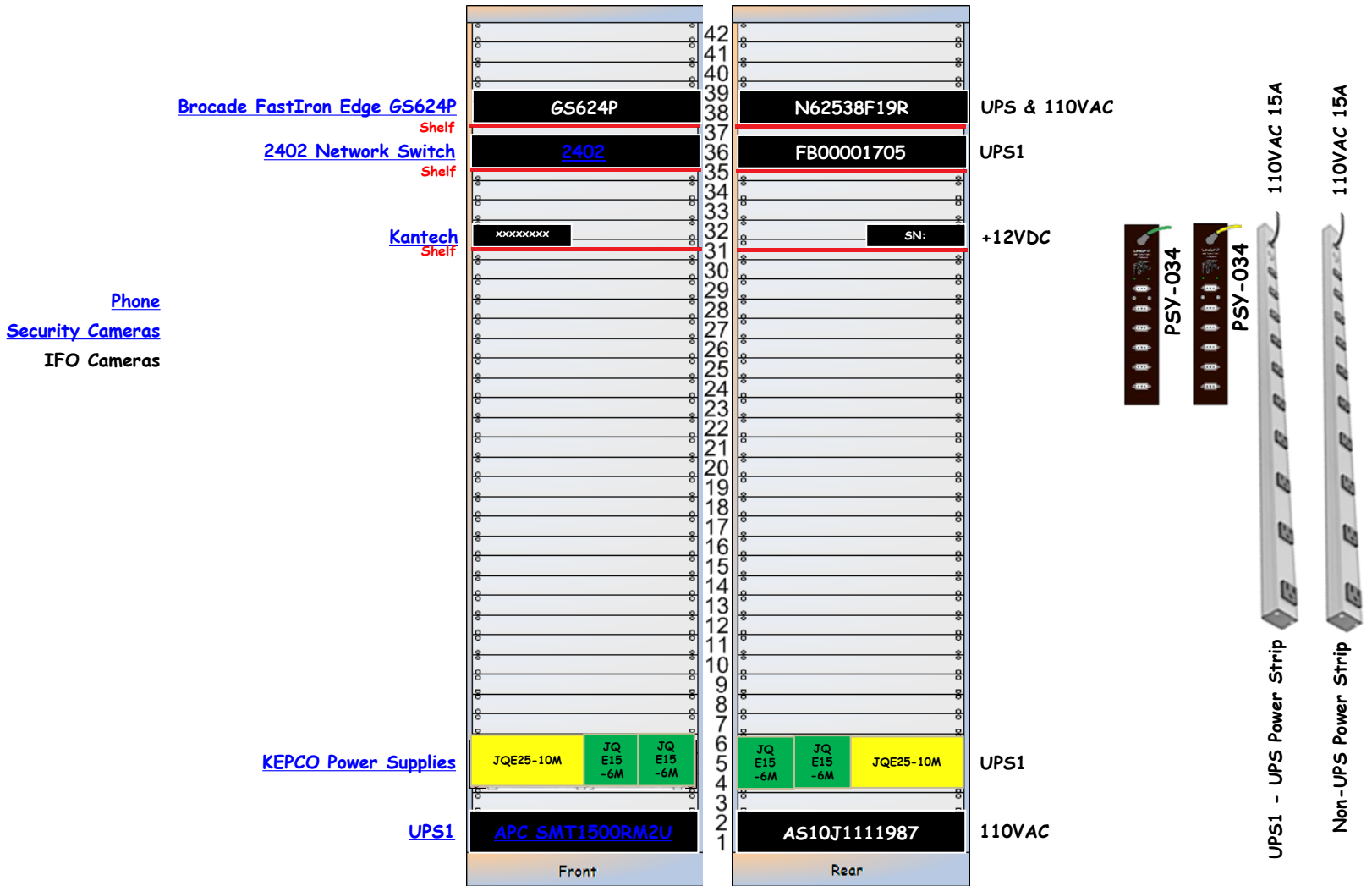

<< L1-FAC-XC1

Brocade FastIron Edge GS624P

GS624P

N62538F19R

UPS & 110VAC



GSM7224

Front

CO:3F:0E:86:88:E0

21F - To 1X23 PP B1.B2

3 - To FE NET Port

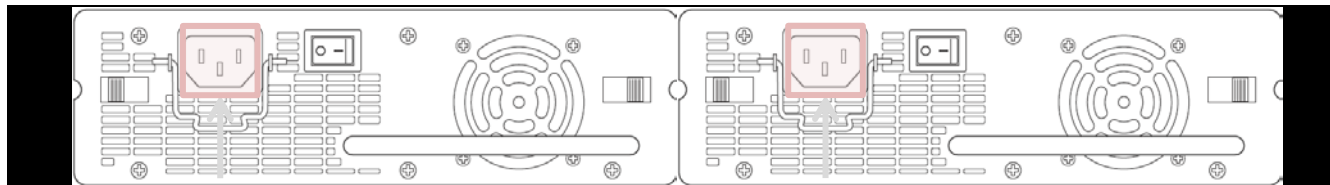

N62538F19R

Rear

To 110 Power Strip

To UPS Power Strip

<< L1-FAC-XC1

2402 Network Switch

2402

FB00001705

110VAC

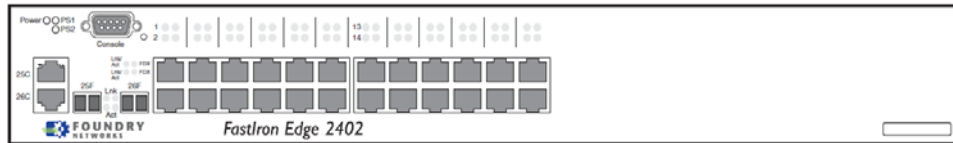

- Empty ↔ 01
- Kantech??? ↔ 02
- Empty ↔ 03
- Empty ↔ 04
- Empty ↔ 05
- Empty ↔ 06
- Empty ↔ 07
- Empty ↔ 08
- Empty ↔ 09
- Empty ↔ 10
- Empty ↔ 11
- Empty ↔ 12
- Empty ↔ 13
- To Siemens ↔ 14
- Empty ↔ 15
- Empty ↔ 16
- Empty ↔ 17
- Empty ↔ 18
- Empty ↔ 19
- Empty ↔ 20
- Empty ↔ 21
- Empty ↔ 22
- Empty ↔ 23
- Empty ↔ 24

- Empty ↔ 25C
- Empty ↔ 26C
- To Special Cable CSR1 ↔ 25F
- To 1X23 PP E1,E2 ↔ 26F

G12038
192.168.253.20

To UPS Power Strip

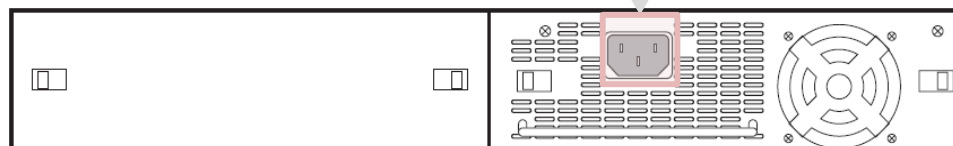

PS1

KEPCO Power Supplies

KEPCO Power Supplies

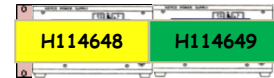

UPS1

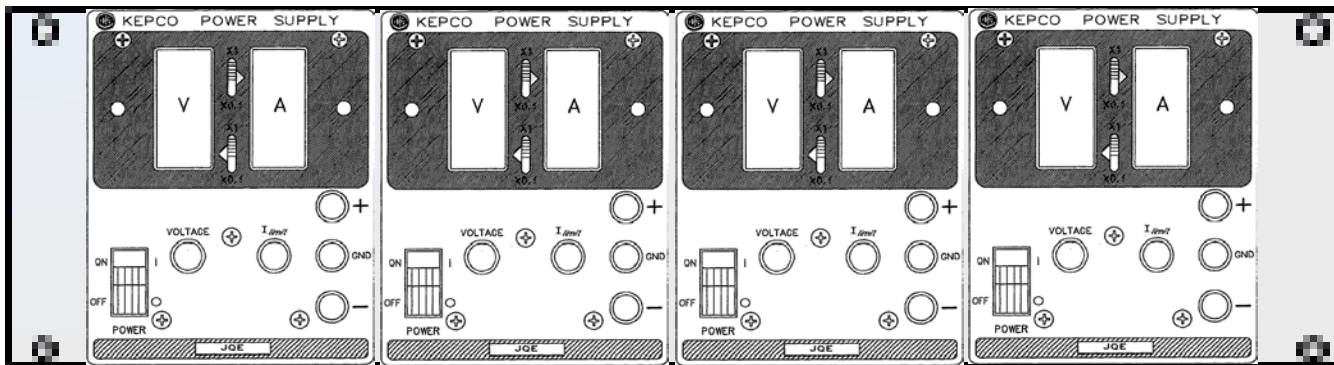

JQE

Front

KEPCO JQE 15-6:
OFF (Not Used)

KEPCO JQE 15-6:
+12VDC

KEPCO JQE 25-4:
-18VDC

KEPCO JQE 25-4:
+18VDC

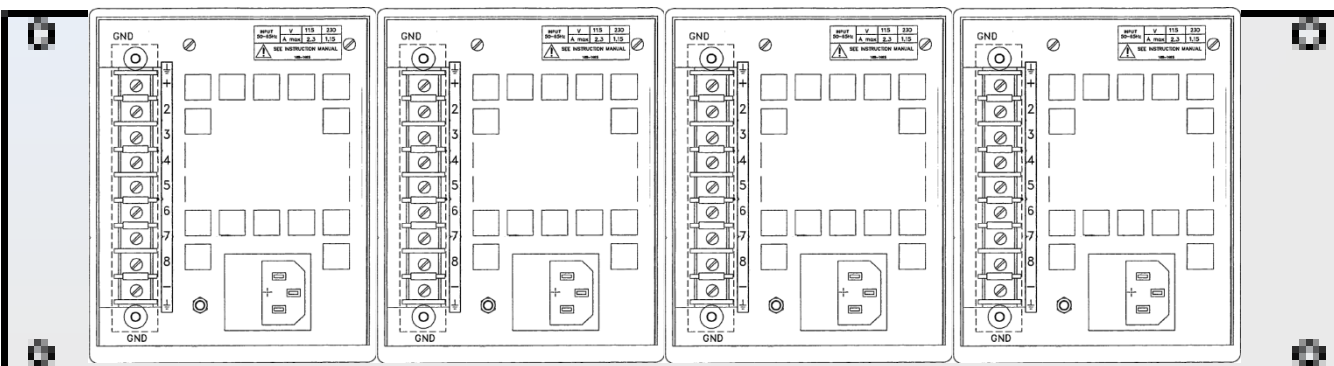

SN:

Rear

KEPCO JQE 25-4

KEPCO JQE 25-4

KEPCO JQE 15-6

KEPCO JQE 15-6

APC SMT1500RM2U

UPS

APC SMT1500RM2U

A51051111991

110VAC

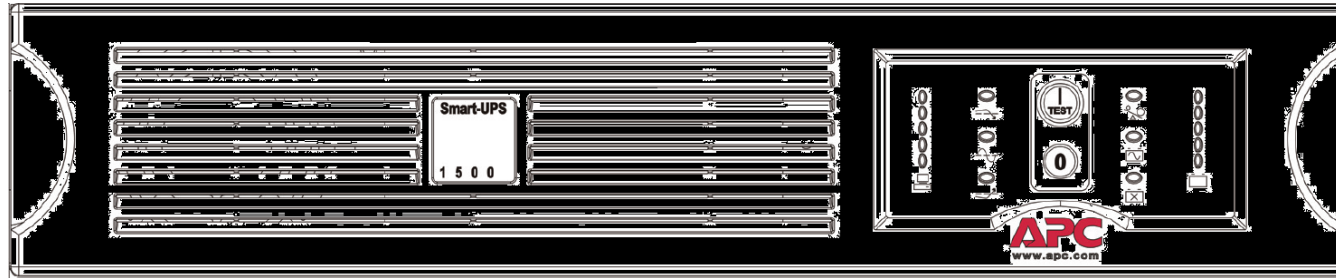

APC SMT1500RM2U

Front

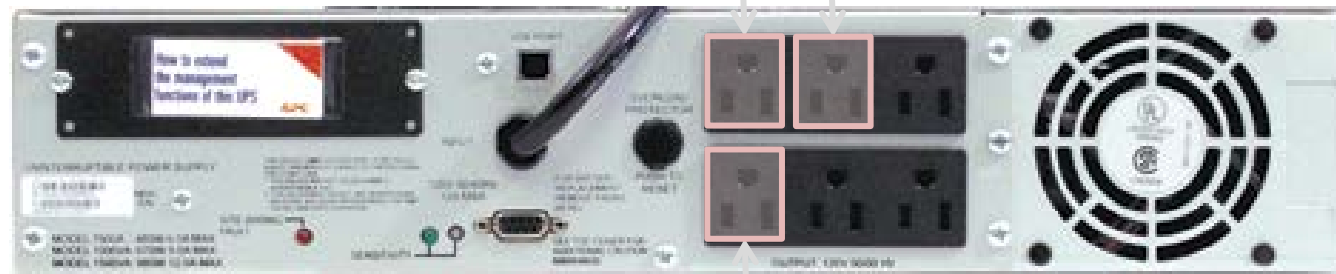

A51051111991

Rear

To 2402 PS1

To UPS Power Strip

To 844X 01

<< L1-FAC-XC1

Magnetometer: [Bartington Instruments](#)
MAG-03MC



5 meter

Black - G/W ... Ground
Stria - Y/W ... +12VDC

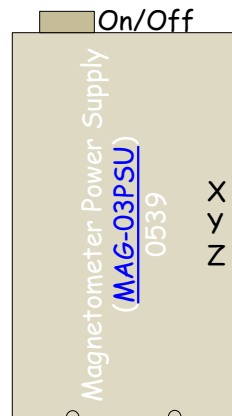

Powered from
12VDC DIN rails

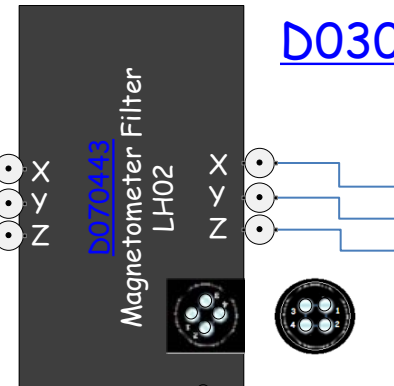
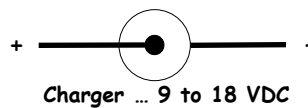

[D030574](#)

Pin 1: +15VDC ... Red/Blk RED
Pin 2: Ground ... Red/Blk BLACK
Pin 3: -15VDC ... Wht/Blk WHITE
Pin 4: Ground ... Wht/Blk BLACK

Powered from
15VDC DIN rails

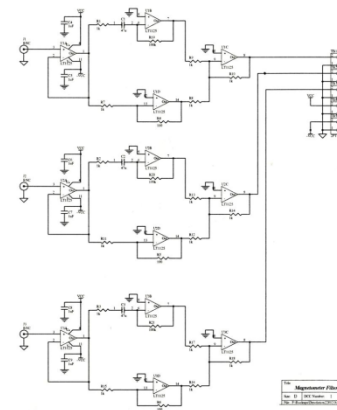

Magnetometer Filter Board

Security Cameras

VT7430-2DRDT
Optical In/Out:
[To 1X23 PP B6](#)
Power: 12VDC
Output: Ch1,
Ch2, Ch3 BNCs
to Cameras

Powered from
Wall Wart from
Isolated Power

Video Master
Power Supply
Model
RT24/16500
Outputs to
Cameras 1,2,3

Note: 6 LEDs
are on.

AC Powered
from Isolated
Power

Kantech

Fiber Options
S7711DR -EST1
Optical In/Out:
[To 1X23 PP A2](#)
13.5VDC from
Wall Wart

Blue CAT5:
1=O/W and
B/W, 4=O, 7=B

Powered from
Wall Wart from
Isolated Power

Phone

TR3030WDM
GE Security
Optical In/Out:
[To 1X23 PP
B3,B4](#)
Phone: Copper to
VEA
Power: 12VDC

Powered from Wall Wart from
Tripp-Lite UPS
Model BC320
xxxxxxxxxxxxx To 6-Outlet
Power Strip in Non-isolated
wall socket



RF Distribution Panel 22

Rack ISC-XC1

Slot	Contents	Vendor	D# / Model	NOTES
42				
41	RF Patch Panel 22	LIGO		
40				
39	RF Patch Panel 23	LIGO		
38				
37	71 MHz Oscillator	LIGO	D080702-A	+12V DC, +/- 24 V DC
36	71 MHz Distrib Amp	LIGO	D100124	+/- 18V DC, +/- 24 V DC
35				
34				
33	24.4 MHz Oscillator	LIGO	D080702-A	+12V DC, +/- 24 V DC
32	24.4 MHz Distrib Amp	LIGO	D100124	+/- 18V DC, +/- 24 V DC
31				
30				
29	Signal Generator	Aeroflex	2023A	AC
28				
27	RF Amp Concentrator 3	LIGO	D1100262	+/- 18V DC (Actually 1.5U)
26				
25				
24				
23				
22				
21	384 Chan Binary Output	LIGO	D1100251	+ 24V DC
20				
19				
18	EtherCat End-Station LSC Common Chassis	LIGO	D1002961	+ 24V DC
17				
16				
15				
14	EtherCat End-Station 2 Chassis	LIGO	D1100682	+ 24V DC
13				
12				
11	Anti-Image Chassis	LIGO	D070081	+/- 18V DC
10	Anti-Aliasing Chassis	LIGO	D0902783	+/- 18V DC
9	Anti-Aliasing Chassis	LIGO	D0902783	+/- 18V DC
8				
7				
6				
5				
4				+ 24V DC
3	ISC/PEM End-station IO Chassis	LIGO		1 16-bit DAC (ISC) 3 32-ch ADCs
2				1 18-bit DAC (PEM)
1				
	LIGO-D1201084-v1			

RF Distribution Panel 23

71 MHz Oscillator

71 MHz Distrib Amplifier

24.4 MHz Oscillator

24.4 MHz Distrib Amplifier

Signal Generator

RF Amp Concentrator 3

384 Channel Binary Output

EtherCat Chassis

EtherCat Chassis

Anti-Image Chassis

Anti-Aliasing Chassis

Anti-Aliasing Chassis

ISC/PEM Chassis

ISC/PEM I/O Extension Chassis

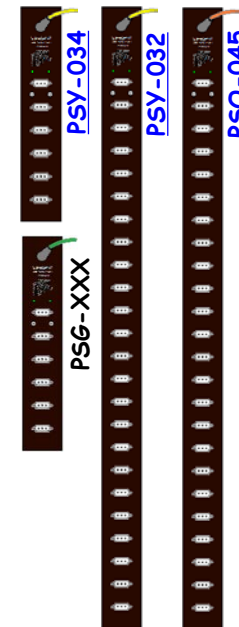
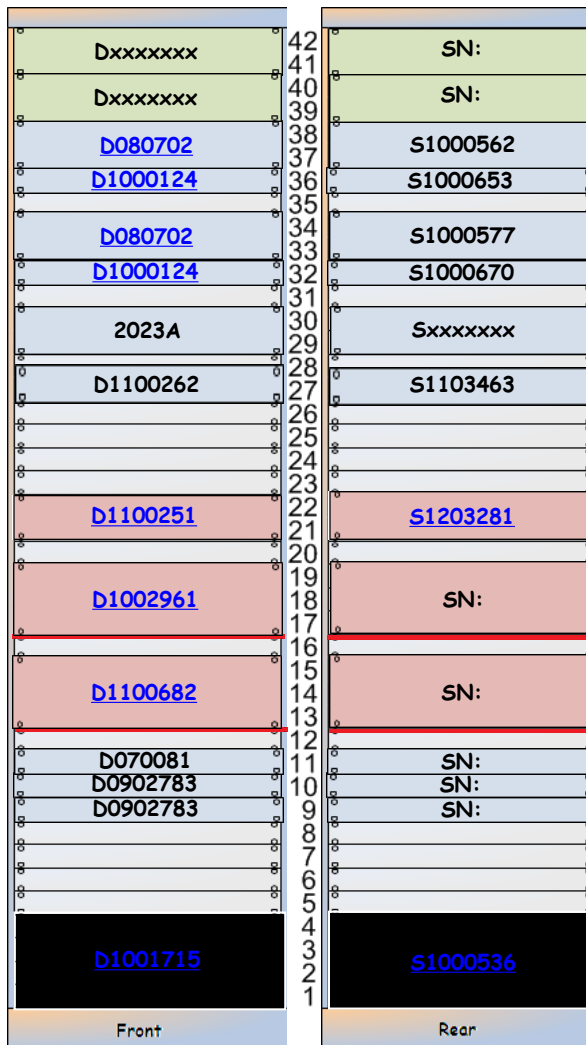

ISC-XC1 is part of [D1001459](#)

L1-ISC-XC1 is [D1201084](#)

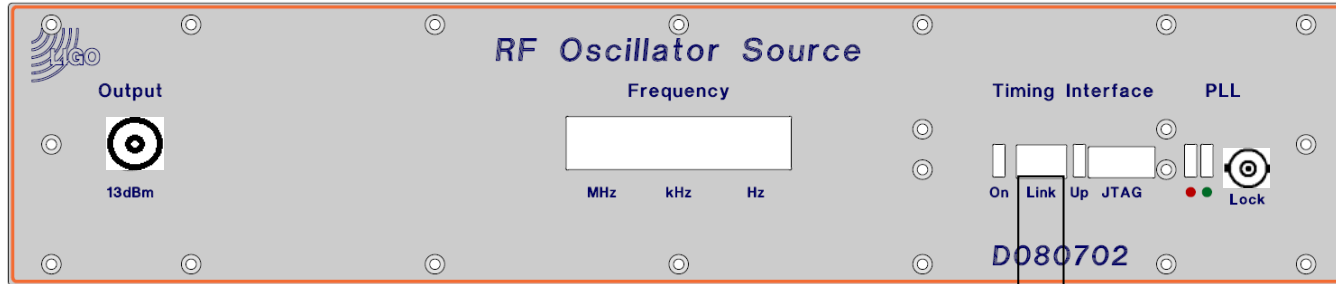

D080702

Front

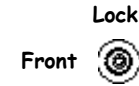

To ...

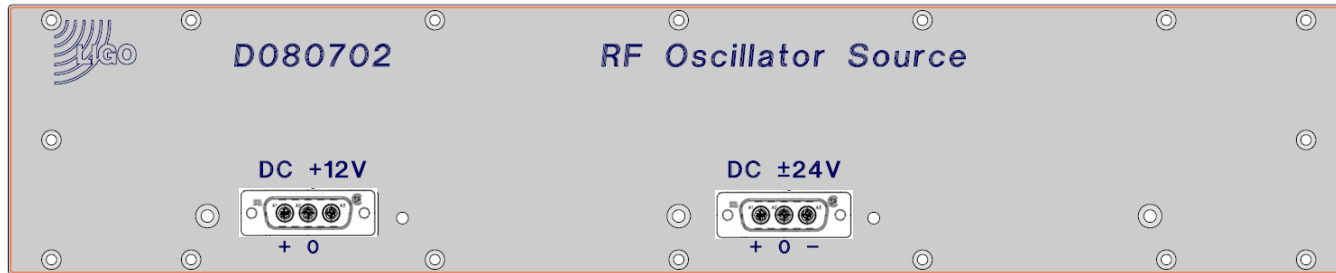

Sxxxxxxx

Rear

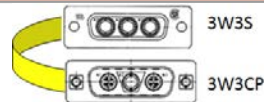

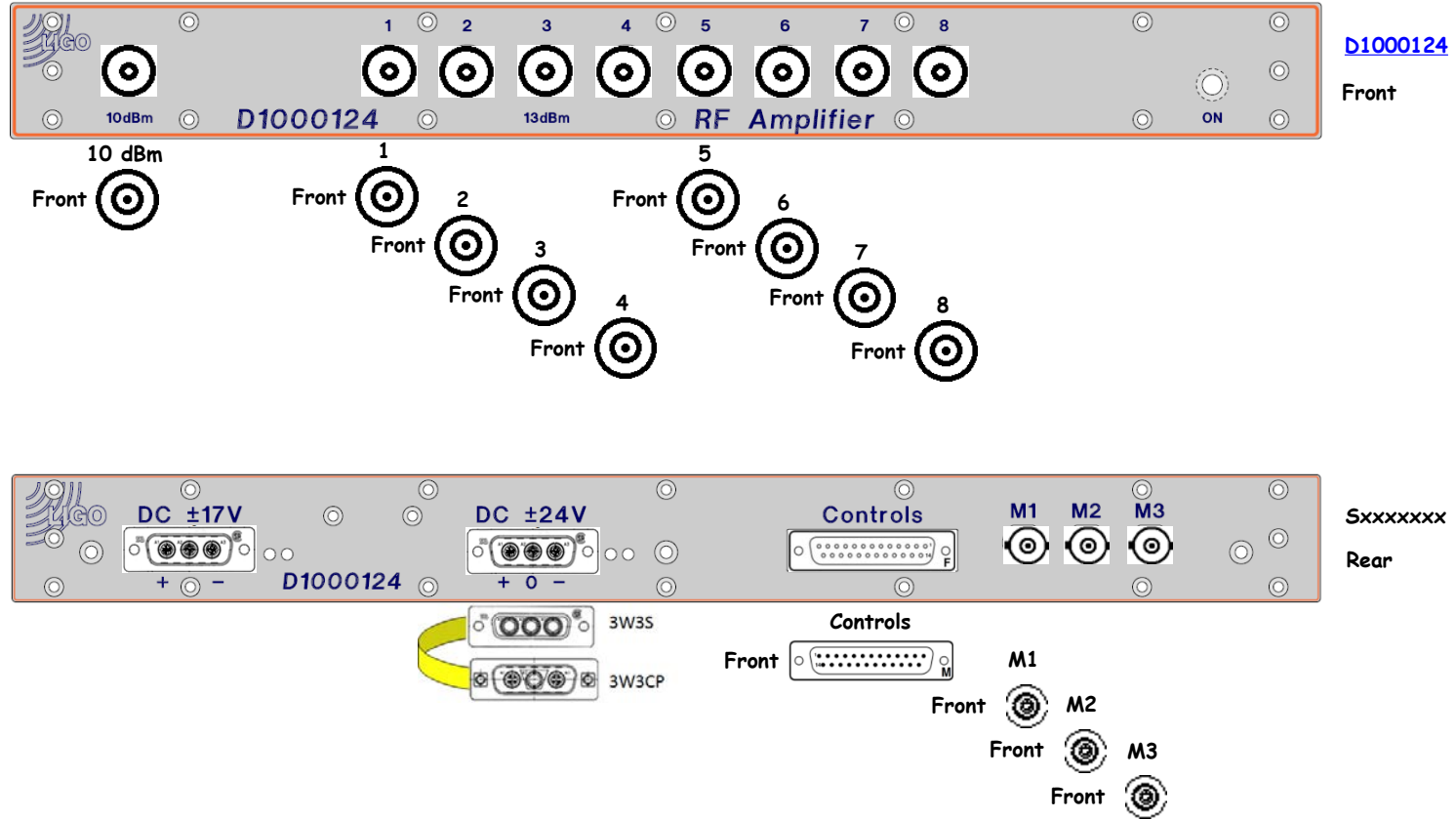

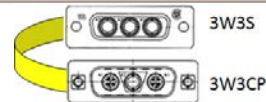
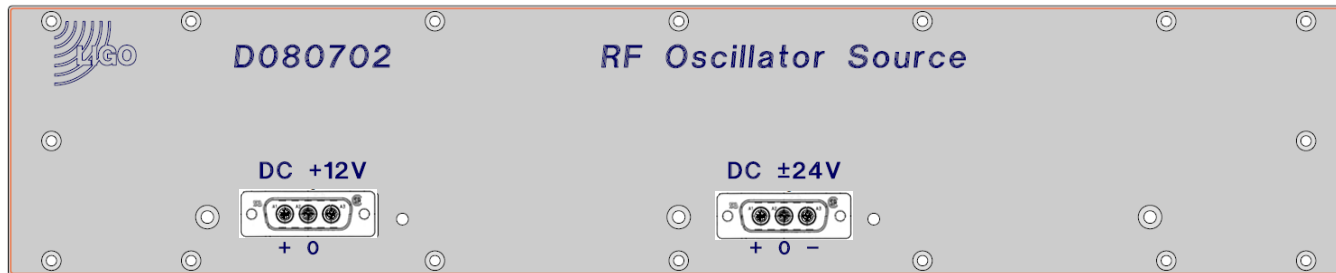
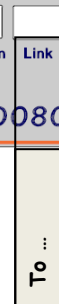
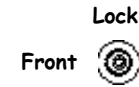
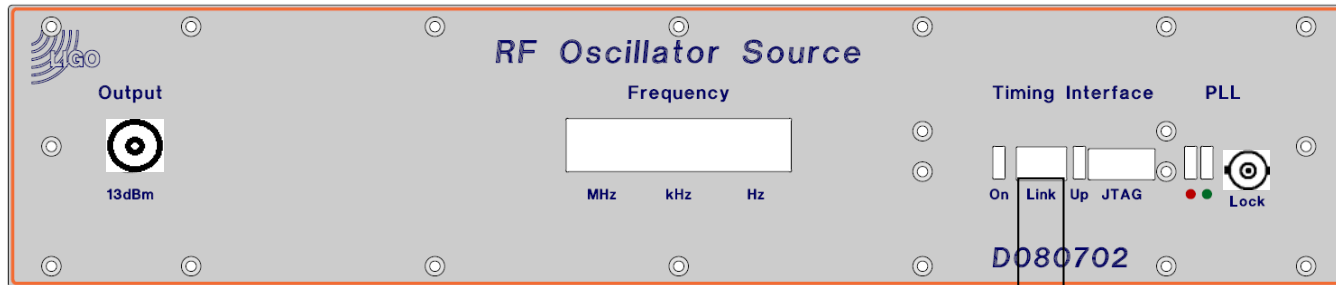

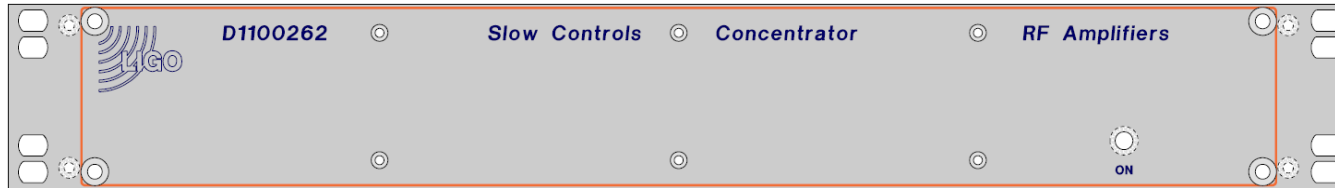

D1100262

Front

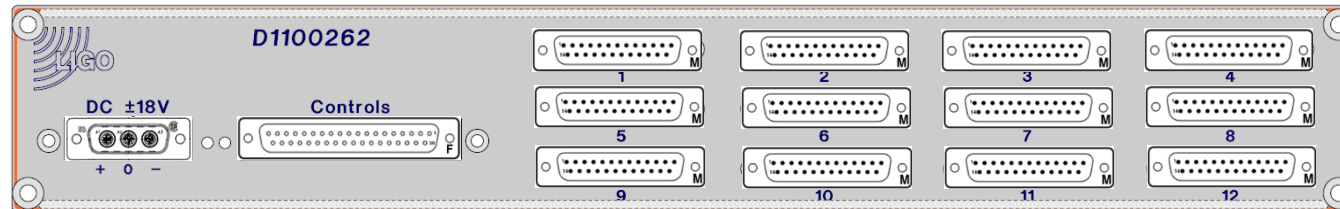

S1001232

Rear

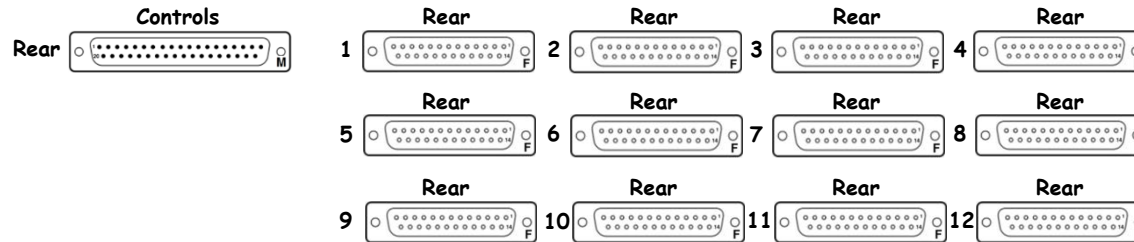

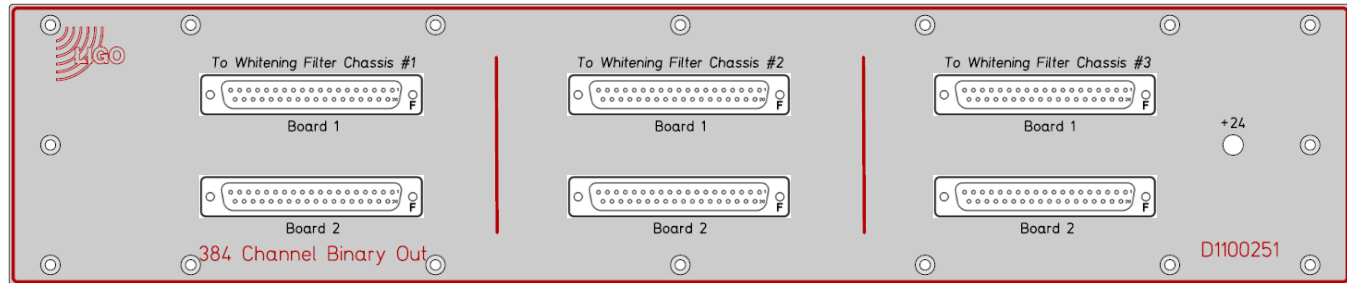

D1100251

Front

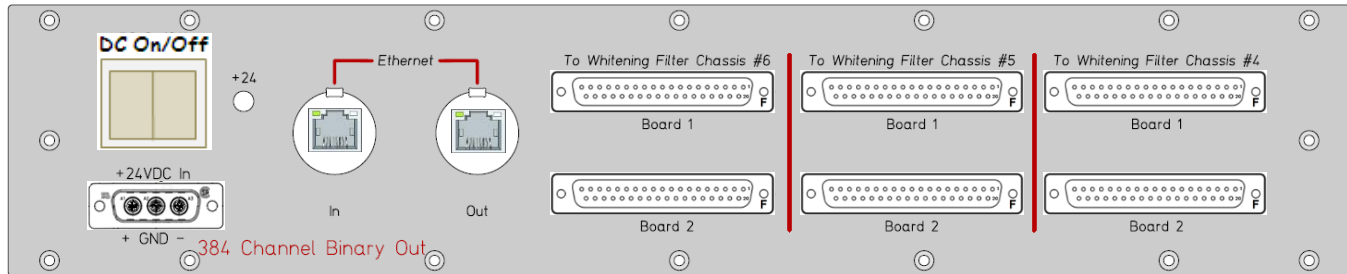
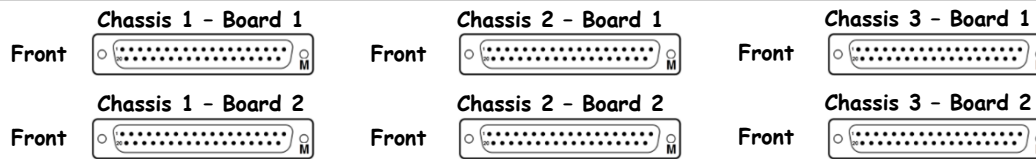

Sxxxxxxx

Rear

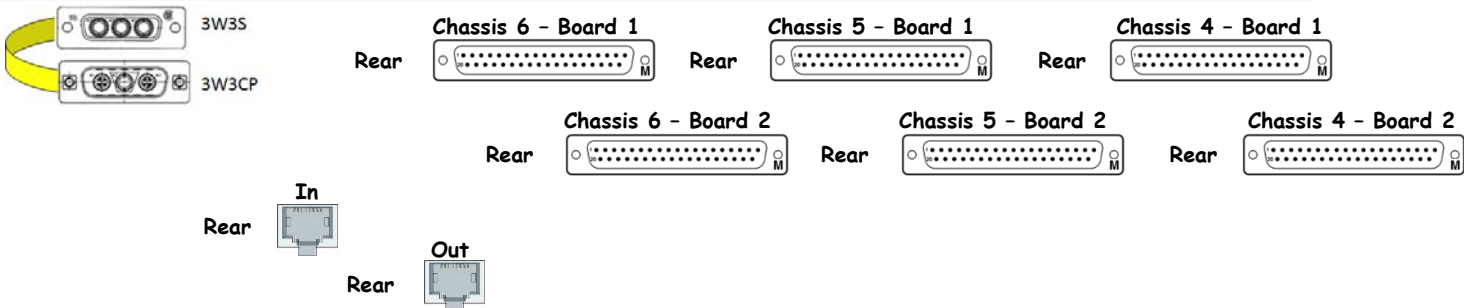

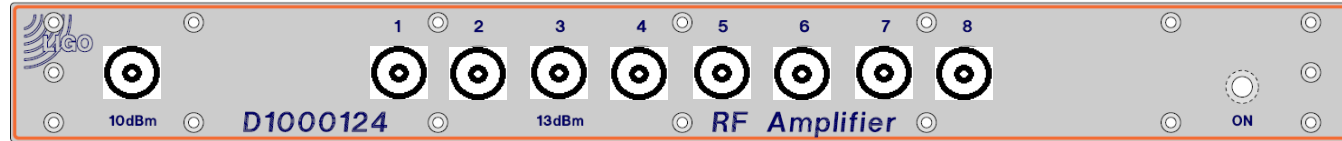

D1000124

Front

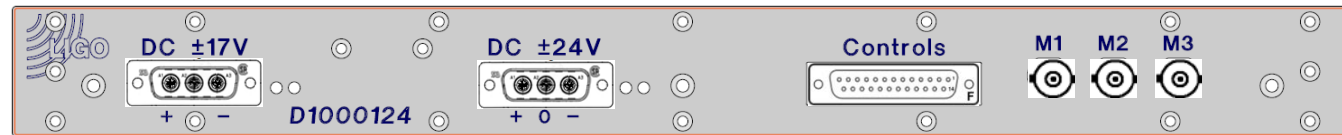
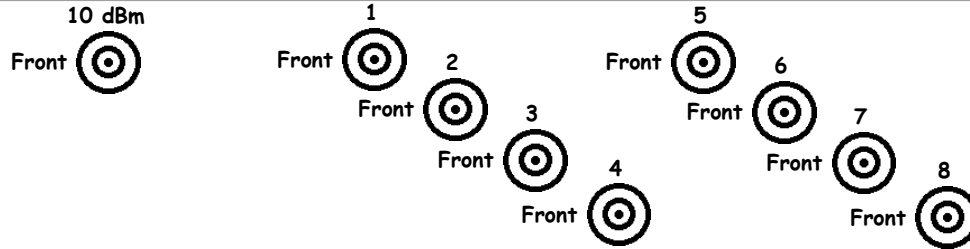

Sxxxxxxx

Rear

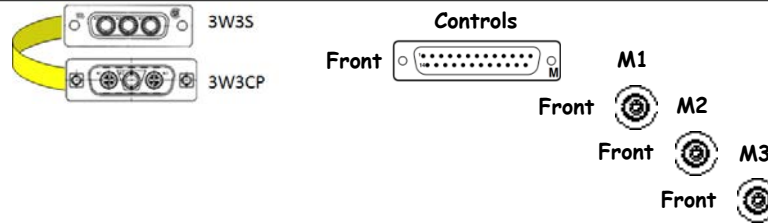



D1001715
Front

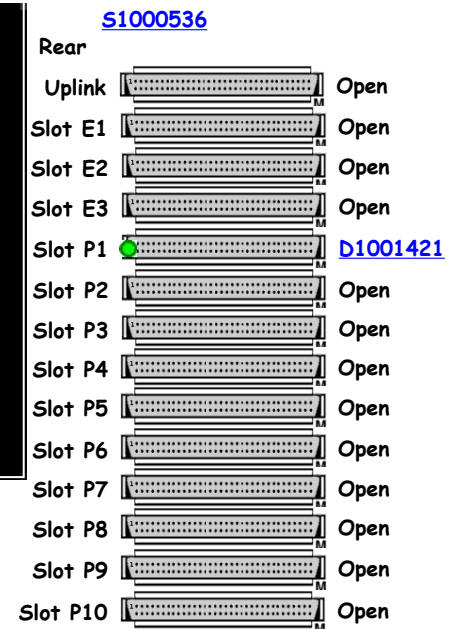
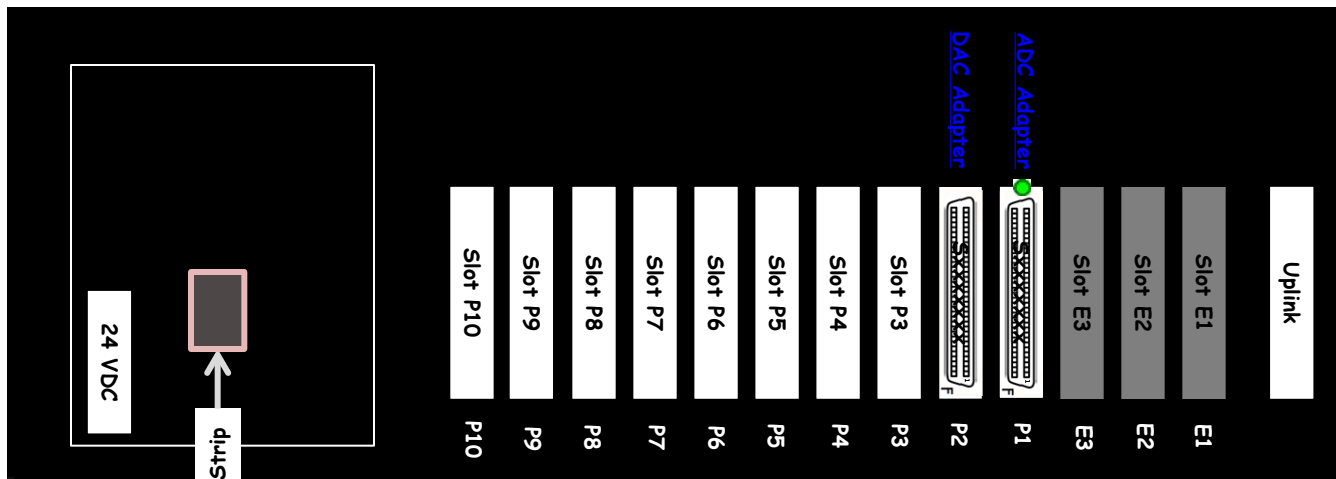

BSC CERX Racks

L1-SEI-XC1 (BSC4) X-End Remote Rack 1 Layout (D1201081) (S1202945)

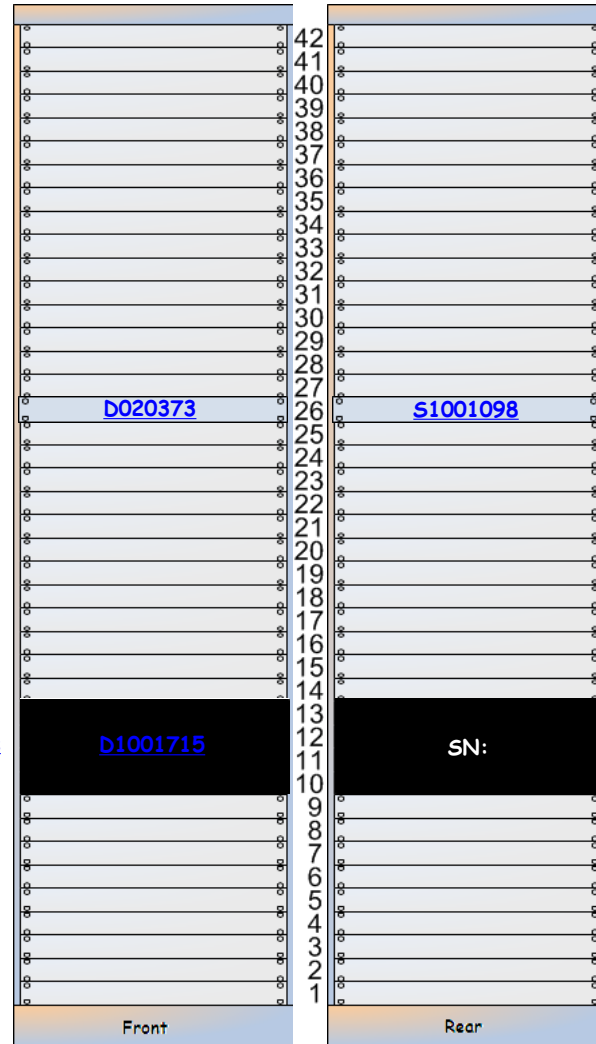
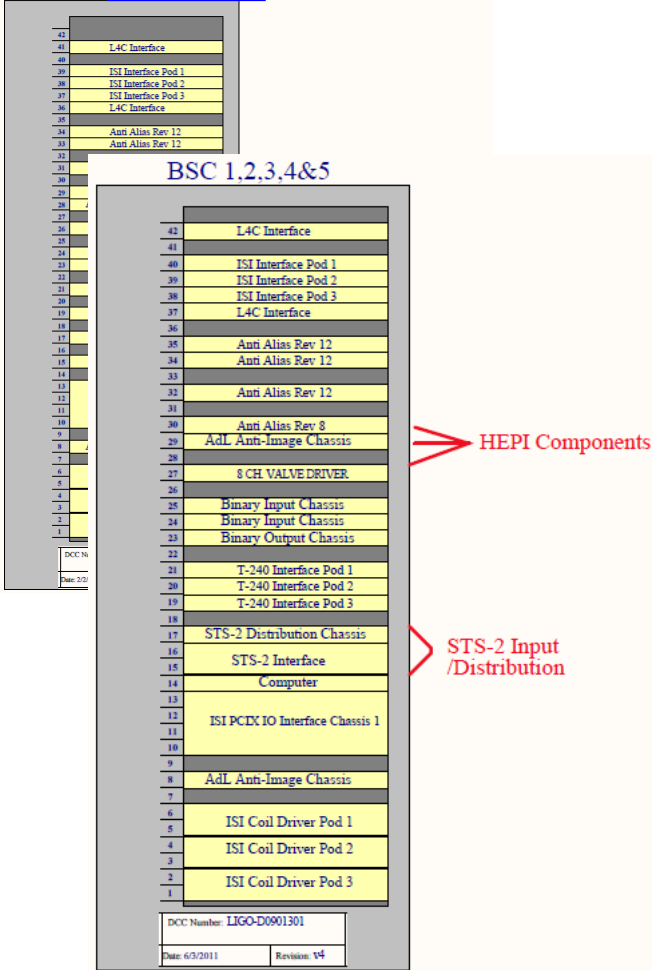

Power

1Y30

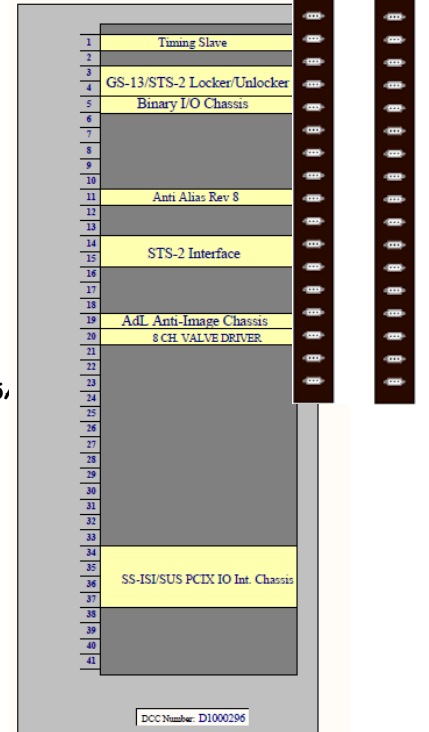

SEI-XC1 is part of [D0901301](#)



[D020373](#)

Front

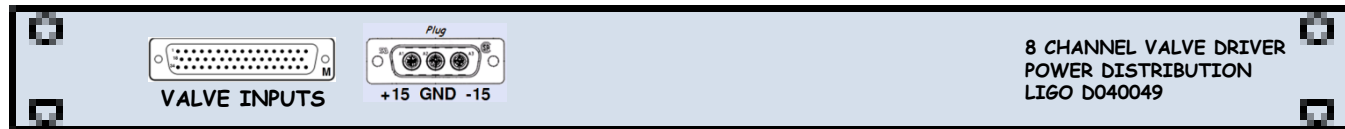
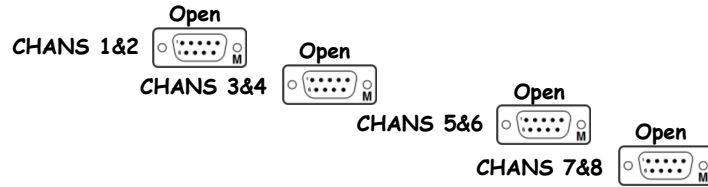

[S1001098](#)
[D040049](#)

Rear





D1001715

Front

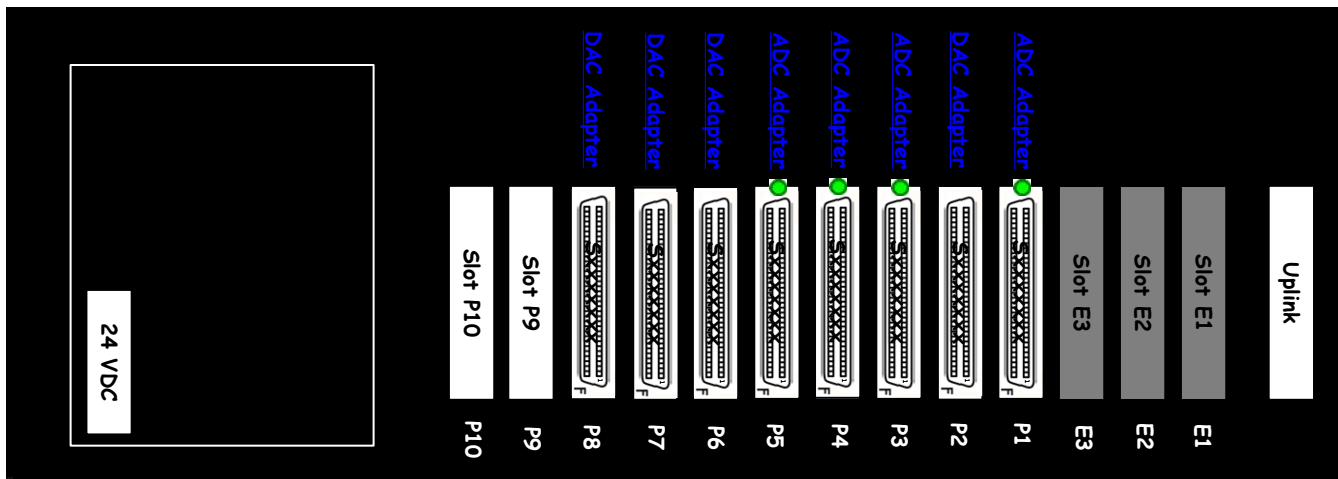

SN

Rear

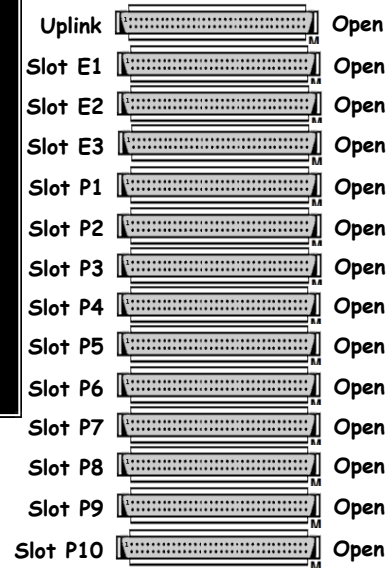

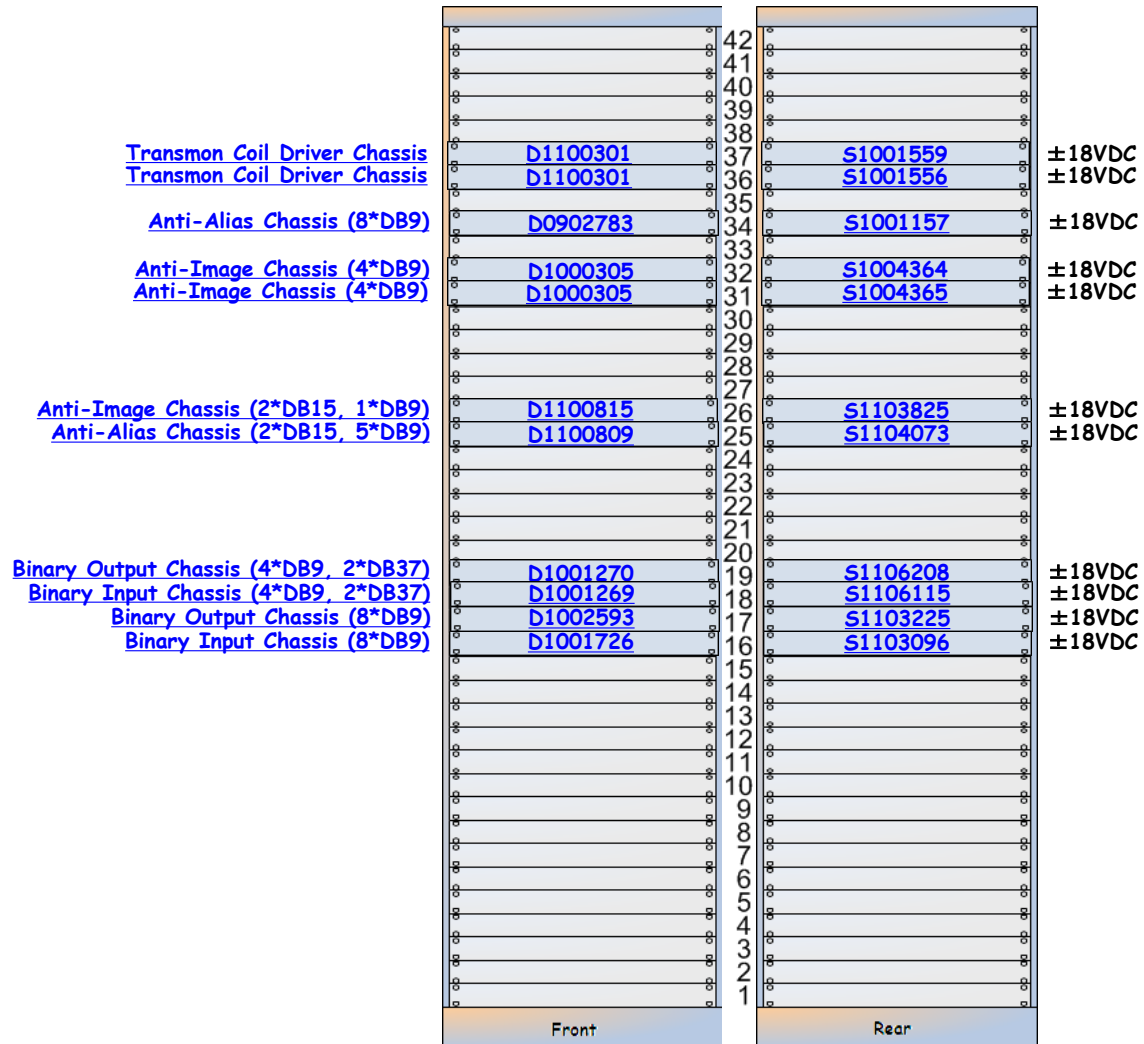

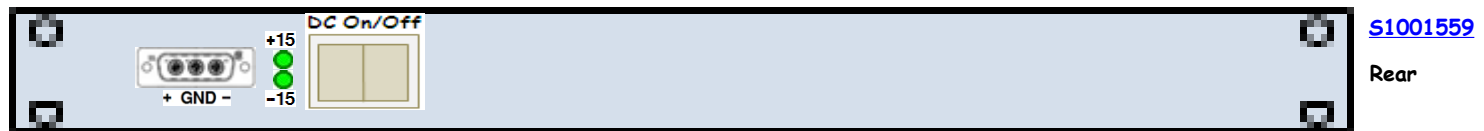
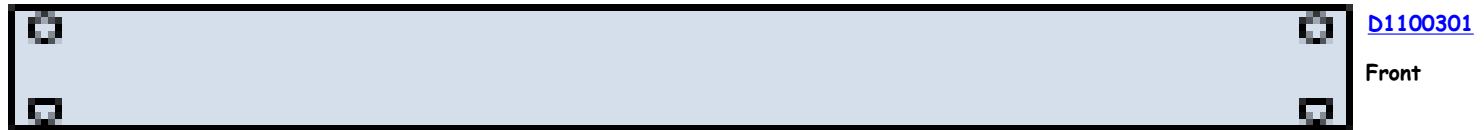

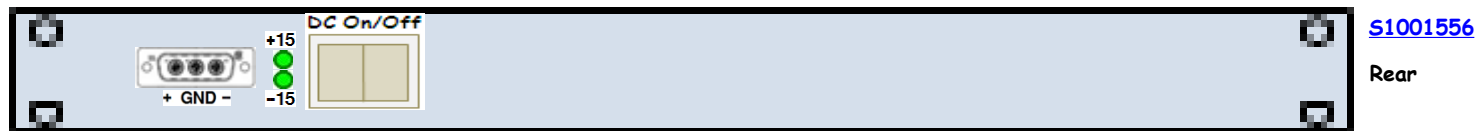
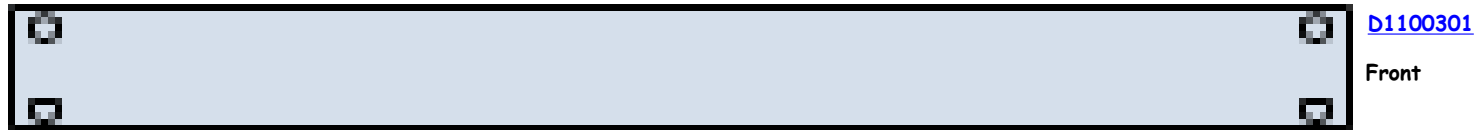

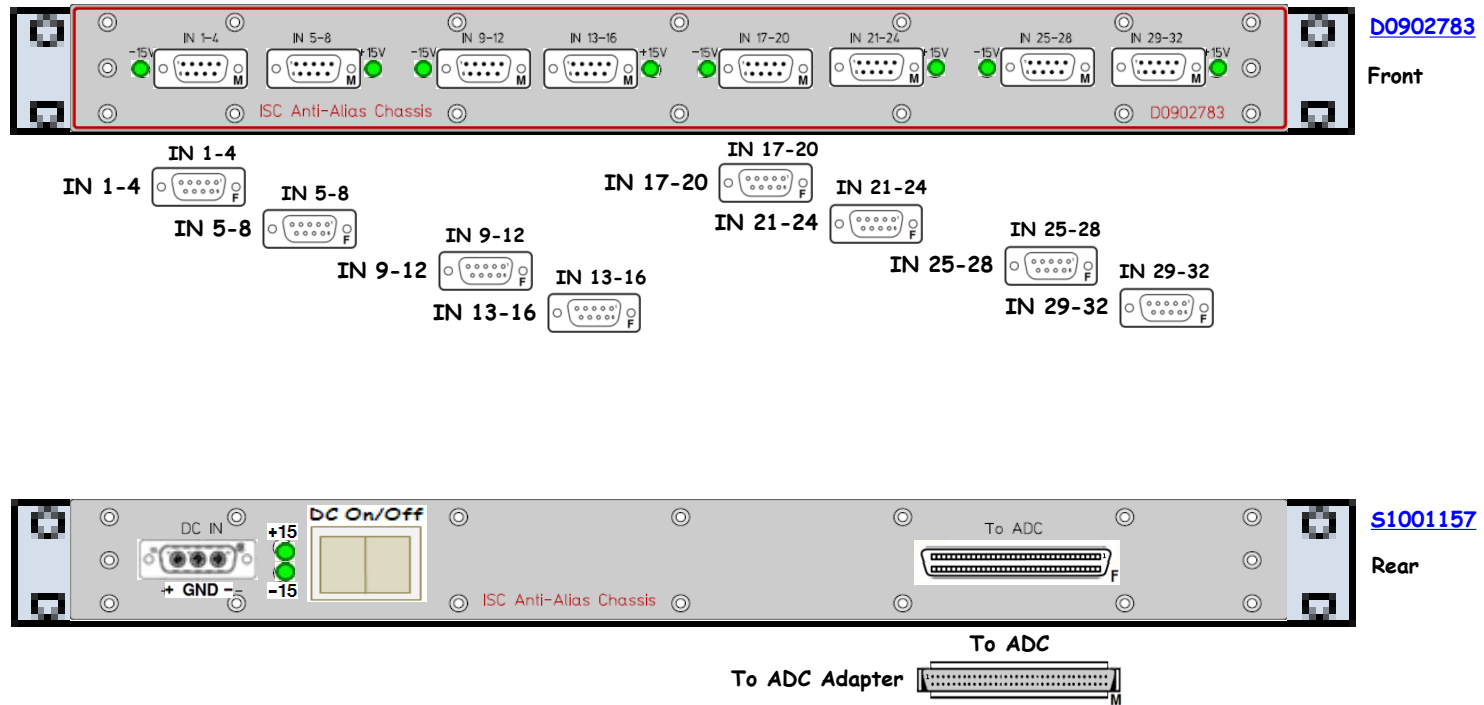

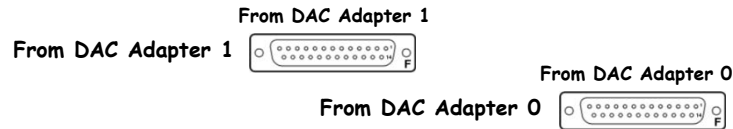
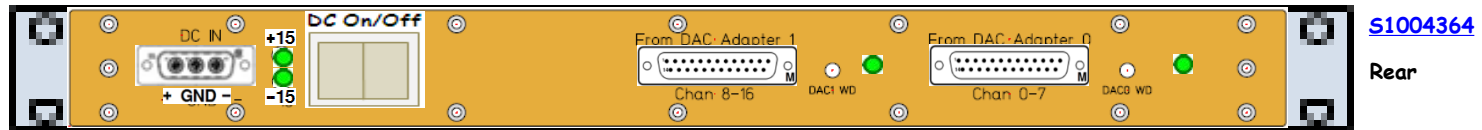
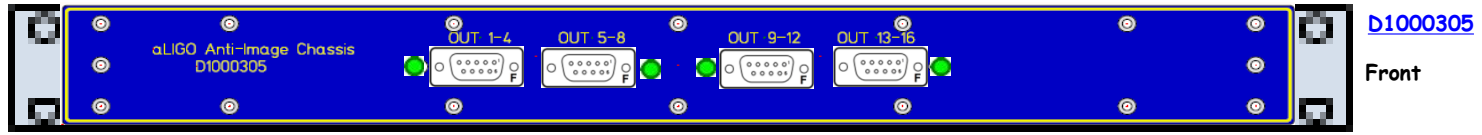

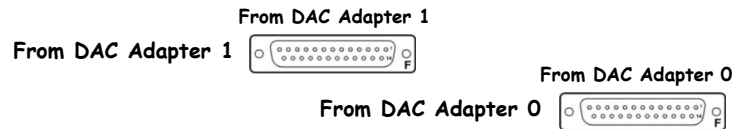
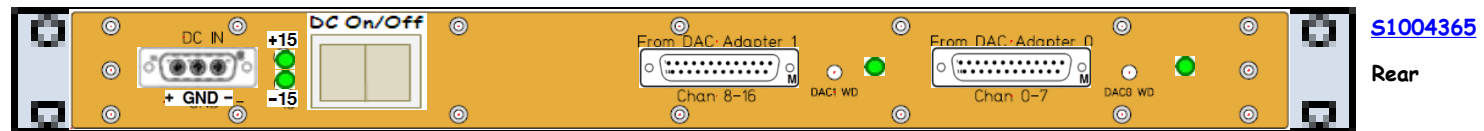
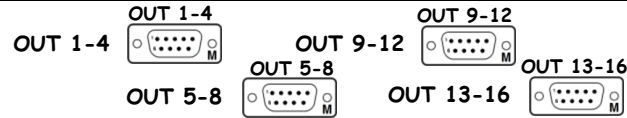
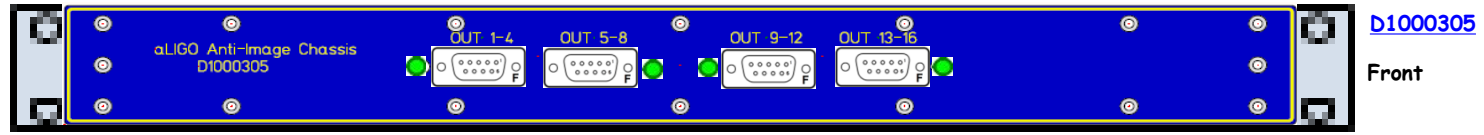

D1100815 is an AI, which means it has OUTPUTS, not INPUTS. The labels are incorrect.

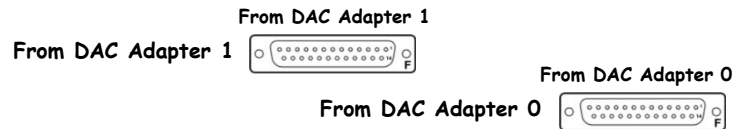
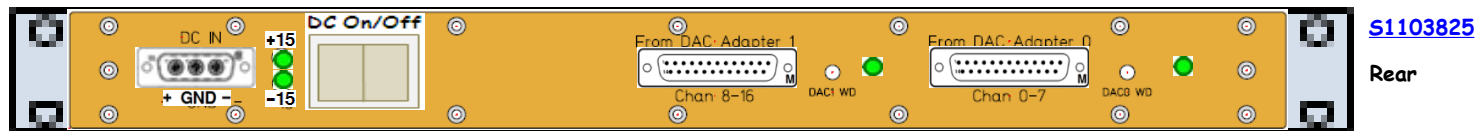
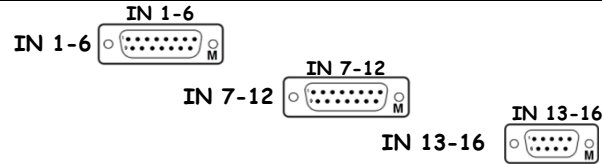
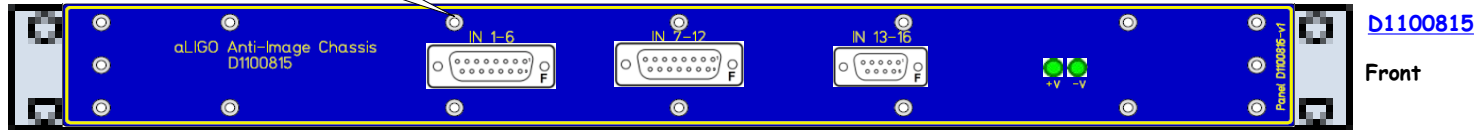

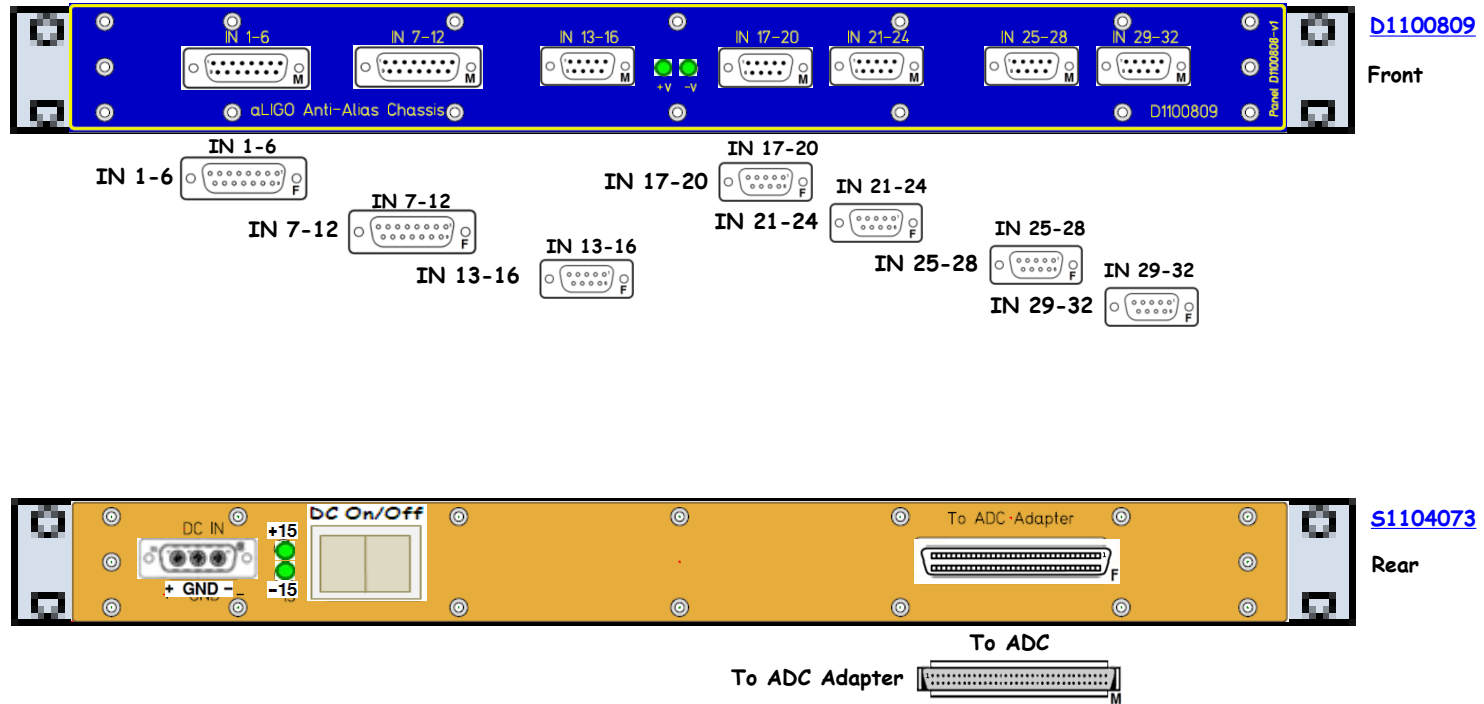

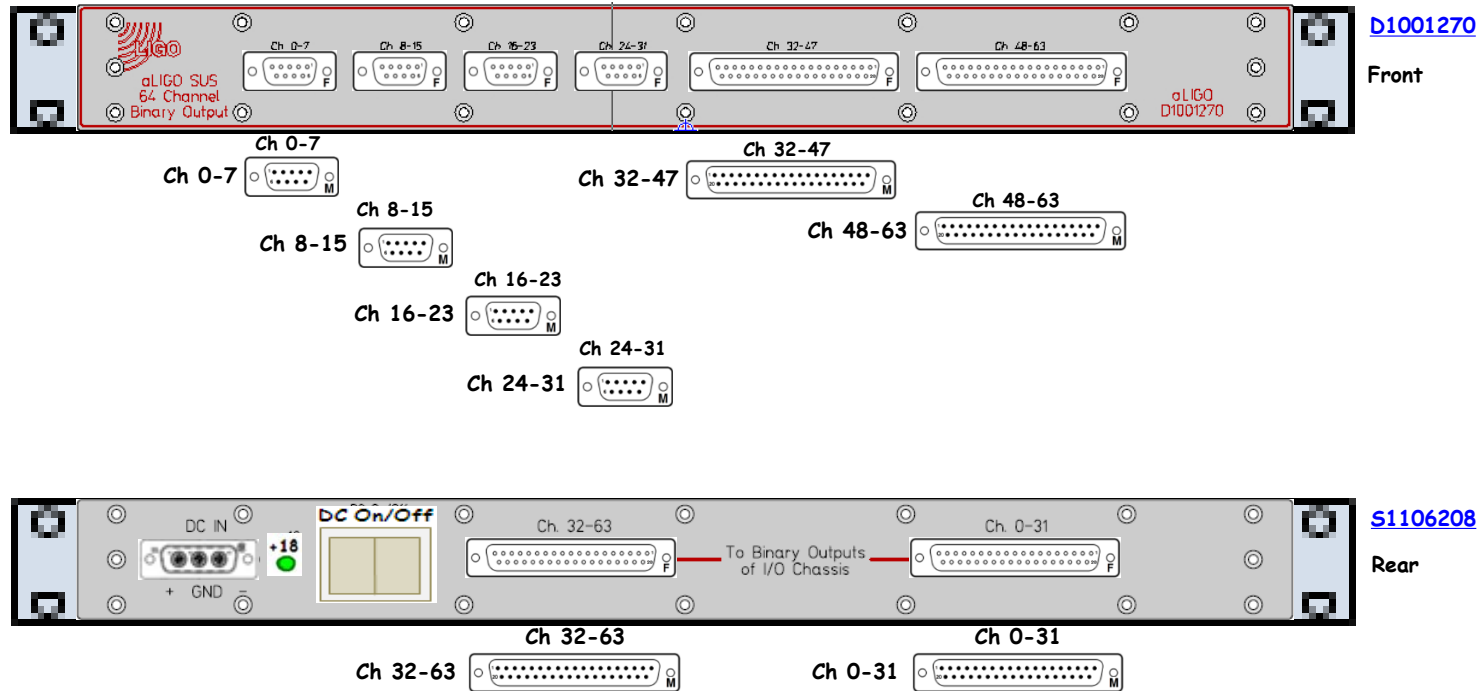

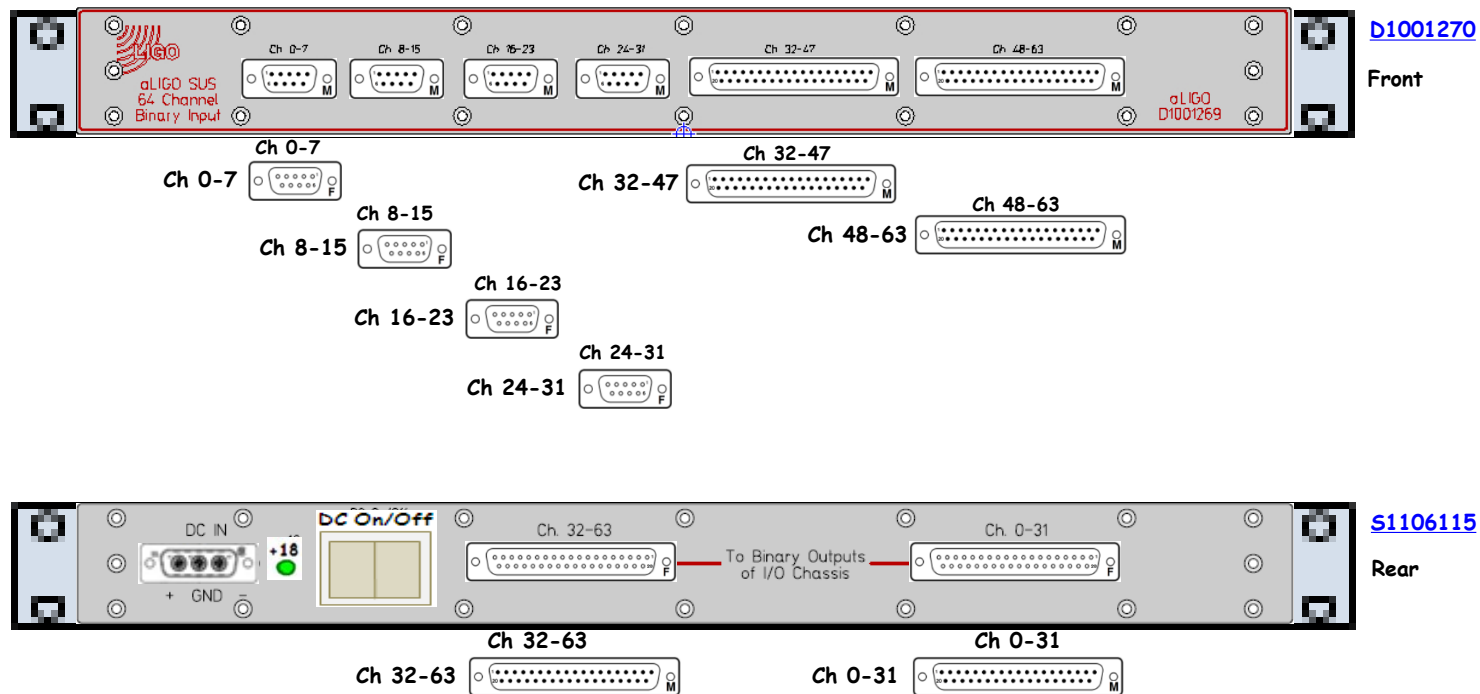

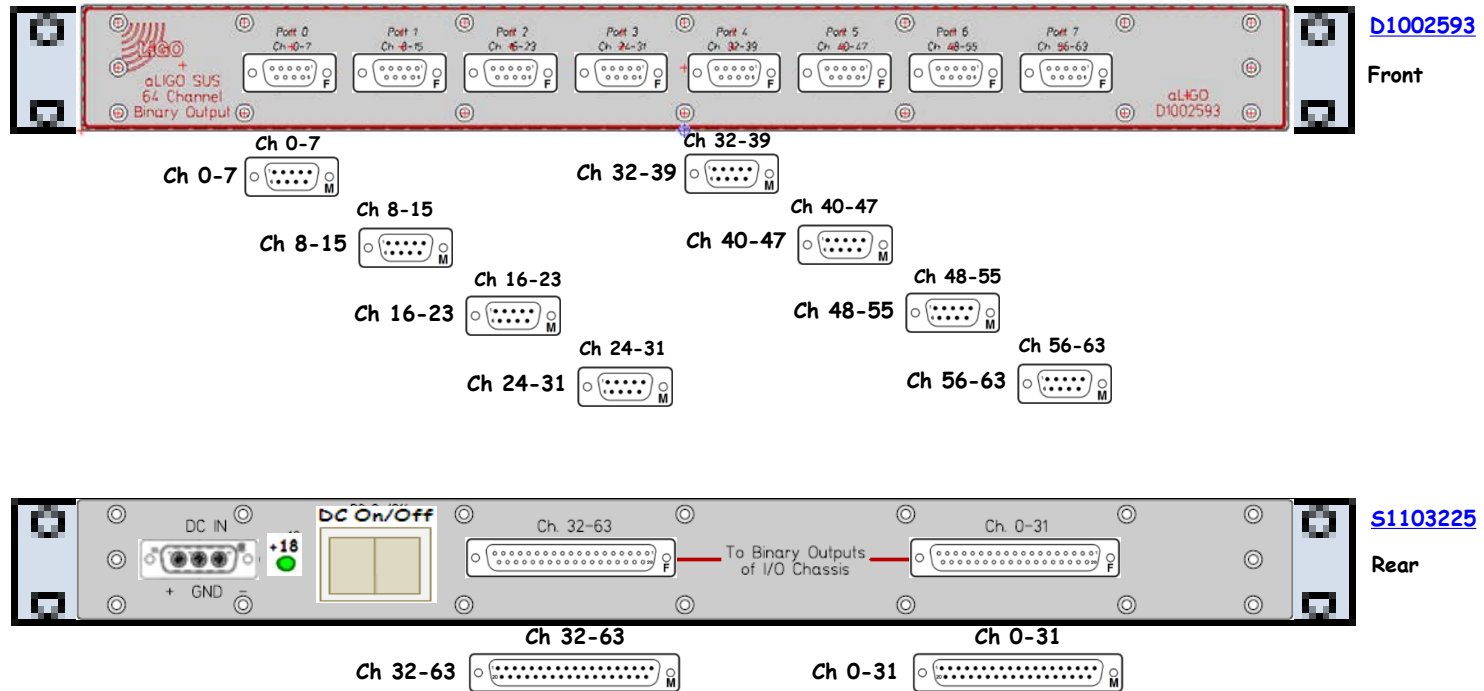

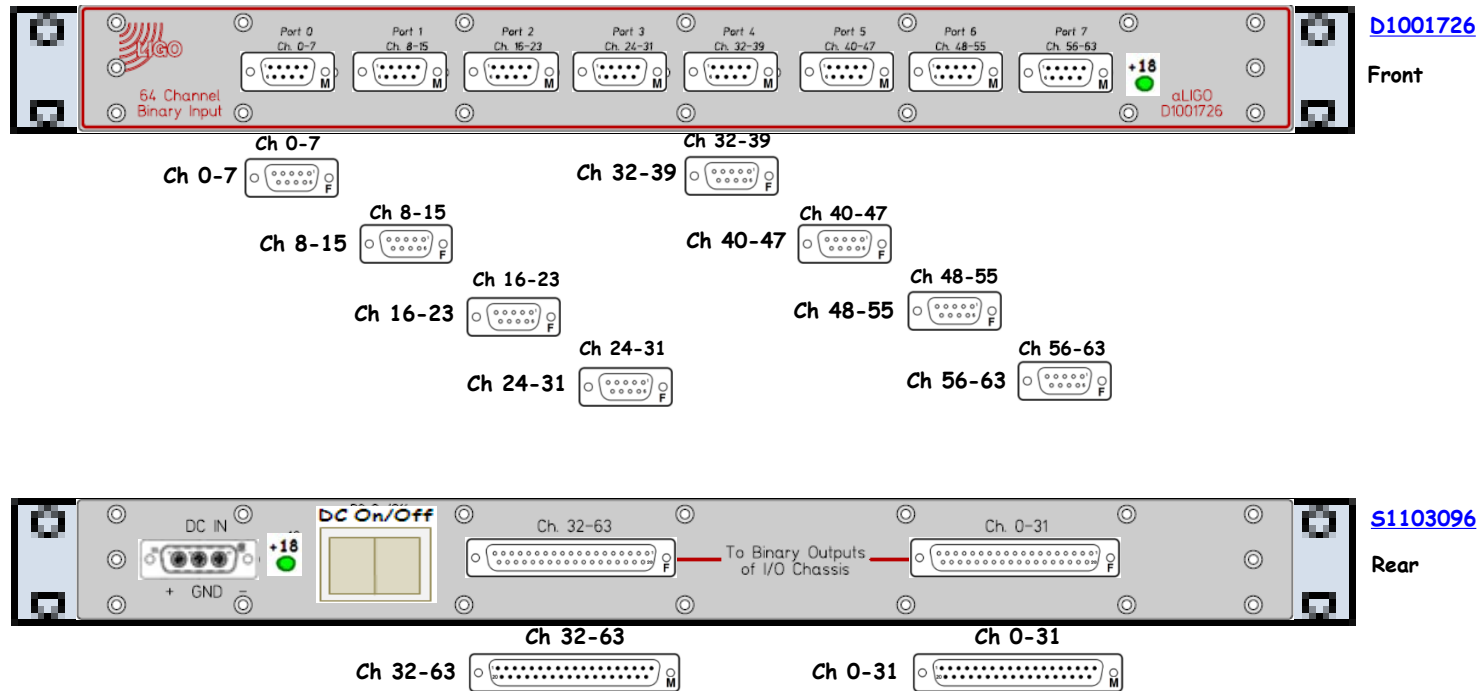

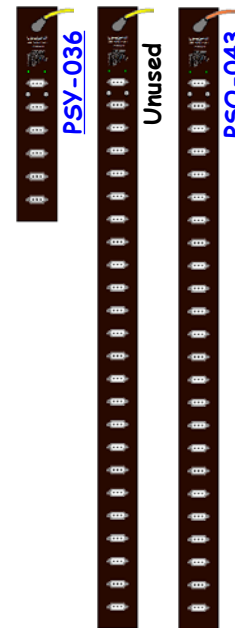
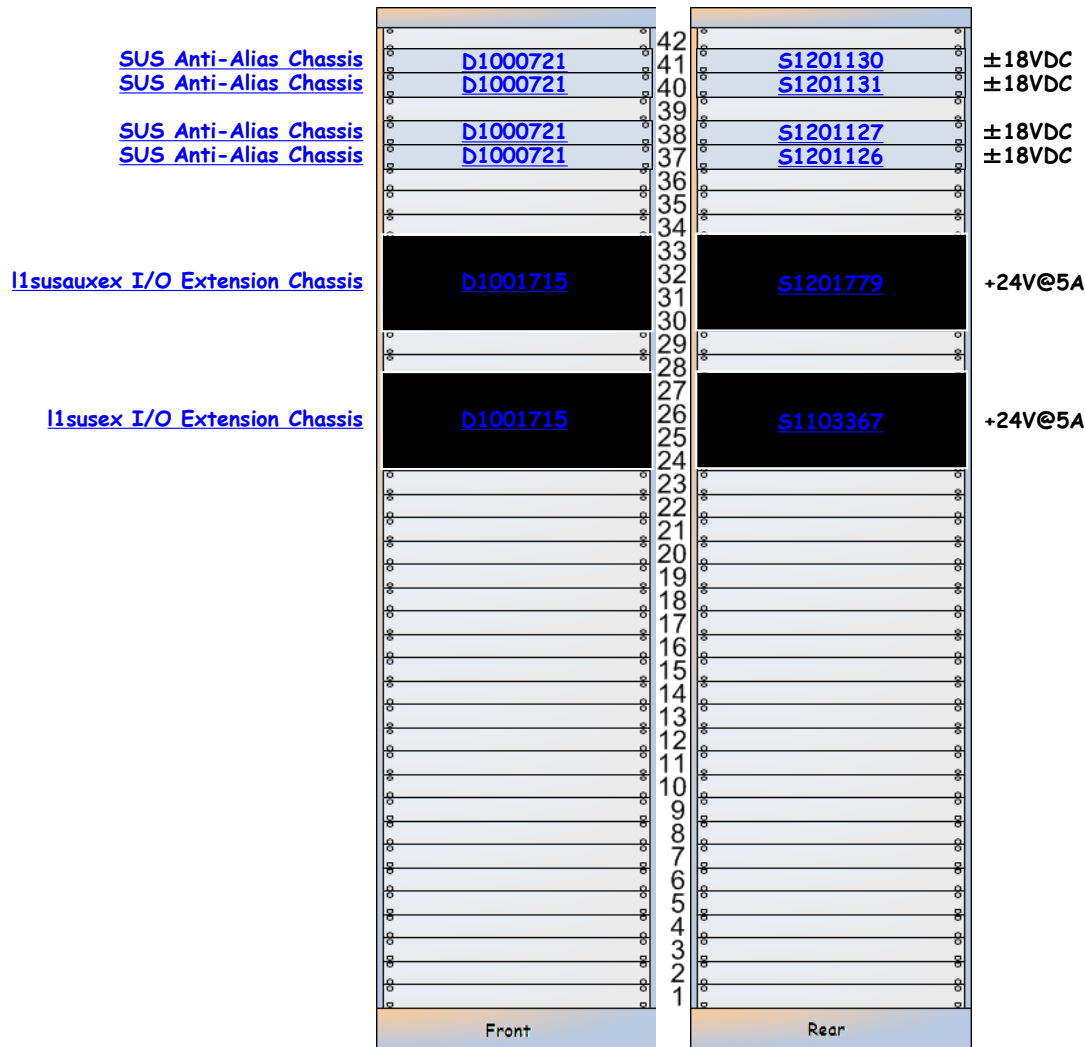

SUS Anti-Alias Chassis D1000721 S1201130 ±18@0.5A

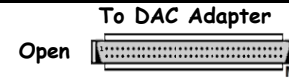
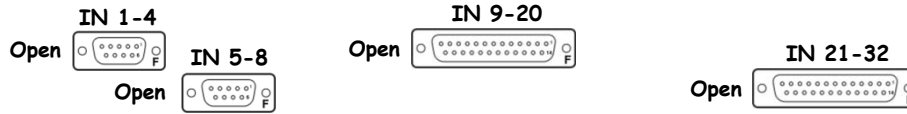
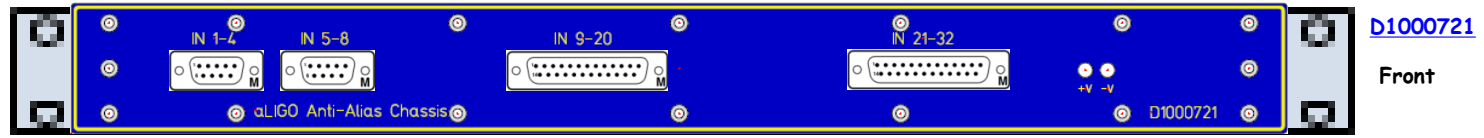

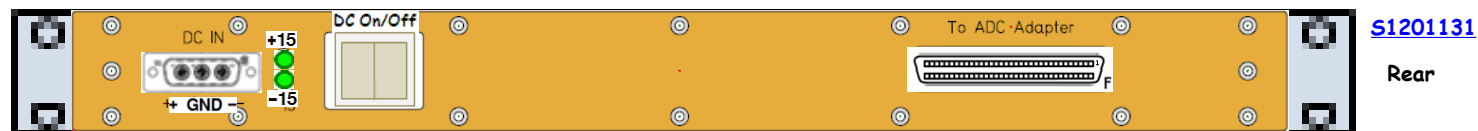
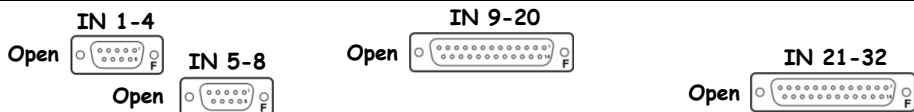
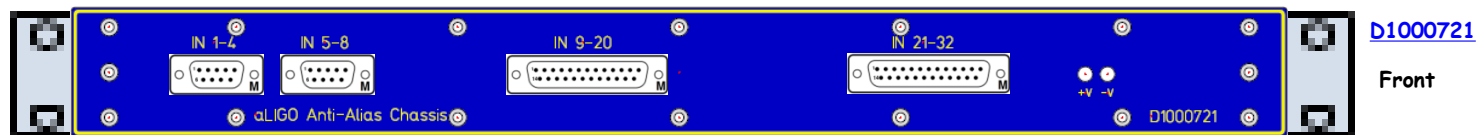

SUS Anti-Alias Chassis D1000721 S1201127 ±18@0.5A

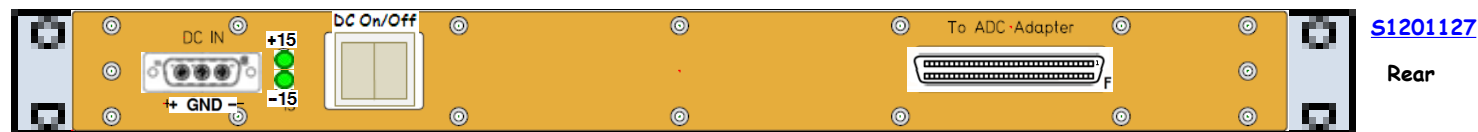
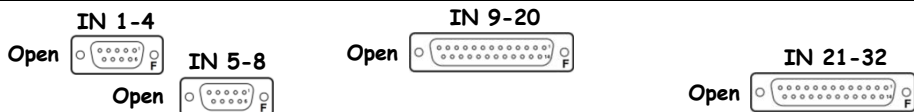
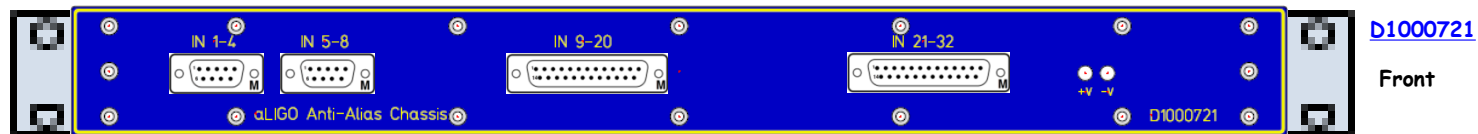

SUS Anti-Alias Chassis D1000721 S1201126 ±18@0.5A

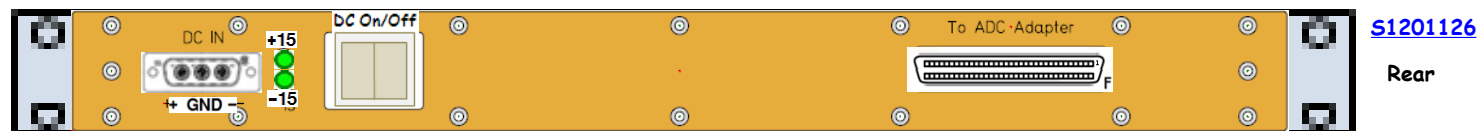
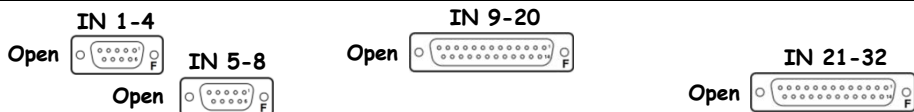
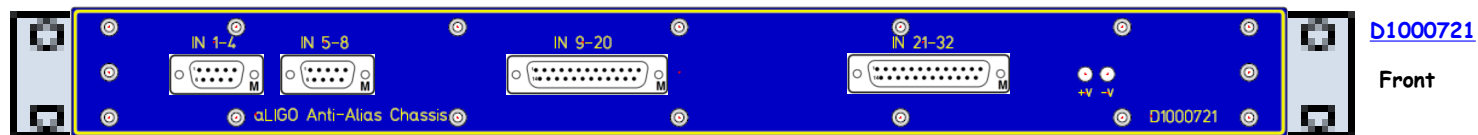



D1001715
Front

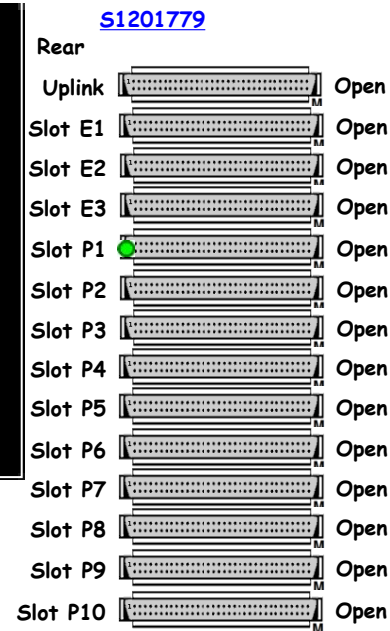
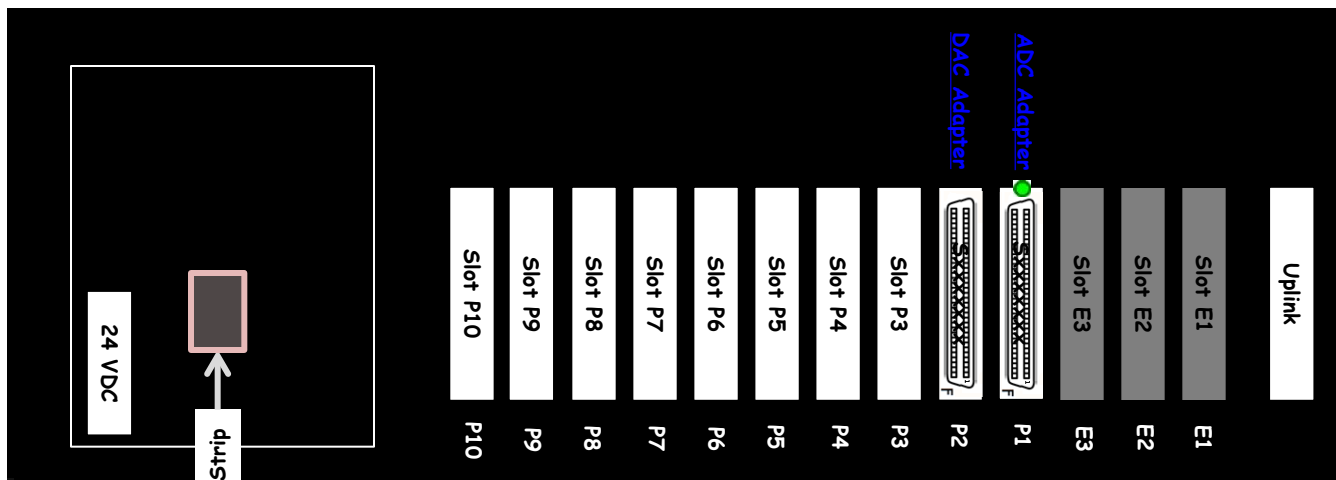

l1susex I/O Extension Chassis

D1001715

S1103367

110VAC



D1001715
Front

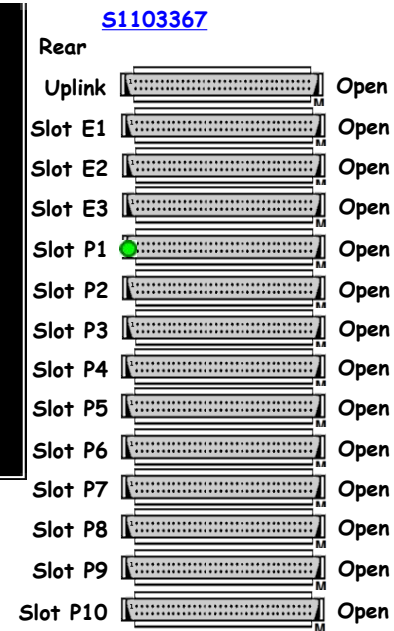
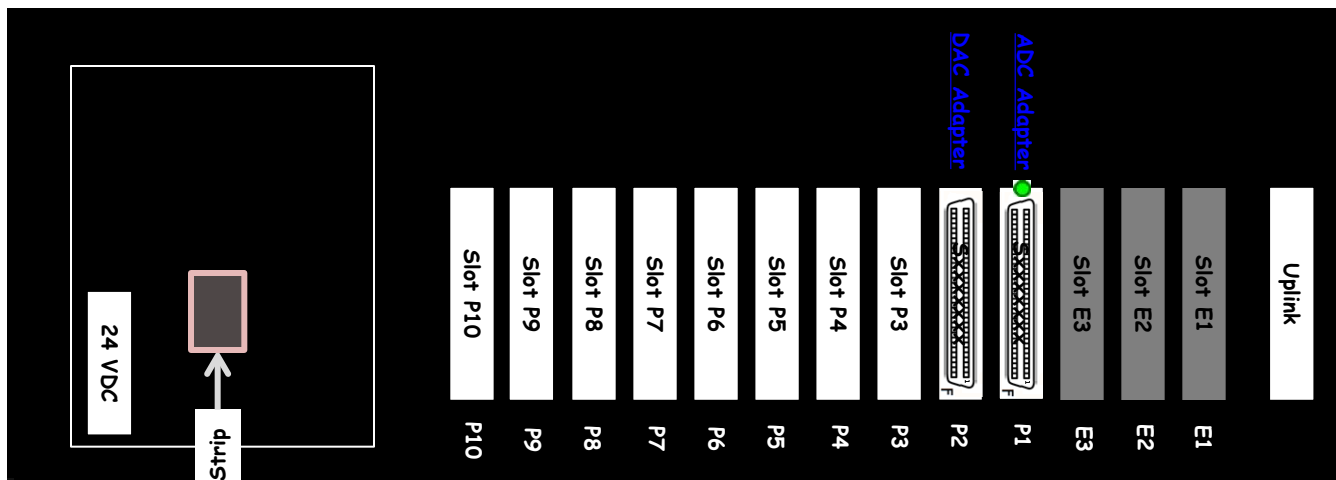

L1-TCS-XC1

L1-TCS-XC1 X-End Remote Rack Layout ([D1201129](#)) ([S1202980](#))

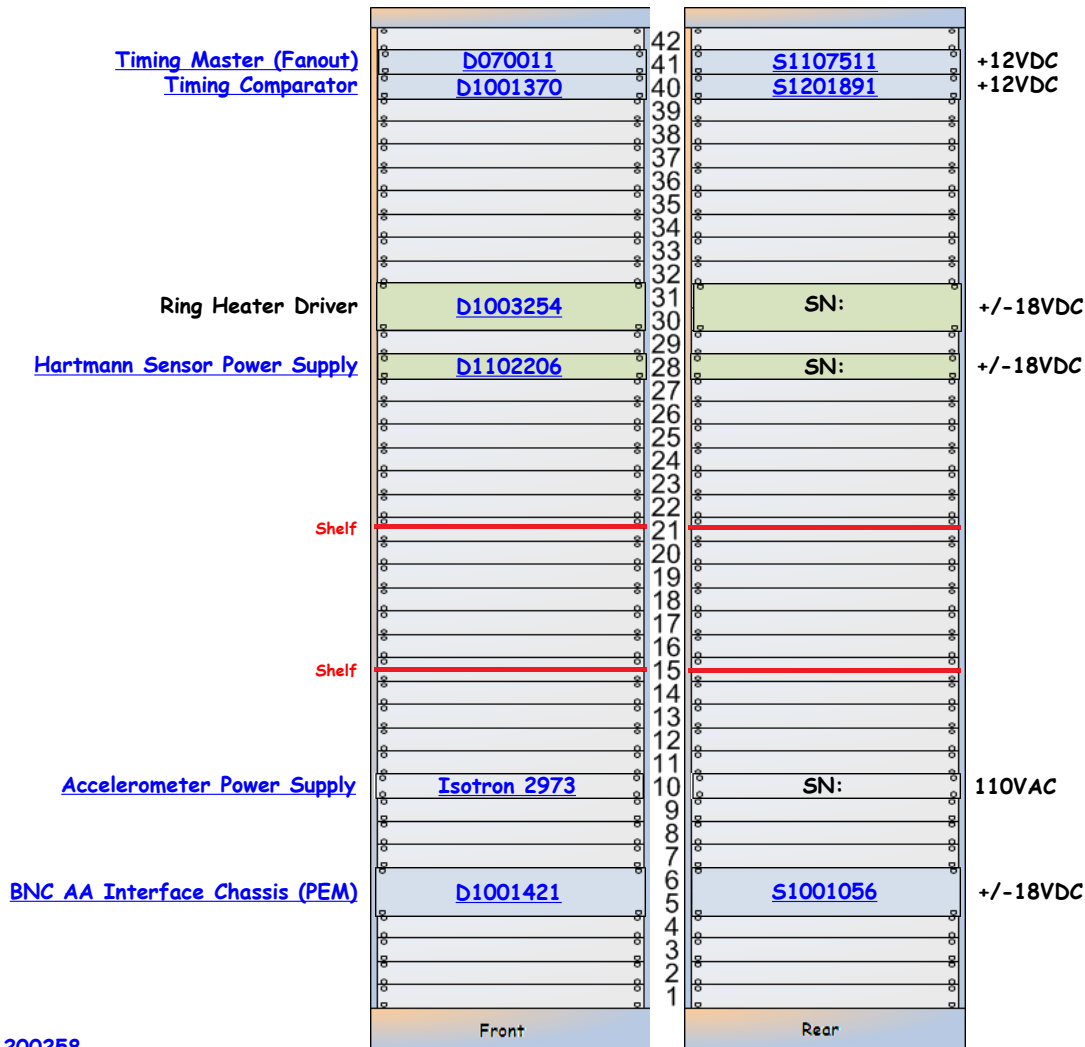

TCS-XC1 is part of [D1200258](#)

TCS-XC1 is part of [E1100894](#)



[D070011](#)

Front

[To 1X23 PP B4, B5](#)

[To 11pinex IO Front Panel](#)



[S1107511](#)

Rear

[To D070124 Green Cable](#)

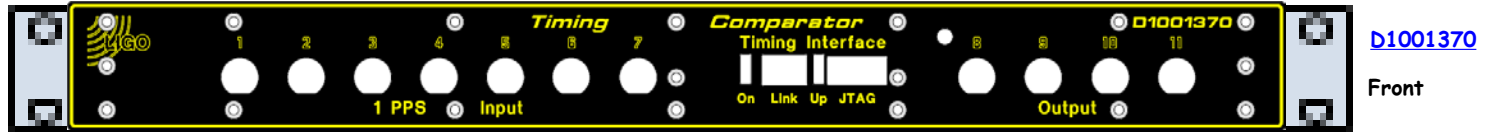

[D1001370](#)
Front

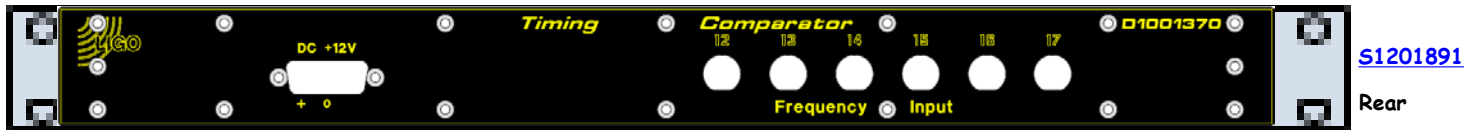

[S1201891](#)
Rear

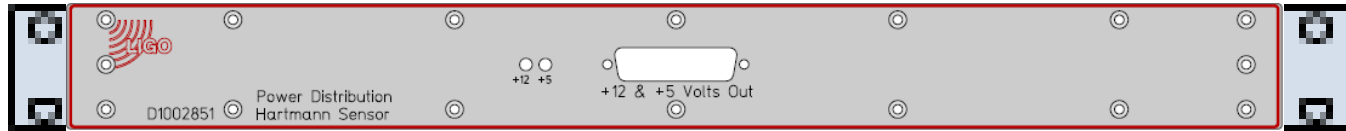

D1102206
Front



Sxxxxxxx
Rear

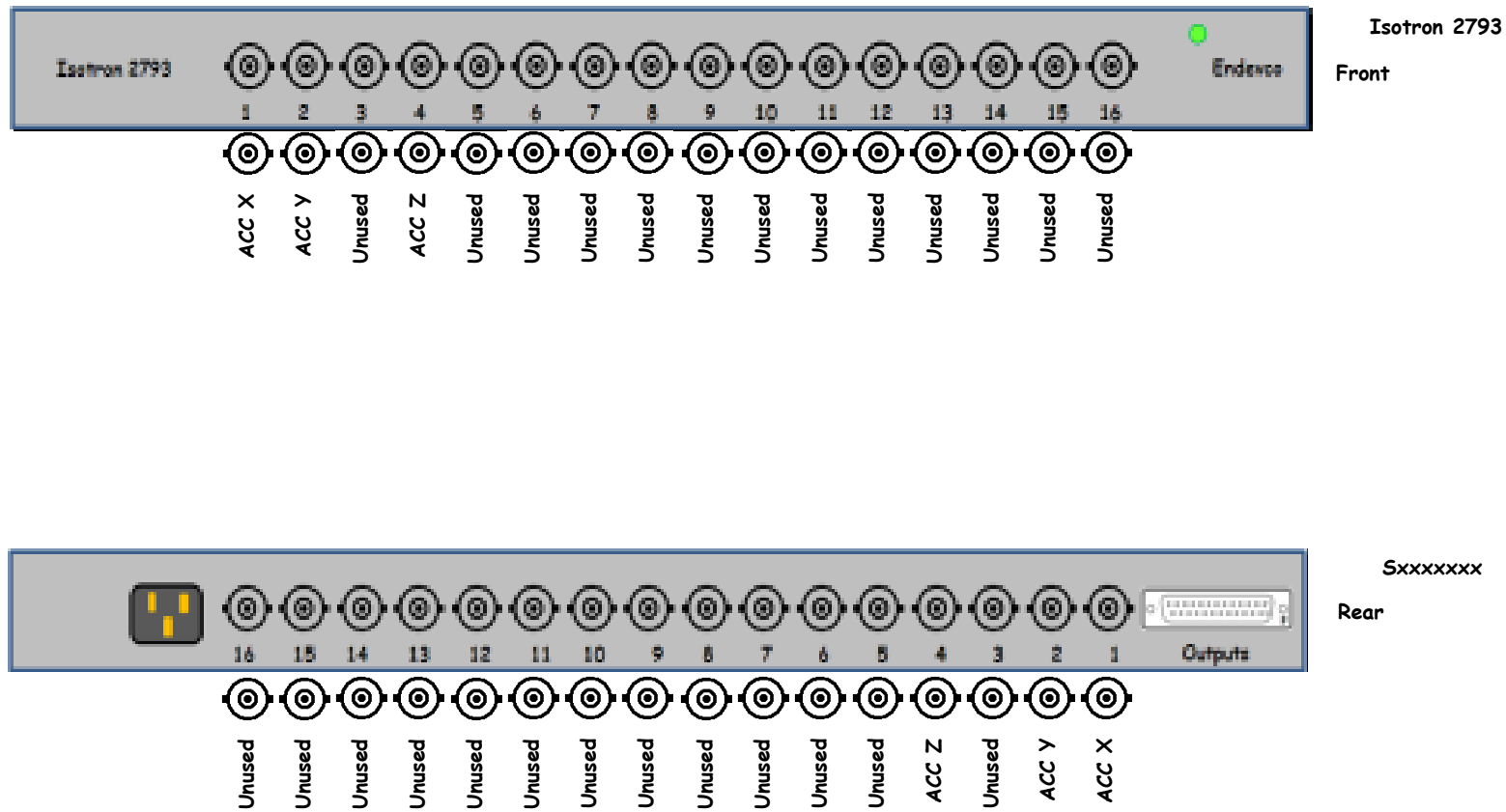

Isotron 2793
Front

Sxxxxxxx
Rear

<< L1-TCS-XC1

aLIGO AA Interface Chassis
(32 BNC, x10 Gain Version)

D1001421

SN:

Power

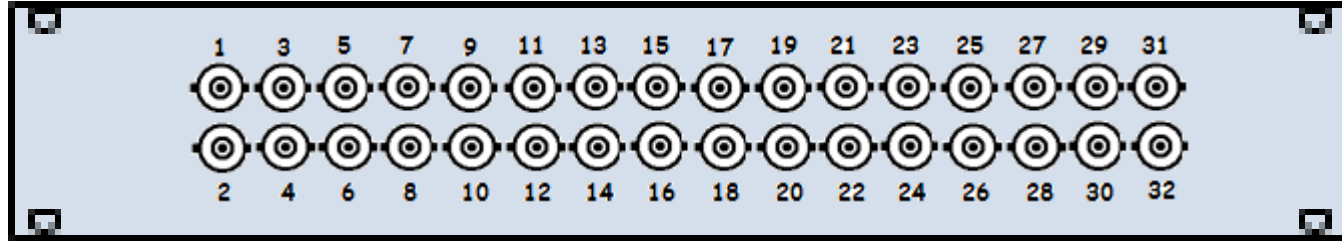

D1001421

Front

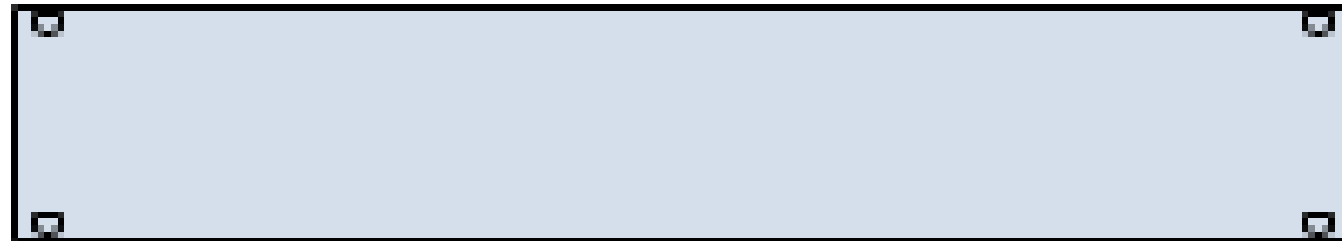
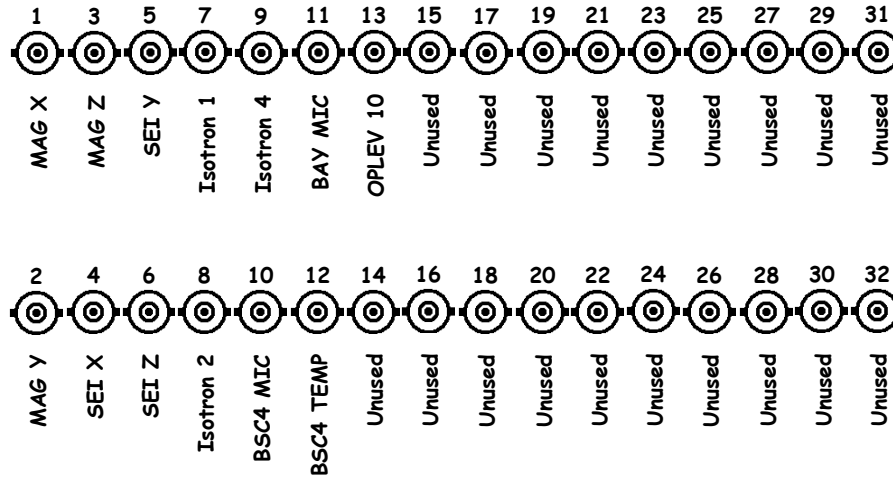

SN:

Rear

<< L1-TCS-XC1

aLIGO Accelerometer Interface Chassis

D1101363

SN:

Power

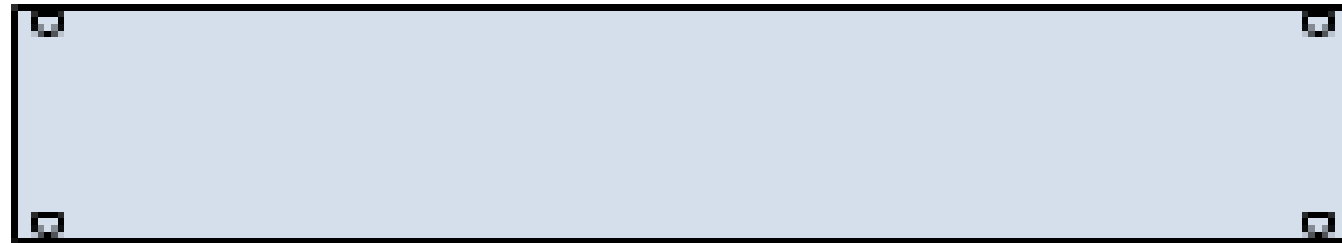
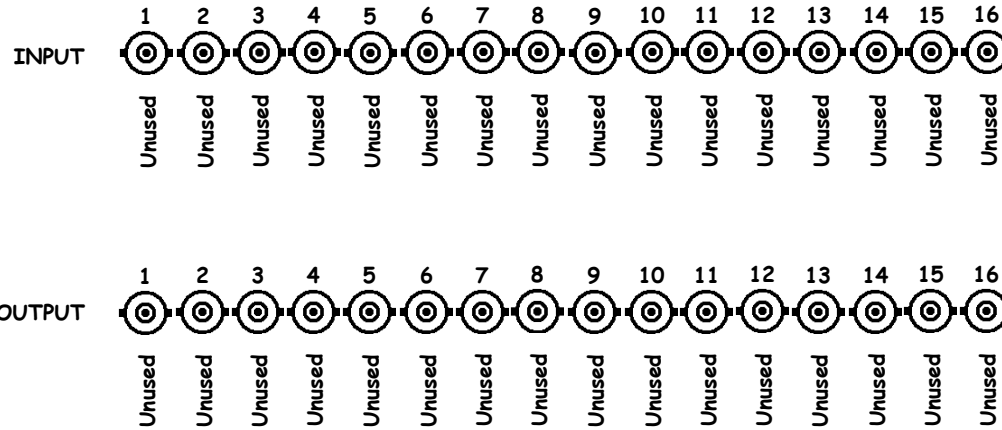
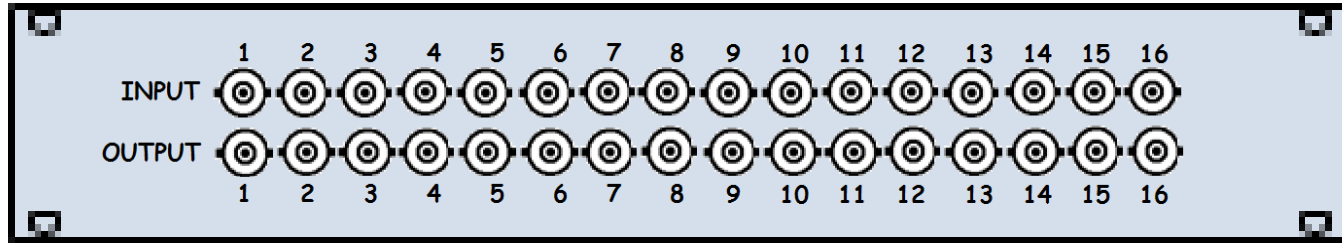

D1101363

Front

SN:

Rear

Status as of 9 November, 2012

End Station ISC Field Rack Layout

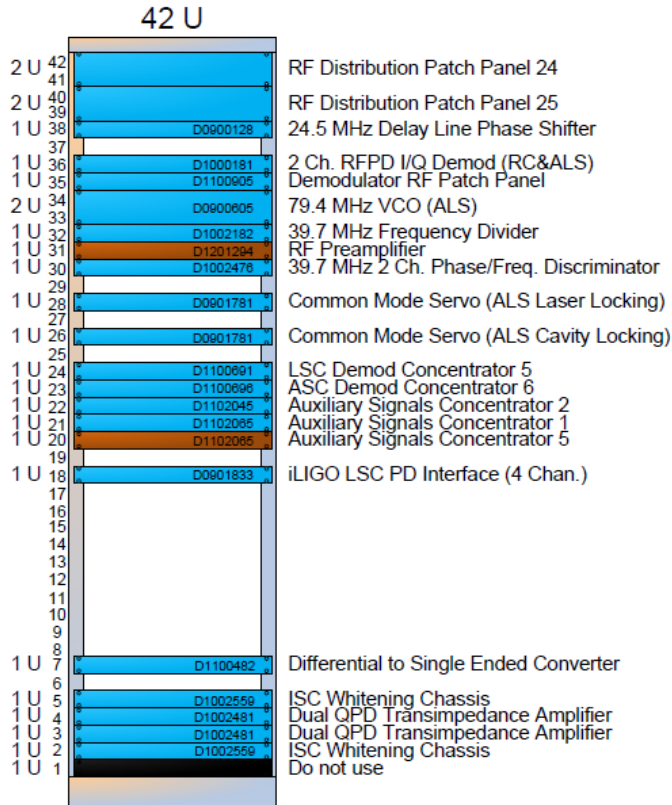

End Station Field Rack LIGO D1001423-v13

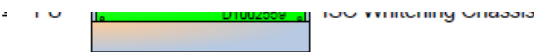

ISC-XR1 is part of [D1001423](#) End Station Field Rack LIGO D1001423-v11

Status reflects OAT at H2 Y only

ISC Field Rack Layout

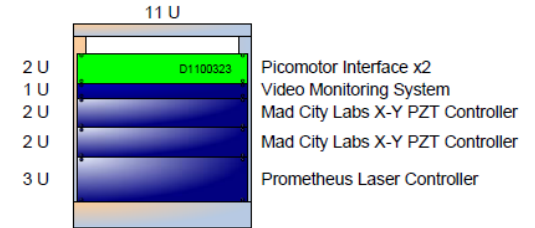
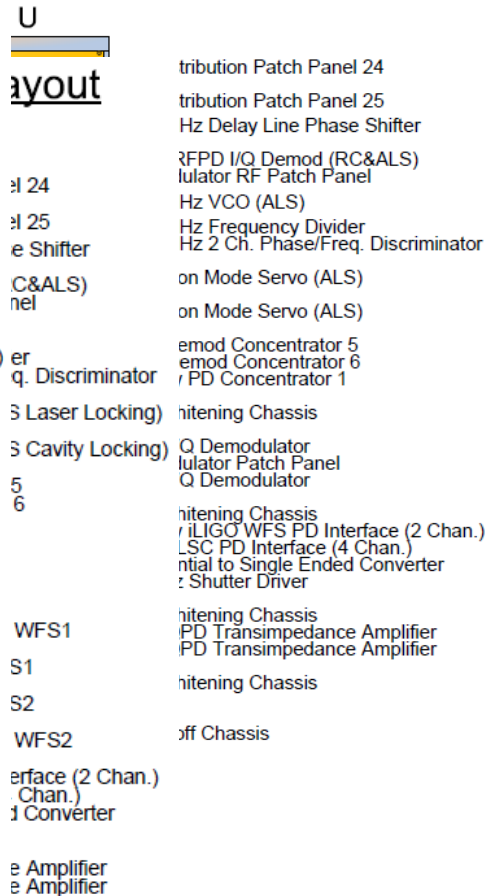

Mini Rack By ISCT

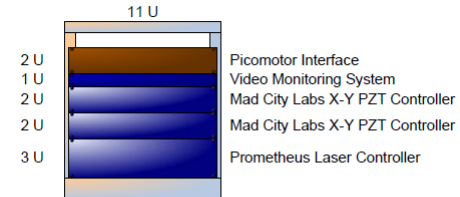

Mini Rack By ISCT LIGO D1001423-v8

D1100905 - Sxxxxxxx



LIGO

<< L1-ISC-XR1

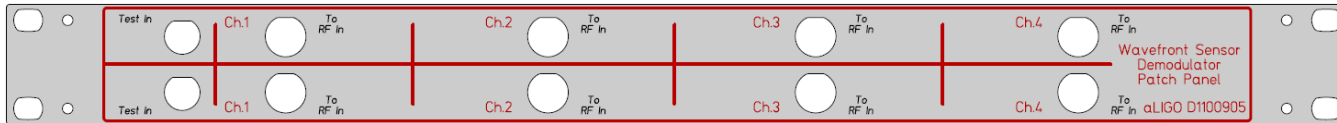

D1002476 - Sxxxxxxx



<< L1-ISC-XR1

158.8 / 79.4 MHz 2-Channel PF Discriminator

D1002476

Sxxxxxxx

±17VDC, ±24VDC

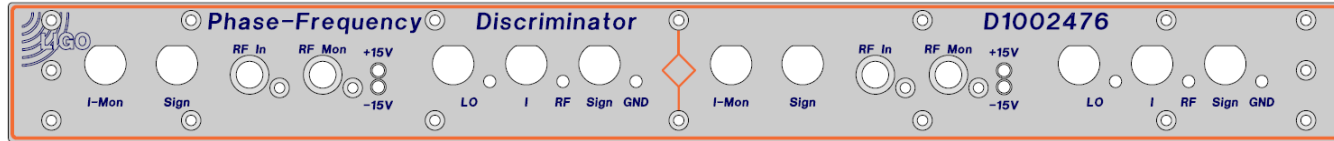

D1002476

Front

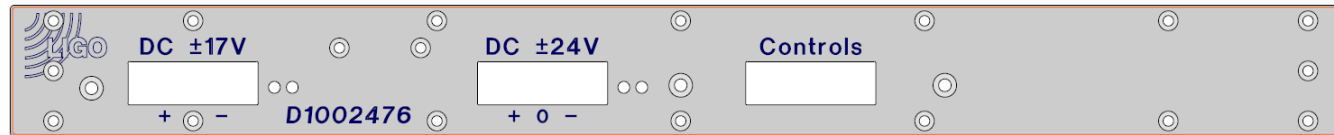

Sxxxxxxx

Rear

[Electrostatic Driver](#)

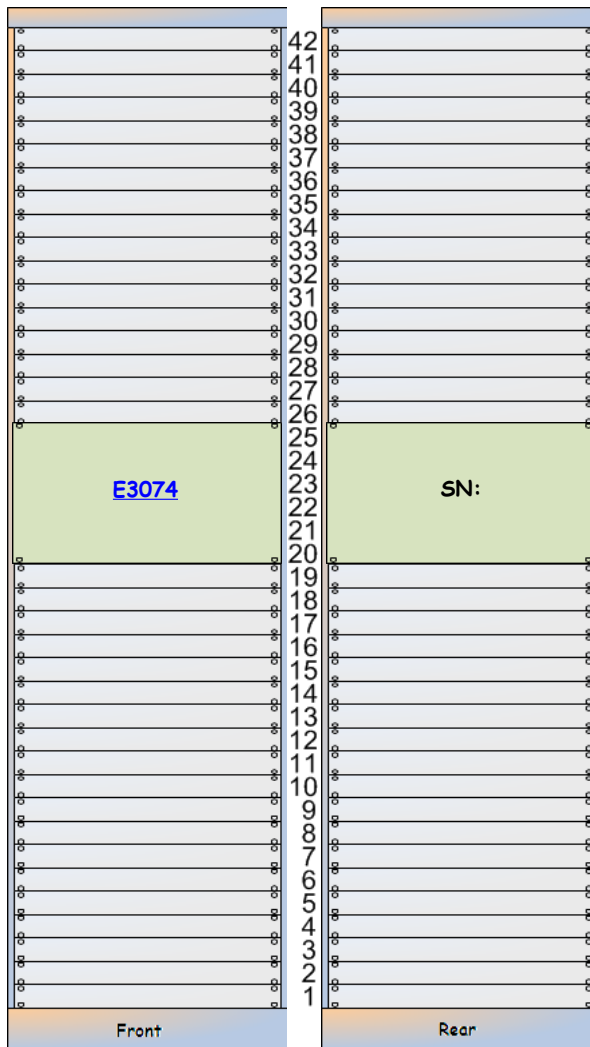

E3074

SN:

+ -18VDC@0.4A
+ -430VDC@15mA

+18VDC	?A
-18VDC	?A
+24VDC	?A

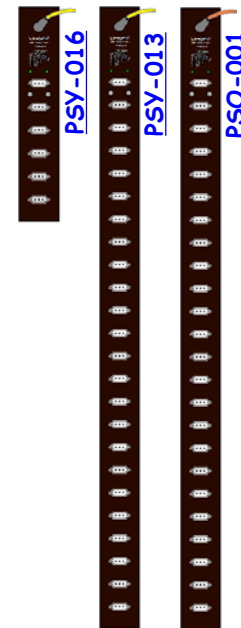

Front

Rear

E3074

Electrostatic Driver

E3074

SN:

+ -18VDC@0.4A
+ -430VDC@15mA



E3074

Front



S???????

Rear

L1-VAC-XR1

L1-VAC-XR1 X-End Vacuum Rack Layout (Dxxxxxxx)

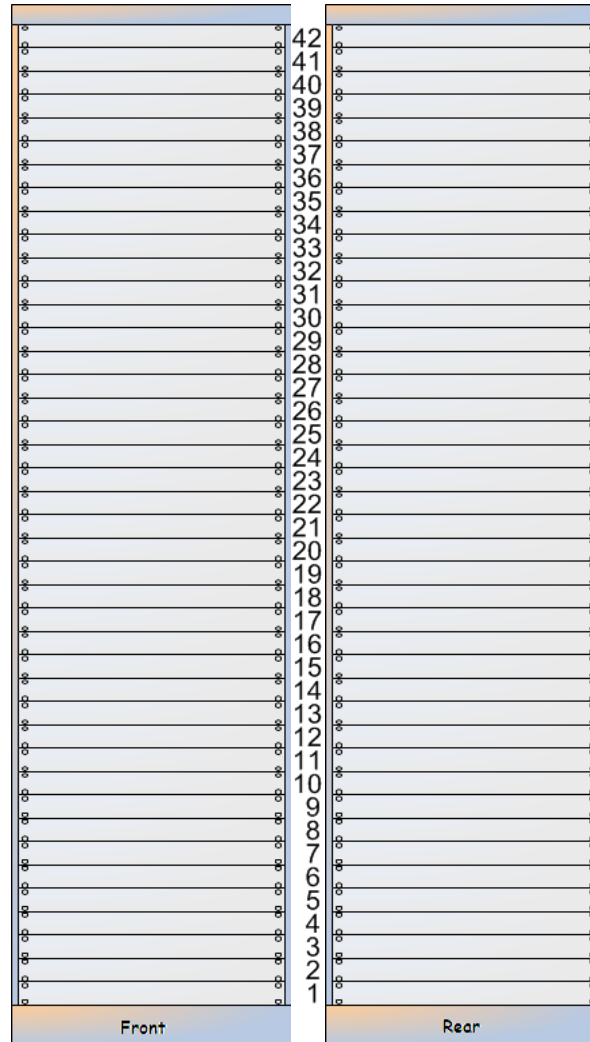

[<< LLO Corner Station](#)

[<< LLO Racks by AREA](#)

[<< LLO CDS Components](#)

VEAY

Y-End Station Rack Layout

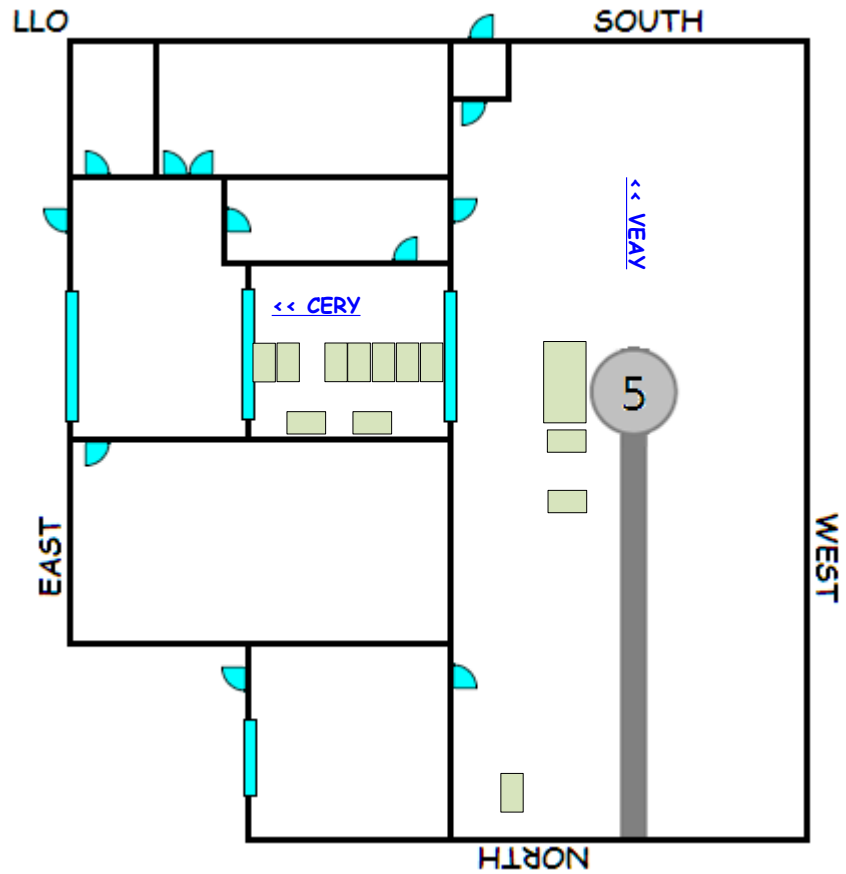

Y-End Station Rack Layout

[<< LLO Corner Station](#)

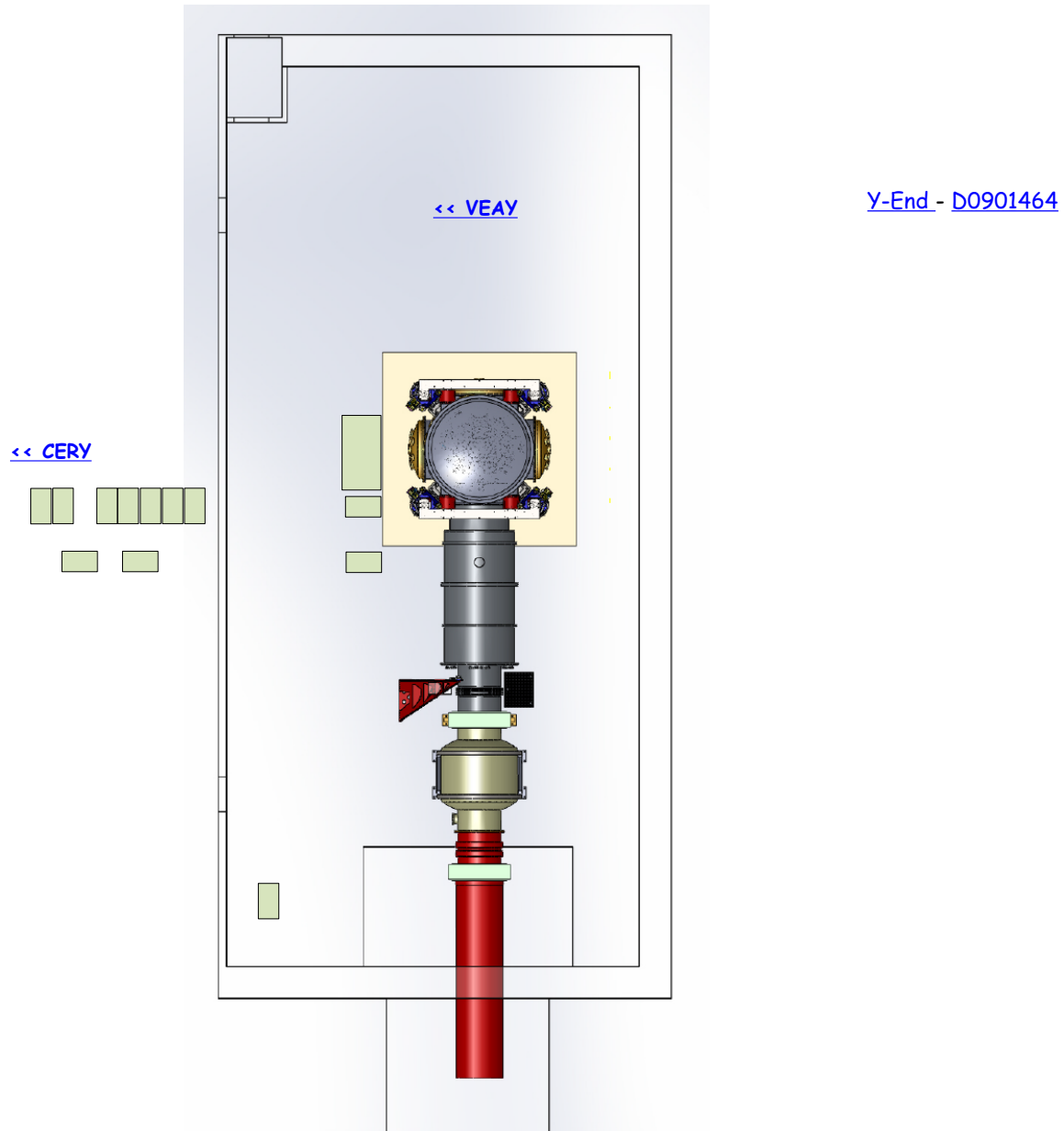

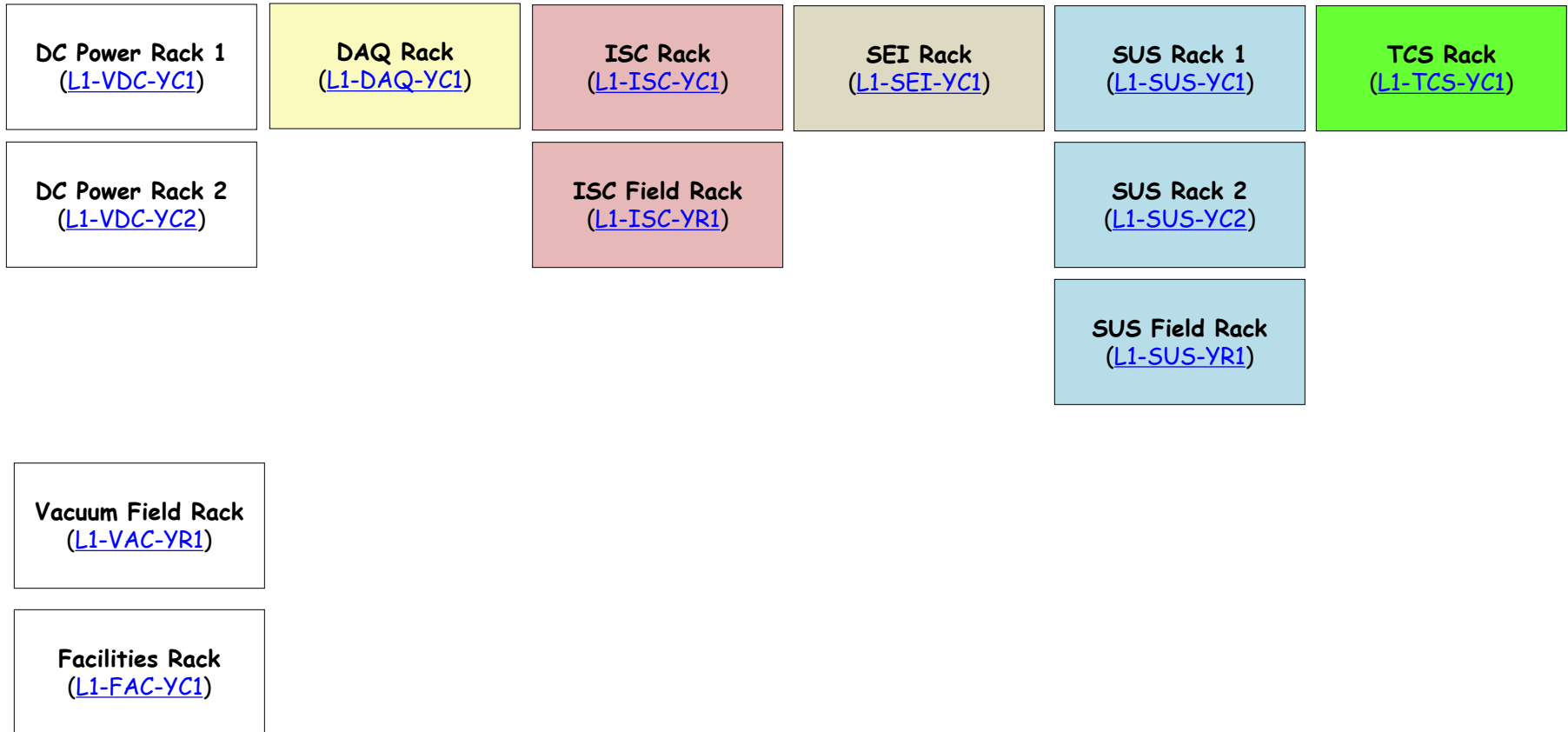

Corning WCH-06P Fiber Panel

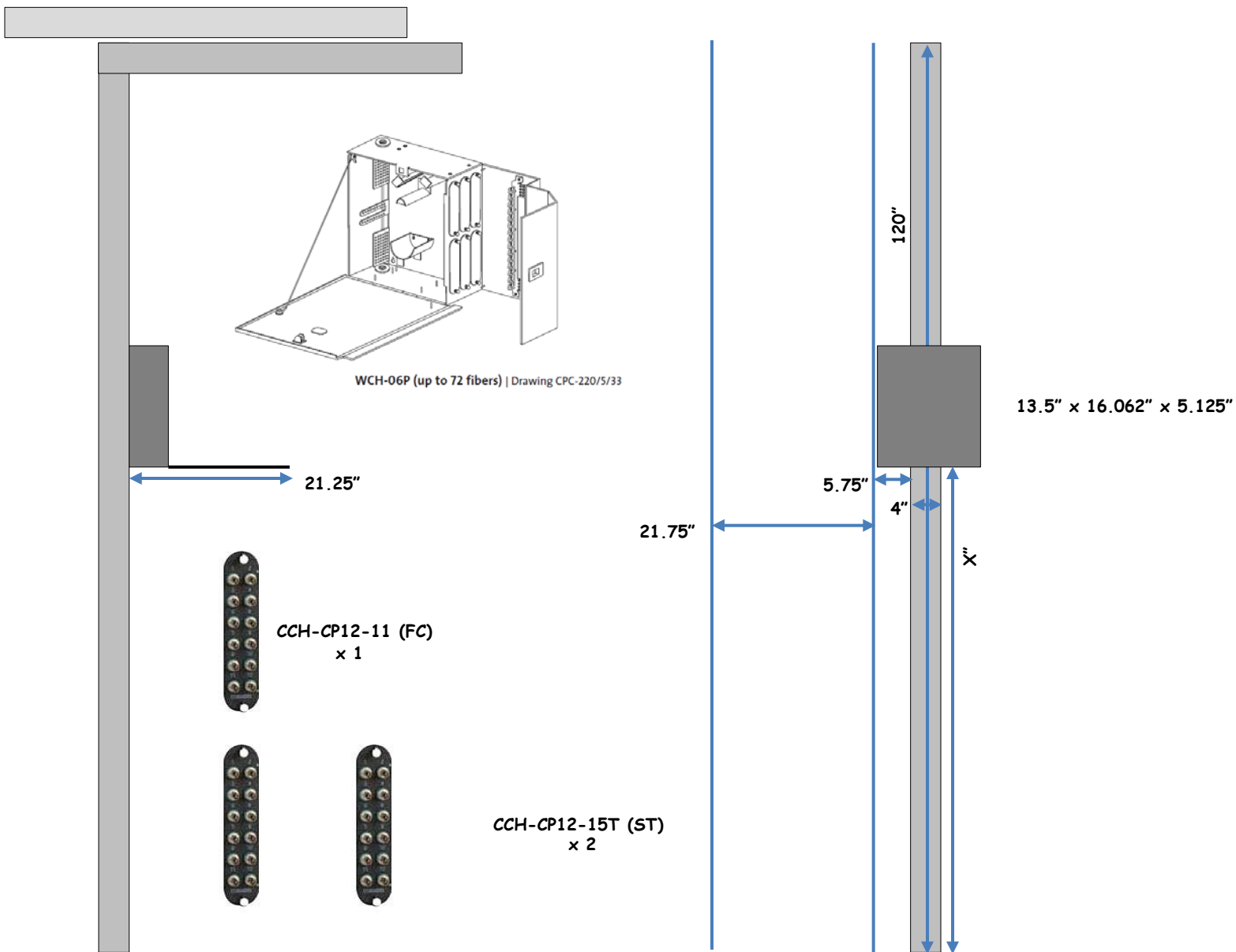

WCH-06P - Patch Panel

Patch Panel

Patch Panel

Patch Panel

No Power



FC Connectors

- [l1lanfey 21F \(Clear\)](#) ↔ 1-1
- [l1lanfey 21F \(None\)](#) ↔ 1-2
- [X448 1F](#) ↔ 1-3
- [X448 1F](#) ↔ 1-4
- [ACC-5595 Port 6 \(Clear\)](#) ↔ 1-5
- [ACC-5595 Port 6 \(None\)](#) ↔ 1-6

- [VT430 Opt In/Out](#) ↔ 3-1
- [7711-R Opt In/Out](#) ↔ 3-2
- [2402 26F \(White\)](#) ↔ 3-3
- Empty ↔ 3-4
- [1Y23 PP Port 6](#) ↔ 3-5
- [1Y23 PP Port 5](#) ↔ 3-6

- Empty ↔ 2-1
- [TR30300WDM OPT In/Out](#) ↔ 2-2
- Empty ↔ 2-3
- [D070011 Fanout Input](#) ↔ 2-4
- [D070011 Fanout Input](#) ↔ 2-5
- [VT5030 Opt Out](#) ↔ 2-6

- [l1netfedaqy 21F \(Clear\)](#) ↔ 4-1
- [l1netfedaqy 21F \(None\)](#) ↔ 4-2
- [2402 26F \(Yellow\)](#) ↔ 4-3
- Empty ↔ 4-4
- Empty ↔ 4-5
- Empty ↔ 4-6

- Empty ↔ C1
- Empty ↔ C2
- Empty ↔ C3
- Empty ↔ C4
- Empty ↔ C5
- Empty ↔ C6

- Empty ↔ F1
- Empty ↔ F2
- Empty ↔ F3
- Empty ↔ F4
- Empty ↔ F5
- Empty ↔ F6

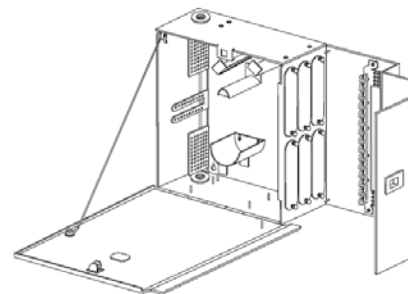

WCH-06P (up to 72 fibers) | Drawing CPC-220/5/33

It is 65' from the L1-FAC-YC1 Rack to the knee of the waterfall in the VEAY.

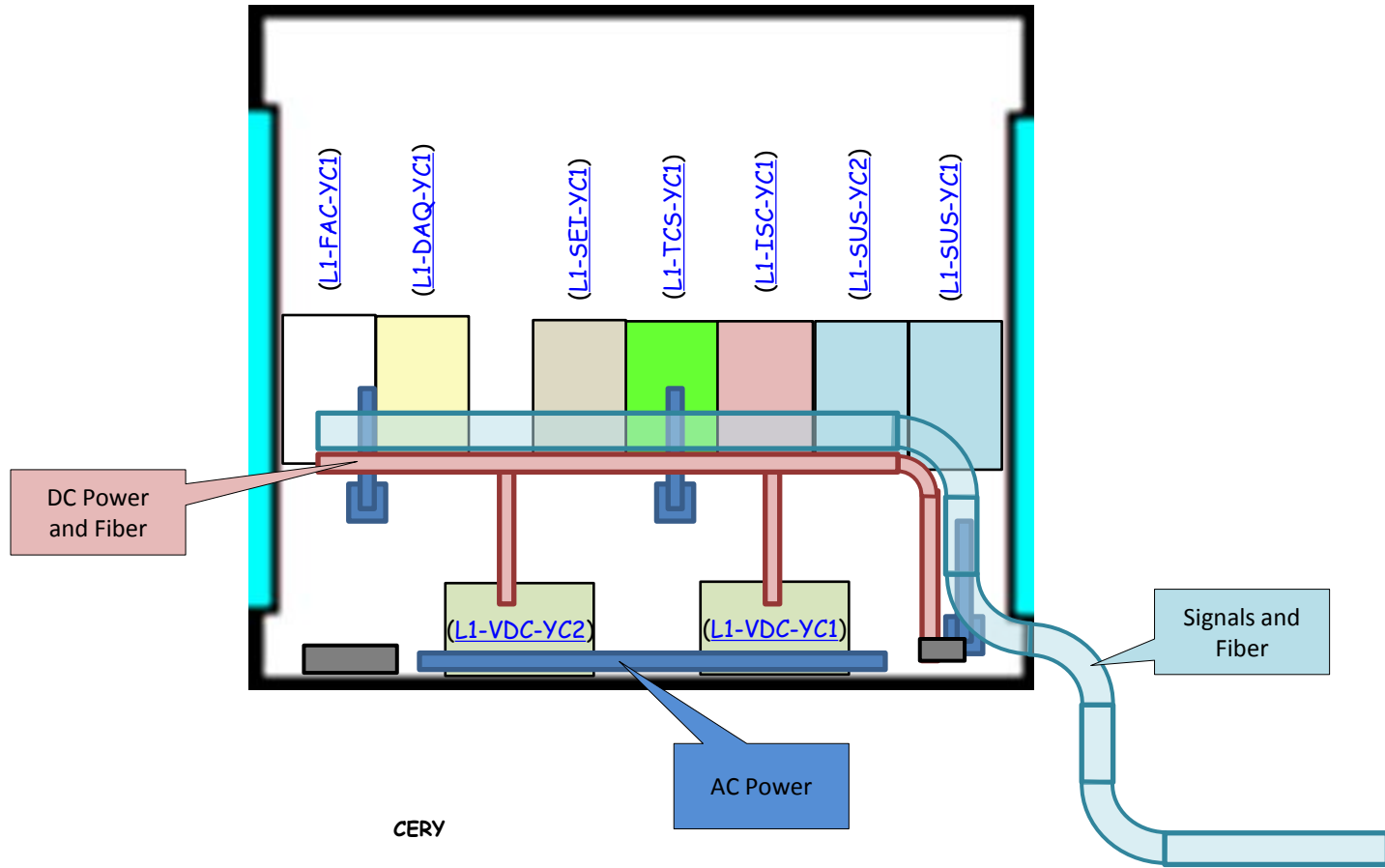

LLO Y-End Cable Tray Layout

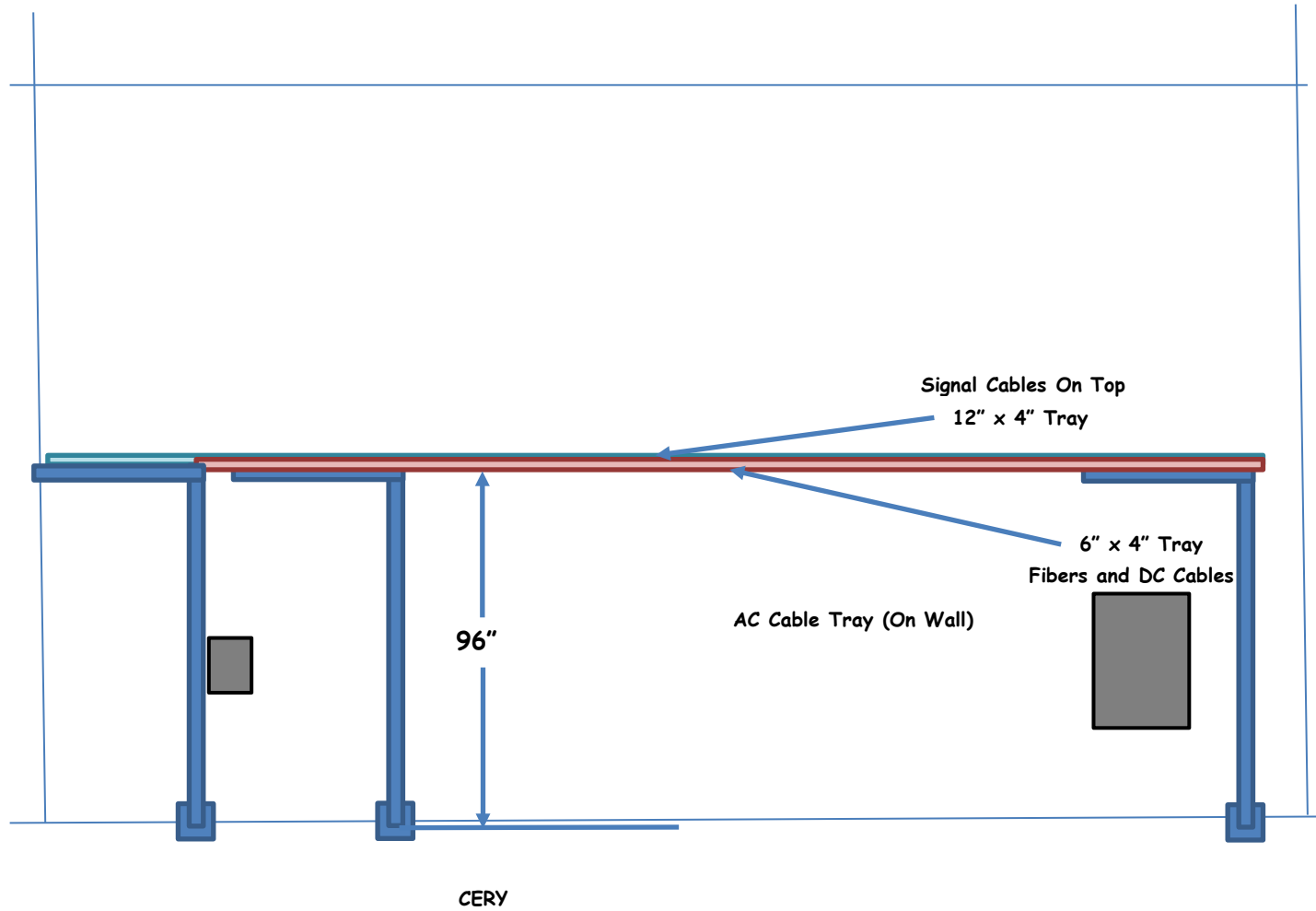

L1-VDC-YC1 Power Racks - VEAY Field Supplies

<< CERY Racks

L1-VDC-YC1 Y-End Station DC Power Rack Layout ([D1200899](#)) ([S1202313](#))

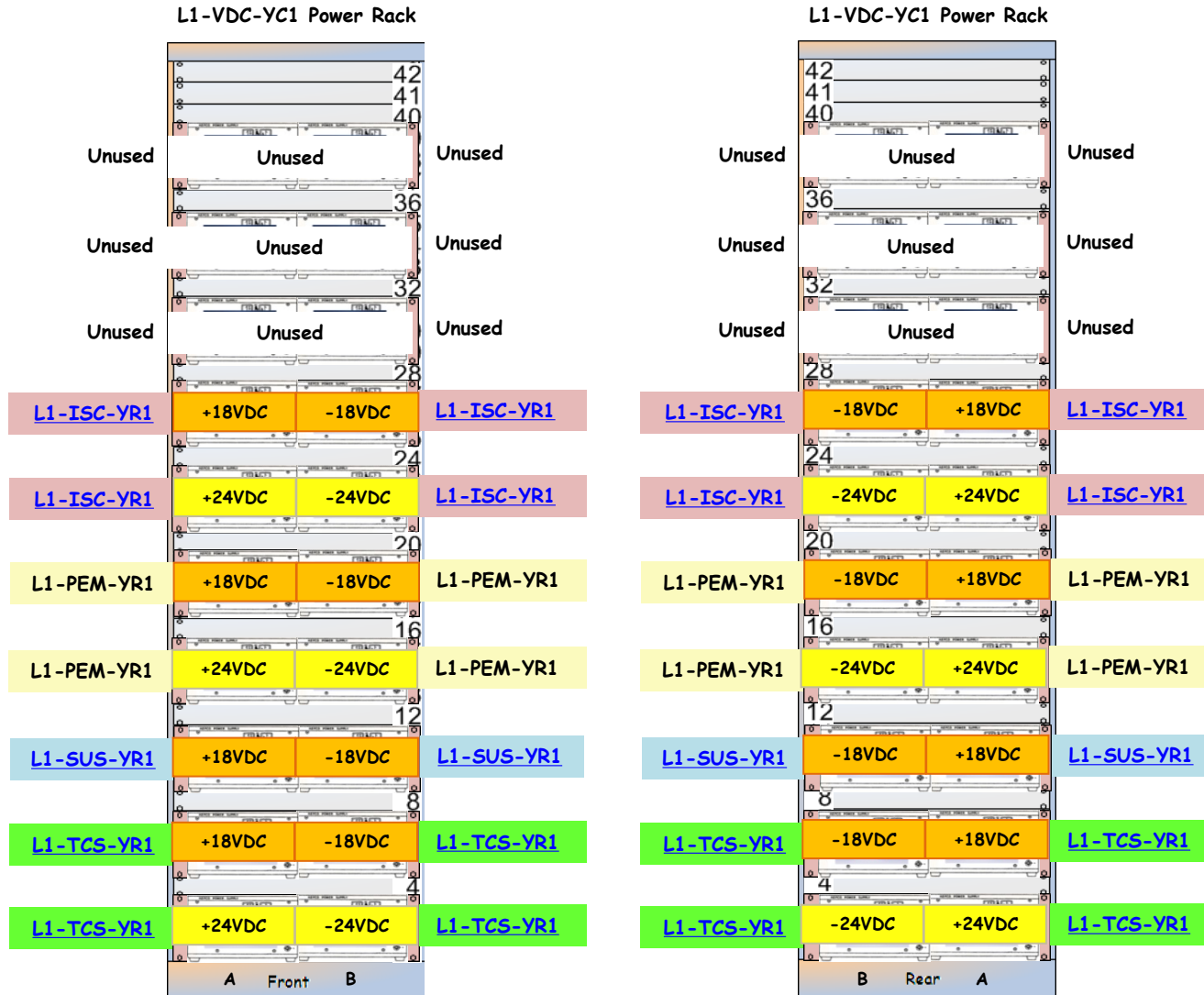

[Cable Runs >>](#)

L1-VDC-YC1 Cable Runs

<< [L1-VDC-YC1](#)

L1-VDC-YC1 Y-End Station DC Cable Runs ([D1200899](#)) ([S1202313](#))

L1-VDC-YC1 S1202313	Power Panel	Circuit	DC Power Rack	Outlet	Plug Position	Rack U	Power Supply Model	Power Supply Serial	Polarity	DC Extension Cable	Electronics Rack	DC Power Strip
1	CDS-Y		L1-VDC-YC1	8	Top	U37-A (Left)						
2	CDS-Y		L1-VDC-YC1	8	Bottom	U37-B (Right)						
3	CDS-Y		L1-VDC-YC1	2	Top	U33-A (Left)						
4	CDS-Y		L1-VDC-YC1	2	Bottom	U33-B (Right)						
5	CDS-Y		L1-VDC-YC1	9	Top	U29-A (Left)	BHK 500V 80mA	A107268	Plus	PBX-004		
6	CDS-Y		L1-VDC-YC1	9	Bottom	U29-B (Right)	BHK 500V 80mA	A107263	Minus	PBX-004		
7	CDS-Y		L1-VDC-YC1	3	Top	U25-A (Left)	JQE 25V 20A		Plus	PTO-046	L1-ISC-YR1	PSO-046
8	CDS-Y		L1-VDC-YC1	3	Bottom	U25-B (Right)	JQE 25V 20A		Minus	PTO-046	L1-ISC-YR1	PSO-046
9	CDS-Y		L1-VDC-YC1	10	Top	U21-A (Left)	JQE 25V 20A		Plus	PTY-037	L1-ISC-YR1	PSY-037
10	CDS-Y		L1-VDC-YC1	10	Bottom	U21-B (Right)	JQE 25V 20A		Minus	PTY-037	L1-ISC-YR1	PSY-037
11	CDS-Y		L1-VDC-YC1	4	Top	U17-A (Left)	JQE 25V 20A		Plus	PTO-047	L1-OAF-YR1	PSO-047
12	CDS-Y		L1-VDC-YC1	4	Bottom	U17-B (Right)	JQE 25V 20A		Minus	PTO-047	L1-OAF-YR1	PSO-047
13	CDS-Y		L1-VDC-YC1	11	Top	U13-A (Left)	JQE 25V 20A		Plus	PTY-038	L1-OAF-YR1	PSY-038
14	CDS-Y		L1-VDC-YC1	11	Bottom	U13-B (Right)	JQE 25V 20A		Minus	PTY-038	L1-OAF-YR1	PSY-038
15	CDS-Y		L1-VDC-YC1	5	Top	U09-A (Left)	JQE 25V 20A		Plus	PTO-048	L1-SUS-YR1	PSO-048
16	CDS-Y		L1-VDC-YC1	5	Bottom	U09-B (Right)	JQE 25V 20A		Minus	PTO-048	L1-SUS-YR1	PSO-048
17	CDS-Y		L1-VDC-YC1	12	Top	U05-A (Left)	JQE 25V 20A		Plus	PTO-049	L1-TCS-YR1	PSO-049
18	CDS-Y		L1-VDC-YC1	12	Bottom	U05-B (Right)	JQE 25V 20A		Minus	PTO-049	L1-TCS-YR1	PSO-049
19	CDS-Y		L1-VDC-YC1	6	Top	U01-A (Left)	JQE 25V 20A		Plus	PTY-039	L1-TCS-YR1	PSY-039
20	CDS-Y		L1-VDC-YC1	6	Bottom	U01-B (Right)	JQE 25V 20A		Minus	PTY-039	L1-TCS-YR1	PSY-039
D1200899												

L1-VDC-YC2 Power Racks - VEAY Supplies

<< CERY Racks

L1-VDC-YC2 Y-End Station DC Power Rack Layout ([D1200900](#)) ([S1202314](#))

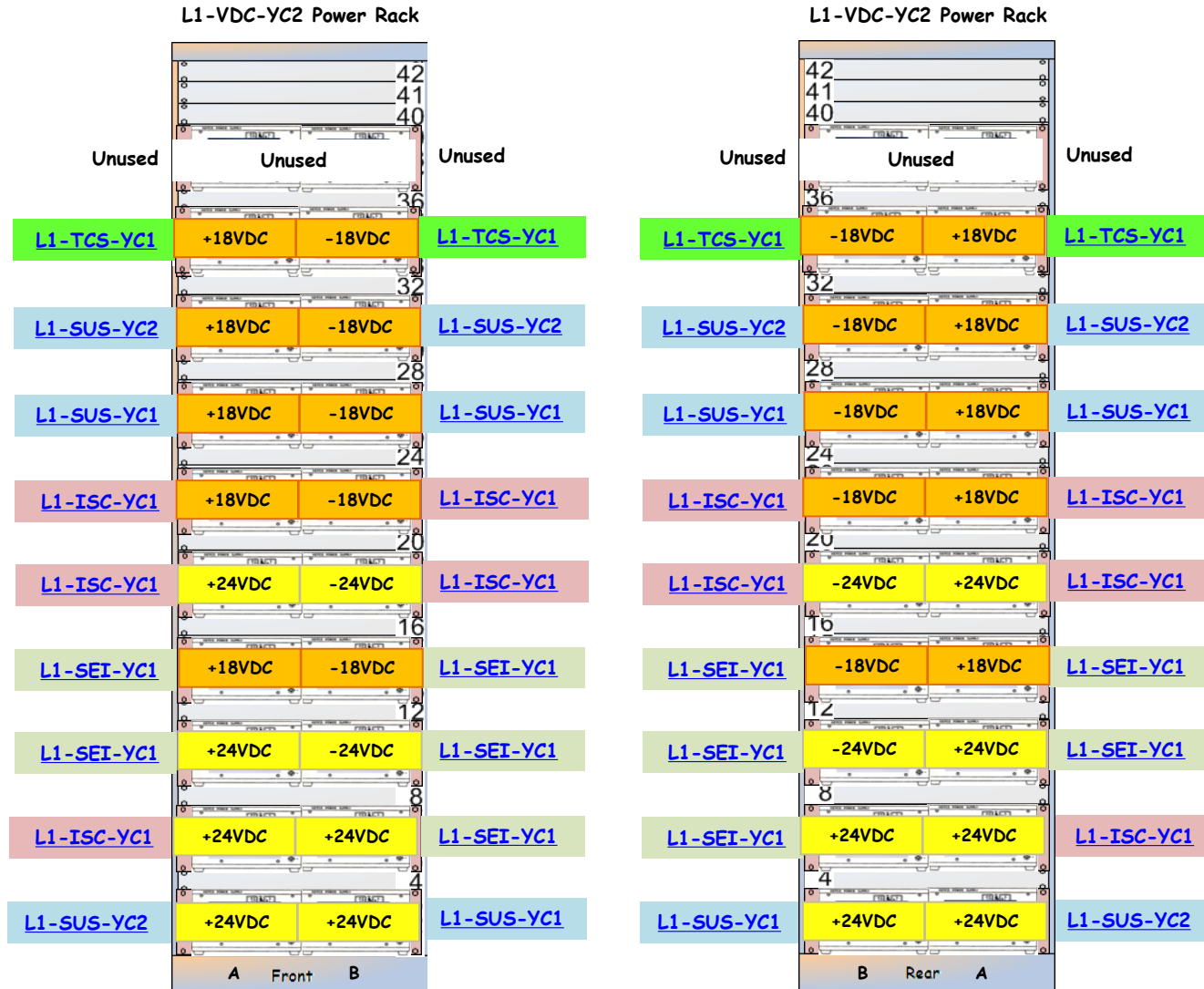

[Cable Runs >>](#)

L1-VDC-YC2 Cable Runs

<< [L1-VDC-YC2](#)

L1-VDC-YC2 Y-End Station DC Cable Runs ([D1200900](#)) ([S1202314](#))

	L1-VDC-YC2 S1202314	Power Panel	Circuit	DC Power Rack	Outlet	Plug Position	Rack U	Power Supply Model	Power Supply Serial	Polarity	DC Extension Cable	Electronics Rack	DC Power Strip
1		CDS-Y		L1-VDC-YC2		Top	U37-A (Left)						
2		CDS-Y		L1-VDC-YC2	8	Bottom	U37-B (Right)						
3		CDS-Y		L1-VDC-YC2	2	Top	U33-A (Left)	JQE 15V 6A	H214466 H214326	Plus Minus	PT6-004	L1-ISC-YC1	
4		CDS-Y		L1-VDC-YC2	8	Bottom	U33-B (Right)	JQE 25V 10A		Plus	PTO-052	L1-ISC-YC1	
5		CDS-Y		L1-VDC-YC2	9	Top	U29-A (Left)	JQE 25V 20A	H236414	Plus	PTO-050	L1-SUS-YC2	PSO-050
6		CDS-Y		L1-VDC-YC2	9	Bottom	U29-B (Right)	JQE 25V 20A	H236422	Minus	PTO-050	L1-SUS-YC2	PSO-050
7		CDS-Y		L1-VDC-YC2	3	Top	U25-A (Left)	JQE 25V 20A	H236504	Plus	PTO-051	L1-SUS-YC1	PSO-051
8		CDS-Y		L1-VDC-YC2	3	Bottom	U25-B (Right)	JQE 25V 20A	H236513	Minus	PTO-051	L1-SUS-YC1	PSO-051
9		CDS-Y		L1-VDC-YC2	10	Top	U21-A (Left)	JQE 25V 20A	H236508	Plus	PTO-052	L1-ISC-YC1	PSO-052
10		CDS-Y		L1-VDC-YC2	10	Bottom	U21-B (Right)	JQE 25V 20A	H236516	Minus	PTO-052	L1-ISC-YC1	PSO-052
11		CDS-Y		L1-VDC-YC2	4	Top	U17-A (Left)	JQE 25V 20A	H236503	Plus	PTY-040	L1-ISC-YC1	PSY-040
12		CDS-Y		L1-VDC-YC2	4	Bottom	U17-B (Right)	JQE 25V 20A	H236488	Minus	PTY-040	L1-ISC-YC1	PSY-040
13		CDS-Y		L1-VDC-YC2	11	Top	U13-A (Left)	JQE 25V 20A	H236500	Plus	PTO-053	L1-SEI-YC1	PSO-053
14		CDS-Y		L1-VDC-YC2	11	Bottom	U13-B (Right)	JQE 25V 20A	H236520	Minus	PTO-053	L1-SEI-YC1	PSO-053
15		CDS-Y		L1-VDC-YC2	5	Top	U09-A (Left)	JQE 25V 20A	H236519	Plus	PTY-041	L1-SEI-YC1	PSY-041
16		CDS-Y		L1-VDC-YC2	5	Bottom	U09-B (Right)	JQE 25V 20A	H236487	Minus	PTY-041	L1-SEI-YC1	PSY-041
17		CDS-Y		L1-VDC-YC2	12	Top	U05-A (Left)	JQE 25V 20A	H236502	Plus	PTY-042	L1-ISC-YC1	PSY-042
18		CDS-Y		L1-VDC-YC2	12	Bottom	U05-B (Right)	JQE 25V 20A	H236518	Plus	PTY-043	L1-SEI-YC1	PSY-043
19		CDS-Y		L1-VDC-YC2	6	Top	U01-A (Left)	JQE 25V 20A	H236521	Plus	PTY-044	L1-SUS-YC2	PSY-044
20		CDS-Y		L1-VDC-YC2	6	Bottom	U01-B (Right)	JQE 25V 20A	H236507	Plus	PTY-045	L1-SUS-YC1	PSY-045
	D1200900												

L1-DAQ-YC1

<< CERY Racks

L1-DAQ-YC1 Y-End Station Remote Rack Layout (D1201092) (S1202956)

Serial to Internet Converter

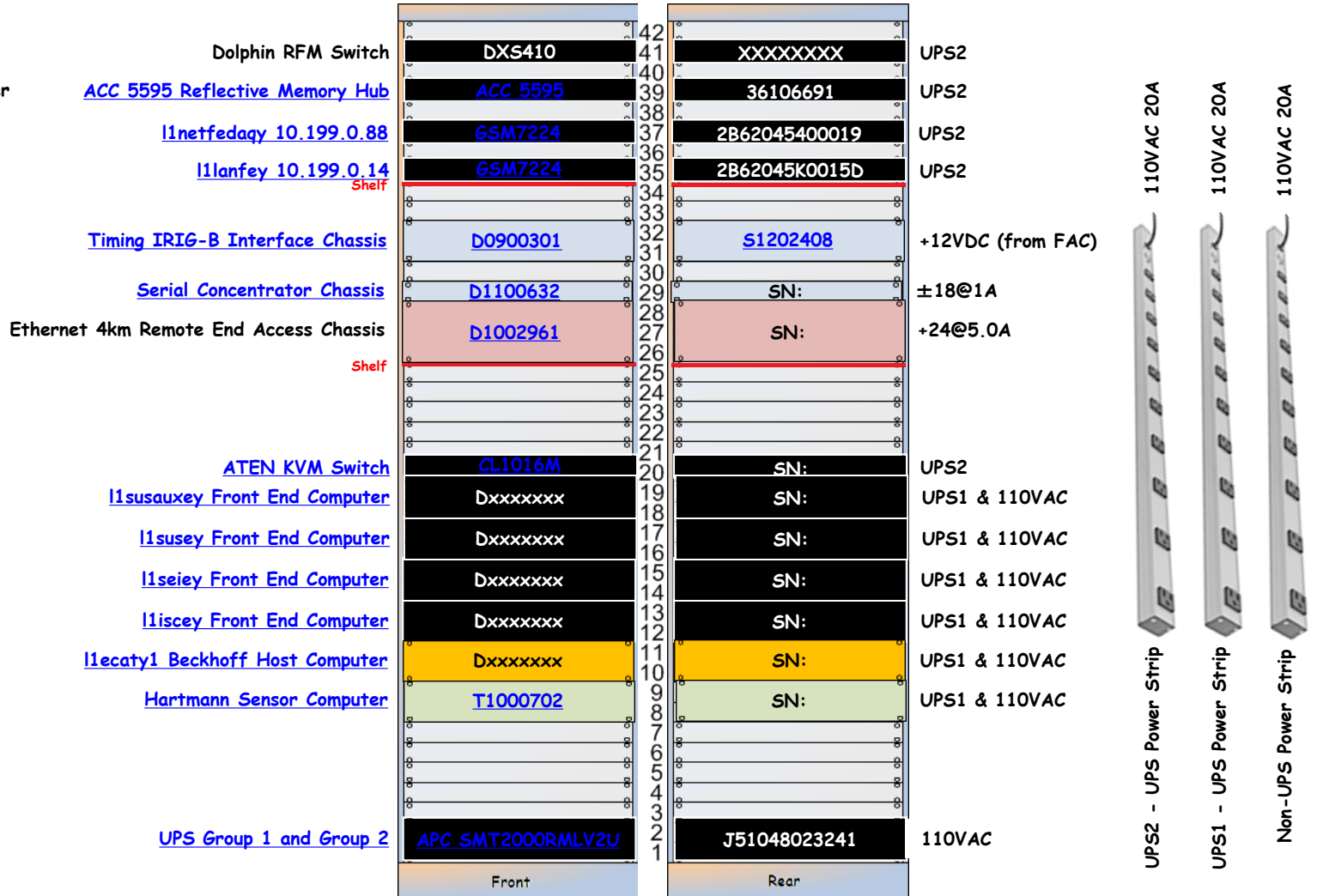

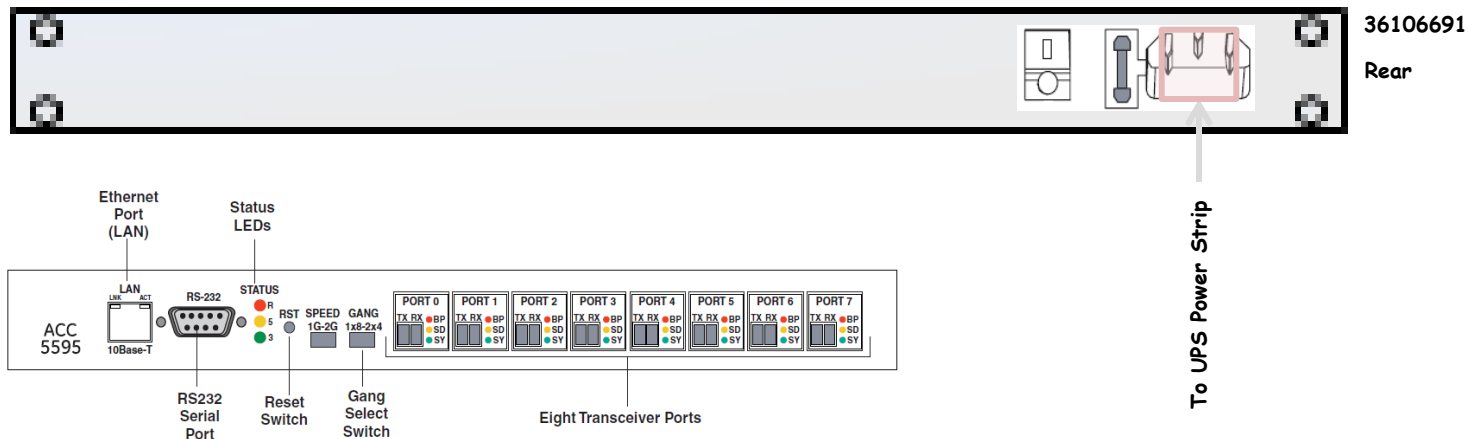
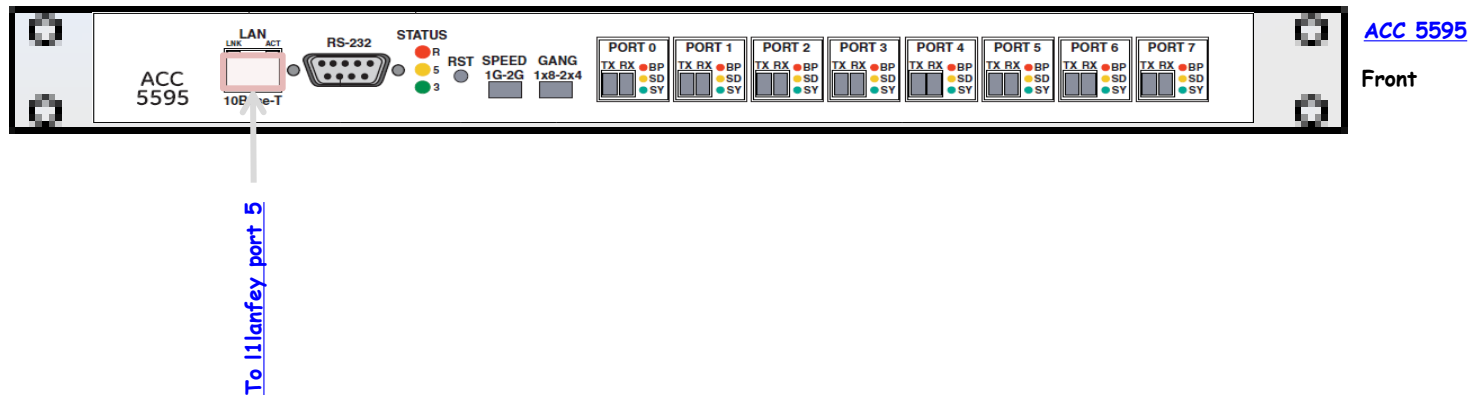

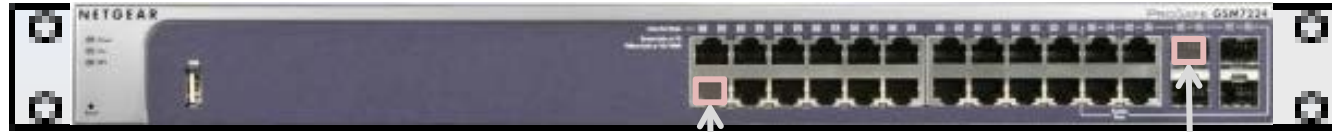

GSM7224

Front
C0:3F:0E:86:84:04

2 - To FE NET Port

21F - To 1Y23 PP E1, E2



2B62045400019

Rear

To UPS Power Strip

I1lanfey - GSM7224

I1lanfey 10.199.0.14

GSM7224

2B62045K0015D

110VAC



GSM7224

Front

CO:3F:0E:86:89:14



2 - To FE LAN Port

5 - To 5595 LAN 10BaseT

21F - To 1Y23 PP A1, A2



2B62045K0015D

Rear

To UPS Power Strip

Timing IRIG-B Interface Chassis

D0900301

S1202408

Power

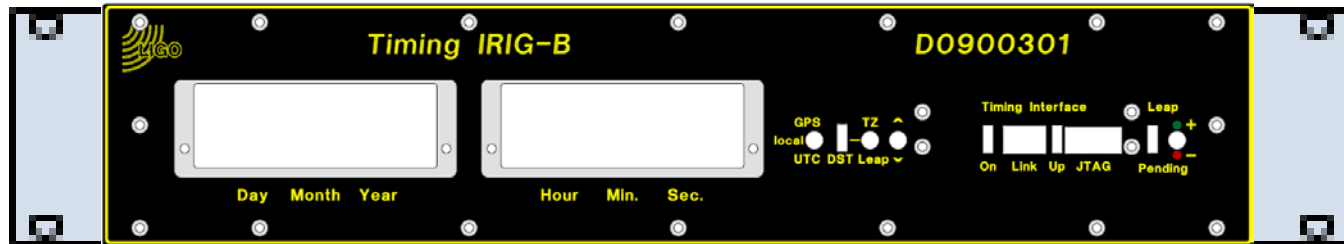

D0900301

Front

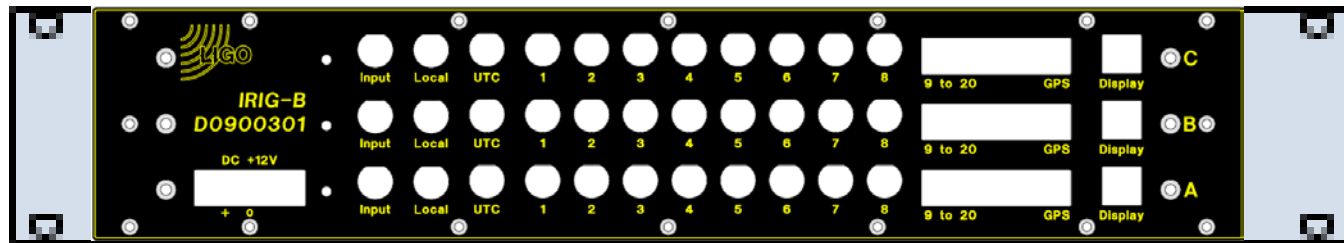

S1202408

Rear

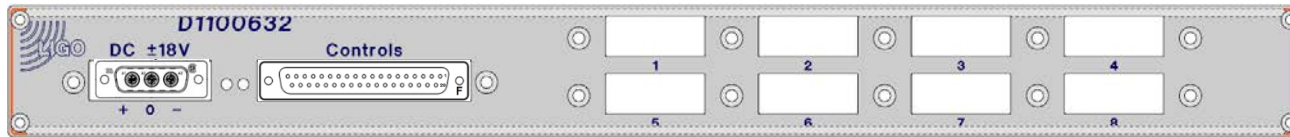
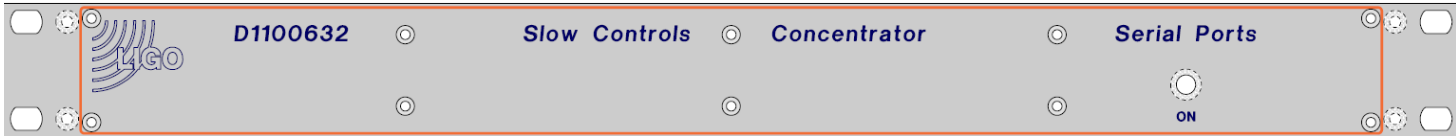

D1100632

Front

Sxxxxxxx

Rear

<< L1-DAQ-YC1

ATEN KVM Switch

CL1016M

SN:

110VAC



To UPS Power Strip

To I1 pemey Front End

Rear
SN:

l1susauxey Front End

l1susey Front End

l1susey Front End Computer

Front End

SN:

110VAC



l1seiey Front End

[<< L1-DAQ-YC1](#)

l1seiey Front End Computer

Front End

SN:

110VAC

l1iscey Front End

l1iscey Front End Computer

Front End

SN:

110VAC



Hartmann Sensor Computer Front End

[<< L1-DAQ-YC1](#)

Hartmann Sensor Front End Computer

Front End

SN:

110VAC

APC SMX2000RMLV2U

UPS

[APC SMX2000RMLV2U](#)

J51048023241

110VAC



[APC SMX2000RMLV2U](#)

Front

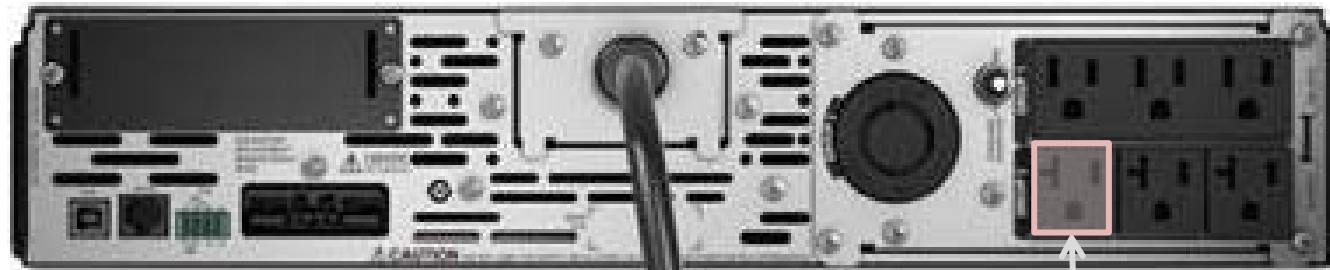

J51048023241

Rear

[To UPS Power Strip](#)

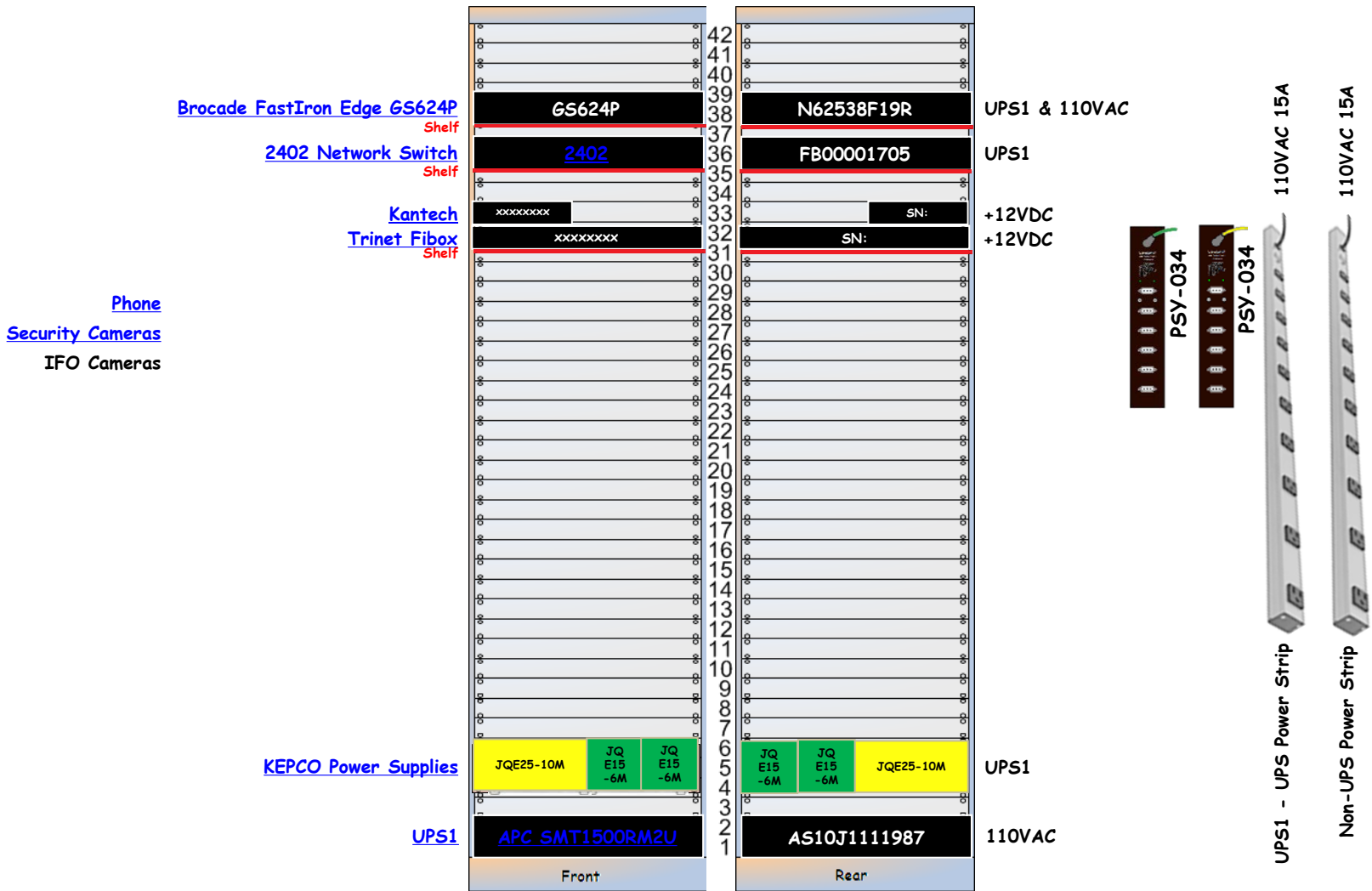

Brocade FastIron Edge GS624P

<< L1-FAC-YC1

Brocade FastIron Edge GS624P

GS624P

N62538F1A3

UPS & 110VAC



GSM7224

Front

CO:3F:0E:86:88:E0

21F - To 1Y23 PP B1.B2

3 - To FE NET Port

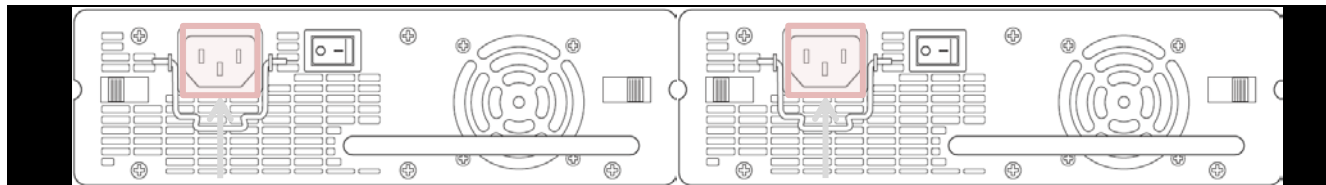

N62538F1A3

Rear

To 110 Power Strip

To UPS Power Strip

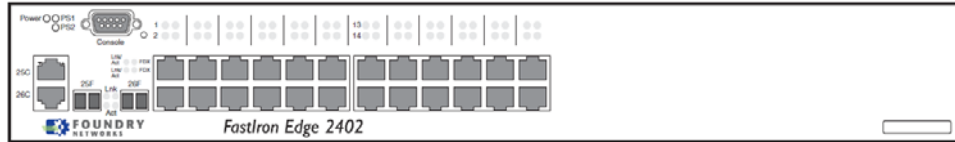

- Empty ↔ 01
- Empty ↔ 02
- Empty ↔ 03
- Empty ↔ 04
- Empty ↔ 05
- Empty ↔ 06
- To Camera on Reel ↔ 07
- Empty ↔ 08
- To Trinet/Trinet ↔ 09
- Empty ↔ 10
- To Trinet/Trinet ↔ 11
- Empty ↔ 12
- Empty ↔ 13
- To Seimens ↔ 14
- Empty ↔ 15
- Empty ↔ 16
- Empty ↔ 17
- Empty ↔ 18
- Empty ↔ 19
- Empty ↔ 20
- To Weather Station ??? ↔ 21
- Empty ↔ 22
- Empty ↔ 23
- Empty ↔ 24

- Empty ↔ 25C
- Empty ↔ 26C
- To Special Cable CSR1 ↔ 25F
- To 1Y23 PP D3, E3 ↔ 26F

G12039
192.168.253.30

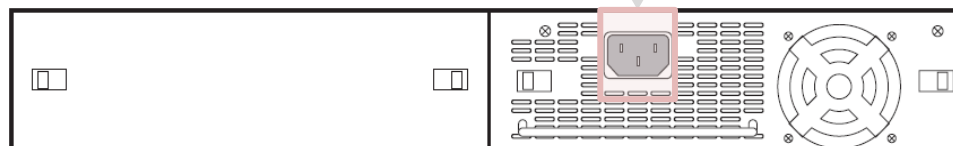

PS1

Y-End - Kantech Interface

Kantech

Fiber Options
[7711-R \(501R\)](#)
Optical In/Out:
[To 1Y23 PP D2](#)
Power: 13.5VDC
from Wall Wart

Blue CAT5:
1=O/W and
B/W, 4=O, 7=B

Powered from
Wall Wart from
Isolated Power

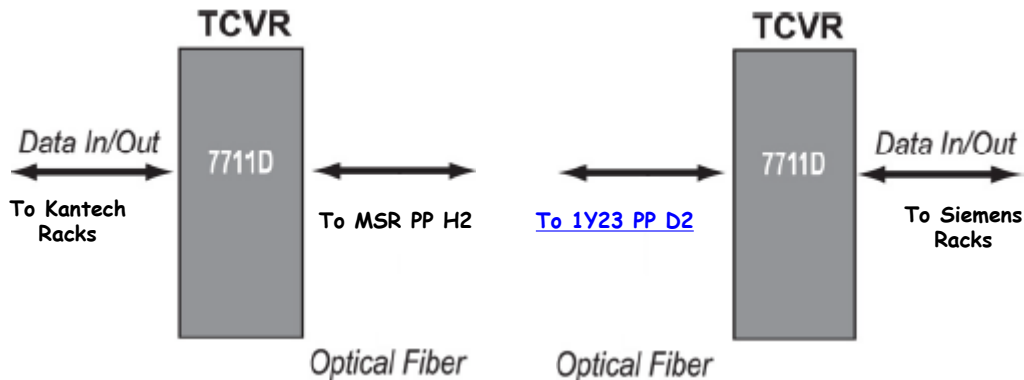

Trinet FIBOX Panel

Trinet FIBOX Panel

Trinet **FIBOX** Panel

Trinet Panel

12VDC

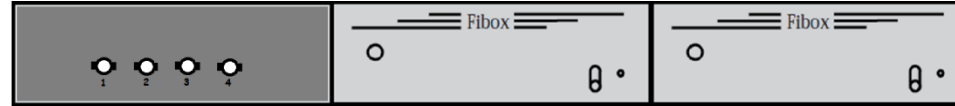

- Empty \longleftrightarrow 1
- Trinet Z \longleftrightarrow 2
- Trinet Y \longleftrightarrow 3
- Trinet X \longleftrightarrow 4

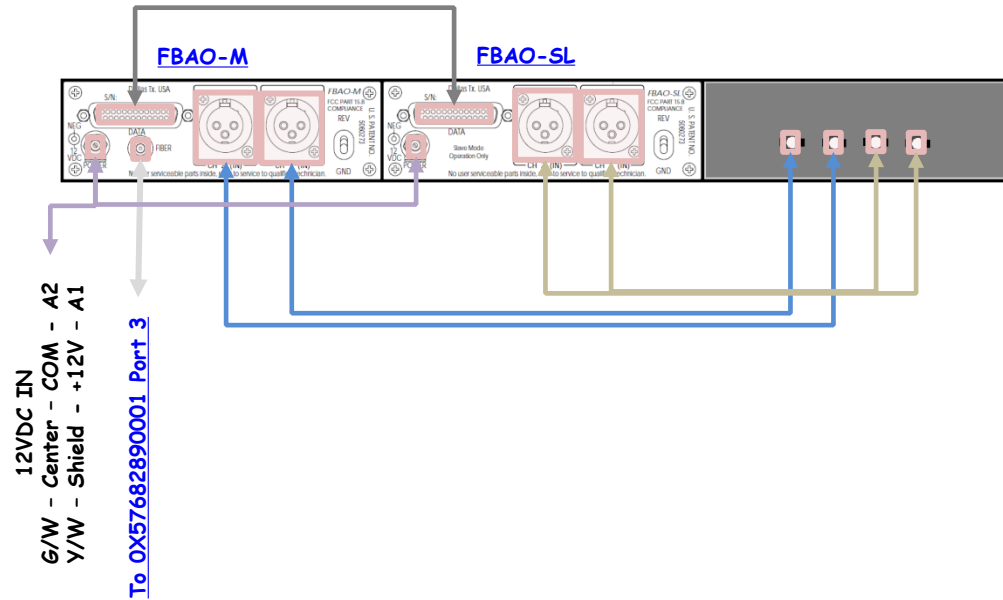

<< L1-FAC-YC1

Magnetometer: [Bartington Instruments](#)
MAG-03MC

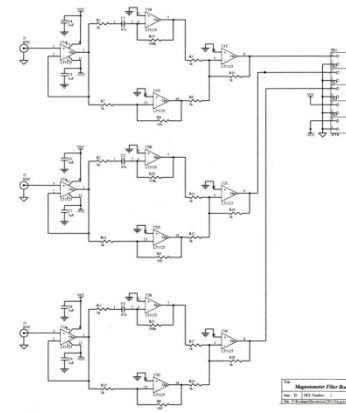
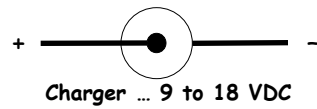
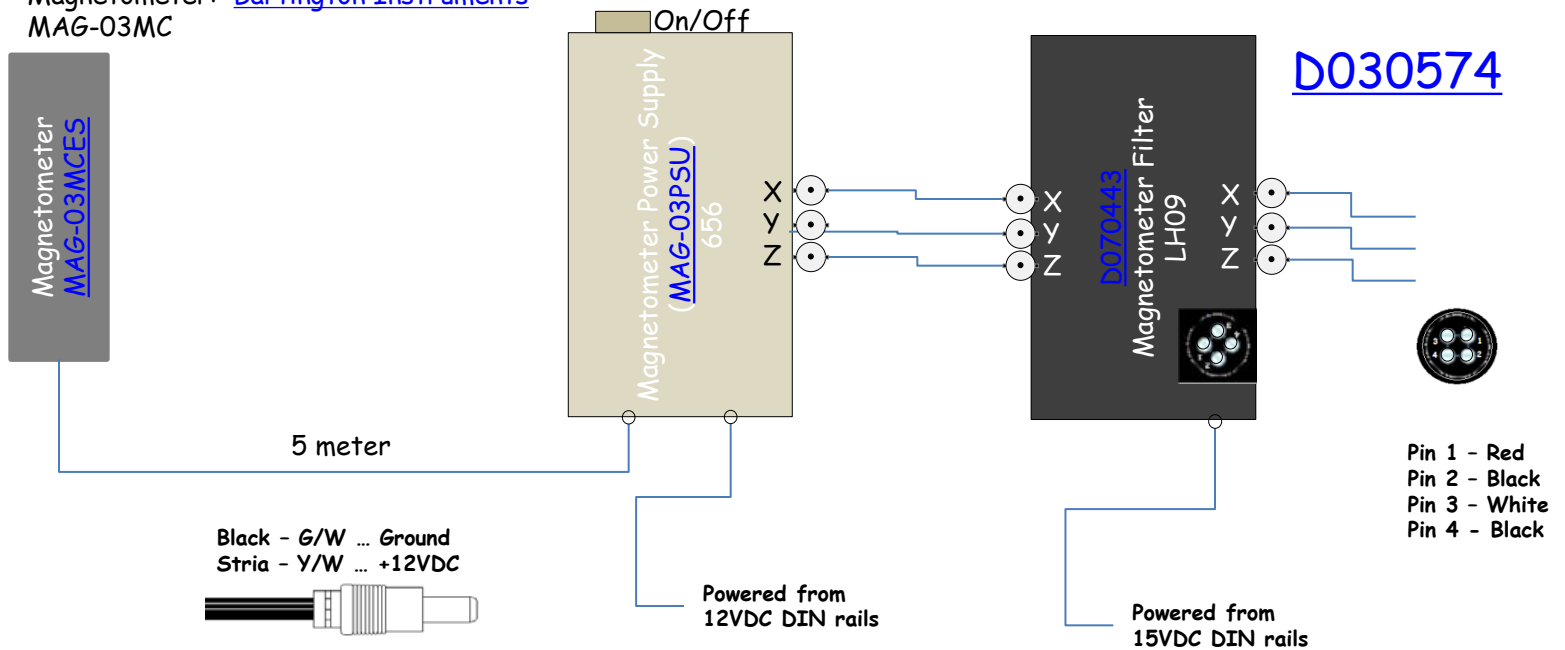

Magnetometer Filter Board

<< [L1-FAC-YC1](#)

IFO Cameras

[VT5030 IFS](#)
International
Fiber Systems,
Inc.
IFS.com
Optical Out:
[To 1Y23 PP B6](#)
Power: 12VDC
Video Input:
Camera 1
Camera 2

Powered from
DIN rails

Security Cameras

[VT7430-2DRDT](#)
Optical In/Out:
[To 1Y23 PP D1](#)
Power: 12VDC
Output: Ch1,
Ch2, Ch3 BNCs
to Cameras

Powered from
Wall Wart from
Isolated Power

Revere Video
Master Power
Supply Model
[RT24/16500](#)
Outputs to
Cameras 1,2,3

*LEDs on with
bad fuse
Note: 8 LEDs
are on.

AC Powered
from Isolated
Power

Kantech

Fiber Options
[7711-R \(501R\)](#)
Optical In/Out:
[To 1Y23 PP D2](#)
Power: 13.5VDC
from Wall Wart

Blue CAT5:
1=O/W and
B/W, 4=O, 7=B

Powered from
Wall Wart from
Isolated Power

Seismic Vault

J/E-CF-01
TriNet
Converter
CAT5:
[To 2402 P9](#)
TX:
[To 0X57... P1](#)
RX:
[To 0X57... P2](#)
Power: 12VDC

Powered from
DIN rails

J/E-CF-01
TriNet
Converter
CAT5:
[To 2402 P11](#)
TX:
[To 0X57... P8](#)
RX:
[To 0X57... P7](#)
Power: 12VDC

Powered from
DIN rails

Phone

[TR3030WDM](#)
GE Security
Optical In/Out:
[To 1Y23 PP B2](#)
Phone: Copper to
VEA
Power: 12VDC

Powered from Wall Wart from
Tripp-Lite UPS
Model BC320
9834DY0BC614000661 To 6-
Outlet Power Strip in Non-
isolated wall socket

Y-End - Security Cameras

Security Cameras

Reverse Video
Master Power
Supply Model
[RT24/16500](#)
Outputs to
Cameras 1,2,3

*LEDs on with
bad fuse
Note: 8 LEDs
are on.

AC Powered
from Isolated
Power



RT24/16500

AC Power120 VAC LED supervised
Non-grounded power cord
furnished
Output24 VAC, 8 amps total
Outputs16 @ 500mA individually
fused at 1/2 amp and
individually supervised
Dimensions7.5" W x 8.25" H x 3.5" D
CabinetHeavy gauge steel



VAC

Y-End - Security Cameras

Security Cameras

VT7430-2DRDT

Optical In/Out:

To 1Y23 PP D1

Power: 12VDC

Output: Ch1,
Ch2, Ch3 BNCs
to Cameras

Powered from
Wall Wart from
Isolated Power

cameras
75-ohm coaxial cables

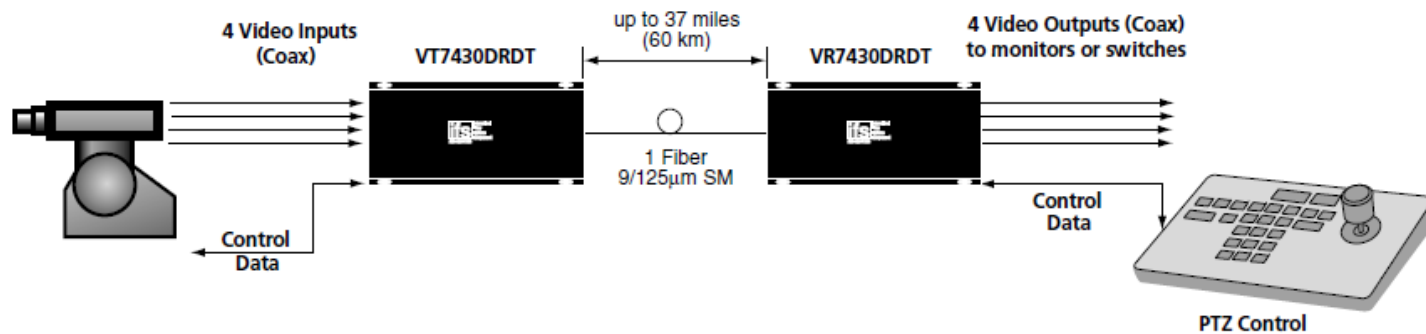

Cameras

[VT5030 IFS](#)
International
Fiber Systems,
Inc.
IFS.com
Optical Out:
[To 1Y23 PP B6](#)
Power: 12VDC
Video Input:
Camera 1
Camera 2

Powered from
DIN rails

cameras
75-ohm coaxial cables

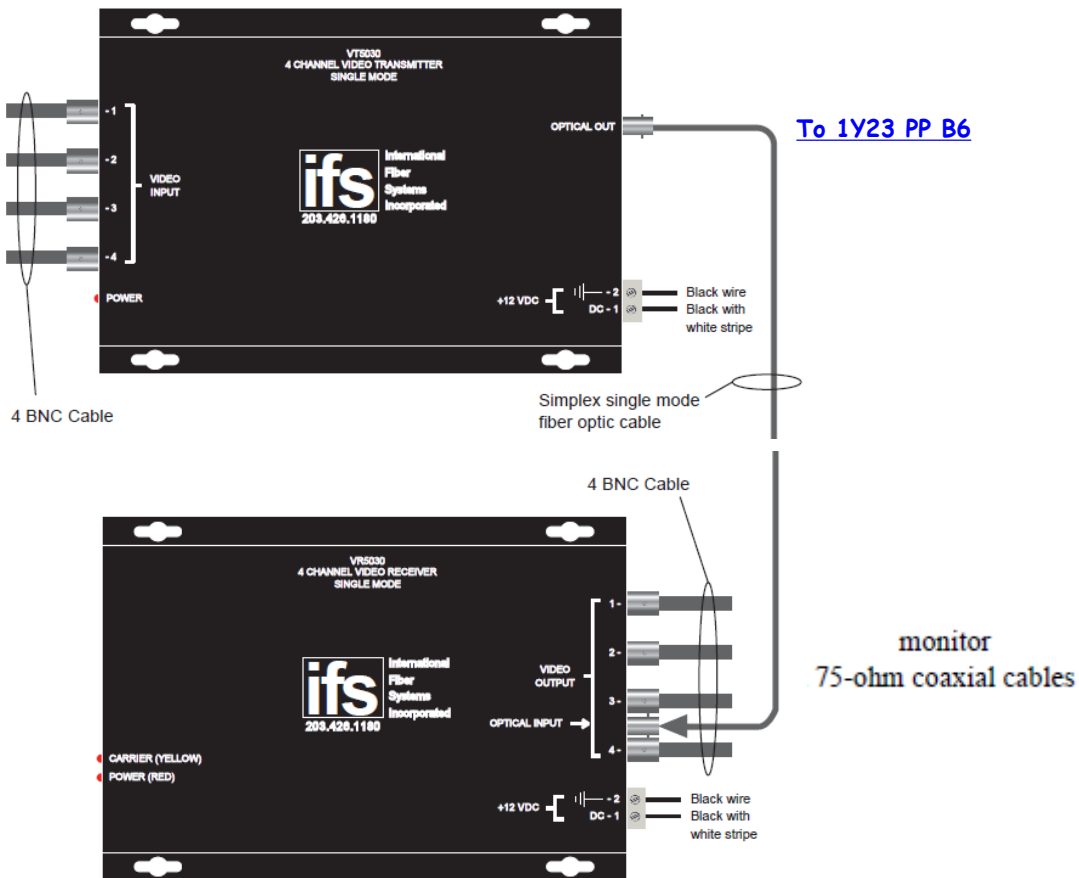

Y-End - Trinet

Seismic Vault

<p>J/E-CF-01 TriNet Converter CAT5: To 2402 P9 TX: To OX57... P1 RX: To OX57... P2 Power: 12VDC</p>	<p>J/E-CF-01 TriNet Converter CAT5: To 2402 P11 TX: To OX57... P8 RX: To OX57... P7 Power: 12VDC</p>
Powered from DIN rails	Powered from DIN rails

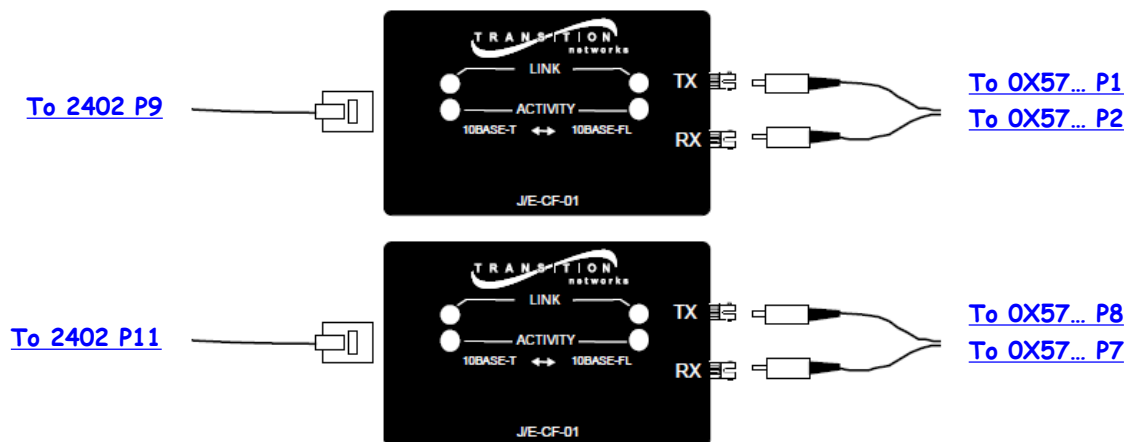

For network installation, the J/E-CF-01 media converter provides an RJ-45 twisted pair connector and a set of RX (receive) and TX (transmit) ST connectors to 850 nm multimode fiber-optic cable.

Y-End - Phone

Phone

[TR3030WDM](#)
 GE Security
 Optical In/Out:
[To 1Y23 PP B2](#)
 Phone: Copper to
 VEA
 Power: 12VDC

Powered from Wall Wart from
 Tripp-Lite UPS
 Model BC320
 9834DY0BC614000661 To 6-
 Outlet Power Strip in Non-
 isolated wall socket



System Design

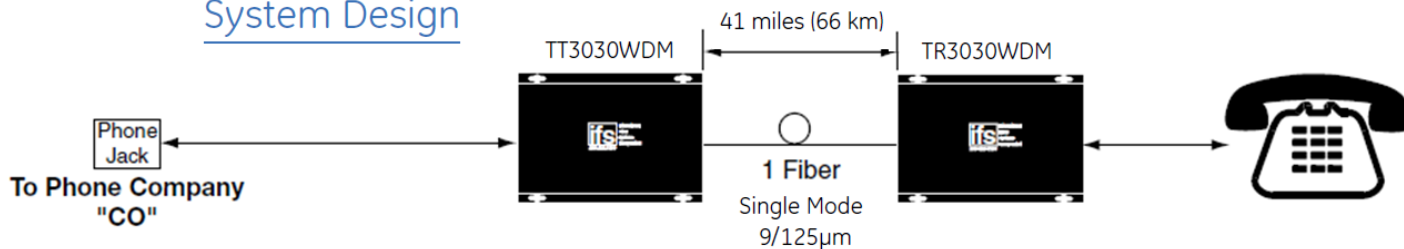

KEPCO Power Supplies

KEPCO Power Supplies



UPS1

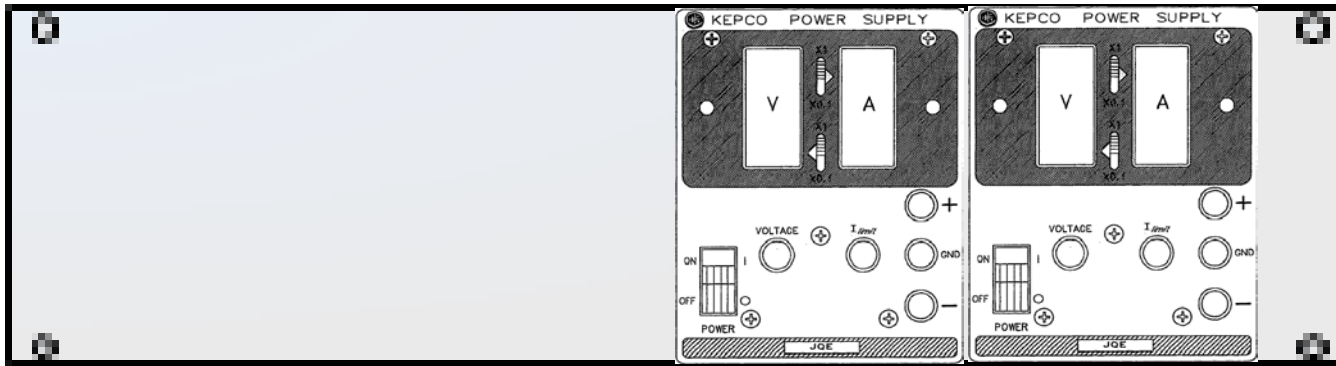

JQE
Front

KEPCO JQE 25-10M
+24VDC

KEPCO JQE 15-6M
+12VDC

KEPCO JQE 15-6M
-12VDC

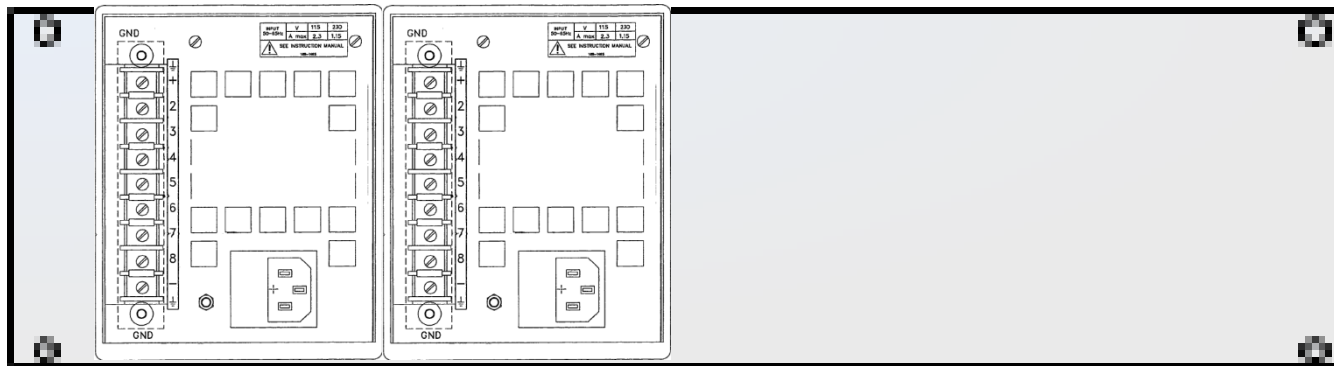

Rear
SN:

KEPCO JQE 15-6M
-12VDC

KEPCO JQE 15-6M
+12VDC

KEPCO JQE 25-10M
+24VDC

APC SMT1500RM2U

UPS

APC SMT1500RM2U

A51051111987

110VAC

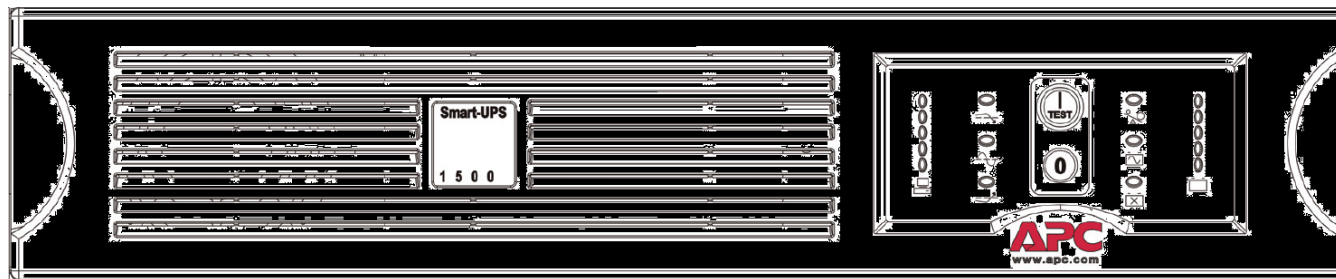

APC SMT1500RM2U

Front

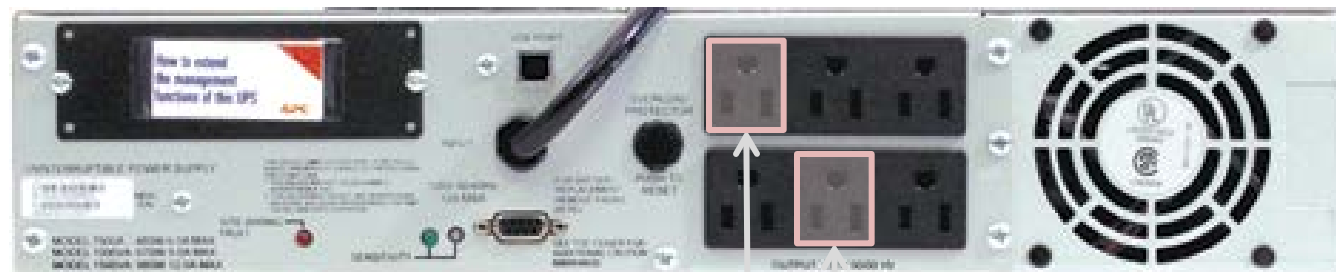

A51051111987

Rear

To 2402 PS1

To X448 PS1



RF Distribution Panel 26	Dxxxxxxx	42	SN:	No Power
RF Distribution Panel 27	Dxxxxxxx	41	SN:	No Power
71 MHz Oscillator	D080702	40	S1000562	+12VDC, ±24VDC
71 MHz Distribution Amplifier	D1000124	39	S1000653	±17VDC, ±24VDC
24.4 MHz Oscillator	D080702	38	S1000577	+12VDC, ±24VDC
24.4 MHz Distribution Amplifier	D1000124	37	S1000670	±17VDC, ±24VDC
Aeroflex Diagnostics	2023A	36	Sxxxxxxx	110VAC
RF Amplifier Concentrator 3	D1100262	35	S1103463	+/-18VDC
384 Channel Binary Output	D1100251	34	S1203282	+24VDC
ISC Common Beckhoff Chassis	D1002961	33	SN:	+24@5.0A
Shelf		32	SN:	+24@5.0A
End 2 Beckhoff Chassis	D1100682	31	SN:	±18@0.5A
Shelf		30	SN:	±18@1A
Anti-Image Chassis	D070081	29	SN:	±18@1A
Anti-Alias Chassis	D0902783	28		
Anti-Alias Chassis	D0902783	27		
I1pemey I/O Extension Chassis	D1001715	26	S1000528	+24V@5A
		25		
		24		
		23		
		22		
		21		
		20		
		19		
		18		
		17		
		16		
		15		
		14		
		13		
		12		
		11		
		10		
		9		
		8		
		7		
		6		
		5		
		4		
		3		
		2		
		1		
	Front		Rear	

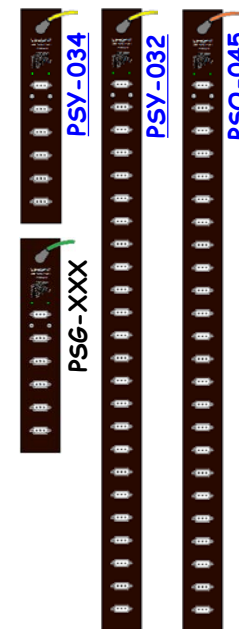

ISC-YC1 is part of [D1001459](#)

L1-ISC-YC1 is [D1201091](#)

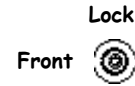
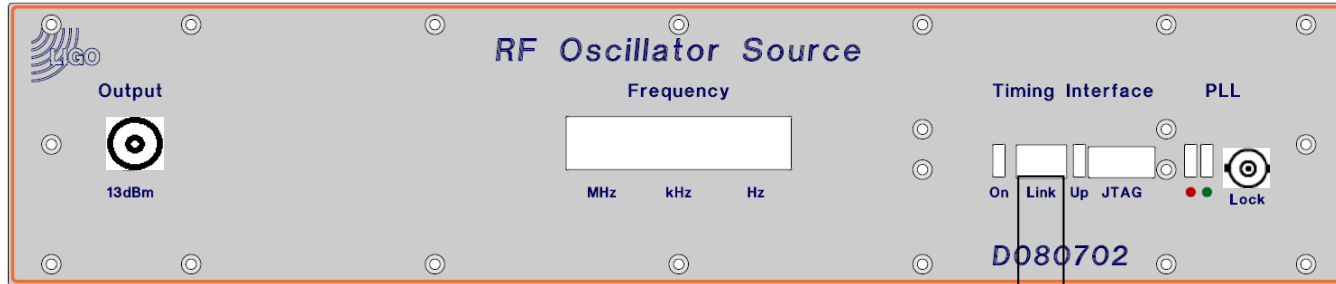

To ...

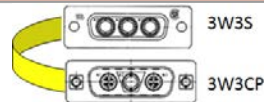
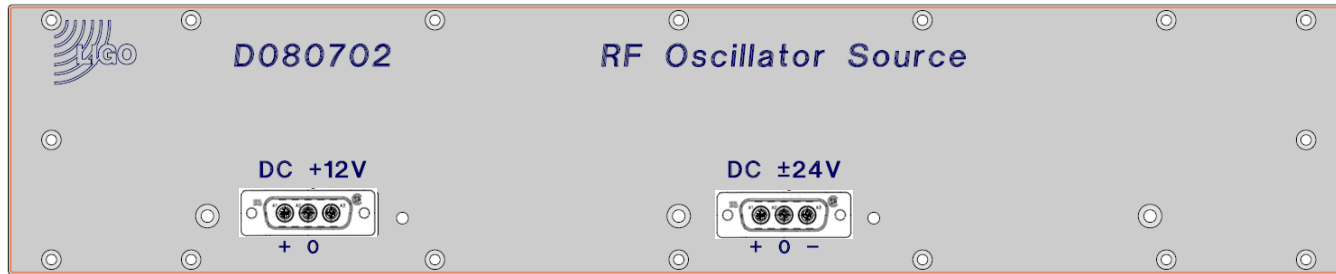

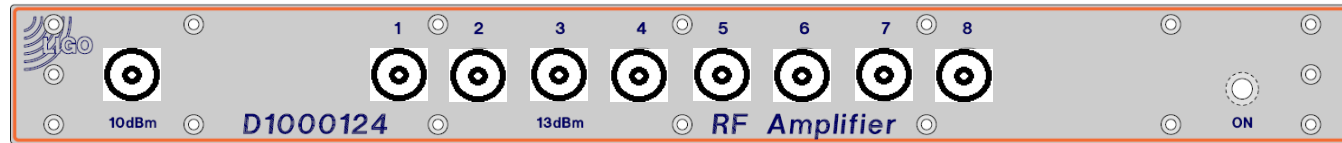

D1000124

Front

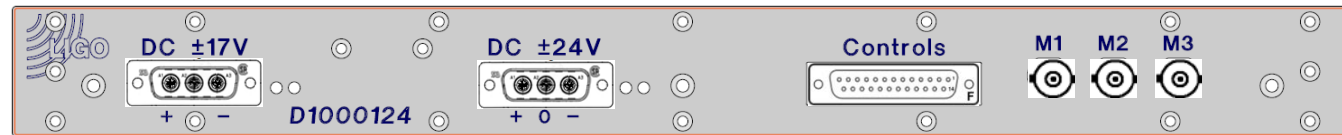
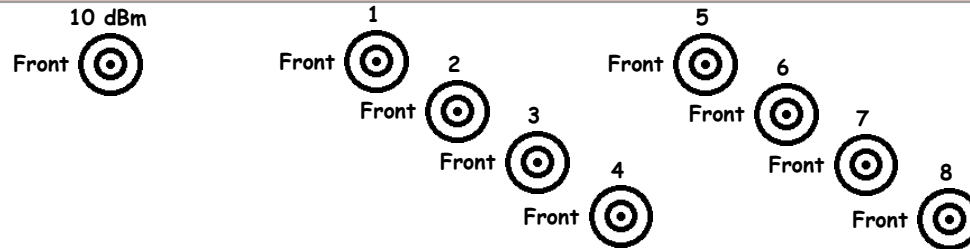

S1000653

Rear

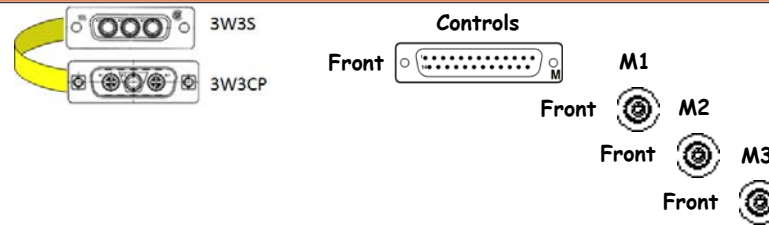

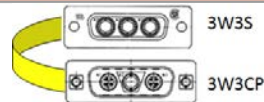
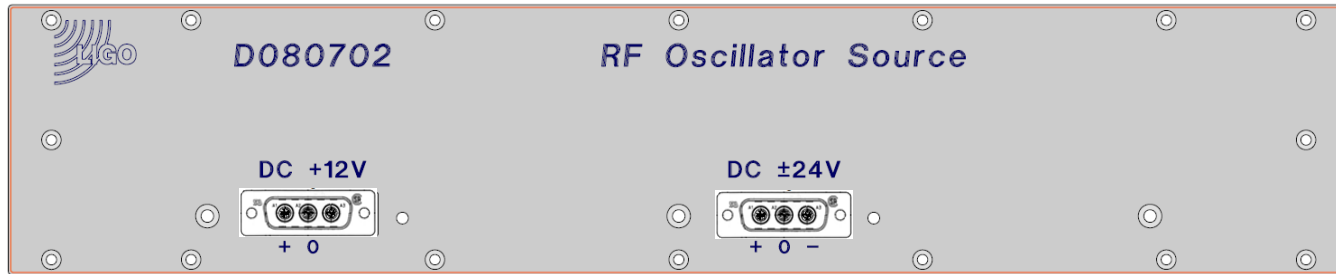
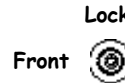
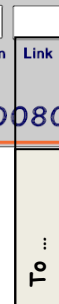
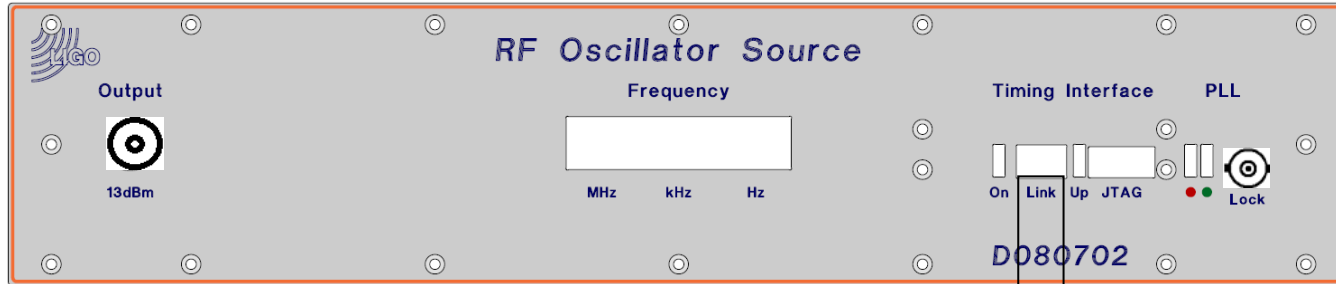

D080702

Front

S1000577

Rear

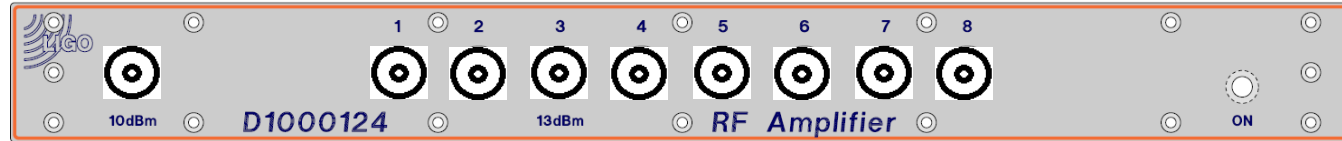

D1000124

Front

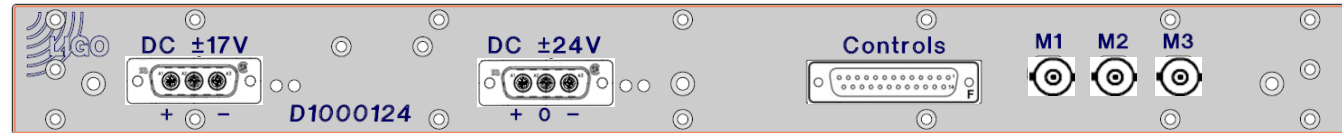
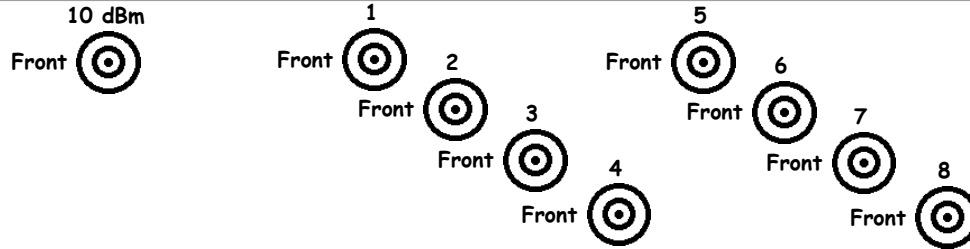

S1000670

Rear

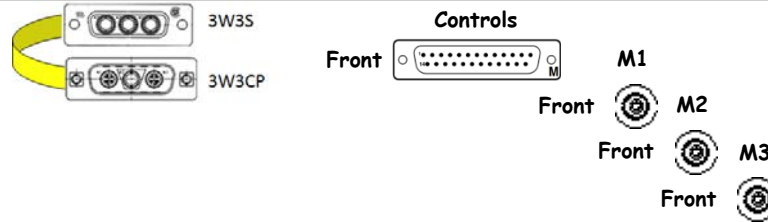



D1100262

Front

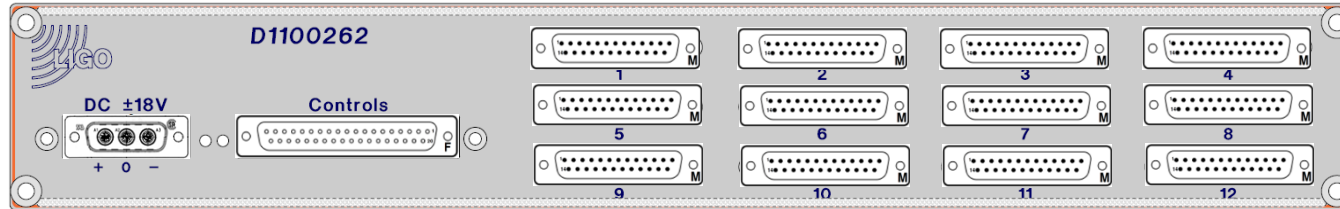

S1103463

Rear

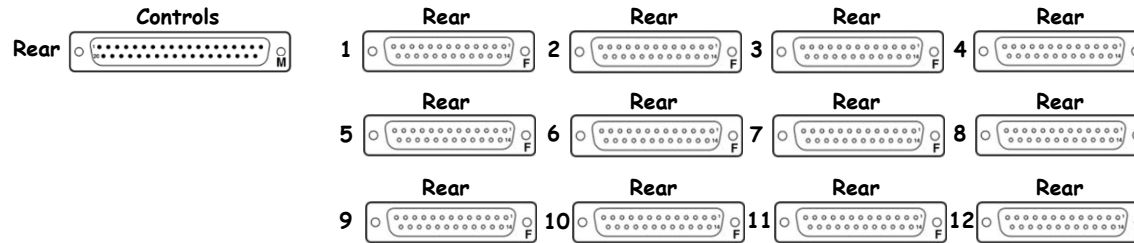

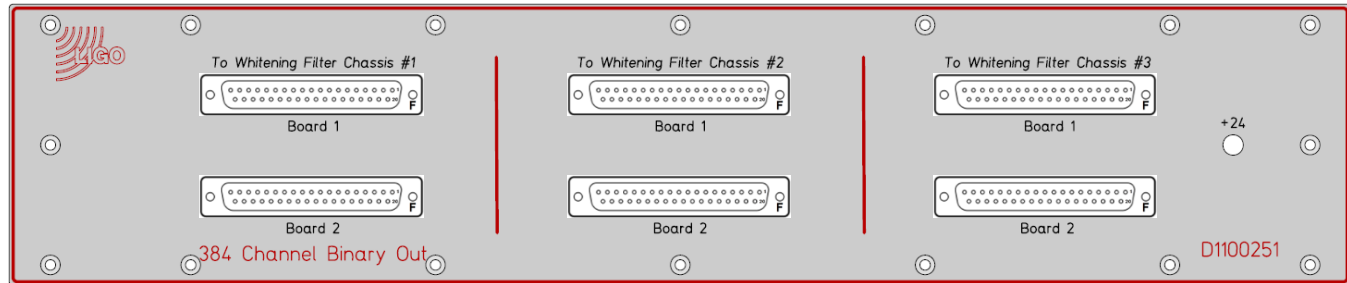

D1100251

Front

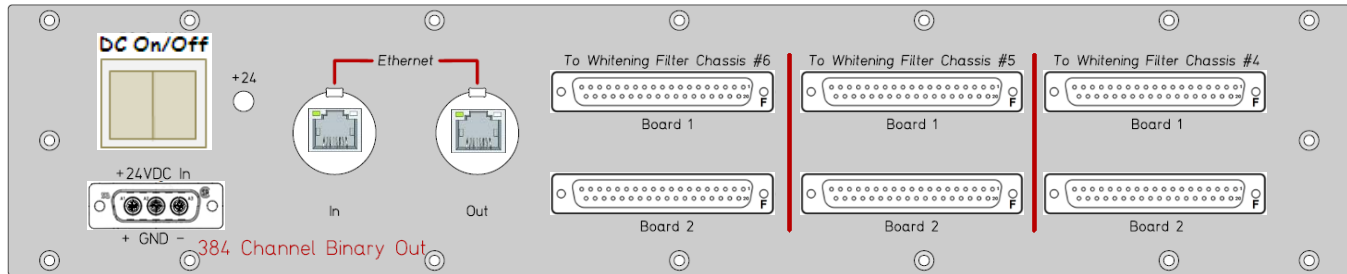
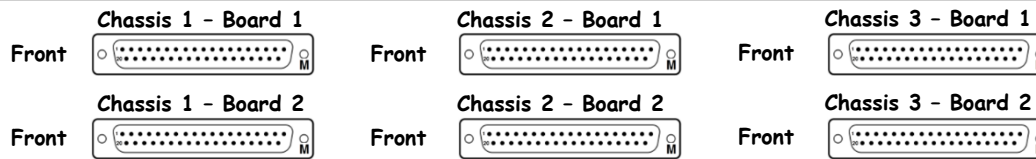

S1203282

Rear

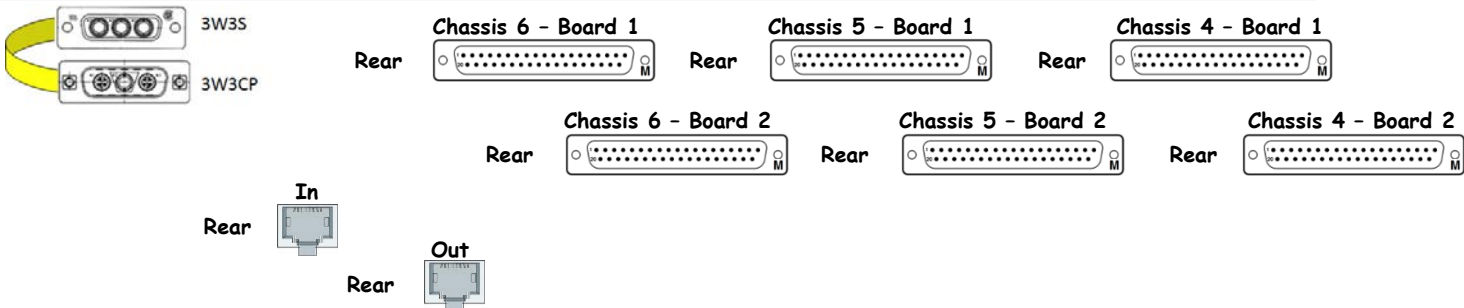

I1pemey - D1001715 - S1000528

I1pemey I/O Extension Chassis

D1001715

S1000528

110VAC



D1001715
Front

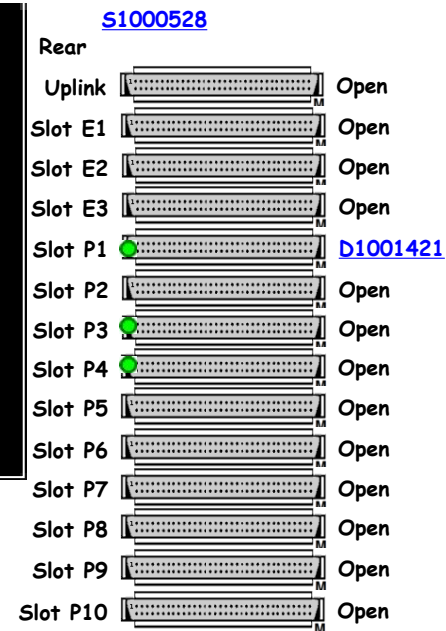
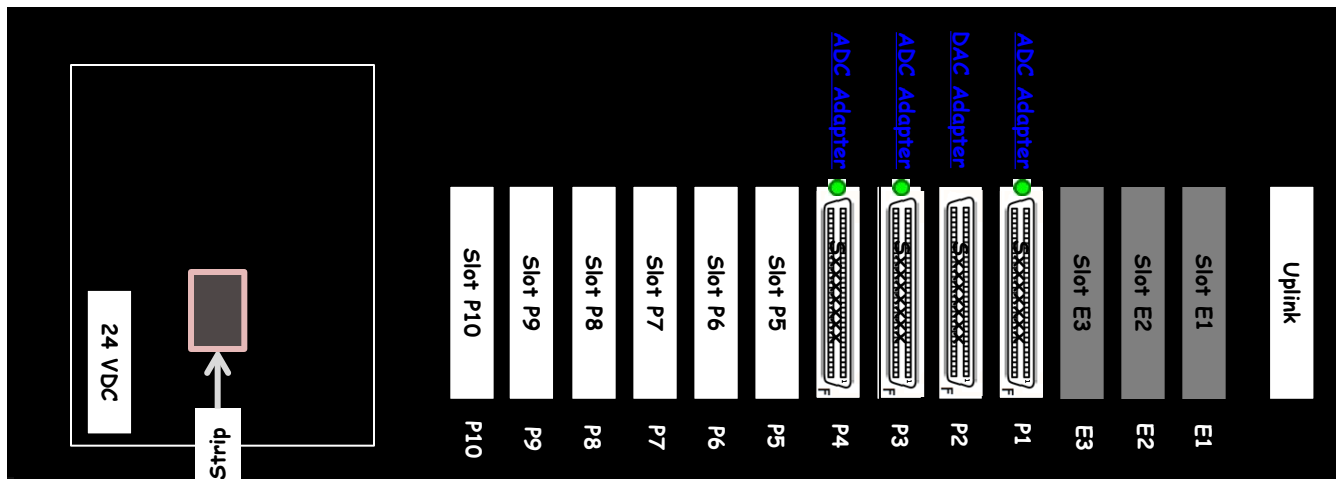

S1000528

Rear

Uplink Open
 Slot E1 Open
 Slot E2 Open
 Slot E3 Open
 Slot P1 D1001421
 Slot P2 Open
 Slot P3 Open
 Slot P4 Open
 Slot P5 Open
 Slot P6 Open
 Slot P7 Open
 Slot P8 Open
 Slot P9 Open
 Slot P10 Open

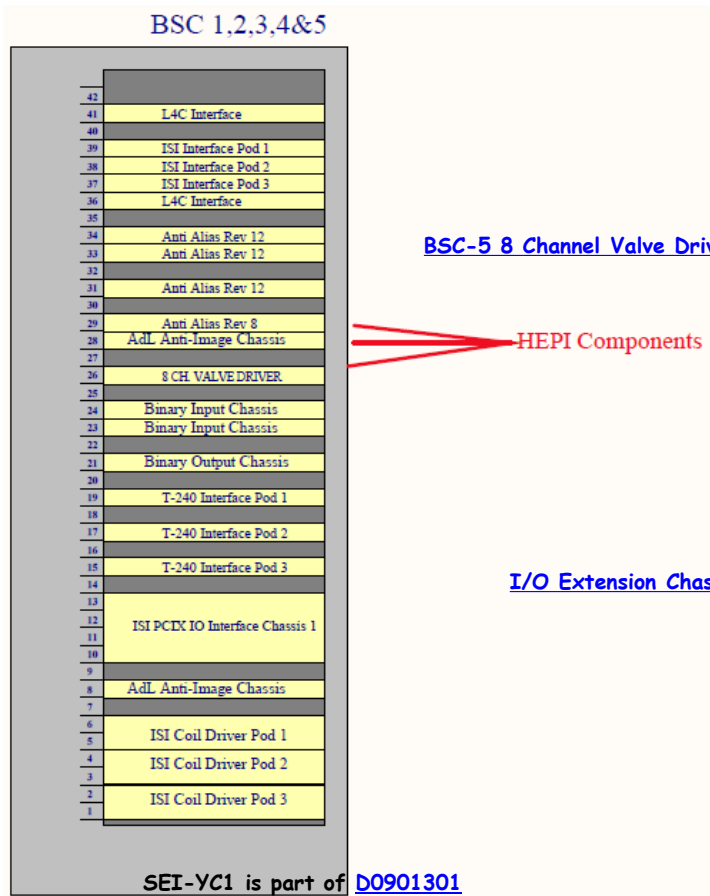

BSC-5 8 Channel Valve Driver

HEPI Components

I/O Extension Chassis

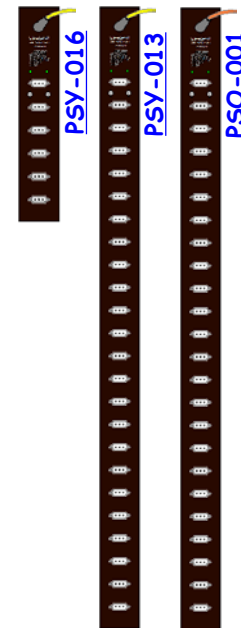
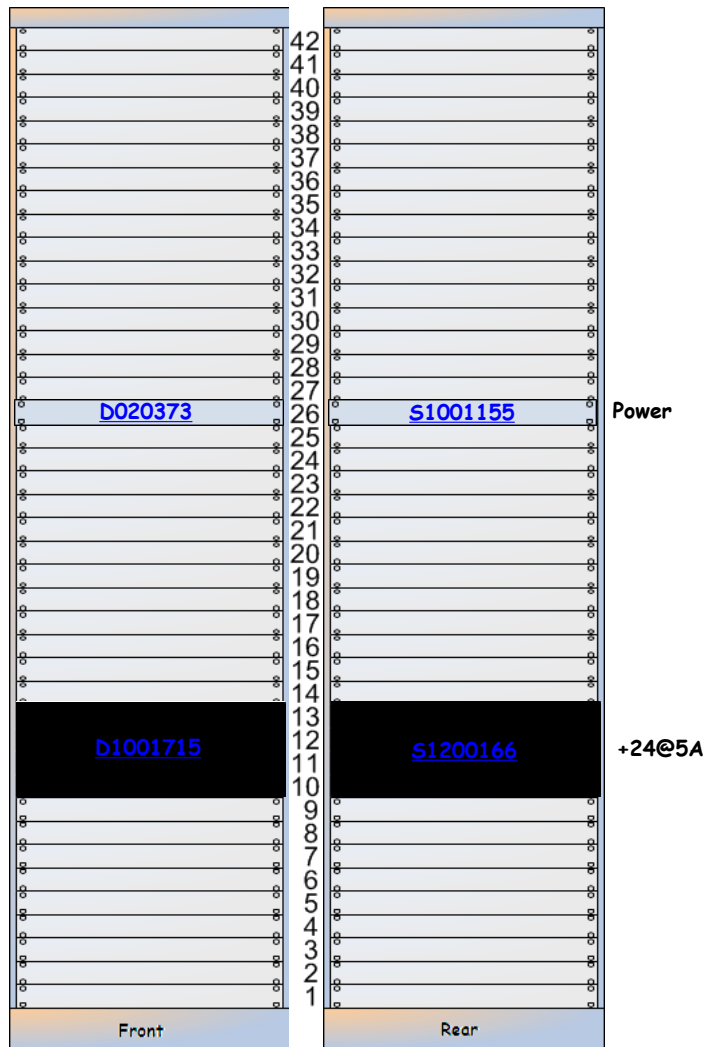

+18VDC	4A
-18VDC	4A
+24VDC	15A



D020373

Front

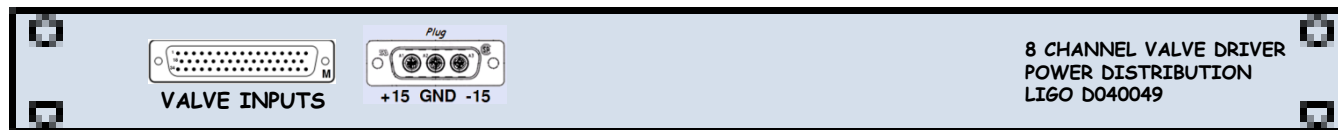
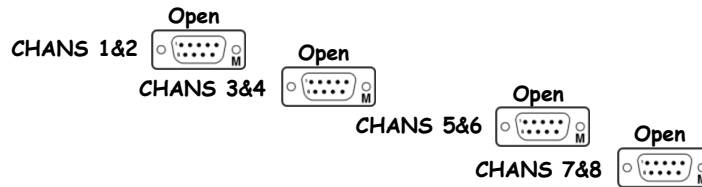

S1001155

D040049

Rear



I1seiey D1001715-S1200166

I/O Extension Chassis

D1001715

S1200166

24 VDC



D1001715

Front

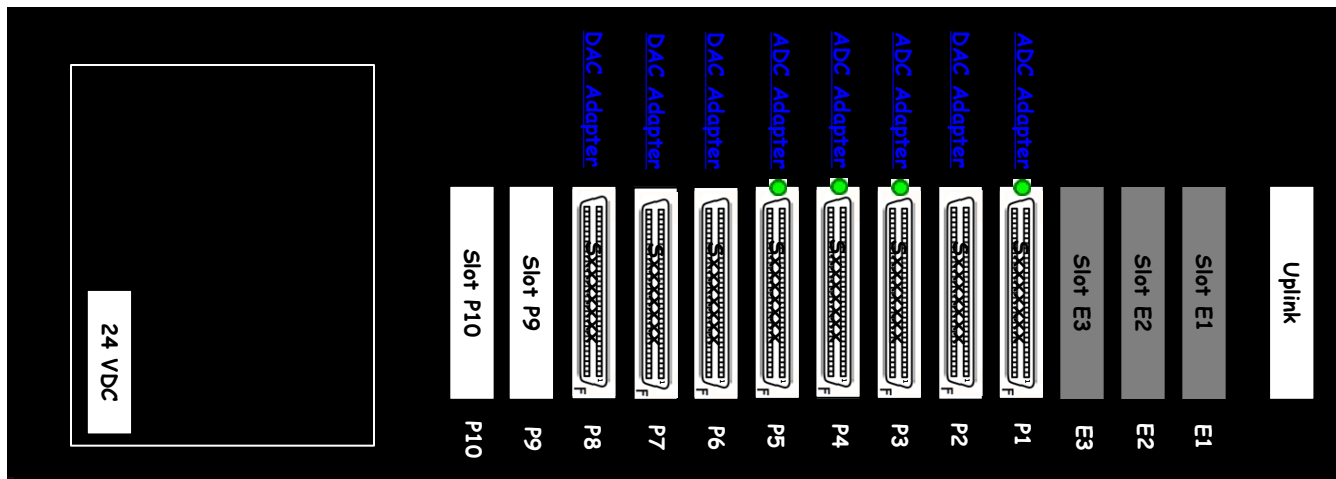

S1200166

Rear

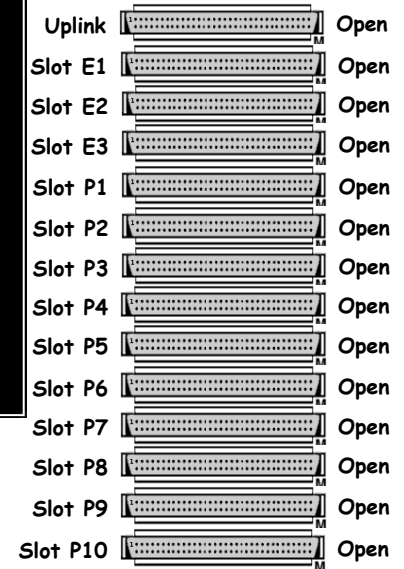

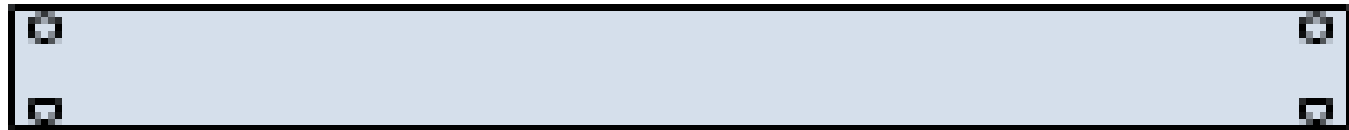

[D1102206](#)

Front

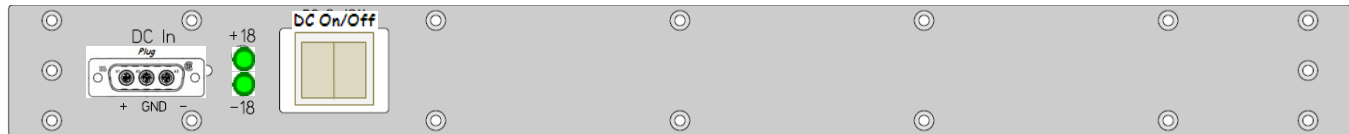

S???????

Rear

		42			
		41			
		40			
		39			
		38			
<u>Transmon Coil Driver Chassis</u>	<u>D1100301</u>	37	Sxxxxxxx	±18VDC	
<u>Transmon Coil Driver Chassis</u>	<u>D1100301</u>	36	Sxxxxxxx	±18VDC	
		35			
<u>Anti-alias Chassis (8*DB9)</u>	<u>D0902783</u>	34	<u>S1200819</u>	±18VDC	
		33			
<u>Anti-Image Chassis (4*DB9)</u>	<u>D1000305</u>	32	<u>S1001201</u>	±18VDC	
<u>Anti-Image Chassis (4*DB9)</u>	<u>D1000305</u>	31	<u>S1105312</u>	±18VDC	
		30			
		29			
		28			
		27			
<u>Anti-Image Chassis (2*DB15, 1*DB9)</u>	<u>D1100815</u>	26	<u>S1103827</u>	±18VDC	
<u>Anti-alias Chassis (2*DB15, 5*DB9)</u>	<u>D1100809</u>	25	<u>S1104075</u>	±18VDC	
		24			
		23			
		22			
		21			
		20			
<u>Binary Output Chassis (4*DB9, 2*DB37)</u>	<u>D1001270</u>	19	<u>S1106211</u>	±18VDC	
<u>Binary Input Chassis (4*DB9, 2*DB37)</u>	<u>D1001269</u>	18	<u>S1106114</u>	±18VDC	
<u>Binary Output Chassis (8*DB9)</u>	<u>D1002593</u>	17	<u>S1103224</u>	±18VDC	
<u>Binary Input Chassis (8*DB9)</u>	<u>D1001726</u>	16	<u>S1103897</u>	±18VDC	
		15			
		14			
		13			
		12			
		11			
		10			
		9			
		8			
		7			
		6			
		5			
		4			
		3			
		2			
		1			
	Front		Rear		



PSO-042

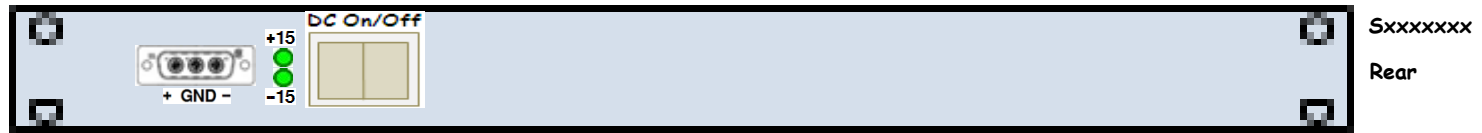

Transmon Coil Driver Chassis ±18VDC

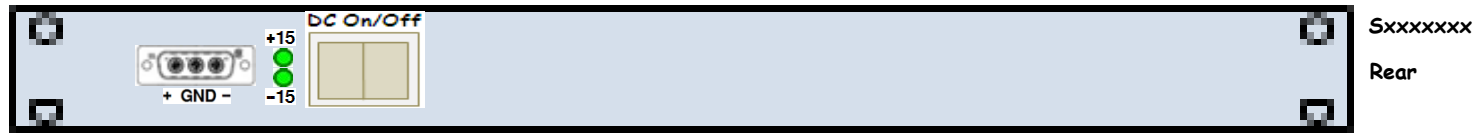

Anti-Alias Chassis (8*DB9) D0902783 S1200819 ±18@0.5A

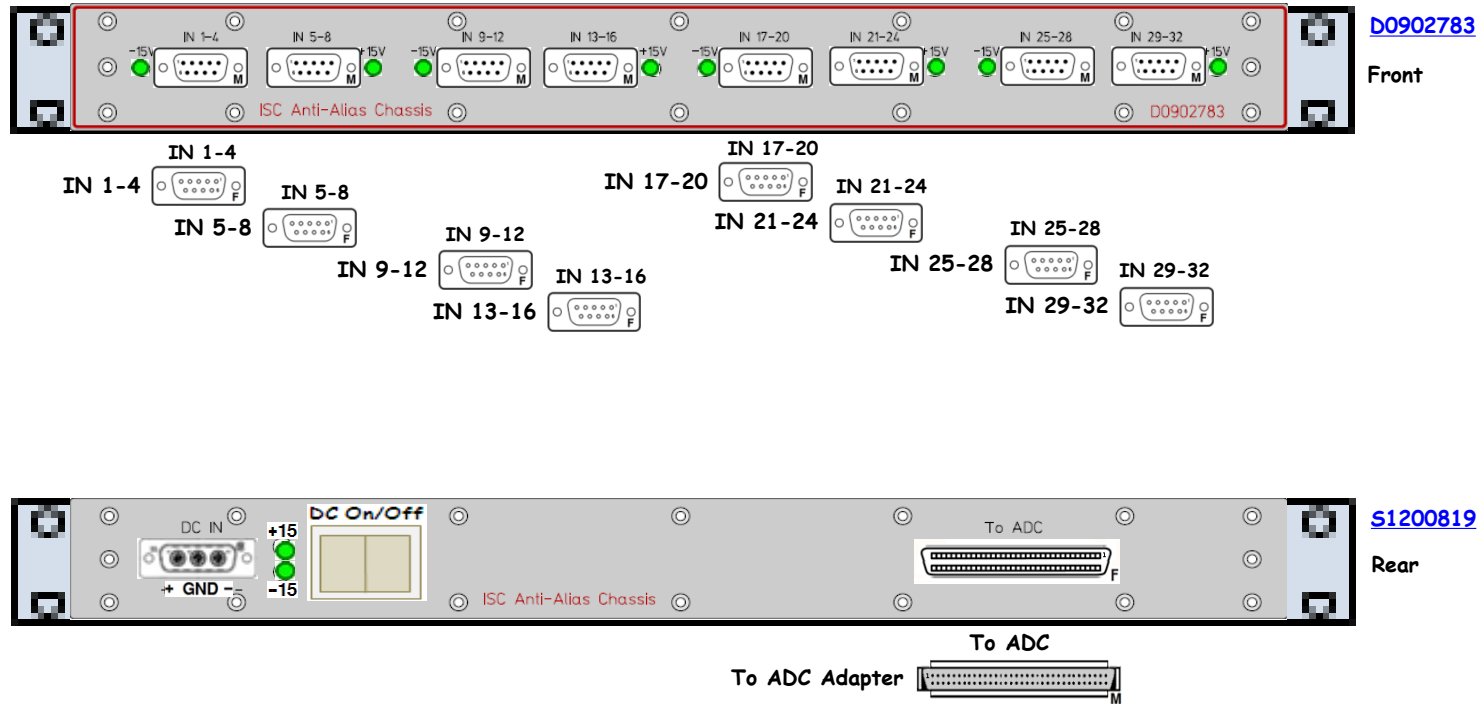

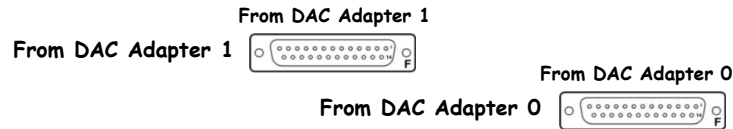
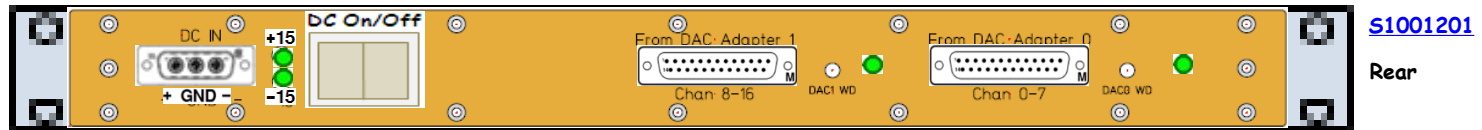
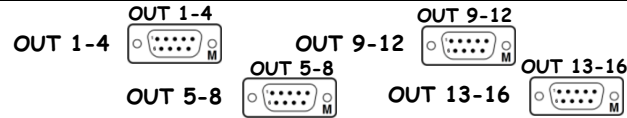
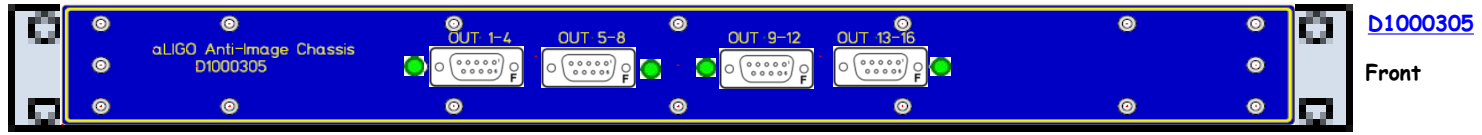

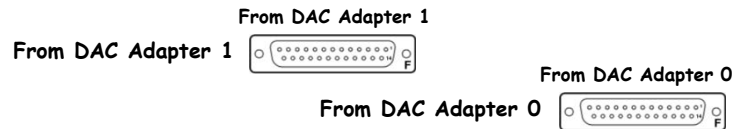
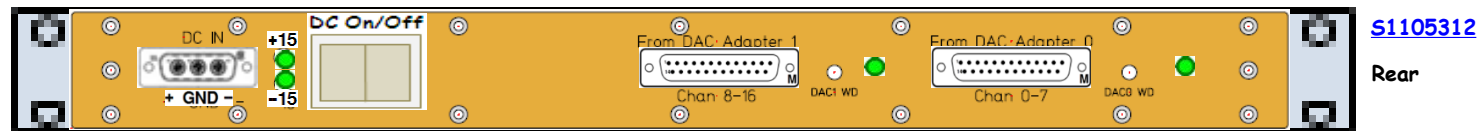
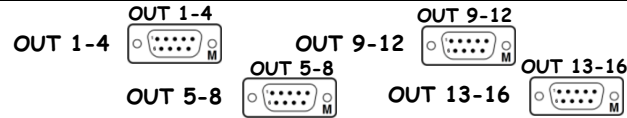
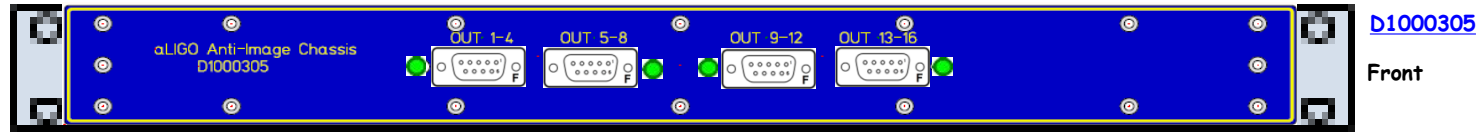

D1100815 is an AI, which means it has OUTPUTS, not INPUTS. The labels are incorrect.

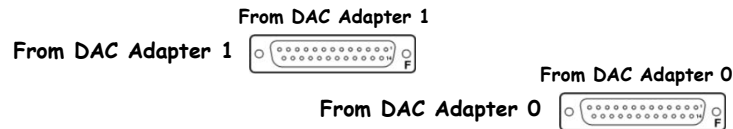
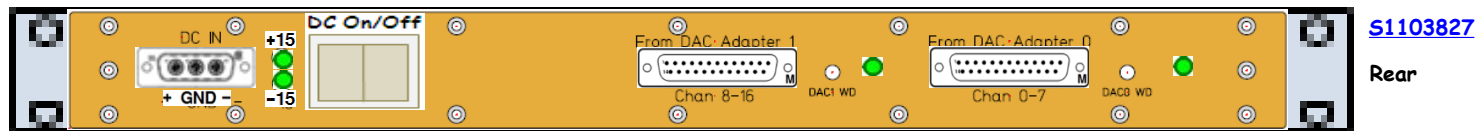
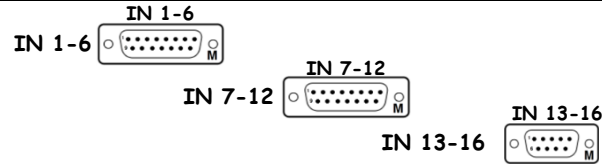
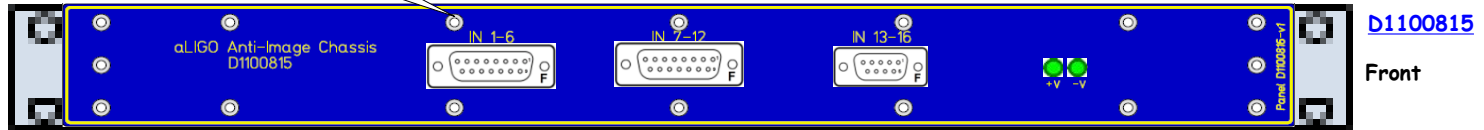

Anti-Alias Chassis (2*DB15, 5*DB9) D1100809 S1104075 ±18@0.5A

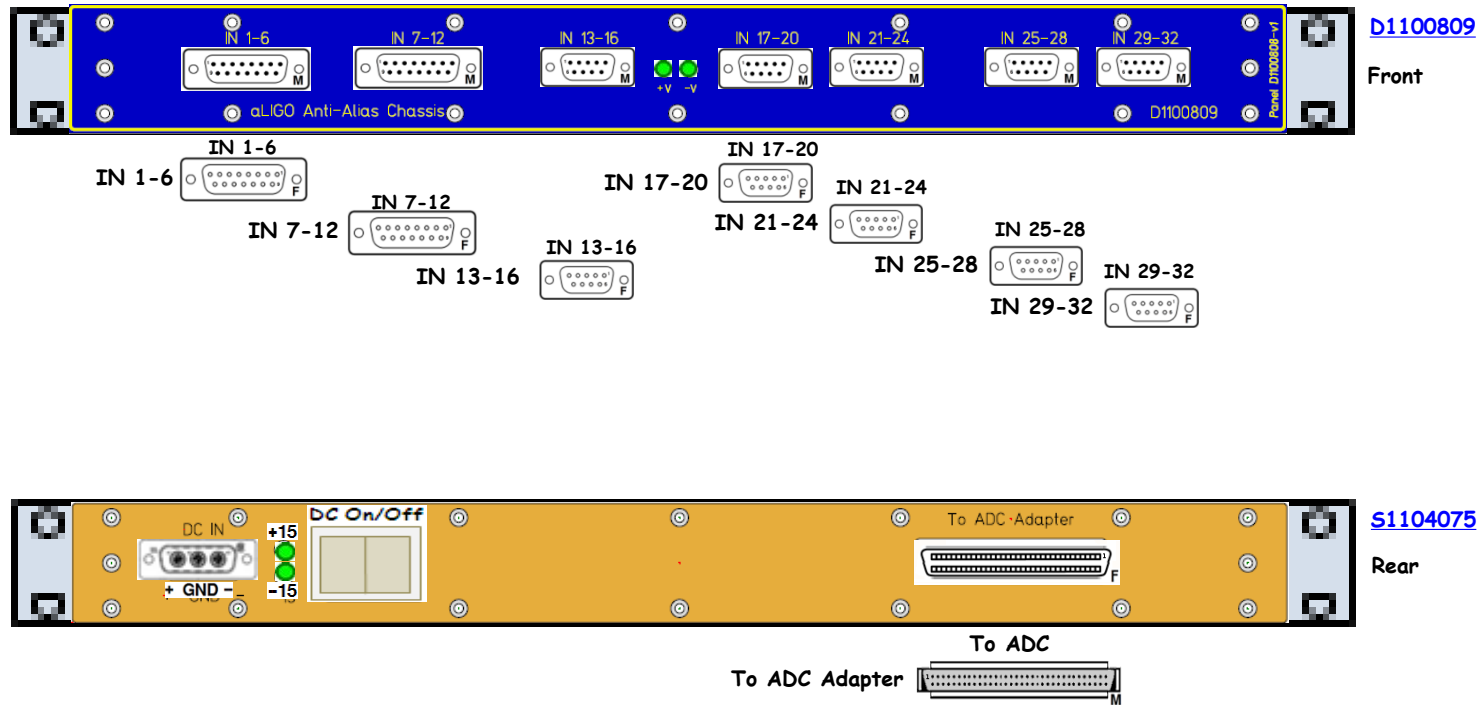

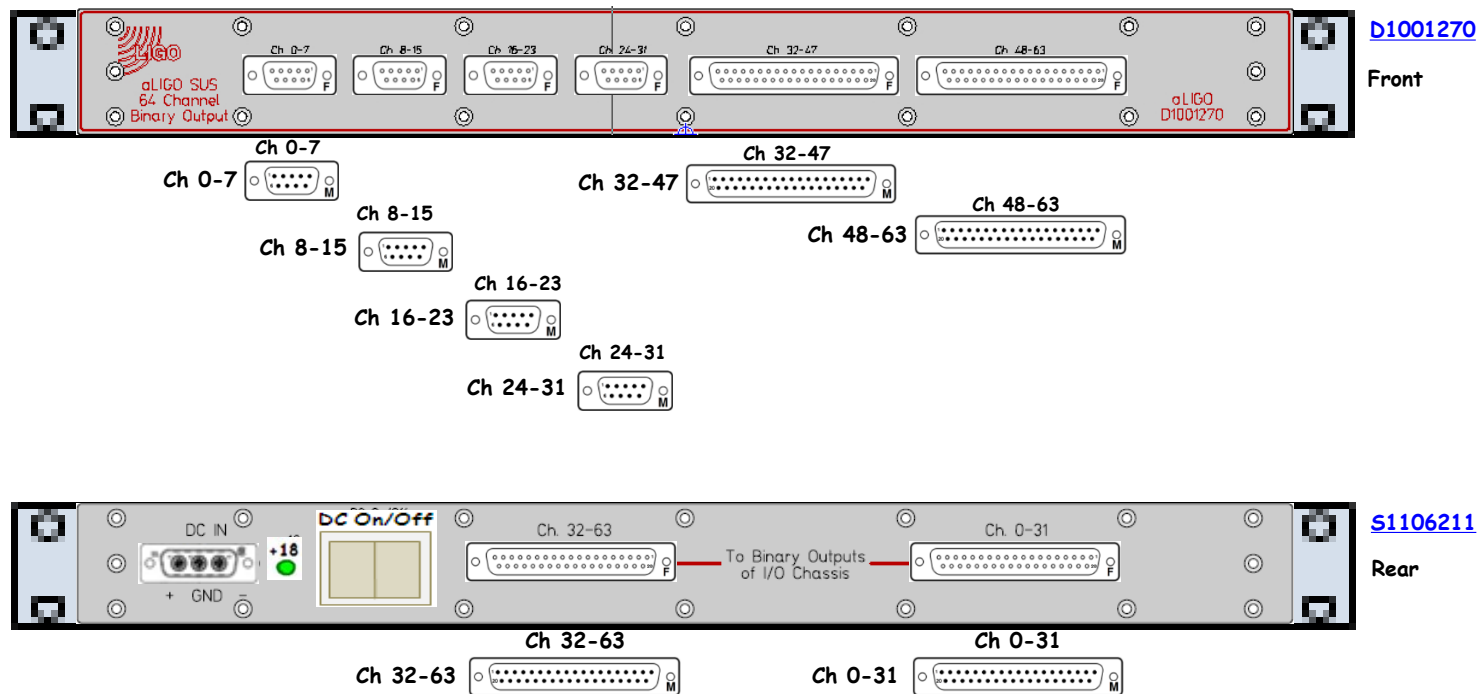

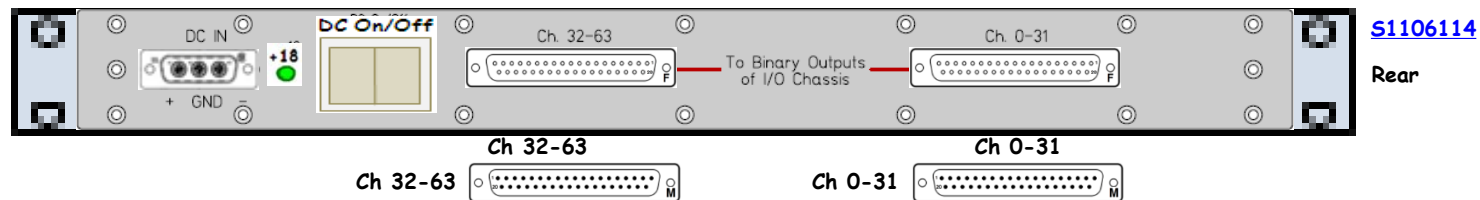
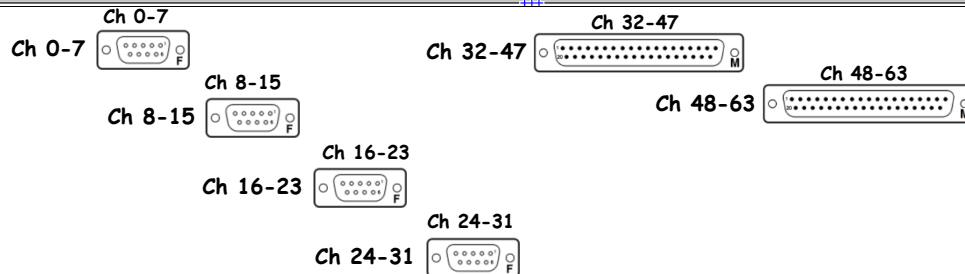
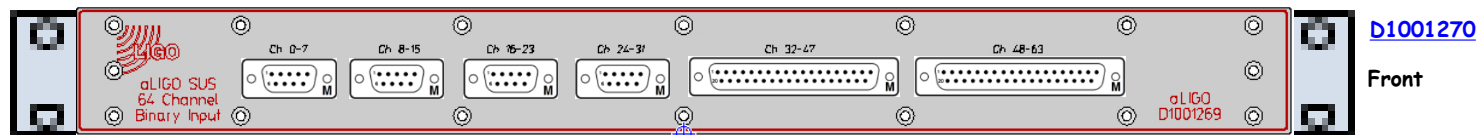

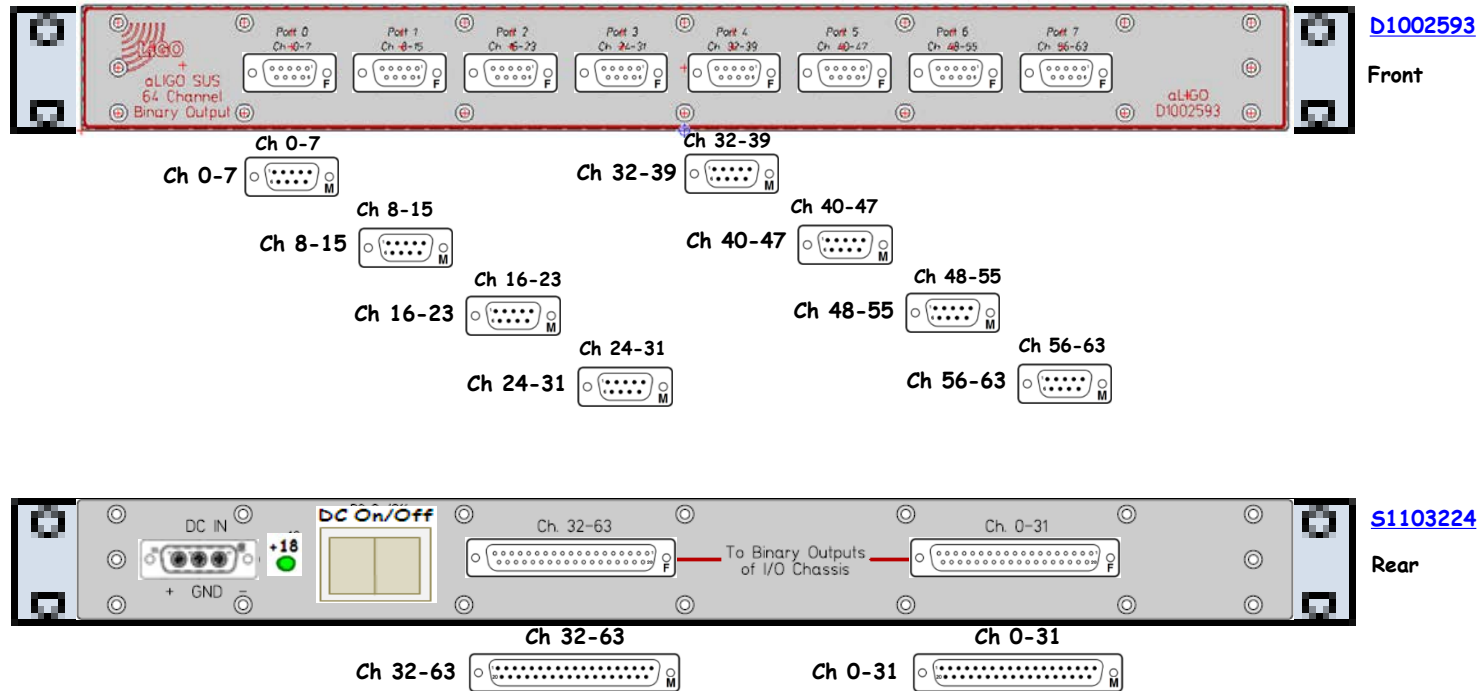

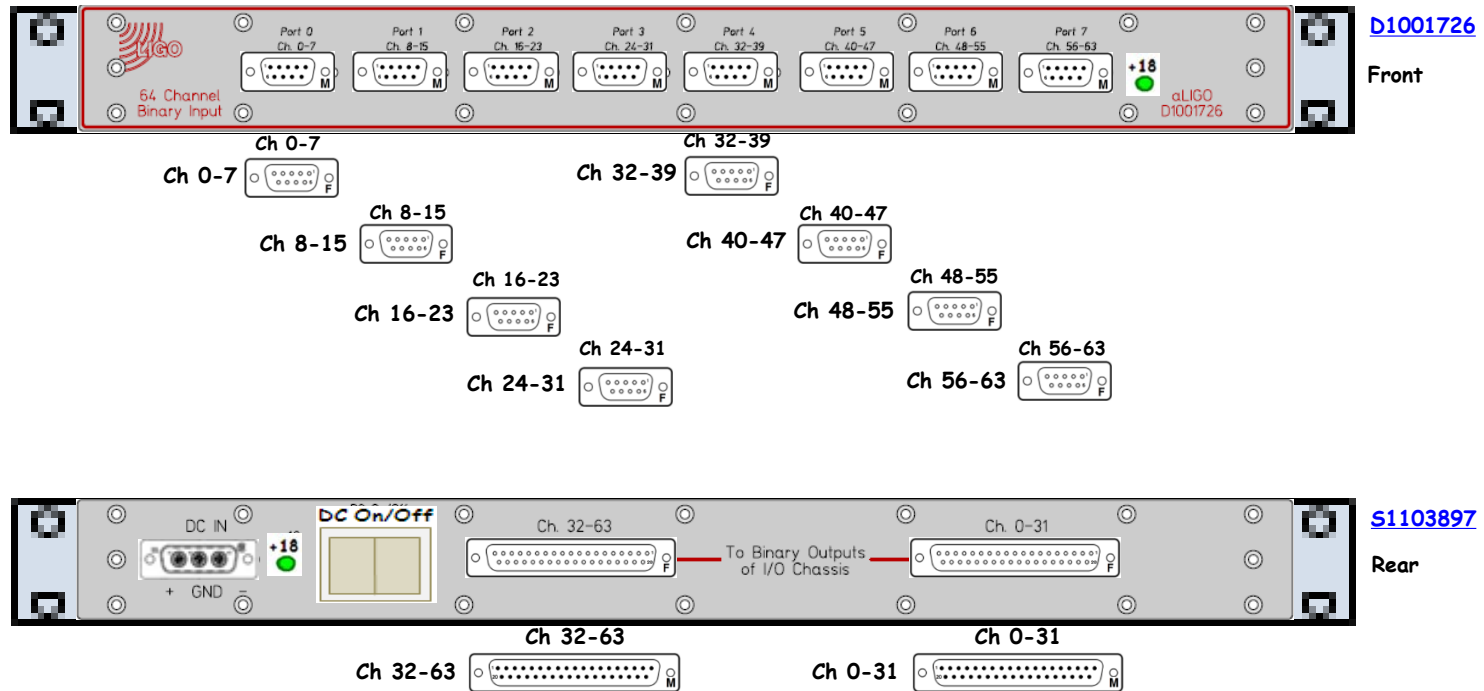

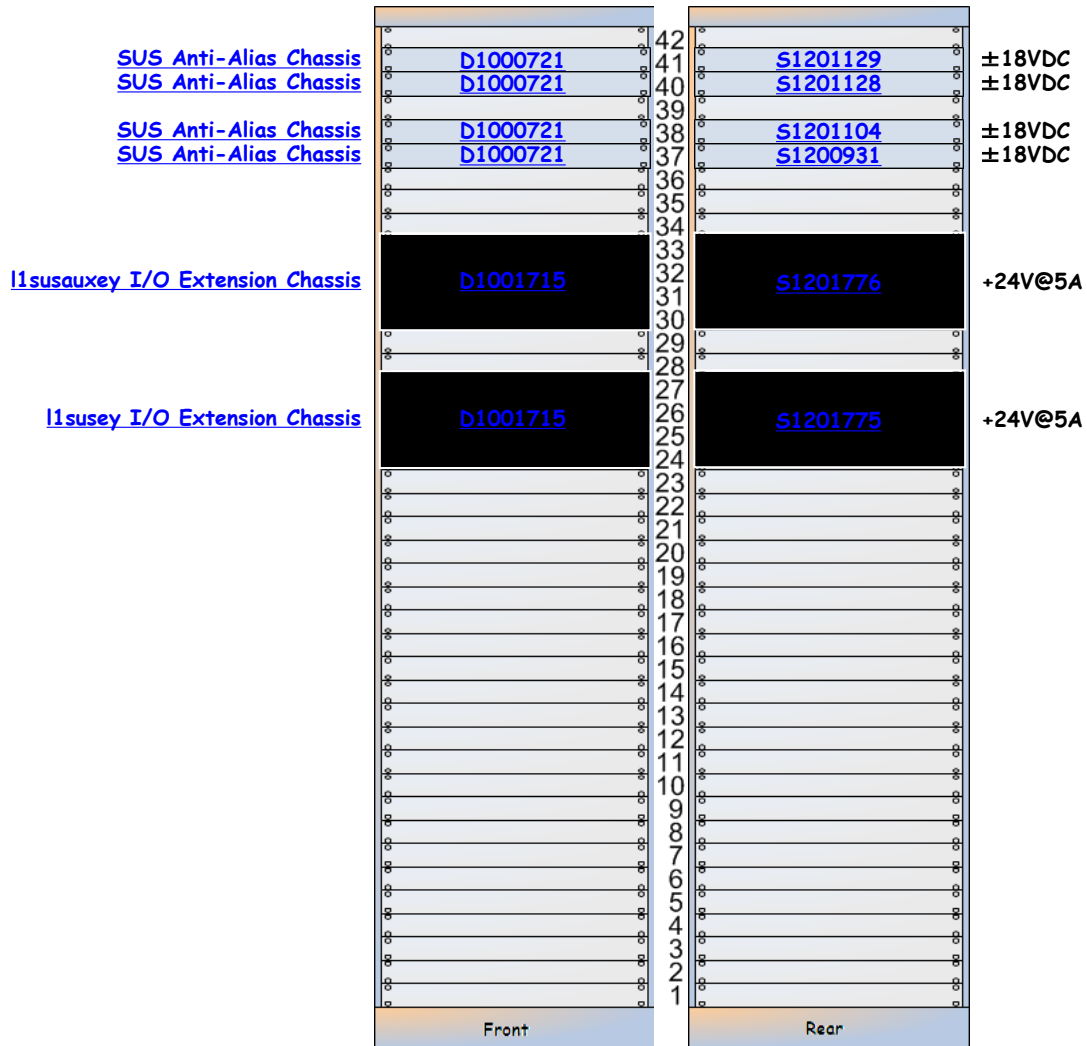

SUS Anti-Alias Chassis D1000721 S1201129 ±18@0.5A

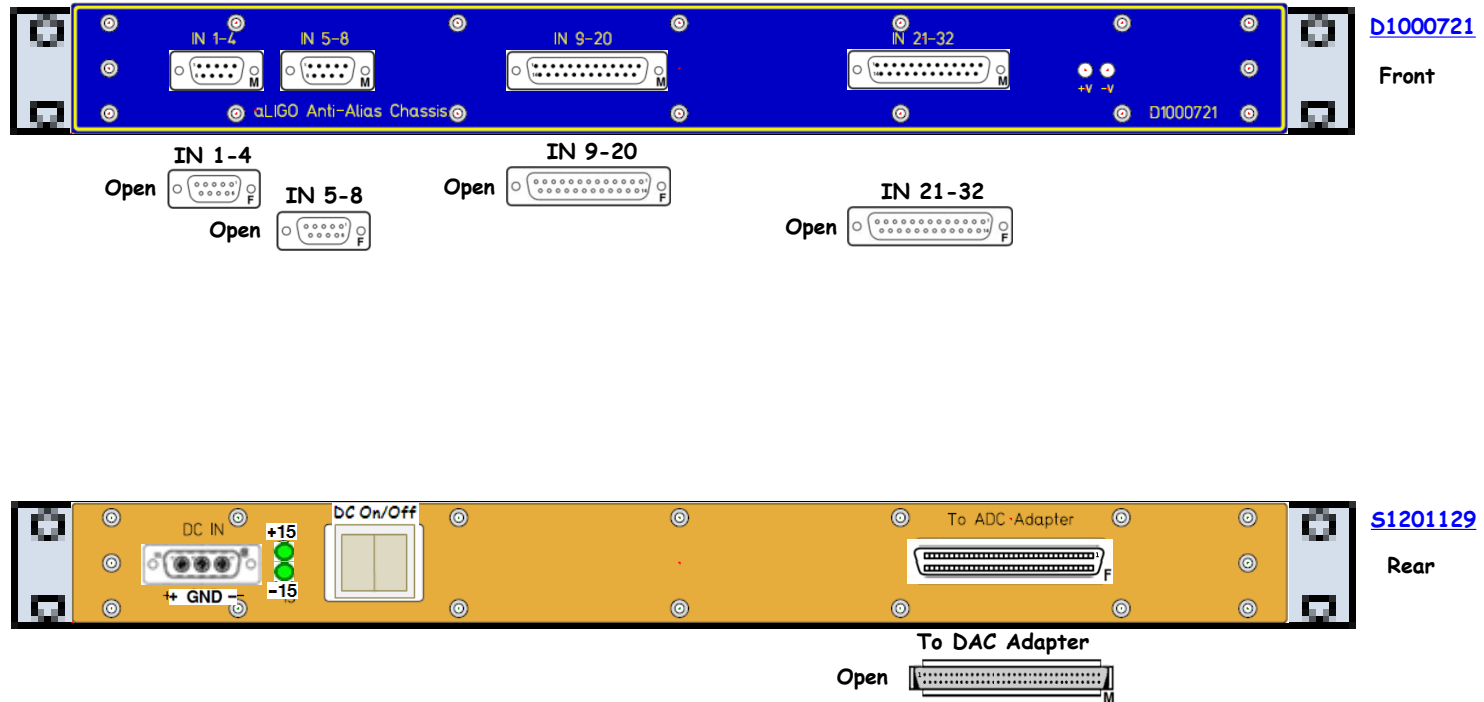

SUS Anti-Alias Chassis D1000721 S1201128 ±18@0.5A

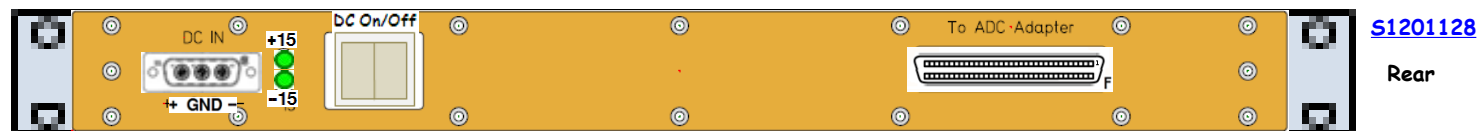
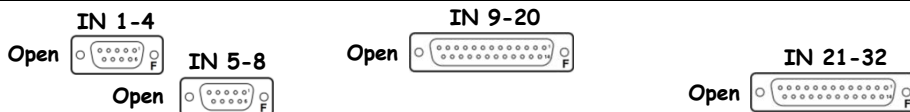
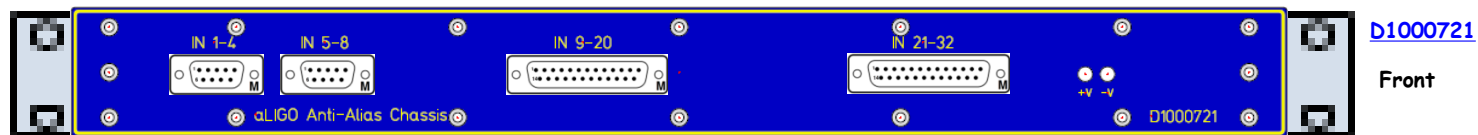

SUS Anti-Alias Chassis D1000721 S1201104 ±18@0.5A

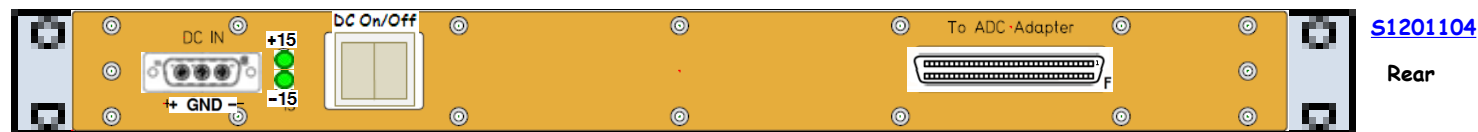
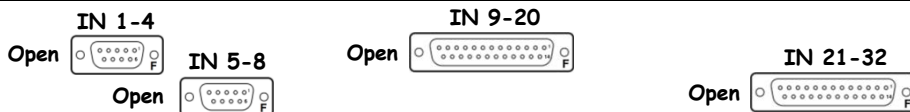
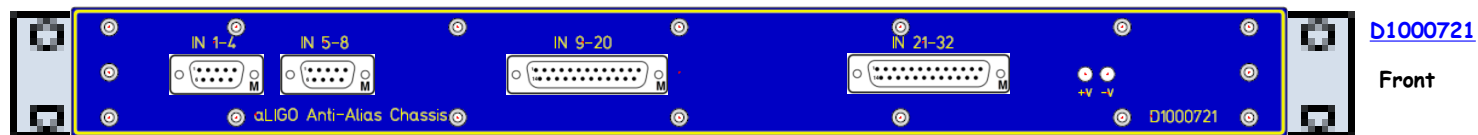

SUS Anti-Alias Chassis D1000721 S1200931 ±18@0.5A

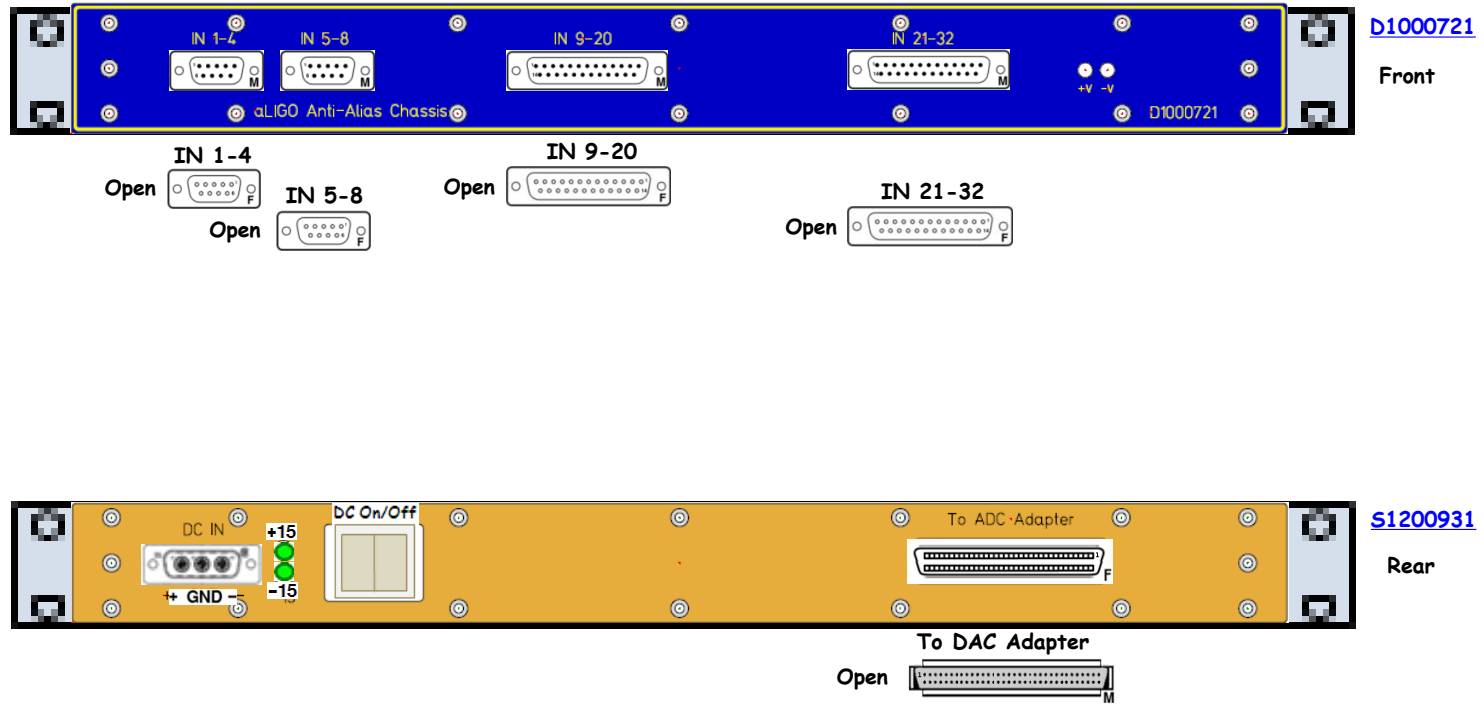



D1001715

Front

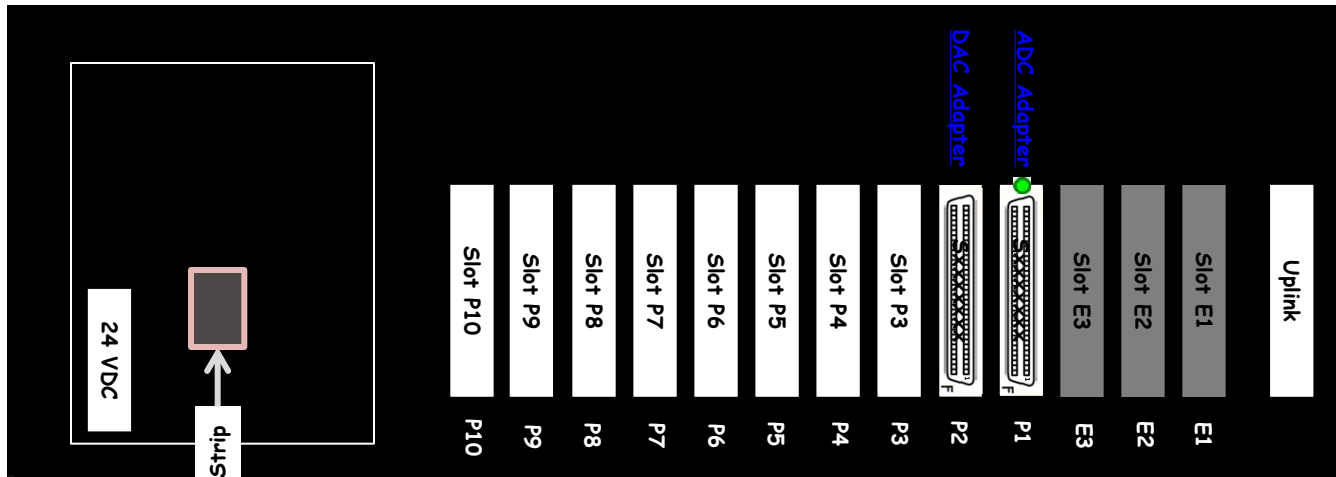

S1201776

Rear

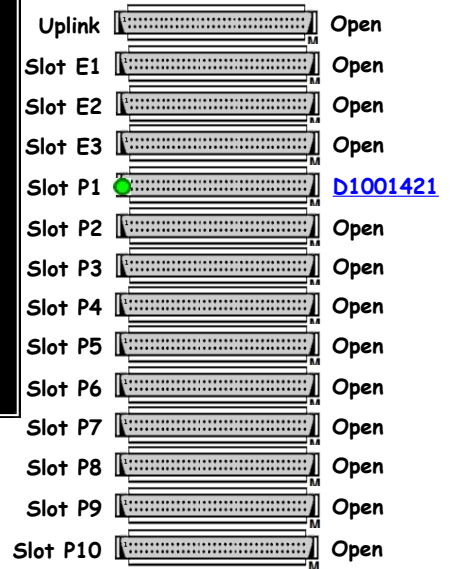

I1susey - D1001715 - S1201775

I1susey I/O Extension Chassis

[D1001715](#)

[S1201775](#)

110VAC



[D1001715](#)
Front

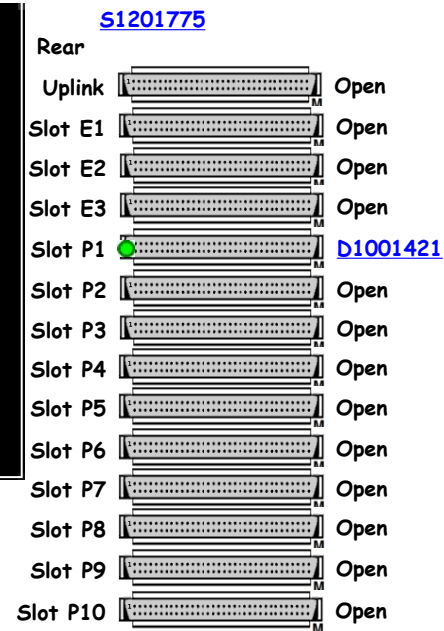
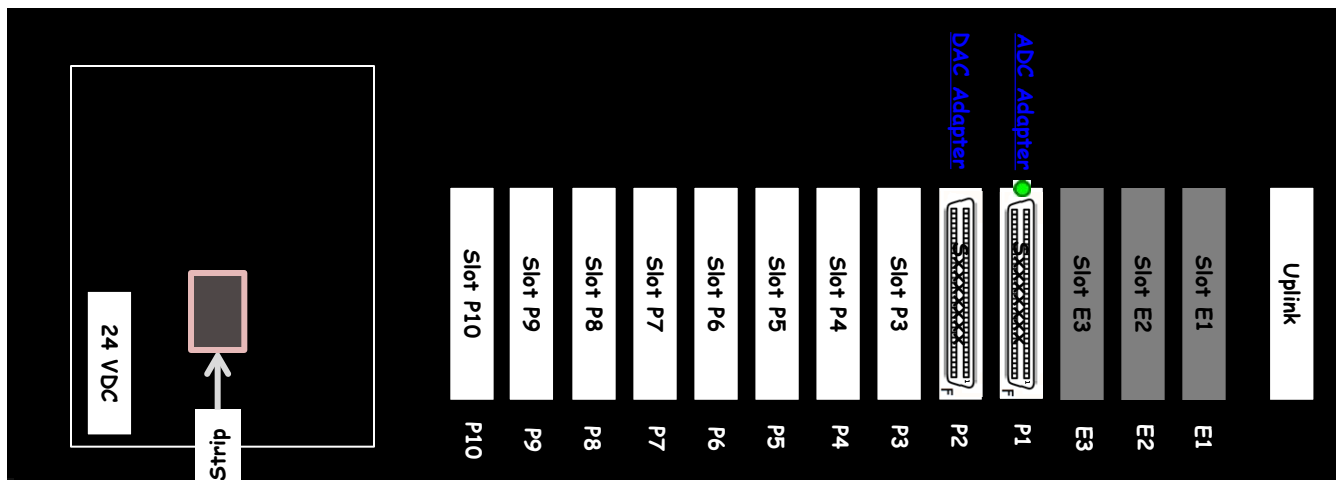

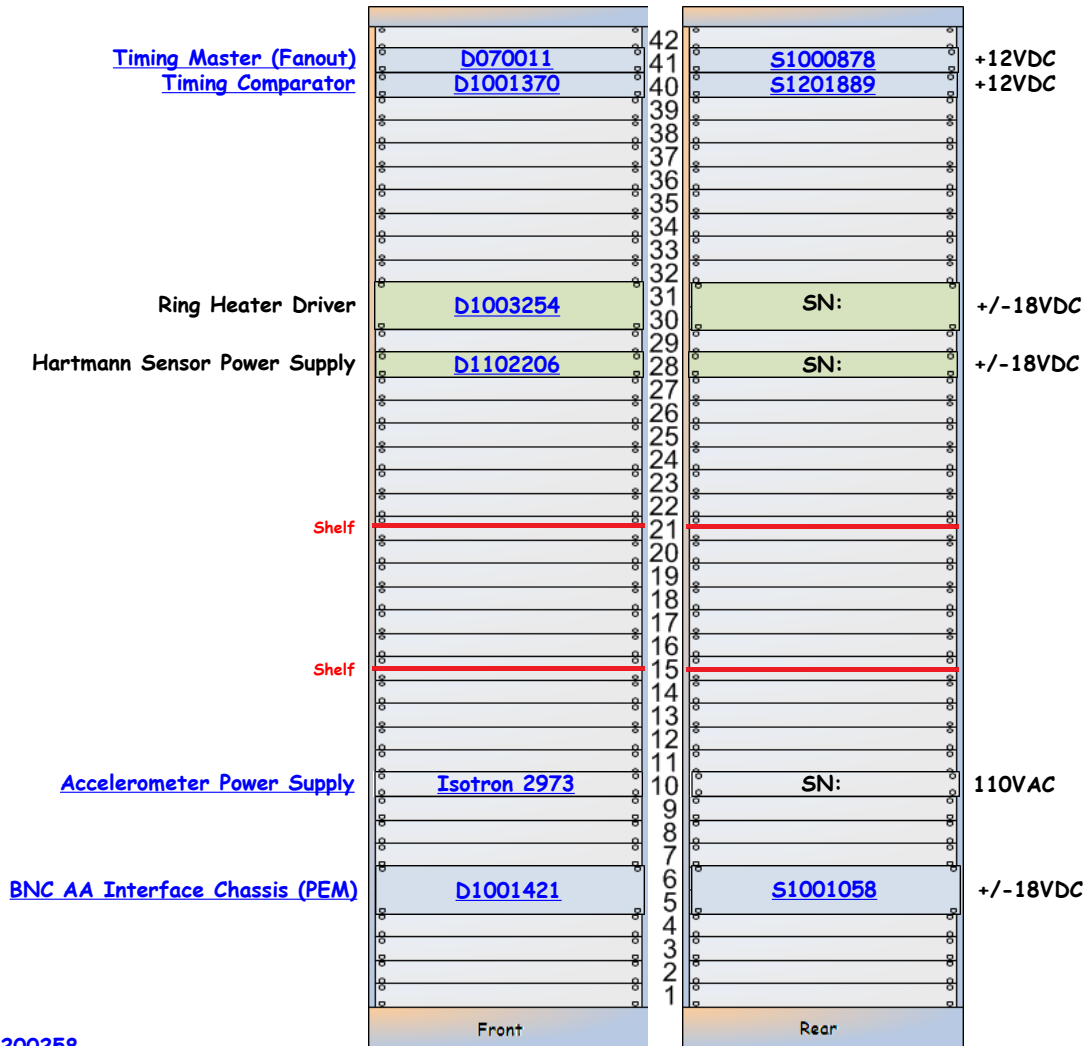

TCS-YC1 is part of [D1200258](#)

TCS-YC1 is part of [E1100894](#)



[D070011](#)

Front



[S1000878](#)

Rear

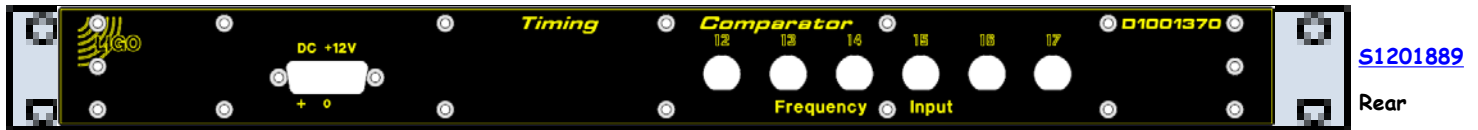
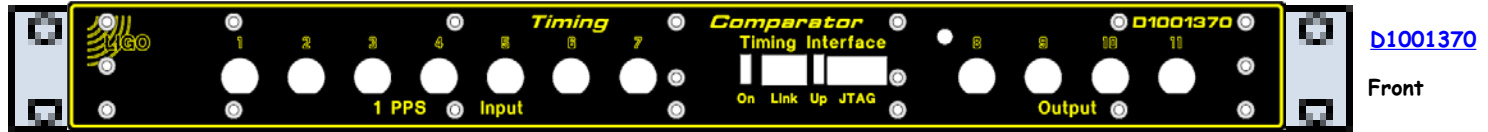

D1102206 - Sxxxxxxx



<< L1-TCS-YC1

Hartmann Sensor Power Supply

D1102206

Sxxxxxxx

+12VDC

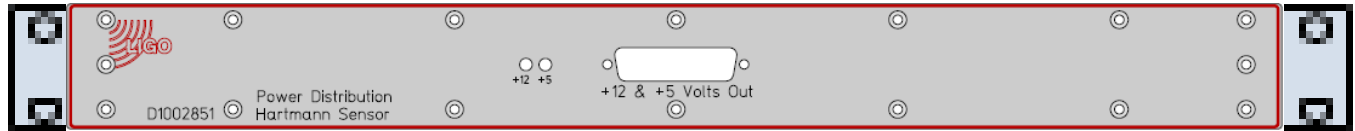

D1102206

Front



Sxxxxxxx

Rear

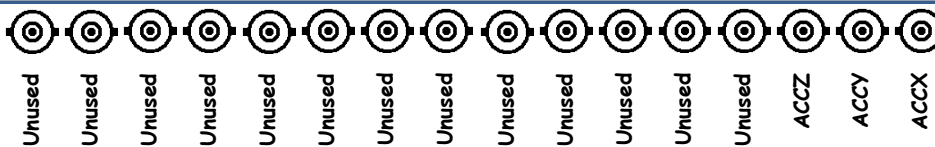
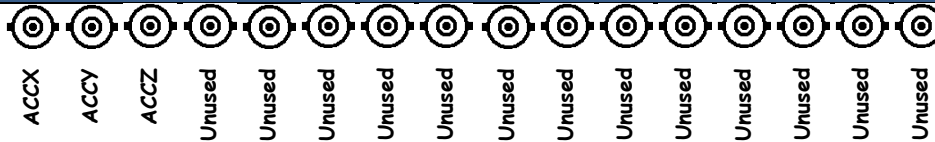

BNC AA Interface Chassis (PEM)

[D1001421](#)

[S1001058](#)

+/-18VDC

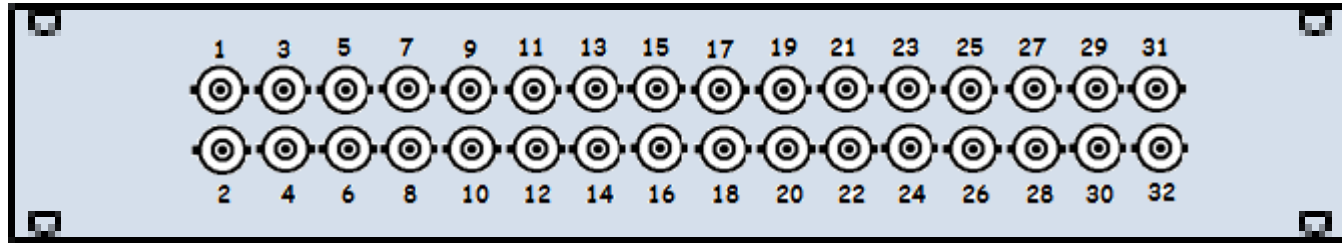

[D1001421](#)

Front

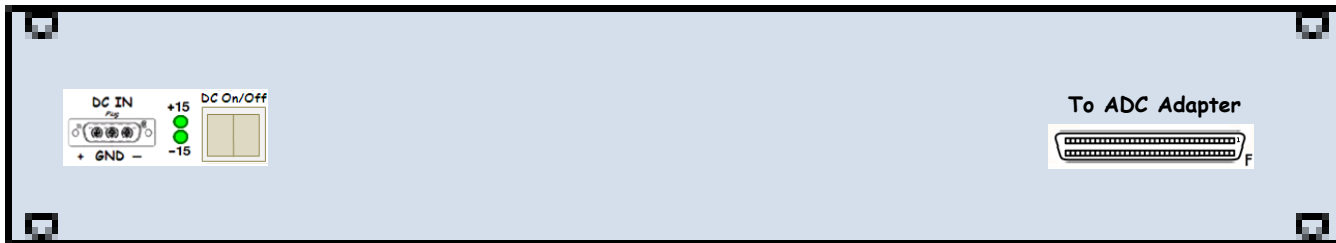
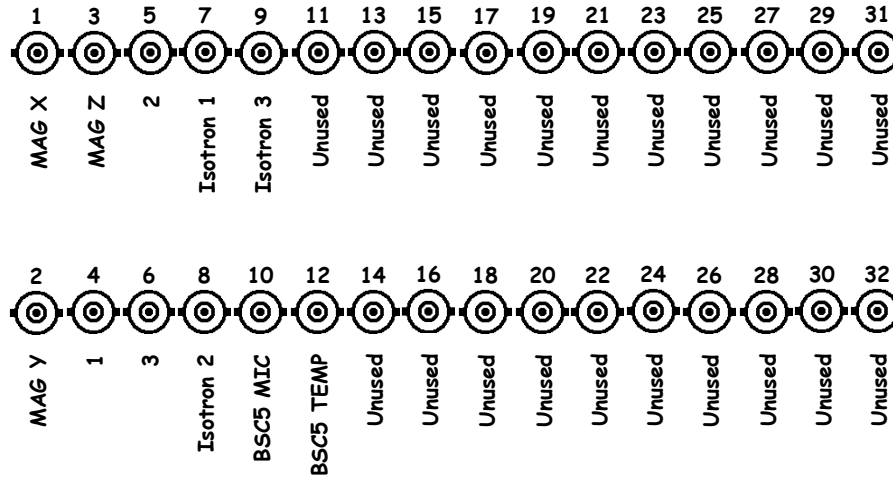

[S1001058](#)

Rear

[To 11pemev Slot P1](#)



To ADC Adapter



To ADC Adapter

aLIGO Accelerometer Interface Chassis

D1101363

SN:

Power

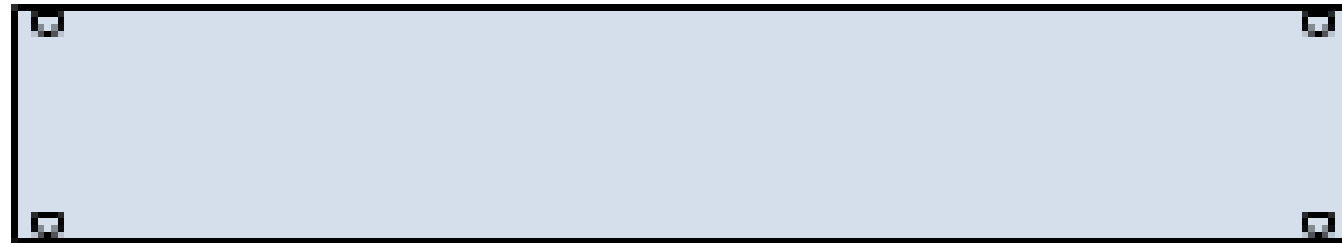
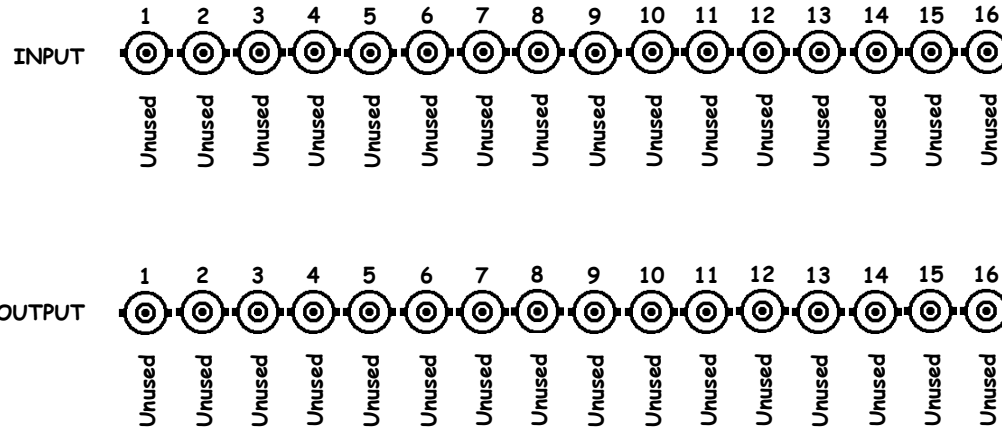
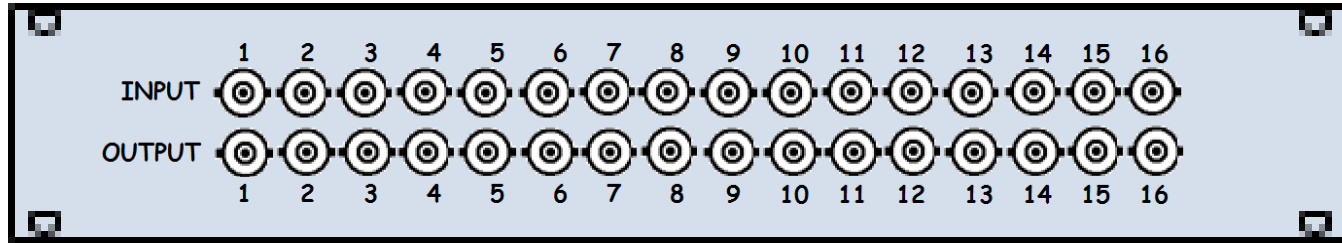



Status as of 9 November, 2012
End Station ISC Field Rack Layout

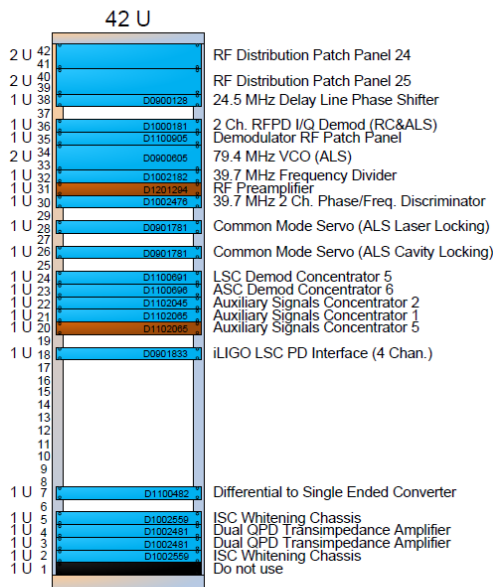

End Station Field Rack
LIGO D1001423-v13

+12VDC	1A	Differential to Single-Ended Converter
-12VDC	1A	
+18VDC	10A	ISC Whitening Chassis
-18VDC	10A	
+24VDC	4A	Dual QPD Transimpedance Amplifier
-24VDC	4A	
High Voltage	?A	ISC Whitening Chassis

ISC-YR1 is part of [D1001423](#)

Distribution Panel 24

Distribution Panel 25
y Line Phase Shifter

2 Ch Demod (RC & ALS)
Demodulator RF Patch Panel

79.4 MHz VCO (ALS)

39.7 MHz Frequency Divider
RF Preamplifier
39.7 MHz 2 Ch. Phase/Freq. Discriminator

Common Mode Servo (ALS Laser Locking)

Common Mode Servo (ALS Cavity Locking)

LSC Demod Concentrator 5

ASC Demod Concentrator 5

Auxiliary Signals Concentrator 2

Auxiliary Signals Concentrator 1

Auxiliary Signals Concentrator 5

iLIGO LSC PD Interface (4 Channel)

Differential to Single Ended Converter

ISC Whitening Chassis

Dual QPD Transimpedance Amplifier

Dual QPD Transimpedance Amplifier

ISC Whitening Chassis

Dxxxxxxx	42	SN:	No Power
Dxxxxxxx	41	SN:	No Power
D0900128	40	SN:	±18V
D1000181	39	S1103430	±18V
D1100905	38	S1000786	±18V
D0900605	37	Sxxxxxxx	No Power
D1002182	36	S1200578	±18V
D1201294	35	S1000753	±18V
D1002476	34	Sxxxxxxx	±18V
D0901781	33	S1000768	±18V
D0901781	32	S1102646	±18V
D0901781	31	S1102647	±18V
D1100691	30	S1104010	±18V
D1100696	29	S1103989	±18V
D1102045	28	Sxxxxxxx	±18V
D1102065	27	Sxxxxxxx	±18V
D1102065	26	Sxxxxxxx	±18V
D0901833	25	Sxxxxxxx	±18V
D1100482	24	Sxxxxxxx	±18V
D1002559	23	Sxxxxxxx	±18V
D1002481	22	Sxxxxxxx	±18V
D1002481	21	Sxxxxxxx	±18V
D1002559	20	Sxxxxxxx	±18V
D1002559	19	Sxxxxxxx	±18V
D1002559	18	Sxxxxxxx	±18V
D1002559	17	Sxxxxxxx	±18V
D1002559	16	Sxxxxxxx	±18V
D1002559	15	Sxxxxxxx	±18V
D1002559	14	Sxxxxxxx	±18V
D1002559	13	Sxxxxxxx	±18V
D1002559	12	Sxxxxxxx	±18V
D1002559	11	Sxxxxxxx	±18V
D1002559	10	Sxxxxxxx	±18V
D1002559	9	Sxxxxxxx	±18V
D1002559	8	Sxxxxxxx	±18V
D1002559	7	Sxxxxxxx	±18V
D1002559	6	Sxxxxxxx	±18V
D1002559	5	Sxxxxxxx	±18V
D1002559	4	Sxxxxxxx	±18V
D1002559	3	Sxxxxxxx	±18V
D1002559	2	Sxxxxxxx	±18V
D1002559	1	Sxxxxxxx	±18V

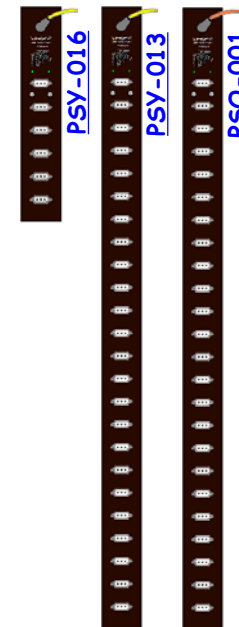

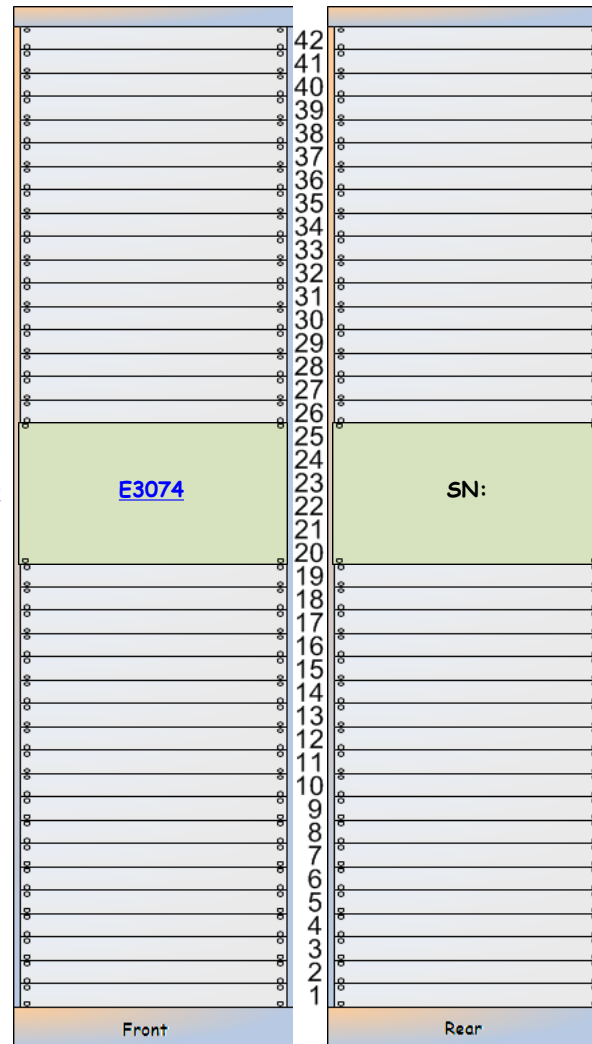

Electrostatic Driver

E3074

SN:

+ -18VDC@0.4A
+ -430VDC@15mA

+18VDC	?A
-18VDC	?A
+24VDC	?A

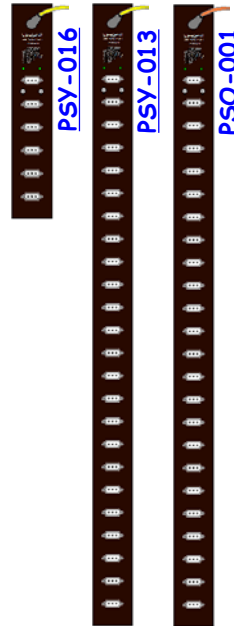

E3074

Electrostatic Driver

E3074

SN:

+ -18VDC@0.4A
+ -430VDC@15mA



E3074

Front



S???????

Rear

L1-VAC-YR1 Y-End Vacuum Rack Layout (Dxxxxxxx)

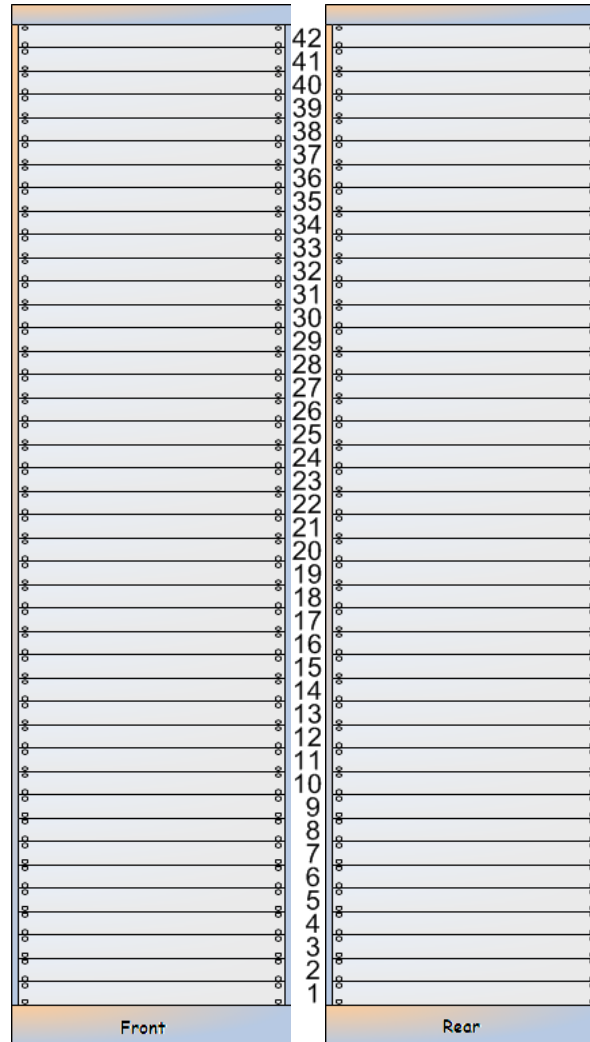

[<< LLO Corner Station](#)

[<< LLO Racks by AREA](#)

[<< LLO CDS Components](#)

DAQ (aka CDS) Test Rack (L1-ETR-01)	RMS (aka Triple) Test Rack (L1-ETR-04)	Triple SUS Test Rack (L1-ETR-07)
BSC (aka QUAD) Test Rack (L1-ETR-02)	HAM ISI Test Rack (L1-ETR-05)	Future Test Rack (L1-ETR-08)
Optics Test Rack (L1-ETR-03)	STS Huddle Test Rack (L1-ETR-06)	Future Test Rack (L1-ETR-09)

L1 DTS - IO

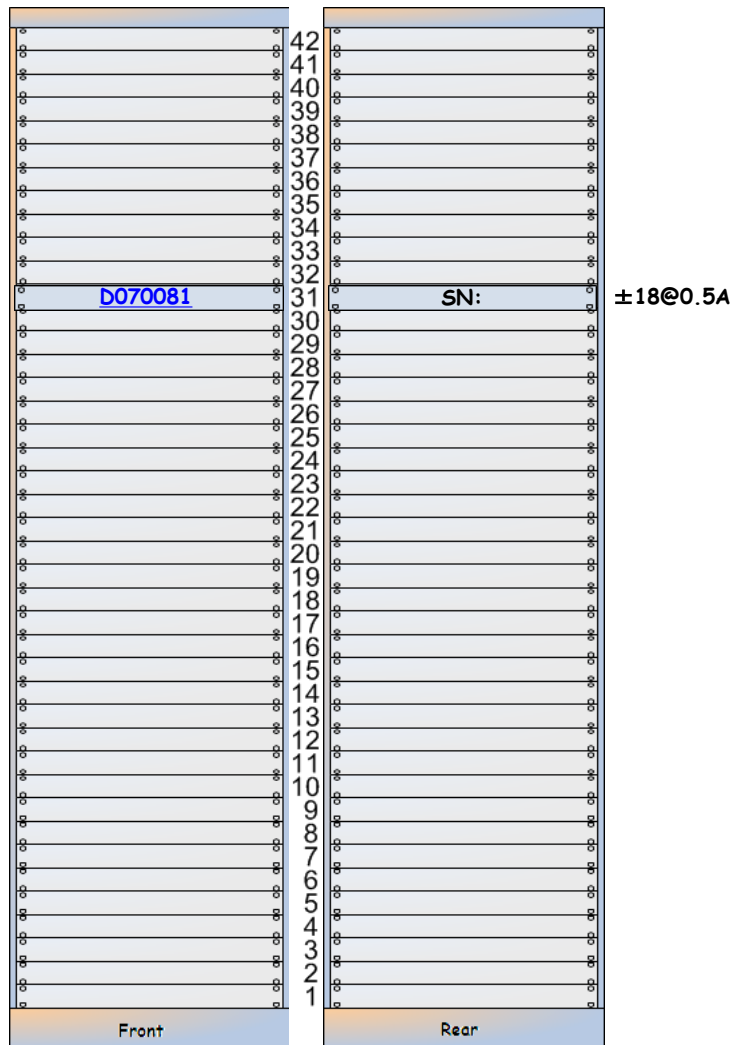
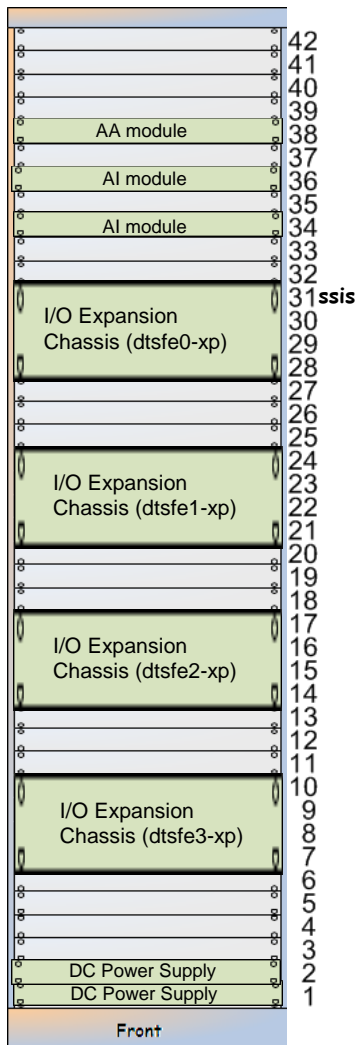

D070124 Rack Input
Power Box (RU 34-36)

+18VDC	?A
-18VDC	?A
+24VDC	?A
-24VDC	?A

L1-ETRO1 DAQ (aka CDS)

L1-ETRO1
Front

- Linksys BEFSX41 Firewall Router
- D070011 Fanout Timing
- Netgear GS724T Switch
- Netgear GSM7352S Switch
- SUN Microsystems X2200 SuperMicro

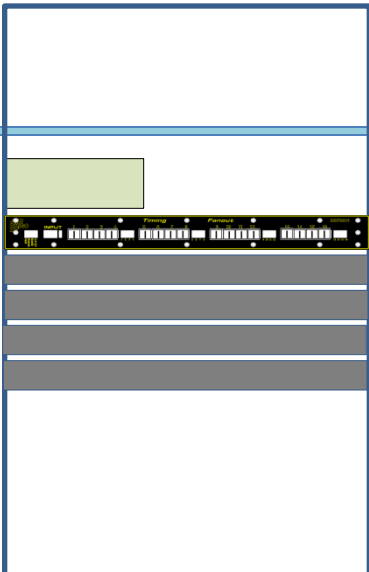

- I/O Extension
- 2 ADC
- 1 DAC
- 1 Timing Slave
- Shelf
- KVM

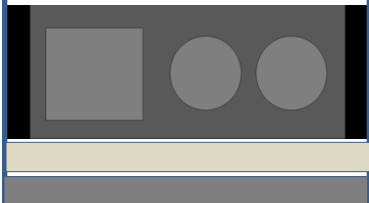

- D070081 AI Chassis
- D070081 AA Chassis

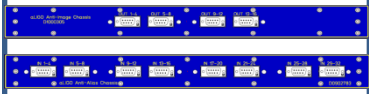

- SuperMicro
- SuperMicro
- SuperMicro



- JQE25-10M +15V
- JQE25-10M -15V

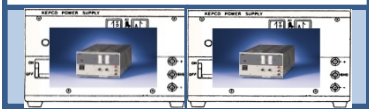

- JQE25-10M +24V
- JQE25-10M -24V

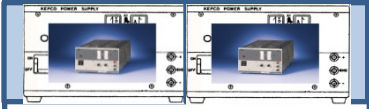

L1-ETRO1
Rear

- D070011 Fanout Timing
- SN:
- SN:
- 0923QAT00D dtserver 192.168.100.10
- ... dtsfe1 192.168.100.15

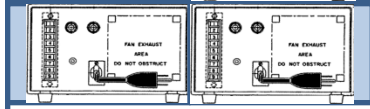
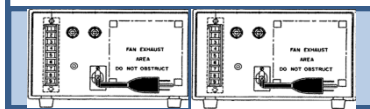
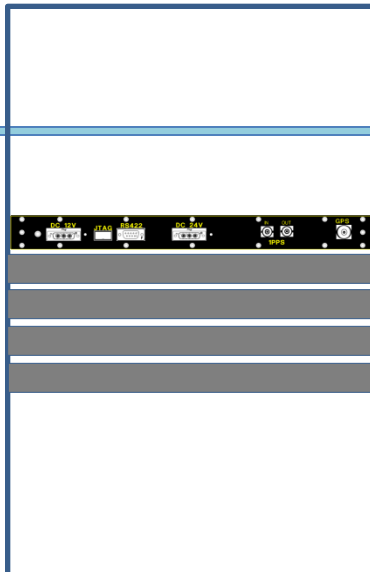

- Shelf
- SN:
- D070081 SYYYYYYYY
- D070081 SYYYYYYYY
- ... dtstdco 192.168.100.30
- ... dtswfo 192.168.100.31
- ... dtsndso 192.168.100.32

DC Bus Distribution Box

- SN:
- SN:
- SN:
- SN:

Linier Rack – has front and rear doors and wheels.

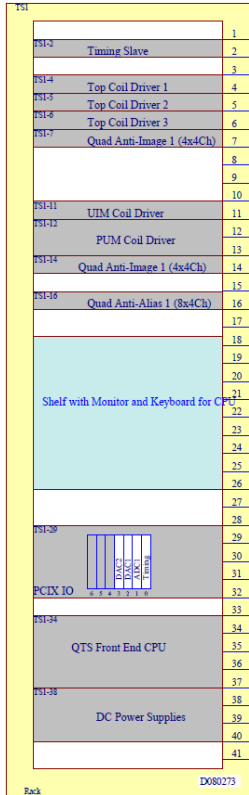

D070124 Rack Input Power Box (RU 34-36)

+18VDC	?A
-18VDC	?A
+24VDC	?A
-24VDC	?A



L1-ETRO2 BSC (aka Quad)

L1-ETRO2
Front

L1-ETRO2
Rear

Computer

I/O Extension
2 ADC
1 DAC
1 Timing Slave

JQE25-10M +15V
JQE25-10M -15V

SN:

SN:
SN:

Satellite Amplifier

Satellite Amplifier

Satellite Amplifier

Satellite Amplifier

Satellite Amplifier

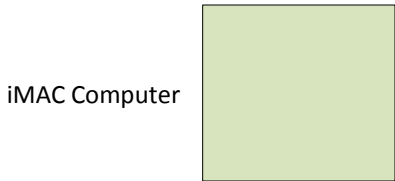
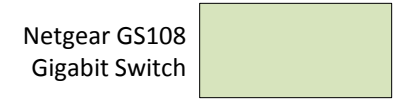
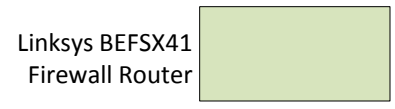
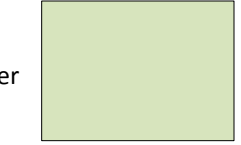
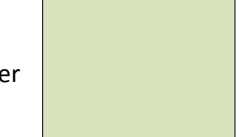
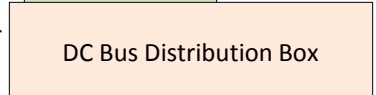
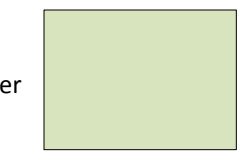



**D070124 Rack Input
Power Box (RU 34-36)**

+18VDC	?A
-18VDC	?A
+24VDC	?A
-24VDC	?A

L1-ETRO3
Front

L1-ETRO3
Rear

Computer

I/O Extension
2 ADC
1 DAC
1 Timing Slave



SN:



Linksys BEFSX41
Firewall Router

Netgear GS108
Gigabit Switch

iMAC Computer

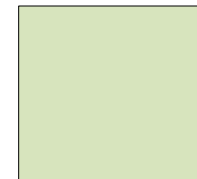

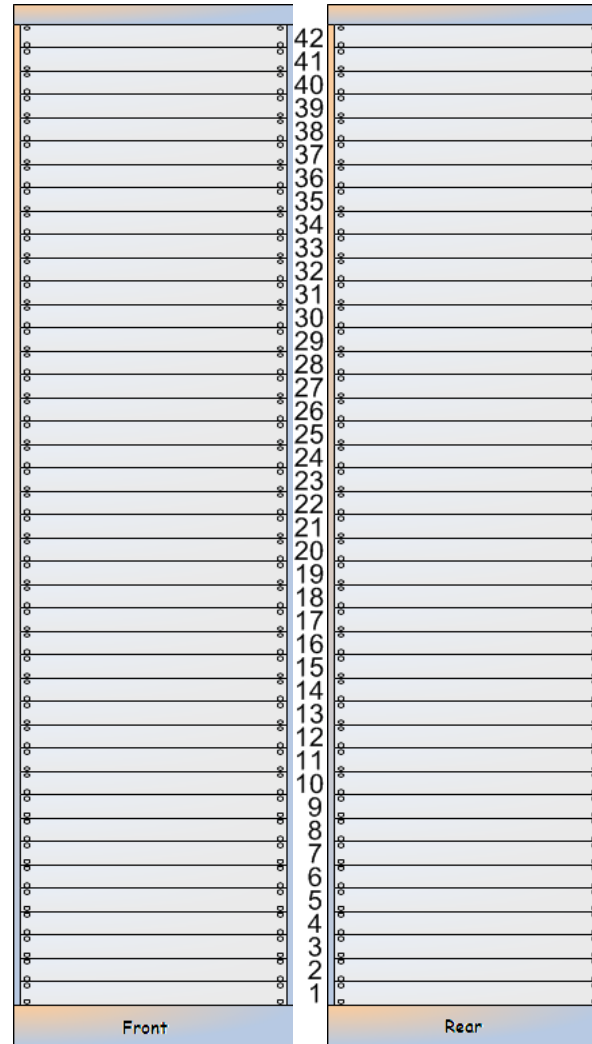

**D070124 Rack Input
Power Box (RU 34-36)**

+18VDC	?A
-18VDC	?A
+24VDC	?A
-24VDC	?A



L1-ETRO4 RMT (aka Triple)

L1-ETRO4
Front

L1-ETRO4
Rear

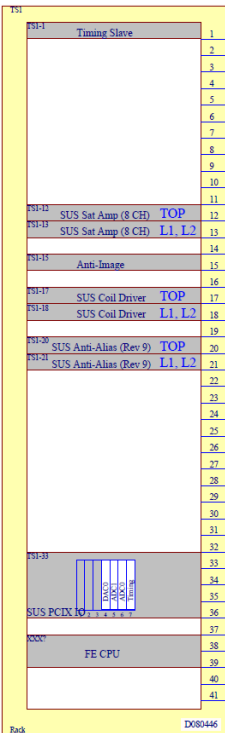

D1000305 AI Chassis

D1000305 SYYYYYYYY

D0902783 AA Chassis

D0902783 SYYYYYYYY

D0902783 AA Chassis

D0902783 SYYYYYYYY

Computer

SN:

I/O Extension

2 ADC

1 DAC

1 Timing Slave

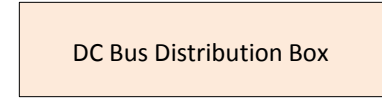

Linksys BEFSX41
Firewall Router



Netgear GS108
Gigabit Switch



iMAC Computer

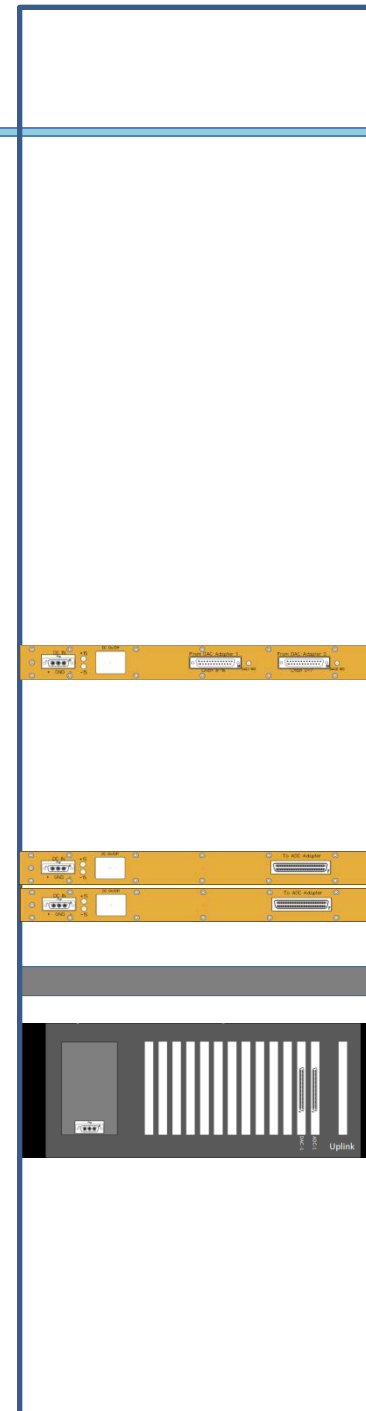
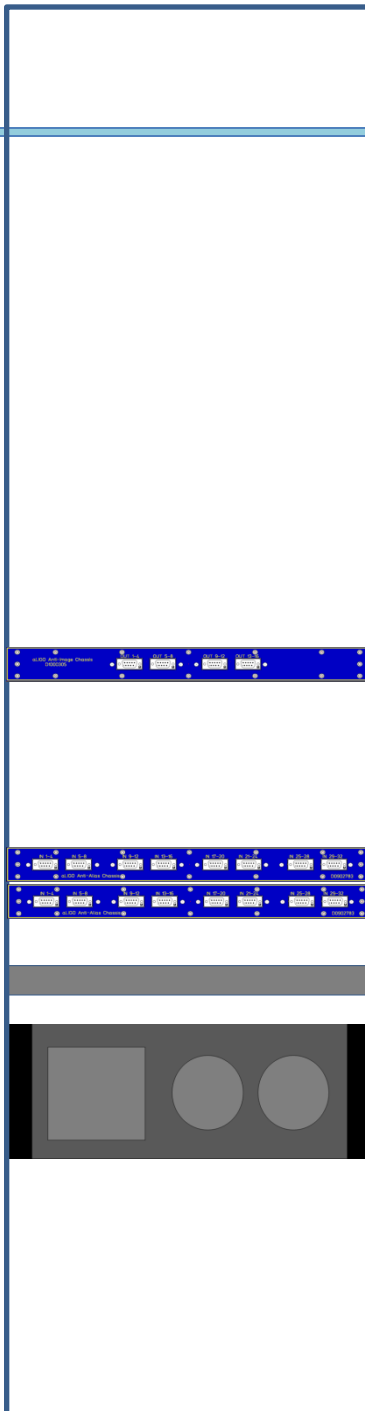

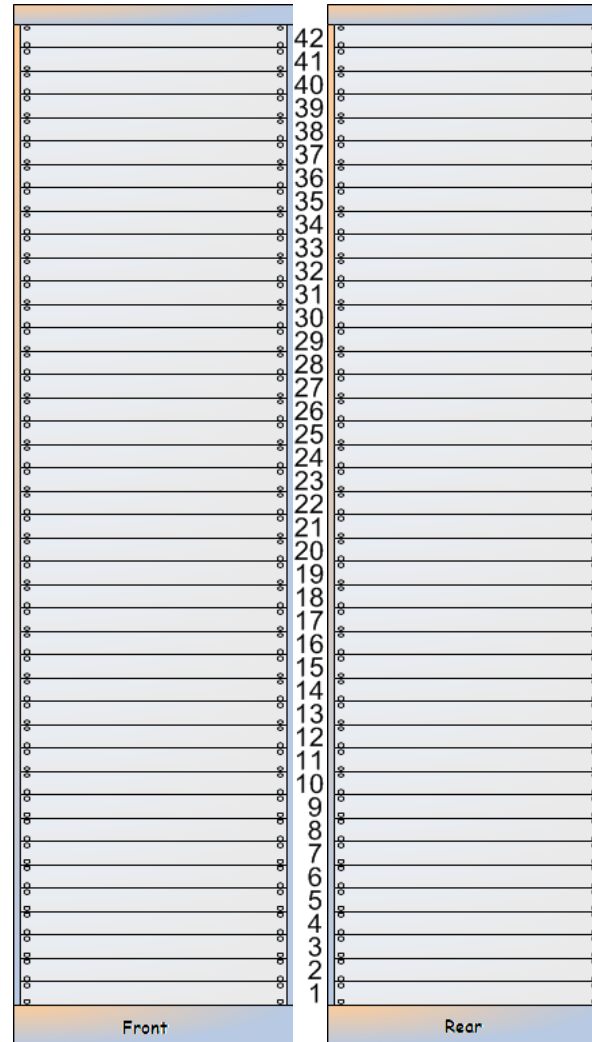

**D070124 Rack Input
Power Box (RU 34-36)**

+18VDC	?A
-18VDC	?A
+24VDC	?A
-24VDC	?A



L1-ETRO5 HAM ISI

L1-ETRO5
Front

L1-ETRO5
Rear

ISI Interface Pod 1 & L4C
ISI Interface Pod 2 & L4C
ISI Interface Pod 3 & L4C

Anti-Alias (AA) Chassis

Anti-Alias (AA) Chassis

Anti-Image (AI) Chassis

ISI Coil Driver (Pod 1 and 2)

ISI Coil Driver (Pod 3)

D1000067 S1000311
D1000067 S1000312
D1000067 S1000314

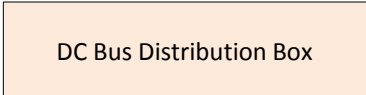

D1000269 S1000244

D1000269 S1000298

D070081 SS1000251

D0902744 S1000317

D0902744 S1000316

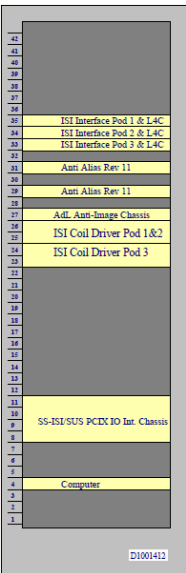

I/O Extension
2 ADC
1 DAC
1 Timing Slave
Computer



SN:

SN:

JQE25-10M +24V
JQE25-10M -24V

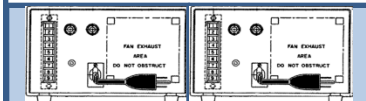
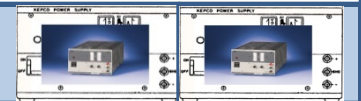

SN:

SN:

JQE25-10M +15V
JQE25-10M -15V

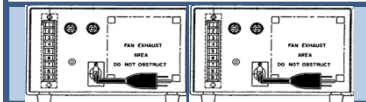
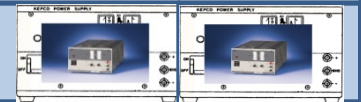

SN:

SN:

iMAC Computer



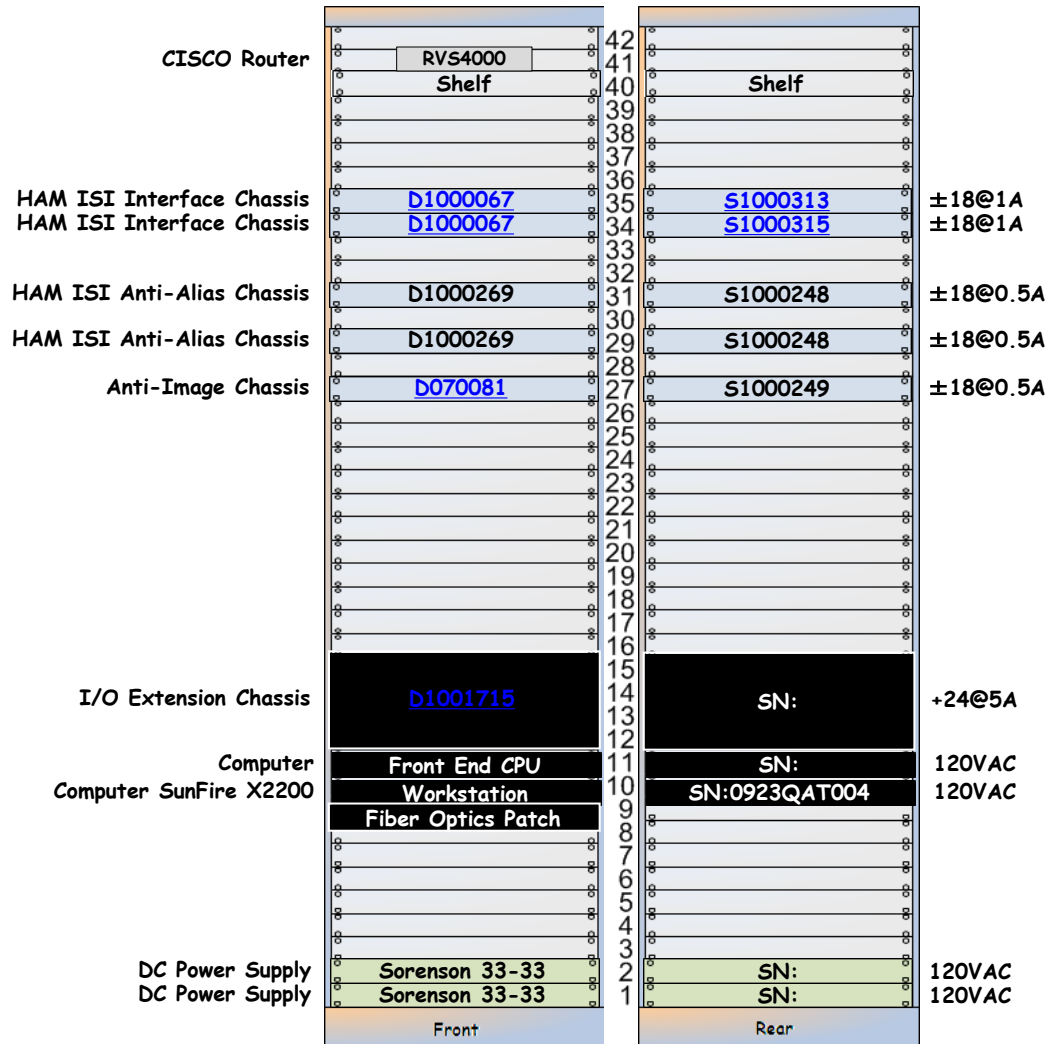

D070124 Rack Input Power Box (RU 34-36)

0 - ADC0
1 - DAC0
2 - ADC1

+18VDC	?A
-18VDC	?A
+24VDC	?A
-24VDC	?A

L1-ETRO6
Front

L1-ETRO6
Rear

ISI Interface Pod 1 & L4C
Pod 2 & L4C
Pod 3 & L4C

DXXXXXXXX SYYYYYYYY
DXXXXXXXX SYYYYYYYY
DXXXXXXXX SYYYYYYYY

DC Bus Distribution Box

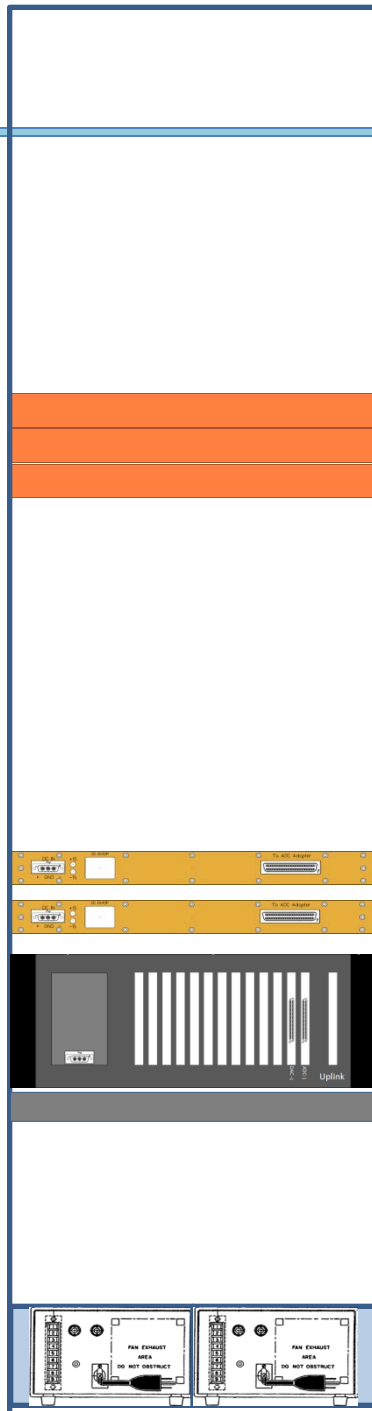
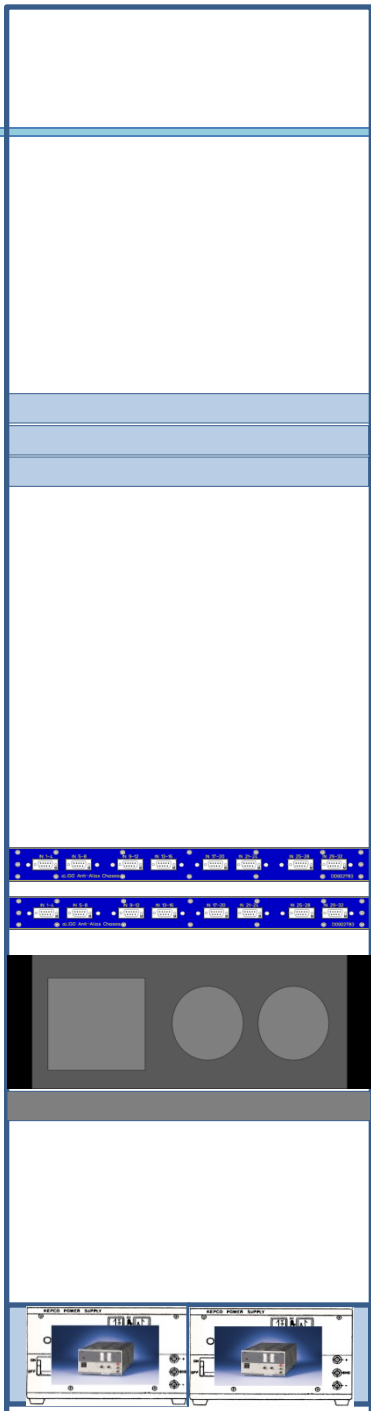
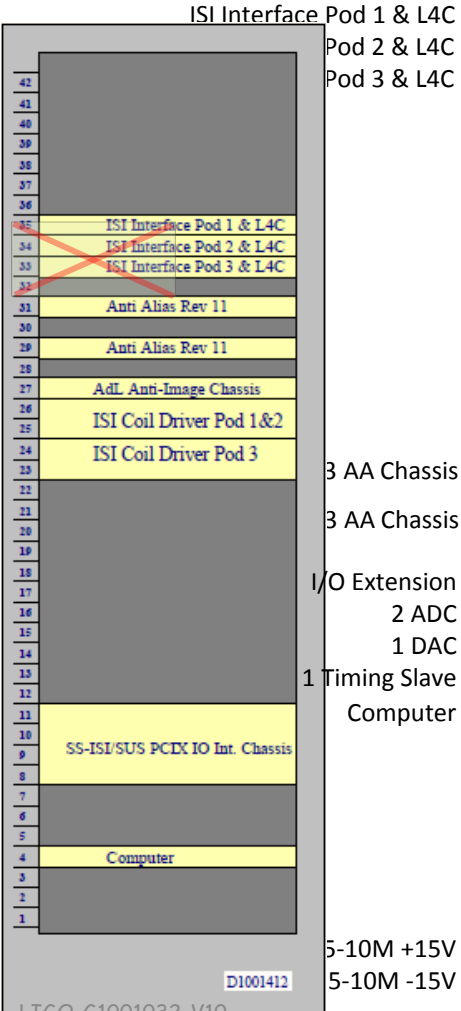

D0902783 SYYYYYYYY
D0902783 SYYYYYYYY

Linksys BEFSX41
Firewall Router

SN:

Netgear GS108
Gigabit Switch

SN:

iMAC Computer

SN:

Triple SUS Test Rack Layout ([D1001624](#) [S1106460](#))

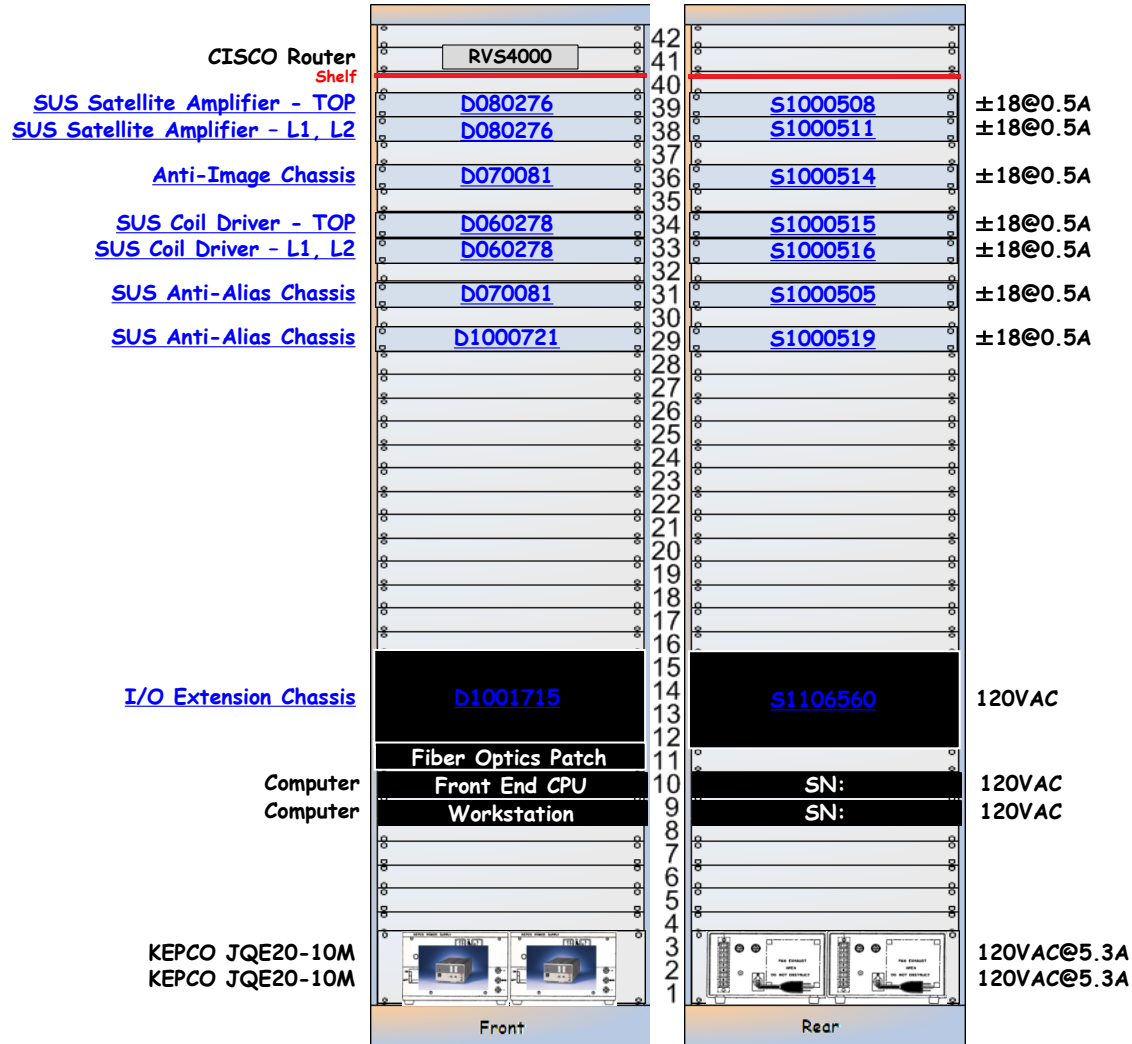

D070124 Rack Input Power Box (RU 34-36)

0 - ADC0
1 - DAC0
2 - ADC1

UM (Top)

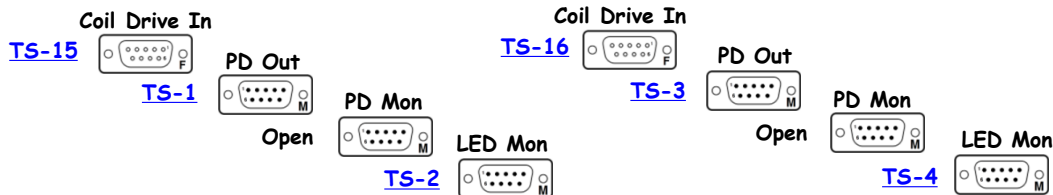

IM (L1), BM (L2)

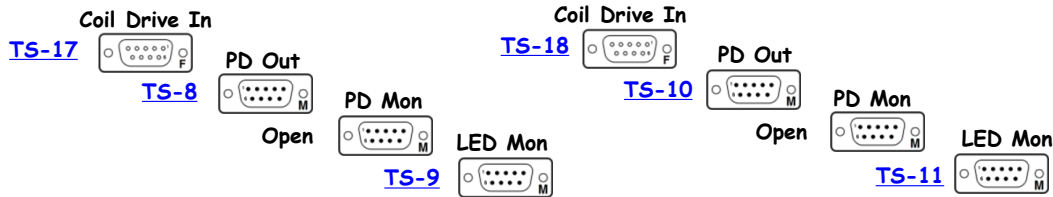

Anti-Image Chassis D070081 S1000514 ±18@0.5A

UNBUFFERED

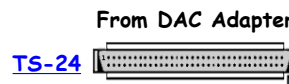
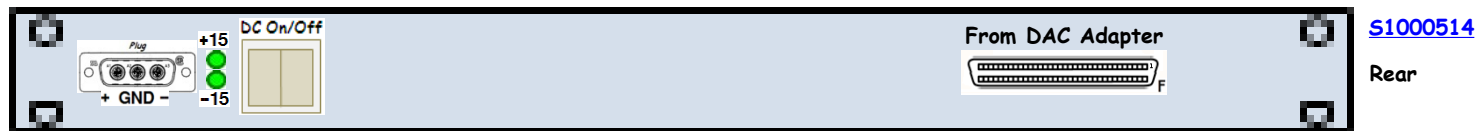

UM (Top)

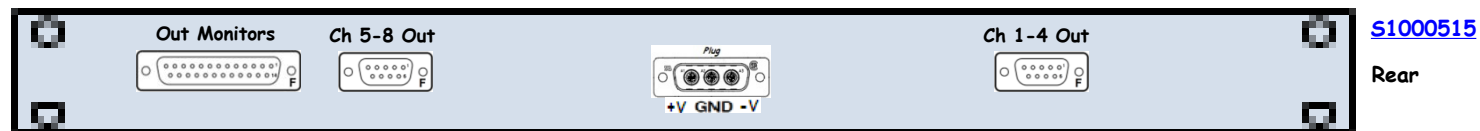
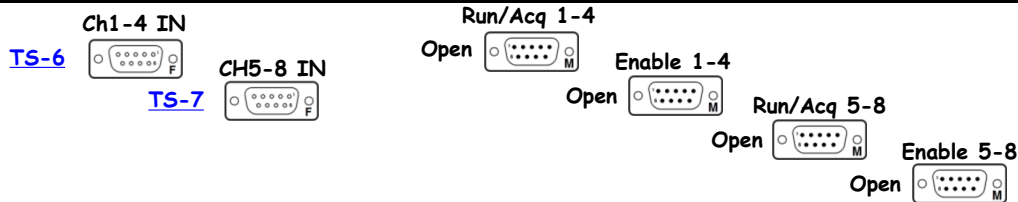
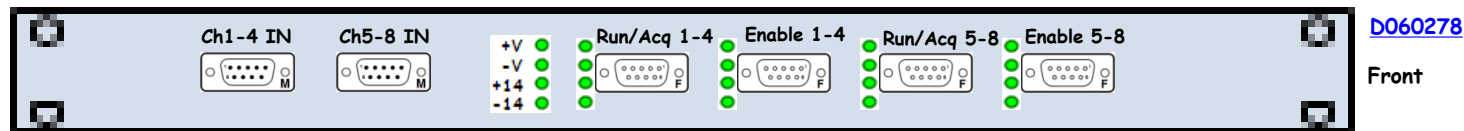

IM (L1), BM (L2)

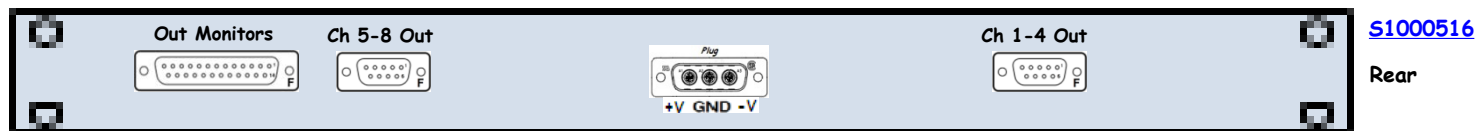
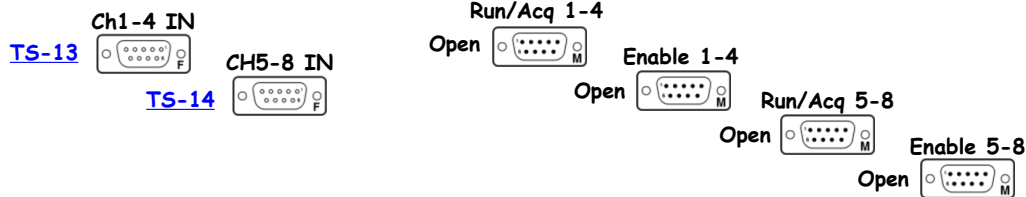
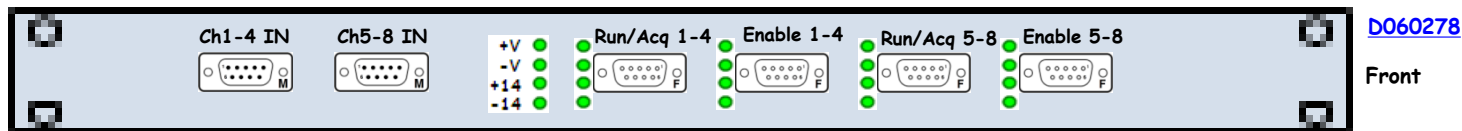

<< L1-ETR-07

SUS Anti-Alias Chassis D070081 S1000505 ±18@0.5A

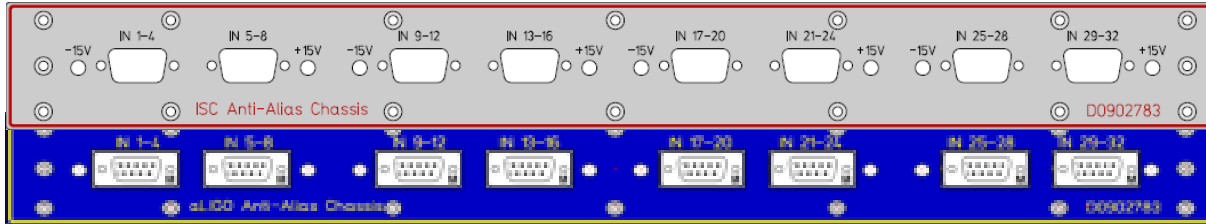

D0902783

Front

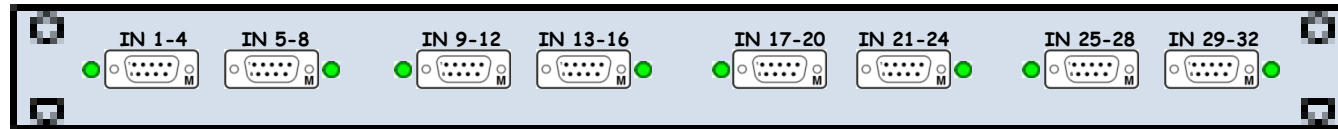

D070081

Front

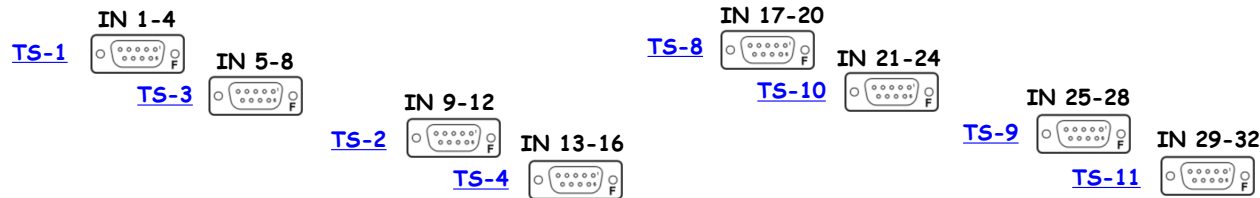

S1000505

Rear

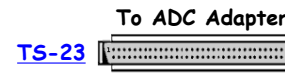

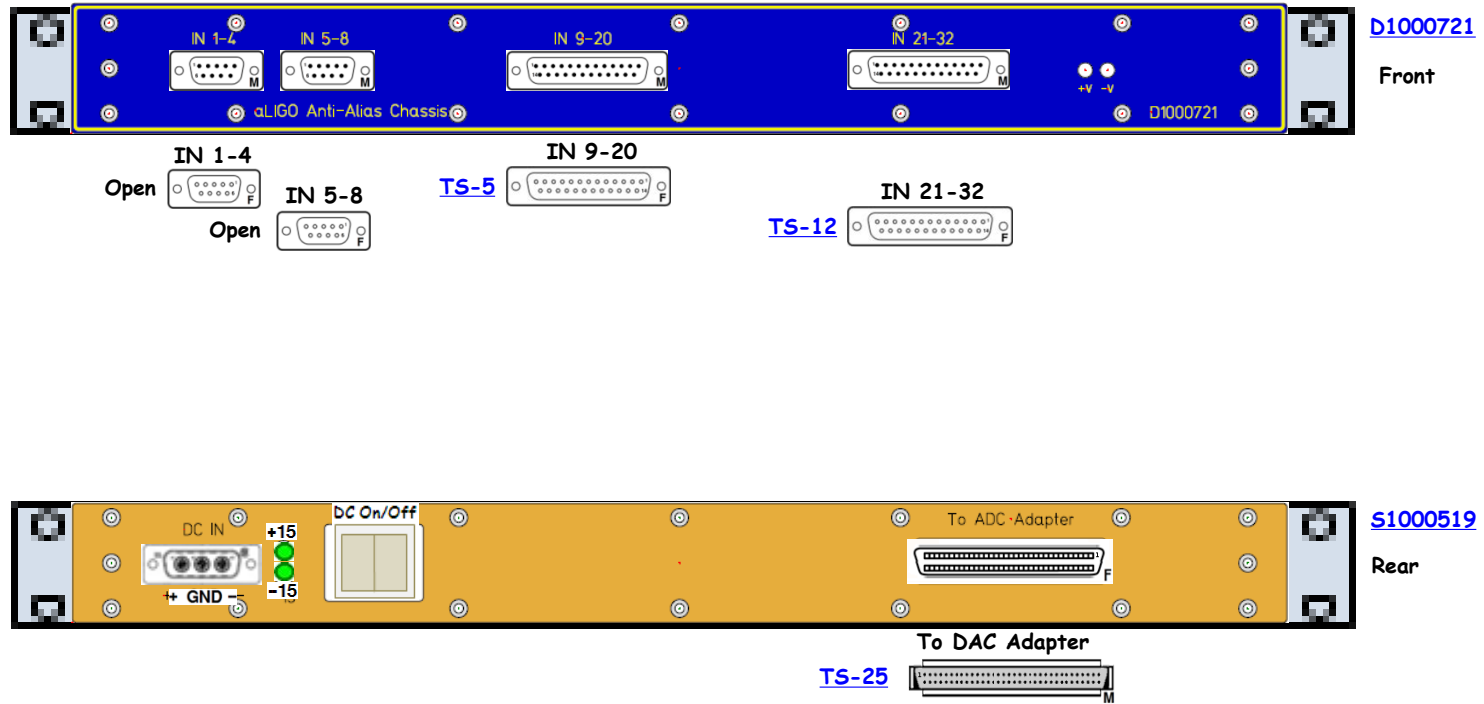



D1001715

Front

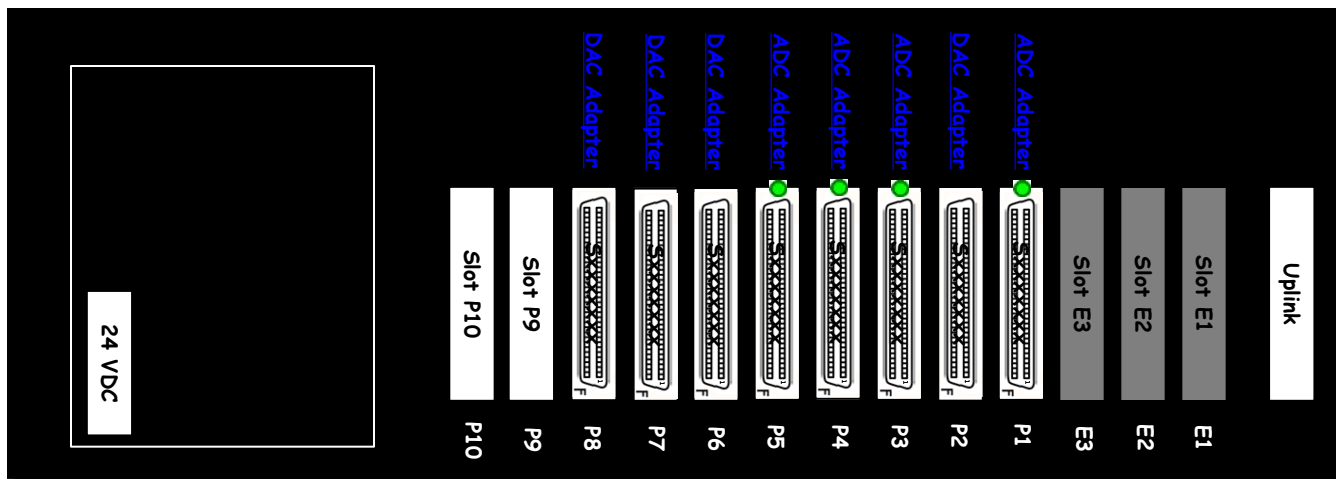

S1106560

Rear

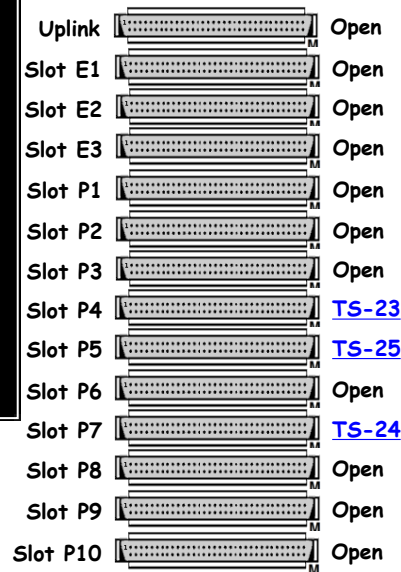

Templates

D070124 Rack Input
Power Box (RU 34-36)

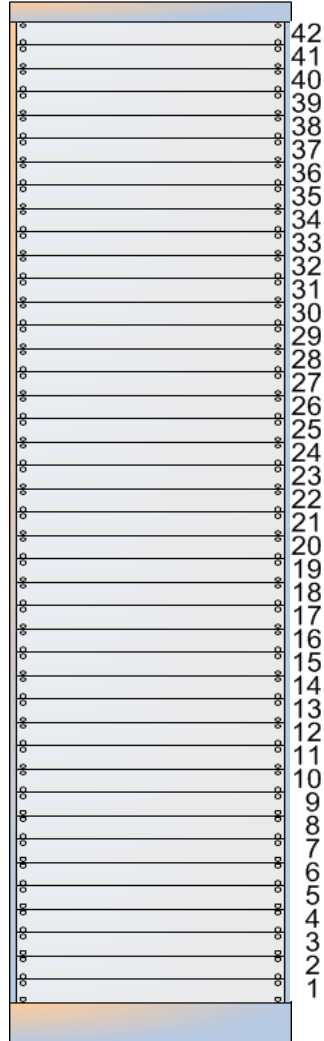
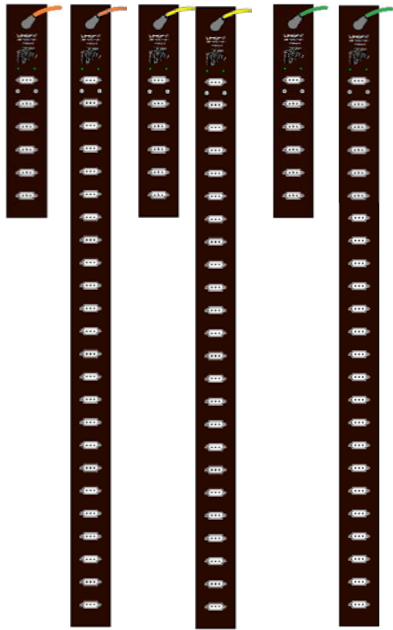

Description **Dxxxxxxx** **SN:** Power

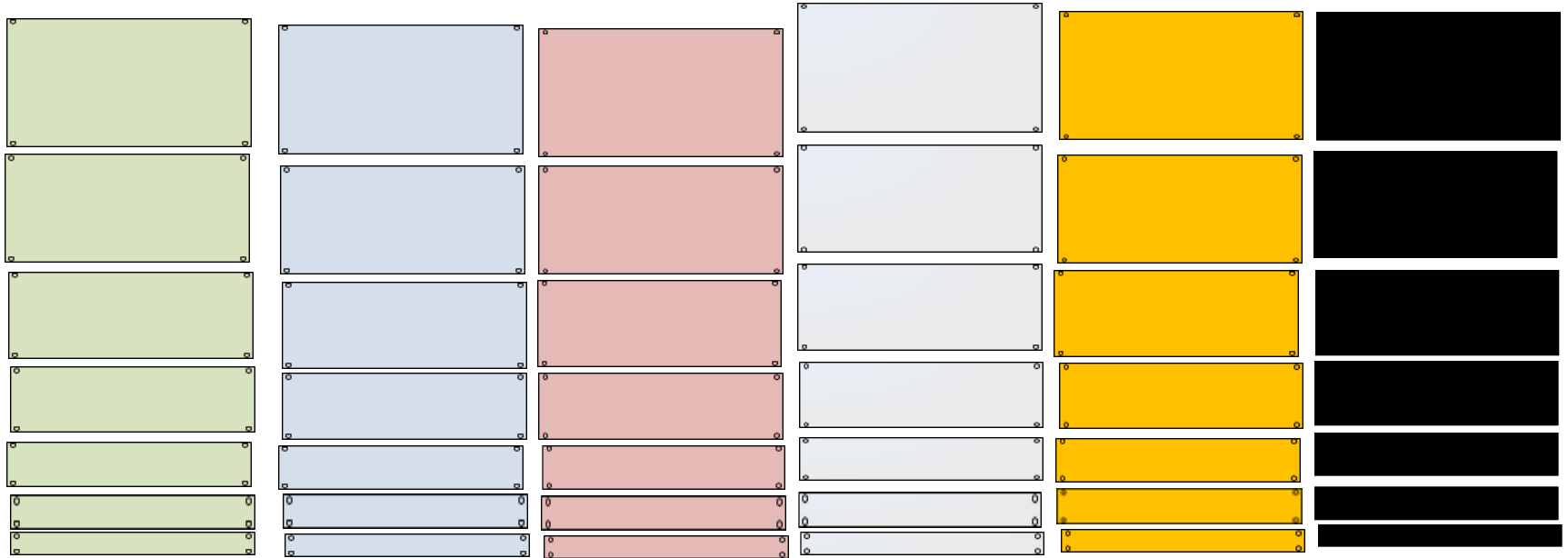

Description **Dxxxxxxx** **SN:** Power

Description

Description

Description

Description

Description

Description

Description

Description **Dxxxxxxx** **SN:** Power



Description

Description

Shelf

DE-9

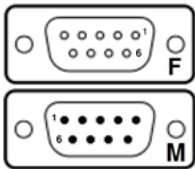

DA-15

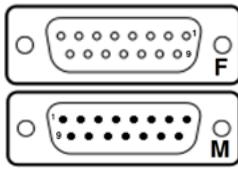

DB-25

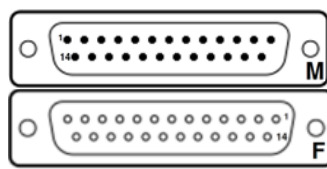

DC-37

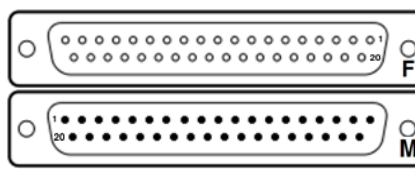

DD-50

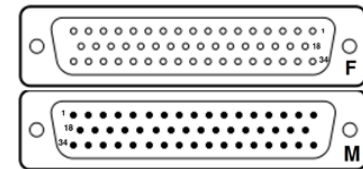

CP-4

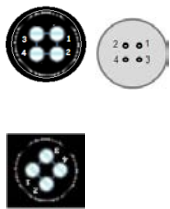

LEMO 2-Pin

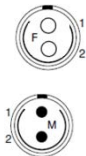

LEMO 4-Pin

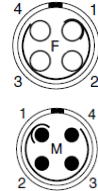

Conec

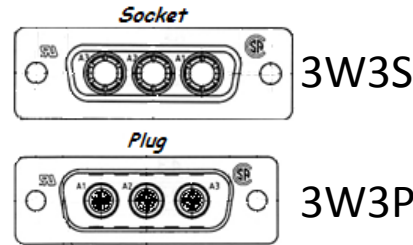

SCSI-68

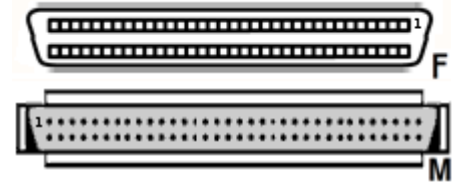

BNC

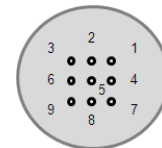

Conec

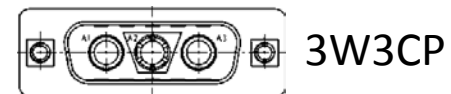
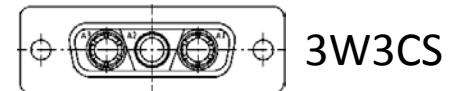
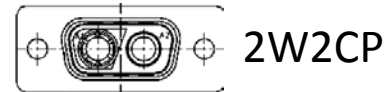
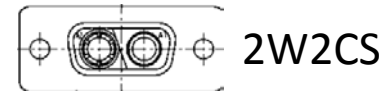
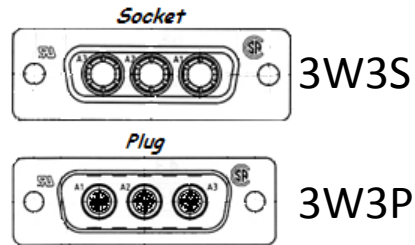

CP-4

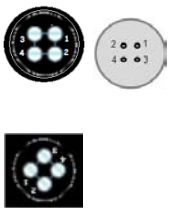

LEMO 2-Pin

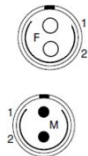

LEMO 4-Pin

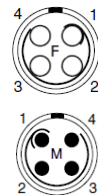

+V -V Layouts

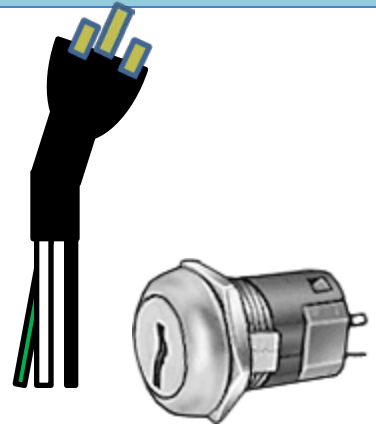
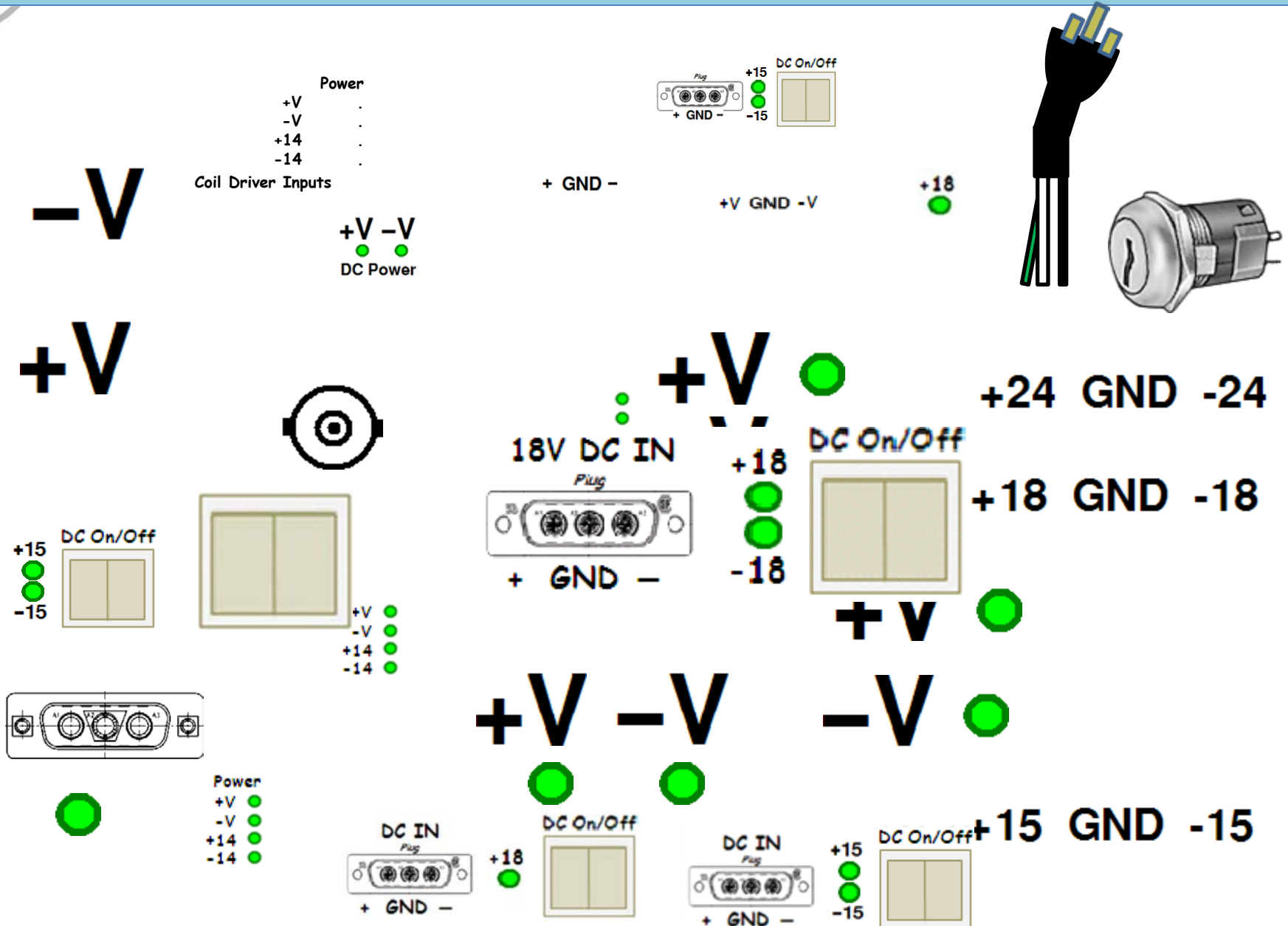

+V -V Layouts

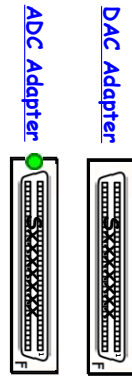

+V -V Layouts

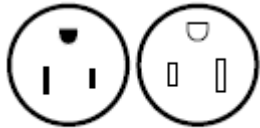

125 VAC, 15 Amps

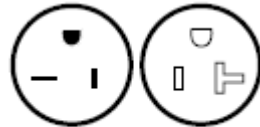

125 VAC, 20 Amps

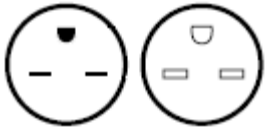

250 VAC, 15 Amps

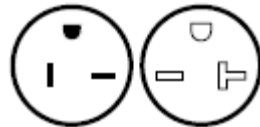

250 VAC, 20 Amps



L6-30R L6-30P

VOLTAGE	NEMA	15 AMPERE		20 AMPERE		30 AMPERE		50 AMPERE		60 AMPERE	
		Receptacle	Plug	Receptacle	Plug	Receptacle	Plug	Receptacle	Plug	Receptacle	Plug
125 V	1	1-15R	1-15P								
250V	2		2-15P	2-20R	2-20P	2-30R	2-30P				
125V	5	5-15R	5-15P	5-20R	5-20P	5-30R	5-30P	5-50R	5-50P		
250V	6	6-15R	6-15P	6-20R	6-20P	6-30R	6-30P	6-50R	6-50P		
277V, A.C.	7	7-15R	7-15P	7-20R	7-20P	7-30R	7-30P	7-50R	7-50P		
125/ 250V	10			10-20R	10-20P	10-30R	10-30P	10-50R	10-50P		
3Ø 250V	11	11-15R	11-15P	11-20R	11-20P	11-30R	11-30P	11-50R	11-50P		
125/ 250V	14	14-15R	14-15P	14-20R	14-20P	14-30R	14-30P	14-50R	14-50P	14-60R	14-60P
3Ø 250V	15	15-15R	15-15P	15-20R	15-20P	15-30R	15-30P	15-50R	15-50P	15-60R	15-60P
3ØY 120/208V	18	18-15R	18-15P	18-20R	18-20P	18-30R	18-30P	18-50R	18-50P	18-60R	18-60P

24VAC Power
To Camera

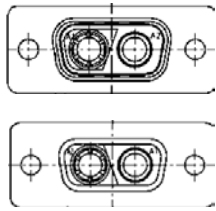

A1 = Black
A2 = White(Y) Red(X)

24VAC



110VAC

Signals To
Camera

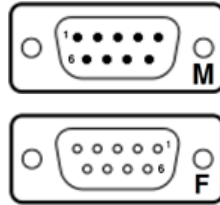

- 1 =
- 2 =
- 3 =
- 4 =
- 5 =
- 6 =
- 7 =
- 8 =
- 9 =

75 Ohm Signal
from Camera

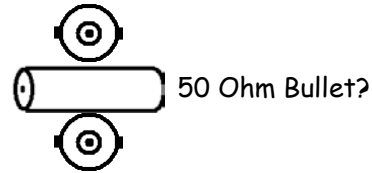

50 Ohm Bullet?

Type N



Interface

12VDC

Fiber Optics Connector Types



FC Ferrule Connector or Fiber Channel



ST / BFOC Straight Tip / Bayonet Fiber Optic Connector



LC Lucent Connector, or Little Connector, or Local Connector



SC Subscriber Connector or square connector or Standard Connector

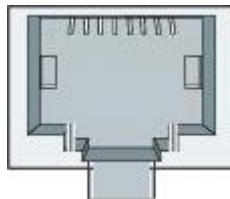
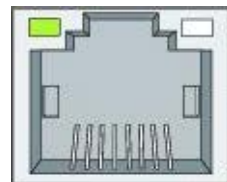

How Rack Documents Relate

