

This document and the design it covers are the property of PARSONS. They are loaned only with the borrower's expressed written agreement that they will not be reproduced, copied, loaned, exhibited, or used in any other way, except by written consent from PARSONS to the borrower.

This document and the design it covers are the property of PARSONS. They are loaned only with the borrower's expressed written agreement that they will not be reproduced, copied, loaned, exhibited, or used in any other way, except by written consent from PARSONS to the borrower.

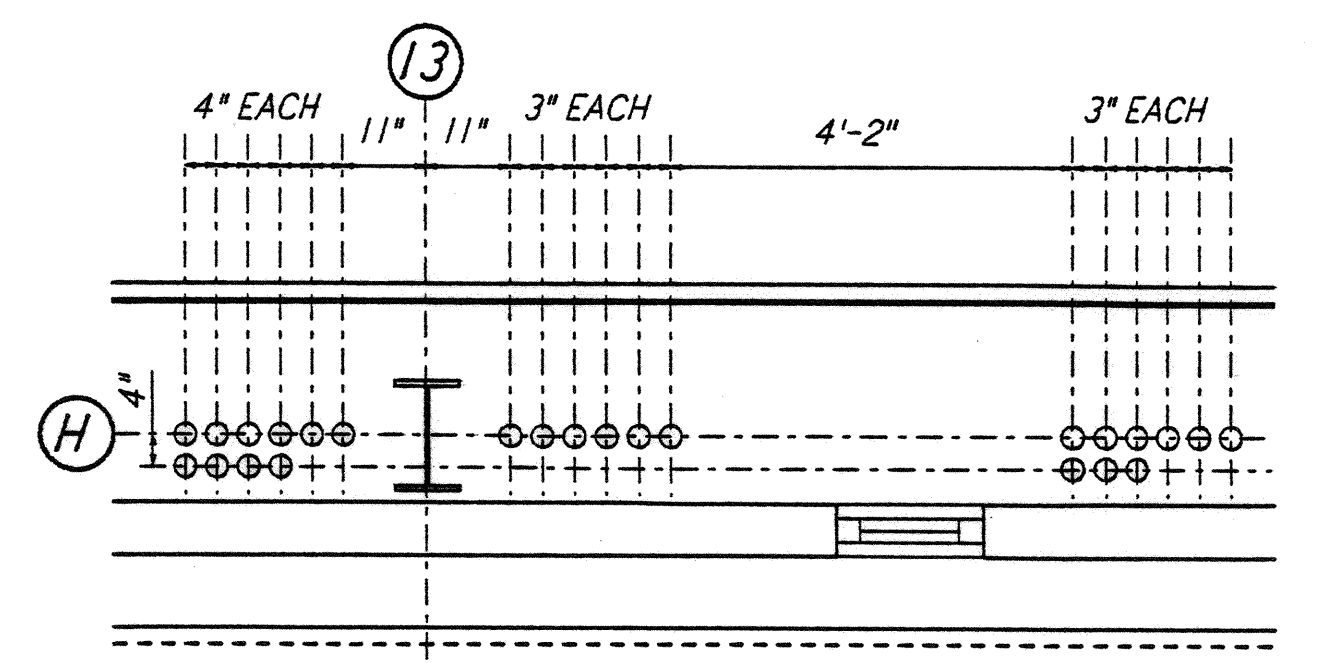
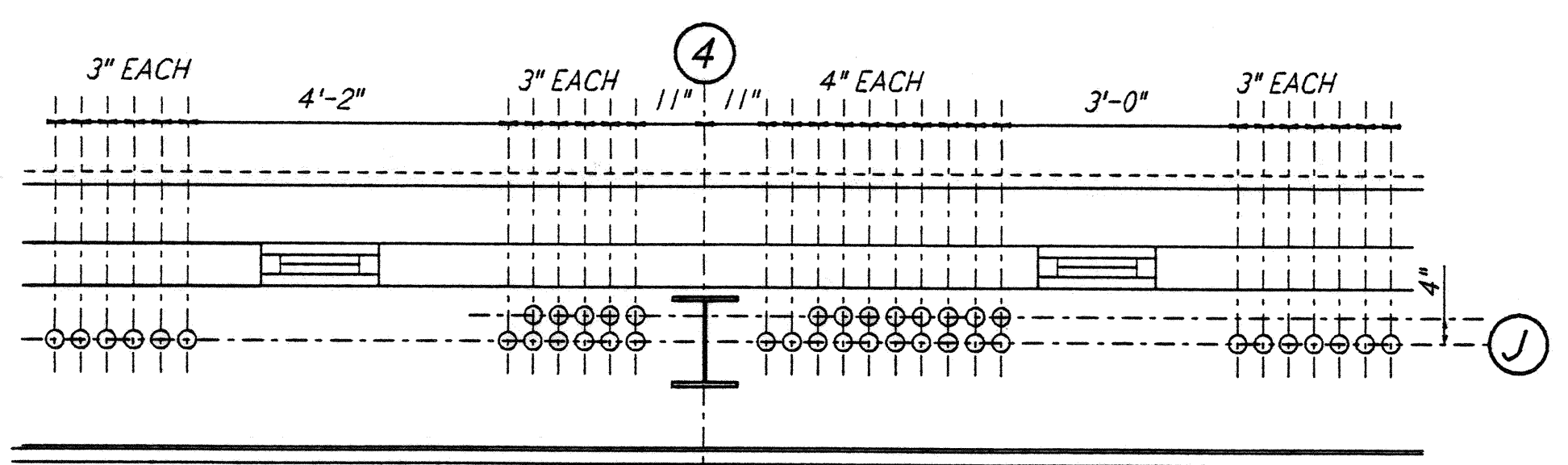
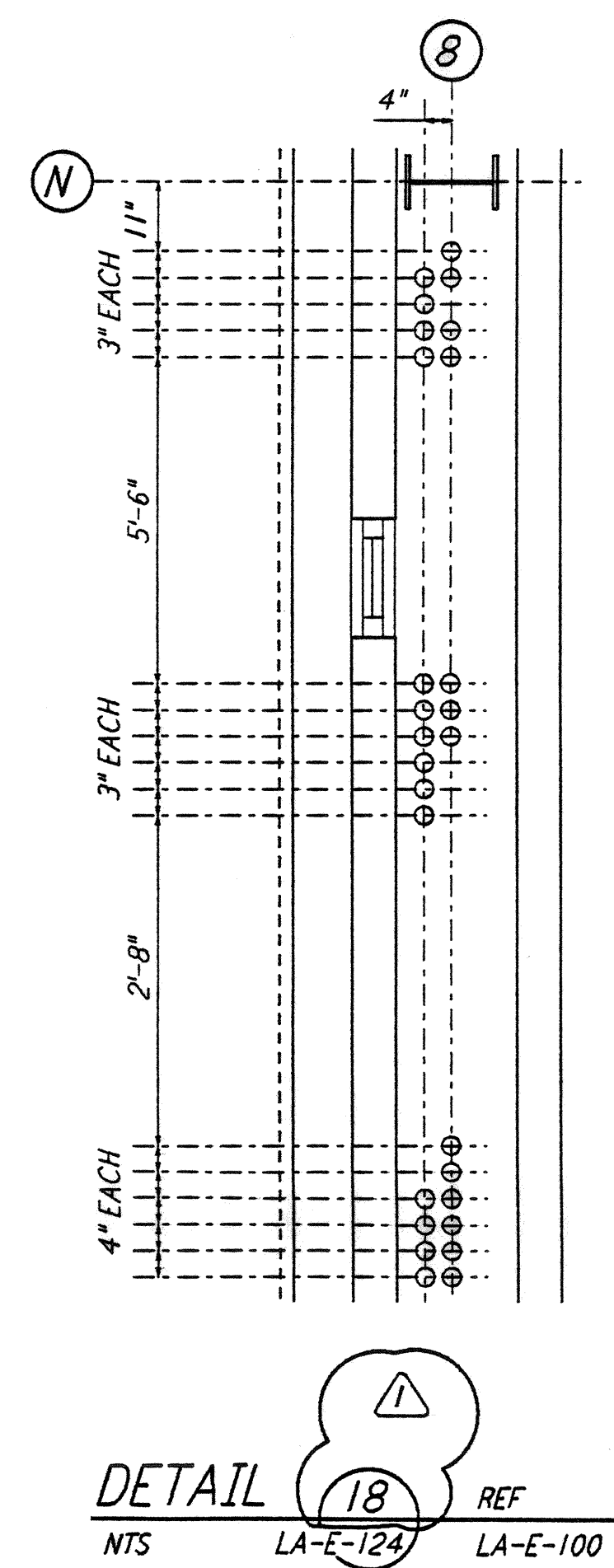
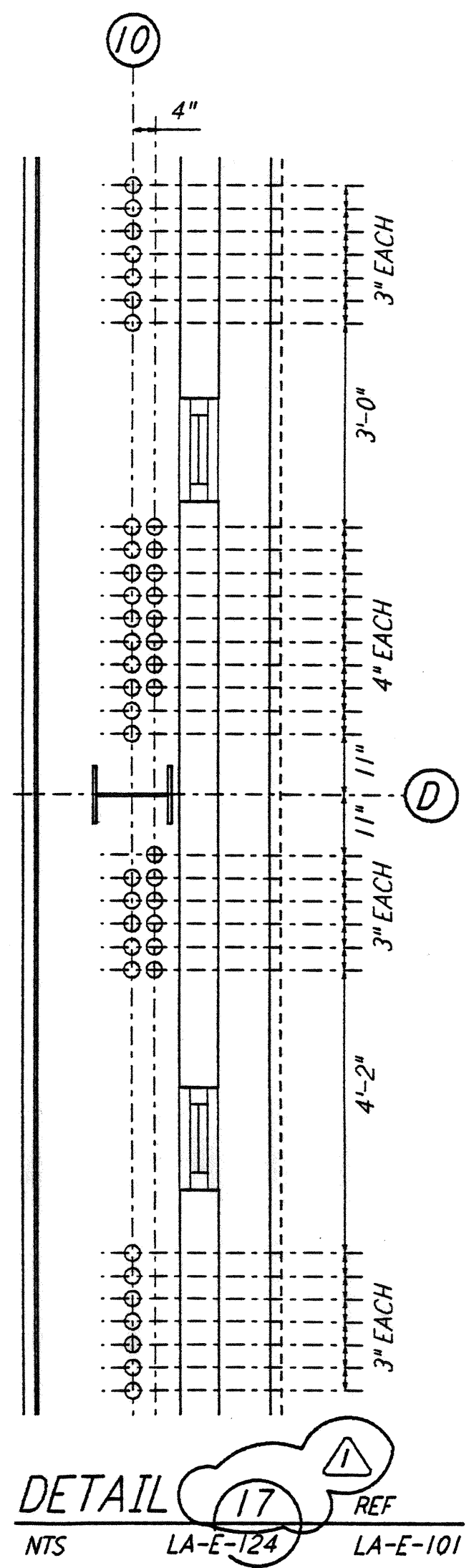
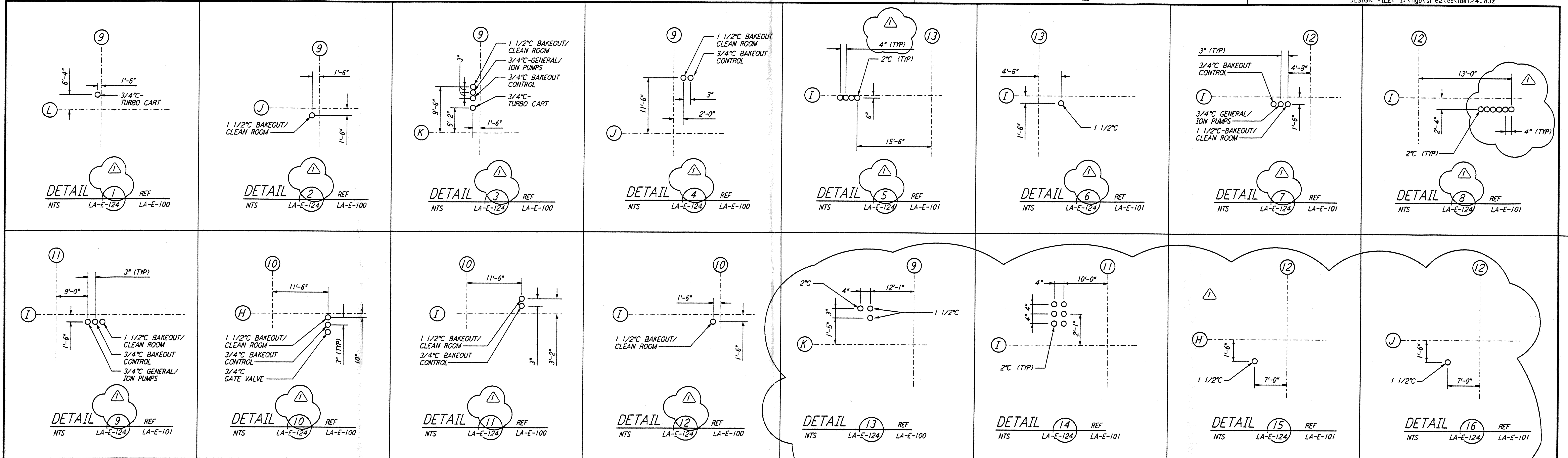

NOTE: THE DETAILS ON SHEETS LA-E-123, LA-E-124 AND LA-E-125 SUPERSEDE, ENTIRELY THE DETAILS ON SHEET LA-E-114

NO.	DATE	BY	CHKD	ENGR	PROJ	DESCRIPTION
1	4-4-97	J. G.				GENERAL REVISIONS

ISSUED FOR CONSTRUCTION
 DRAWN J. G. 3-21-97
 CHECKED B. K. 3-21-97
 ENGINEER K. C. R. 3-21-97
 PROJ T. D. M. 3-21-97

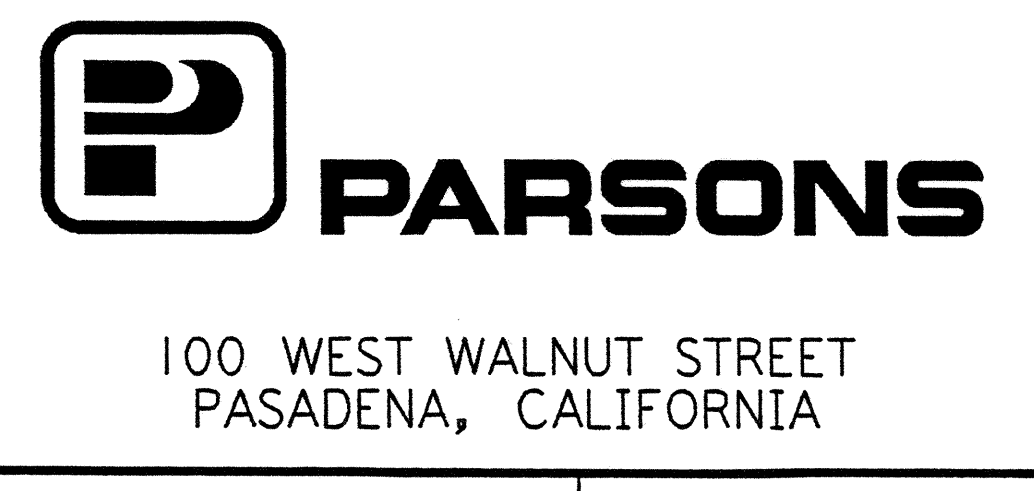
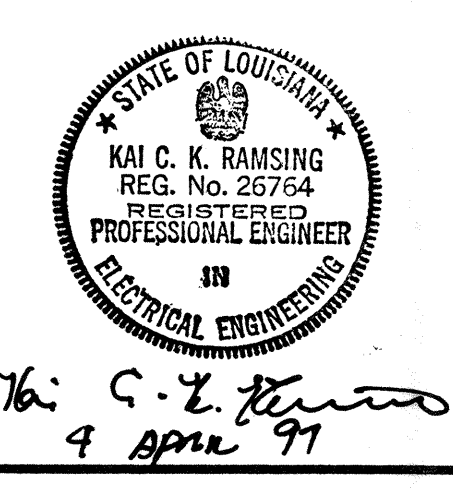

LIGO-D961480-01-0
 LASER INTERFEROMETER GRAVITATIONAL-WAVE OBSERVATORY
 SITE NO. 2 - LIVINGSTON, LOUISIANA
 TITLE: ELECTRICAL CORNER STATION LVEA AREAS 101, 102, 103, 104 DETAILS
 SCALE: NONE
 CONTRACT NUMBER: PP150969
 PROJECT NUMBER: 8094
 SHEET NUMBER: LA-E-124
 REVISIONS: