

187

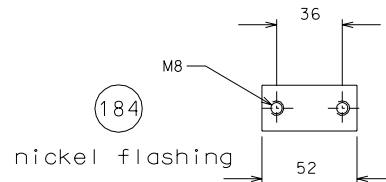

184

nickel flashing

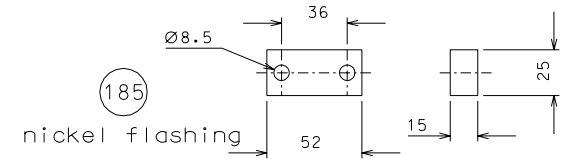
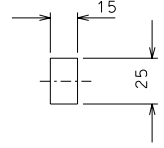

185

nickel flashing

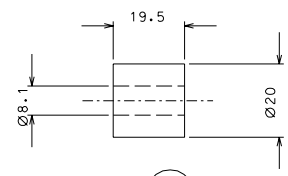

190

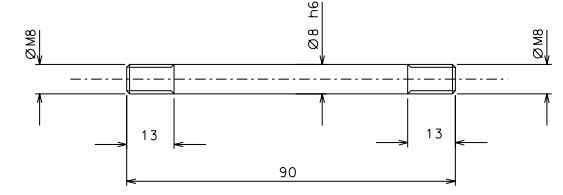

188

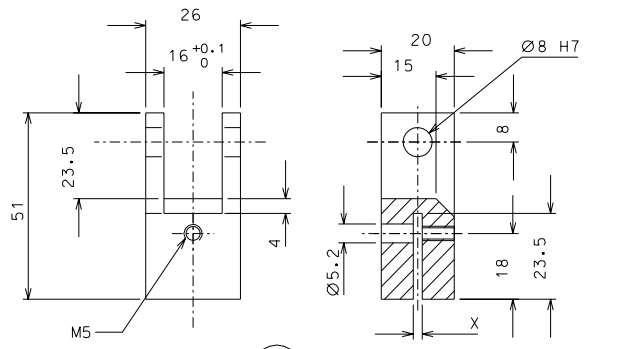

183 nickel flashing

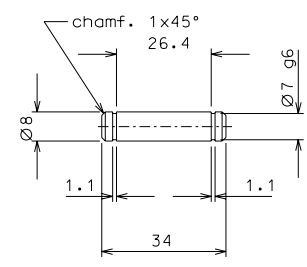

181

ref.	note	date	signature
modifications			
187	2 EN 6082	1/2	
185	2 Fe 360	1/2	
184	2 Fe 360	1/2	
183	2 Fe 360	1/1	190 12 EN 6082 1/1
181	4 inox	1/1	188 10 inox 1/1
ref.	pieces	mat. and treatments	scale

General machining tolerances UNI 5307-63								
Dimensions	< 6	> 6-30	> 30-120	> 120-315	> 315-1000	> 1000-2000	> 2000-4000	> 4000
linear Toli.	± 0.1	± 0.2	± 0.3	± 0.5	± 0.8	± 1.2	± 2	± 3
angular Toli.	± 1'	± 30'	± 20'	± 10' referred to the shortest side				
designed for							R.De Salvo	
draw. by							G. Gennaro-PROMECC	
date							29-10-05	
scale							1/2	
title							HAM-OPTICAL BENCH	
LARGE BLADE TOOL							LIGO-D051182-00-D	
date ¹ from							180	
							A 2	