

aLIGO HAM-ISI, BSC-ISI, HAM-HEPI and BSC-HEPI matrices

The purpose of the change of basis matrices is to combine local instruments to sense (or drive) the platforms rigid body motions along the axis of the interferometer (in other work they align the sensing basis of each platform with the axis of the interferometer)

The local sensors of a given set of instruments are typically noted H1, H2, H3, V1, V2 ,V3, standing for Horizontal 1 to 3 and Vertical 1 to 3*

The translation and rotations along the axis of the interferometer are noted X,Y,Z, RX,RY,RZ.

The objectives of this document are:

- To describe the instruments location and orientation**
- To define which scripts have been used to calculate the change of basis matrices (must define clear location in the svn)**
- List the matrices values (for each of the two possible platform orientations)**
- Specify where the matrices are stored in the svn and the Structures names**
- Specify which scripts to use to load the matrices (populate...)**

*** HEPI sets of 8 instruments noted H1, H2, H3, H4, V1, V2 ,V3, V4 and BSC-ISI Stage 1 T240 set is made of 9 signals noted X1, Y1, Z1, X2, Y2, Z2, X3, Y3, Z3.**

Table of contents

1) Instruments location and orientation – Page 3

2) Change of basis calculation and scripts – Page 9

3) Matrices Values – Page 21

HAM-ISI – Page 26

BSC-HEPI – Page 31

HAM-HEPI – Page 35

BSC-ISI – Page 41

Appendix 1: Translation between new and former naming convention – page 56

Appendix 2: Transfer Functions to highlights the instruments signs – Page 57

1) Instruments location and orientation

1.0) Modules Orientation

(See G1000125 for mode details)

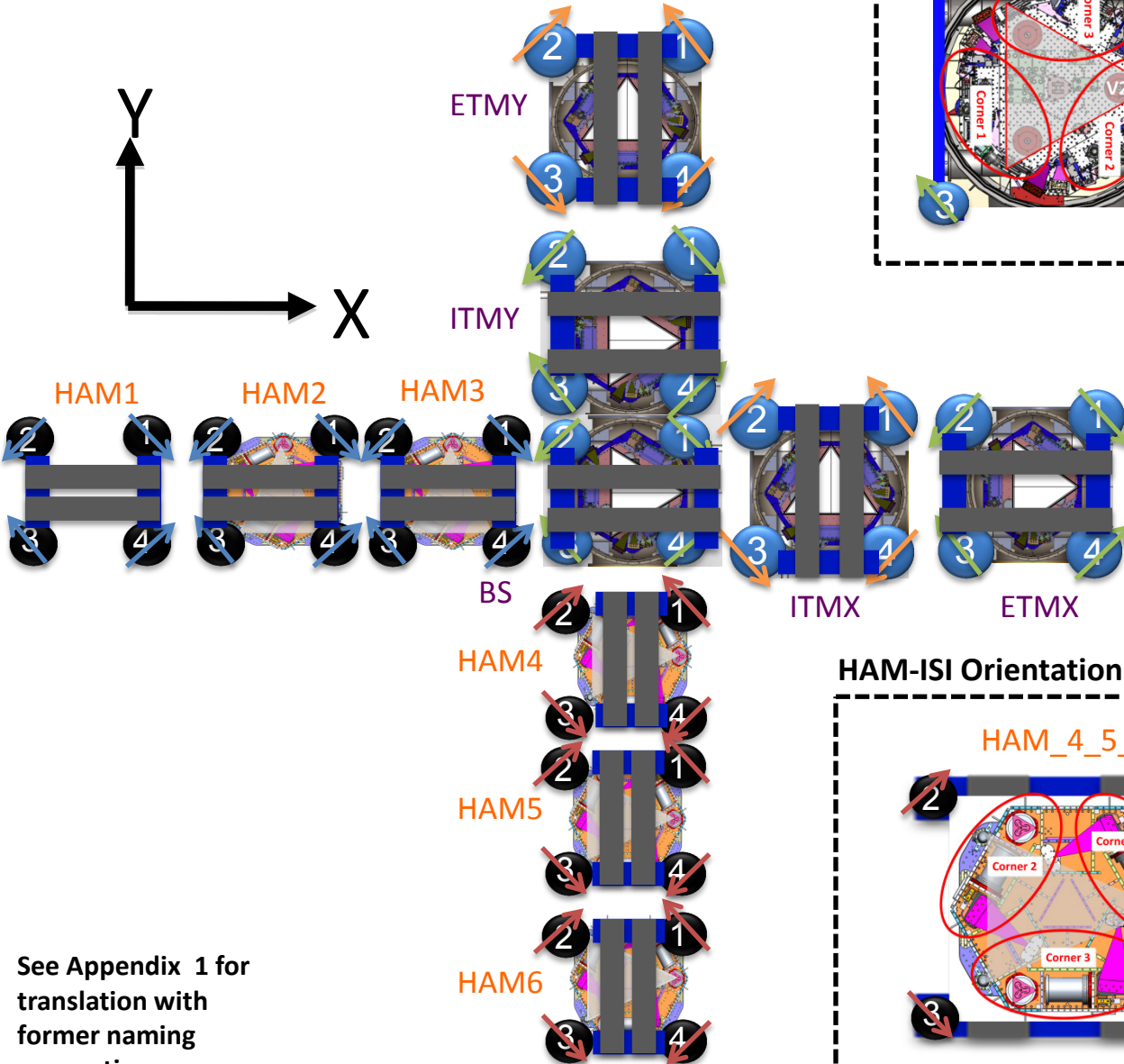
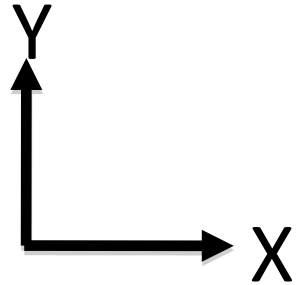

BSC-ISI Orientation.

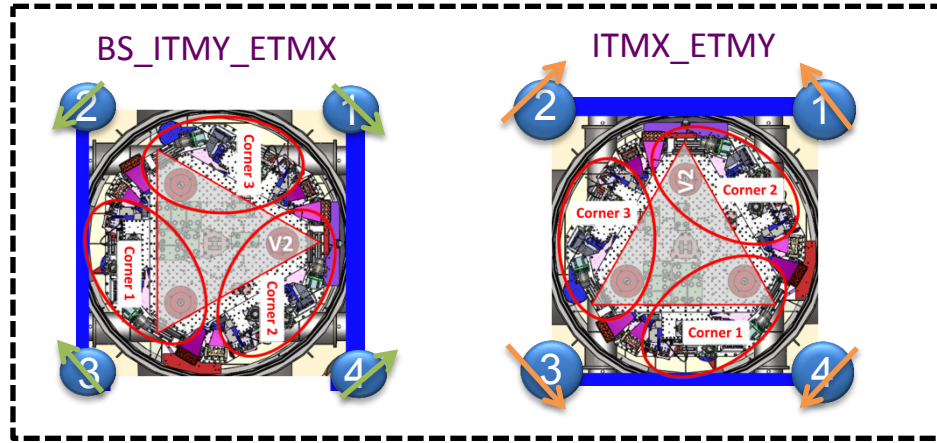

HEPI Orientation.

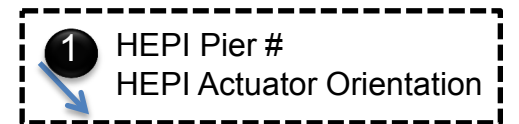

HAM-ISI Orientation.

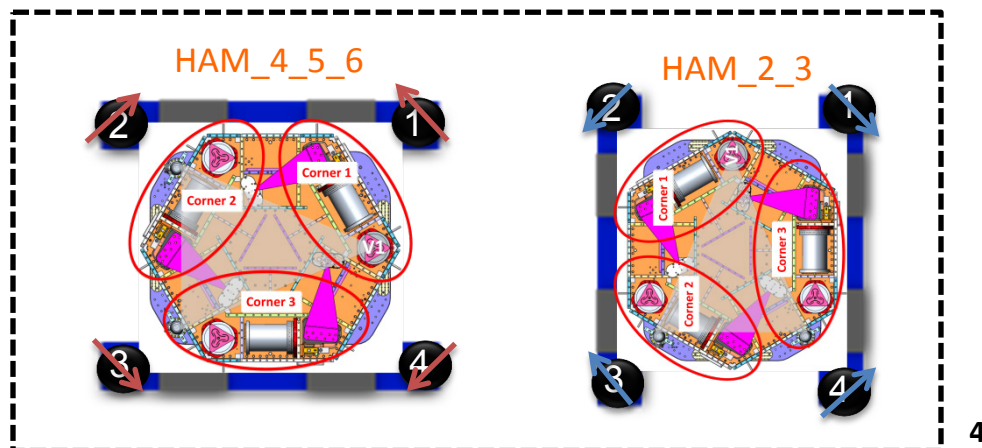

See Appendix 1 for translation with former naming convention.

Summary of Position Sensors signal “sign”:

- HAM-HEPI: **Positive RZ** motion of HEPI Stage makes **+H1, -H2, +H3 and -H4 IPS signals*** for HAM 4,5,6
 - HAM-HEPI: **Positive RZ** motion of HEPI Stage makes **-H1, +H2, -H3 and +H4 IPS signals*** for HAM 1,2,3
 - HAM-ISI: **Positive RZ** motion of Stage 1 makes **negative CPS signals*** for all chambers
 - BSC-HEPI: **Positive RZ** motion of HEPI Stage makes **+H1, -H2, +H3 and -H4 IPS signals*** for ITMX, ETMY BSC
 - BSC-HEPI: **Positive RZ** motion of HEPI Stage makes **-H1, +H2, -H3 and +H4 IPS signals*** for BS, ITMY, ETMX
 - BSC-ISI: **Positive RZ** motion of Stage 1 makes **negative CPS signals*** for all chambers
 - BSC-ISI : **Positive RZ** motion of Stage 2 makes **positive CPS signals*** for all chambers
- HAM-HEPI, BSC-HEPI, HAM-ISI, BSC-ISI:

Positive Z motion makes **positive PS signal in all local vertical sensors*** (for all stages & all chambers)

These signs are checked during the assembly and testing process by pushing on the moving stages and watching the local sensors readouts. The position sensors are then used during the commissioning process to verify and correct if necessary the sign of all other instruments (actuators, geophones and seismometers)

***as read on the IN1 channel of the input filters**

Details about horizontal HAM-ISI Instruments coordinates

- The coordinate system's origin is aligned with the horizontal actuators plane.
- Positive RZ motion of Stage 1 makes negative local CPS signals. (Sensor is on Stage 0, target is on Stage 1, +RZ motion of stage 1 closes the gap.) The CPS sensors direction vectors are therefore negatively-oriented tangents as shown by the green arrows in the figure in the left. (-60 degrees angle in Corner 1)
- For the calculation of the actuators matrices, it is assumed that each actuator is in the same orientation as its local CPS. If a local to local transfer function* shows otherwise, the actuator sign would be corrected in the "symetrization" filter located in the actuator's output filter bank.
- For the calculation of the GS13 matrices, it is assumed that each GS13 instrument is in the same orientation as its local CPS and actuator (+270 degrees phase at low frequency). If the local to local transfer function* shows otherwise, the GS13 instrument sign would be corrected in the "symetrization" filter located in the GS13 input filter bank.
- For the calculation of the L4C matrices, it is assumed that the L4Cs are in the same orientation as the CPS, actuators, and GS13's (tangent oriented negatively as shown by the green arrows). If the local to local transfer function* shows otherwise, the L4C instrument sign would be corrected in the "symetrization" filter located in the L4C input filter bank.

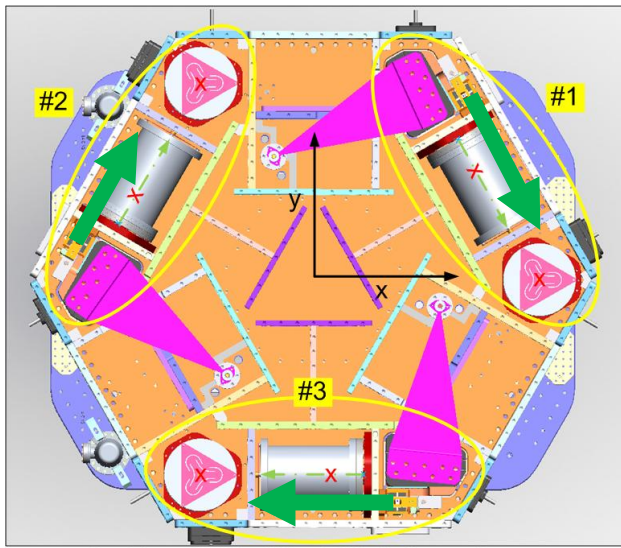

Stage 1 Sensors GS-13 H and V, Stage 0-1 H Position Sensors and Actuators

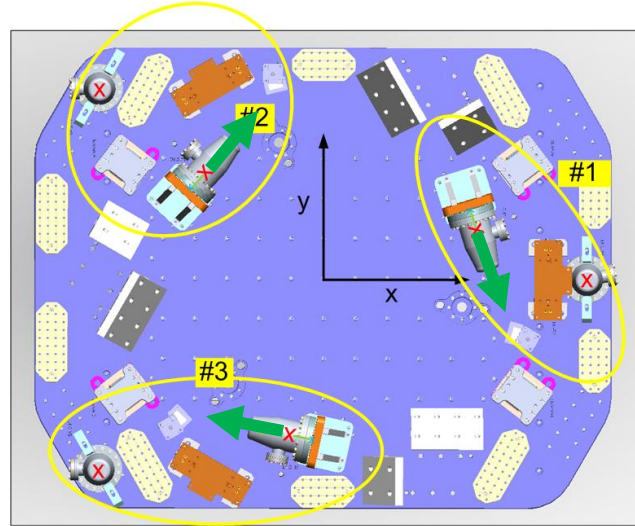

Stage 0 Sensors L4-C H and V, Stage 0-1 V Position Sensors and Actuators

* Local to local transfer function: from local actuator "Exc channel" to "IN1 channel" in the local sensor input filter's. Only the "Comp filter" must be engaged in the actuator bank (to partially revert the coil driver and actuator frequency response). See example in appendix 2.

aLIGO HAM-ISI Sensors & Actuators Location

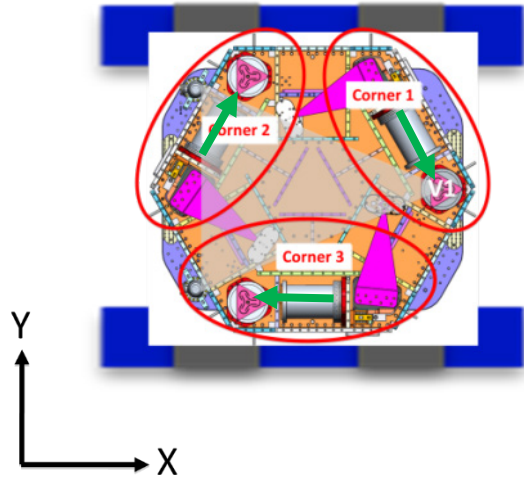

HAM_4_5_6 instruments location and direction:

Sensor	X [m]	Y [m]	Z [m]	Direction
Actuator H1	0.52342	0.64154	0.00000	-60 deg to X
Position sensor H1	0.53071	0.66058	-0.20358	-60 deg to X
GS-13 H1	0.58849	0.33960	-0.03334	-60 deg to X
L4-C H1	0.48582	0.14852	-0.40043	-72.5 deg to X
Actuator V1	0.71120	0.00000	-0.38119	0 deg to Z
Position sensor V1	0.64703	-0.18553	-0.39402	0 deg to Z
GS13 V1	0.78740	0.00000	-0.04272	0 deg to Z
L4C V1	0.83502	0.00000	-0.41821	0 deg to Z
L4C V2	0.71120	0.60325	-0.41821	0 deg to Z
L4C V3	-0.71120	-0.60325	-0.41821	0 deg to Z

Note that L4C V1, V2 and V3 are not 120 degrees apart and not on the same radius.

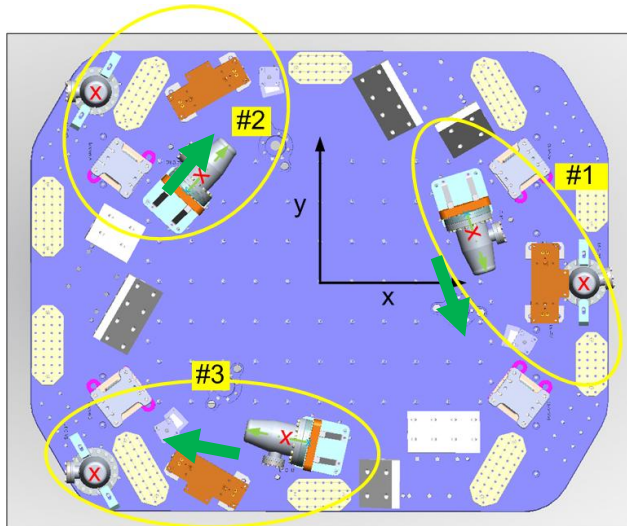

Stage 0 Sensors L4-C H and V, Stage 0-1 V Position Sensors and Actuators

Notes: HAM 4,5,6 table orientation used for reference. All measurements originated at the center point of the Optics Table on the optics mounting side. The measurement termination locations are as follows: x,y,z center point (origin) of the Actuator field assembly; center point of the face of the Displacement Sensor Target closest to the Sensor; values for seismometers are taken at the approximate center of mass of the proof mass based on SW models (red center points or X)

1.2) aLIGO BSC-ISI Sensors & Actuators

- The coordinate system's origin of Stage 1 is aligned with the Stage 1 horizontal actuators plane located (8.995" above the optical table).
- The coordinate system's origin of Stage 2 is aligned with the Stage 2 horizontal actuators plane (7.188" above the optical table).
- Positive RZ motion of Stage 1 makes negative local CPS signals*. The CPS sensors direction vectors are therefore negatively-oriented tangents as shown by the green arrows in the figure in the left.
- Positive RZ motion of Stage 2 makes positive local CPS signals**. The CPS sensors direction vectors are therefore positively-oriented tangents as shown by the green arrows in the figure in the left.
- For the calculation of the actuators matrices, it is assumed that each actuator is in the same orientation as its local CPS. If a local to local transfer function* shows otherwise, the actuator sign would be corrected in the "symetrization" filter located in the actuator's output filter bank.
- For the calculation of the GS13 and L4C matrices, it is assumed that each instrument is in the same orientation as it local CPS and actuator. If the local to local transfer function* shows otherwise, the instrument sign would be corrected in the "symetrization" filter located in the input filter bank.
- For the calculation of the T240 matrices, it is assumed that the X1 is in the same orientation as the CPS, and that Y1 points radially outward. If the local to local transfer function* shows otherwise, the Linstrument sign would be corrected in the "symetrization" filter located in the input filter bank.

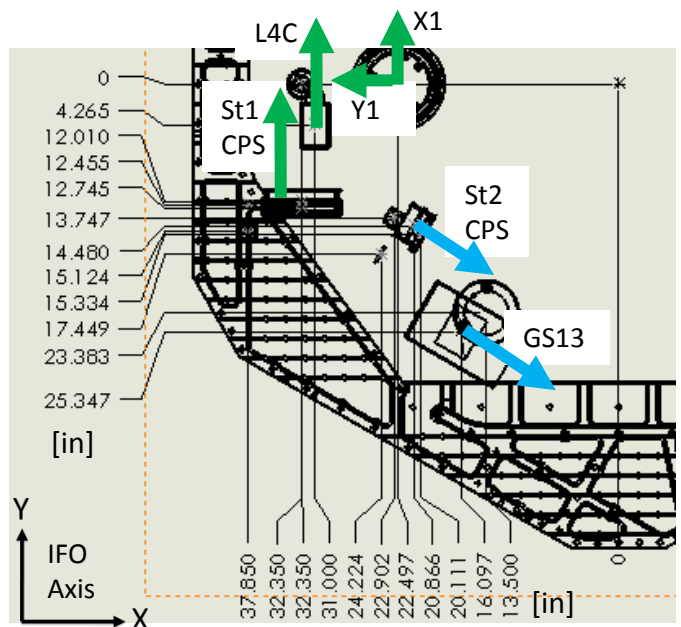

* Positive Stage 1 RZ motion makes negative CPS signal in all three corners. (Sensor on Stage 0, target on Stage 1, +RZ closes the gap and reduces the signal). This is true for both orientations.

** Positive Stage 2 RZ motion makes positive CPS signal in all three corners. (Sensor on Stage 1, target on Stage 2, +RZ opens the gap and increases the signal). This is true for both orientations.

1.2) aLIGO BSC-ISI Sensors & Actuators

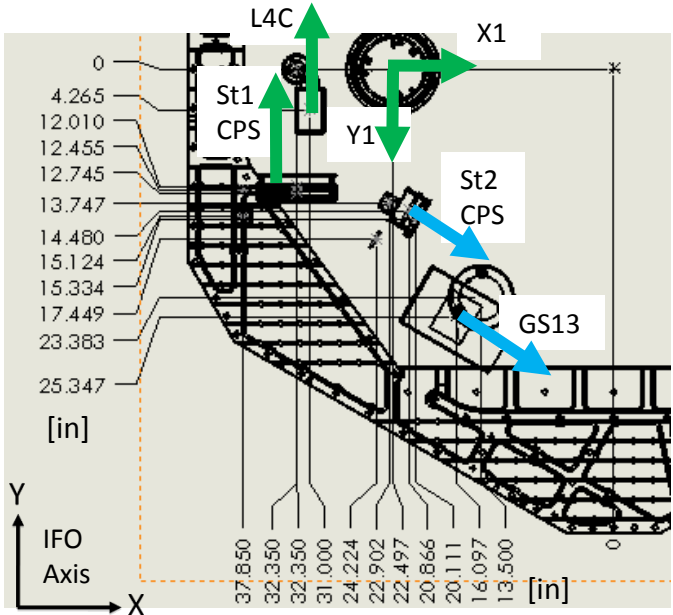

BS, ITMY, ETMX instruments location and direction:

	X [m]	Y [m]	Z [m]	Direction	Notes
Stage 0-1 Act H1	-0.8217	-0.3051	0.0000	90 deg to X	Center Bobbin
Stage 0-1 CPS H1	-0.9614	-0.3164	0.0603	90 deg to X	Center Face of sensor
T240 (X1,Y1,Z1)	-0.5714	0.0000	0.1160	-90 deg to X	Center XY, Z-TBD
L4C H1	-0.7874	-0.1083	0.0600	90 deg to X	Center
Stage 0-1 Act V1	-0.8217	-0.3237	0.2221	0 deg to Z	Center Bobbin
Stage 0-1 CPS V1	-0.9614	-0.3841	0.2108	0 deg to Z	Center Face of sensor
L4C V1	-0.8217	0.0000	0.3855	0 deg to Z	Center
Stage 1-2 Act H1	-0.5300	-0.3678	0.0000	-30 deg to X	Center Bobbin
Stage 1-2 CPS H1	-0.6153	-0.4432	0.0714	-30 deg to X	Center Face of sensor
GS13 H1	-0.4089	-0.6438	0.0432	-30 deg to X	CG
Stage 1-2 Act V1	-0.5108	-0.3895	0.1667	0 deg to Z	Center Bobbin
Stage 1-2 CPS V1	-0.5817	-0.3492	0.1608	0 deg to Z	Center Face of sensor
GS13 V1	-0.3429	-0.5939	0.3694	0 deg to Z	CG

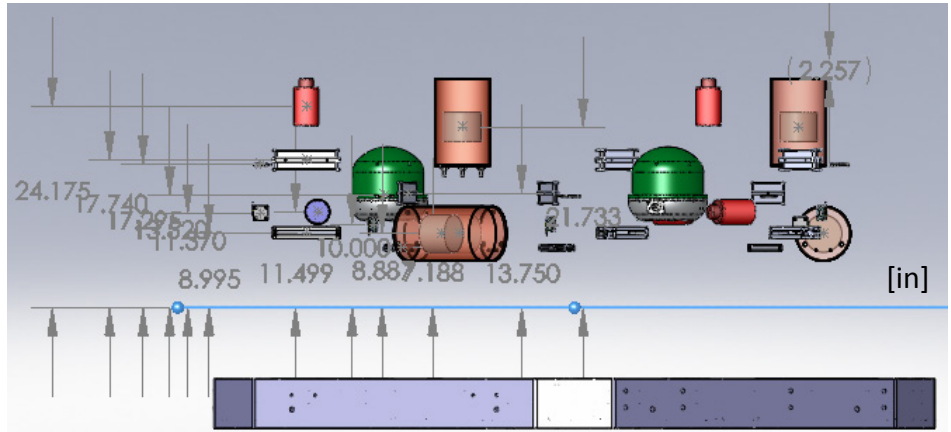
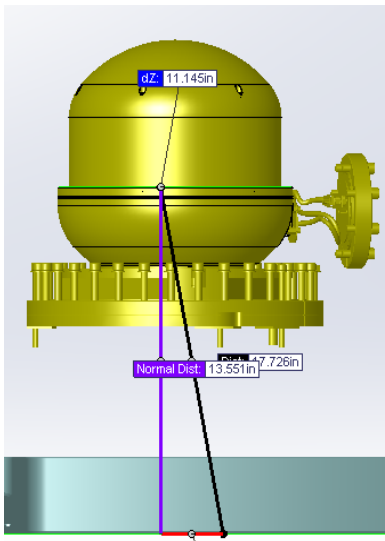

T240 center is about 13.551" above the optical table, that is 4.556" above the Stage 1 Actuator Plane, that is 0.116 m above the Stage 1 Actuator Plane.

1.3) aLIGO HAM-HEPI Sensors & Actuators

HAM4,5,6 instruments location and direction:

Sensor	X [m]	Y [m]	Z [m]	Angle
Actuator H1	1.628	.730	0	119 deg to X
Position sensor H1	1.641	.707	0	119 deg to X
L4-C H1	1.554	.864	0	119 deg to X
Actuator V1	1.554	.864	-0.083	0 deg to Z
Position sensor V1	1.554	.864	-0.122	0 deg to Z
L4C V1	1.554	.864	0.149	0 deg to Z

Coordinate system's origin is aligned with horizontal actuators plane

For the Ham 4,5,6 chambers, **Positive RZ motion makes +H1, -H2, +H3 and -H4 IPS signals.**

For the calculation of the actuators matrices, **it is assumed that each actuator is in the same orientation as its local IPS.** If a local to local transfer function shows otherwise, the actuator sign would be corrected in the "symetrization" filter located in the actuator's output filter bank.

For the calculation of the L4C matrices, **it is assumed that the L4Cs are in the same orientation as the CPS.** If the local to local transfer function shows otherwise, the L4C instrument sign would be corrected in the "symetrization" filter located in the L4C input filter bank.

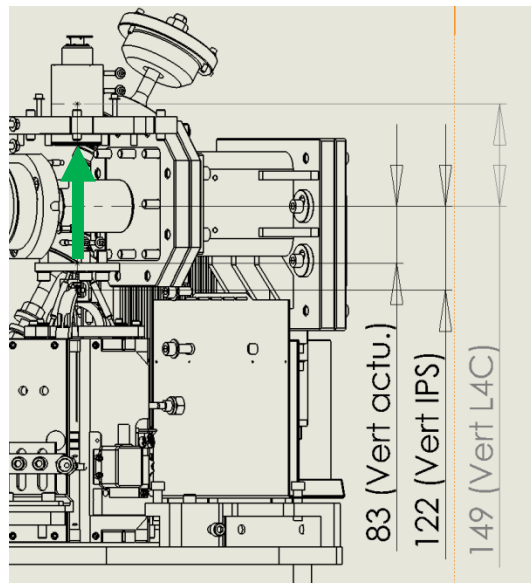
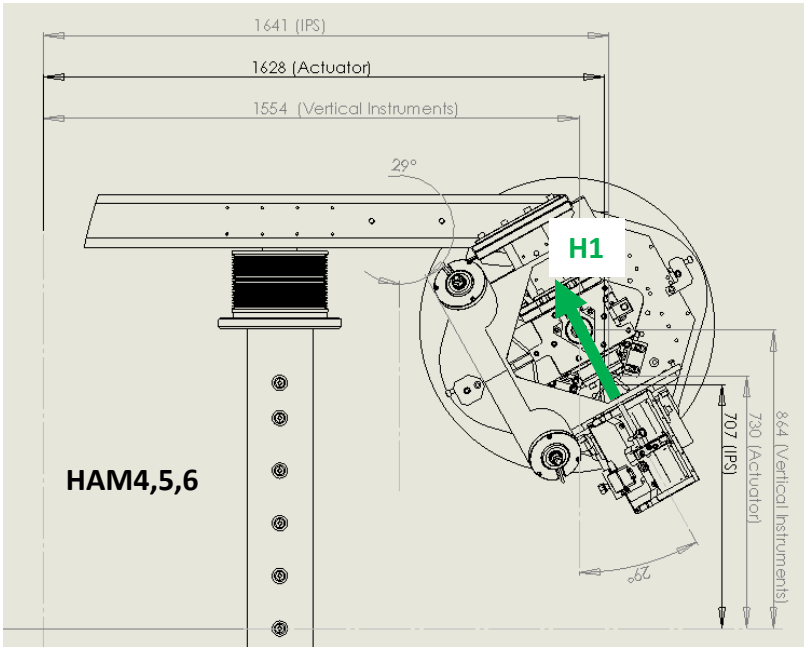

Corner 2 direction:
61 degrees

Corner 1 direction:
119 degrees

Corner 3 direction:
-61 degrees

Corner 4 direction:
-119 degrees

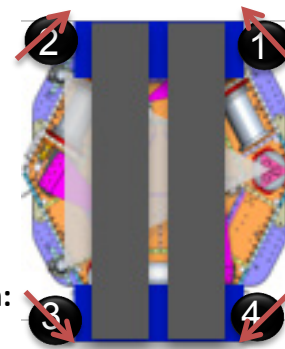

HAM4,5,6

1.4) aLIGO BSC-HEPI Sensors & Actuators

Drawing of Corner # 4 of ITMY

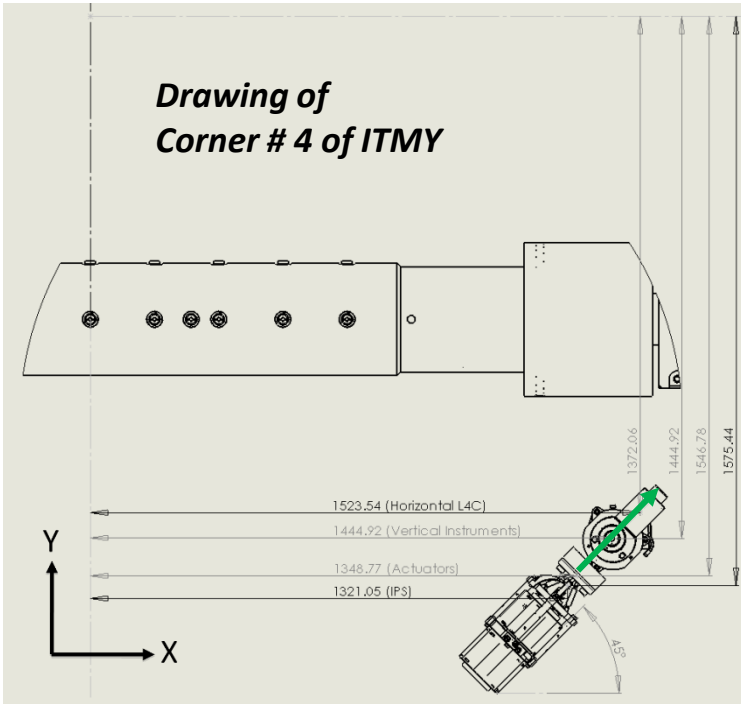

BS, ITMY, ETMX instruments location and direction:

Sensor	X [m]	Y [m]	Z [m]	Angle
Actuator H1	1.348	1.547	0	-45 deg to X
Position sensor H1	1.321	1.575	0	-45 deg to X
L4-C H1	1.523	1.372	0	-45 deg to X
Actuator V1	1.445	1.445	-0.092	0 deg to Z
Position sensor V1	1.445	1.445	-0.123	0 deg to Z
L4C V1	1.445	1.445	0.02	0 deg to Z

Coordinate system's origin is aligned with horizontal actuators plane

For the BS, ITMY, ETMX , Positive RZ motion makes -H1, +H2, -H3 and +H4 IPS signals.

For the calculation of the actuators matrices, it is assumed that each actuator is in the same orientation as its local IPS. If a local to local transfer function shows otherwise, the actuator sign would be corrected in the "symetrization" filter located in the actuator's output filter bank.

For the calculation of the L4C matrices, it is assumed that the L4Cs are in the same orientation as the CPS. If the local to local transfer function shows otherwise, the L4C instrument sign would be corrected in the "symetrization" filter located in the L4C input filter bank.

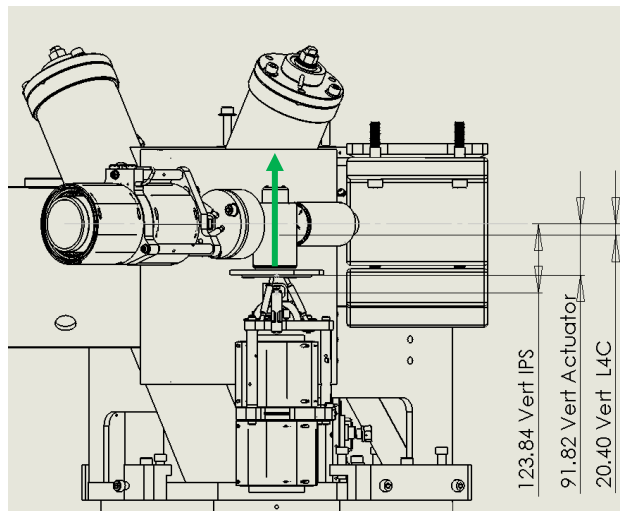

Corner 2 Direction:
- 135 degrees

Corner 1 Direction:
- 45 degrees

ITMY

Corner 3
135 degrees

Corner 4
45 degrees

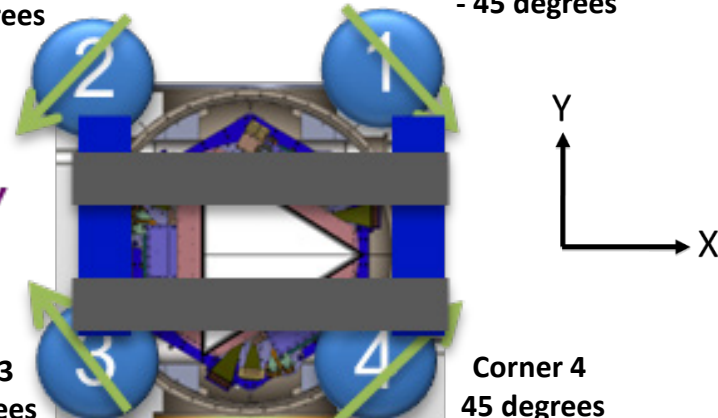

2) Change of basis calculation And scripts

2.1) Calculations

Sensors (1/3)

- Platform's rigid body motion in the Cartesian basis: $C = \{x \ y \ z \ R_x \ R_y \ R_z\}'$
 - The origin is on the vertical axis of symmetry, and in the horizontal actuators plan
 - Units are [m] for the translation, [rad] for the rotation (or any time derivatives of these respective units)
 - The order $\{x \ y \ z \ R_x \ R_y \ R_z\}'$ will be swapped to $\{x \ y \ R_z \ z \ R_x \ R_y\}'$ at the end of the calculations

- Measurements in the local basis: $L = \{l_{h1} \ l_{h2} \ l_{h3} \ l_{v1} \ l_{v2} \ l_{v3}\}'$
 - Units are [m] for all measurements (or any time derivatives of these units)

Sensors (2/3)

- The sensor location in the Cartesian basis is noted: $A_i = \{a_i \ b_i \ c_i\}'$
 - For $i = h_1, h_2, \dots, v_3$
 - Units are [m]
- The sensor direction in the Cartesian basis is noted: $J_i = \{j_i \ k_i \ l_i\}'$
 - For $i = h_1, h_2, \dots, v_3$
 - Direction vector amplitude is unity $|J_i|$
- The motion of the sensor located in A_i is:

$$\begin{Bmatrix} x \\ y \\ z \end{Bmatrix} + \begin{Bmatrix} Rx \\ Ry \\ Rz \end{Bmatrix} \times A_i = \begin{Bmatrix} x \\ y \\ z \end{Bmatrix} - A_i \times \begin{Bmatrix} Rx \\ Ry \\ Rz \end{Bmatrix} = P_i C$$

With: $P_i = [I(3) \quad | \quad -Cross(A_i)]$ Where: $Cross(A_i) = \begin{bmatrix} 0 & -c_i & b_i \\ c_i & 0 & -a_i \\ -b_i & +a_i & 0 \end{bmatrix}$

$$P_i = \begin{bmatrix} 1 & 0 & 0 & 0 & c_i & -b_i \\ 0 & 1 & 0 & -c_i & 0 & a_i \\ 0 & 0 & 1 & b_i & -a_i & 0 \end{bmatrix}$$

Sensors (3/3)

- The measurement of the sensor located in A_i is the motion projected on the direction of the sensor:

$$l_i = J'_i P_i C$$

- The sensor matrix S (such as $L = S C$) is made of lines of $J'_i P_i$:

$$S = \begin{bmatrix} J'_{h1} & P_{h1} \\ J'_{h2} & P_{h2} \\ \dots & \dots \\ J'_{v3} & P_{h3} \end{bmatrix}$$

- The Local to Cartesian matrix is S^{-1} :

$$C = S^{-1} L$$

- Units are dimensionless [m/m] for the components of the first three lines of S^{-1}
- Units are [rad/m] for the components of the last three lines of S^{-1}

(or any time derivatives of these units)

Actuators (1/3)

- Platform's forces in the Cartesian basis:
$$F_C = \{F_x \ F_y \ F_z \ \tau_x \ \tau_y \ \tau_z\}'$$
 - The origin is on the vertical axis of symmetry, and in the horizontal actuators plan
 - Units are [N] for the forces, [N. m] for the torques
 - The order $\{F_x \ F_y \ F_z \ \tau_x \ \tau_y \ \tau_z\}'$ will be swapped to $\{F_x \ F_y \ \tau_z \ F_z \ \tau_x \ \tau_y\}'$ at the end of the calculations
- Forces in the local basis:
$$F_L = \{F_{h1} \ F_{h2} \ F_{h3} \ F_{v1} \ F_{v2} \ F_{v3}\}'$$
 - Units are [N] for all forces
- The actuators location in the Cartesian basis is noted:
$$A_i = \{a_i \ b_i \ c_i\}'$$
 - For $i = h_1, h_2 \dots$
 - Units are [m]
- The actuators direction in the Cartesian basis is noted:
$$J_i = \{j_i \ k_i \ l_i\}'$$
 - For $i = h_1, h_2 \dots$
 - The amplitude of the direction vector is unity: $|J_i|$

Actuators (2/3)

- The forces at the center of the Cartesian basis can be written using the direction vectors J_i :

$$\begin{Bmatrix} F_x \\ F_y \\ F_z \end{Bmatrix} = [J_{h1} \quad \dots \quad J_{v3}] \begin{Bmatrix} F_{h1} \\ \dots \\ F_{v3} \end{Bmatrix}$$

- The moments at the center of the Cartesian basis can be written using the direction vectors J_i :

$$\begin{Bmatrix} \tau_x \\ \tau_y \\ \tau_z \end{Bmatrix} = [A_{h1} \times J_{h1} \quad \dots \quad A_{v3} \times J_{v3}] \begin{Bmatrix} F_{h1} \\ \dots \\ F_{v3} \end{Bmatrix}$$

- The drive matrix D (such as $F_C = D F_L$) made of columns of $Q_i J_i$:

$$D = [Q_{h1} J_{h1} \quad \dots \quad Q_{v3} J_{v3}]$$

With: $Q_i = \begin{bmatrix} I(3,3) \\ \text{Cross}(A_i) \end{bmatrix}$ where: $\text{Cross}(A_i) = \begin{bmatrix} 0 & -c_i & b_i \\ c_i & 0 & -a_i \\ -b_i & +a_i & 0 \end{bmatrix}$

Actuators (3/3)

- The Cartesian to Local matrix is D^{-1} :

$$F_L = D^{-1} F_C$$

- Units are dimensionless [N/N] for the components of the first three lines of D^{-1}
- Units are [m] for the components of the last three lines of D^{-1}

HEPI Horizontal Pringle Sensor Definition

- A unity horizontal “pringle” deformation is defined as a deformation that generates a unity displacement in each corner (H1 to H4).
- In other words, a local displacement sensor reads a “positive 1 meter signal” for a “unity positive HP deformation”

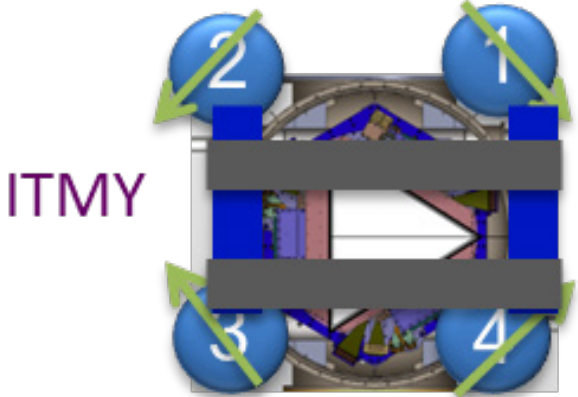

HP = +1
➔

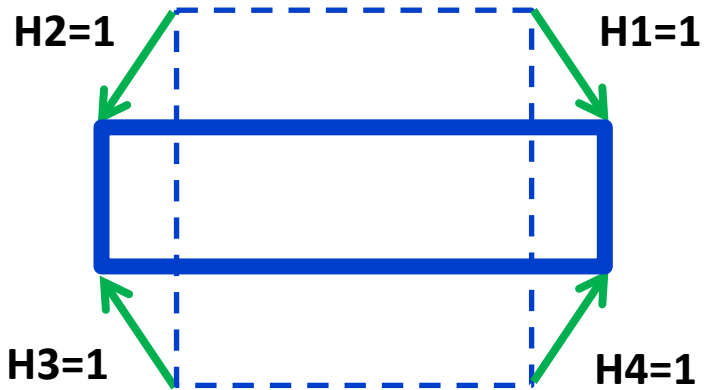

HP = +1
➔

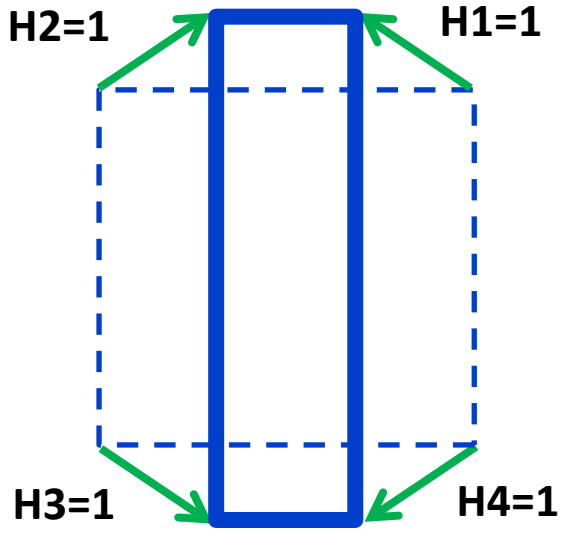

HEPI Horizontal Pringle Sensor Definition

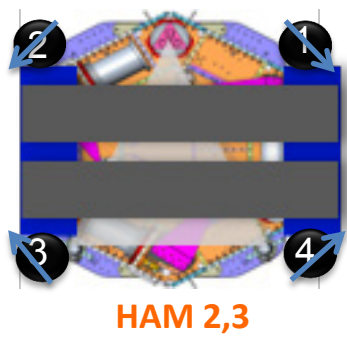

HP = +1
 →

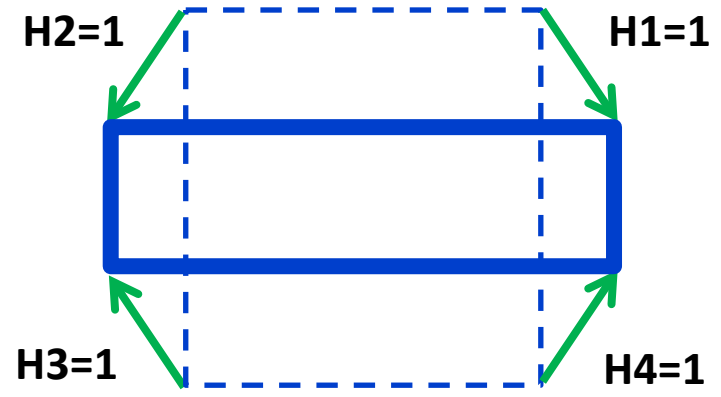

HP = +1
 →

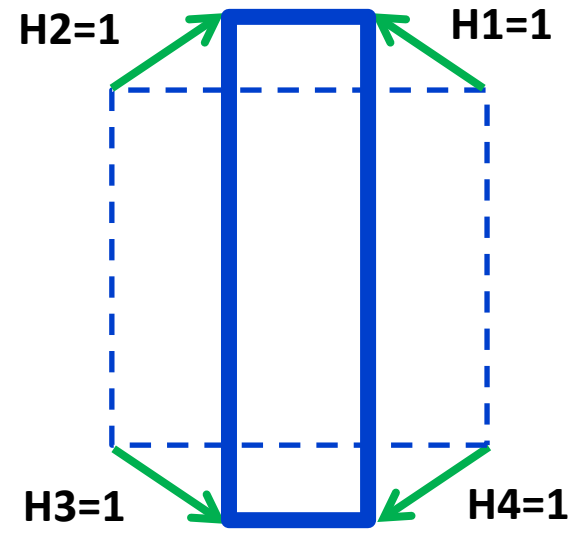

Note: A Positive HP always compress the blue beams and extend the support tubes.





Vertical Pringle Sensor Definition

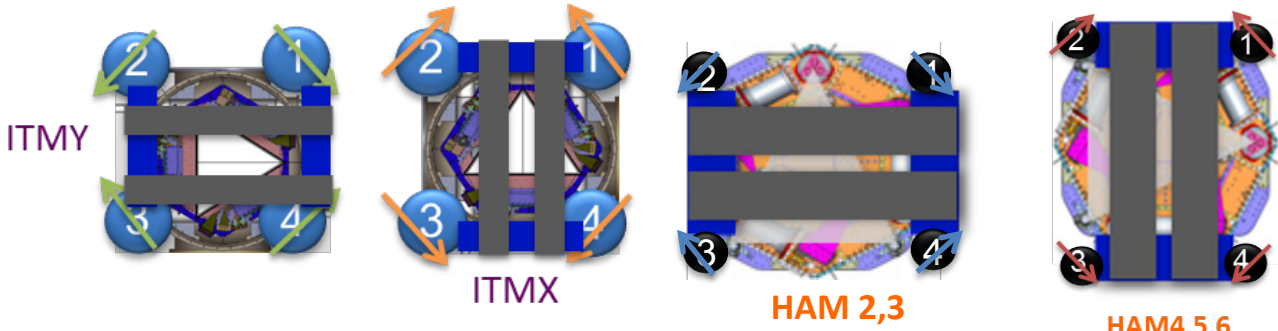
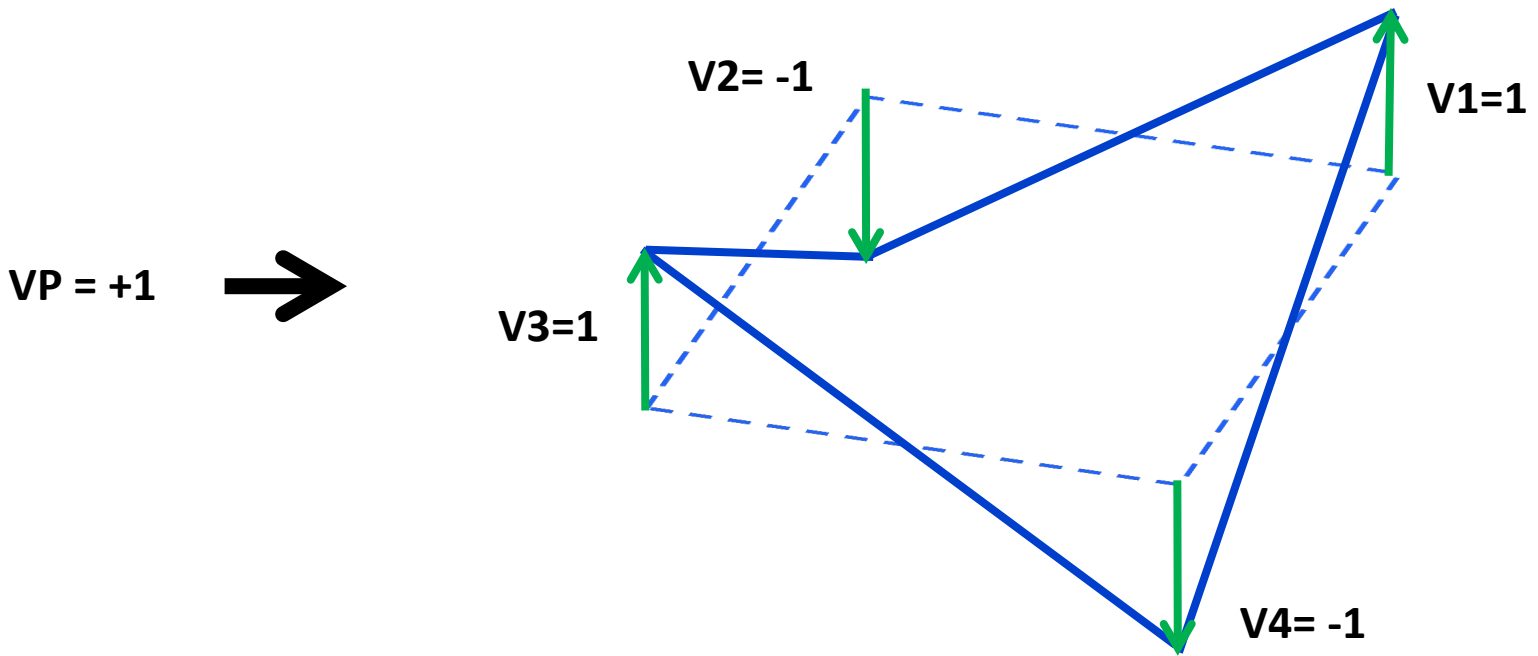



A unity Vertical "pringle" deformation is defined as a deformation that generates a displacement of 1 Meter in each sensor (V1=1 to V4).



A positive VP deformation generates a positive V1 and V3 (negative V2 and V4)



2.2) Scripts

-  aLIGO_BSC_HEPI_Matrices_Input_Values.m
-  aLIGO_BSC_ISI_Matrices_Input_Values.m
-  aLIGO_HAM_HEPI_Matrices_Input_Values.m
-  aLIGO_HAM_ISI_Matrices_Input_Values.m

-  Make_aLIGO_BSC_HEPI_Matrices.m
-  Make_aLIGO_BSC_ISI_Matrices.m
-  Make_aLIGO_HAM_HEPI_Matrices.m
-  Make_aLIGO_HAM_ISI_Matrices.m

-  rot_mat.m
-  cross_mat.m

aLIGO_HAM_ISI_Matrices_Input_Values.m

```
1  %% HAM-ISI INPUT VALUES
2  % This script calculates the HAM-ISI change of basis matrices
3  % Sensors Locations and directions are described in T1000388
4  clear
5  close all
6  clc
7
8  %% CPS HAM_4_5_6
9  % Corner 1 Locations and directions:
10 Loc_Hor1 = [0.53071; 0.66058; -0.42107+0.21749i];
11 Dir_Hor1 = [cos(-pi/3); sin(-pi/3); 0];
12 Loc_Vert1 = [0.64703; -0.18553; -0.61151+0.21749i];
13 Dir_Vert1 = [0; 0; 1];
14 % Local to Cartesian Sensor Matrix:
15 disp('HAM_4_5_6:')
16 CPS2CART = Make_aLIGO_HAM_ISI_Matrices(Loc_Hor1, Dir_Hor1, Loc_Vert1, Dir_Vert1, 'Sens')
17
18 %% CPS HAM_2_3
19 % Corner 1 Locations and directions:
20 Loc_Hor1 = rot_mat(pi/2)*Loc_Hor1;
21 Dir_Hor1 = rot_mat(pi/2)*Dir_Hor1;
22 Loc_Vert1 = rot_mat(pi/2)*Loc_Vert1;
23 Dir_Vert1 = rot_mat(pi/2)*Dir_Vert1;
24 % Local to Cartesian Sensor Matrix:
25 disp('HAM_2_3:')
26 CPS2CART = Make_aLIGO_HAM_ISI_Matrices(Loc_Hor1, Dir_Hor1, Loc_Vert1, Dir_Vert1, 'Sens')
```

```

71
72 %% Actuator HAM_4_5_6
73 % Corner 1 Locations and directions:
74 - Loc_Hor1 = [0.52342; 0.64154; 0];
75 - Dir_Hor1 = [cos(-pi/3); sin(-pi/3); 0];
76 - Loc_Vert1 = [0.71120; 0; -0.59868+0.21749i];
77 - Dir_Vert1 = [0; 0; 1];
78 % Cartesian to Local Actuator Matrix:
79 - disp('HAM_4_5_6:')
80 - CART2ACT = Make_aLIGO_HAM_ISI_Matrices(Loc_Hor1, Dir_Hor1, Loc_Vert1, Dir_Vert1, 'Actu')
81
82 %% Actuator HAM_2_3
83 % Corner 1 Locations and directions:
84 - Loc_Hor1 = rot_mat(pi/2)*Loc_Hor1;
85 - Dir_Hor1 = rot_mat(pi/2)*Dir_Hor1;
86 - Loc_Vert1 = rot_mat(pi/2)*Loc_Vert1;
87 - Dir_Vert1 = rot_mat(pi/2)*Dir_Vert1;
88 % Cartesian to Local Actuator Matrix:
89 - disp('HAM_2_3:')
90 - CART2ACT = Make_aLIGO_HAM_ISI_Matrices(Loc_Hor1, Dir_Hor1, Loc_Vert1, Dir_Vert1, 'Actu')

```

Make_aLIGO_HAM_ISI_Matrices

```
1 function Result=Make_aLIGO_HAM_ISI_Matrices(Loc_Hor1,Dir_Hor1,Loc_Vert1,Dir_Vert1,Type,Loc_Vert2,Loc_Vert3)
2
3 % Instruments Location in rows
4 Loc(:,1)=Loc_Hor1; % Horizontal Corner 1
5 Loc(:,2)=rot_mat(2*pi/3)*Loc_Hor1; % Horizontal Corner 2
6 Loc(:,3)=rot_mat(4*pi/3)*Loc_Hor1; % Horizontal Corner 3
7 Loc(:,4)=Loc_Vert1; % Vertical Corner 4
8 if Type == 'L4Cs'
9     Loc(:,5)=Loc_Vert2; % Vertical Corner 5
10    Loc(:,6)=Loc_Vert3; % Vertical Corner 6
11    Type='Sens';
12 else
13    Loc(:,5)=rot_mat(2*pi/3)*Loc_Vert1; % Vertical Corner 5
14    Loc(:,6)=rot_mat(4*pi/3)*Loc_Vert1; % Vertical Corner 6
15 end
16
17
18 % Instruments Direction
19 Dir(:,1)=Dir_Hor1; % Horizontal Corner 1
20 Dir(:,2)=rot_mat(2*pi/3)*Dir_Hor1; % Horizontal Corner 2
21 Dir(:,3)=rot_mat(4*pi/3)*Dir_Hor1; % Horizontal Corner 3
22 Dir(:,4)=Dir_Vert1; % Vertical Corner 4
23 Dir(:,5)=rot_mat(2*pi/3)*Dir_Vert1; % Vertical Corner 5
24 Dir(:,6)=rot_mat(4*pi/3)*Dir_Vert1; % Vertical Corner 6
```

```

26 - if Type == 'Sens'
27     % L=S*C (Local sensor as a function to Cartesian displacements):
28     for jj=1:6
29         S(jj,:)=Dir(:,jj)'+[eye(3) -cross_mat(Loc(:,jj))];
30     end
31     % Calculate the local to Cartesian matrix
32     L2C=S^-1;
33     % Swap Z and RZ
34     L2C_temp=L2C;
35     L2C(3,:)=L2C_temp(6,:);
36     L2C(4,:)=L2C_temp(3,:);
37     L2C(5,:)=L2C_temp(4,:);
38     L2C(6,:)=L2C_temp(5,:);
39     Result=round(L2C*1e6)*1e-6;
40 end

```

**Projections from
Cartesian to Local
Motions**

Inverting.

Re-ordering

Rounding

```

42 - if Type == 'Actu'
43     % L=S*C (Local sensor as a function to Cartesian displacements):
44     for jj=1:6
45         D(:,jj)=[eye(3) ; cross_mat(Loc(:,jj))]*Dir(:,jj);
46     end
47     % Calculate the local to Cartesian matrix
48     C2L=D^-1;
49     % Swap Z and RZ
50     C2L_temp=C2L;
51     C2L(:,3)=C2L_temp(:,6);
52     C2L(:,4)=C2L_temp(:,3);
53     C2L(:,5)=C2L_temp(:,4);
54     C2L(:,6)=C2L_temp(:,5);
55     Result=round(C2L*1e6)*1e-6;
56 end

```

2.3) Output Names

Current Outputs

```
>> load('aLIGO_HAM_ISI_Matrices_X_Direction.mat')
```

```
>> whos
```

Name	Size	Bytes	Class	Attributes
CART2ACT	6x6	288	double	
CPS2CART	6x6	288	double	
CPSALIGN	6x6	288	double	
GS132CART	6x6	288	double	
L4C2CART	6x6	288	double	

```
make_ham_hepi_modal_matrixs(2)
```

```
ans =
```

```
    L4C: [8x8 double]  
    IPS: [8x8 double]  
 Act_L2M: [8x8 double]  
 Act_M2L: [8x8 double]
```

The standard version will use the MEDM channel names

Add DCC #, date, and name of mfile used to create the matrices

3) Matrices values

3.1) HAM-ISI Matrices

seismic - Revision 7887: /HAM-ISI/Common/Basis_Change_Matrices

- [..](#)
- [Archives/](#) → Old programs and matrices
- [Make aLIGO HAM ISI Matrices.m](#) → Matrix calculation program
- [aLIGO HAM ISI 2 3.mat](#) → Output Data
- [aLIGO HAM ISI 4 5 6.mat](#) → Output Data
- [aLIGO HAM ISI Matrices Input Values.m](#) → Input Values/Top level script

```
>> load aLIGO_HAM_ISI_4_5_6.mat
```

```
>> Readme
```

```
Readme =
```

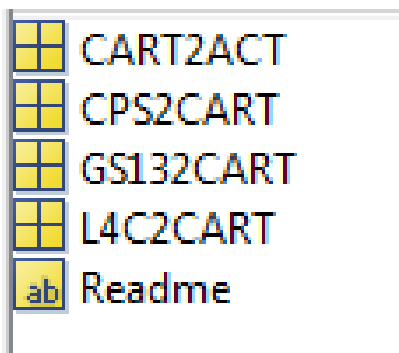

```
These matrices were generated and saved on 19-Dec-2013 using aLIGO_HAM_ISI_Matrices.m
```

```
See T1000388 for more details.
```

HAM-ISI CPS

HAM 4,5,6

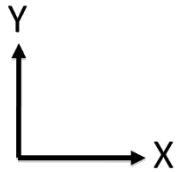
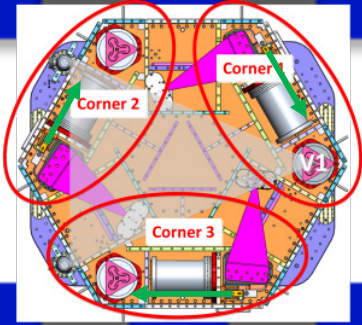

HAM 2,3

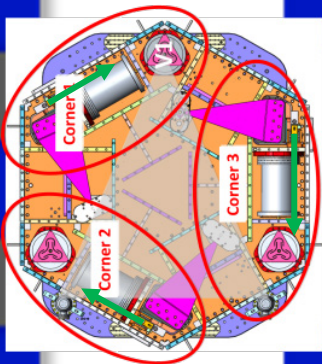

HAM_4_5_6:

CPS2CART =

0.3333	0.3333	-0.6667	-0.1938	0.0488	0.1450
-0.5773	0.5773	0	0.0556	-0.1956	0.1401
-0.4220	-0.4220	-0.4220	0	0	0
0	0	0	0.3333	0.3333	0.3333
0	0	0	-0.2730	0.9610	-0.6880
0	0	0	-0.9521	0.2396	0.7125

HAM_2_3:

CPS2CART =

0.5773	-0.5773	0	-0.0556	0.1956	-0.1401
0.3333	0.3333	-0.6667	-0.1938	0.0488	0.1450
-0.4220	-0.4220	-0.4220	0	0	0
0	0	0	0.3333	0.3333	0.3333
0	0	0	0.9521	-0.2396	-0.7125
0	0	0	-0.2730	0.9610	-0.6880

HAM-ISI GS13

HAM 4,5,6

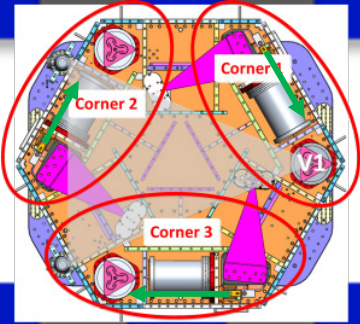

HAM_4_5_6:

GS132CART =

0.3333	0.3333	-0.6667	-0.0282	0.0141	0.0141
-0.5773	0.5773	0	0	-0.0244	0.0244
-0.4906	-0.4906	-0.4906	0	0	0
0	0	0	0.3333	0.3333	0.3333
0	0	0	0	0.7332	-0.7332
0	0	0	-0.8467	0.4233	0.4233

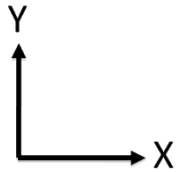

HAM_2_3:

GS132CART =

0.5773	-0.5773	0	0	0.0244	-0.0244
0.3333	0.3333	-0.6667	-0.0282	0.0141	0.0141
-0.4906	-0.4906	-0.4906	0	0	0
0	0	0	0.3333	0.3333	0.3333
0	0	0	0.8467	-0.4233	-0.4233
0	0	0	0	0.7332	-0.7332

HAM 2,3

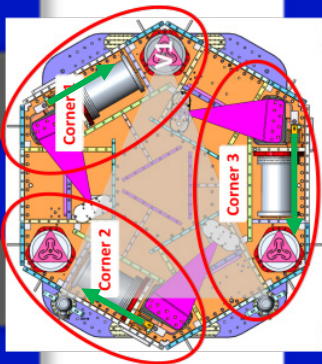

HAM-ISI L4Cs

HAM 4,5,6

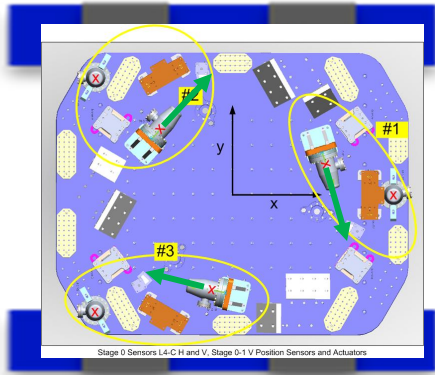

HAM_4_5_6:

L4C2CART =

0.2005	0.4504	-0.6509	-0.2590	0.1295	0.1295
-0.6358	0.4915	0.1443	0	-0.3319	0.3319
-0.6562	-0.6562	-0.6562	0	0	0
0	0	0	0.4600	0.2700	0.2700
0	0	0	0	0.8288	-0.8288
0	0	0	-0.6467	0.3234	0.3234

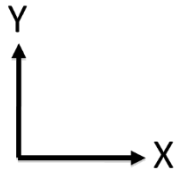

Need to Check L4C Signs

No Stage 0 L4Cs on HAM 2&3

HAM-ISI Actuators

HAM 4,5,6

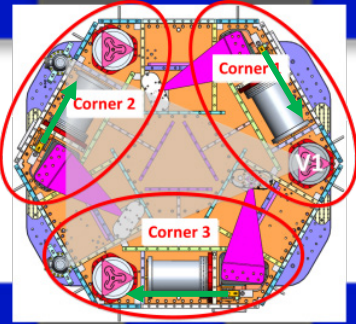

HAM_4_5_6:

CART2ACT =

0.3333	-0.5773	-0.4306	0	0	0
0.3333	0.5773	-0.4306	0	0	0
-0.6667	0	-0.4306	0	0	0
0	0	0	0.3333	0	-0.9374
0	0	0	0.3333	0.8118	0.4687
0	0	0	0.3333	-0.8118	0.4687

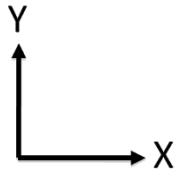

HAM_2_3:

CART2ACT =

0.5773	0.3333	-0.4306	0	0	0
-0.5773	0.3333	-0.4306	0	0	0
0	-0.6667	-0.4306	0	0	0
0	0	0	0.3333	0.9374	0
0	0	0	0.3333	-0.4687	0.8118
0	0	0	0.3333	-0.4687	-0.8118

HAM 2,3

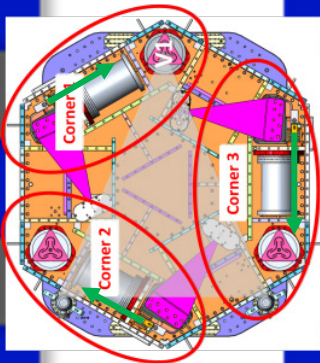

3.2) BSC-HEPI Matrices

seismic - Revision 7891: /HEPI/Common/Basis_Change_Matrices_HEPI/BSC

- `==`
- [Make aLIGO BSC HEPI Matrices.m](#) → Matrix calculation program
- [aLIGO BSC HEPI BS ITMY ETMX.mat](#) → Output Data
- [aLIGO BSC HEPI ITMX ETMY.mat](#) → Output Data
- [aLIGO BSC HEPI Matrices Input Values.m](#) → Input Values/Top level script

BSC-HEPI IPS

BSC_ISI_BS_ITMY_ETMX:

HEPI not ISI

IPS2CART =

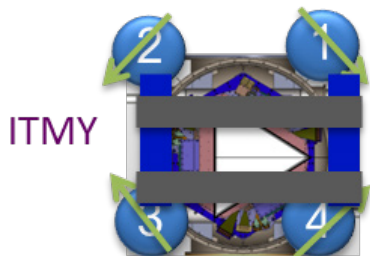

0.3536	-0.3536	-0.3536	0.3536	0	0	0	0
-0.3536	-0.3536	0.3536	0.3536	0	0	0	0
-0.1221	0.1221	-0.1221	0.1221	0	0	0	0
0.2500	0.2500	0.2500	0.2500	0	0	0	0
0	0	0	0	0.2500	0.2500	0.2500	0.2500
0	0	0	0	0.1730	0.1730	-0.1730	-0.1730
0	0	0	0	-0.1730	0.1730	0.1730	-0.1730
0	0	0	0	0.2500	-0.2500	0.2500	-0.2500

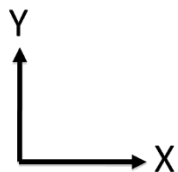

BSC_ISI_ITMX_ETMY:

IPS2CART =



-0.3536	0.3536	0.3536	-0.3536	0	0	0	0
0.3536	0.3536	-0.3536	-0.3536	0	0	0	0
0.1221	-0.1221	0.1221	-0.1221	0	0	0	0
0.2500	0.2500	0.2500	0.2500	0	0	0	0
0	0	0	0	0.2500	0.2500	0.2500	0.2500
0	0	0	0	0.1730	0.1730	-0.1730	-0.1730
0	0	0	0	-0.1730	0.1730	0.1730	-0.1730
0	0	0	0	0.2500	-0.2500	0.2500	-0.2500

BSC-HEPI L4C

BSC_ISI_BS_ITMY_ETMX:

L4C2CART =

0.3536	-0.3536	-0.3536	0.3536	0	0	0	0
-0.3536	-0.3536	0.3536	0.3536	0	0	0	0
-0.1221	0.1221	-0.1221	0.1221	0	0	0	0
0.2500	0.2500	0.2500	0.2500	0	0	0	0
0	0	0	0	0.2500	0.2500	0.2500	0.2500
0	0	0	0	0.1730	0.1730	-0.1730	-0.1730
0	0	0	0	-0.1730	0.1730	0.1730	-0.1730
0	0	0	0	0.2500	-0.2500	0.2500	-0.2500

ITMY

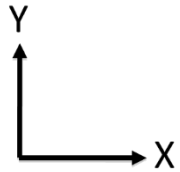
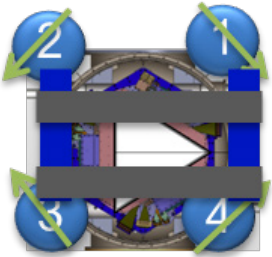

BSC_ISI_ITMX_ETMY:

L4C2CART =

-0.3536	0.3536	0.3536	-0.3536	0	0	0	0
0.3536	0.3536	-0.3536	-0.3536	0	0	0	0
0.1221	-0.1221	0.1221	-0.1221	0	0	0	0
0.2500	0.2500	0.2500	0.2500	0	0	0	0
0	0	0	0	0.2500	0.2500	0.2500	0.2500
0	0	0	0	0.1730	0.1730	-0.1730	-0.1730
0	0	0	0	-0.1730	0.1730	0.1730	-0.1730
0	0	0	0	0.2500	-0.2500	0.2500	-0.2500

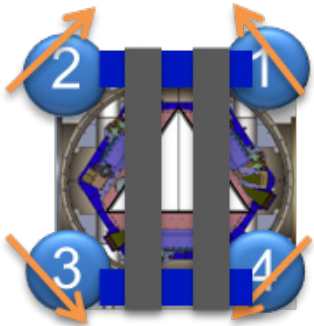

ITMX

BSC-HEPI Actuators

BSC_ISI_BS_ITMY_ETMX:

CART2ACT =

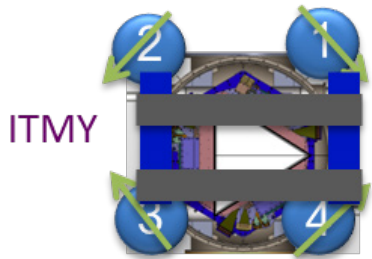

0.3536	-0.3536	-0.1221	0.2500	0	0	0	0
-0.3536	-0.3536	0.1221	0.2500	0	0	0	0
-0.3536	0.3536	-0.1221	0.2500	0	0	0	0
0.3536	0.3536	0.1221	0.2500	0	0	0	0
0	0	0	0	0.2500	0.1730	-0.1730	0.2500
0	0	0	0	0.2500	0.1730	0.1730	-0.2500
0	0	0	0	0.2500	-0.1730	0.1730	0.2500
0	0	0	0	0.2500	-0.1730	-0.1730	-0.2500

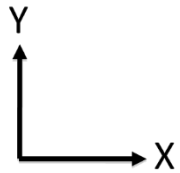

BSC_ISI_ITMX_ETMY:

CART2ACT =



-0.3536	0.3536	0.1221	0.2500	0	0	0	0
0.3536	0.3536	-0.1221	0.2500	0	0	0	0
0.3536	-0.3536	0.1221	0.2500	0	0	0	0
-0.3536	-0.3536	-0.1221	0.2500	0	0	0	0
0	0	0	0	0.2500	0.1730	-0.1730	0.2500
0	0	0	0	0.2500	0.1730	0.1730	-0.2500
0	0	0	0	0.2500	-0.1730	0.1730	0.2500
0	0	0	0	0.2500	-0.1730	-0.1730	-0.2500

3.3) HAM-HEPI Matrices

seismic - Revision 7891: /HEPI/Common/Basis_Change_Matrices_HEPI/HAM

- ..
- [Make aLIGO HAM HEPI Matrices.m](#) → Matrix calculation program
- [aLIGO HAM HEPI 1 2 3.mat](#) → Output Data
- [aLIGO HAM HEPI 4 5 6.mat](#) → Output Data
- [aLIGO HAM HEPI Matrices Input Values.m](#) → Input Values/Top level script

BSC-HEPI IPS

HAM_4_5_6:

IPS2CART =

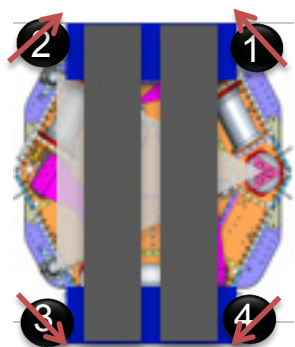

HAM4,5,6

-0.5157	0.5157	0.5157	-0.5157	0	0	0	0
0.2858	0.2858	-0.2858	-0.2858	0	0	0	0
0.1406	-0.1406	0.1406	-0.1406	0	0	0	0
0.2500	0.2500	0.2500	0.2500	0	0	0	0
0	0	0	0	0.2500	0.2500	0.2500	0.2500
0	0	0	0	0.2894	0.2894	-0.2894	-0.2894
0	0	0	0	-0.1609	0.1609	0.1609	-0.1609
0	0	0	0	0.2500	-0.2500	0.2500	-0.2500

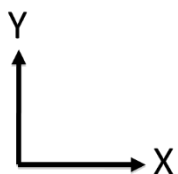

HAM_1_2_3:

IPS2CART =

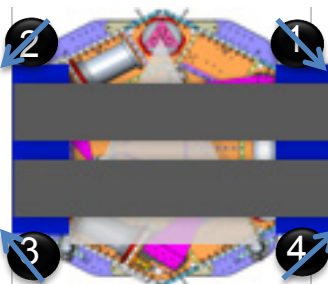

HAM 2,3

0.2858	-0.2858	-0.2858	0.2858	0	0	0	0
-0.5157	-0.5157	0.5157	0.5157	0	0	0	0
-0.1406	0.1406	-0.1406	0.1406	0	0	0	0
0.2500	0.2500	0.2500	0.2500	0	0	0	0
0	0	0	0	0.2500	0.2500	0.2500	0.2500
0	0	0	0	0.1609	0.1609	-0.1609	-0.1609
0	0	0	0	-0.2894	0.2894	0.2894	-0.2894
0	0	0	0	0.2500	-0.2500	0.2500	-0.2500

HAM-HEPI

aLIGO_HAM_HEPI_4_5_6.mat

L4C

HAM 4,5,6

HAM_4_5_6:

L4C2CART =

-0.5157	0.5157	0.5157	-0.5157	0	0	0	0
0.2858	0.2858	-0.2858	-0.2858	0	0	0	0
0.1406	-0.1406	0.1406	-0.1406	0	0	0	0
0.2500	0.2500	0.2500	0.2500	0	0	0	0
0	0	0	0	0.2500	0.2500	0.2500	0.2500
0	0	0	0	0.2894	0.2894	-0.2894	-0.2894
0	0	0	0	-0.1609	0.1609	0.1609	-0.1609
0	0	0	0	0.2500	-0.2500	0.2500	-0.2500

make_ham_hepi_modal_matrixs(2)

>> ans.L4C

ans =

-0.5157	0.5157	0.5157	-0.5157	0	0	0	0
0.2858	0.2858	-0.2858	-0.2858	0	0	0	0
0.1406	-0.1406	0.1406	-0.1406	0	0	0	0
0.2500	0.2500	0.2500	0.2500	0	0	0	0
0	0	0	0	0.2500	0.2500	0.2500	0.2500
0	0	0	0	0.2848	0.2848	-0.2848	-0.2848
0	0	0	0	-0.1617	0.1617	0.1617	-0.1617
0	0	0	0	0.2500	-0.2500	0.2500	-0.2500

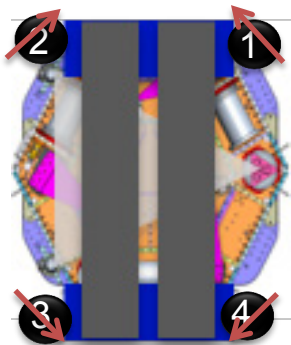
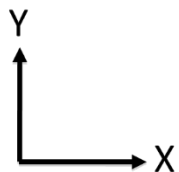

HAM4,5,6

HAM-HEPI

L4C

HAM 2,3

aLIGO_HAM_HEPI_1_2_3.mat

HAM_1_2_3:

L4C2CART =

0.2858	-0.2858	-0.2858	0.2858	0	0	0	0
-0.5157	-0.5157	0.5157	0.5157	0	0	0	0
-0.1406	0.1406	-0.1406	0.1406	0	0	0	0
0.2500	0.2500	0.2500	0.2500	0	0	0	0
0	0	0	0	0.2500	0.2500	0.2500	0.2500
0	0	0	0	0.1609	0.1609	-0.1609	-0.1609
0	0	0	0	-0.2894	0.2894	0.2894	-0.2894
0	0	0	0	0.2500	-0.2500	0.2500	-0.2500

make_ham_hepi_modal_matrixs(1)

>> ans.L4C

ans =

0.2858	-0.2858	-0.2858	0.2858	0	0	0	0
-0.5157	-0.5157	0.5157	0.5157	0	0	0	0
0.2697	-0.2697	0.2697	-0.2697	0	0	0	0
0.2500	0.2500	0.2500	0.2500	0	0	0	0
0	0	0	0	0.2500	0.2500	0.2500	0.2500
0	0	0	0	0.1617	0.1617	-0.1617	-0.1617
0	0	0	0	-0.2848	0.2848	0.2848	-0.2848
0	0	0	0	0.2500	-0.2500	0.2500	-0.2500

	H1	H2	H3	H4	V1
X	0.28580	-0.28580	-0.28580	0.28580	0.00000
Y	-0.51560	-0.51560	0.51560	0.51560	0.00000
RZ	0.13579	-0.13579	0.13579	-0.13579	0.00000
HP	0.25000	0.25000	0.25000	0.25000	0.00000
Z	0.00000	0.00000	0.00000	0.00000	0.25000
RX	0.00000	0.00000	0.00000	0.00000	-0.1523
RY	0.00000	0.00000	0.00000	0.00000	0.29870
VP	0.00000	0.00000	0.00000	0.00000	0.25000

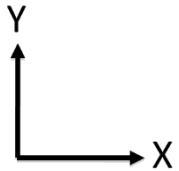

HAM 2,3

HAM-HEPI

ACT

HAM4,5,6

aLIGO_HAM_HEPI_4_5_6.mat

HAM_4_5_6:

CART2ACT =

-0.5157	0.2858	0.1406	0.2500	0	0	0	0
0.5157	0.2858	-0.1406	0.2500	0	0	0	0
0.5157	-0.2858	0.1406	0.2500	0	0	0	0
-0.5157	-0.2858	-0.1406	0.2500	0	0	0	0
0	0	0	0	0.2500	0.2894	-0.1609	0.2500
0	0	0	0	0.2500	0.2894	0.1609	-0.2500
0	0	0	0	0.2500	-0.2894	0.1609	0.2500
0	0	0	0	0.2500	-0.2894	-0.1609	-0.2500

make_ham_hepi_modal_matrixs(2)

```
>> ans.Act_M2L
```

```
ans =
```

-1	1	1	-1	0	0	0	0
1	1	-1	-1	0	0	0	0
1	-1	1	-1	0	0	0	0
1	1	1	1	0	0	0	0
0	0	0	0	1	1	1	1
0	0	0	0	1	1	-1	-1
0	0	0	0	-1	1	1	-1
0	0	0	0	1	-1	1	-1

	X	Y	EZ	HP
H1	-1.00000	1.00000	1.00000	1.00000
H2	1.00000	1.00000	-1.00000	1.00000
H3	1.00000	-1.00000	1.00000	-1.00000
H4	-1.00000	-1.00000	-1.00000	1.00000
V1	0.00000	0.00000	0.00000	0.00000
V2	0.00000	0.00000	0.00000	0.00000
V3	0.00000	0.00000	0.00000	0.00000
V4	0.00000	0.00000	0.00000	0.00000

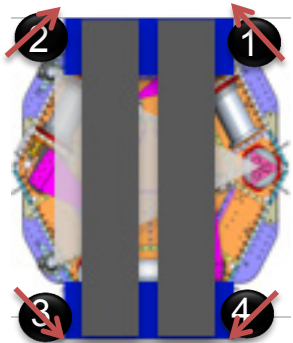
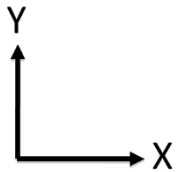

HAM4,5,6

HAM-HEPI

ACT

HAM 2,3

aLIGO_HAM_HEPI_1_2_3.mat

HAM_1_2_3:

CART2ACT =

```

0.2858  -0.5157  -0.1406  0.2500  0  0  0  0
-0.2858  -0.5157   0.1406  0.2500  0  0  0  0
-0.2858   0.5157  -0.1406  0.2500  0  0  0  0
 0.2858   0.5157   0.1406  0.2500  0  0  0  0
 0  0  0  0  0.2500  0.1609 -0.2894  0.2500
 0  0  0  0  0.2500  0.1609  0.2894 -0.2500
 0  0  0  0  0.2500 -0.1609  0.2894  0.2500
 0  0  0  0  0.2500 -0.1609 -0.2894 -0.2500
    
```

make_ham_hepi_modal_matrixs(1)

```
>> ans.Act_M2L
```

ans =

```

 1  -1  -1  1  0  0  0  0
-1  -1   1  1  0  0  0  0
-1   1  -1  1  0  0  0  0
 1   1   1  1  0  0  0  0
 0   0   0  0  1  1  1  1
 0   0   0  0  1  1 -1 -1
 0   0   0  0 -1  1  1 -1
 0   0   0  0  1 -1  1 -1
    
```

	X	Y	RZ	HP	
H1	0.87470	-0.48480	1.77800	1.00000	0.00000
H2	-0.87470	-0.48480	-1.77800	1.00000	0.00000
H3	-0.87470	0.48480	1.77800	1.00000	0.00000
H4	0.87470	0.48480	-1.77800	1.00000	0.00000
V1	0.00000	0.00000	0.00000	0.00000	1.00000
V2	0.00000	0.00000	0.00000	0.00000	1.00000
V3	0.00000	0.00000	0.00000	0.00000	1.00000
V4	0.00000	0.00000	0.00000	0.00000	1.00000

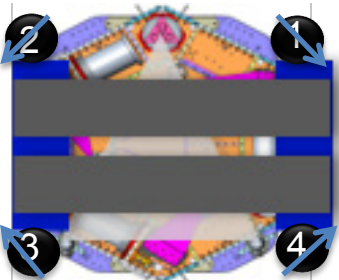
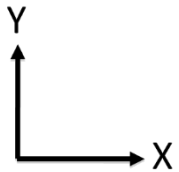

HAM 2,3

3.4) BSC-ISI Matrices

/seismic/BSC-ISI/Common/Basis_Change_BSC_ISI/aLIGO/Matrices/

- aLIGO_BSC_ISI_Matrices_Direction_X.mat
- aLIGO_BSC_ISI_Matrices_Direction_Y.mat
- aLIGO_BSC_ISI_Matrices_Y_Direction.mat
- aLIGO_BSC_ISI_Matrices_Y_Direction_2011_10_01.mat

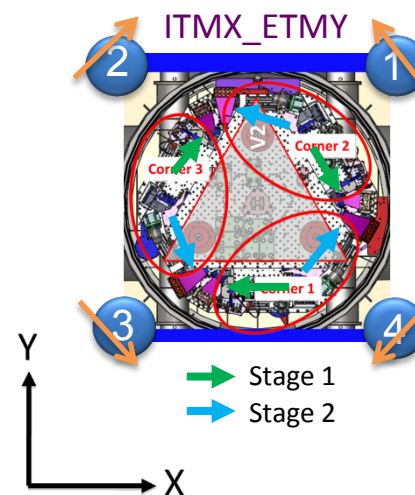
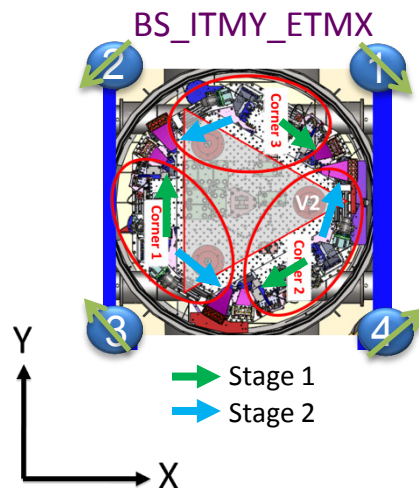

BSC-ISI

Stage 1 CPS

BS_ITMY_ETMX:

ST1_CPS2CART =

0	-0.5773	0.5773	-0.0361	0.0305	0.0056
0.6667	-0.3333	-0.3333	-0.0144	-0.0240	0.0384
-0.3467	-0.3467	-0.3467	0	0	0
0	0	0	0.3333	0.3333	0.3333
0	0	0	-0.2389	-0.3984	0.6373
0	0	0	0.5980	-0.5059	-0.0921

ITMX_ETMY:

ST1_CPS2CART =

-0.6667	0.3333	0.3333	0.0144	0.0240	-0.0384
0	-0.5773	0.5773	-0.0361	0.0305	0.0056
-0.3467	-0.3467	-0.3467	0	0	0
0	0	0	0.3333	0.3333	0.3333
0	0	0	-0.5980	0.5059	0.0921
0	0	0	-0.2389	-0.3984	0.6373

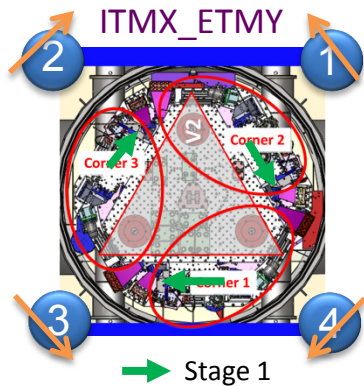
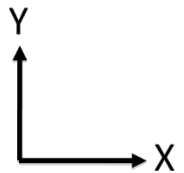
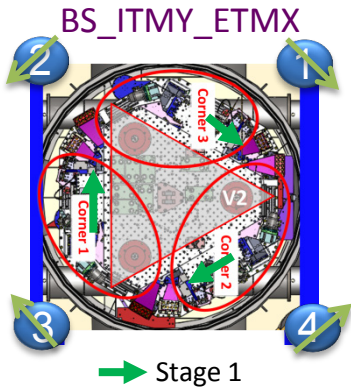

BSC-ISI

Stage 1 T240

BS_ITMY_ETMX

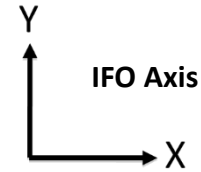
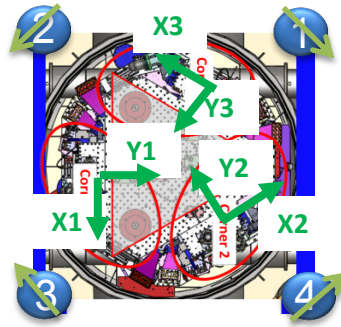

Cartesian to Local Test to check the sign Y1, Y2, Y3?

ST1_T2402CART =

	X1	Y1	Z1	X2	Y2	Z2	X3	Y3	Z3
X	0	0.3333	-0.1353	0.2887	-0.1667	0.0677	-0.2887	-0.1667	0.0677
Y	-0.3333	0	0	0.1667	0.2887	-0.1172	0.1667	-0.2887	0.1172
RZ	0.5834	0	0	0.5834	0	0	0.5834	0	0
Z	0	0	0.3333	0	0	0.3333	0	0	0.3333
RX	0	0	0	0	0	-1.0104	0	0	1.0104
RY	0	0	1.1667	0	0	-0.5834	0	0	-0.5834

BSC-ISI

Stage 1 T240

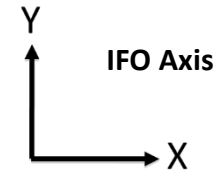
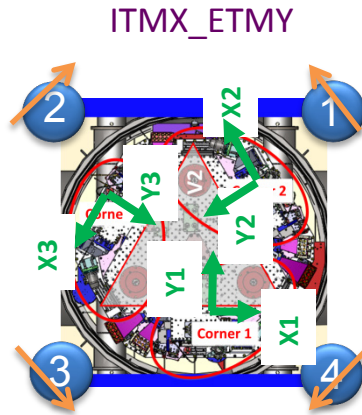

ST1_T2402CART =

	X1	Y1	Z1	X2	Y2	Z2	X3	Y3	Z3
X	0.3333	0	0	-0.1667	-0.2887	0.1172	-0.1667	0.2887	-0.1172
Y	0	0.3333	-0.1353	0.2887	-0.1667	0.0677	-0.2887	-0.1667	0.0677
RZ	0.5834	0	0	0.5834	0	0	0.5834	0	0
Z	0	0	0.3333	0	0	0.3333	0	0	0.3333
RX	0	0	-1.1667	0	0	0.5834	0	0	0.5834
RY	0	0	0	0	0	-1.0104	0	0	1.0104

BSC-ISI

Stage 1 L4C

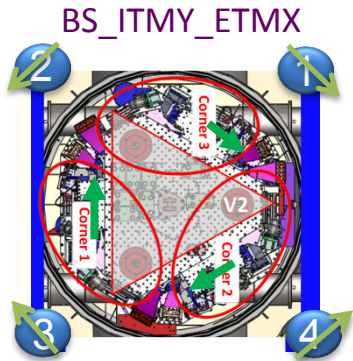

BS_ITMY_ETMX:

ST1_L4C2CART =

0	-0.5773	0.5773	-0.0516	0.0258	0.0258
0.6667	-0.3333	-0.3333	0	-0.0447	0.0447
-0.4233	-0.4233	-0.4233	0	0	0
0	0	0	0.3333	0.3333	0.3333
0	0	0	0	-0.7026	0.7026
0	0	0	0.8113	-0.4057	-0.4057

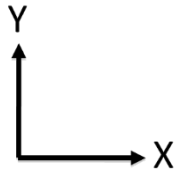

ITMX_ETMY:

ST1_L4C2CART =

-0.6667	0.3333	0.3333	0	0.0447	-0.0447
0	-0.5773	0.5773	-0.0516	0.0258	0.0258
-0.4233	-0.4233	-0.4233	0	0	0
0	0	0	0.3333	0.3333	0.3333
0	0	0	-0.8113	0.4057	0.4057
0	0	0	0	-0.7026	0.7026

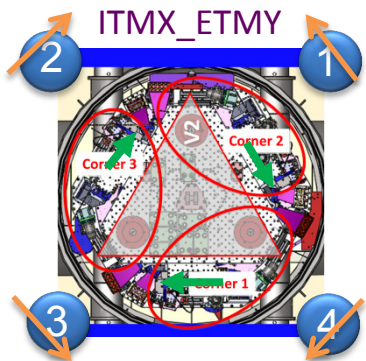

BSC-ISI

Stage 1 Actuator

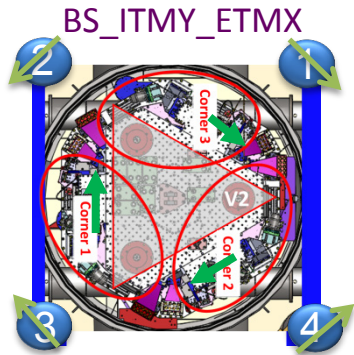

BS_ITMY_ETMX:

ST1_CART2ACT =

0	0.6667	-0.4057	0	0	0	0
-0.5773	-0.3333	-0.4057	0	0	0	0
0.5773	-0.3333	-0.4057	0	0	0	0
0	0	0	0.3333	-0.2767	0.7023	
0	0	0	0.3333	-0.4699	-0.5908	
0	0	0	0.3333	0.7466	-0.1116	

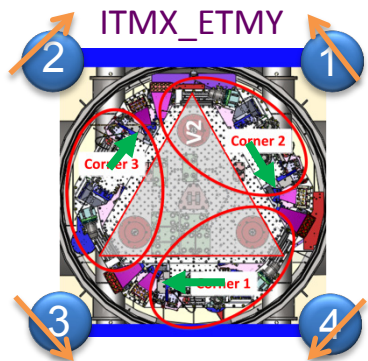
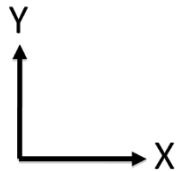

ITMX_ETMY:

ST1_CART2ACT =

-0.6667	0	-0.4057	0	0	0	0
0.3333	-0.5773	-0.4057	0	0	0	0
0.3333	0.5773	-0.4057	0	0	0	0
0	0	0	0.3333	-0.7023	-0.2767	
0	0	0	0.3333	0.5908	-0.4699	
0	0	0	0.3333	0.1116	0.7466	

BSC-ISI

Stage 2 CPS

BS_ITMY_ETMX:

ST2_CPS2CART =

0.5773	0	-0.5773	-0.0602	0.0613	-0.0012
-0.3333	0.6667	-0.3333	-0.0361	-0.0340	0.0701
0.4821	0.4821	0.4821	0	0	0
0	0	0	0.3333	0.3333	0.3333
0	0	0	-0.5057	-0.4767	0.9825
0	0	0	0.8425	-0.8592	0.0168

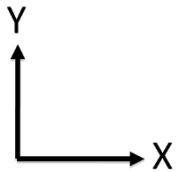
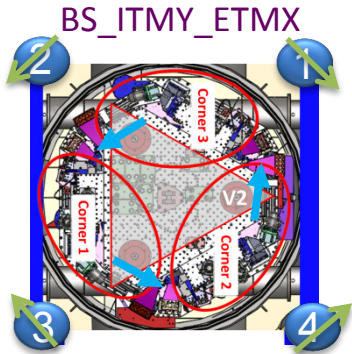

ITMX_ETMY:

ST2_CPS2CART =

0.3333	-0.6667	0.3333	0.0361	0.0340	-0.0701
0.5773	0	-0.5773	-0.0602	0.0613	-0.0012
0.4821	0.4821	0.4821	0	0	0
0	0	0	0.3333	0.3333	0.3333
0	0	0	-0.8425	0.8592	-0.0168
0	0	0	-0.5057	-0.4767	0.9825

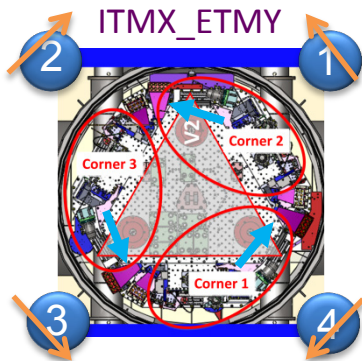

BSC-ISI

Stage 2 GS13

BS_ITMY_ETMX:

ST2_GS132CART =

0.5773	0	-0.5773	-0.0210	0.0420	-0.0210
-0.3333	0.6667	-0.3333	-0.0364	-0.0000	0.0364
0.4374	0.4374	0.4374	0	0	0
0	0	0	0.3333	0.3333	0.3333
0	0	0	-0.8419	-0.0000	0.8419
0	0	0	0.4861	-0.9721	0.4860

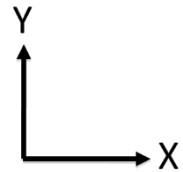
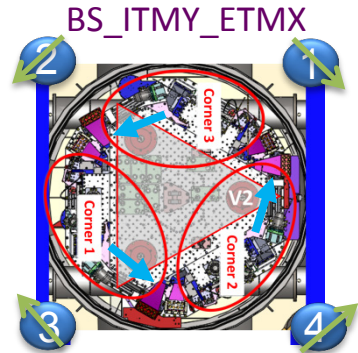

ITMX_ETMY:

ST2_GS132CART =

0.3333	-0.6667	0.3333	0.0364	0.0000	-0.0364
0.5773	0	-0.5773	-0.0210	0.0420	-0.0210
0.4374	0.4374	0.4374	0	0	0
0	0	0	0.3333	0.3333	0.3333
0	0	0	-0.4861	0.9721	-0.4860
0	0	0	-0.8419	-0.0000	0.8419

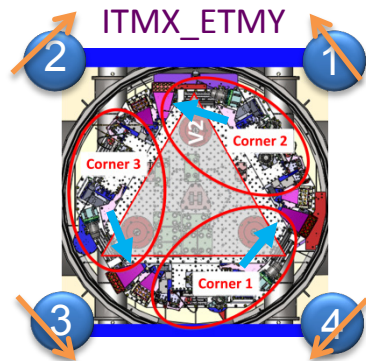

BSC-ISI

Stage 2 Actuator

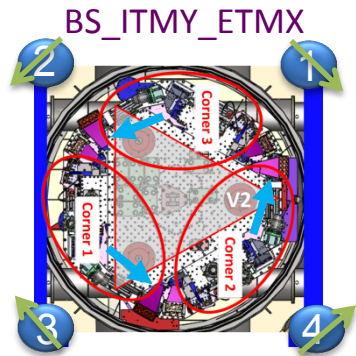

BS_ITMY_ETMX:

ST2_CART2ACT =

0.5773	-0.3333	0.5712	0	0	0
0	0.6667	0.5712	0	0	0
-0.5773	-0.3333	0.5712	0	0	0
0	0	0	0.3333	-0.6293	0.8253
0	0	0	0.3333	-0.4001	-0.9576
0	0	0	0.3333	1.0294	0.1324

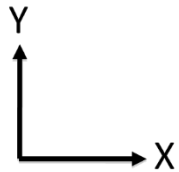

ITMX_ETMY:

ST2_CART2ACT =

0.3333	0.5773	0.5712	0	0	0
-0.6667	0	0.5712	0	0	0
0.3333	-0.5773	0.5712	0	0	0
0	0	0	0.3333	-0.8253	-0.6293
0	0	0	0.3333	0.9576	-0.4001
0	0	0	0.3333	-0.1324	1.0294

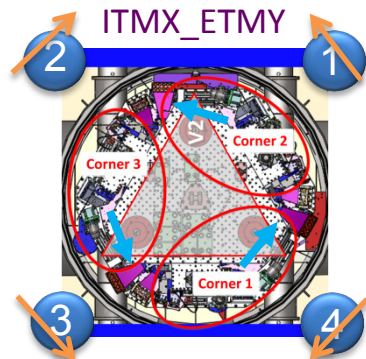

Appendix 1: Translation between new and former naming convention

The old convention (“X direction”, “Y direction” naming) is now obsolete and should not be used anywhere anymore

HAM-ISI in HAM 4, 5 and 6 used to be labeled “X direction” (because V1 GS13 points toward the X axis). The mat files containing their matrices are now labeled “[HAM_ISI_4_5_6](#)” for clarity.

HAM-ISI in HAM 2 and 3 used to be labeled “Y direction” (because V1 GS13 points toward the X axis). The mat files containing their matrices are now labeled “[HAM_ISI_2_3](#)” for clarity.

HAM-HEPI in HAM 4, 5 and 6 used to be labeled “Y direction” (because these chambers are aligned with the Y axis). The mat files containing their matrices are now labeled “[HAM_HEPI_4_5_6](#)” for clarity.

HAM-HEPI in HAM 2 and 3 used to be labeled “X direction” (because these chambers are aligned with the X axis). The mat files containing their matrices are now labeled “[HAM_ISI_2_3](#)” for clarity.

BSC-ISI in BS, ITMY and ETMX used to be labeled “X direction” (because V2 GS13 points toward the X axis). The mat files containing their matrices are now labeled “[BSC_ISI_BS_ITMY_ETMX](#)” for clarity.

BSC-ISI in ITMX and ETMY used to be labeled “Y direction” (because V1 GS13 points toward the X axis). The mat files containing their matrices are now labeled “[BSC_ISI_ITMX_ETMY](#)” for clarity.

BSC-HEPI in BS, ITMY and ETMX used to be labeled “Y direction” (because these chambers are aligned with the Y axis). The mat files containing their matrices are now labeled “[BSC_HEPI_BS_ITMY_ETMX](#)” for clarity.

BSC-HEPI in ITMX and ETMY used to be labeled “X direction” (because these chambers are aligned with the X axis). The mat files containing their matrices are now labeled “[BSC_HEPI_ITMX_ETMY](#)” for clarity.

Appendix 2:

**Example of Transfer Functions to establish instrument signs
to be applied in symetrization filters.**

HAM-HEPI IPS transfer functions*: - Actuators and IPS are in phase in this example.
 No sign correction necessary in the output symmetrization filters

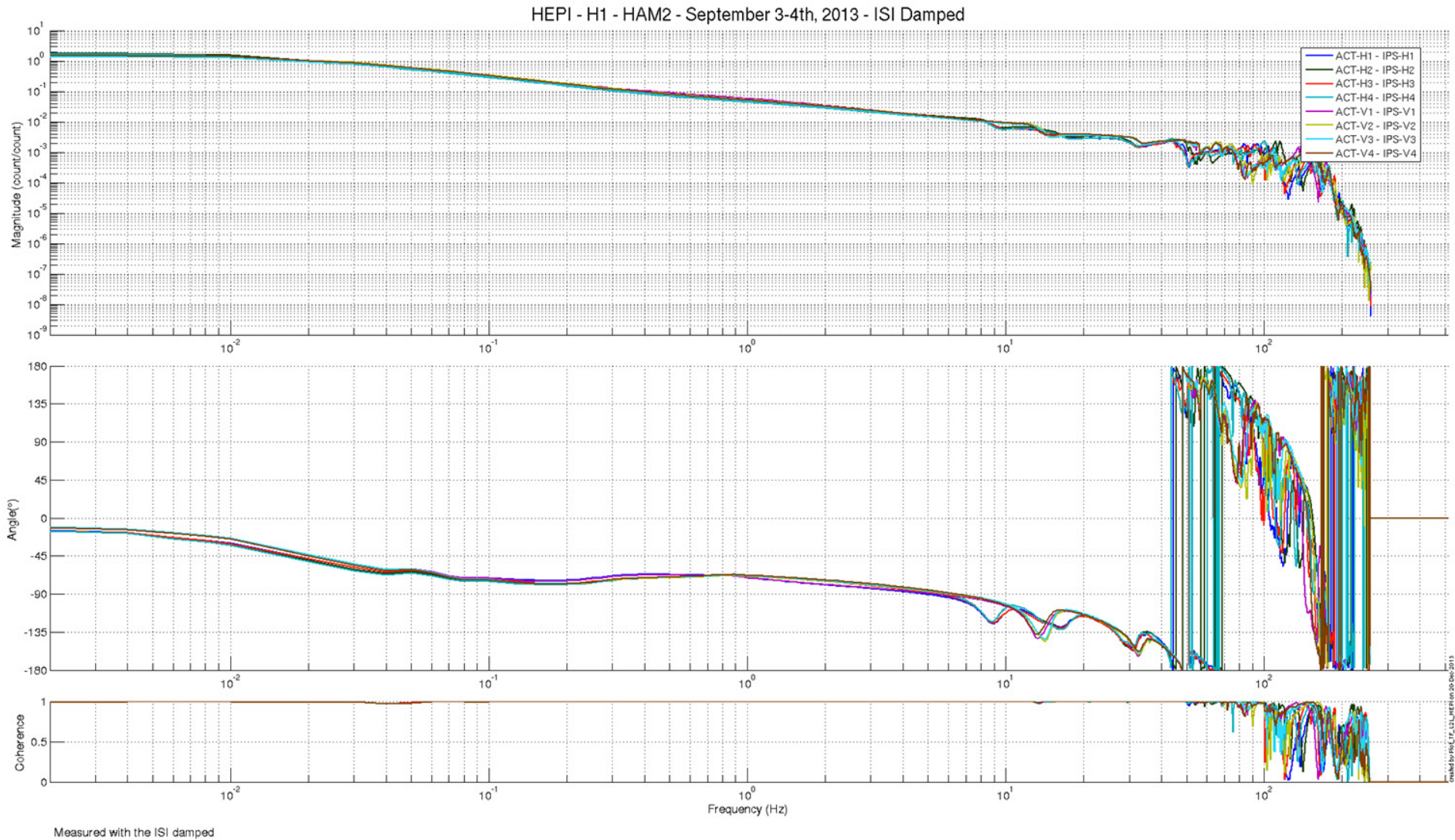

made by HE/C/LC/Letterton 30-Sep-2013

* Local to local transfer function: from local actuator “Exc channel” to “IN1 channel” in the local sensor input filter’s. Only the “Comp filter” must be engaged in the actuator bank (to partially revert the coil driver and actuator frequency response).

HAM-HEPI L4Cs transfer functions*:

- Actuators and horizontal L4Cs are in phase in this example. No sign correction needed in the input symmetrization filters of the Horizontal L4Cs

- Actuators and vertical L4Cs are out of phase in this example. A sign correction is necessary in the input symmetrization filters of the vertical L4Cs

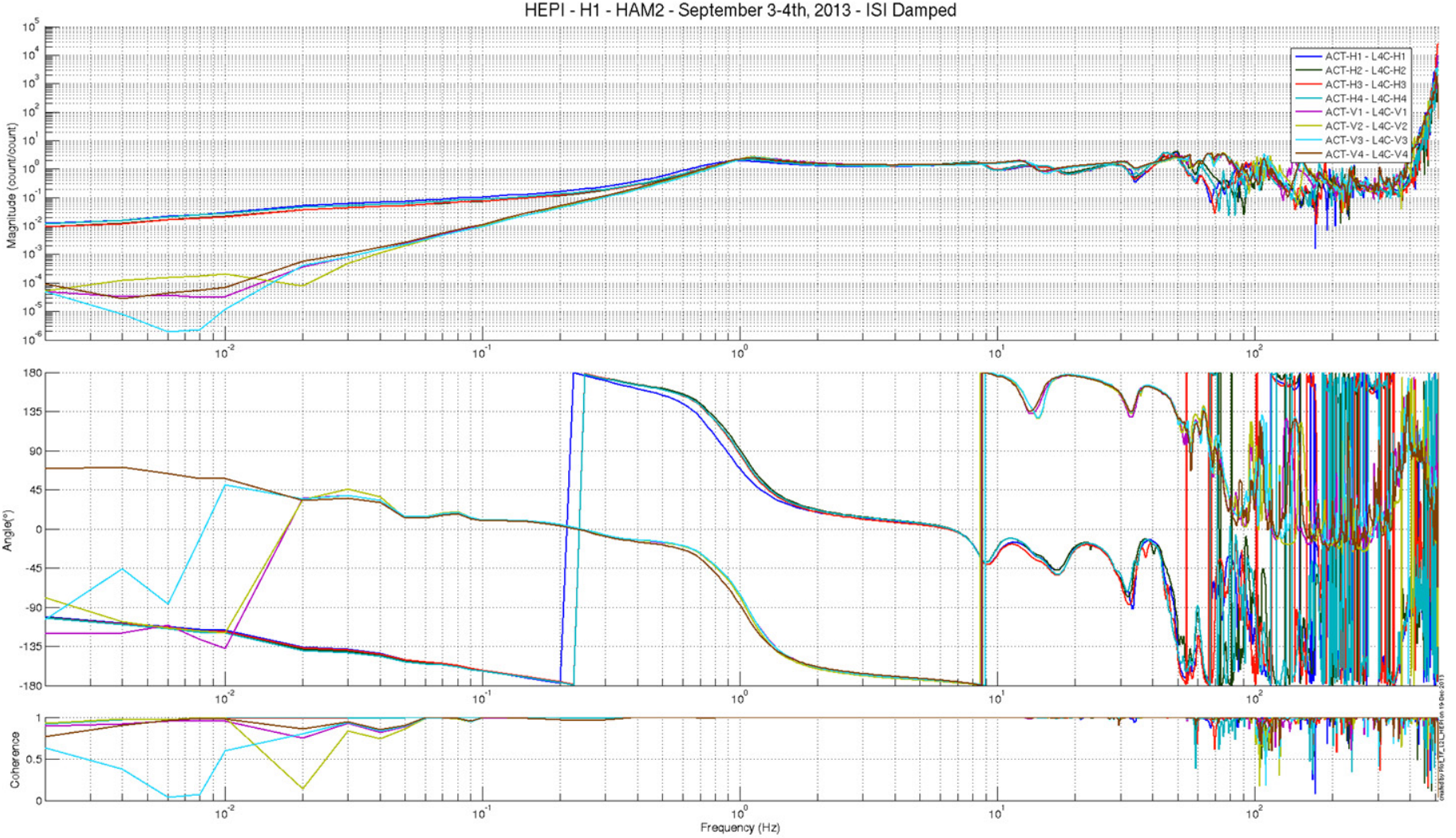

Measured with the ISI damped

* Local to local transfer function: from local actuator “Exc channel” to “IN1 channel” in the local sensor input filter’s. Only the “Comp filter” must be engaged in the actuator bank (to partially revert the coil driver and actuator frequency response).

BSC HEPI: Actuators and IPS are in phase.

HEPI - H1 - BSC1 - ITMY - August 16, 2013 - ISI damped

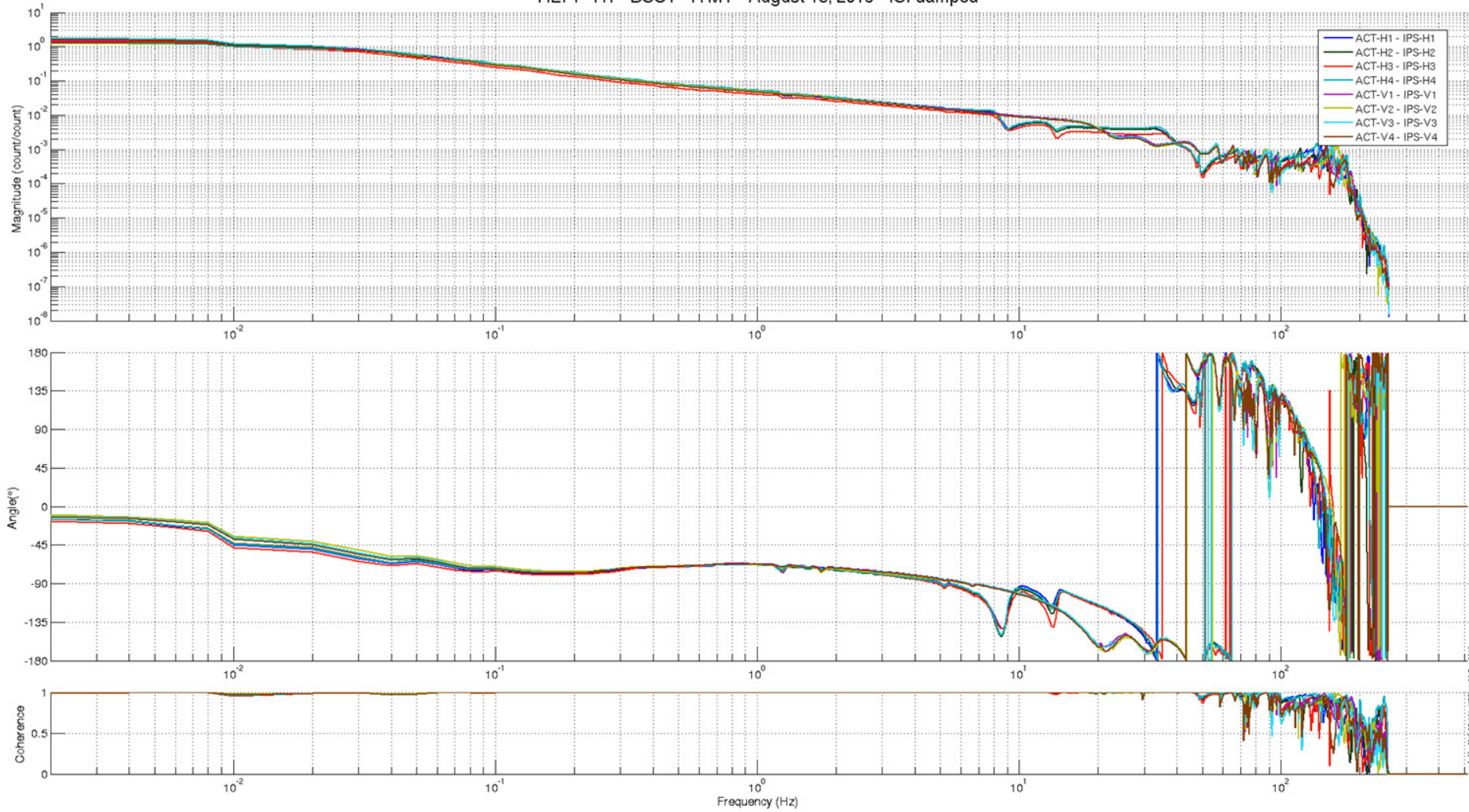

Measured with te ISI damped

made by PRC_IT_L3_L4_EPI on 08/16/2013

BSC-HEPI:

Actuators and L4Cs are out of phase. This is corrected in the symetrization filters.

HEPI - H1 - BSC1 - ITMY - August 16, 2013 - ISI damped

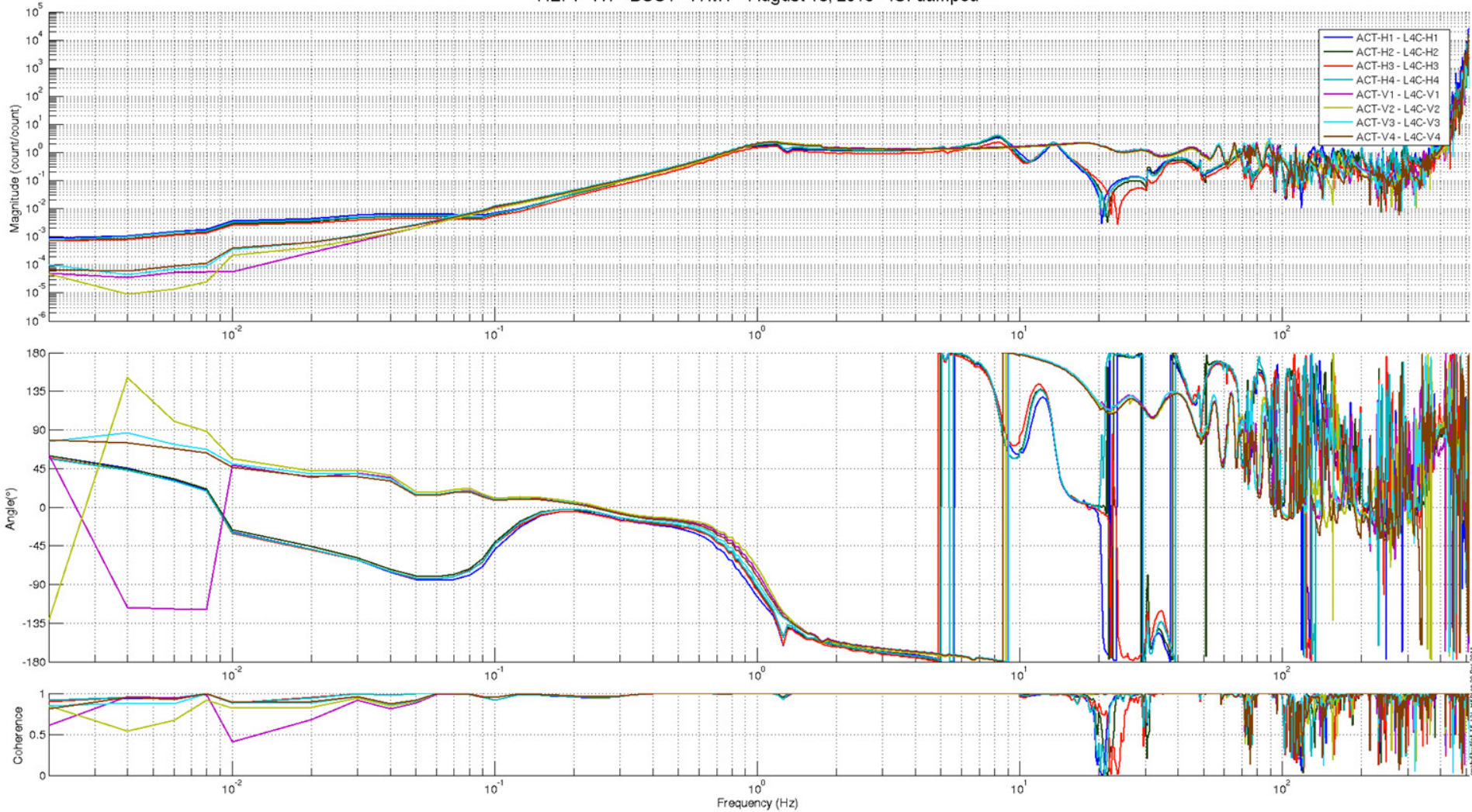

Measured with te ISI damped

HAM-ISI: Actuators and CPS are in phase.

LHO HAM2-ISI - HEPI locked - SUS Damped- Nov 18th 2013 PR3 Baffle and PD Array added

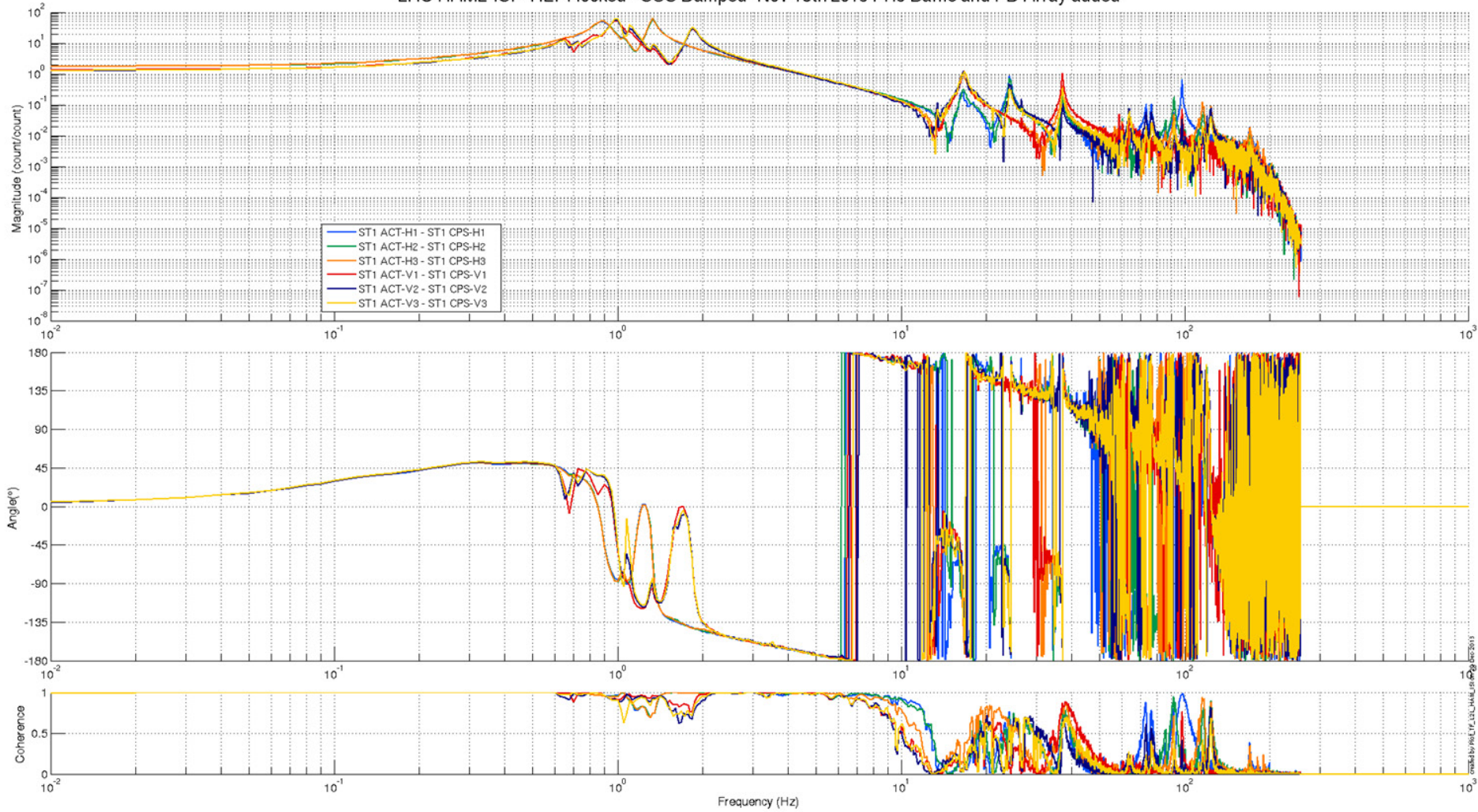

HAM-ISI: Actuators and GS13 are in phase.

LHO HAM2-ISI - HEPI locked - SUS Damped- Nov 18th 2013 PR3 Baffle and PD Array added

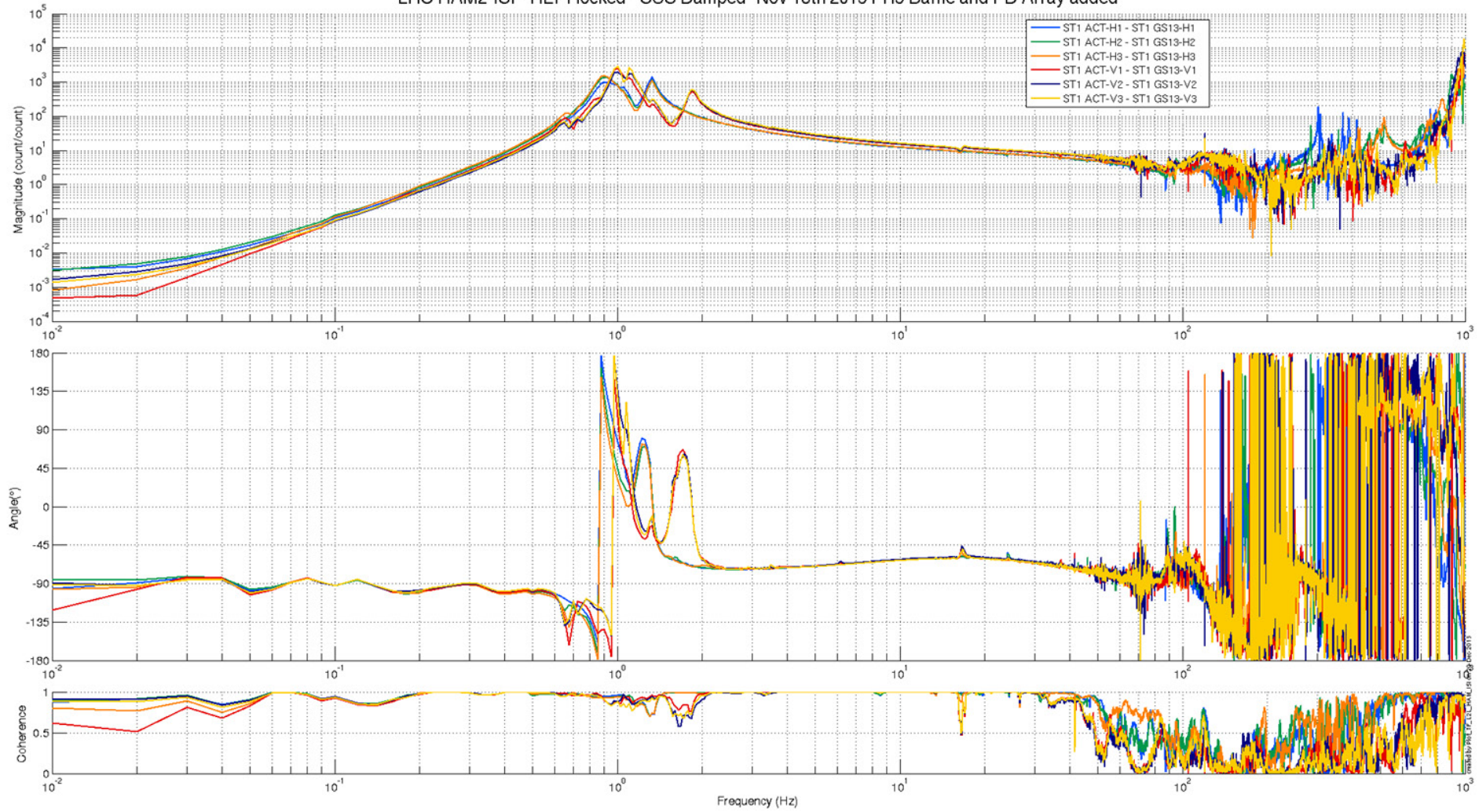

BSC-ISI: Stage1 Actuators and CPS are in phase.

Abbreviated for ITMX comparison -BSC-ISI - LHO - BSC2 - May 3th, 2013 - Cartridge - ITMY damped - In Vacuum

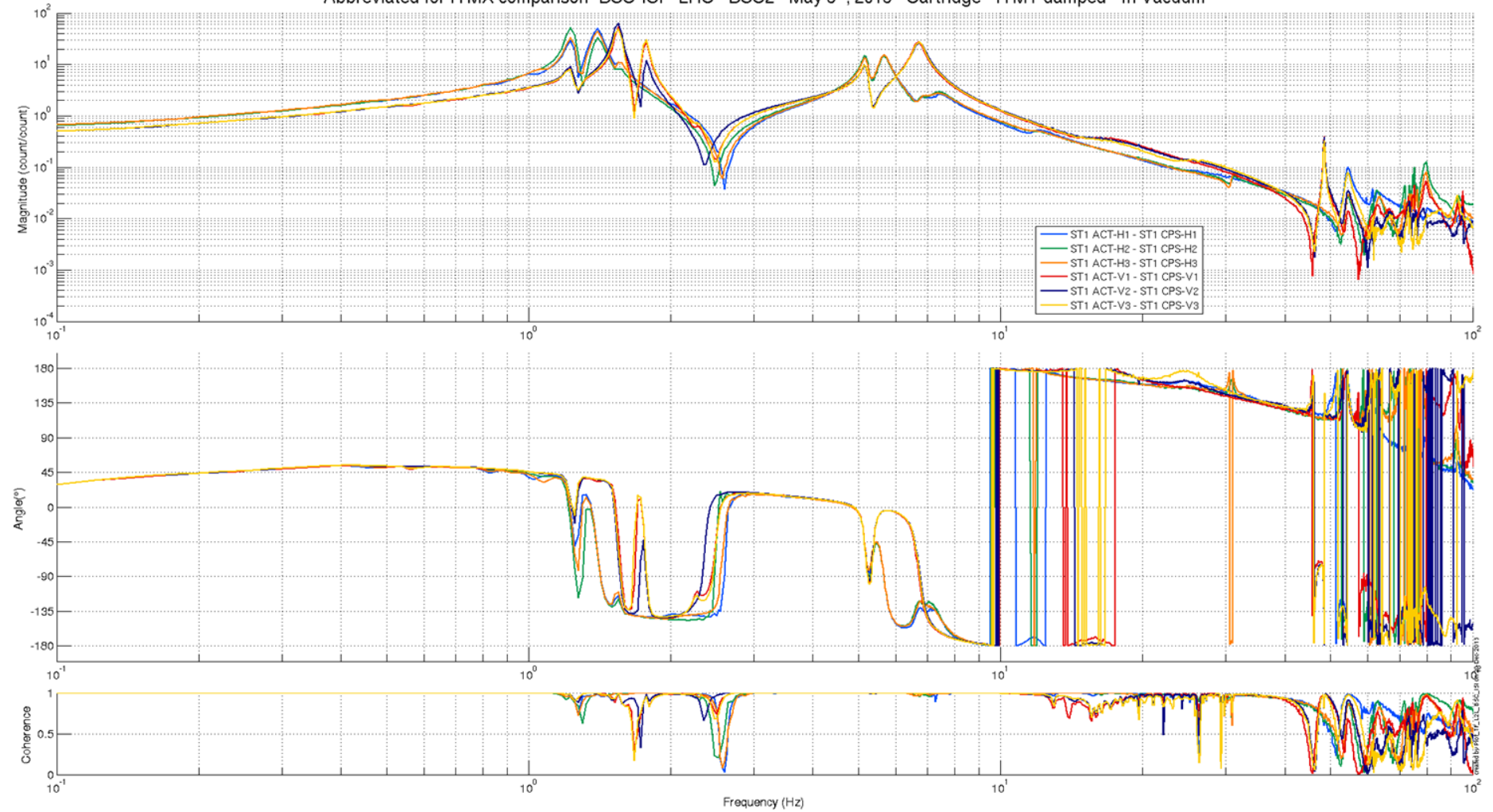

BSC-ISI: Stage 1 T240

- Actuators and Horizontal T240s are out of phase.
- Actuators and Vertical T240s are in phase.

No symmetrization Filters
Sign in the blend?
Cross couplings in matrices ok?

Abbreviated for ITMX comparison -BSC-ISI - LHO - BSC2 - May 3th, 2013 - Cartridge - ITMY damped - In Vacuum

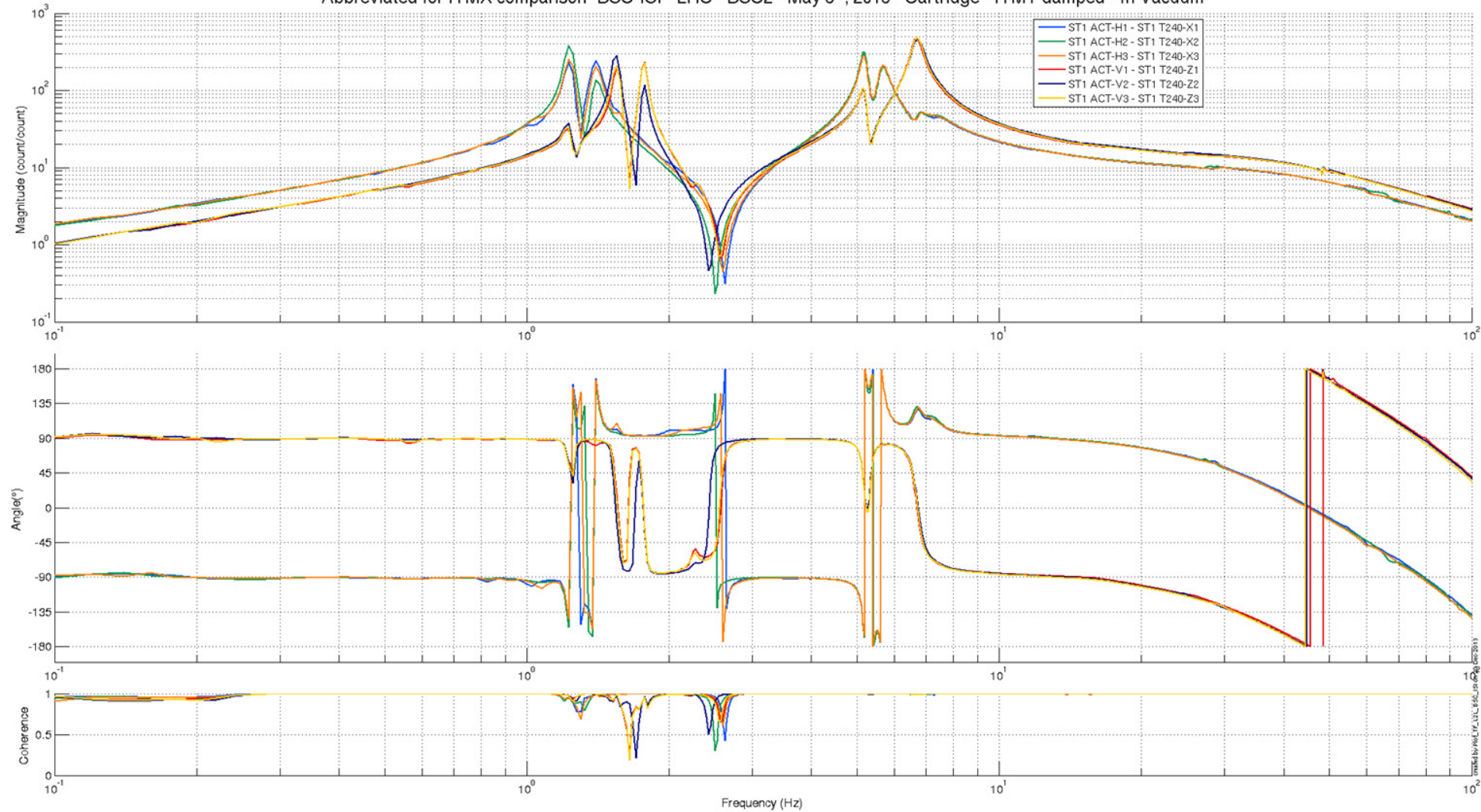

Analog gain mode?

BSC-ISI:

Stage 1 Actuators and L4Cs are out of phase. This is corrected in the symetrization filters.

Abbreviated for ITMX comparison -BSC-ISI - LHO - BSC2 - May 3th, 2013 - Cartridge - ITMY damped - In Vacuum

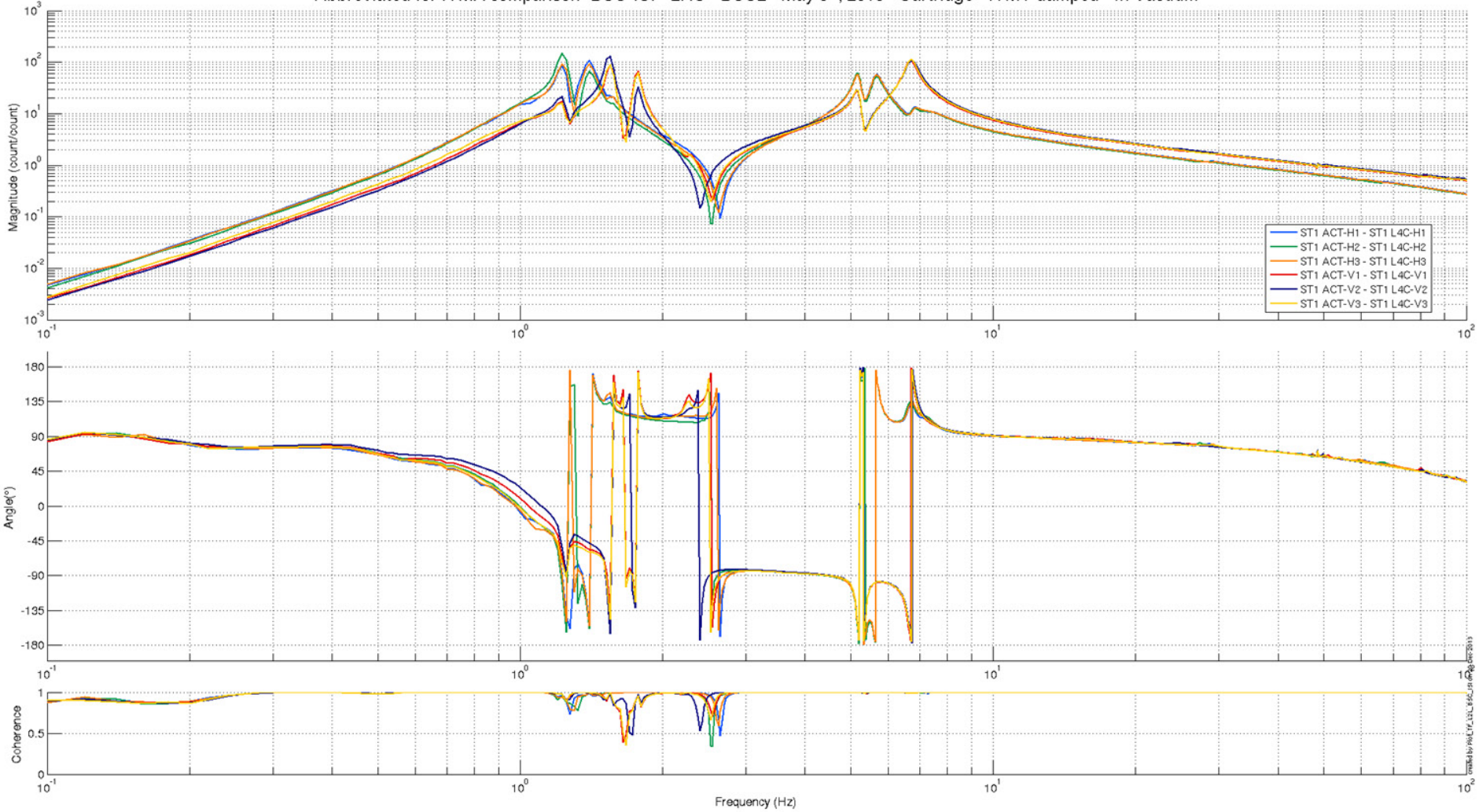

Analog gain mode?

BSC-ISI: Stage 2 Actuators and CPS are in phase.

Abbreviated for ITMX comparison -BSC-ISI - LHO - BSC2 - May 3th, 2013 - Cartridge - ITMY damped - In Vacuum

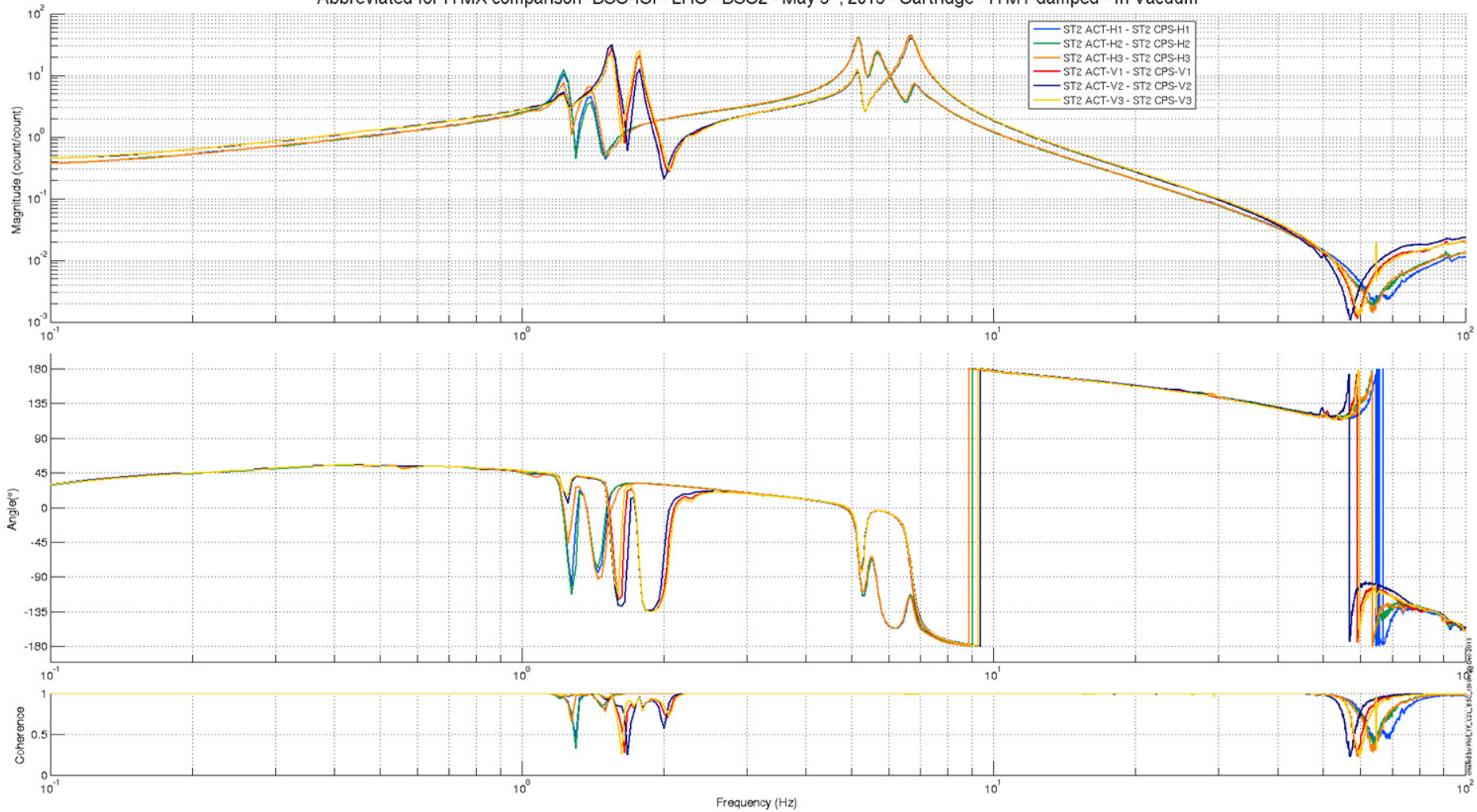

BSC-ISI: Stage 2 Actuators and GS13s are in phase.

Abbreviated for ITMX comparison -BSC-ISI - LHO - BSC2 - May 3th, 2013 - Cartridge - ITMY damped - In Vacuum

