

# HAM ISI Test Stand

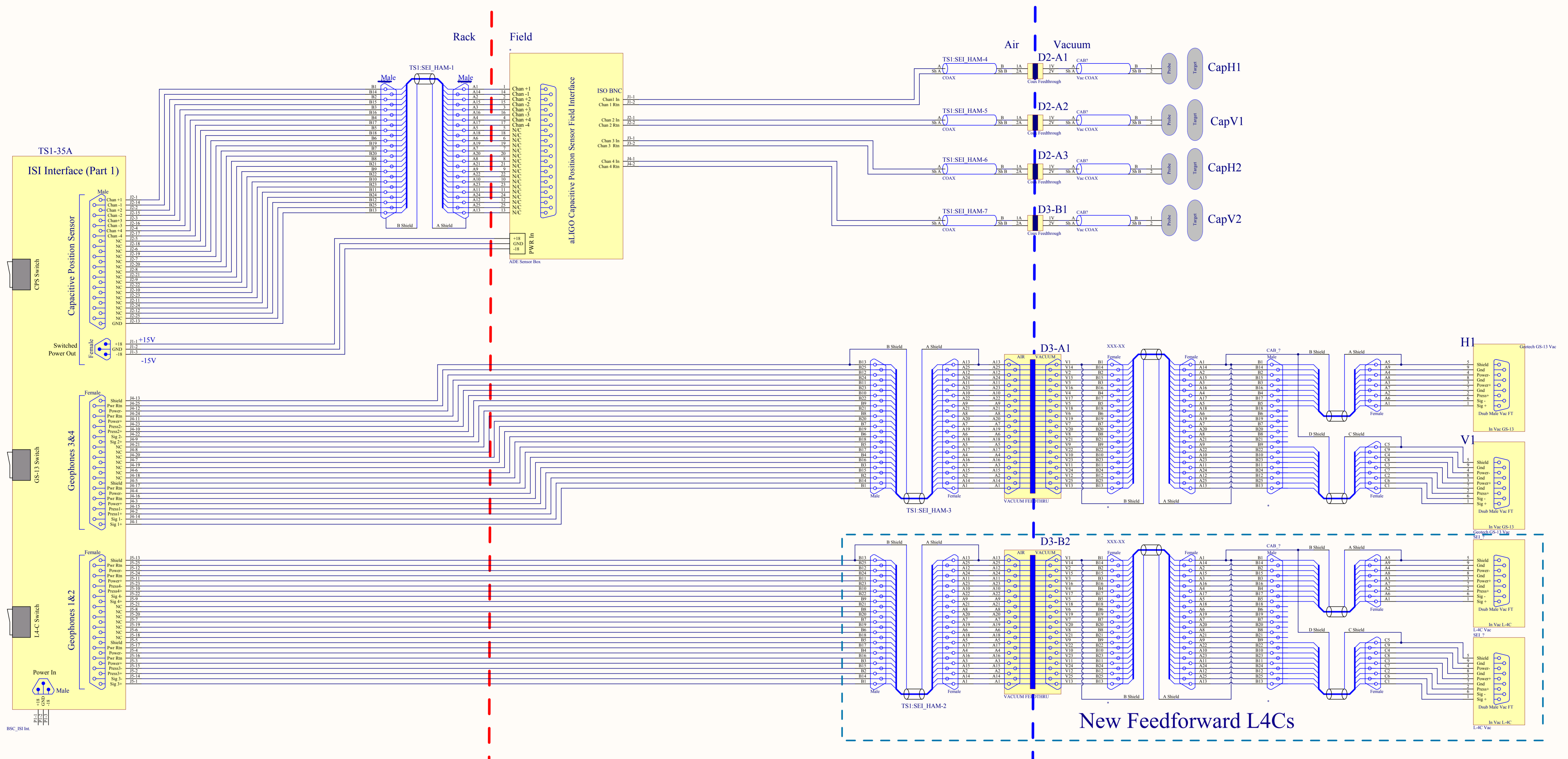

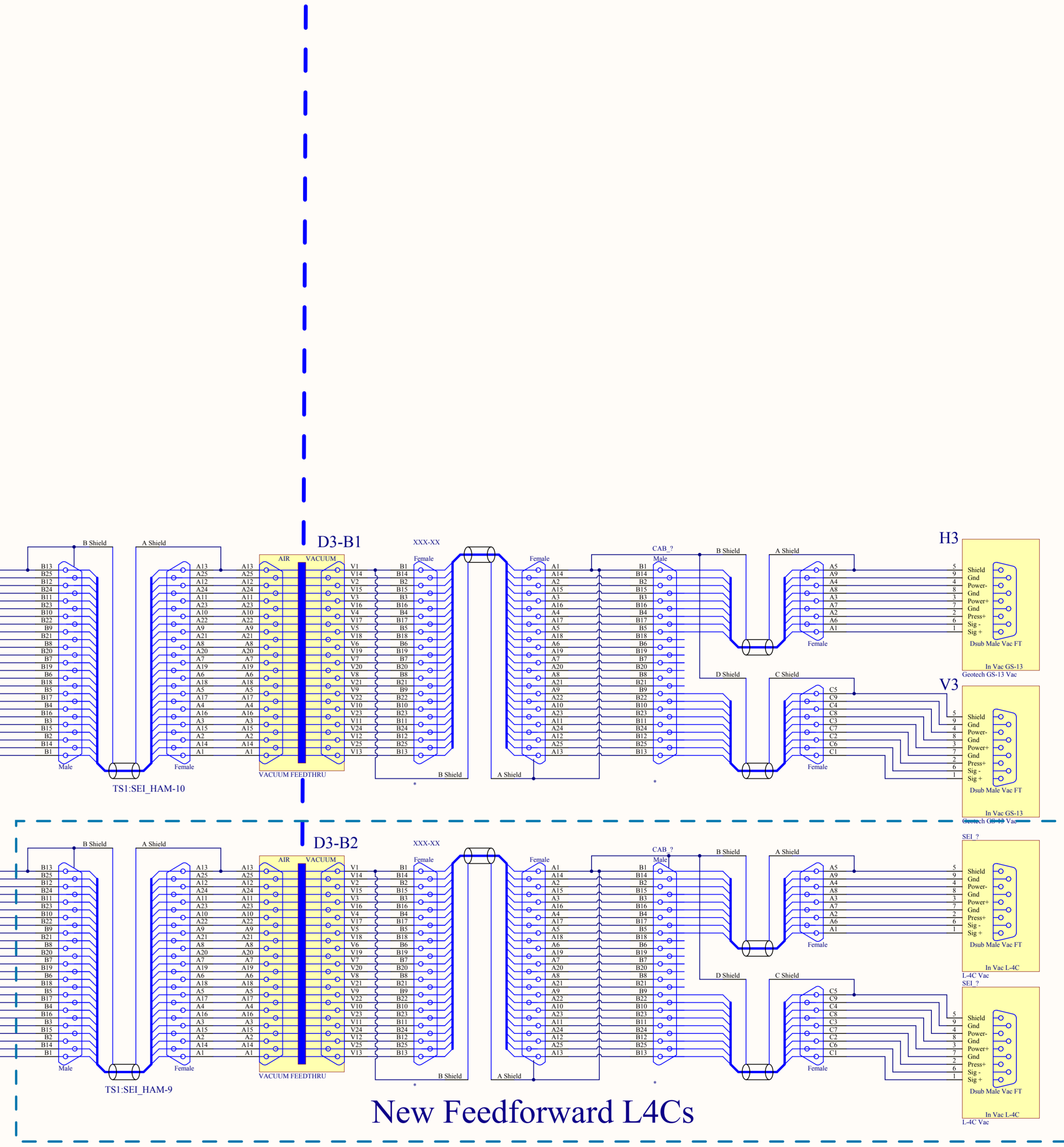

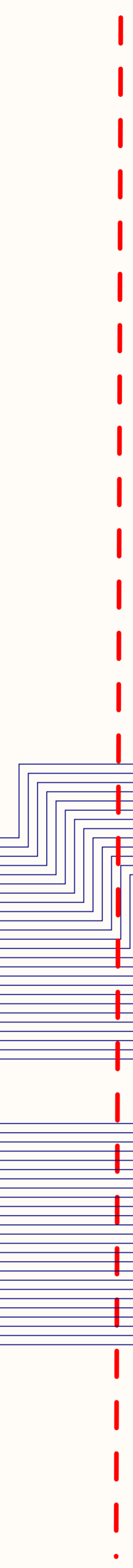

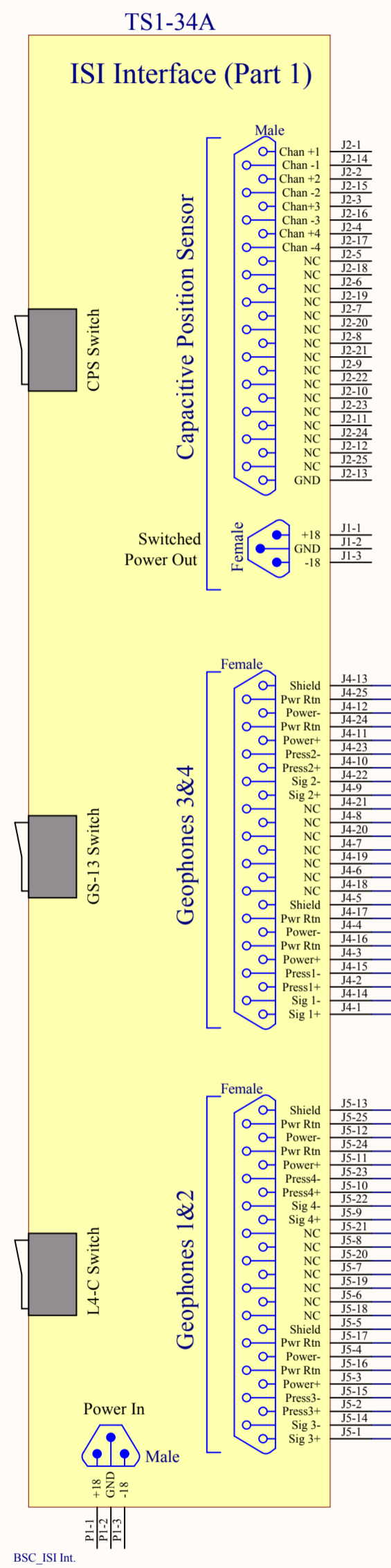
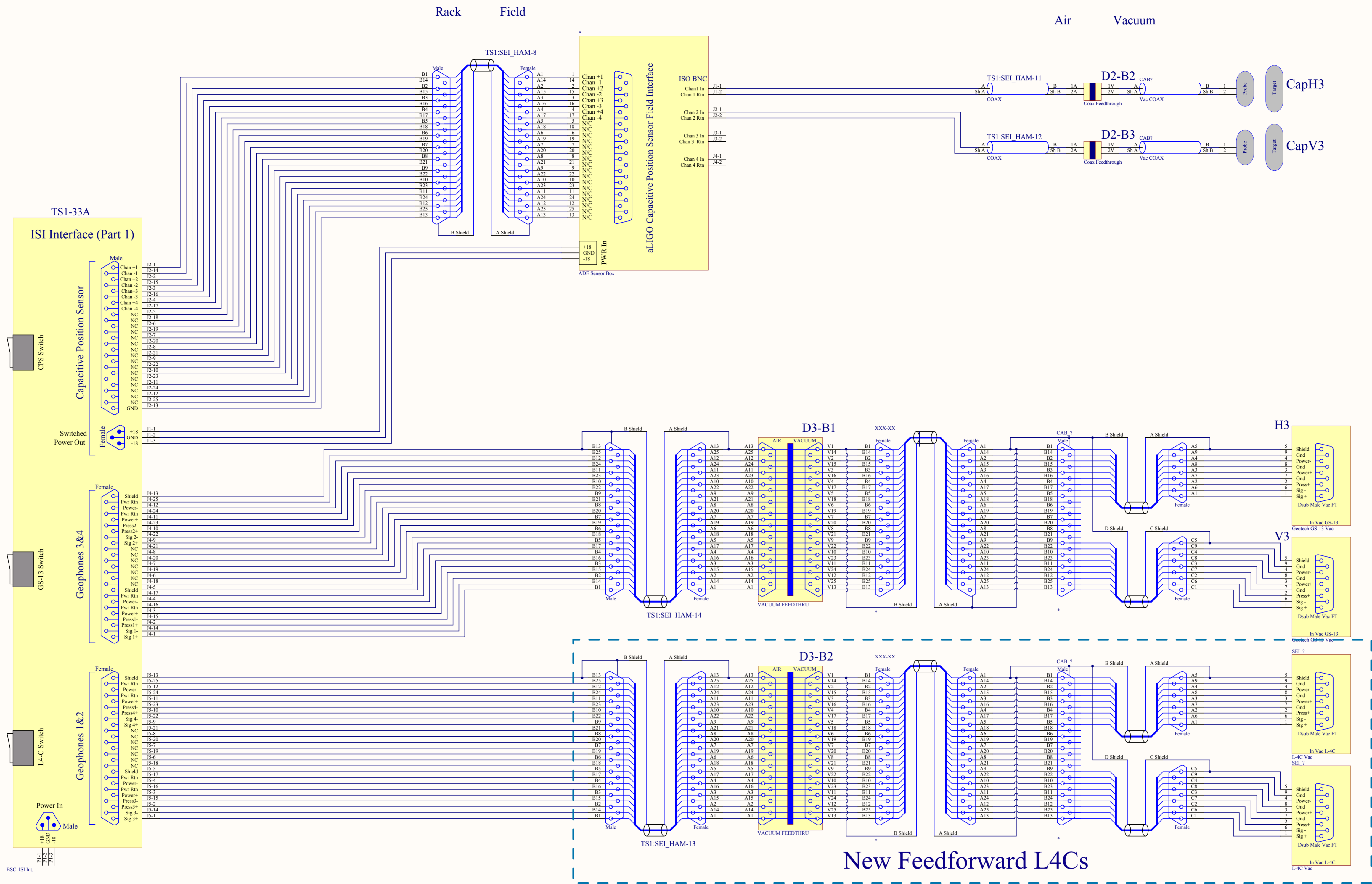

New Feedforward L4Cs



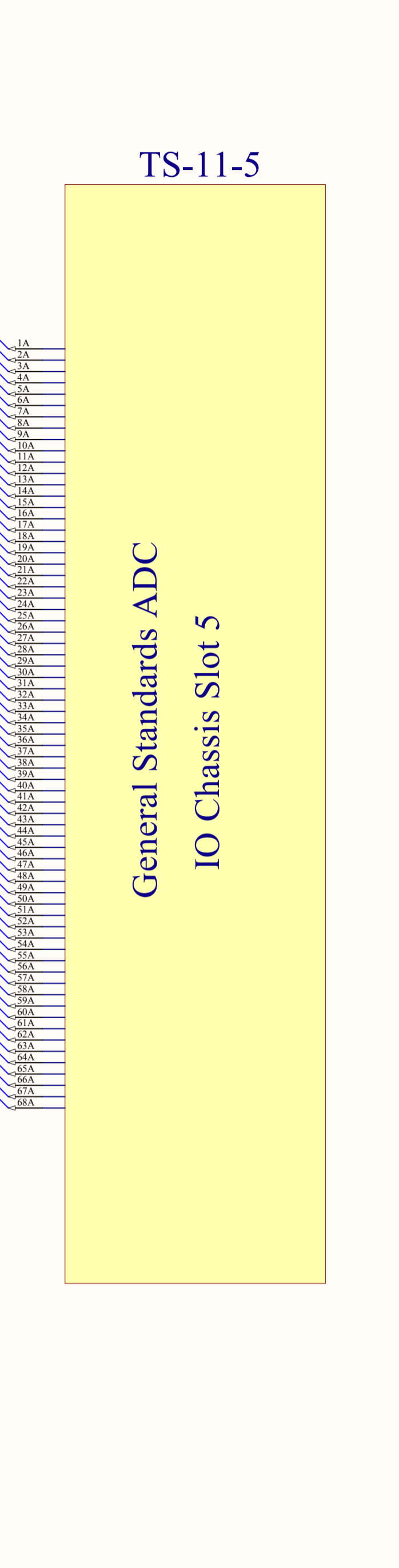
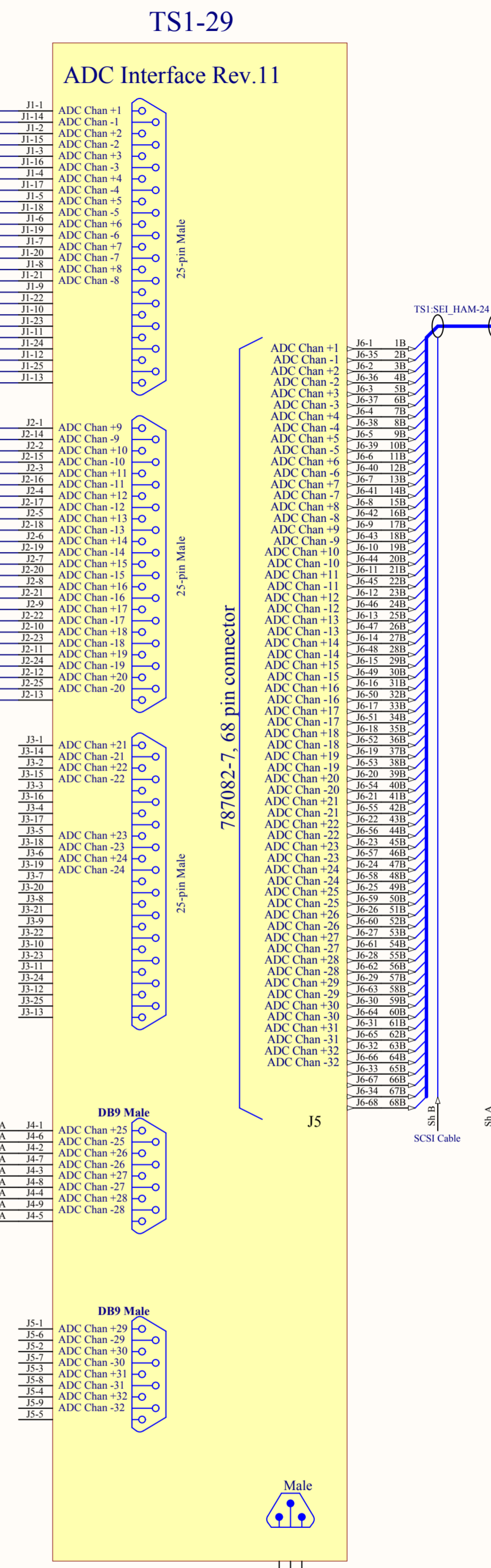
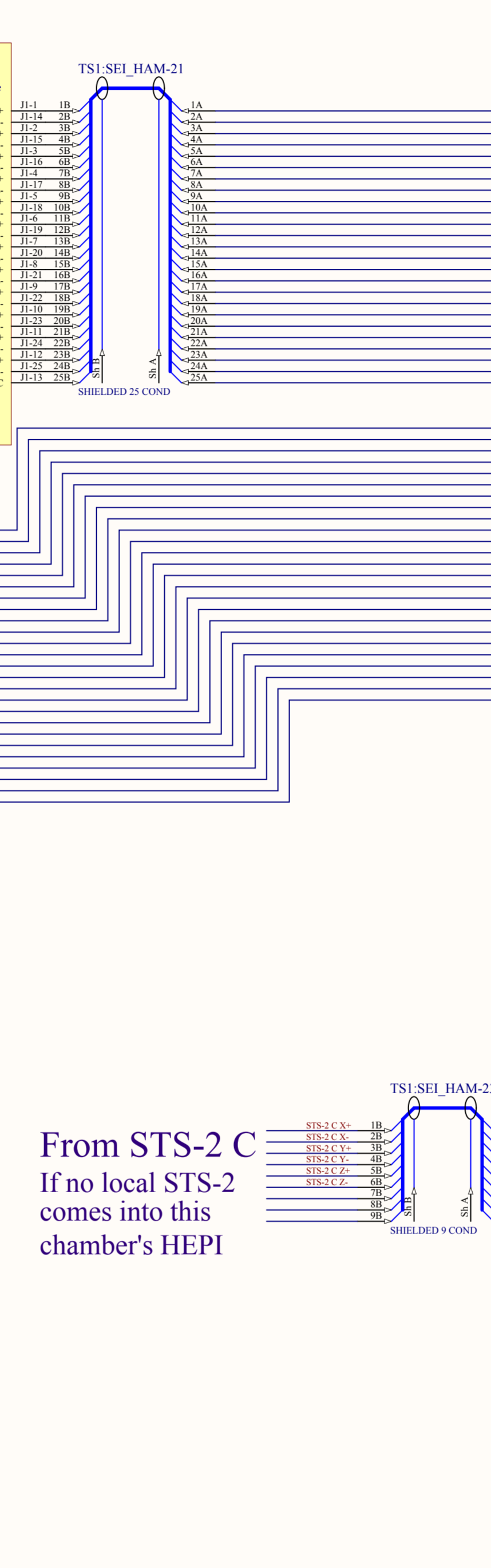
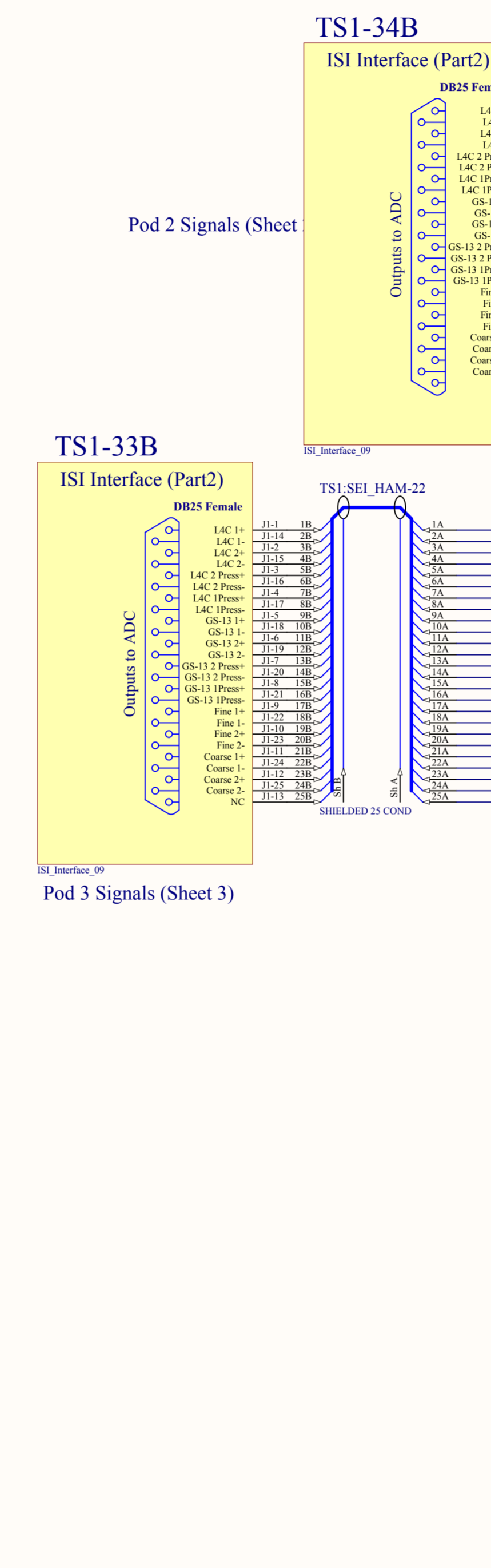
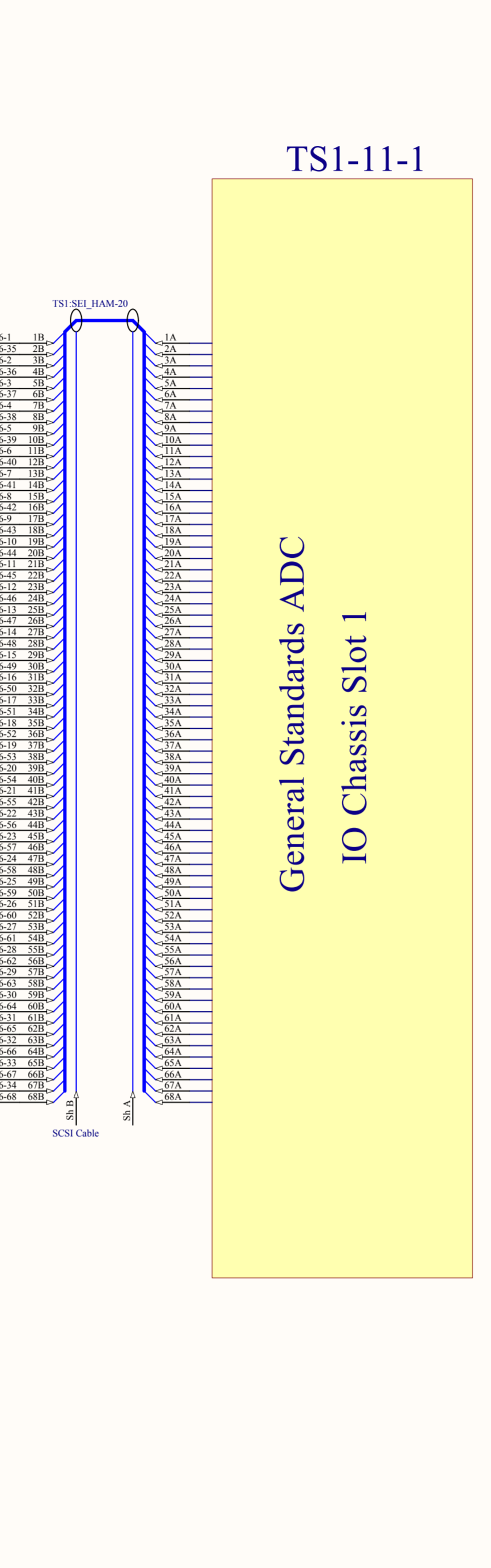
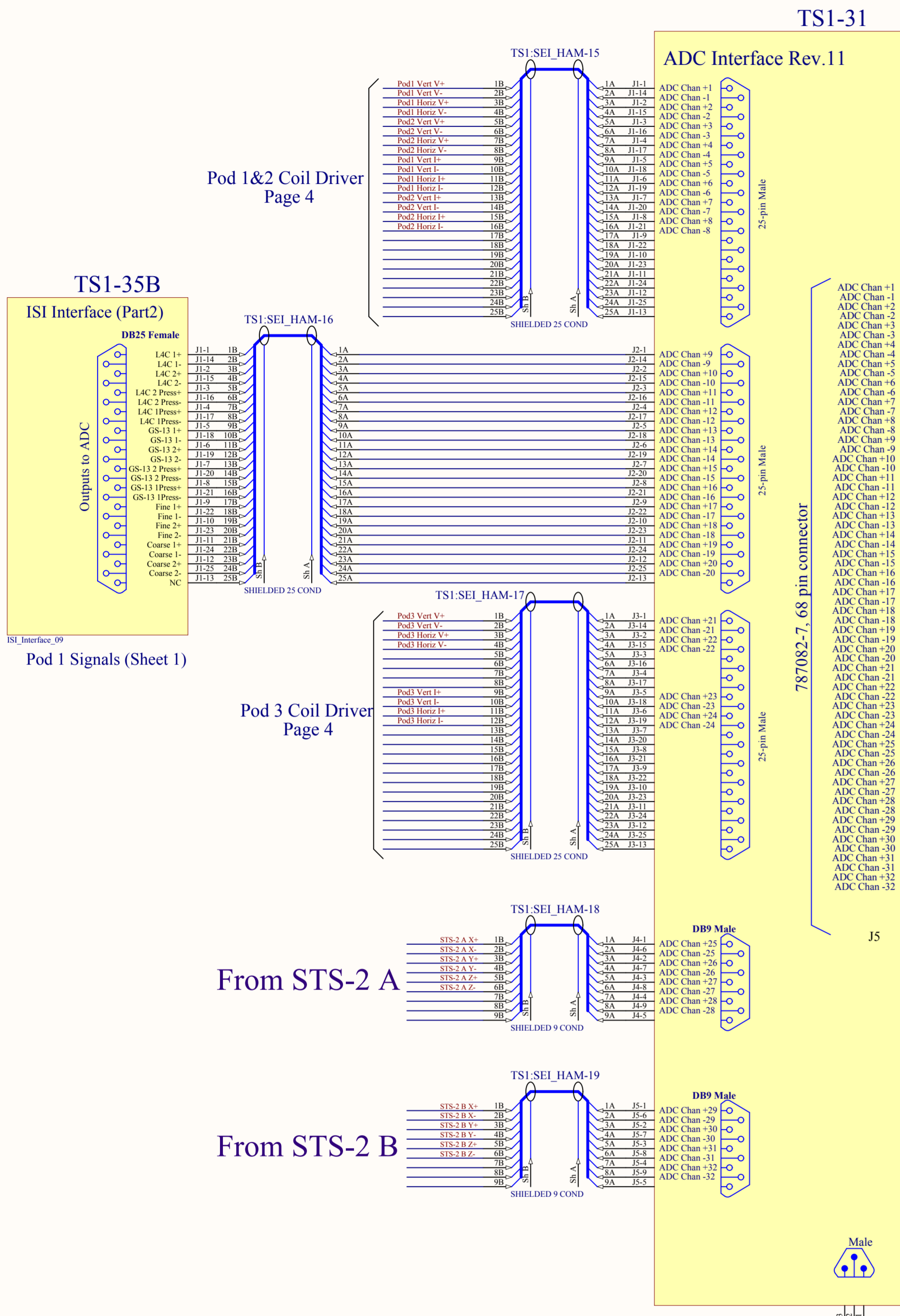



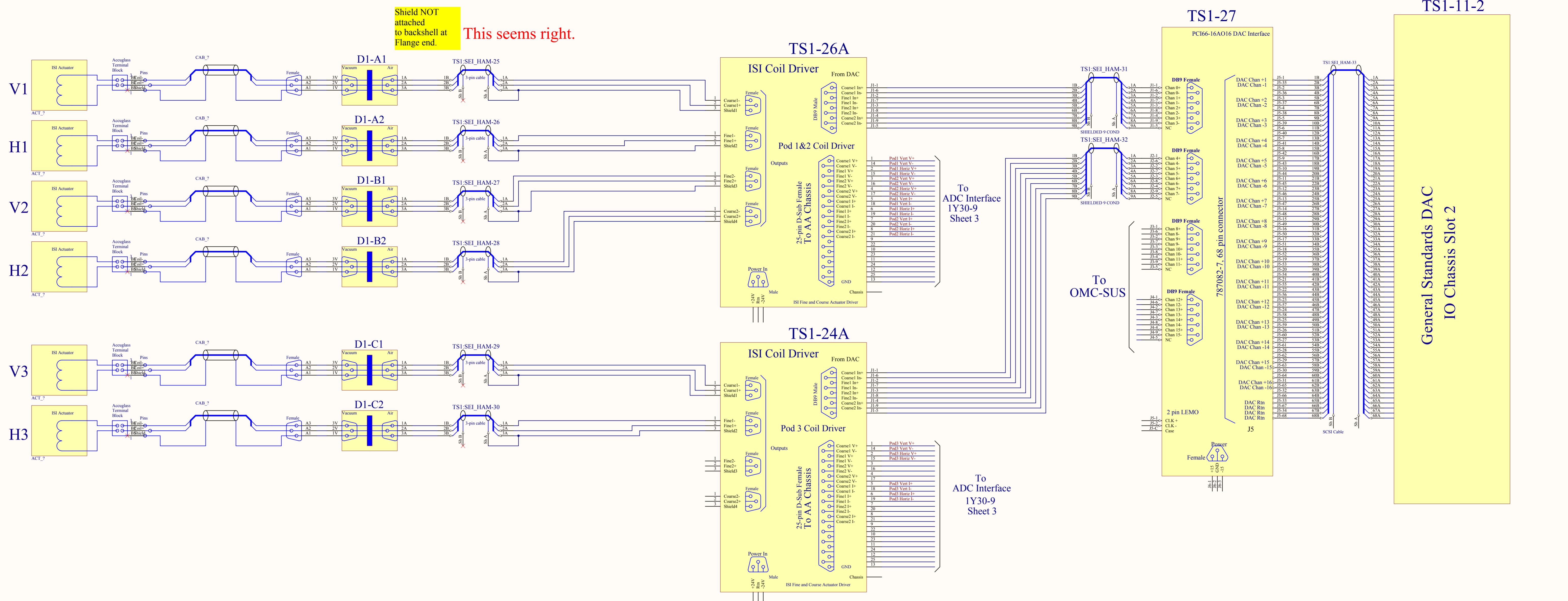

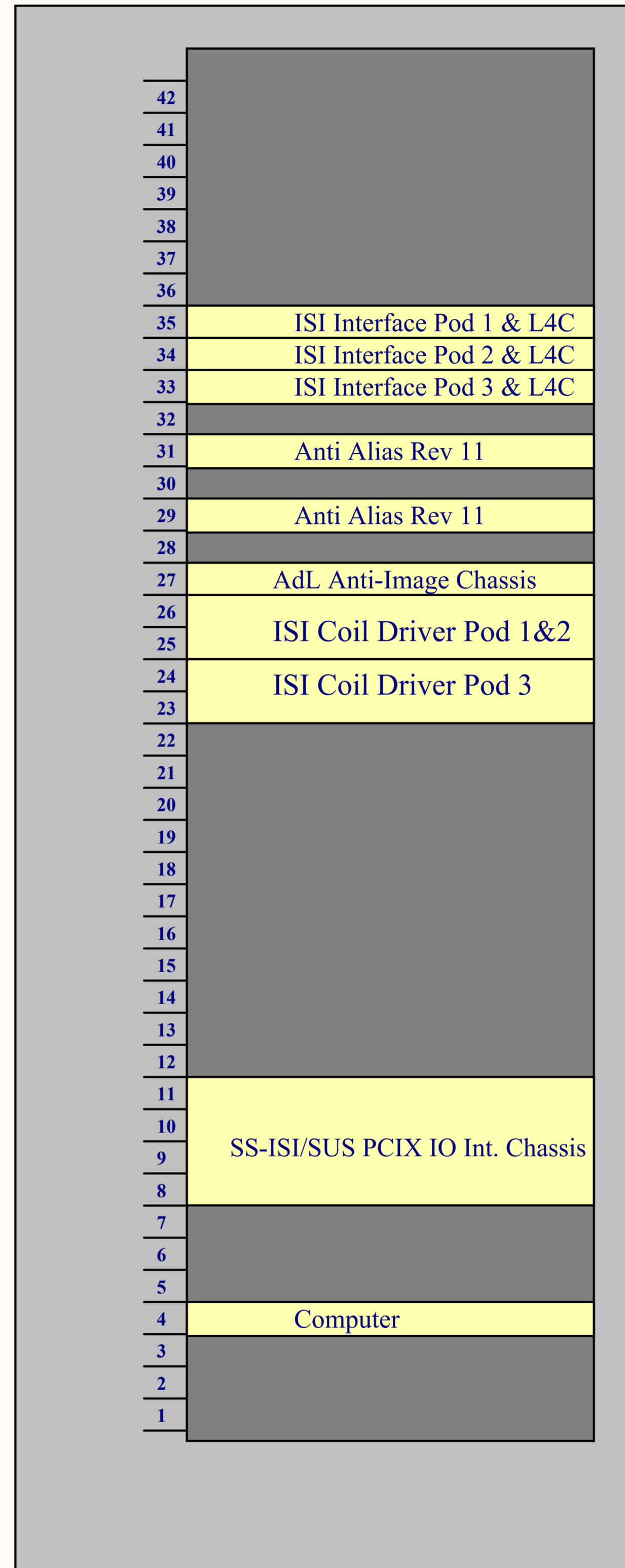

# Test Stand 1



Title <b><i>HAM ISI Test Stand System Wiring</i></b>			
Size: <b>B</b>	DCC Number: D1001412		<i>Ligo Project</i> <i>California Institute of Technology</i> <i>Massachusetts Institute of Technology</i> 
Drawn by: Ben Abbott	Date: 6/28/2010	Revision: v3	
File: C:\Ben\Seismic\ISI\Single Stage ISI\TestStands\AdLSEI_Single_Stage\T1\TechDraw\38:27 AM Sheet 6 of 6			