

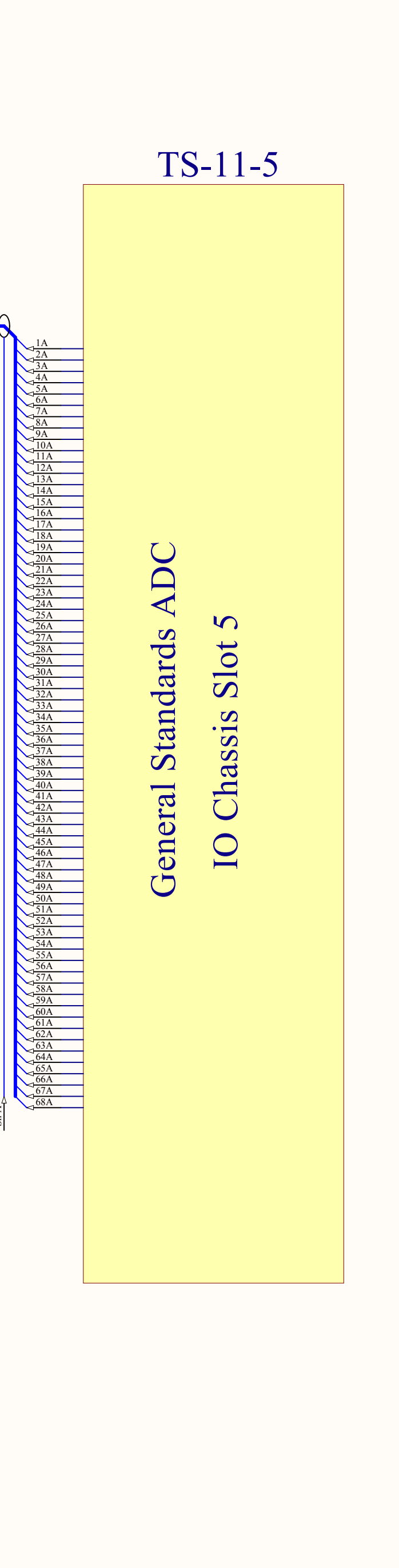

New Feedforward L4Cs

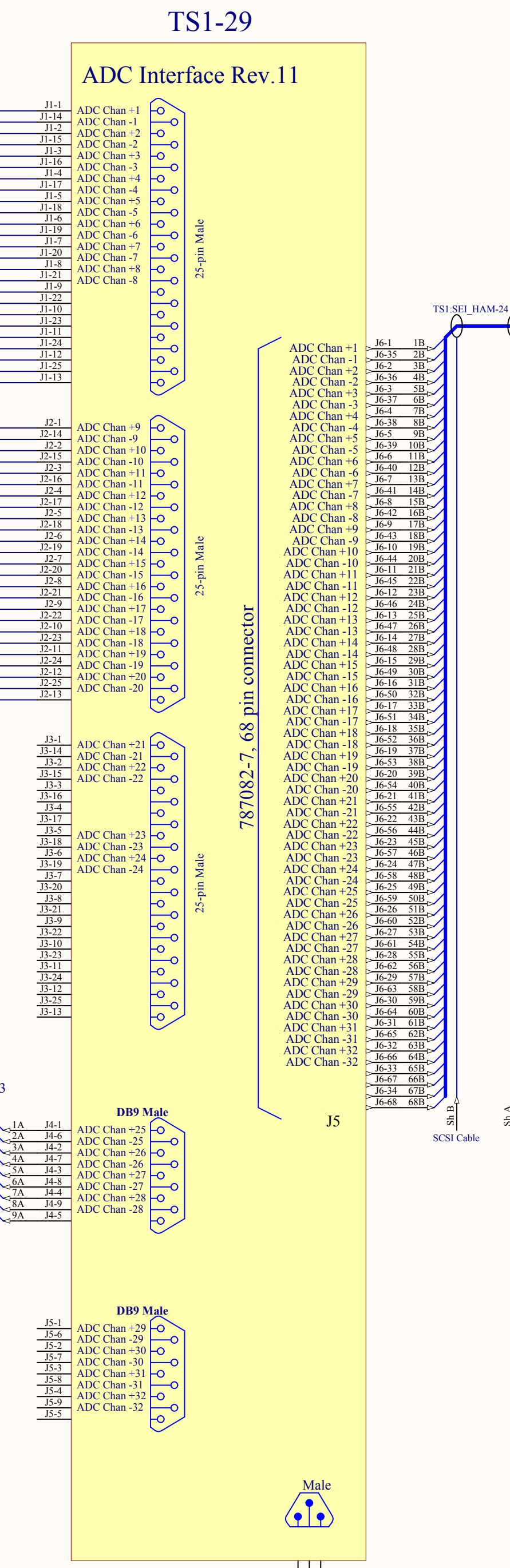

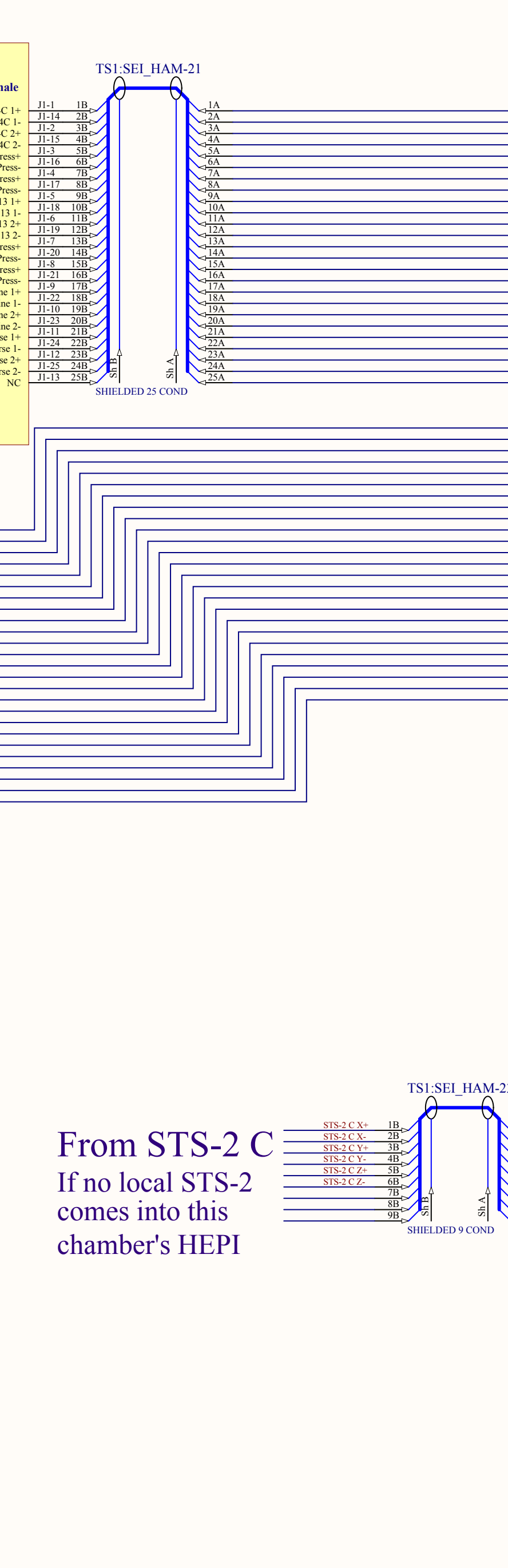
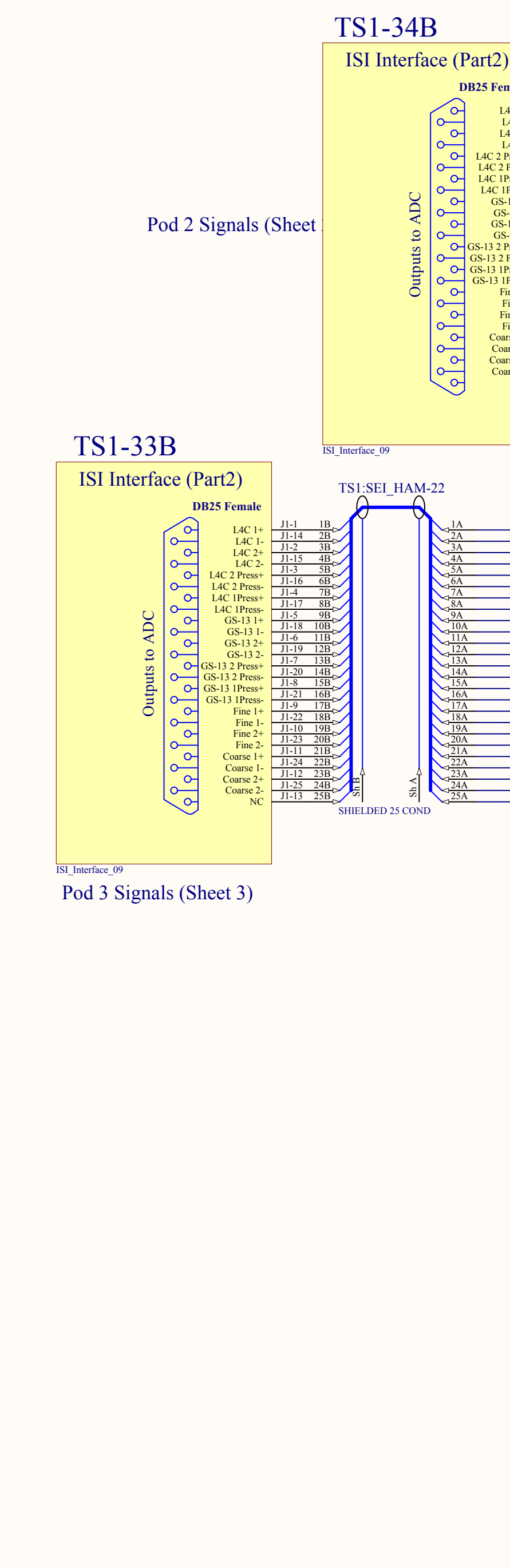
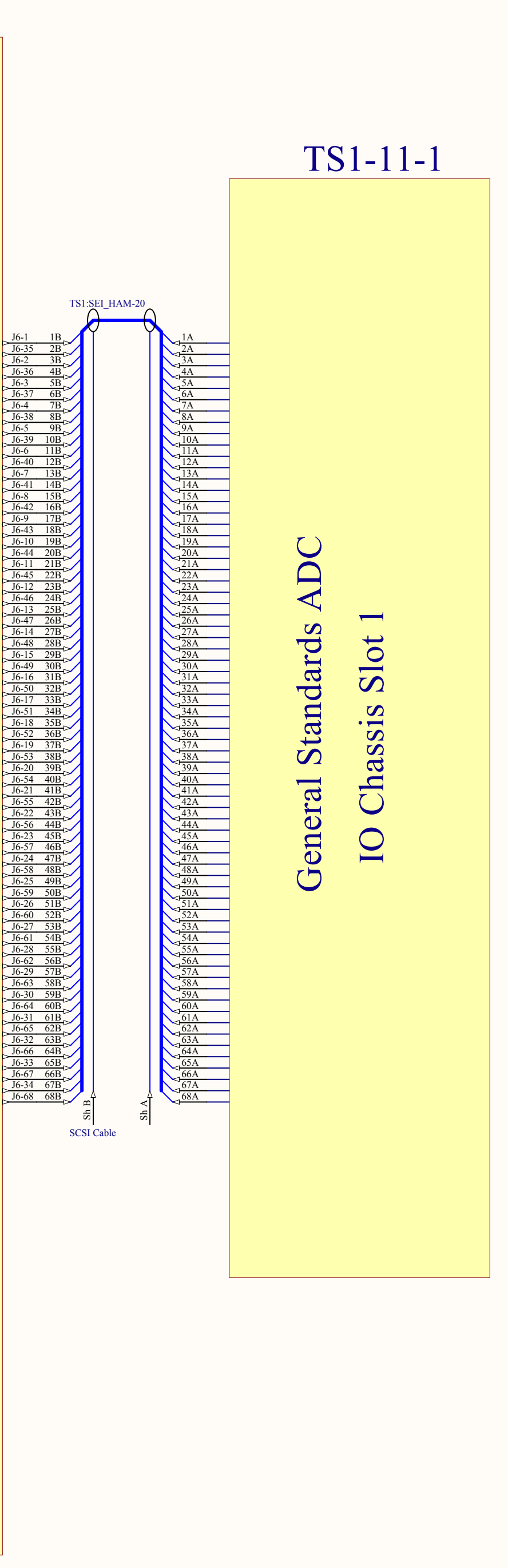
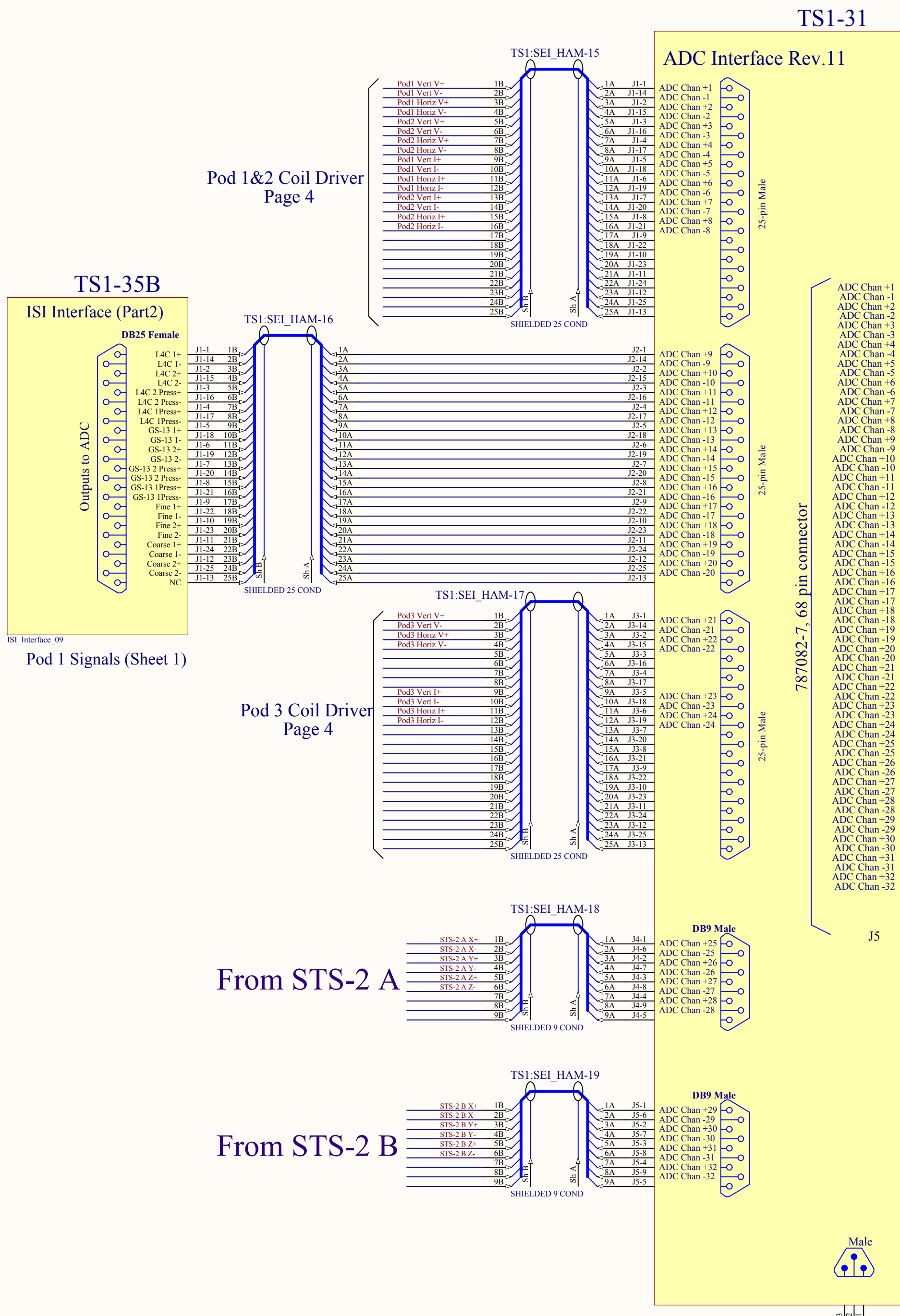
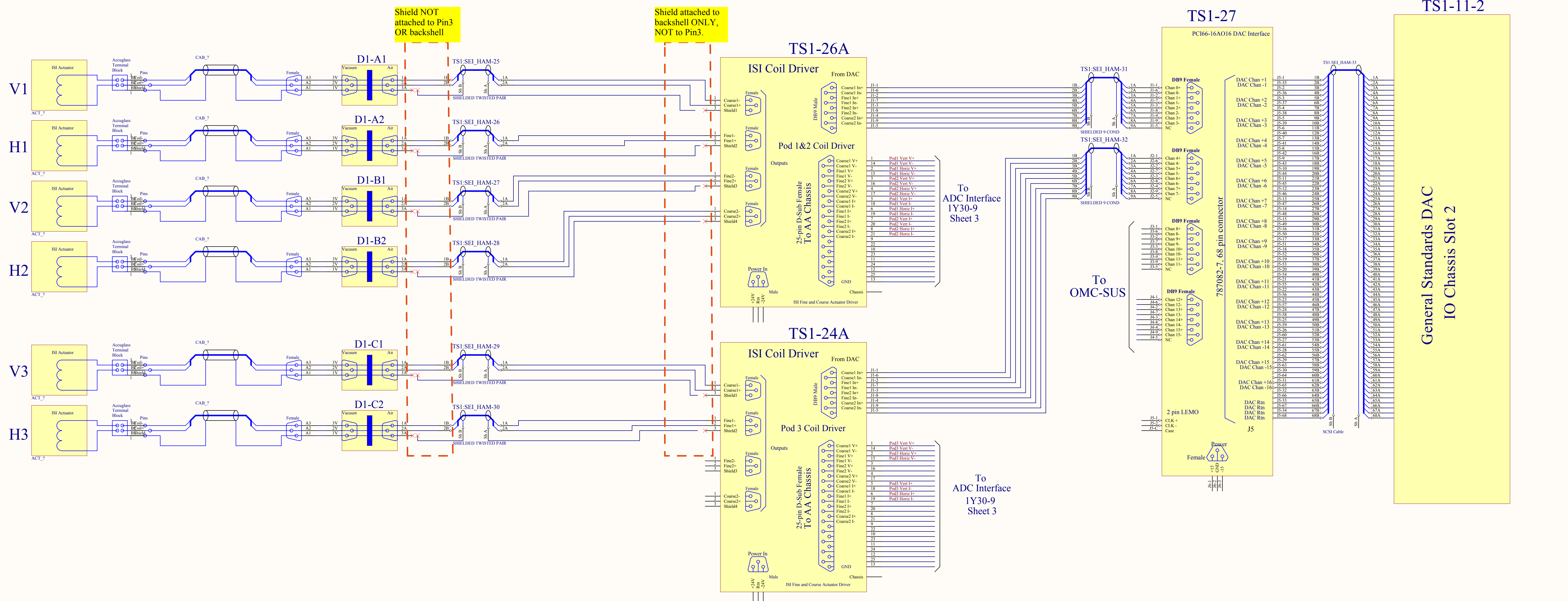
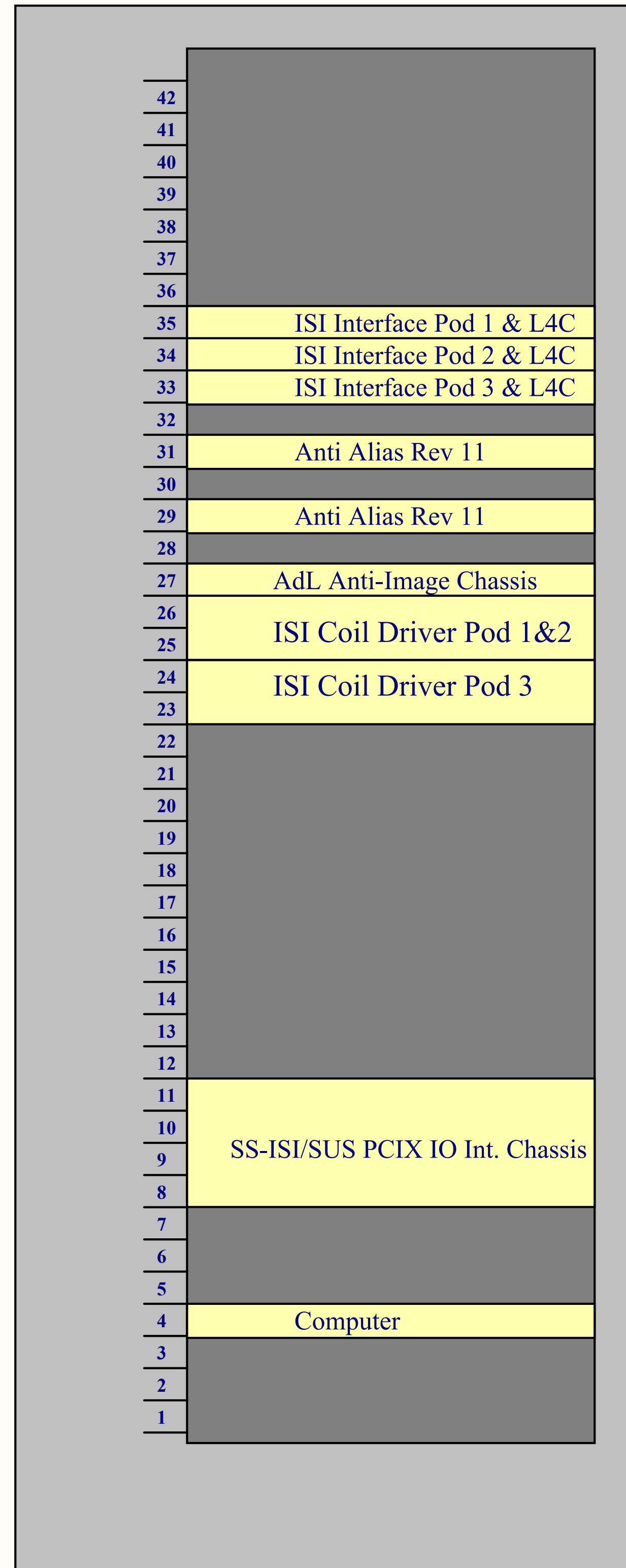

Test Stand 1



Title HAM ISI System Wiring			
Size: B	DCC Number: D1001412	<i>Ligo Project</i> <i>California Institute of Technology</i> <i>Massachusetts Institute of Technology</i>	
Drawn by: Ben Abbott	Date: 6/1/2010	Revision: v1	
File: C:\Ben\Seismic\ISI\Single Stage ISI\TestStands\AdLSEI_Single_Stage\T1\TechDraw\30:36 AMSheet 6 of 6			