



How to Build a Gravitational-wave Detector



*Stan Whitcomb
LIGO/Caltech*

*1st Galileo-XuGuangqi meeting
26 October 2009*

LIGO-G0900960-v1





Outline of Talk

- Focus on Ground-based Laser Interferometers
- The Challenges
 - » Sensitivity / Noise Sources
 - » Organization and Management
 - » Integration as the Key Element
- Closing thoughts

Detecting GWs with Interferometry

Suspended mirrors act as “freely-falling” test masses (in horizontal plane) for frequencies $f \gg f_{pend}$

$$h = \Delta L / L$$

Terrestrial detector
 For $h \sim 10^{-22} - 10^{-21}$
 $L \sim 4 \text{ km (LIGO)}$
 $\Delta L \sim 10^{-18} \text{ m}$

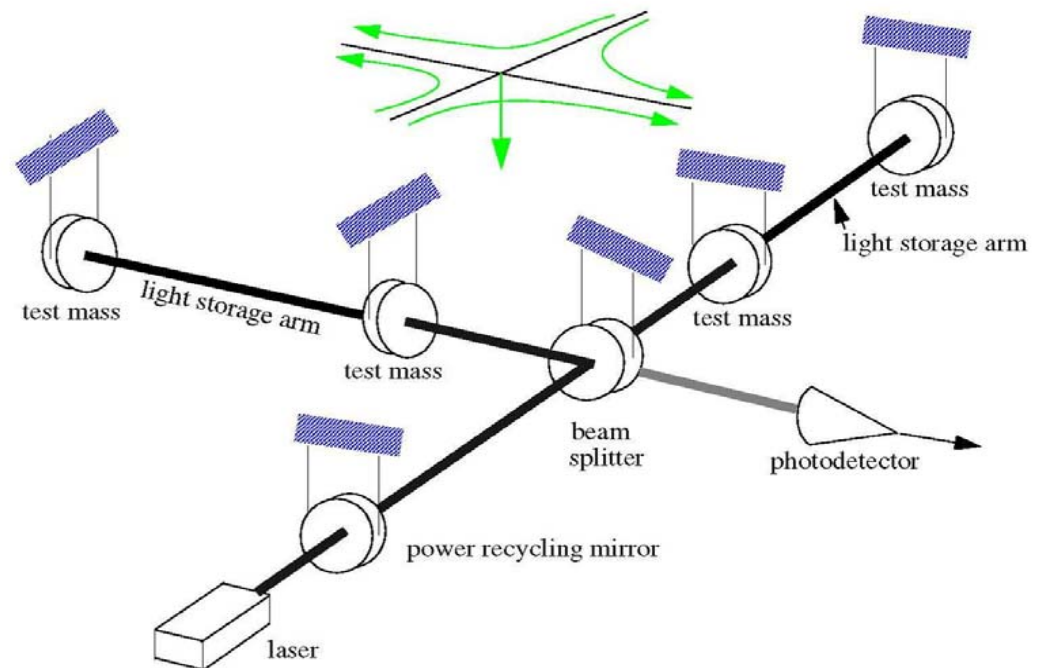

10^{-18} m is 1/1000 the diameter of an atomic nucleus



Initial LIGO Sensitivity Goal

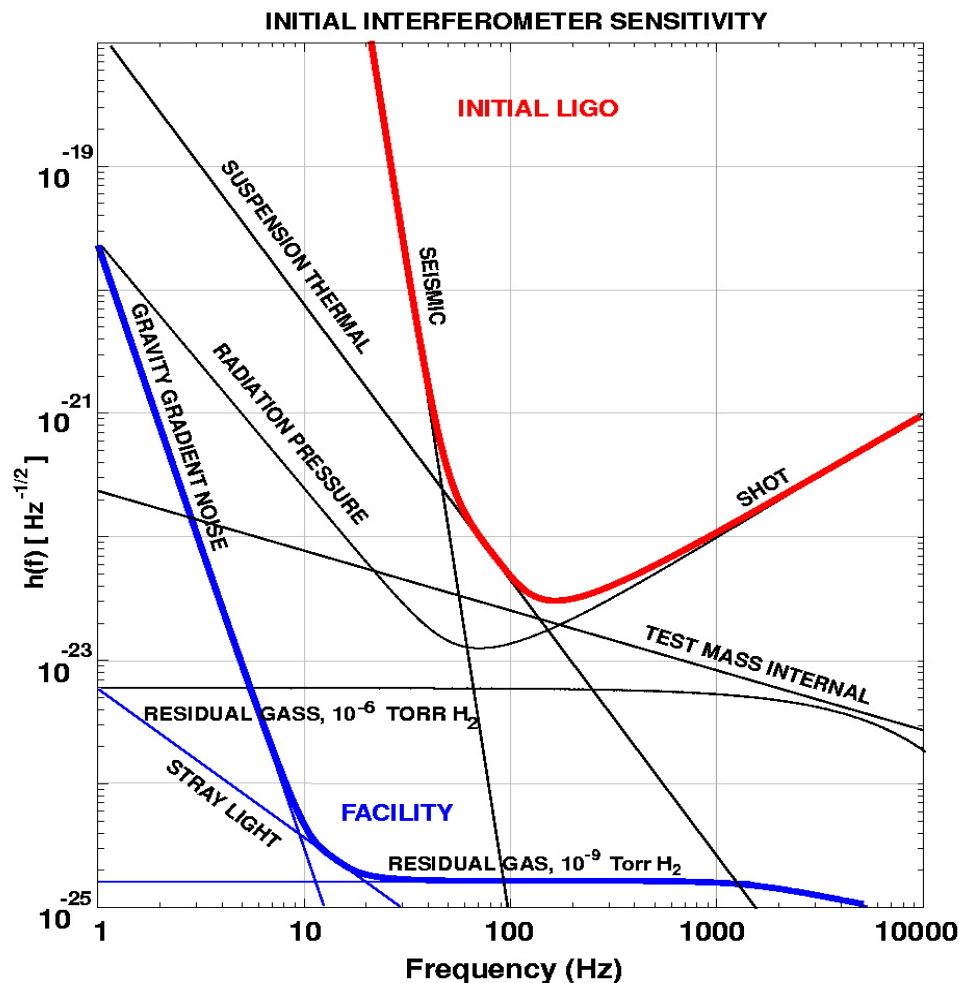

- Strain sensitivity $< 3 \times 10^{-23} \text{ 1/Hz}^{1/2}$ at 200 Hz
- Sensing Noise
 - » Photon shot noise
 - » Residual gas
 - » Laser frequency noise
- Displacement Noise
 - » Seismic motion
 - » Thermal noise
 - » Radiation pressure

Strain Sensitivity for the LIGO Hanford 4km Interferometer

S5 Performance LIGO-G060051-00-Z

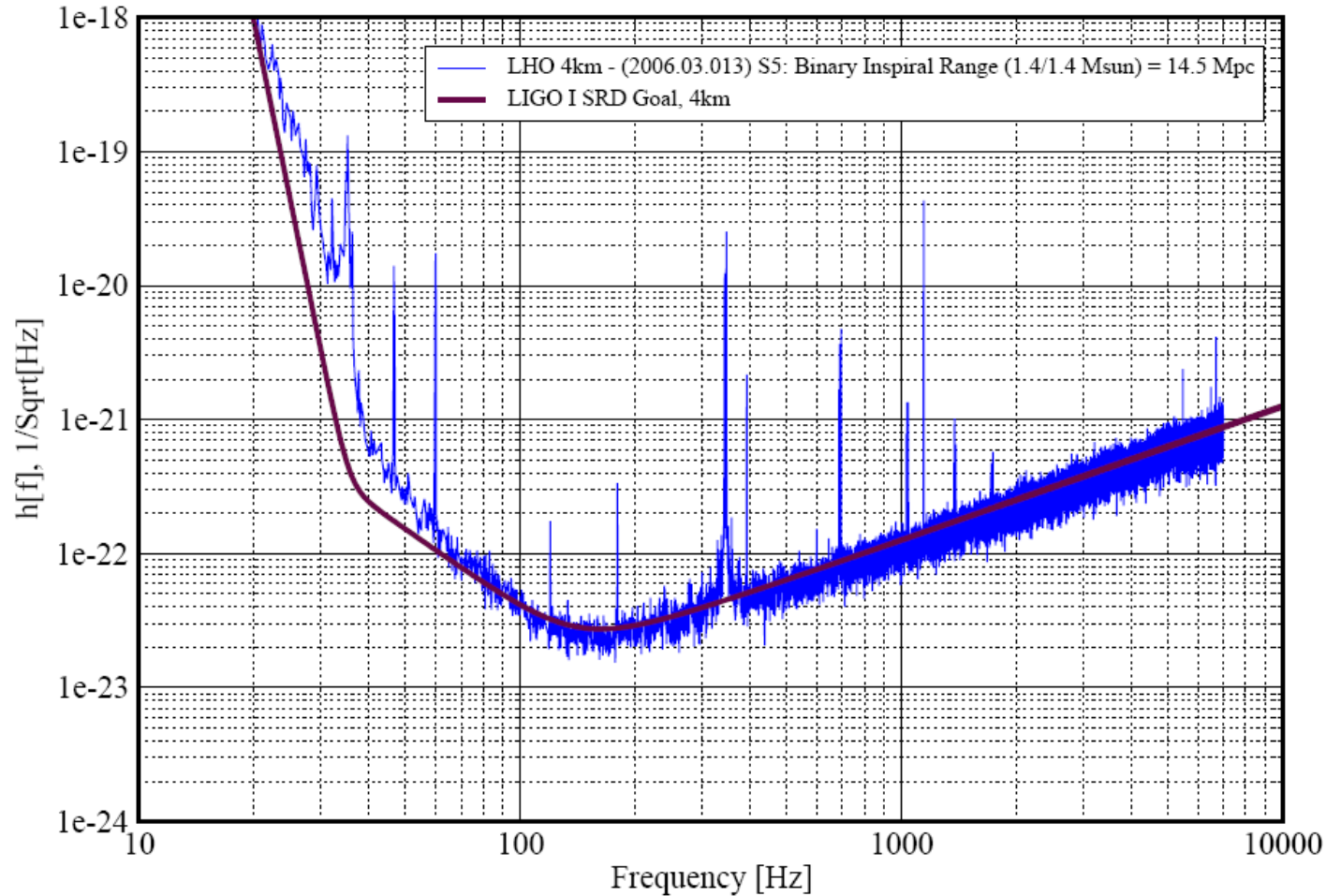

Most of the work goes into noise sources that never show up in talks or papers!

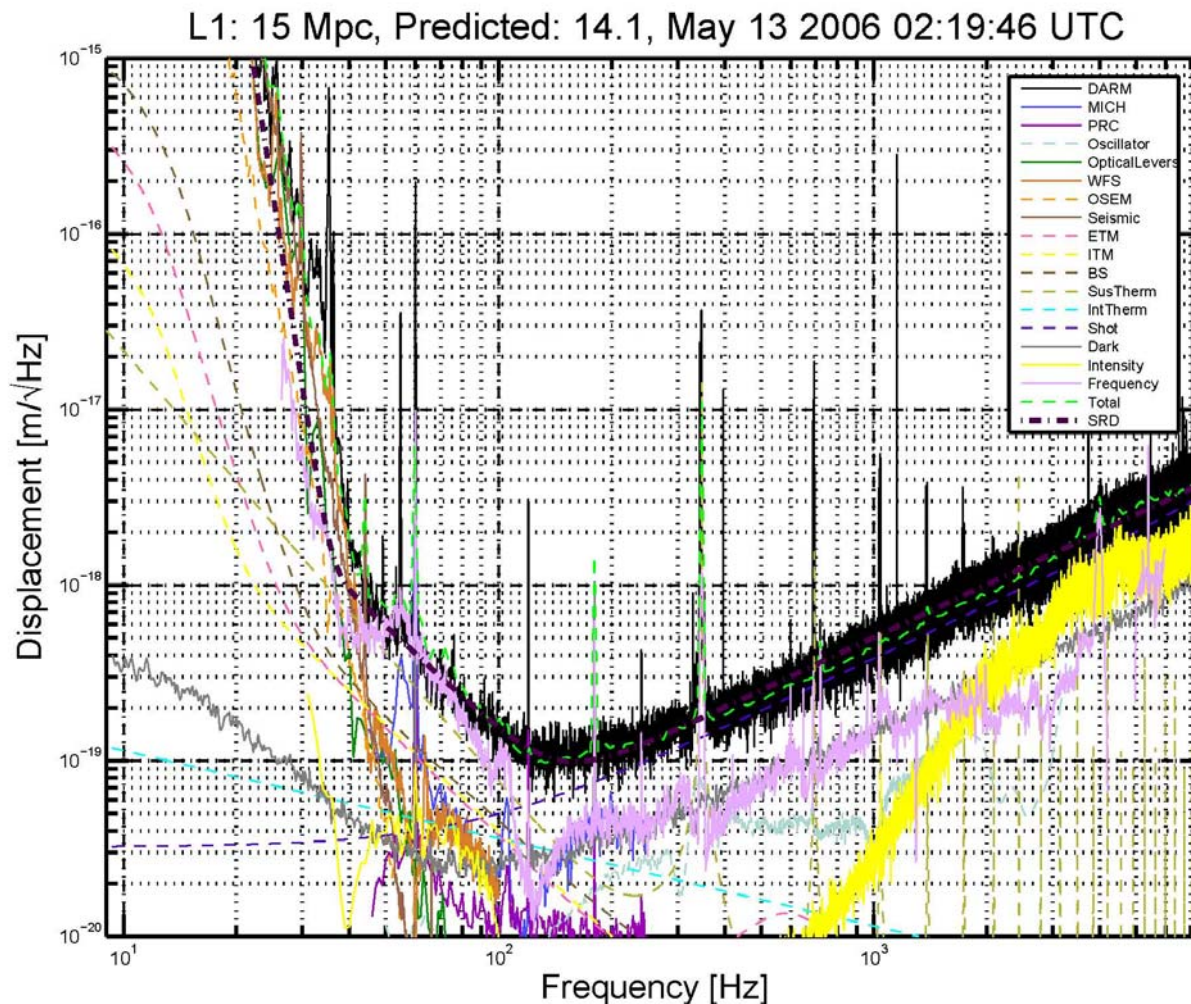

Example: Control Systems

Requires test masses to be held in position to $\sim 10^{-13}$ meter

Must move test masses by 10^{-6} m to compensate for ground motion with noise level $\ll 10^{-18}$ m

Light is "recycled" about 50 times

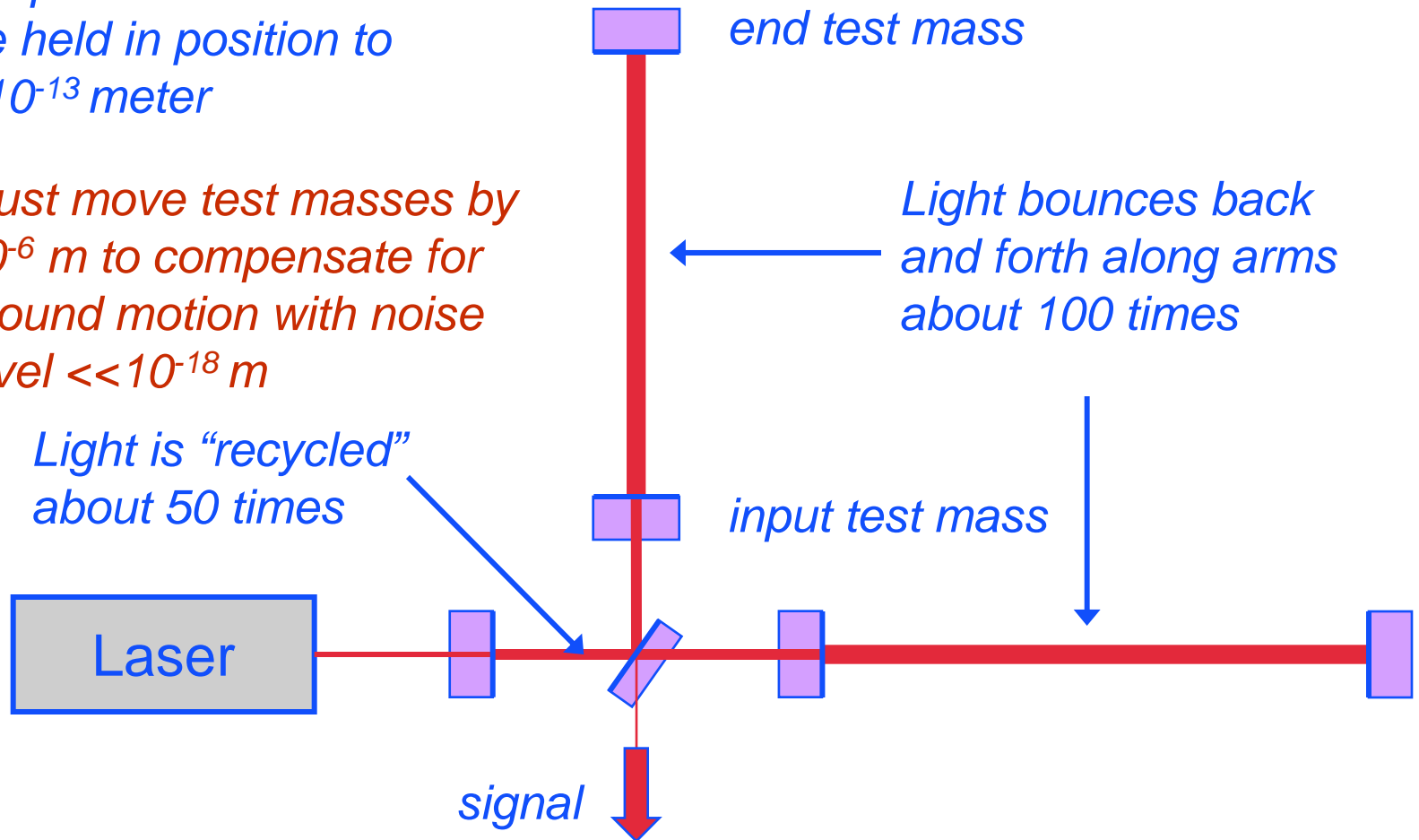



The Technical Challenge

- Noise sources are sometimes divided into “fundamental” and “technical” categories
 - » “Fundamental” are those that physicist like to work on
 - » “Technical” are the ones that someone else ought to fix
- There are many more technical noise sources than fundamental ones
 - » Time and effort to uncover and reduce them is also much larger
- Everything has to be done right



Organization and Management

- Cost of a GW detector for the international network is of the order of US\$100M
 - » Varies based on the accounting standards of different countries (salaries included or not, cost differences between countries, etc.)
- Effort required on the order of 500 person-years
 - » Need effective management structures to organize and coordinate effort of this scale



Management Techniques

- Work Breakdown Structure
 - » Exactly what it says it is:
a “tree” structure to break the work into manageable parts
- Essential components of a WBS element
 - » Definition of technical scope
 - » Budget
 - » Schedule
 - » Contingency
 - » Other resources needed

LIGO.4.04 Prestabilized Laser (PSL)
LIGO.4.04.1 PSL Subsystem Management
LIGO.4.04.2 PSL R&D
LIGO.4.04.2.1 High Power Laser R&D - Caltech
LIGO.4.04.2.2 High Power Laser R&D - Stanford
LIGO.4.04.2.3 High Power Laser R&D - ACIGA
LIGO.4.04.2.4 High Power Laser R&D - GEO
LIGO.4.04.3 PSL Design
LIGO.4.04.3.1 PSL Conceptual Design/Requirements
LIGO.4.04.3.2 PSL Preliminary Design
LIGO.4.04.3.2.1 System Design/Simulation
LIGO.4.04.3.2.2 Laser Design & prototype development
LIGO.4.04.3.2.3 Laser Performance Characterization/Acceptance
LIGO.4.04.3.2.4 Frequency Noise Suppression Design
LIGO.4.04.3.2.5 Intensity Noise Suppression Design
LIGO.4.04.3.2.6 Prototype Testing
LIGO.4.04.3.2.7 Safety Requirements/Design
LIGO.4.04.3.3 PSL Final Design
LIGO.4.04.3.3.1 System Design/Simulation
LIGO.4.04.3.3.2 Laser Design & prototype development
LIGO.4.04.3.3.3 Laser Performance Characterization/Acceptance
LIGO.4.04.3.3.4 Frequency Noise Suppression Design
LIGO.4.04.3.3.5 Intensity Noise Suppression Design
LIGO.4.04.3.3.6 Prototype Testing / Testbed Fabrication
LIGO.4.04.3.3.7 Safety Requirements/Design
LIGO.4.04.4 PSL Fabrication
LIGO.4.04.4.1 Laser Fabrication
LIGO.4.04.4.2 Optomechanical Fabrication
LIGO.4.04.4.3 Electronics Fabrication
LIGO.4.04.4.4 Testbed Fabrication
LIGO.4.04.4.5 First Article Testing
LIGO.4.04.4.6 Assembly



Work Breakdown Structure (WBS)

- Example

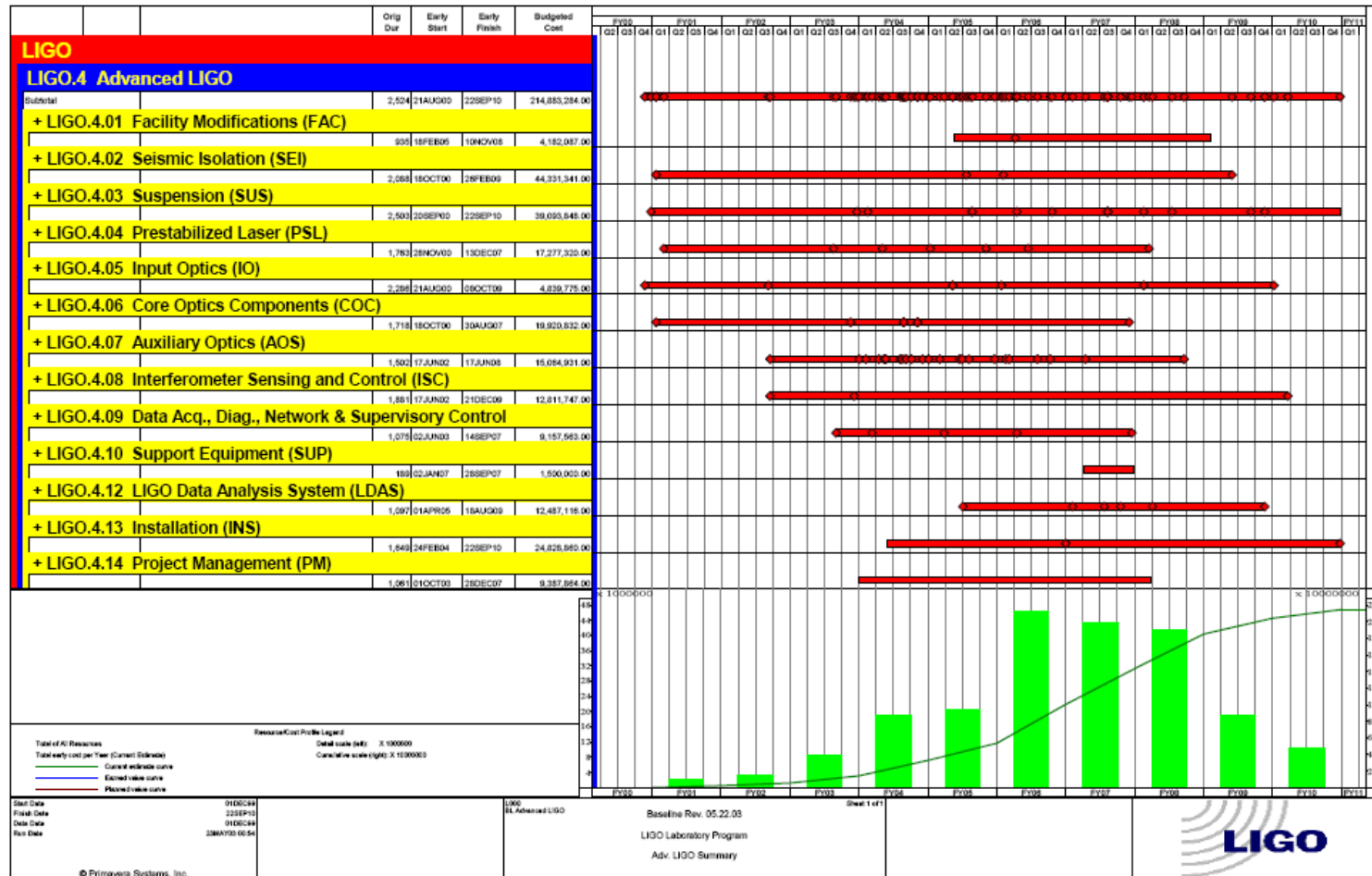



Management Techniques

- Management team must show that it will use appropriate tools to monitor and assess progress
 - » Shows wise stewardship of the public's money
 - » **Funding agencies will require it**

How much has been spent compared with what has been accomplished?

What is the current estimate for the schedule and how does that affect the costs?

How are you dealing with the unexpected? (Contingency management)

- Not the skills of a typical physicist
 - » Must be learned on the job
- Important to draw in an experienced project manager



System Engineering and Integration

- To build a big scientific facility you need to break it down into manageable pieces...
 - But to make it work, you need to bring it together and make all the pieces work together
- Strong system engineering group to define subsystem requirements, manage performance and interfaces, and resolve inconsistencies and conflicts
 - » SW's observation: Practical physicists can be very effective system engineers
- A particularly significant challenge for GW interferometers because of their inter-connected nature
 - » Components must fulfill diverse requirements

Optical Requirements

- Surface Figure
 $< 1 \text{ nm rms}$
- Radius of Curvature
 matched $< 3\%$
- Material homogeneity
 $< 5 \times 10^{-7}$
- Coating
 - » Scatter $< 50 \text{ ppm}$
 - » Absorption $< 2 \text{ ppm}$
 - » Uniformity $< 10^{-3}$

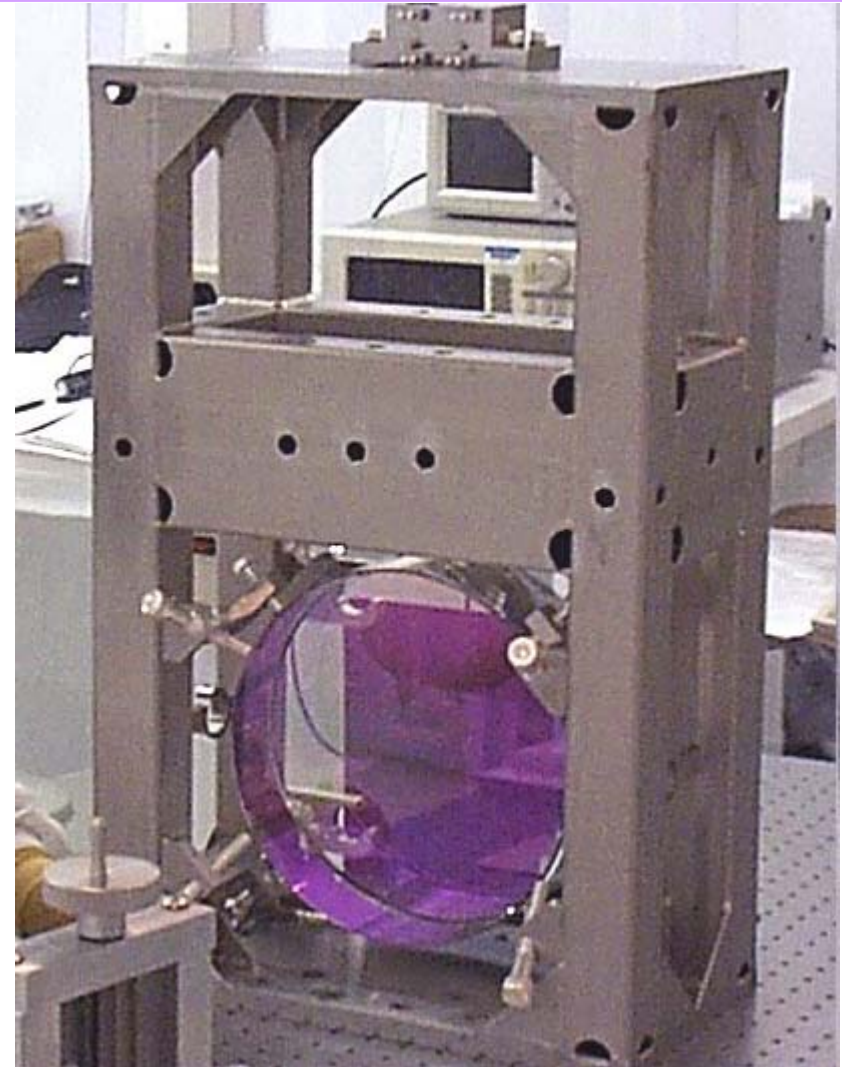

Mechanical Noise Requirements

- Optical surface must reproduce the motion of a free body in space
- Vibration isolation
- Low noise suspension
 - » Attachment techniques
- Low thermal noise
 - » Size: 25 cm Diameter, 10 cm thick
 - » Internal mode Q's $> 2 \times 10^6$
 - » Mechanical properties of coating

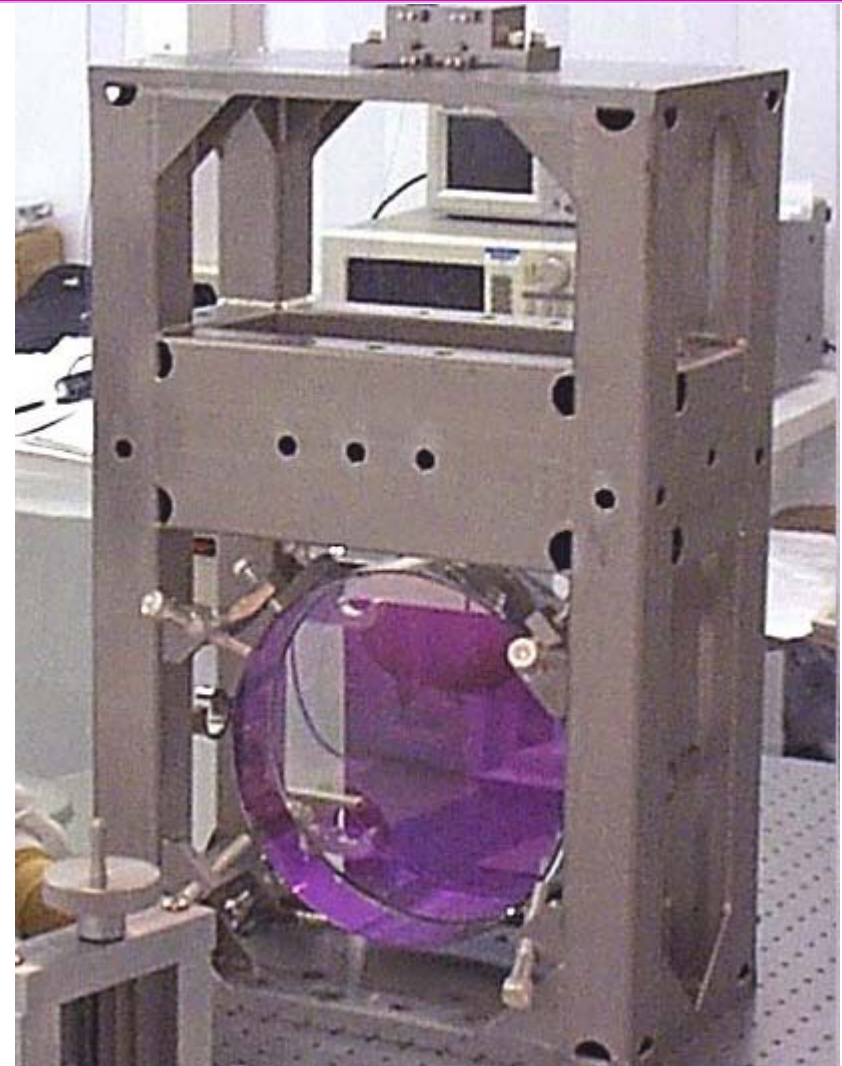

Servo Actuator Requirements

- Need to apply forces to control position and orientation
 - » Coupling of angle to length
 - » Noise from control system
 - » Resonances (!)
 - » Effect of reaction forces

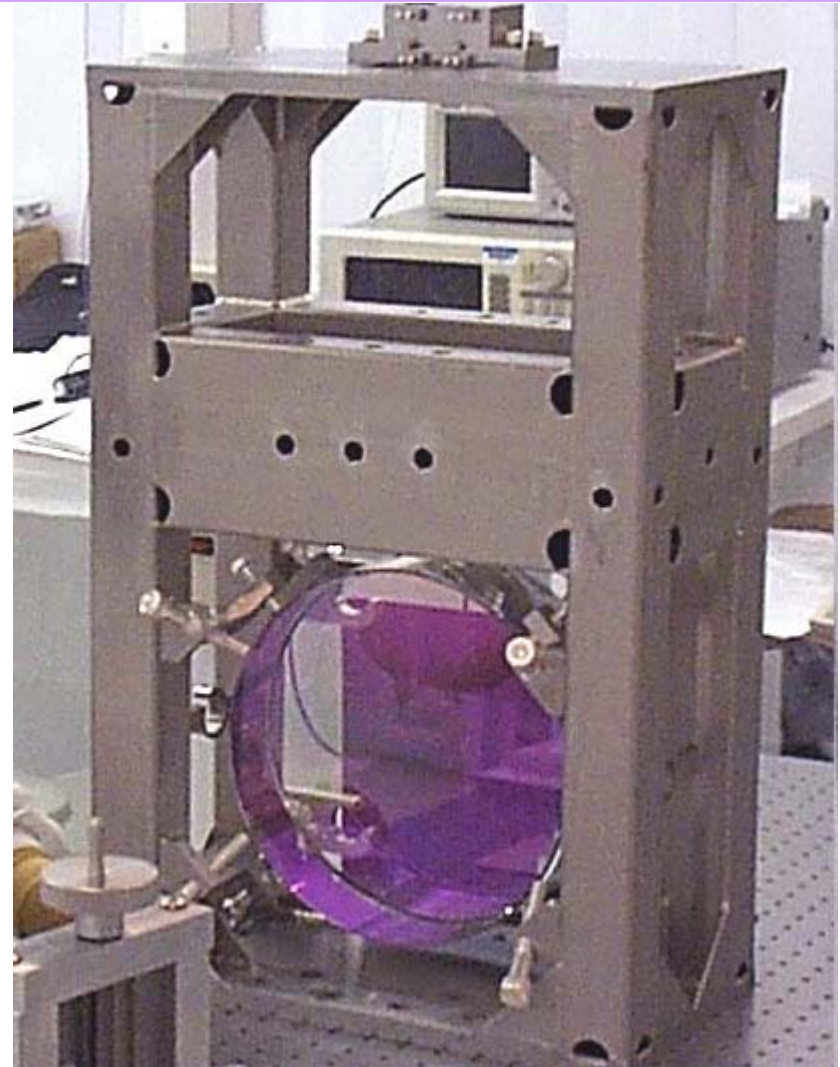



Integration and Commissioning

- GW Interferometers are complex instruments
 - » Up to ~200 servo loops, all needing to operate optimally
 - » As many as 10000 control settings and readbacks
- Interactions are complex, and they are unique to the particular configuration
- Changes in one part of the apparatus can ripple through in subtle and unforeseen ways

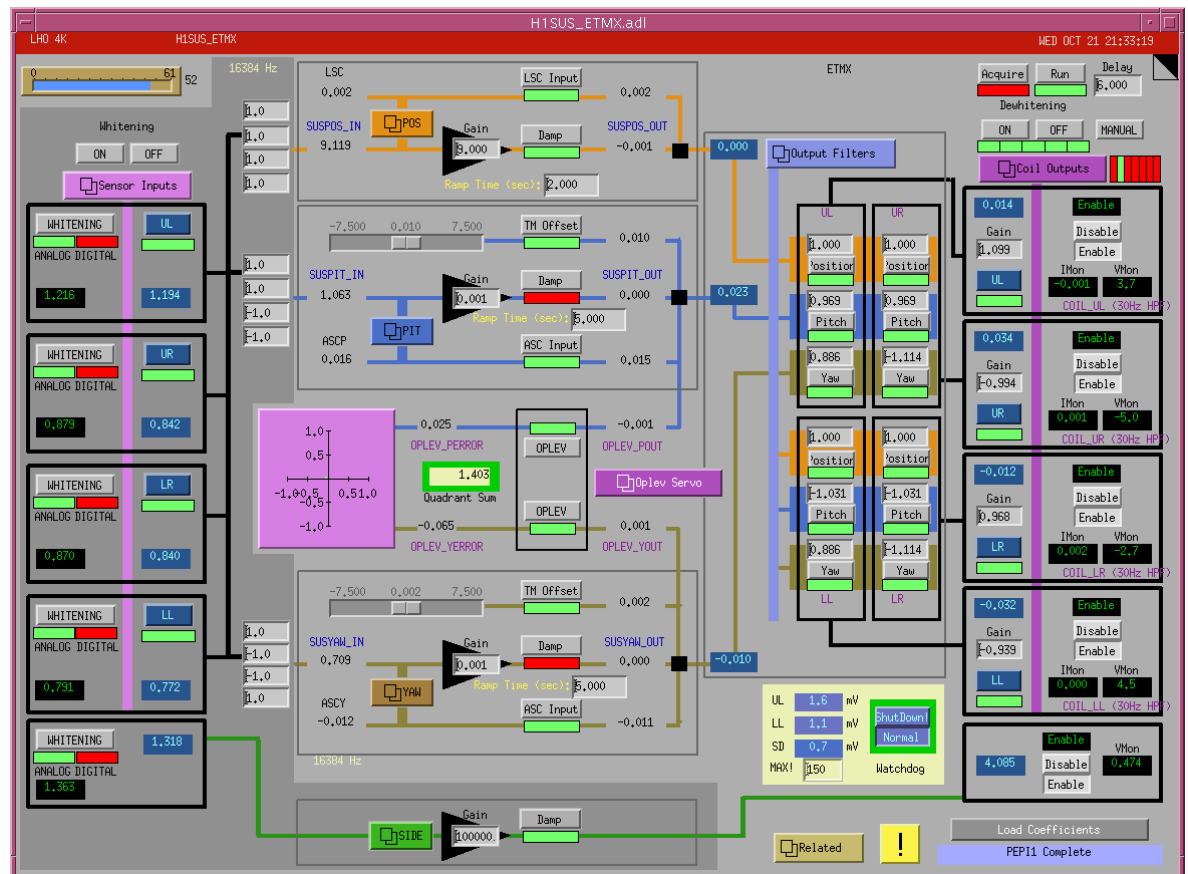



Final Thoughts

- Have I taught you how to build a gravitational wave detector?
 - » No, a 30 minute talk is far too short!
 - » I have tried to lay out the key issues in the broadest context
- Success requires not only the tools of experimental physicists, but also skilled managers and engineers
- If there is an effort to build a detector in this region, then there is a vibrant and interested international community that wants to help