

Residual Gas in the LIGO Beam Tubes: Science, Arts and Recipes

Rainer Weiss, MIT,
on behalf of the LIGO project and CBI

American Vacuum Society
Baltimore November 5, 2003



Interferometers

international network

Simultaneously detect signal (within msec)

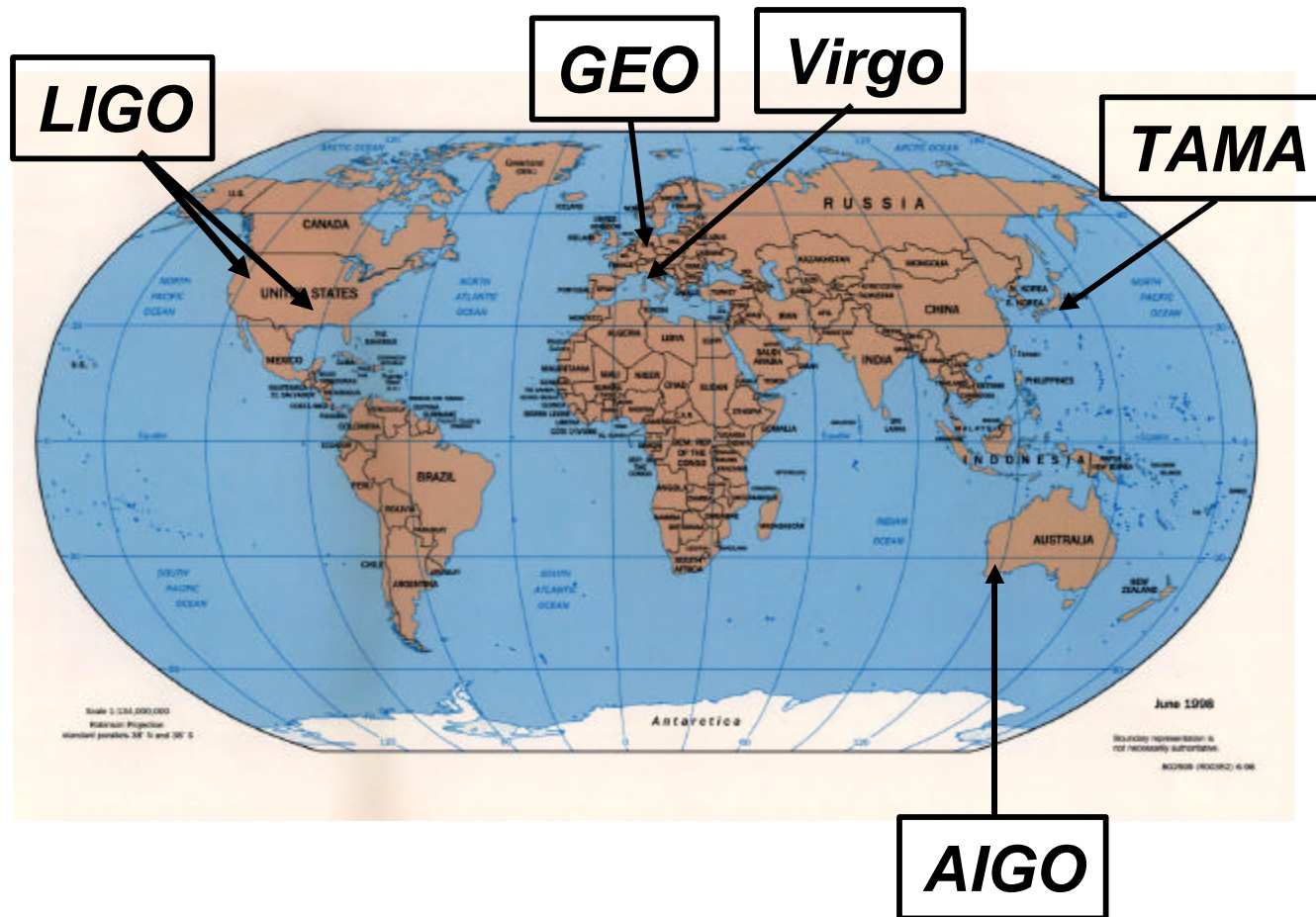

detection
confidence

locate the
sources

decompose the
polarization of
gravitational
waves

LIGO Observatory Facilities



LIGO Hanford Observatory [LHO]

26 km north of Richland, WA

2 km + 4 km interferometers in same vacuum envelope



LIGO Livingston Observatory [LLO]

42 km east of Baton Rouge, LA

Single 4 km interferometer

Beam Tubes and Enclosures

Precast concrete enclosure

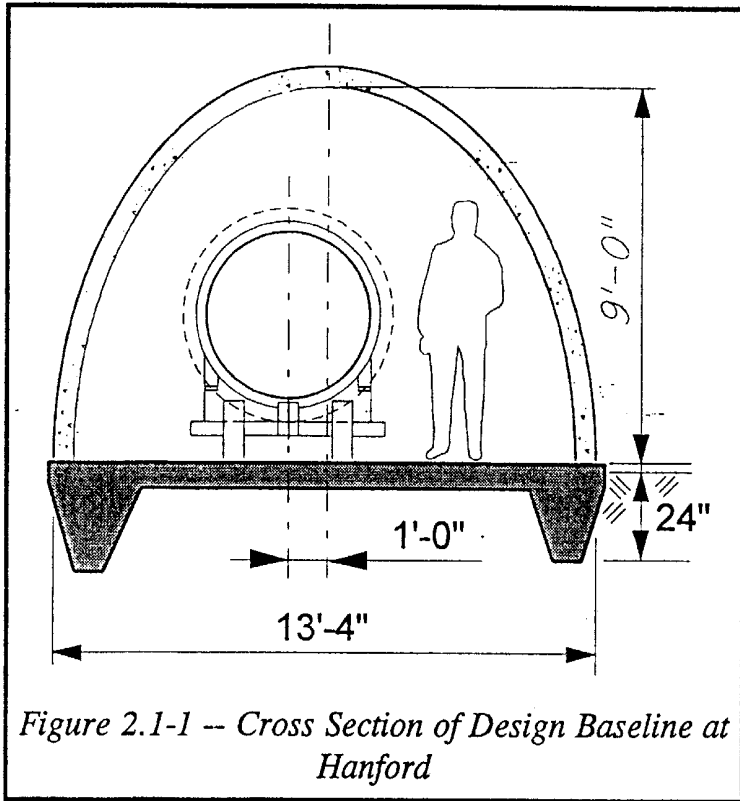

- **Beam Tube**
 - 1.2m diam; 3 mm stainless
 - special low-hydrogen steel process
 - 65 ft spiral weld sections
 - 50 km of weld (NO LEAKS!)
 - In situ 160 C bakeout
 - 20,000 m³ @ 10⁻⁸ to 10⁻⁹ torr



LIGO

vacuum equipment



LIGO-G000306-00-M

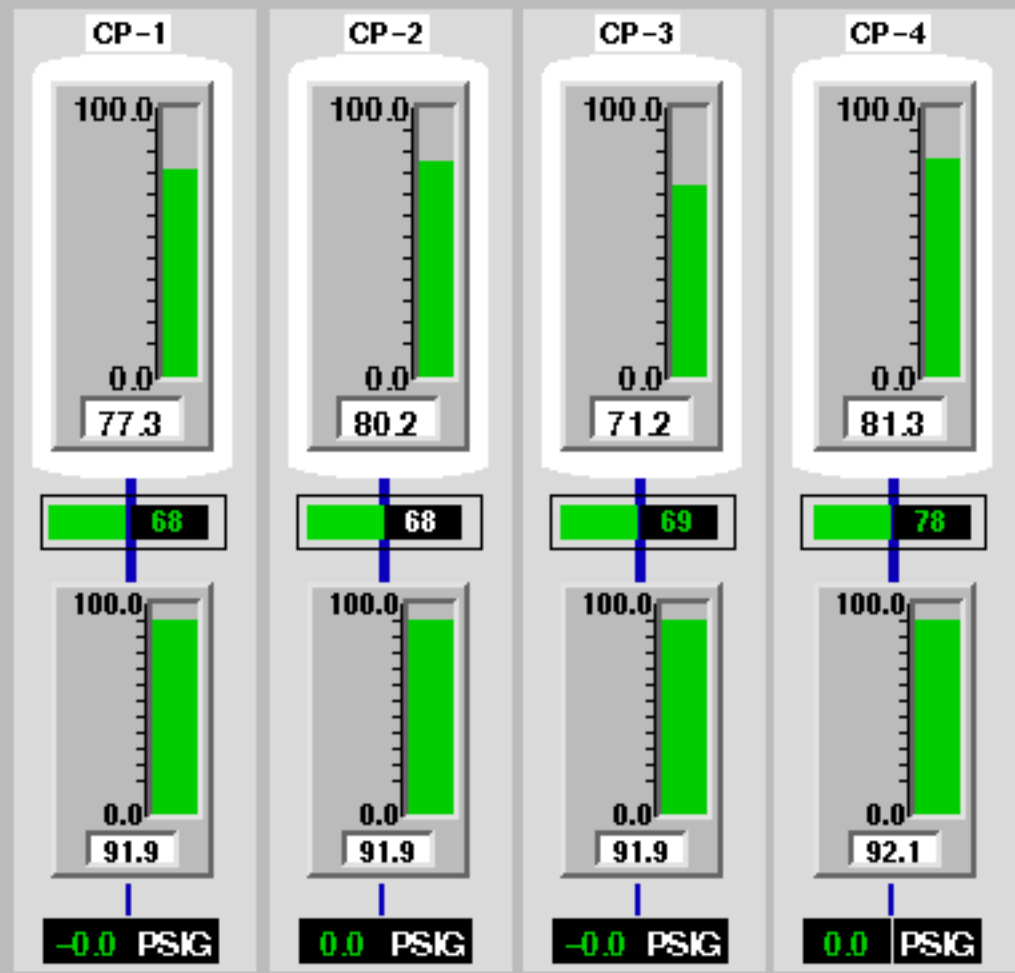
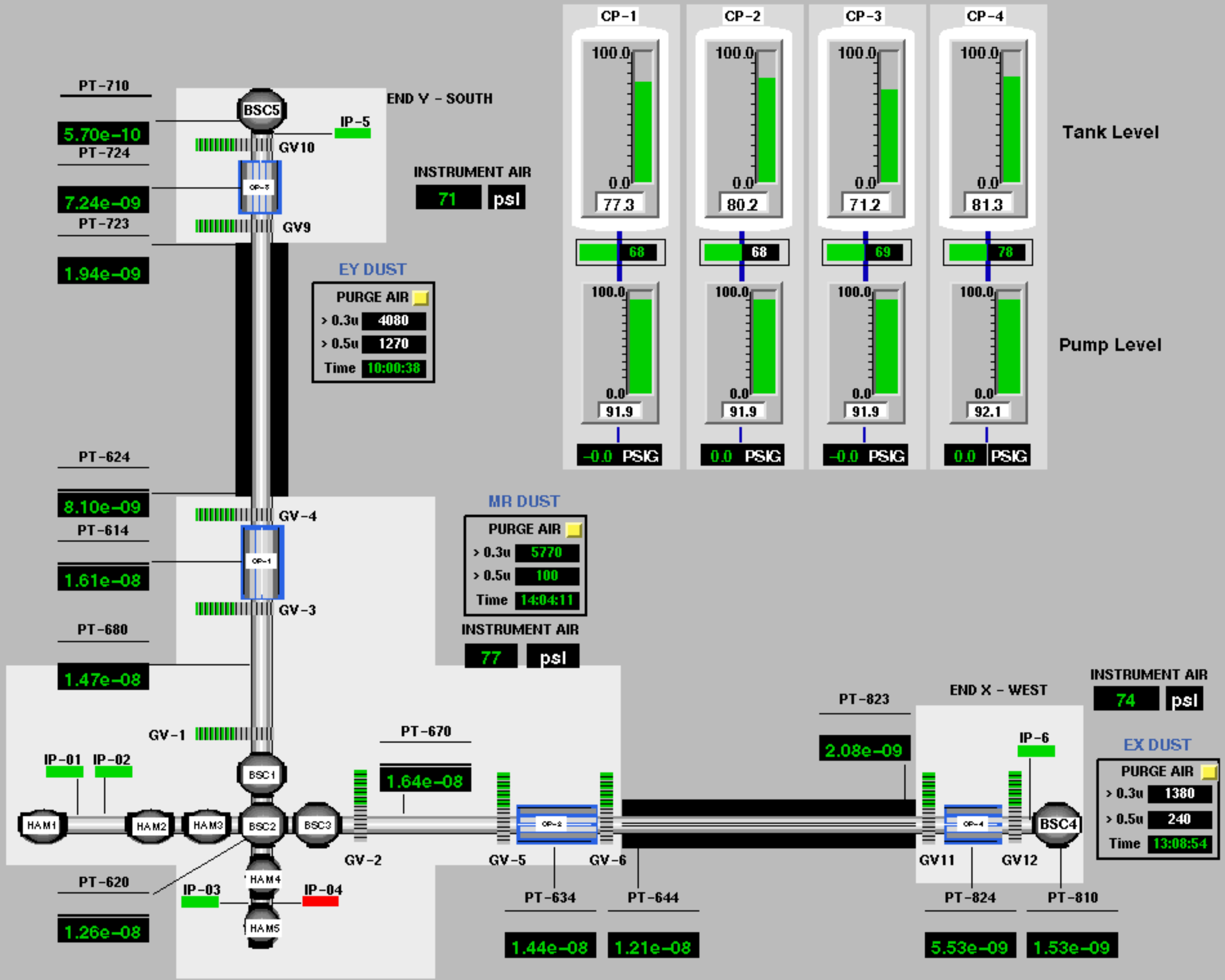

INSTRUMENT AIR
71 psl

EY DUST
PURGE AIR
> 0.3u **4080**
> 0.5u **1270**
Time **10:00:38**

MR DUST
PURGE AIR
> 0.3u **5770**
> 0.5u **100**
Time **14:04:11**

INSTRUMENT AIR
77 psl

INSTRUMENT AIR
74 psl

EX DUST
PURGE AIR
> 0.3u **1380**
> 0.5u **240**
Time **13:08:54**

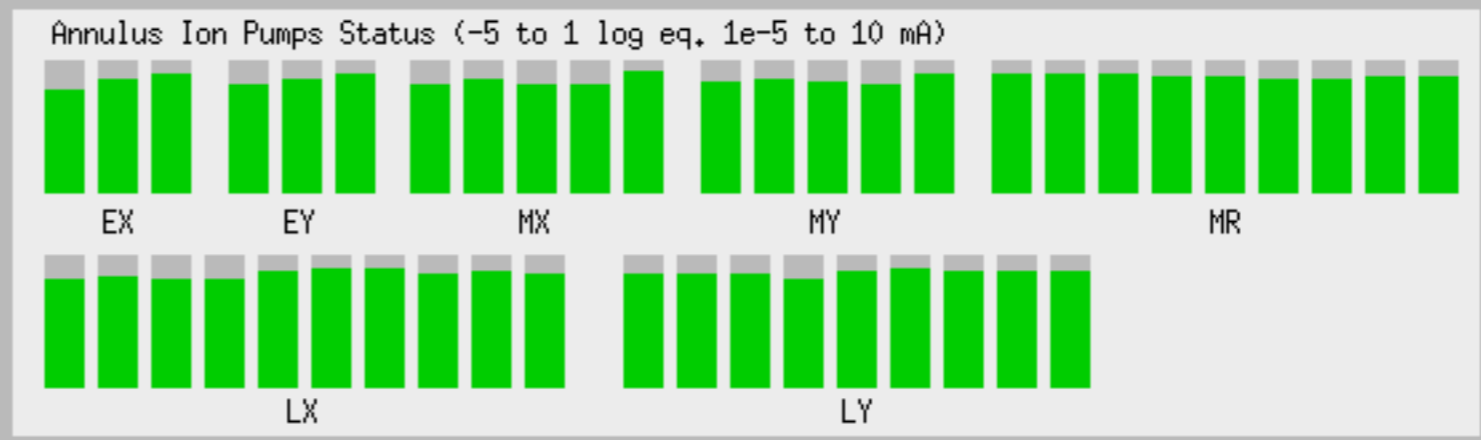
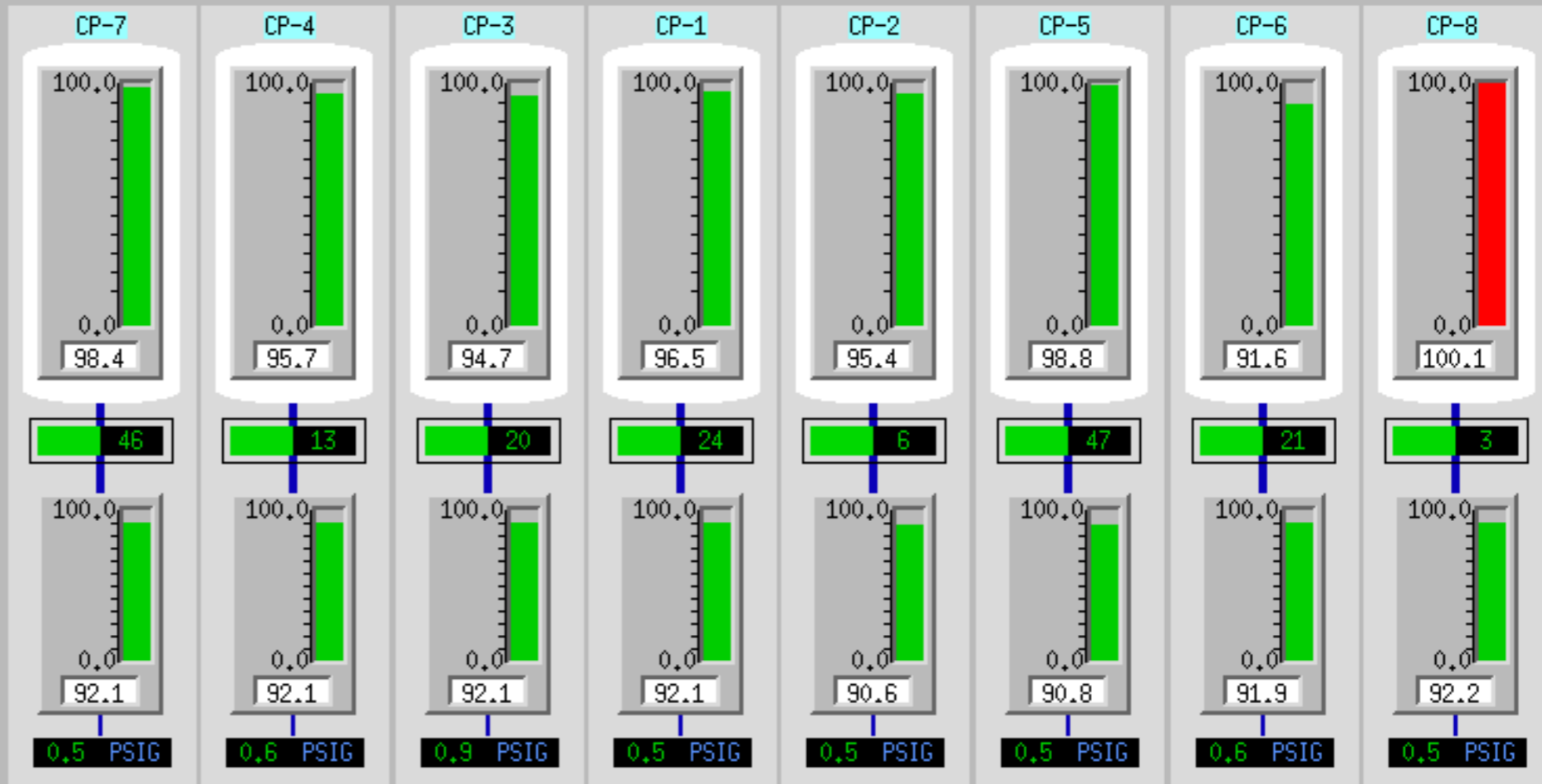
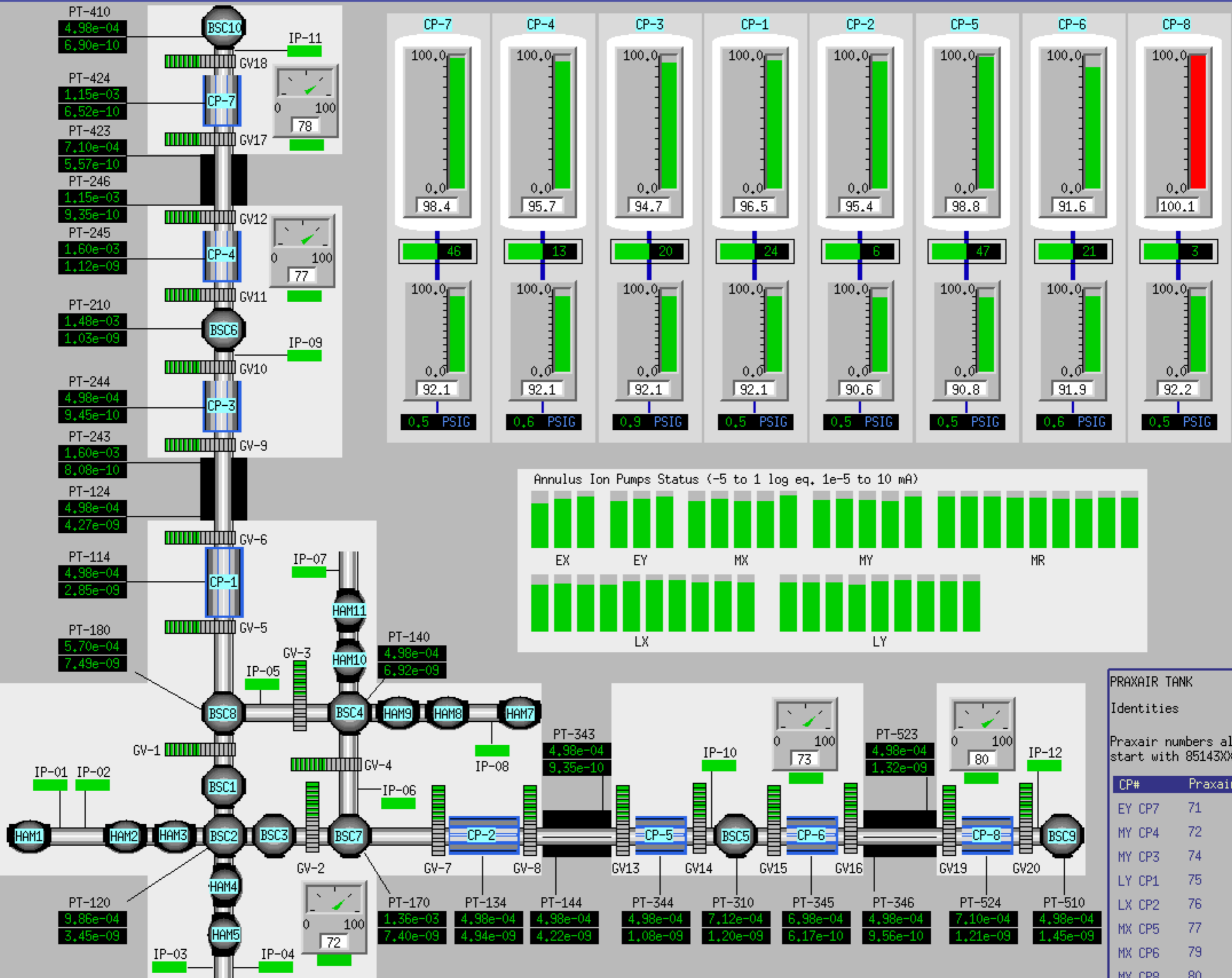

PRAXAIR TANK

Identities

Praxair numbers all start with 85143XX

CP#	Praxair #
EY CP7	71
MY CP4	72
MY CP3	74
LY CP1	75
LX CP2	76
MX CP5	77
MX CP6	79
MX CP8	80

LIGO Beam Tubes

- Interaction region between gravitational waves and laser interferometers
 - ›› 16 km of vacuum tubing at two sites
 - ›› initial detectors require 10^{-7} torr
 - ›› ultimate detectors require 10^{-10} torr
 - ›› needs to be economical
 - minimal pumping, exploit passive nature of system
 - new welding techniques - continuous spiral weld in 304L
 - low outgassing materials - air bake to reduce hydrogen outgassing, total low 150C bake to reduce water and heavier molecule outgassing
 - mass production cleaning
 - global positioning system alignment

BEAM TUBE SCIENTIFIC REQUIREMENTS

- VACUUM REQUIREMENTS

- ›› Residual gas
 - Leak requirements
- ›› Contamination
- ›› Operational requirements
 - Pump down time
 - Isolation from chambers
 - Reliability

- MECHANICAL AND OPTICAL REQUIREMENTS

- ›› Clear Aperture
- ›› Forward and Backscatter from walls and baffles
- ›› Motion of tube walls and baffles

BEAM TUBE REQUIREMENTS

- LEAK LIMITS

- ›› Component Level

- 1×10^{-10} torr liters/sec

- ›› 2 km module with 2500 liter/sec end pumps

- 1×10^{-9} torr liters/sec

- CONTAMINATION ON OPTICS

- ›› less than 1 monolayer of hydrocarbon/month

BEAM TUBE REQUIREMENTS

- OPERATIONAL REQUIREMENTS

- ›› Time to reach required pressure < 2 months
- ›› Capability to isolate beamtubes from chambers
- ›› Reliability: leak free state for > 20 years

- MECHANICAL AND OPTICAL
REQUIREMENTS

- ›› Unobstructed aperture 1 meter
- ›› Backscatter from baffles and tube between 0.5 to 1 micron wavelengths < $2 \times 10^{-3} \text{ sr}^{-1}$ for angles of incidence greater than 45 degrees
- ›› Motion of tubes at baffles not to exceed 2 x the ambient seismic noise except in narrow bands

Beam Tube Properties

module length	2 km
25 cm diameter pump ports/module	9
radius of beam tube	62 cm
volume of module	4.831×10^6 liters
area of module	1.55×10^8 cm ²
initial pumping speed/surface area	1.94×10^{-5} liters/sec/cm ²
length/short section	1.90×10^3 cm
wall thickness	3.23×10^{-1} cm
stiffener ring spacing	76 cm
stiffening ring width	4.76×10^{-1} cm
stiffening ring height	4.45 cm
expansion joint wall thickness	2.67×10^{-1} cm
expansion joint convolutions	9
expansion joint longitudinal spring rate	1.5×10^9 dynes/cm

Initial Interferometer Noise Budget

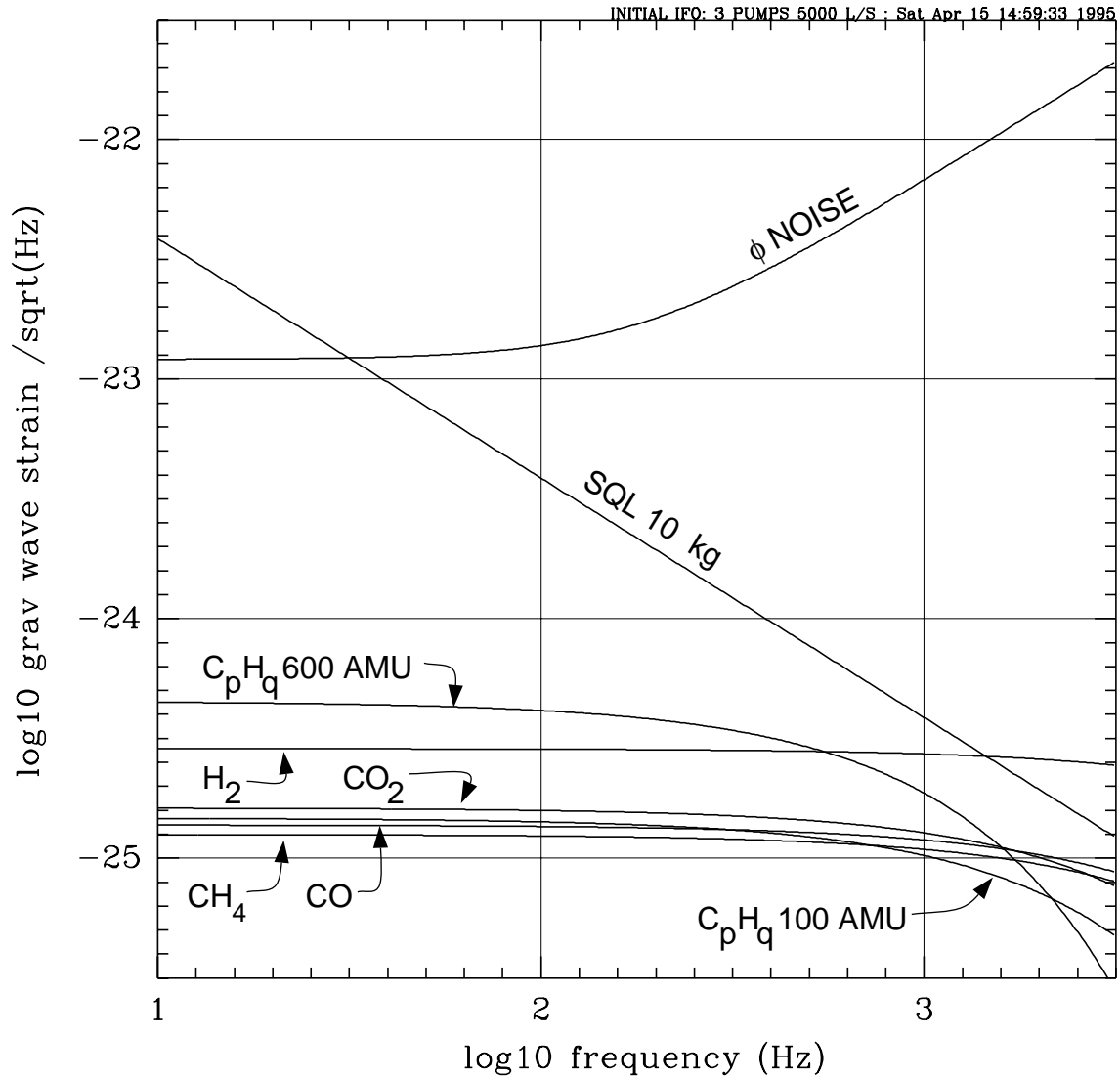

Advanced Interferometer Noise Budget

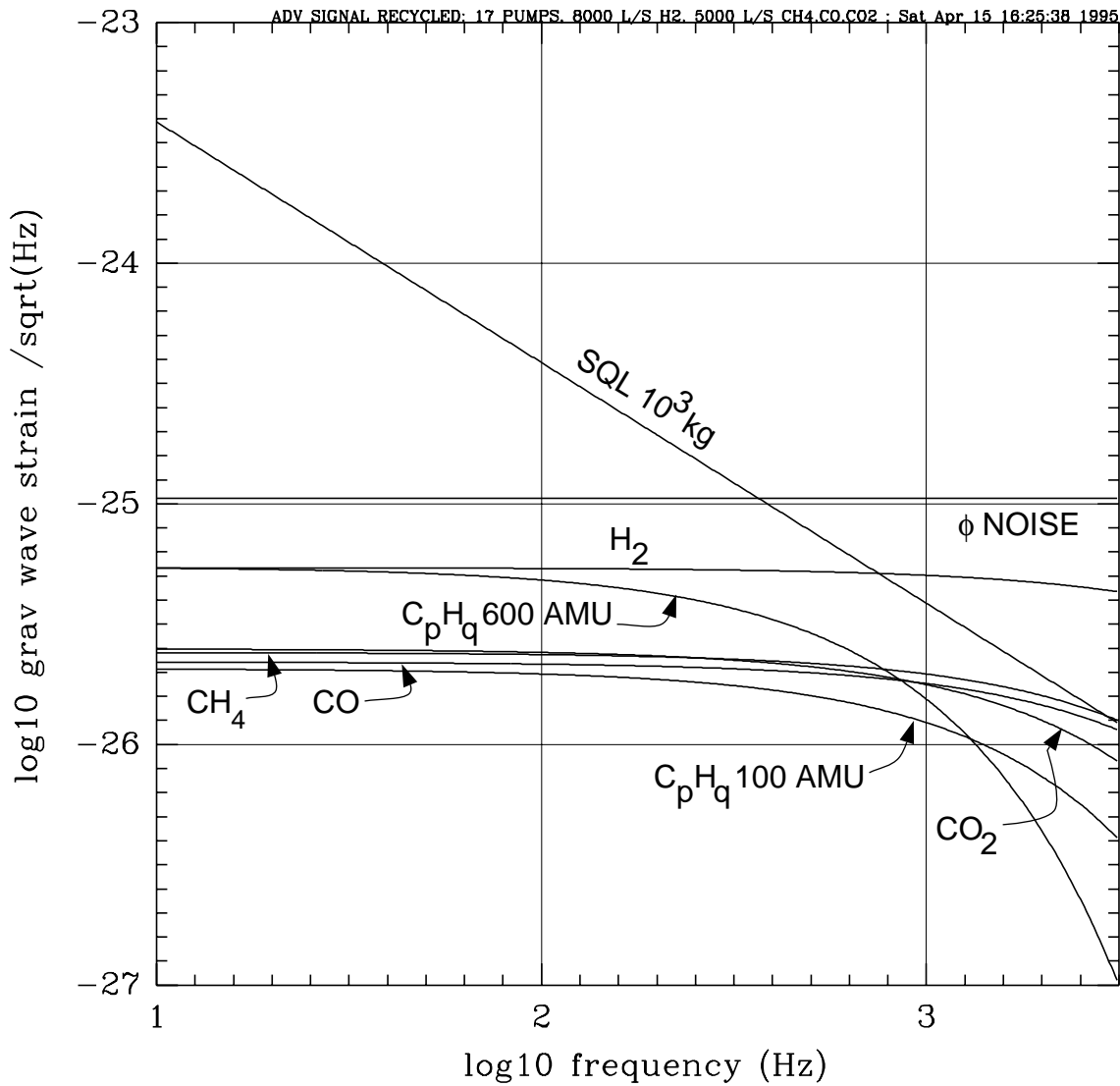

Advanced amplitude recycled interferometer parameters:

$$A_m = 10^{-5}$$

$$P_{in} = 100 \text{ W}$$

$$P_{circ} \sim 1 \text{ MW}$$

$$\epsilon_{opt} = 0.3$$

$$\lambda = 1.06 \mu$$

BEAM TUBE BAKEOUT

- Requirements and goals

- ›› Initial interferometer residual gas phase noise (100Hz)

$$h(f) < 5 \times 10^{-24}$$

- ›› Advanced interferometer residual gas phase noise (100Hz)

$$h(f) < 1.5 \times 10^{-25}$$

- ›› Relation between pressure and phase noise

$$h(f) = 4.8 \times 10^{-21} R \left(\frac{x}{H_2} \right) \sqrt{\langle P(\text{torr}) \rangle_L}$$

BEAM TUBE BAKEOUT

Table 1: Residual gas phase noise factor and average pressure

Gas Species	R(x/H₂)	Requirement (torr)	Goal (torr)
H ₂	1.0	1×10 ⁻⁶	1×10 ⁻⁹
H ₂ O	3.3	1×10 ⁻⁷	1×10 ⁻¹⁰
N ₂	4.2	6×10 ⁻⁸	6×10 ⁻¹¹
CO	4.6	5×10 ⁻⁸	5×10 ⁻¹¹
CO ₂	7.1	2×10 ⁻⁸	2×10 ⁻¹¹
CH ₄	5.4	3×10 ⁻⁸	3×10 ⁻¹¹
AMU 100 hydrocarbon	38.4	7.3×10 ⁻¹⁰	7×10 ⁻¹³
AMU 200 hydrocarbon	88.8	1.4×10 ⁻¹⁰	1.4×10 ⁻¹³
AMU 300 hydrocarbon	146	5×10 ⁻¹¹	5×10 ⁻¹⁴
AMU 400 hydrocarbon	208	2.5×10 ⁻¹¹	2.5×10 ⁻¹⁴
AMU 500 hydrocarbon	277	1.4×10 ⁻¹¹	1.4×10 ⁻¹⁴
AMU 600 hydrocarbon	345	9.0×10 ⁻¹²	9.0×10 ⁻¹⁵

BEAM TUBE BAKEOUT

- Average pressure and outgassing rate

$$\langle p \rangle_L = J \left[\frac{2\pi a L}{nF} + \frac{L^2}{4va^2(n-1)^2} \right]$$

- Outgassing rate vs temperature and time

$$J(T) = ae^{-\frac{T_0}{T}}$$

- ›› Typical: $5000 < T_0 < 10000$ K
- ›› Time dependence
 - $1/t$ surface adsorption with distribution of binding site energies
 - $(1/t)^{0.5}$ diffusion followed by evaporation

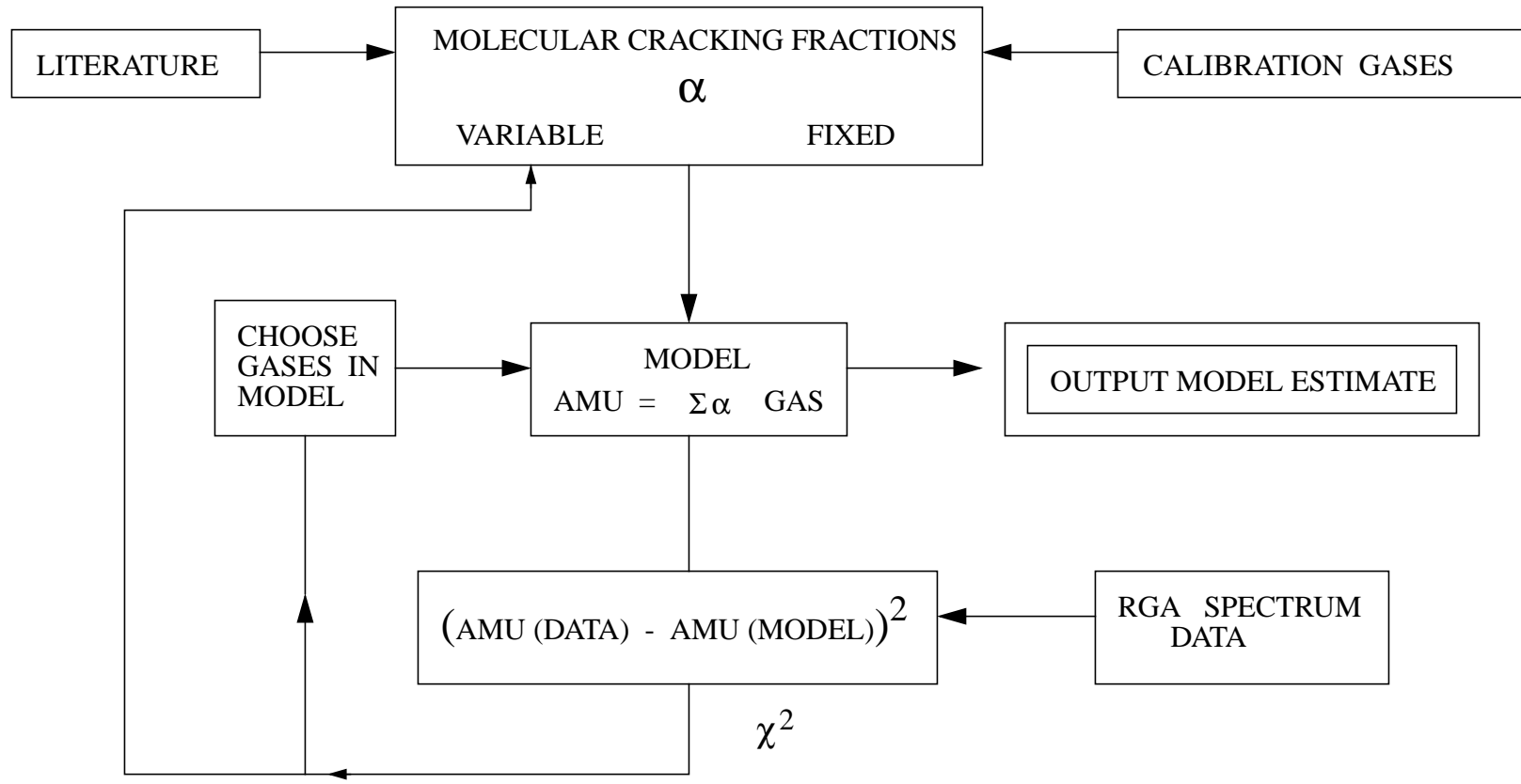

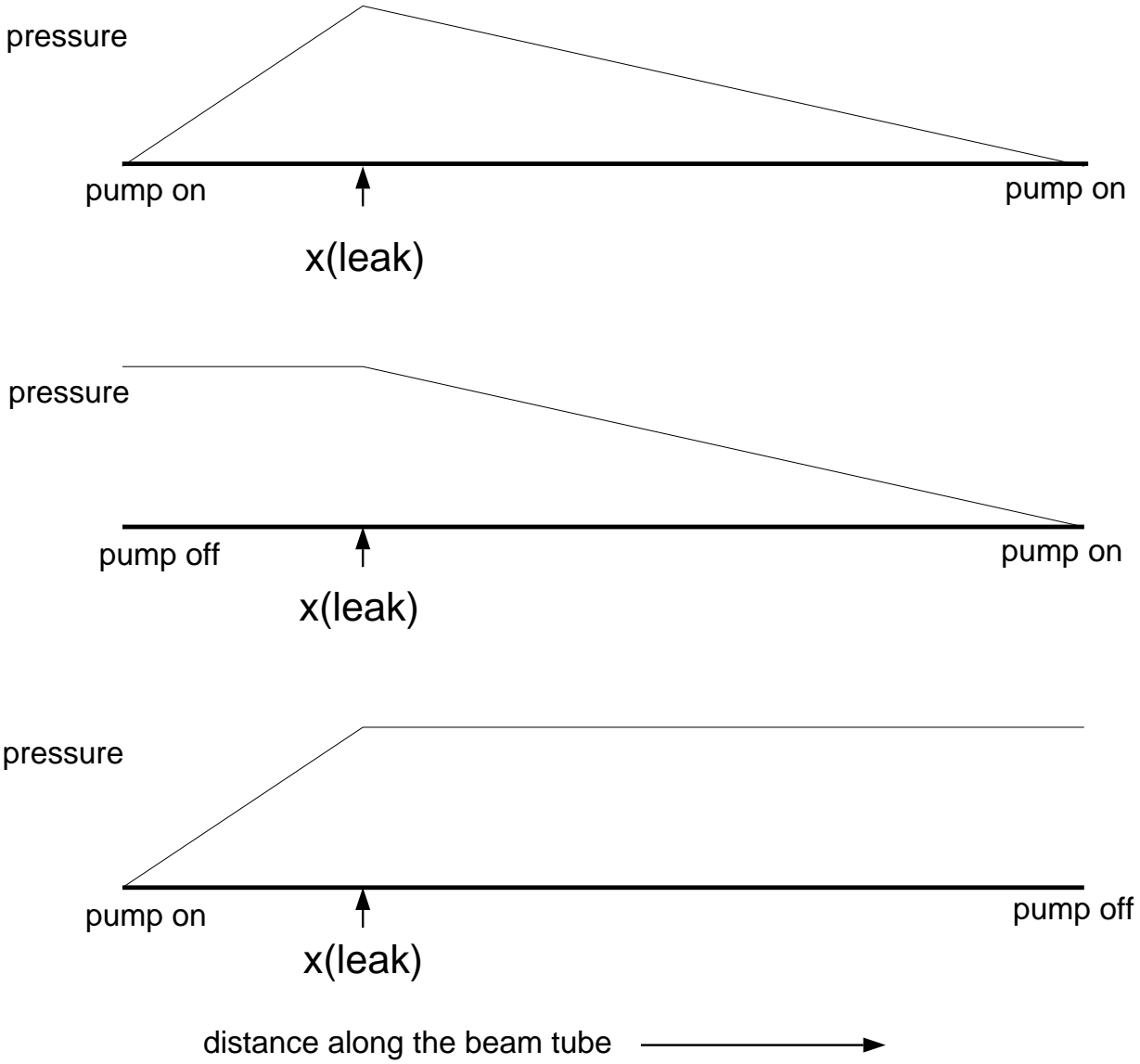

Leak pressure profiles in tube

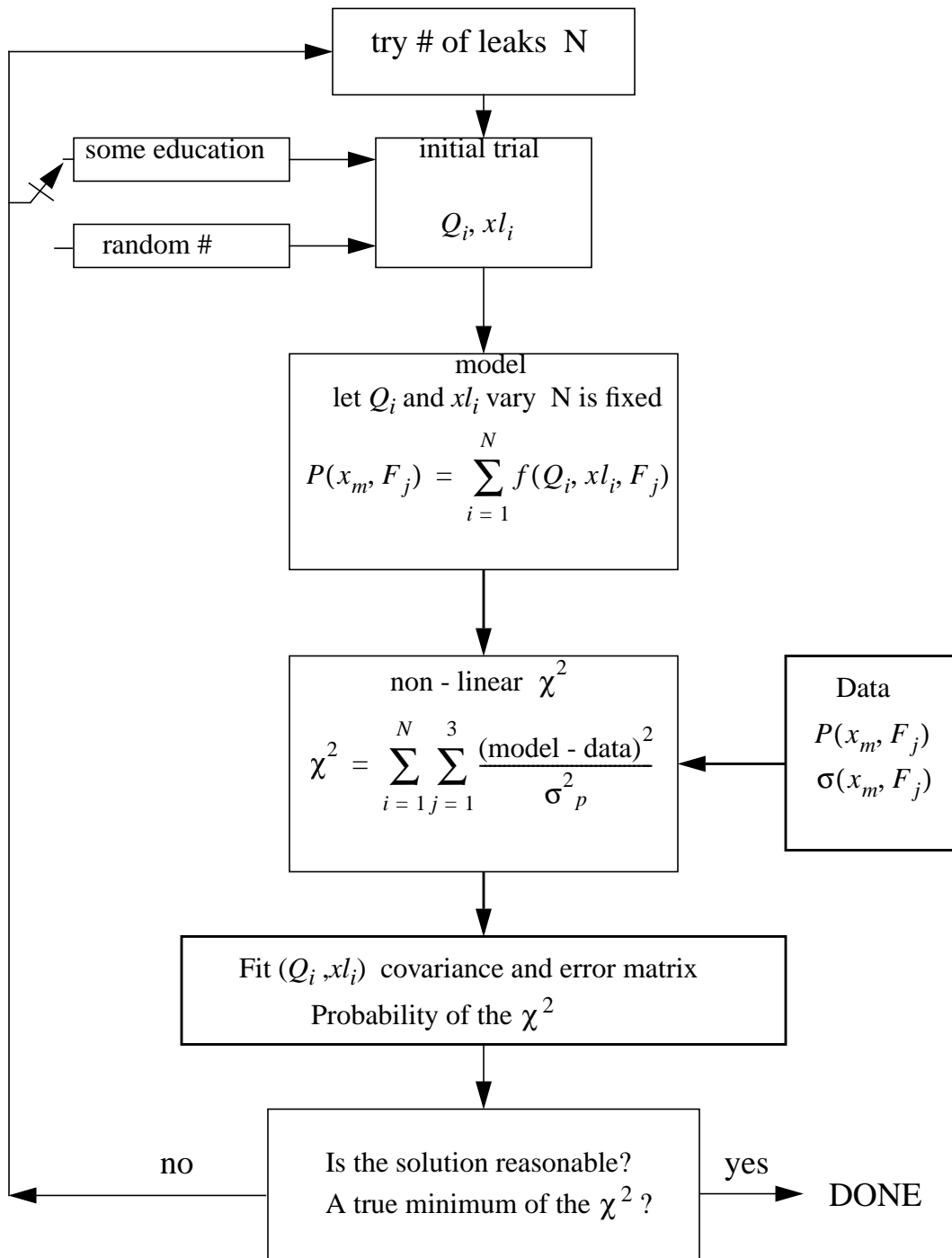

Leak localization algorithm

Beam Tube Cleaning

- Cleaning steps

- ›› Hot water and detergent - Mirachem 500 spray wash

- 30/1 water/Mirachem - 500

- 1 cc/ cm²

- ›› Steam rinse

- 2 cc/ cm²

- 7 - 8.5 atmospheres pressure

- 58 - 65 C surface temperature of steel

- ›› Applied by rotating wand that traverses the tube longitudinally at 20 cm / minute

- Surface analysis

- ›› Fourier Transform Infrared Spectroscopy FTIR

- Sample taken by pouring 2 - isopropanol in strip down tube

- Analysis made in professional testing laboratory

Beam Tube Cleaning

- ›› Auger electron spectroscopy
 - Sample strips placed in tube
 - Analysis made in surface measurement lab after cleaning
 - Sensitive to elemental carbon
 - Useful to determine state of rinse by measurement of sodium and calcium
- ›› Water drop adhesion tests
 - Qualitative but can be made on location
 - Useful in diagnosis of oil layers (poor adhesion) and incomplete rinse of detergent (super adhesion and wetting).

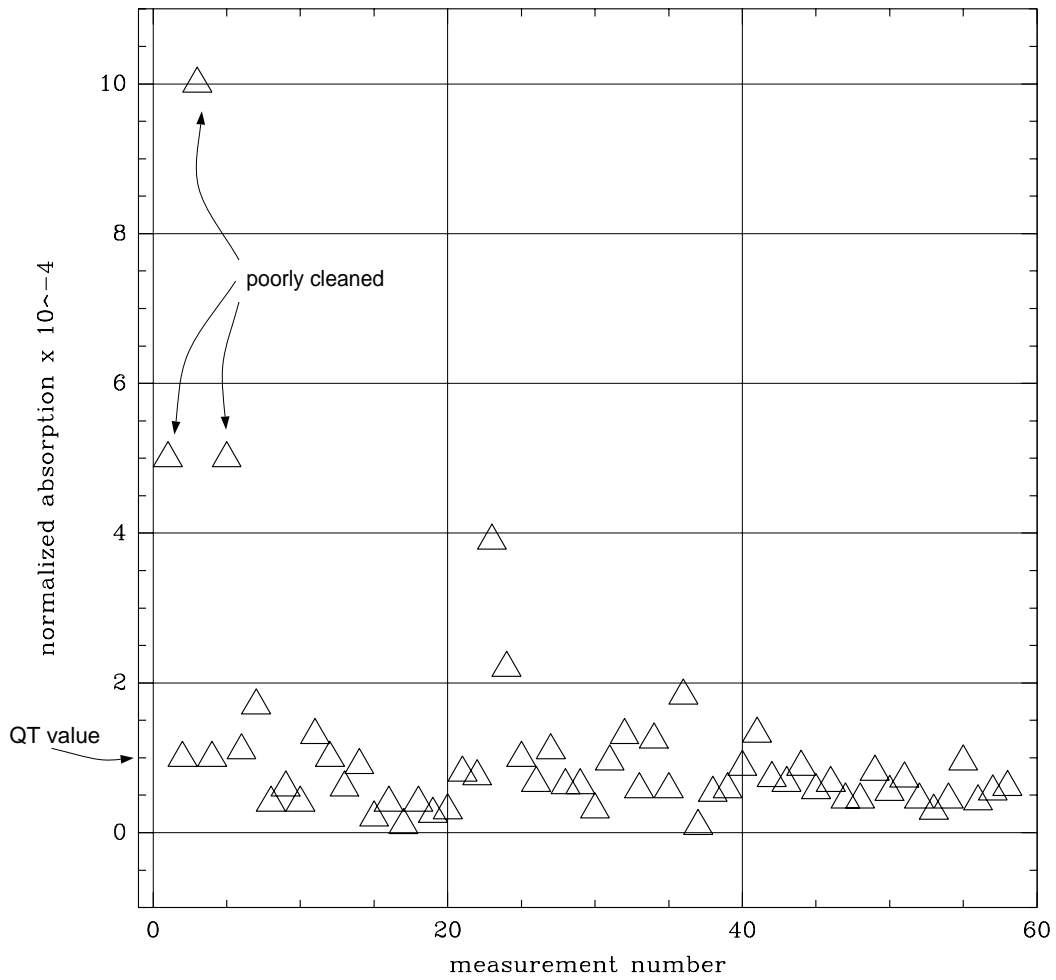

Normalized absorption z at 2950 cm⁻¹

$$z = \frac{(\ln(I/I_0)_{\text{sample}} - \ln(I/I_0)_{\text{reference}}) \times \text{KBr area} \times \text{sample volume in tube}}{\text{sample volume evaporated on KBr} \times \text{area of tube exposed}}$$

Typical values:

Area of tube exposed = 2×10^4 cm²

Sample volume in tube = 2 liters

Sample evaporated = 200 cc

KBr area = 0.6 cm²

$z \approx 1 \times 10^{-4}$ corresponds to 0.1 monolayer of 100 amu hydrocarbon

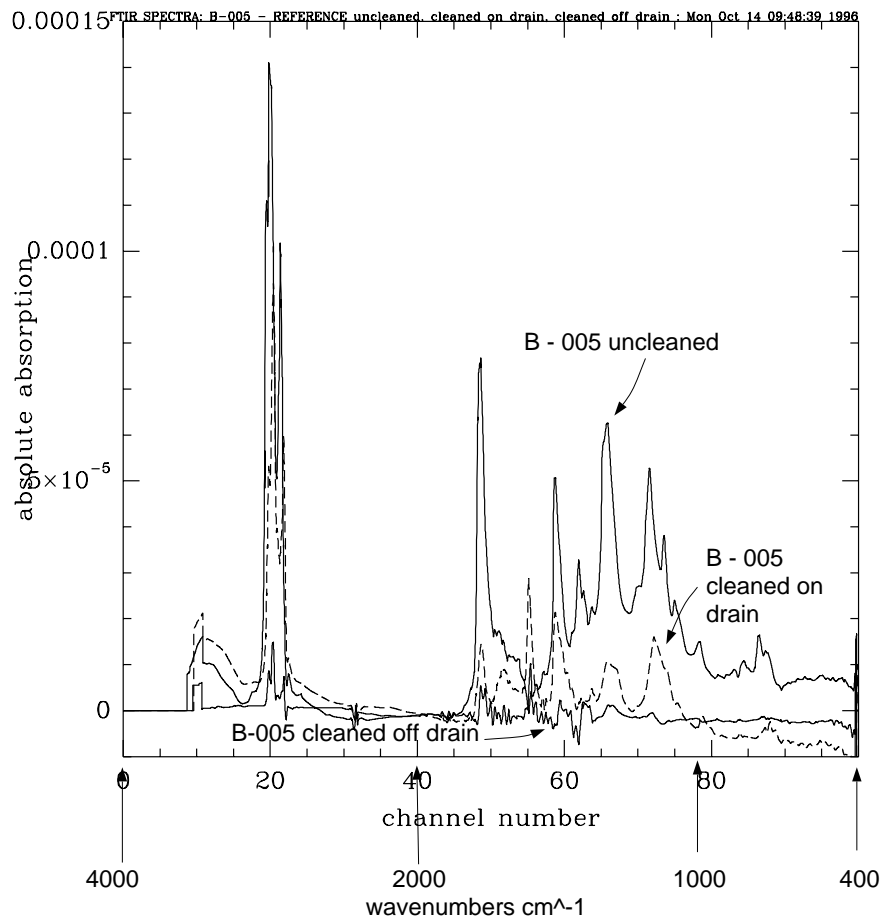

Spectra of tube B-005 uncleaned, and cleaned with sample taken along and off the drain line. The off drain sample is more characteristic of the average wall condition. The spectra have had the reference spectrum of the isopropanol subtracted, hence the negative values of the absorption.

Table 1: Auger analysis 270 ev Carbon line given in terms of 10^3 counts in 1.64 minutes vs A^+ milling time

<i>tube # or surface</i>	<i>condition</i>	<i>0 min</i>	<i>1 min</i>	<i>2 min</i>	<i>3 min</i>	<i>4 min</i>
22B	uncl	57.4	24.3	16.5	11.8	10.8
22B	cl	26.1	8.1	6.5	4.4	5.1
B-005	uncl	59.5	17.6	10.6	8.3	7.1±1.0
B-005	cl 1	24.3	5.2	2.3	1.0±1.0	0.0±1.0
B-005	cl 2	21.9	6.7	2.1	1.0±1.0	0.0±1.0
Oxidized	super cl	35.1	22.1	3.0	2.7±1.0	2.4±1.0
smooth	super cl	27.9	2.9	0.0±1.0		
rough	oily	61.9	64.9	63.2	62.3	62.3

Conditions:

Incident electron energy = 5kV
 Incident electron current = 100nA
 Ion milling energy = 2kV
 Ion current density = $10\mu A/cm^2$

5×10^4 counts of 270 ev electrons in 1.64 sec of acquisition time corresponds to 1 monolayer of carbon bearing molecule

Hydrogen Reduction

- Dry air bake at 454C for 36 hours
 - Reduced 1 micron reflectivity of 304 L
 - Max temperature to minimize Carbide formation
- Mechanism:
 - tight (20000K) and loose (5000K) H binding sites
 - reduce density of loosely bound H and J(300K)
 - surface important for recombination (Myers)
 - Oxide layer not a significant factor
- Avoid reintroduction in welding
 - Dry purge gas until weld is cool
 - Clean weld rod

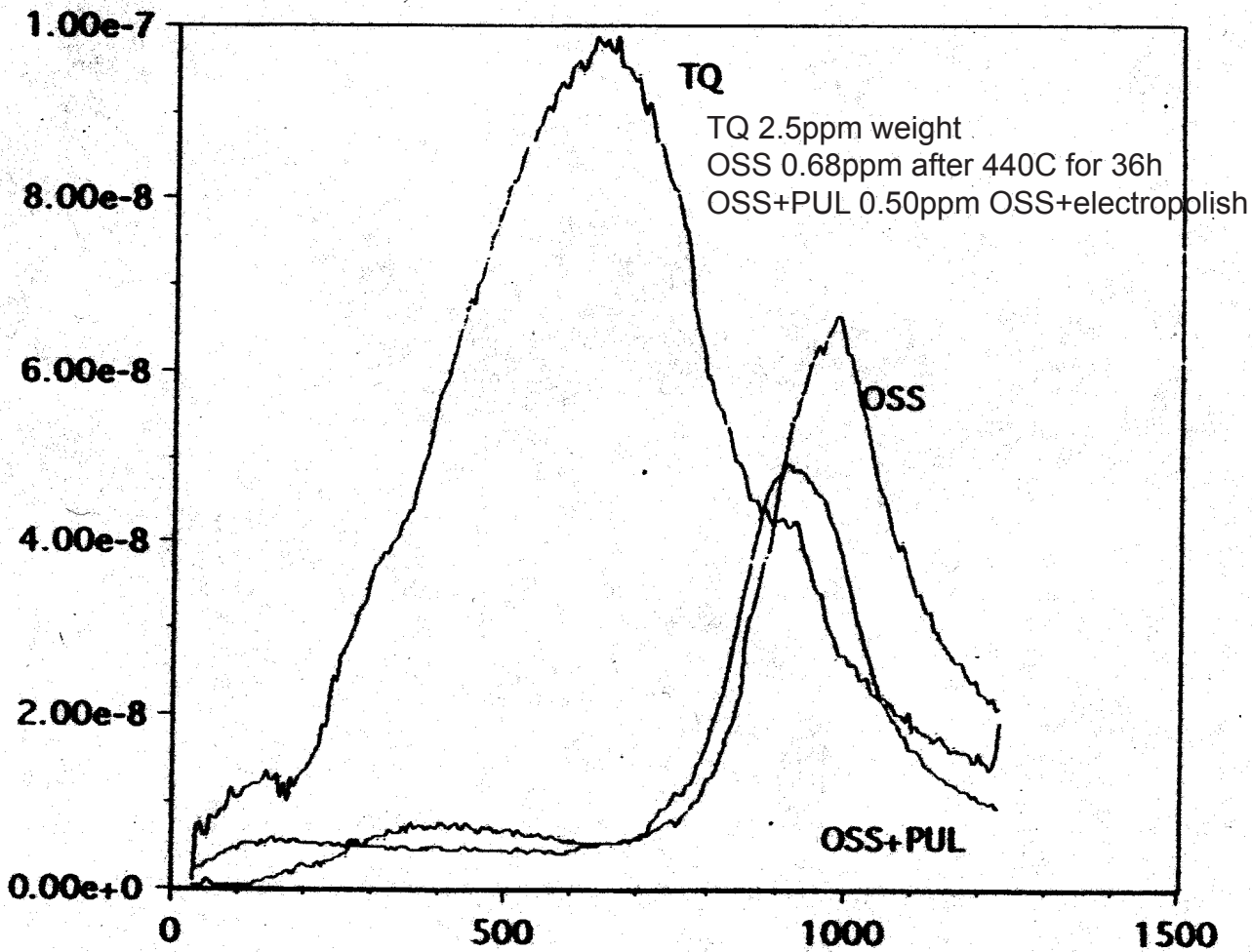

C. Bradaschia INFN, Pisa
A. Marraud CNRS, Orsay

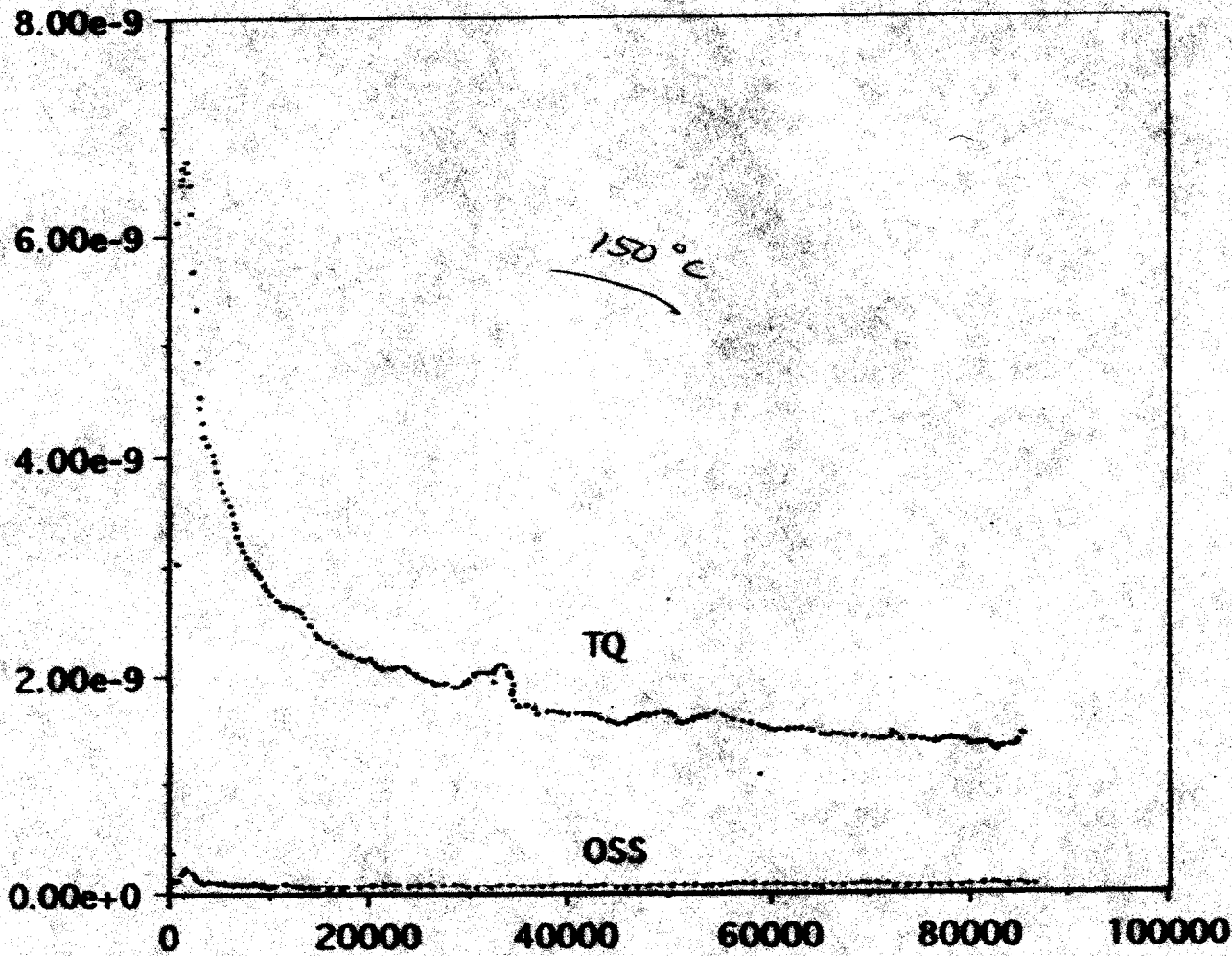

C. Bradaschia INFN, Pisa
A. Marraud CNRS, Orsay

t(s)

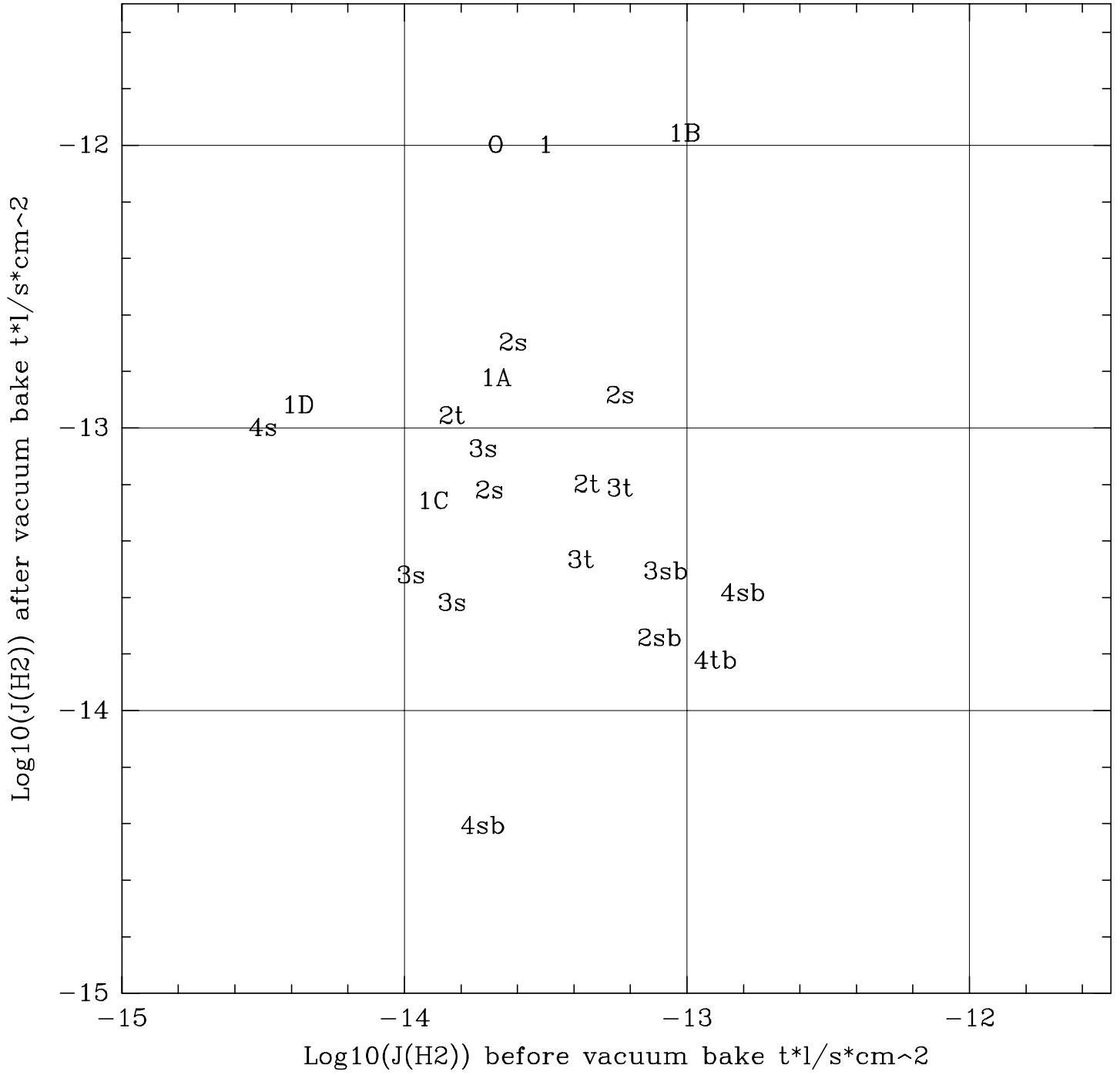

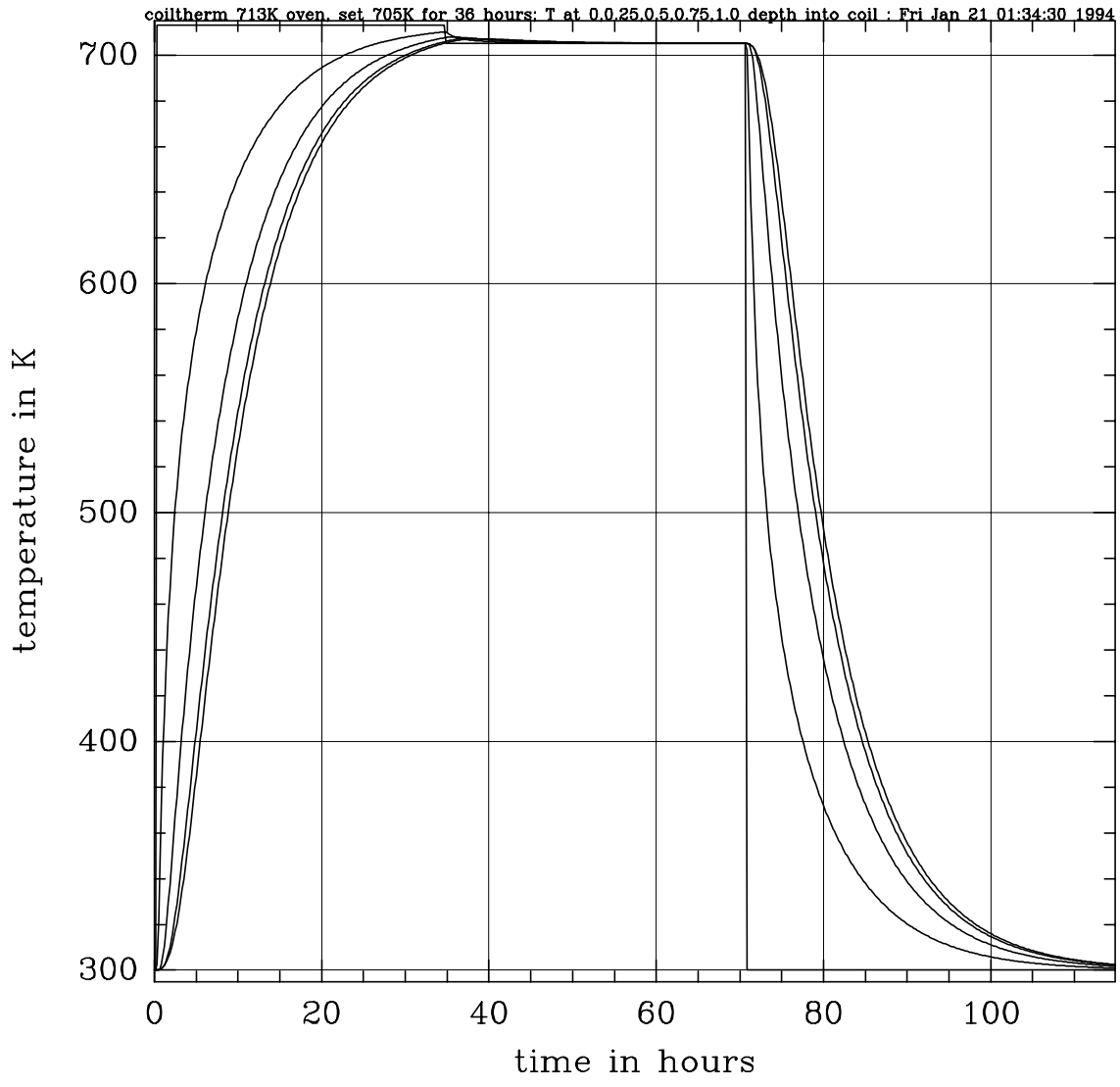

initial mobile hydrogen = 0.64 ppm, H2O density = 5e17 #/cc, T = 723K, solid inside, dots outside : Sat Dec 25 22:42:56 1993

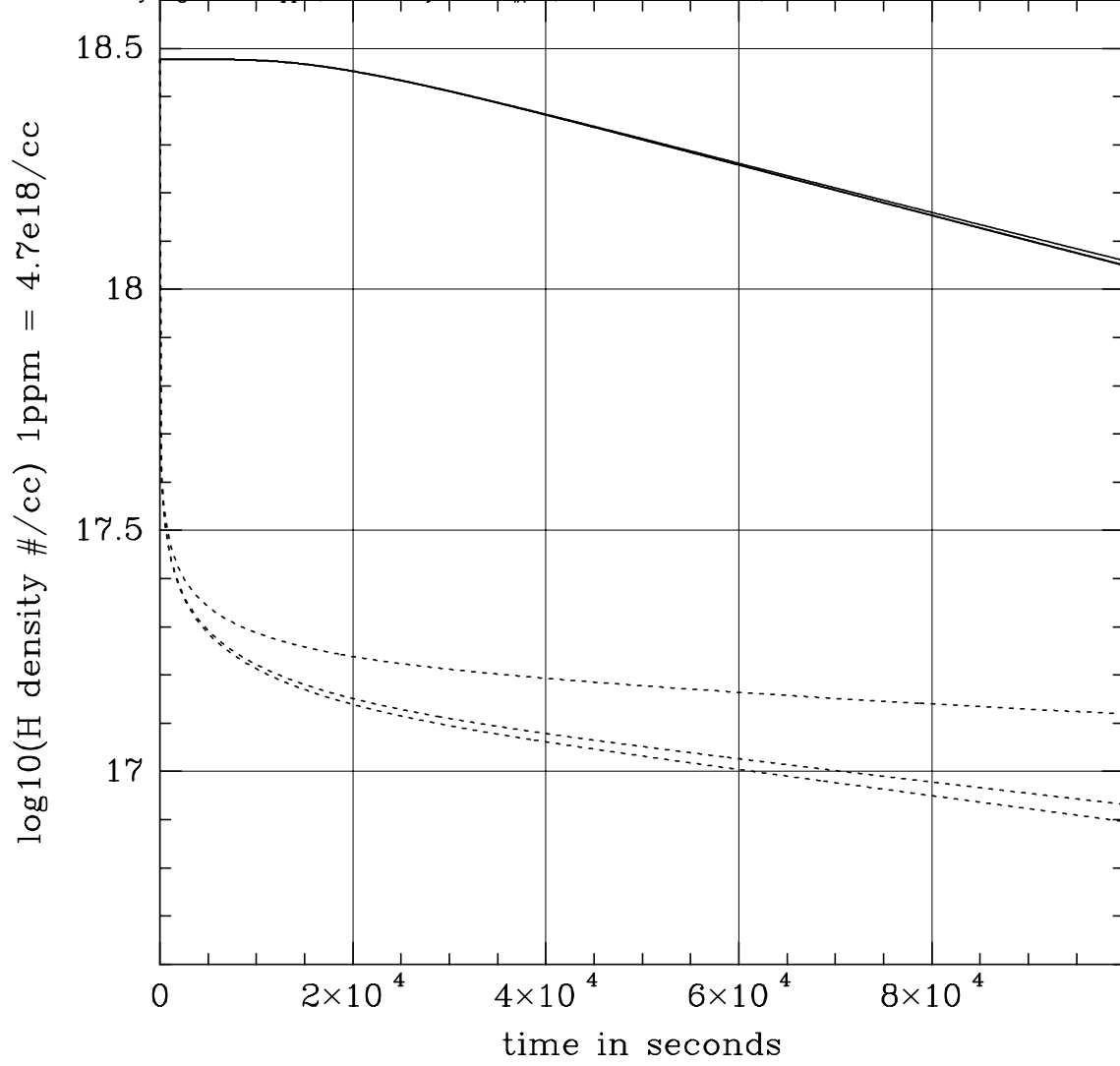

Chromium Carbide formation boundary temperature vs time at temperature
From several sources

Carbide Precipitation Boundary 304 SS .038 - .03% Carbon : Wed Mar 9 23:04:48 1994

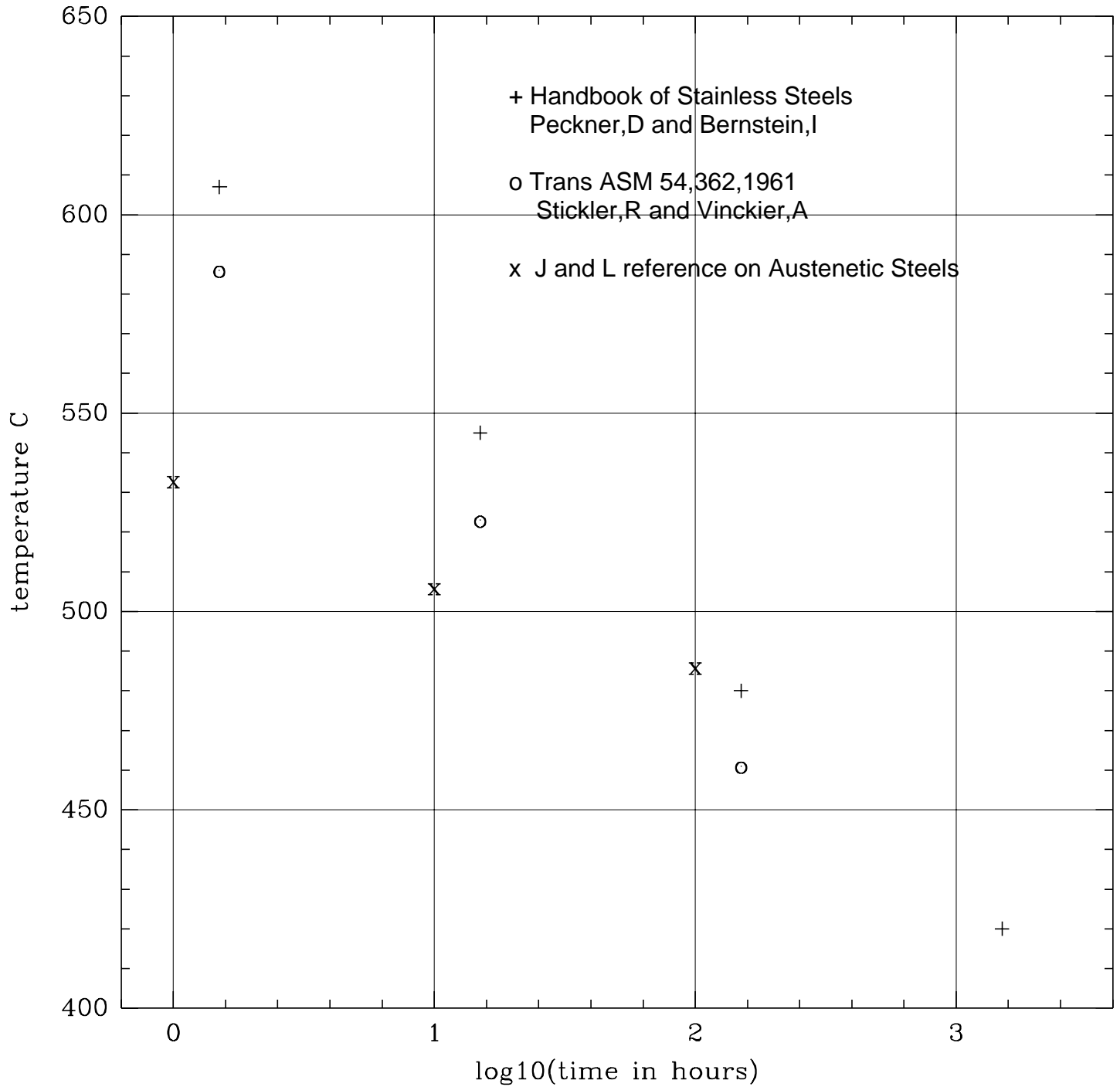

Heuristic Statistical Mechanics Model

Dubinin-Radushkevich (DR) equilibrium surface coverage:

$$\frac{\sigma}{\sigma_m} = e^{-(T/T_0)^2 \ln^2(P/P_0)}$$

DR site distribution function:

$$\theta(T_{bind}) = (2T_{bind}/T_0^2) e^{-(T_{bind}/T_0)^2}$$

$$\int_0^{\infty} \theta(T_{bind}) \delta T_{bind} = 1$$

Heuristic surface potential:

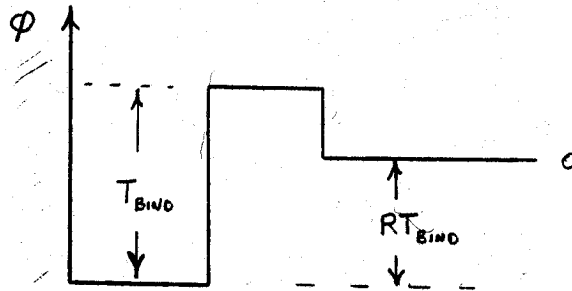

Emission time:

$$\tau_{emit}(T_{bind}) = \tau_0 e^{T_{bind}/T}$$

Adsorption time:

$$\tau_{ads} = \frac{4n\sigma_0}{\alpha p v_{th} (1 + (1 - R)T_{bind}/T) e^{-(1-R)T_{bind}/T}}$$

Detailed balance per site:

$$\frac{dP(T_{bind}, t)}{dt} = -\frac{P(T_{bind}, t)}{\tau_{emit}} + \frac{(1 - P(T_{bind}, t))}{\tau_{ads}}$$

Integration:

$$P(T_{bind}, t) = P(T_{bind}, 0)e^{-t/\tau} + P_{equil}(T_{bind})(1 - e^{-t/\tau})$$

where

$$\tau = \frac{\tau_{emit}\tau_{ads}}{(\tau_{emit} + \tau_{ads})}$$

and

$$P_{equil}(T_{bind}) = \frac{\tau_{emit}}{(\tau_{emit} + \tau_{ads})}.$$

Incremental outgassing rate of band of sites:

$$dJ_{out}(t) = n\sigma_0 \theta(T_{bind}) \left(\frac{dP(T_{bind}, t)}{dt} \right) \delta T_{bind}$$

Aside: for $P(T_{bind}, 0) = 1$ and $\tau_{ads} \rightarrow \infty$

$$J_{out}(t, T) = \left(\frac{2n\sigma_0 T}{tT_0} \right) \int_0^a b \ln(y/a) e^{-(b \ln(y/a))^2} e^{-y} dy$$

where

$$b = T/T_0 \quad a = t/\tau_0$$

Computational algorithm (waterbakesm.f)

Step time:

$$\Delta t / \tau_s = f \quad \tau_s = V / F$$

Probability computation over 1024 binding energies $0 \rightarrow 3T_0$

$$P(T_{bind}, t_{j+1}) = P(T_{bind}, t_j) e^{-f\tau_s/\tau_j} + P_{equil}(T_{bind}, t_j) (1 - e^{-f\tau_s/\tau_j})$$

Surface coverage:

$$\sigma(t_{j+1}) = n\sigma_0 \sum_0^{3T_0} \theta(T_{bind}) P(T_{bind}, t_{j+1}).$$

Outgassing rate:

$$J(t_{j+1}) = \frac{(\sigma(t_{j+1}) - \sigma(t_j))}{f\tau_s}$$

Pressure:

$$p(t_{j+1}) = p(t_j) e^{-f} + \left(\frac{J(t_j)A}{F} \right) (1 - e^{-f})$$

GO BACK AND DO IT AGAIN (new time and temperatures)

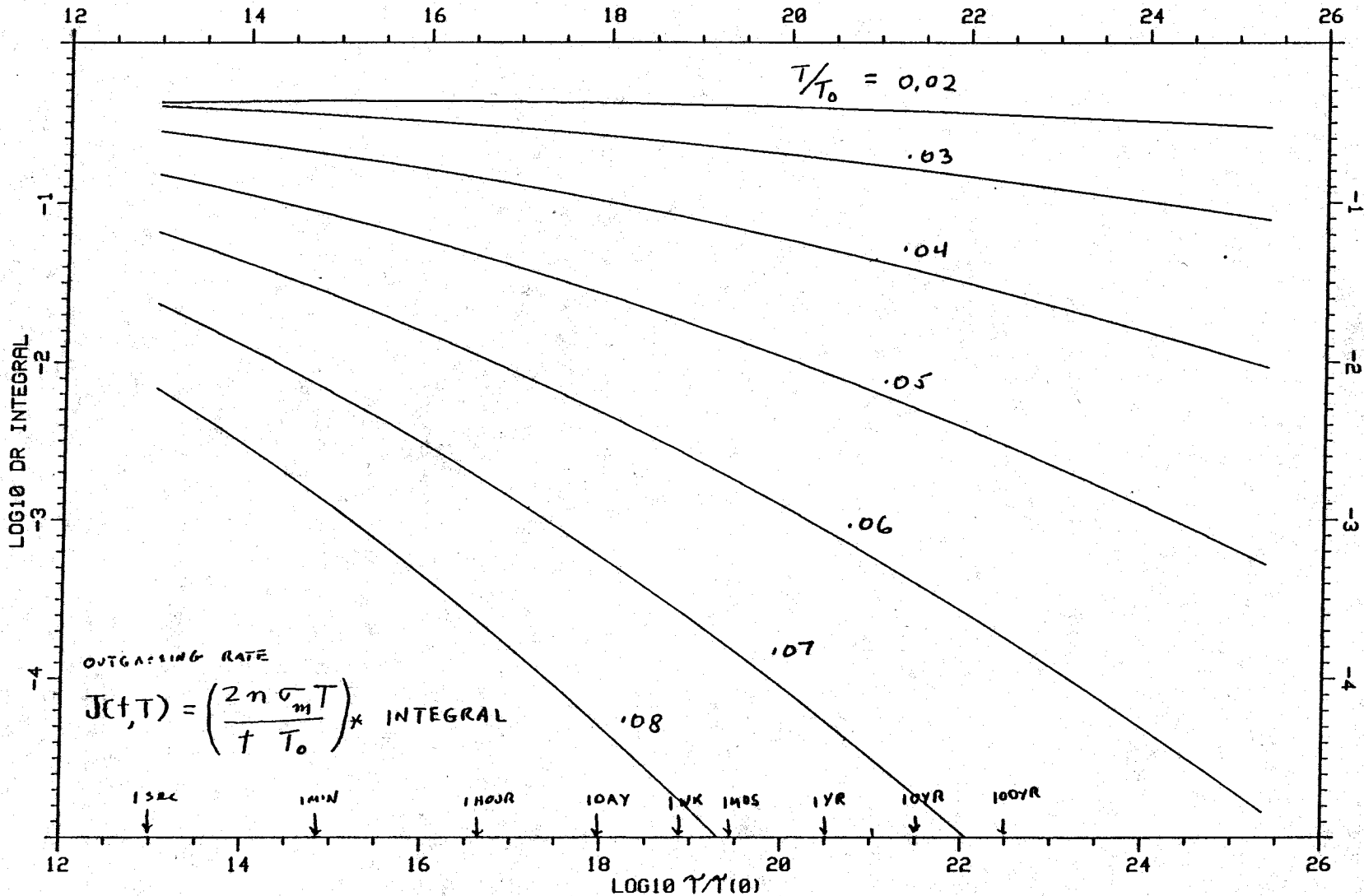

ASSUME $\zeta_0 = 10^{-13}$ sec

DR INTEGRAL VS NORMALIZED PUMPING TIME

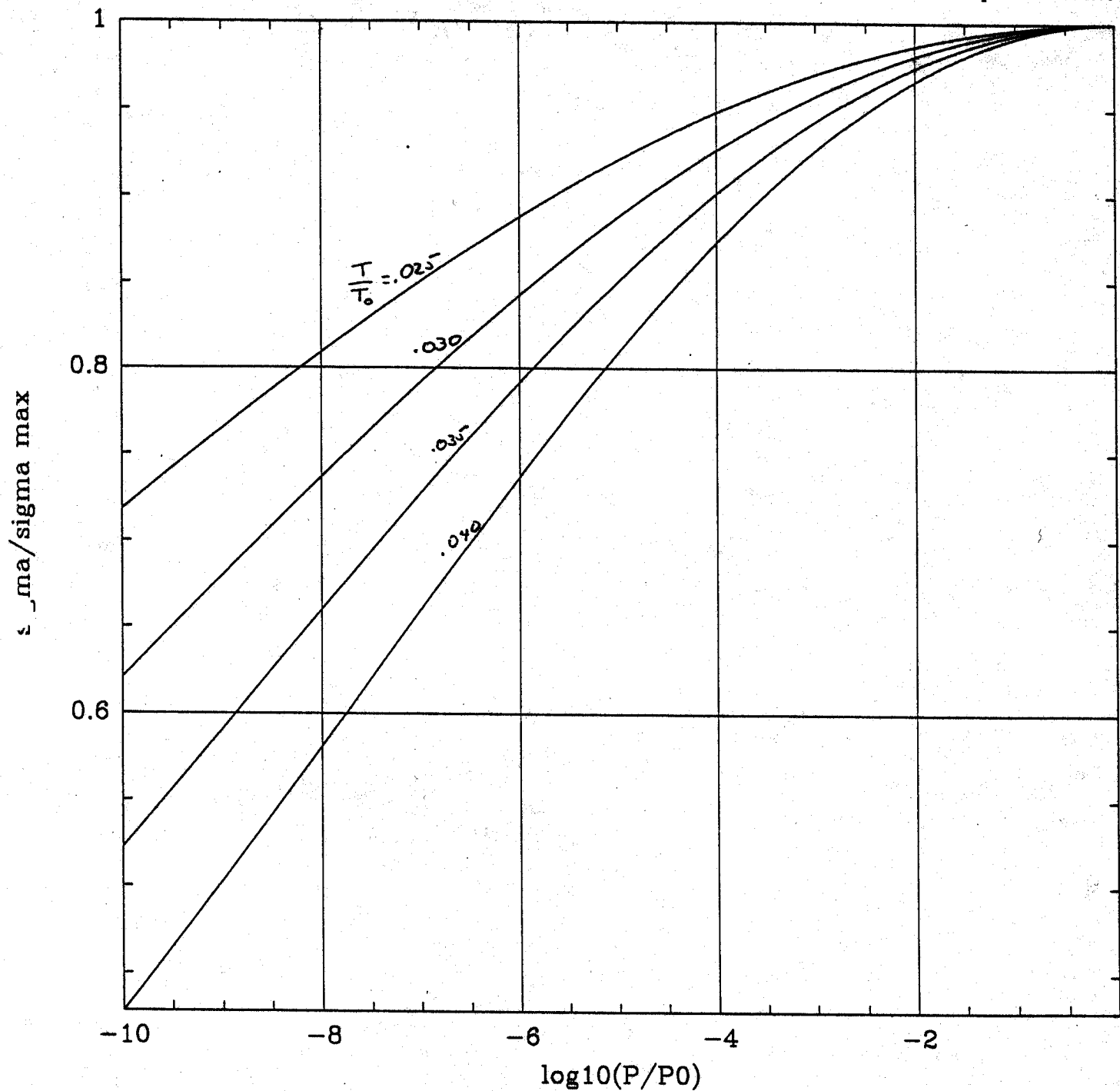

$$z_{\max} = \rho - \left(\frac{T}{T_0}\right)^2 \ln^2(P/P_0)$$

EQUILIBRIUM WITH SURFACE

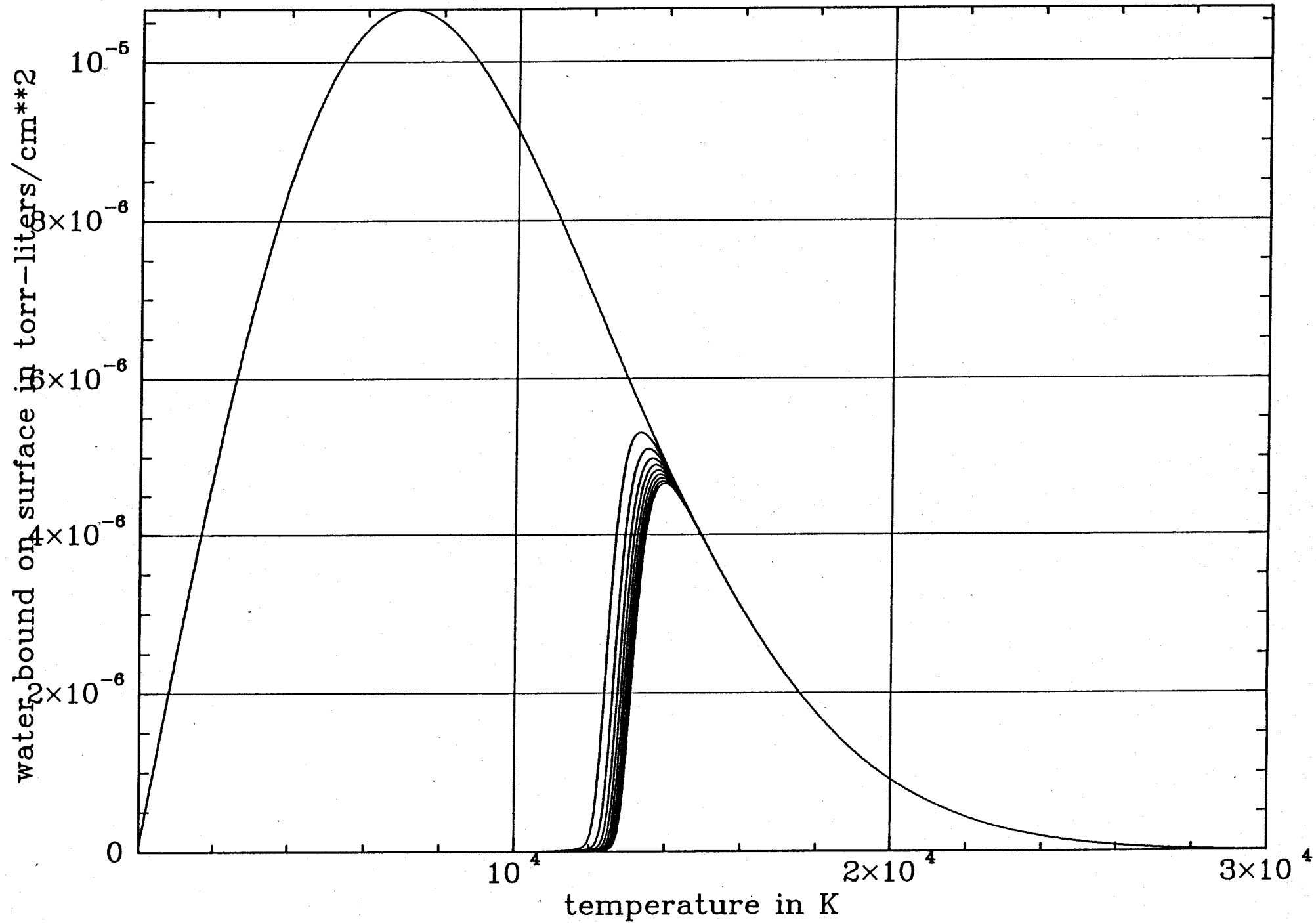

140C btd bake and model sigma = 285 monolayers T0 = 1.0e4 K r = 0.7 ; Fri Nov 6 19:07:07 1992

log₁₀(H₂O outgassing rate) torr lit/sec cm²

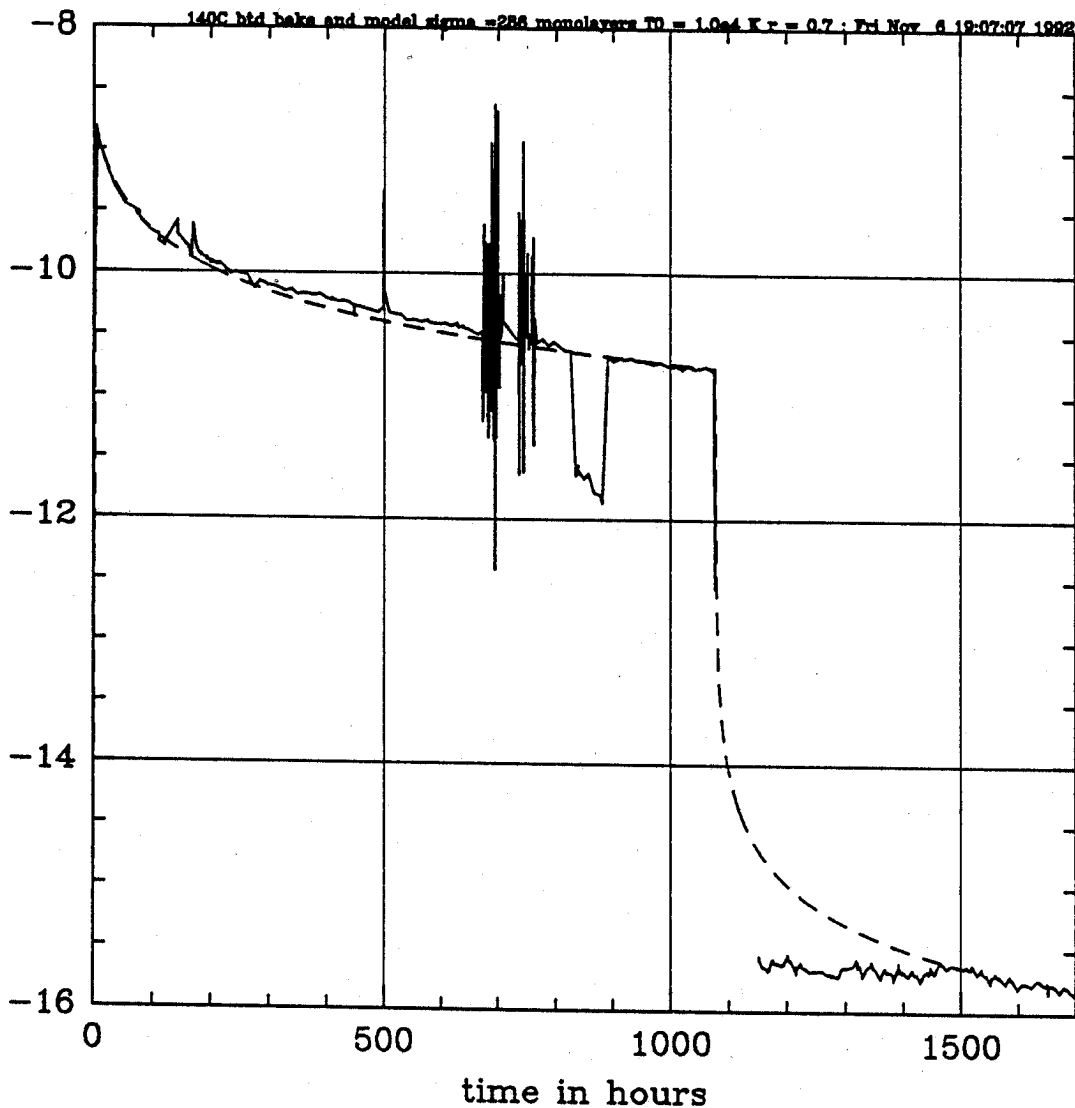

BEAM TUBE BAKEOUT ELECTRICAL HEATING POWER

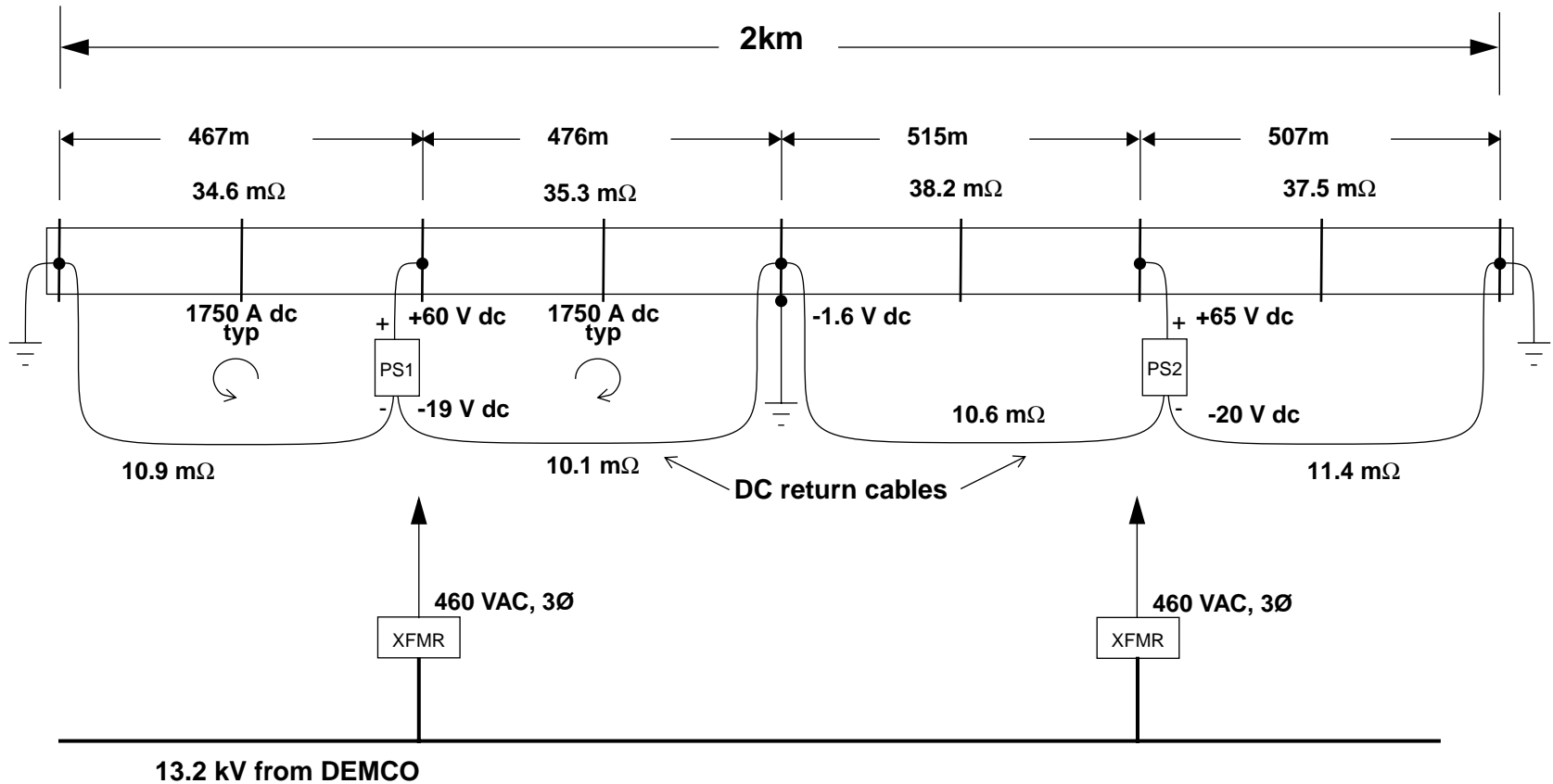

Legend: XFMR Power Transformer PS Low voltage, high current DC power supply



SCHEMATIC OF PUMPS AND RGA DURING BAKEOUT

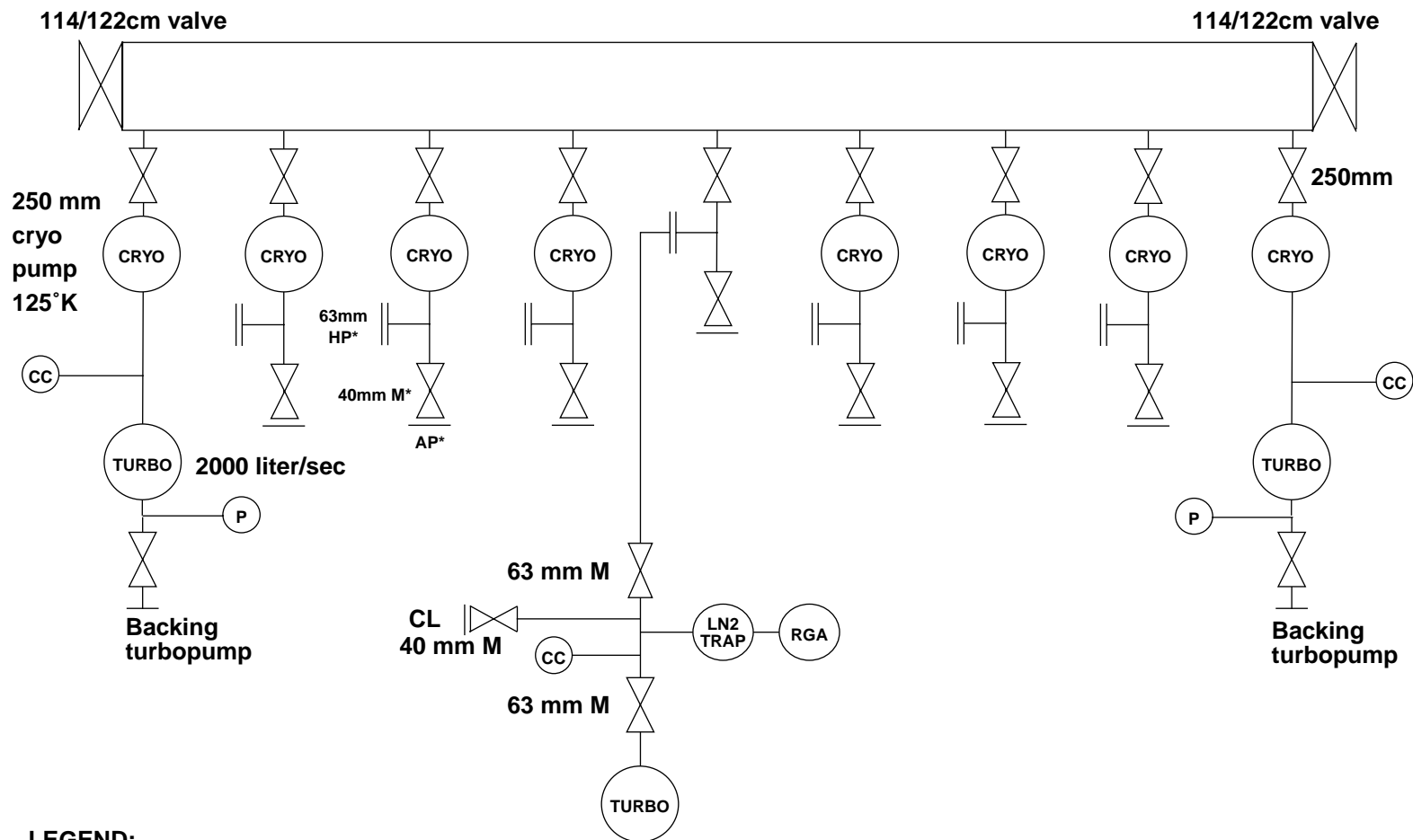

LEGEND:

- AP Port for auxiliary pump
- CC Cold Cathode gauge
- CL Port for calibration leaks
- HP Port for RGA head installation

- M Metal sealed valve
- P Pirani gauge

* Type H Pump Port Hardware furnished by CBI



POST-BAKE TEST CONFIGURATION

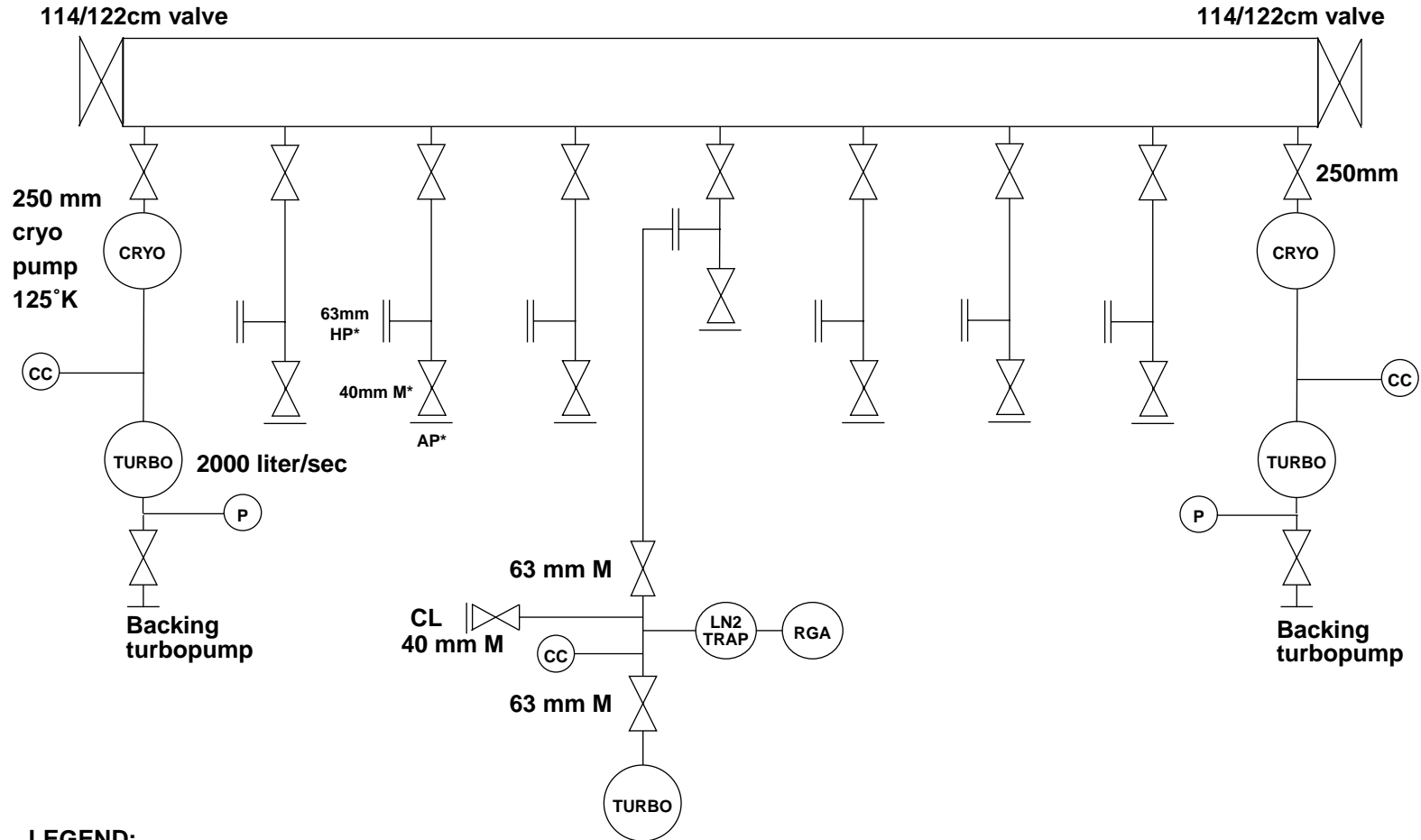

LEGEND:





AP Port for auxiliary pump
 CC Cold Cathode gauge
 CL Port for calibration leaks
 HP Port for RGA head installation

M Metal sealed valve
 P Pirani gauge

* Type H Pump Port Hardware furnished by CBI

CALIBRATION ASSEMBLY

LEGEND:

-  ALL METAL UHV VALVE
-  CALIBRATED GAS LEAK
-  LIQUID NITROGEN TRAP
-  CONFLAT FLANGE

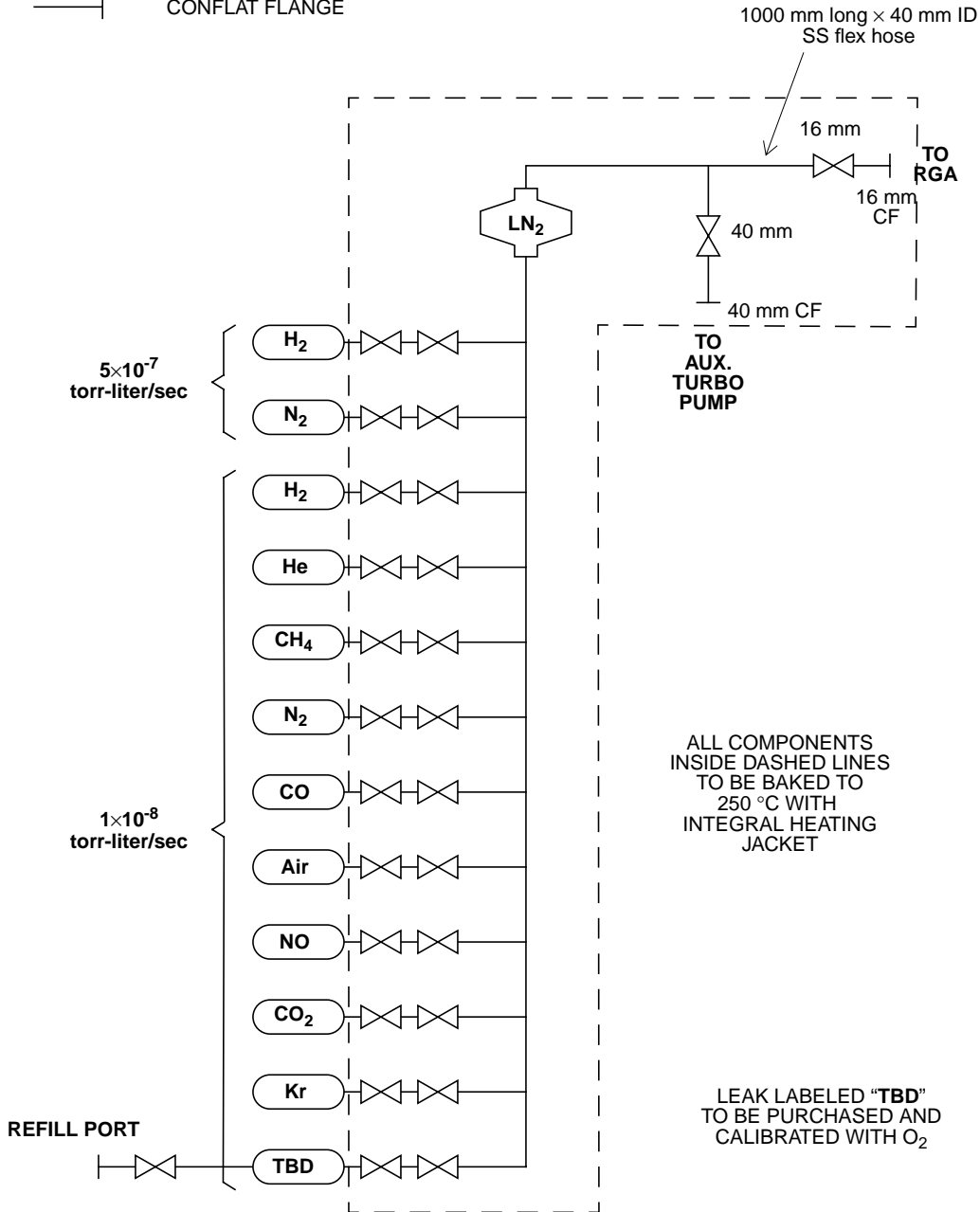

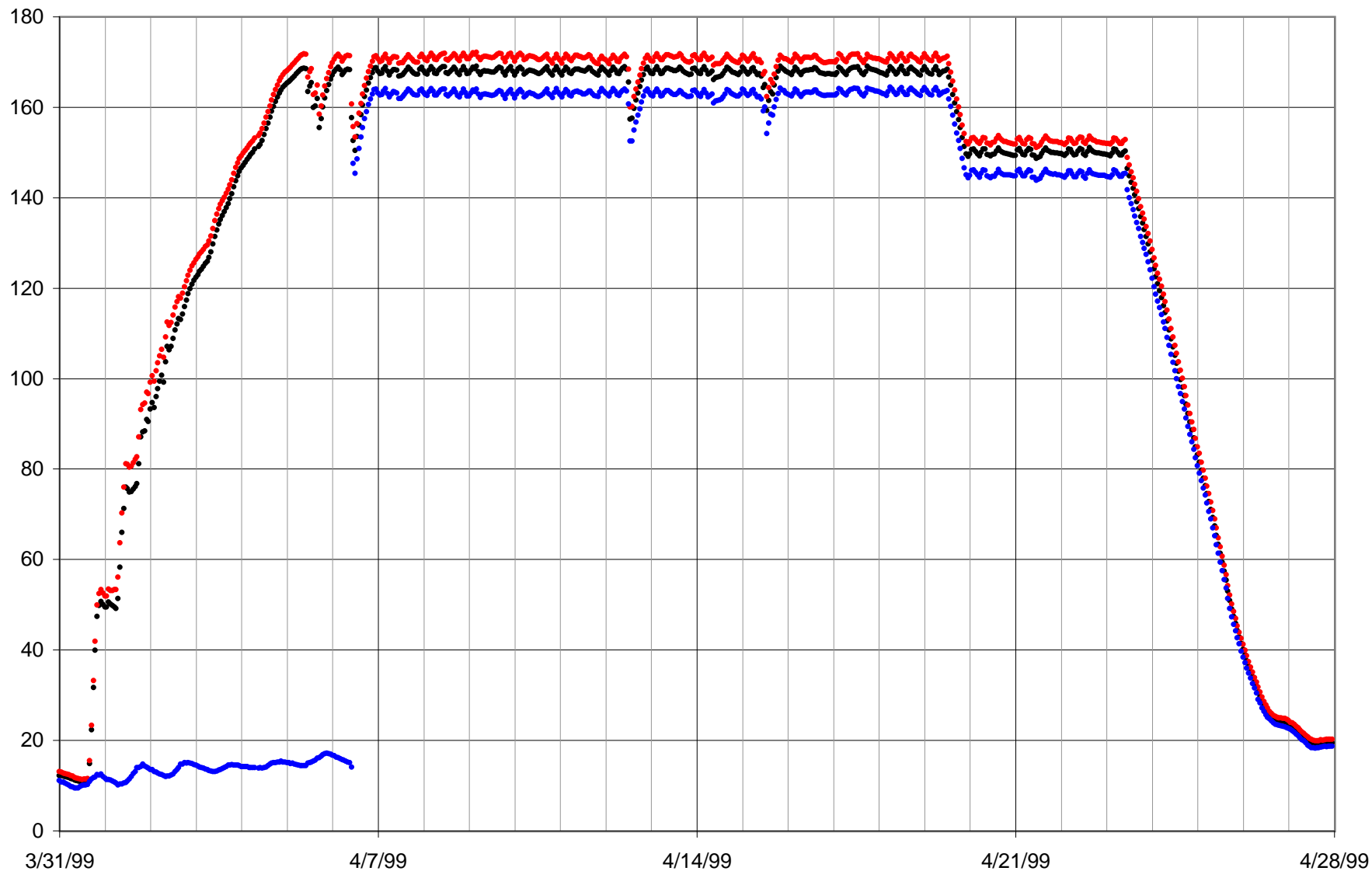

• ave temp • max temp • min temp



HX2 RGA PRESSURE, AMU 2 (blk), AMU 18 (blu), AMU 28 (red), AMU 44 (green)

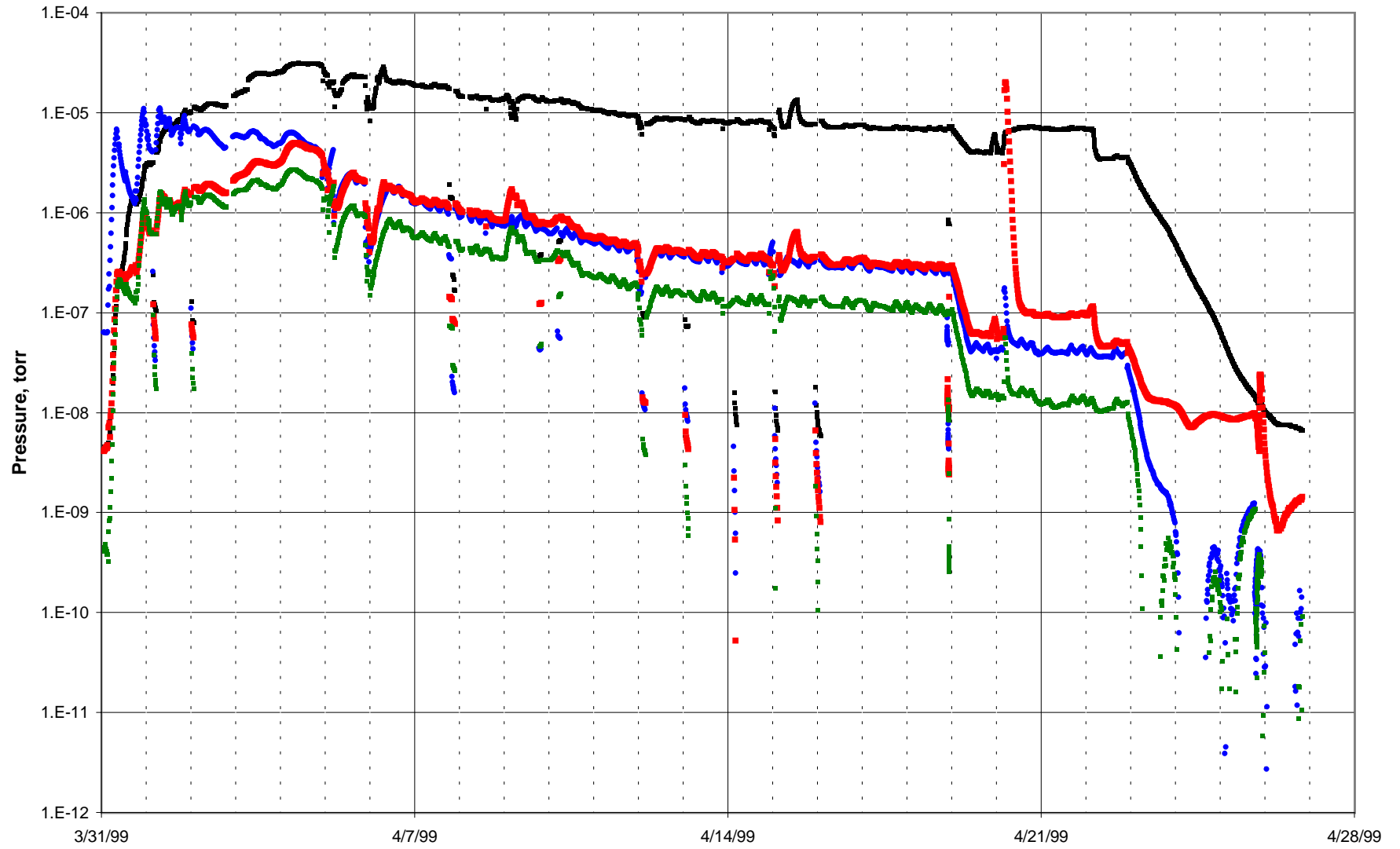

Postbake measurements of module X1 at Hanford

March 11-12, 1999

Table 1: Results from gas model solution of 16.9 hour postbake accumulation ending March 12, 1999 at 10:00AM .

molecule	Outgassing rate @ 10C	pressure@ 10C	outgassing rate @ 23C	pressure@ 23C
	torr liters/sec/cm ²	torr	torr liters/sec/cm ²	torr
H ₂	1.6 x 10 ⁻¹⁴	1.0 x 10 ⁻⁹	5.2 x 10 ⁻¹⁴	3.4 x 10 ⁻⁹
CH ₄	< 2 x 10 ⁻²⁰	< 3.4 x 10 ⁻¹³	< 8.8 x 10 ⁻²⁰	< 1.5 x 10 ⁻¹²
H ₂ O	< 3 x 10 ⁻¹⁹	< 5.2 x 10 ⁻¹³	< 1.3 x 10 ⁻¹⁸	< 2.3 x 10 ⁻¹²
N ₂	< 9 x 10 ⁻¹⁹ **	< 1.5x 10 ⁻¹³		
CO	< 1.3 x 10 ⁻¹⁸	< 1.7 x 10 ⁻¹³	< 5.7 x 10 ⁻¹⁸	< 7 x 10 ⁻¹³
O ₂	< 1.2 x 10 ⁻²⁰	< 2.3 x 10 ⁻¹⁴		
A	< 2.5x 10 ⁻²⁰	< 3.6 x 10 ⁻¹⁴		
CO ₂	< 6.5 x 10 ⁻²⁰	< 1.2x 10 ⁻¹³	< 2.9 x 10 ⁻¹⁹	<5.2 x 10 ⁻¹³
NO+C ₂ H ₆	< 1.5 x 10 ⁻¹⁹	< 1.6 x 10 ⁻¹³	< 6.6x 10 ⁻¹⁹	< 7.2 x 10 ⁻¹³
H _n C _p O _q	∑ amu41,43,55,57 < 1.2 x 10 ⁻¹⁹	< 2.2 x 10 ⁻¹³	∑ amu41,43,55,57 < 5.3 x 10 ⁻¹⁹	< 9.7 x 10 ⁻¹³

Volume = 2.4 x 10⁶ liters and Area = 7.8 x 10⁷ cm²

** The equivalent air leak into the module Q < 3.5x 10⁻¹¹ torr liters/sec from amu 28.

Correction from 10C to 23C uses a binding temperature of 8000K for hydrogen and 10000K for all other molecules

The data shows the outgassing rates of the tube are acceptable. The higher temperature bake at 168C for a shorter time has accomplished a better result than the longer bakes at 150C.

Beam Tube Bakeout Results

	Outgassing Rate corrected to 23 °C torr liters/sec/cm ² (All except H ₂ are upper limits)					
molecule	Goal*	HY2	HY1	HX1	HX2	
H ₂	4.7	4.8	6.3	5.2	4.6	× 10 ⁻¹⁴
CH ₄	48000	< 900	< 220	< 8.8	< 95	× 10 ⁻²⁰
H ₂ O	1500	< 4	< 20	< 1.8	< 0.8	× 10 ⁻¹⁸
CO	650	< 14	< 9	< 5.7	< 2	× 10 ⁻¹⁸
CO ₂	2200	< 40	< 18	< 2.9	< 8.5	× 10 ⁻¹⁹
NO+C ₂ H ₆	7000	< 2	< 14	< 6.6	< 1.0	× 10 ⁻¹⁹
H _n C _p O _q	50–2 [†]	< 15	< 8.5	< 5.3	< 0.4	× 10 ⁻¹⁹

air leak	1000	< 20	< 10	< 3.5	< 16	× 10 ⁻¹¹ torr liter/sec
----------	------	------	------	-------	------	------------------------------------

*Goal: maximum outgassing to achieve pressure equivalent to 10⁻⁹ torr H₂ using only pumps at stations

[†]Goal for hydrocarbons depends on weight of parent molecule; range given corresponds with 100–300 AMU