

# Experimental progress with the quantum noise limit

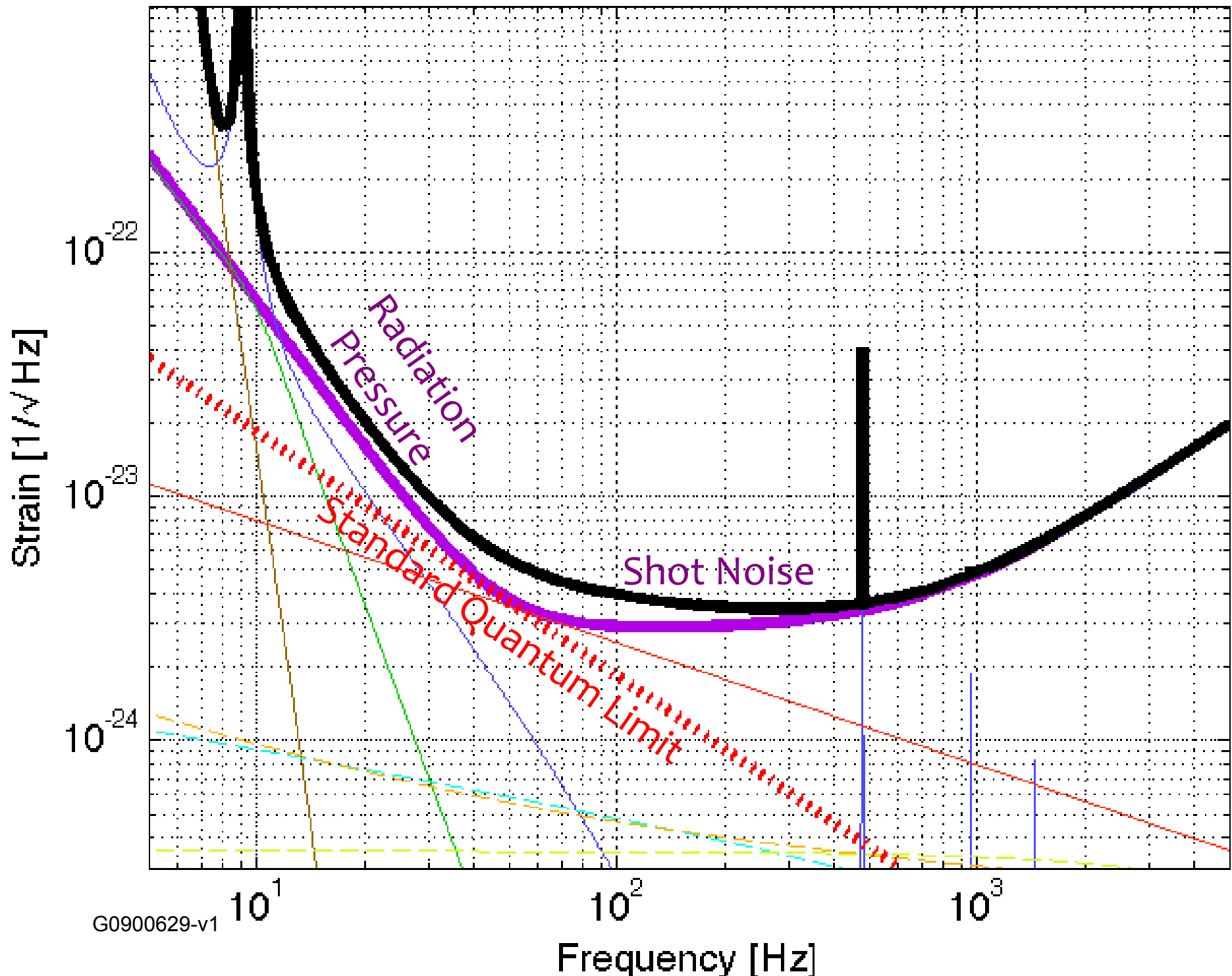

Christopher Wipf  
GWADW 2009

# In Advanced Detectors, Quantum Noise Is Everywhere!



# Mechanism

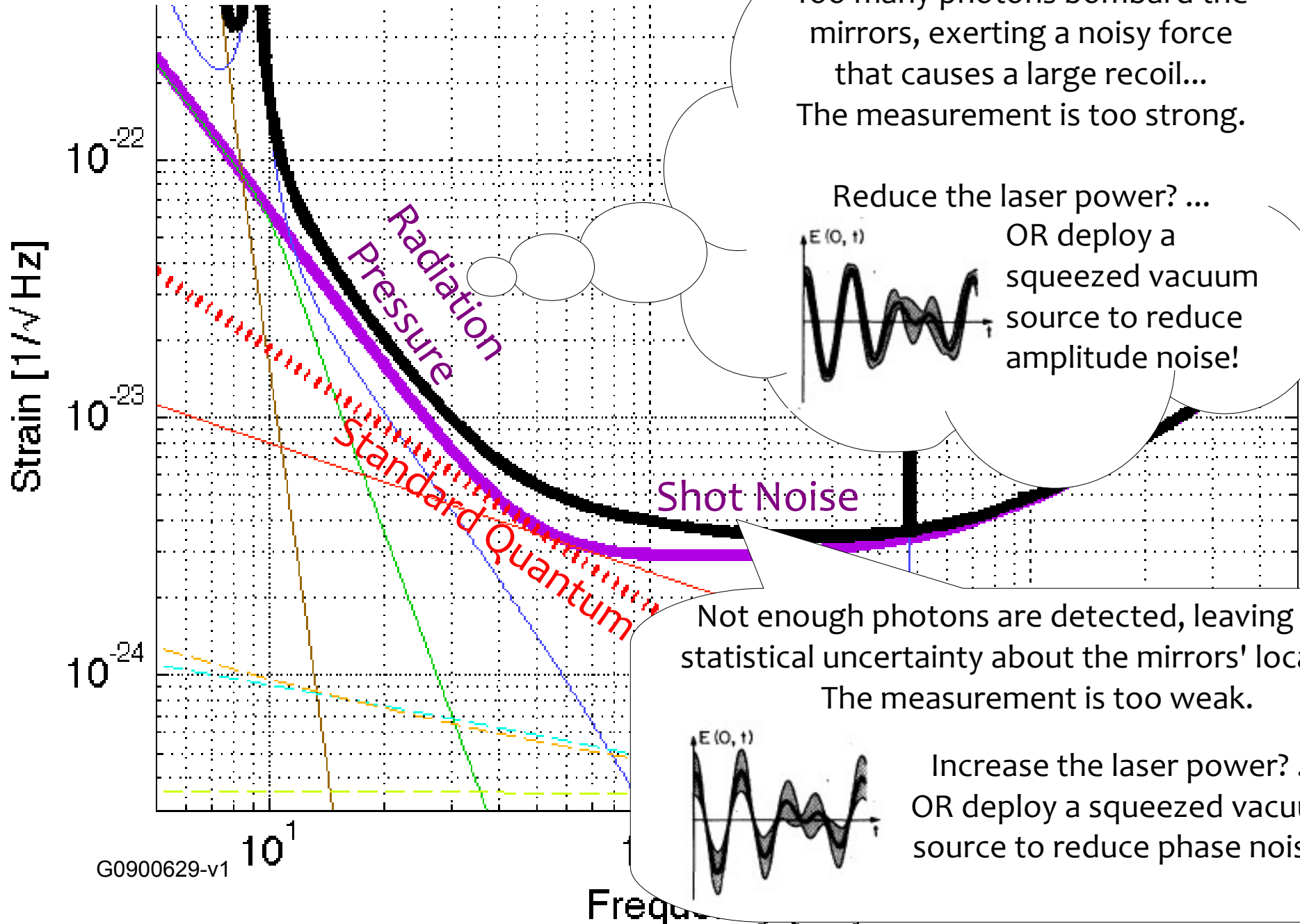

# Questions

- Shot noise reduction with squeezed vacuum

$10^{-22}$  Crystal squeezing's two decades of development culminate in one big question...

– *Is this ready to become standard-issue equipment on a GW interferometer?*

- The back-action of our measurement has arrived

– *How do we cope with RP-dominated systems?*

– *Can we learn about macroscopic quantum mechanics?*

- Ponderomotive squeezing and entanglement of the light
- Interesting quantum states of the test masses
- Quantum limits are opportunities in disguise!

Strain [1/√Hz]

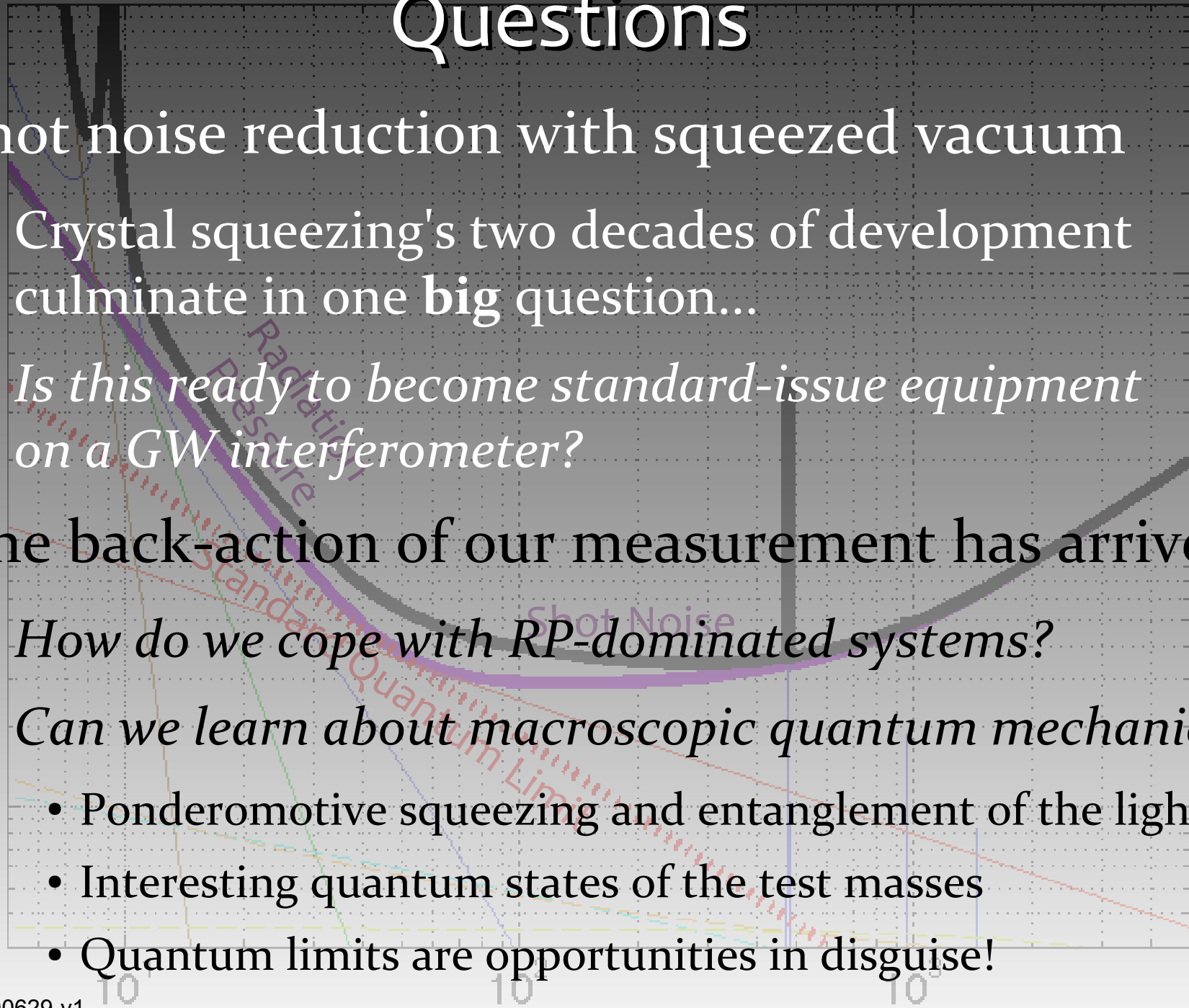

# Squeezing with nonlinear crystals

- Amplitude and phase correlated via Kerr effect (Refractive index  $\Delta n \sim \text{intensity } I$ )
- Needs a bright frequency-doubled “pump” beam
- Use a cavity to amplify the effect

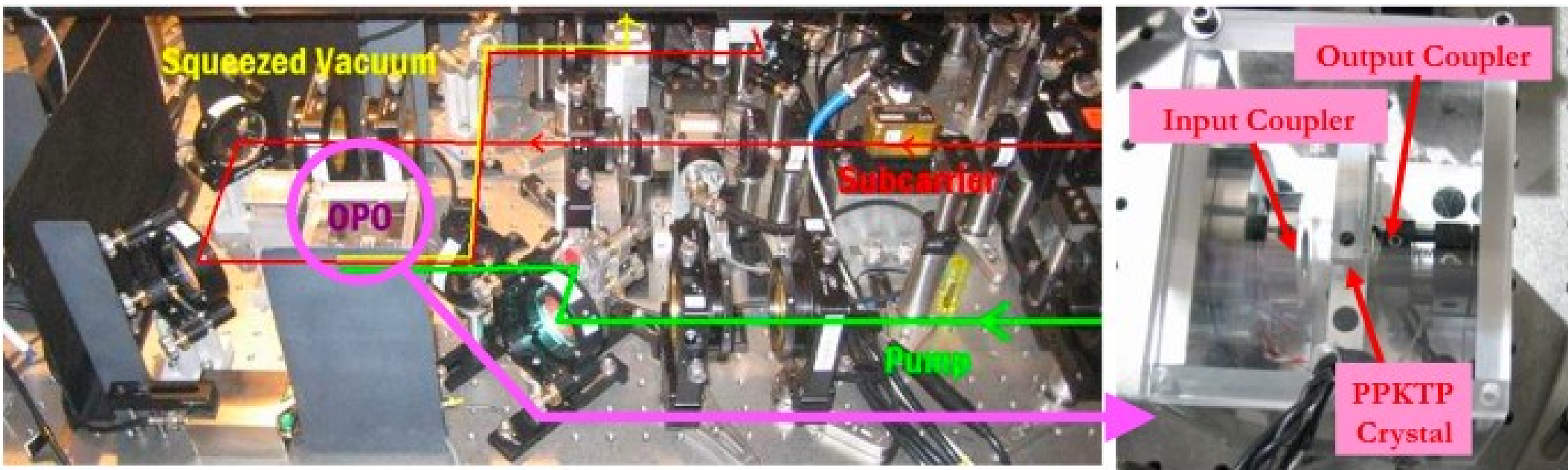

# Time for a squeezing-enhanced LIGO ?

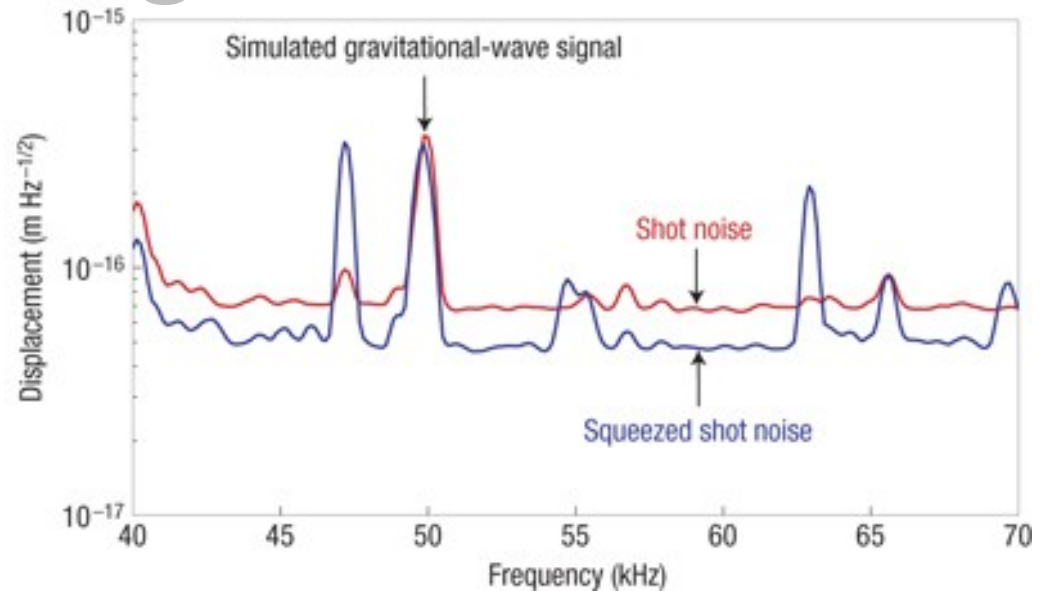
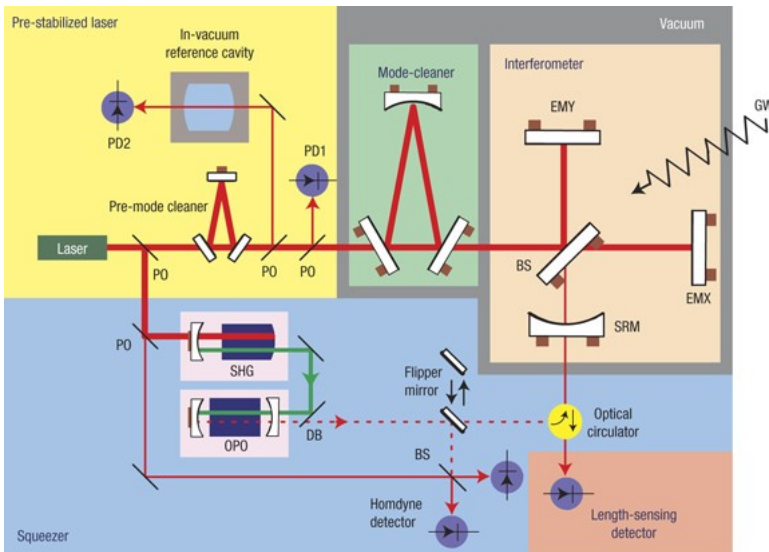

[Goda et al., Nature Phys. 4 472 (2008)]

- Successful proof of principle at Caltech 40m IFO
- VLF squeezing (sub-10 Hz!) achieved at AEI
- Possible opportunity to test on H1 after S6
- Meet our sensitivity goals using less laser power
  - Fewer headaches from RP instability, thermal lensing

# Squeezed Enhanced LIGO, 30 W

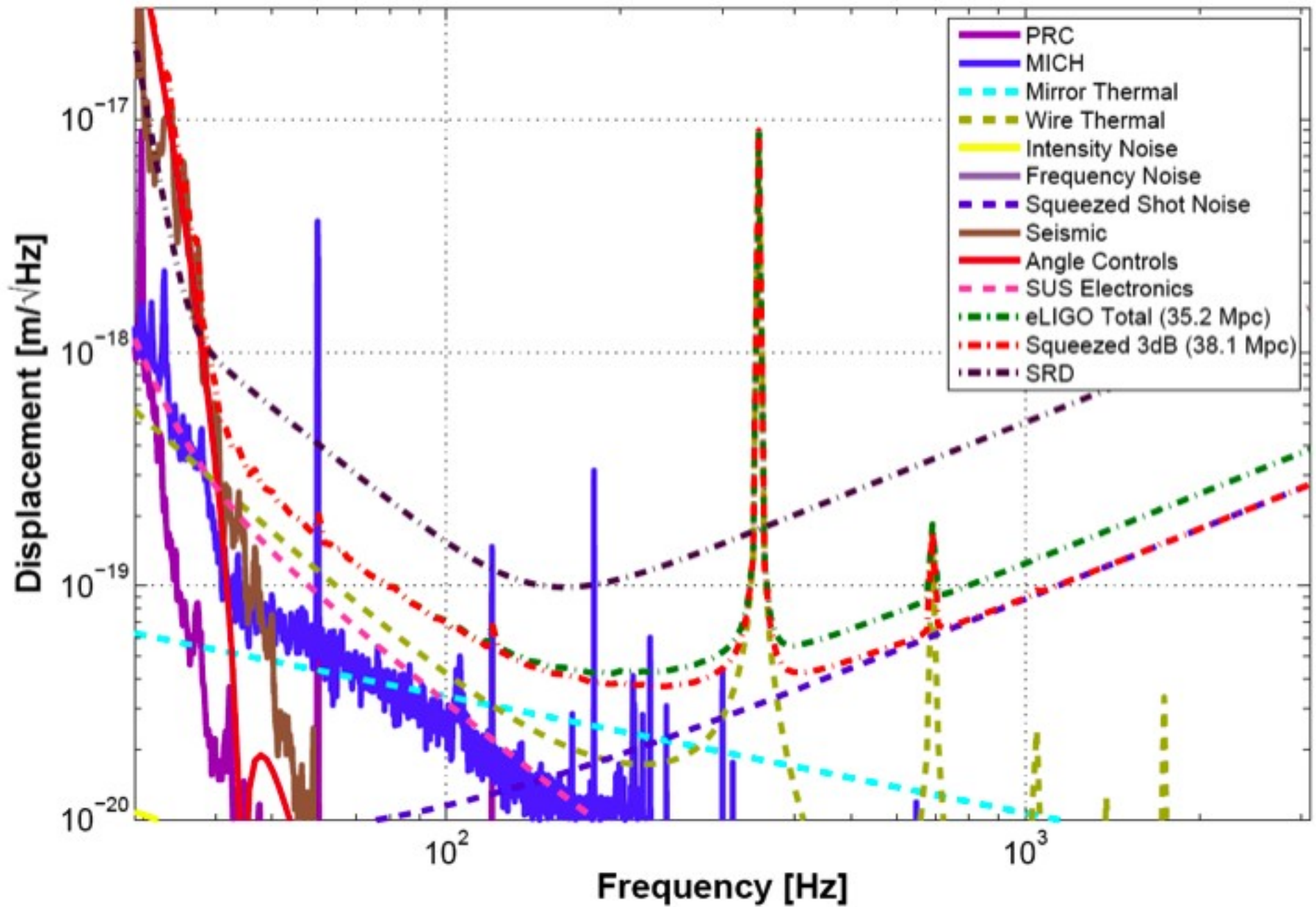

# Squeezing enhancement of Advanced LIGO

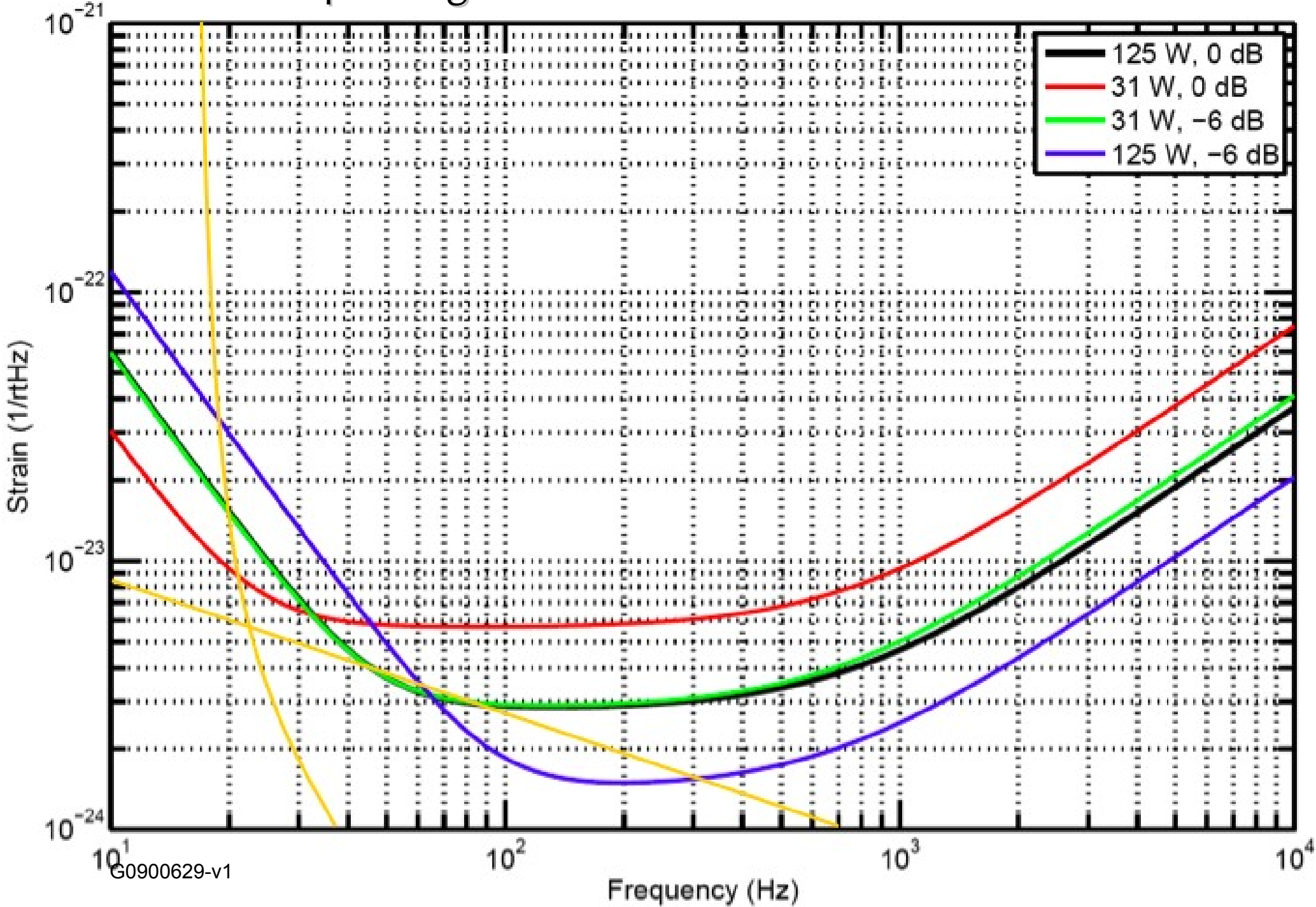

G0900629-v1



Squeezing at 100 kHz rel to Shot Noise - 24/01/2009

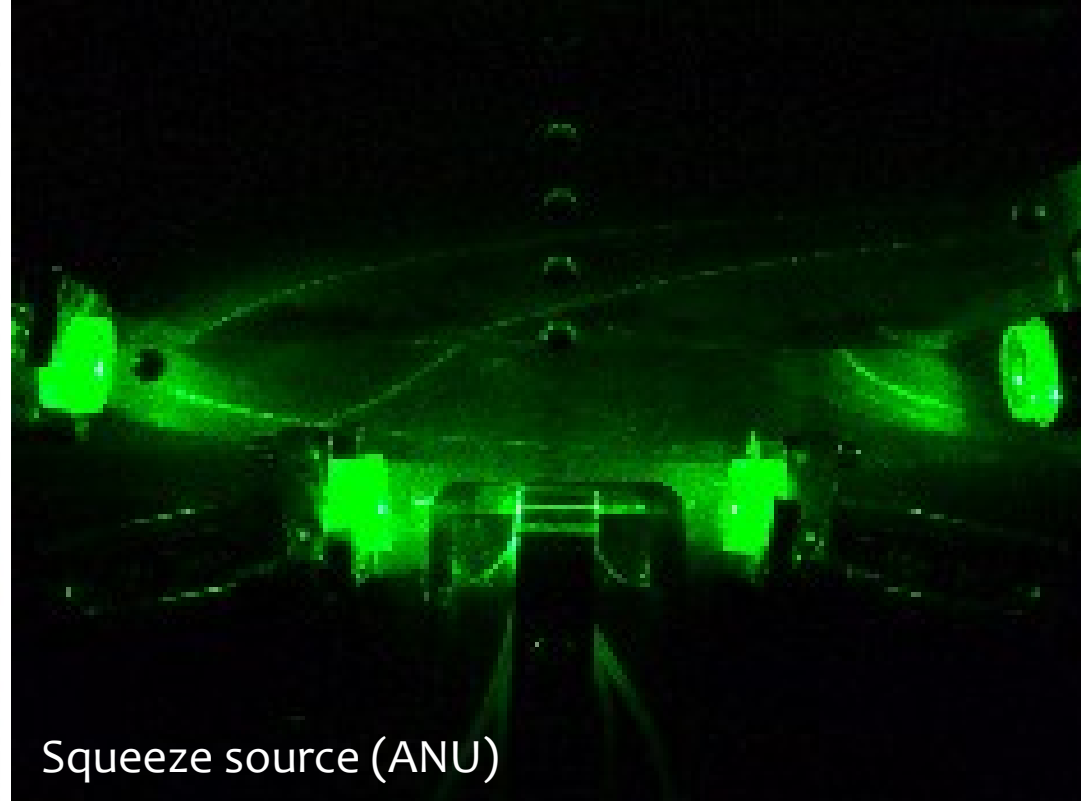
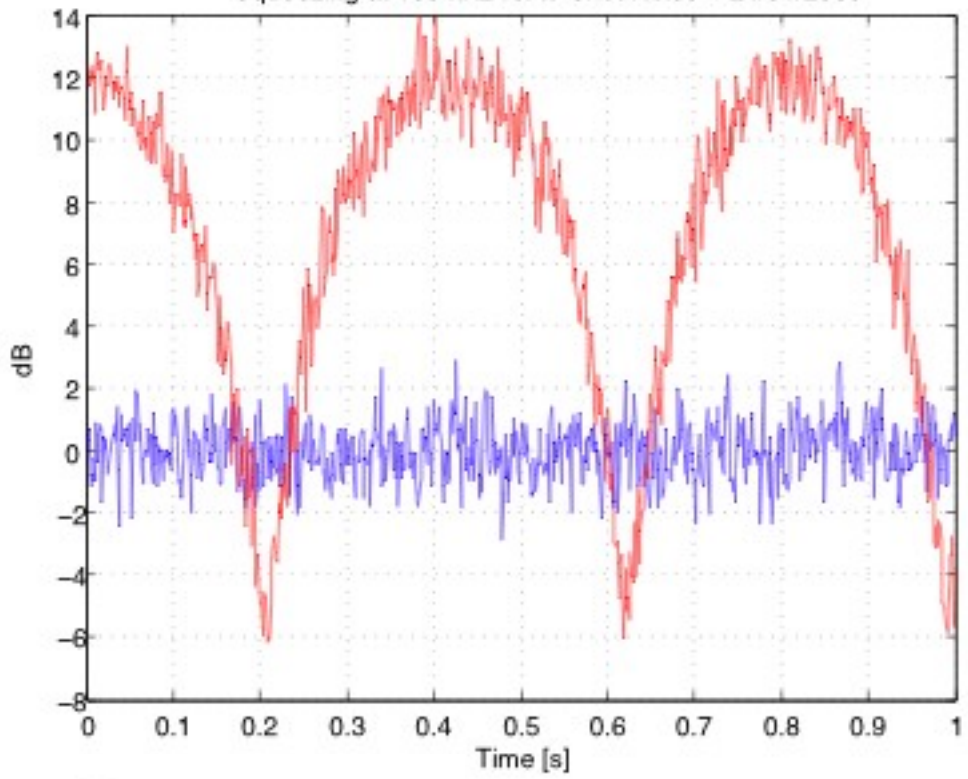

Squeeze source (ANU)

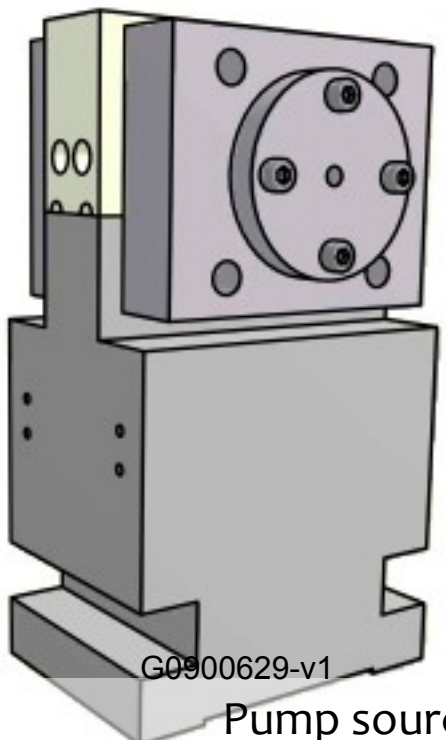

Pump source & homodyne detector (AEI)

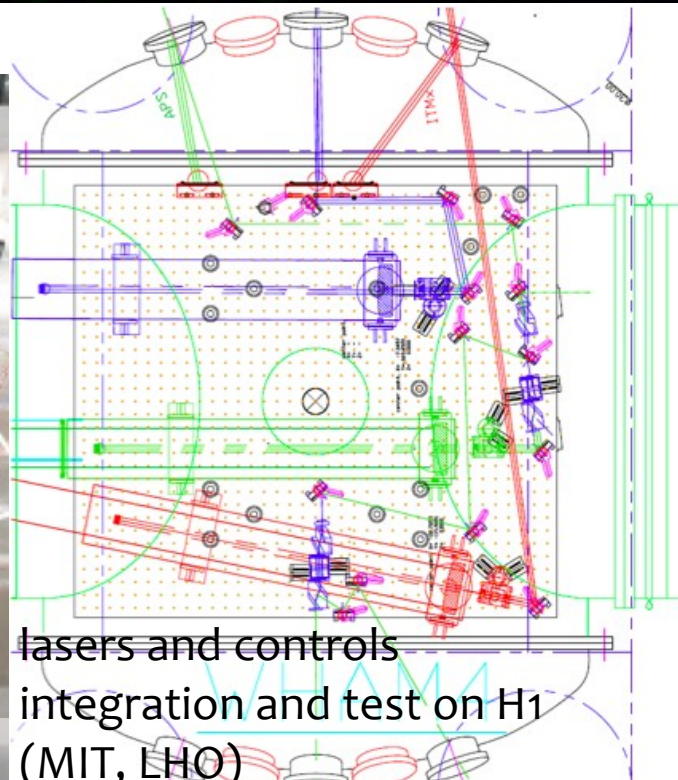
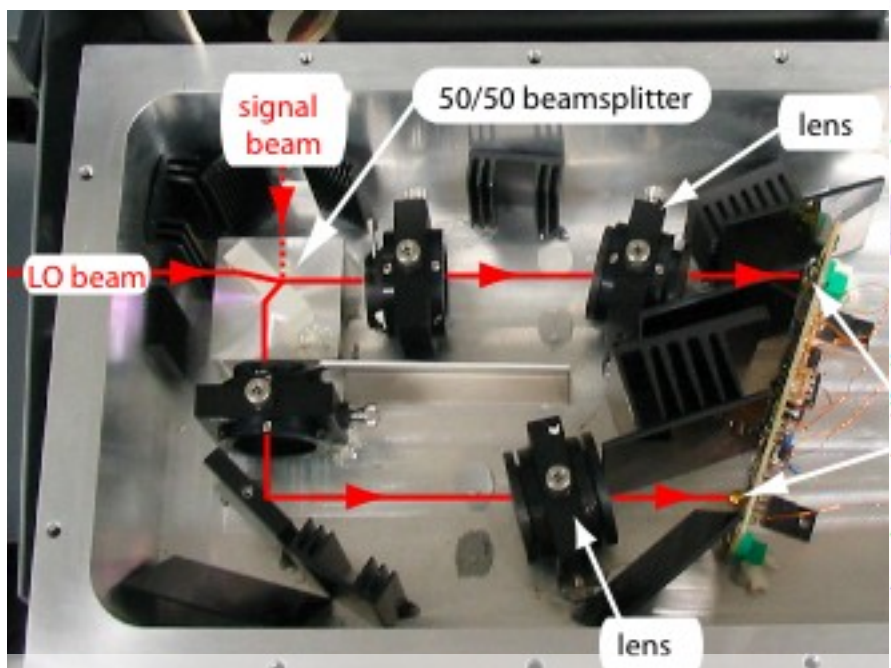

lasers and controls integration and test on H1 (MIT, LHO)

# Coming soon to a detector near you...

- First funds approved
- Laser, AEI SHG now being integrated at MIT
- OPO development ongoing at ANU
- Servo electronics (advLIGO prototypes) in progress at LHO
- No time to lose – we must be ready to go by 15 Feb 2011

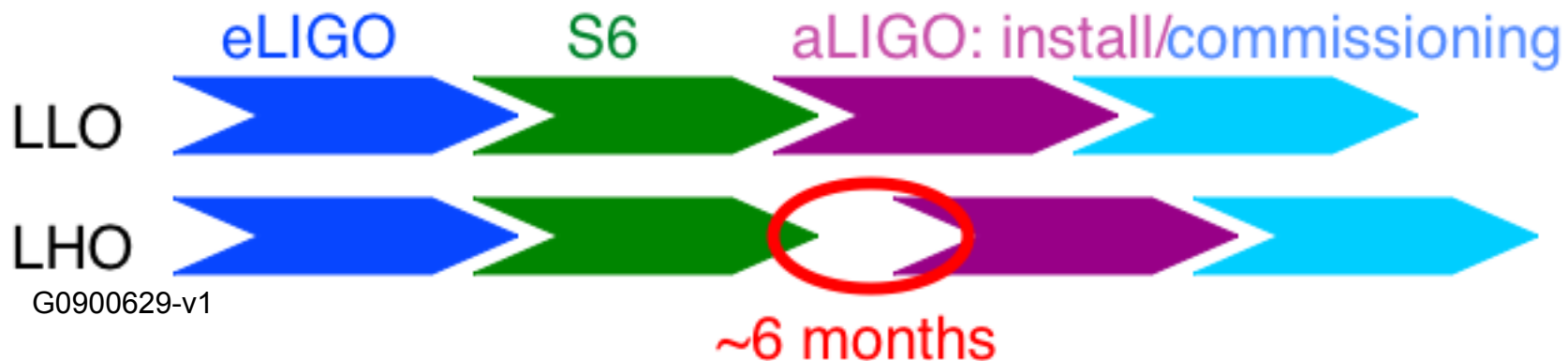

# Back-action machine

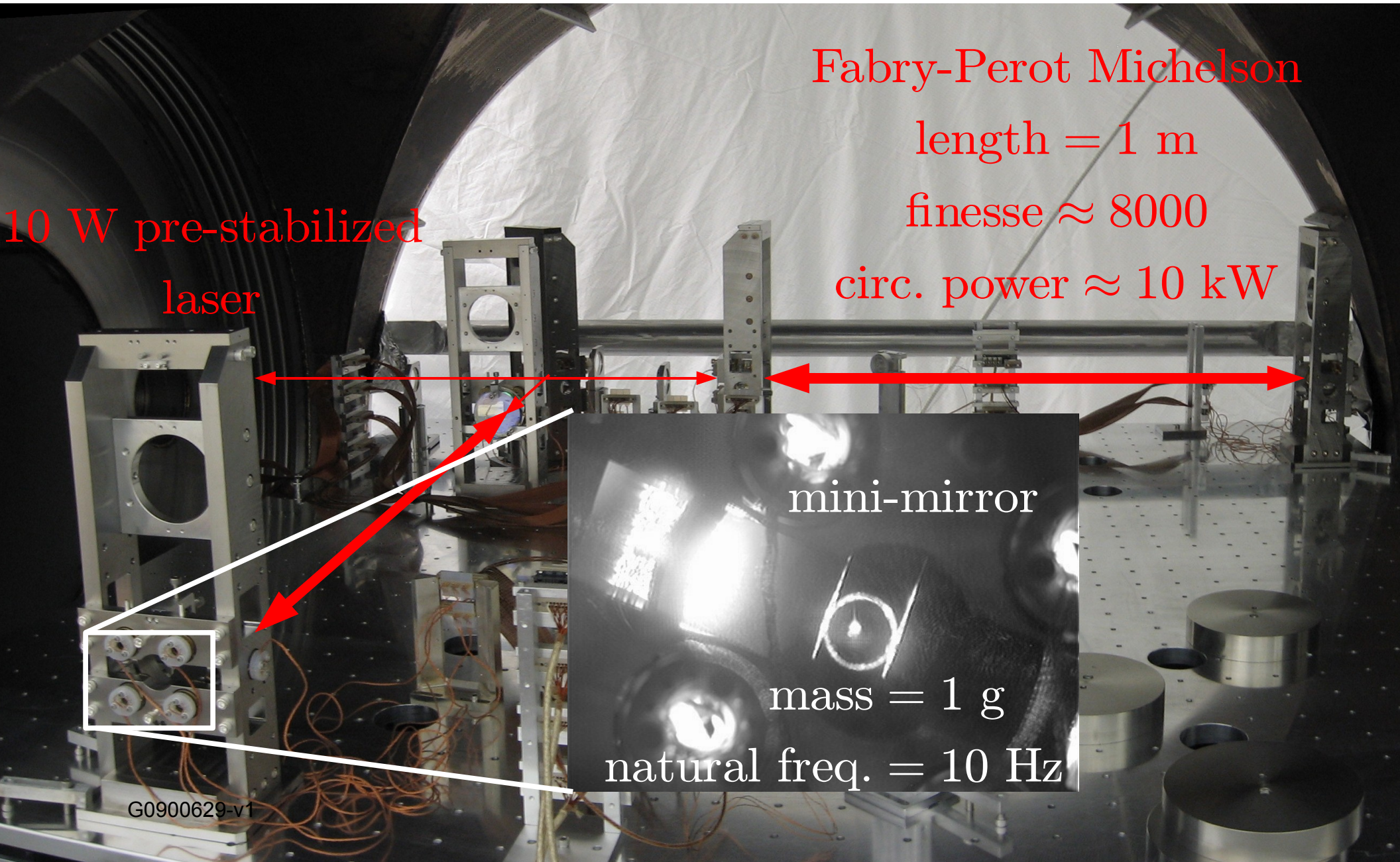

# Radiation pressure's dynamical effects

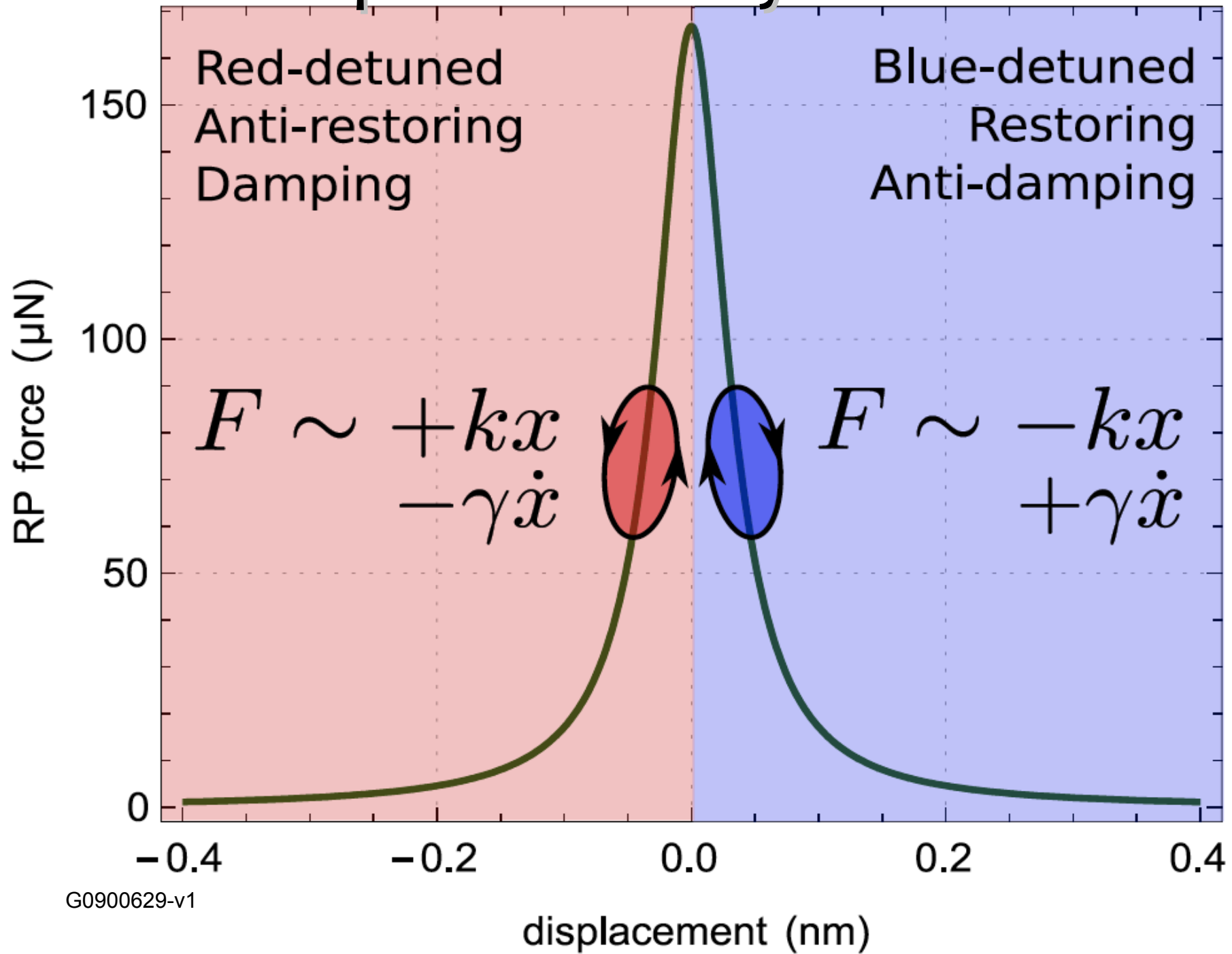

# Springing an optical trap

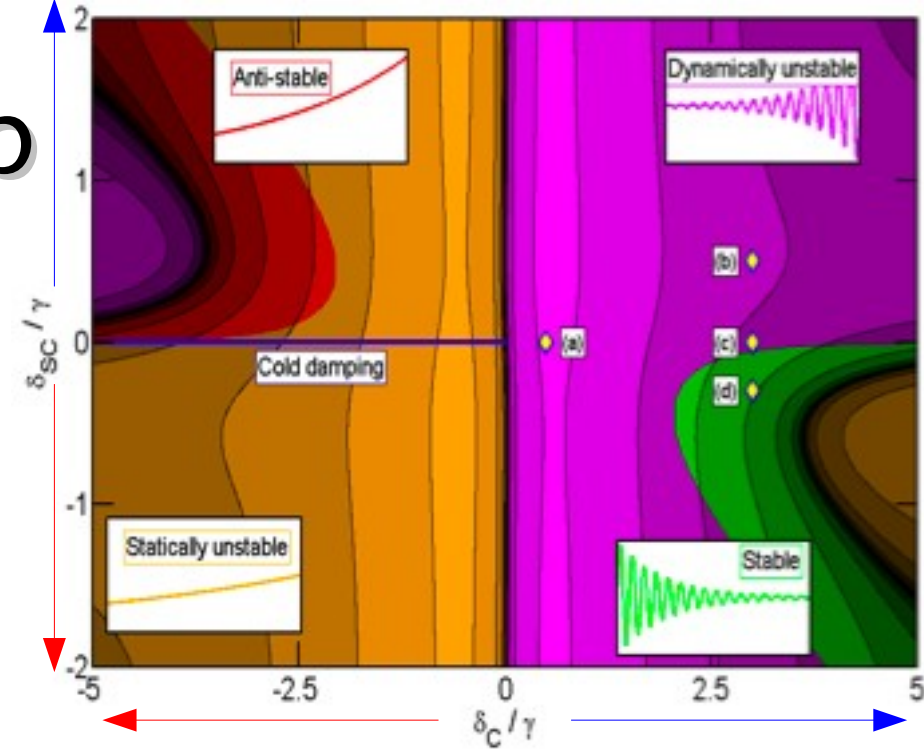
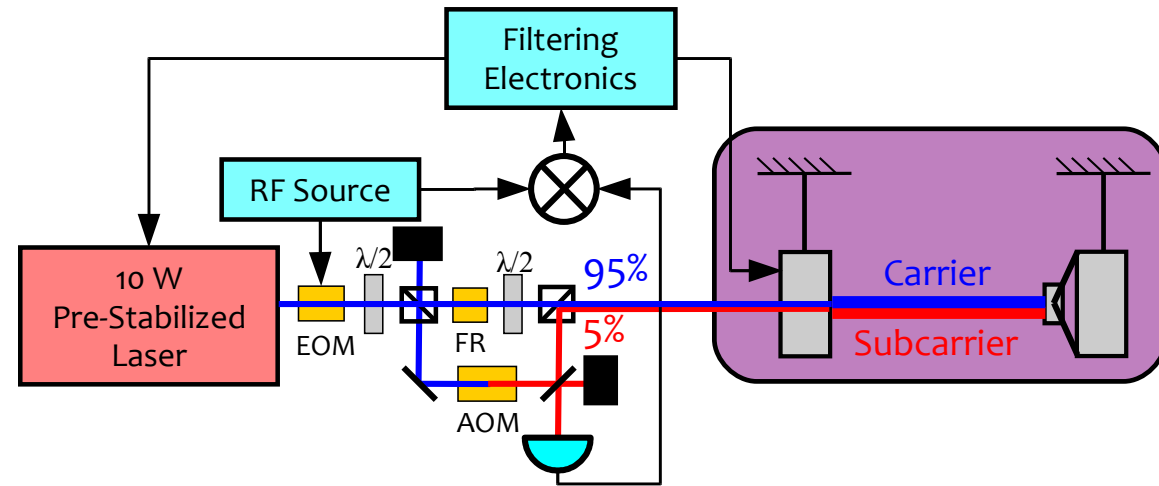

- Extreme optical rigidity
- Stable, self-locked system
- “Cold” optical forces dominate dynamics

$$S_F = 4k_B T \frac{\Gamma_{\text{mech}}}{M} \approx 4k_B T_{\text{eff}} \frac{\Gamma_{\text{opt}}}{M}$$

thermal occupation number  $N \sim \frac{k_B T_{\text{eff}}}{\hbar \Omega_{\text{eff}}}$

G0900629-v1

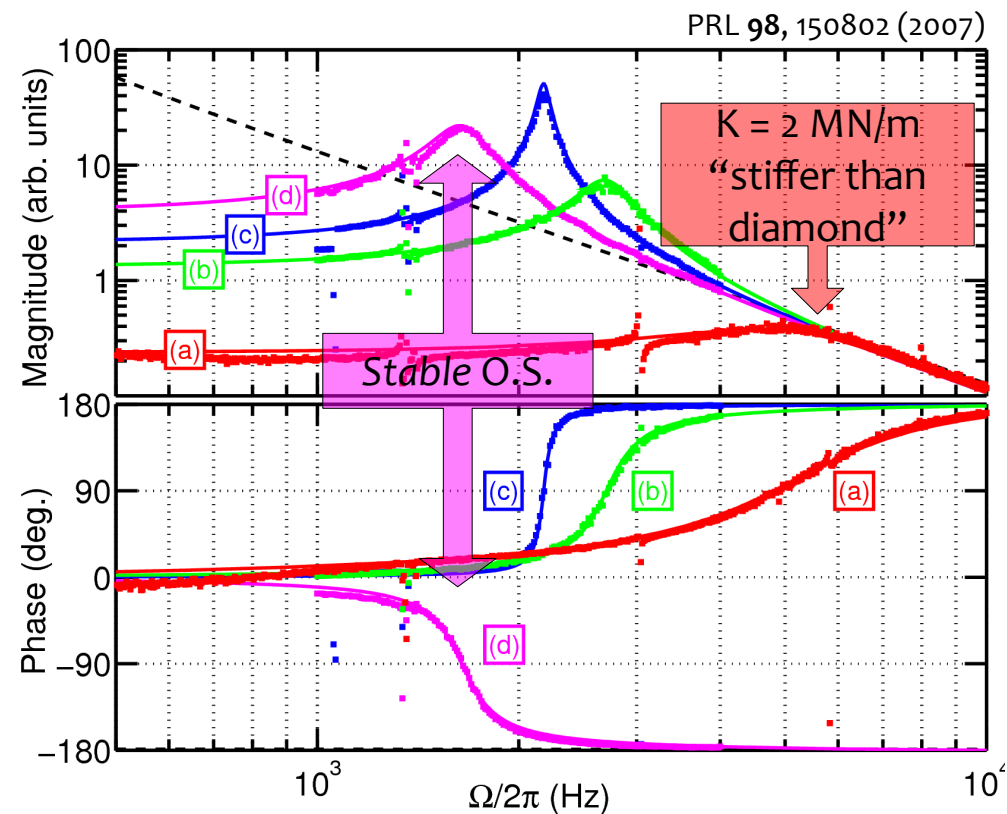

# Feedback cooling

We are here!

cavity "leakiness"

$$\frac{\gamma_c}{\Omega_{\text{eff}}} \ll 1$$

state remains pure  
strong self-cooling  
 $N \rightarrow 0$   
via self-cooling

$$\frac{\gamma_c}{\Omega_{\text{eff}}} \gg 1$$

weak self-cooling  
strong measurement  
 $N \rightarrow 0$   
via **feedback control**

Feedback forces can be "cold"  
when sensing noise is low!

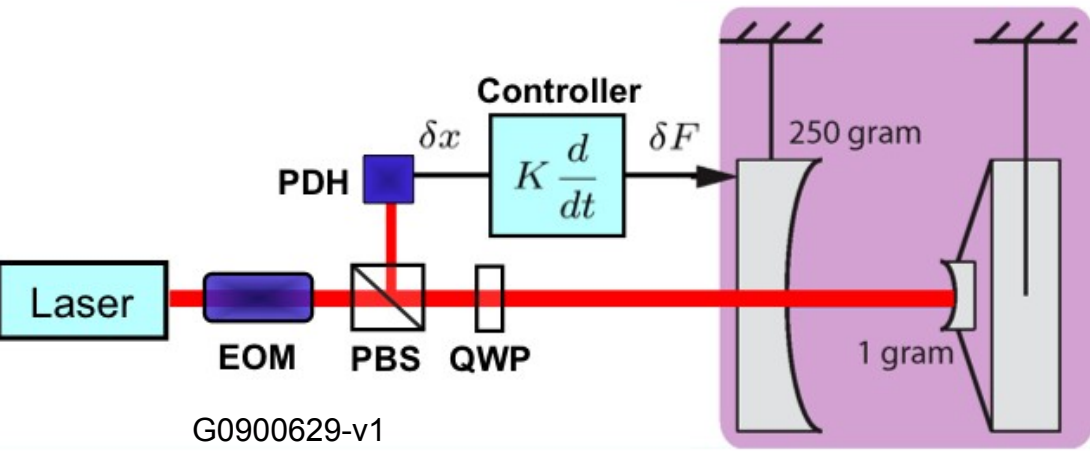

G0900629-v1

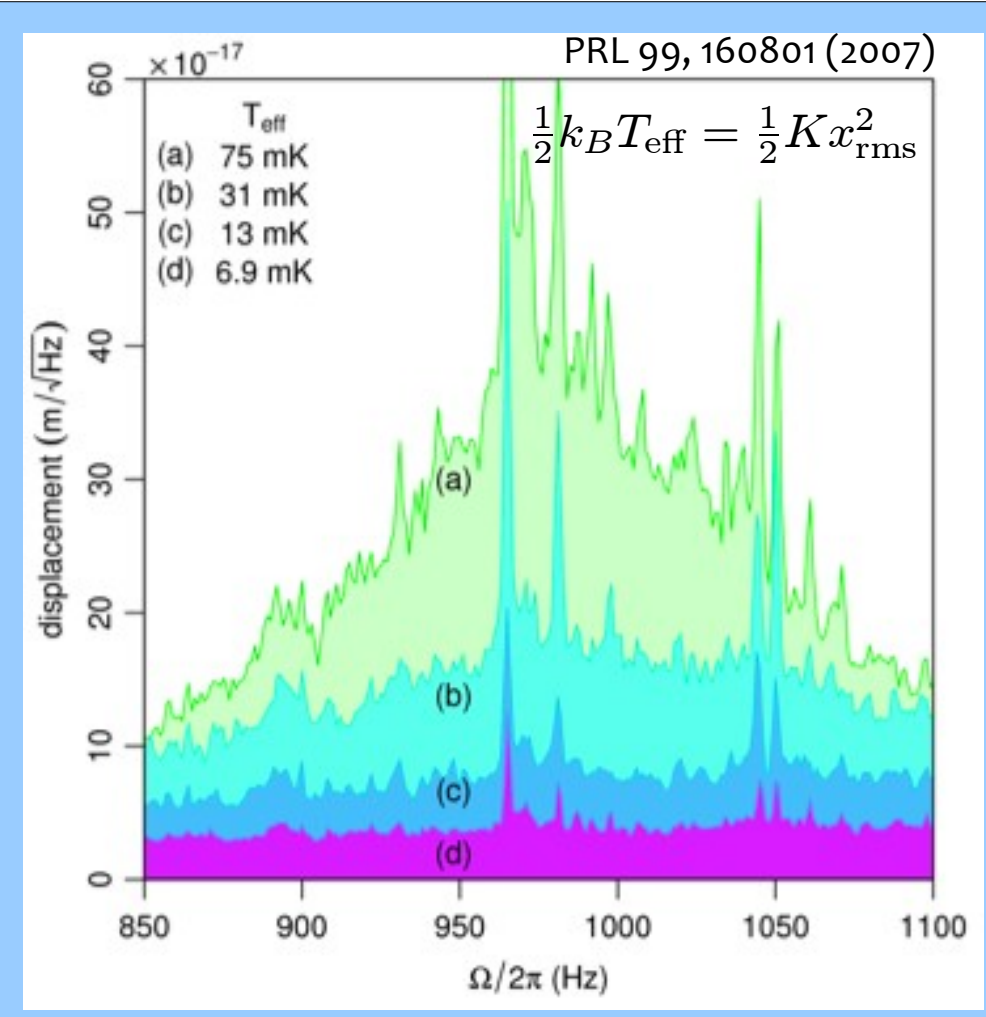

1 kHz OS stabilized, damped by feedback  
 $N = 10^5$  constrained by laser frequency noise!  
(ambient T)/(effective T) = 43 000  
Suspension Q = 20 000  
1<sup>st</sup> instance where "cooling factor" > natural Q

# Servo spring

- Initial LIGO post-S5
  - kg-scale masses ( $10^{26}$  atoms)
  - factor 10 above SQL
  - BUT strong radiation pressure forces are not available yet

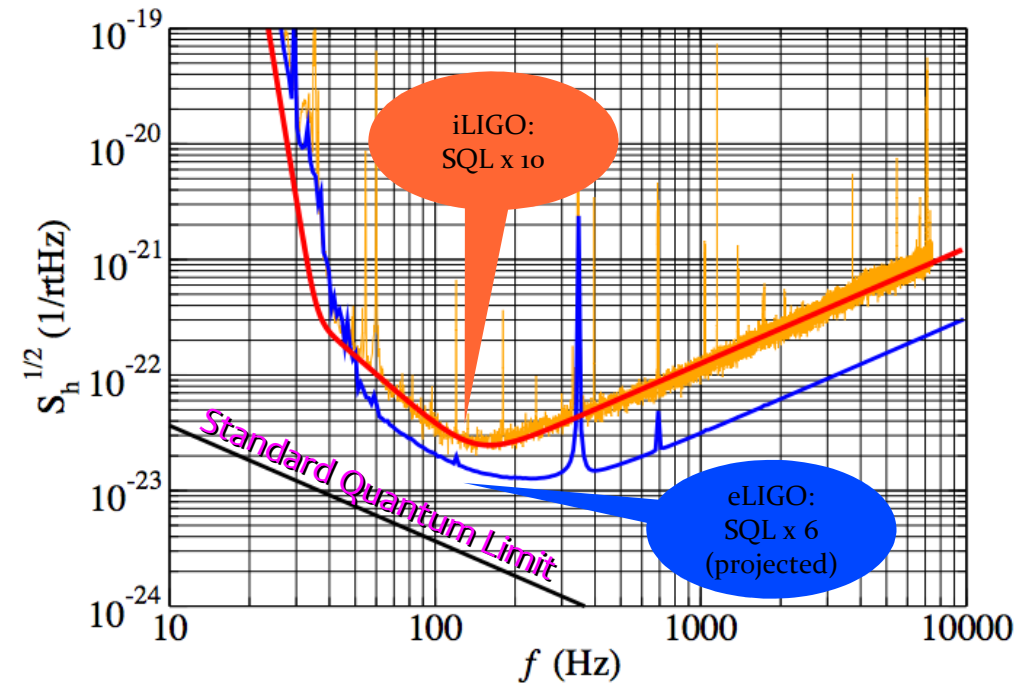
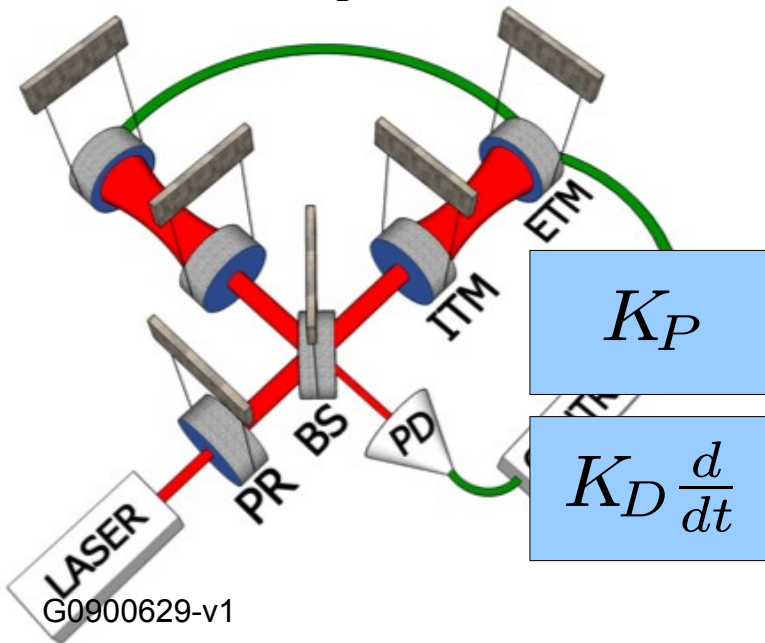

# Feedback cooling and the SQL

The optimal control strategy shifts the mechanical mode to the nearest approach to the SQL, and damps it.

$$N_{\text{opt}} = \frac{k_B T_{\text{eff}}}{\hbar \Omega_{\text{eff}}} \approx \frac{S_x(\Omega_{\text{eff}})}{S_{\text{SQL}}(\Omega_{\text{eff}})} \frac{Q_{\text{eff}}}{2} \quad [\text{Danilishin et al., submitted to PRL}]$$

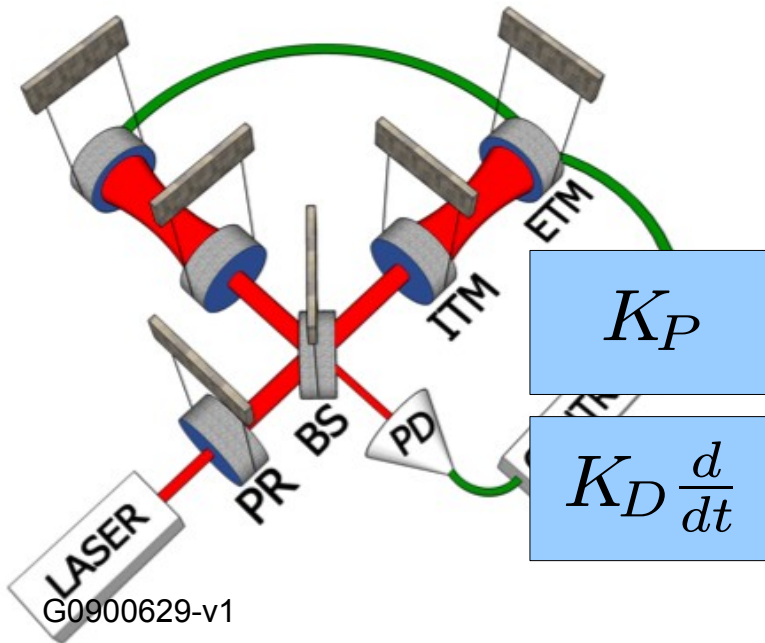

G0900629-v1

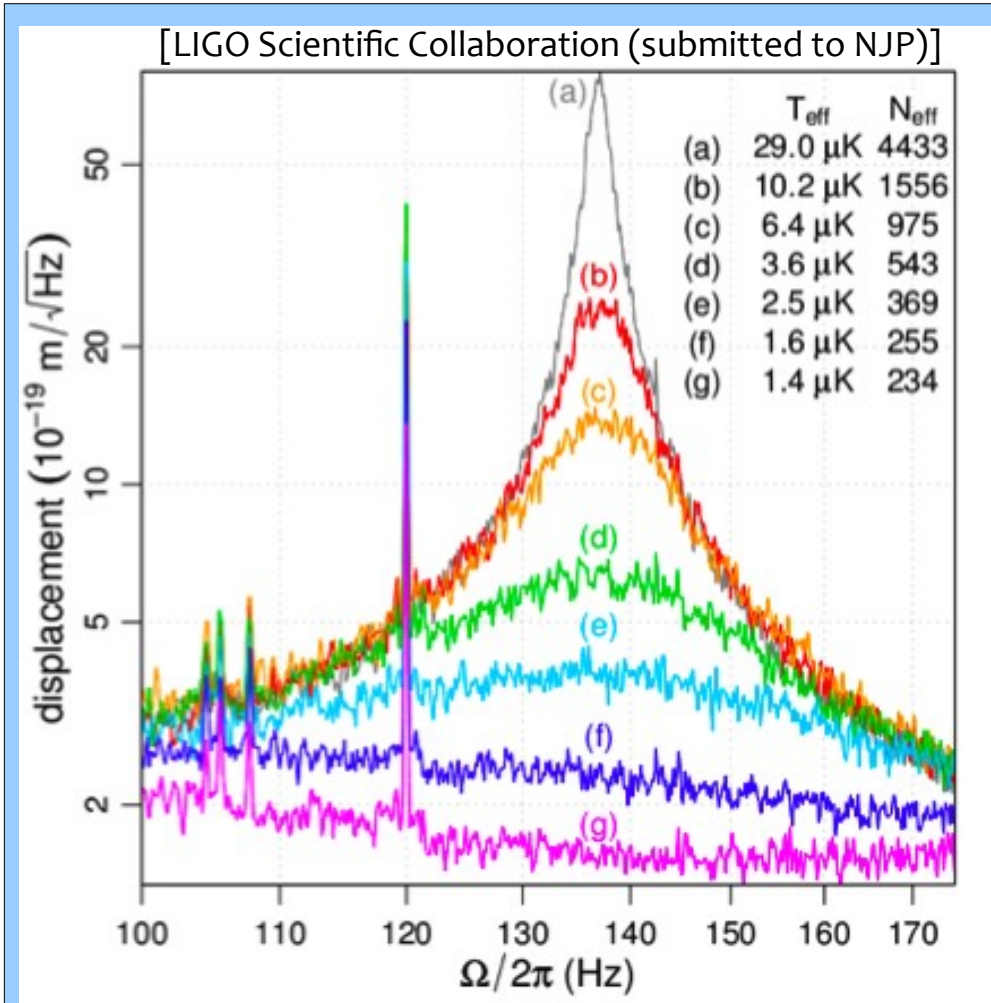

140 Hz EOS formed, damped by feedback

$N = 234$  - limited mainly by shot noise

(ambient T)/(effective T) =  $2 \times 10^8$

Displacement is estimated pessimistically since some noise sources are unknown



# Photo finish

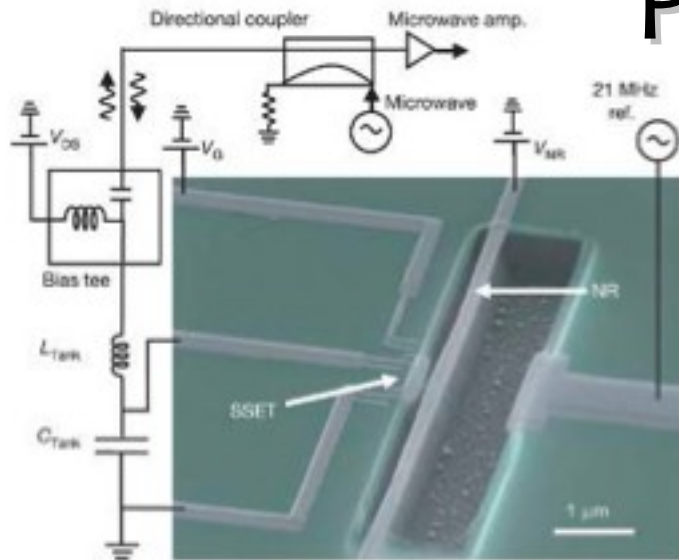

NEMS

$M \sim$  picogram,  $\Omega/2\pi \sim$  MHz  
Naik et al., Nature (2006)



SiN micro-membrane

$M \sim$  10 picogram,  $\Omega/2\pi \sim$  100 kHz  
Thompson et al., Nature (2008)

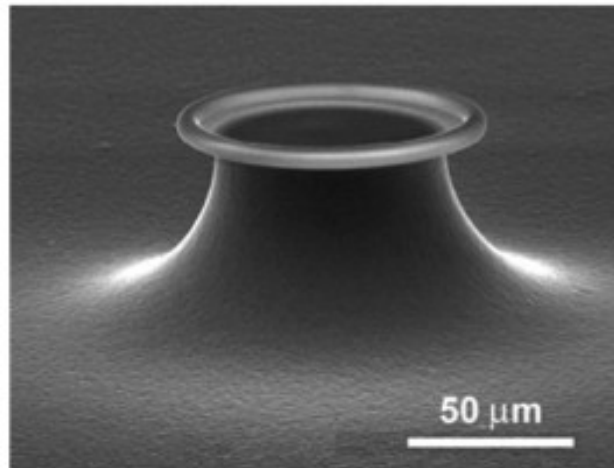

Micro-toroid cavity

$M \sim$  10 nanogram,  $\Omega/2\pi \sim$  50 MHz  
Schliesser et al., PRL (2006)

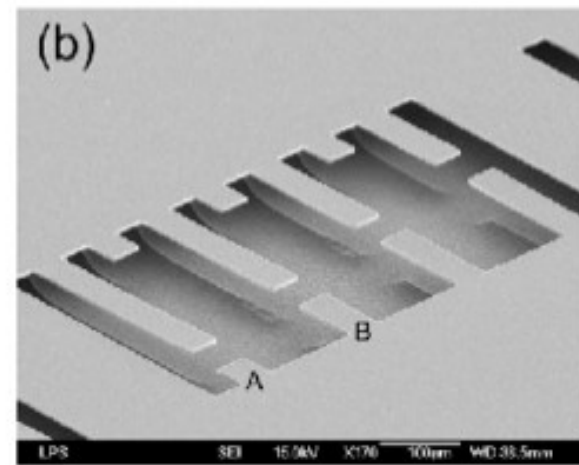

Micro-mirror

$M \sim$  100 nanogram,  $\Omega/2\pi \sim$  MHz  
Gröblacher et al., arXiv (2007)

# Progress toward back-action

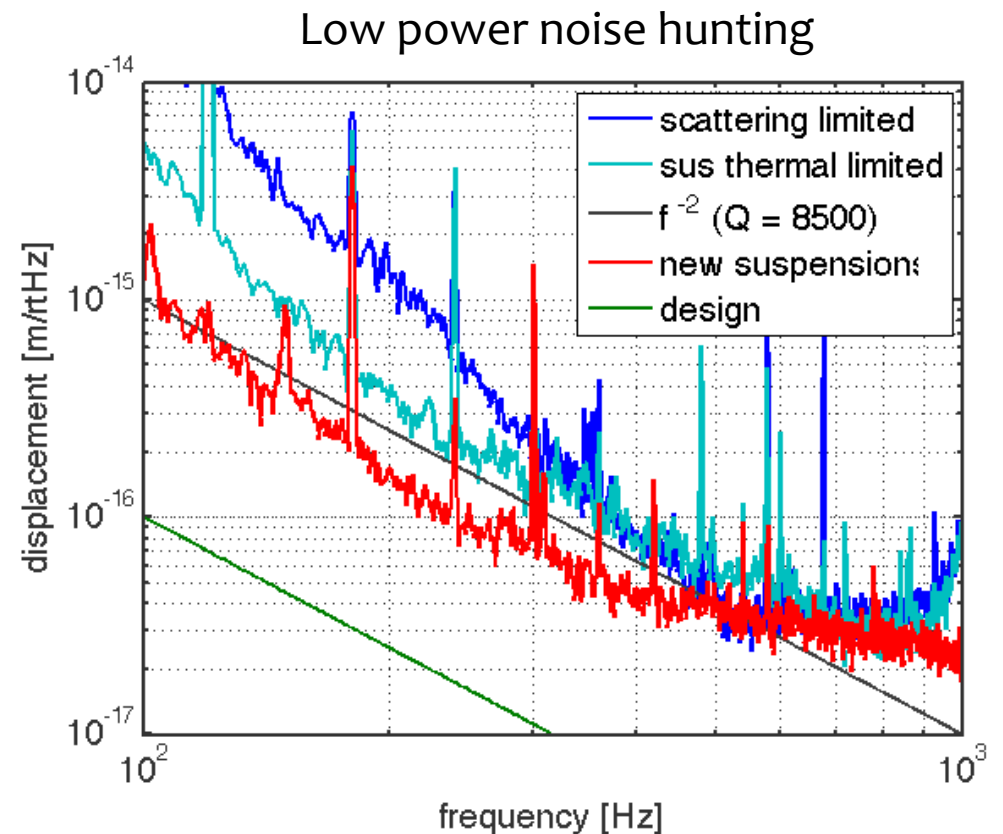
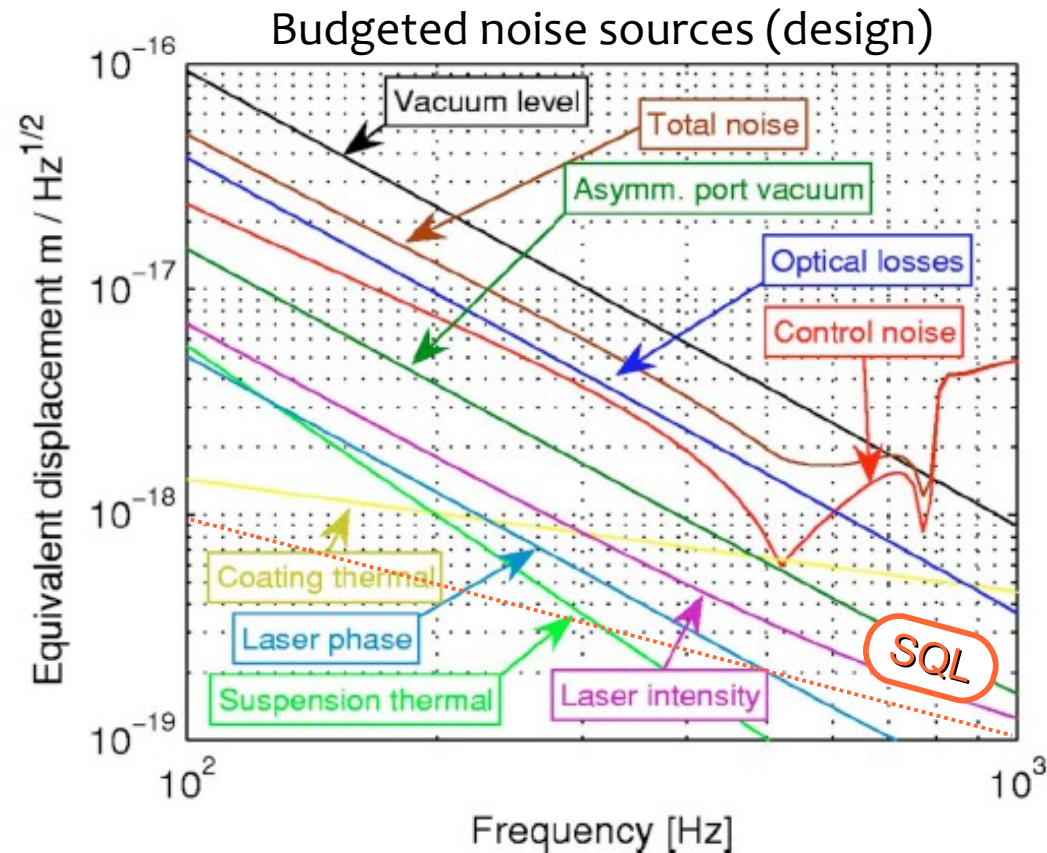

We presently operate about a factor of 5 above the back-action goal.  
 Scattering noise looms large in the detuned configuration  
 (where the displacement signal is suppressed by the optical spring).

The mini-mirror suspension thermal noise has been remediated.

# Suspension upgrades

Then

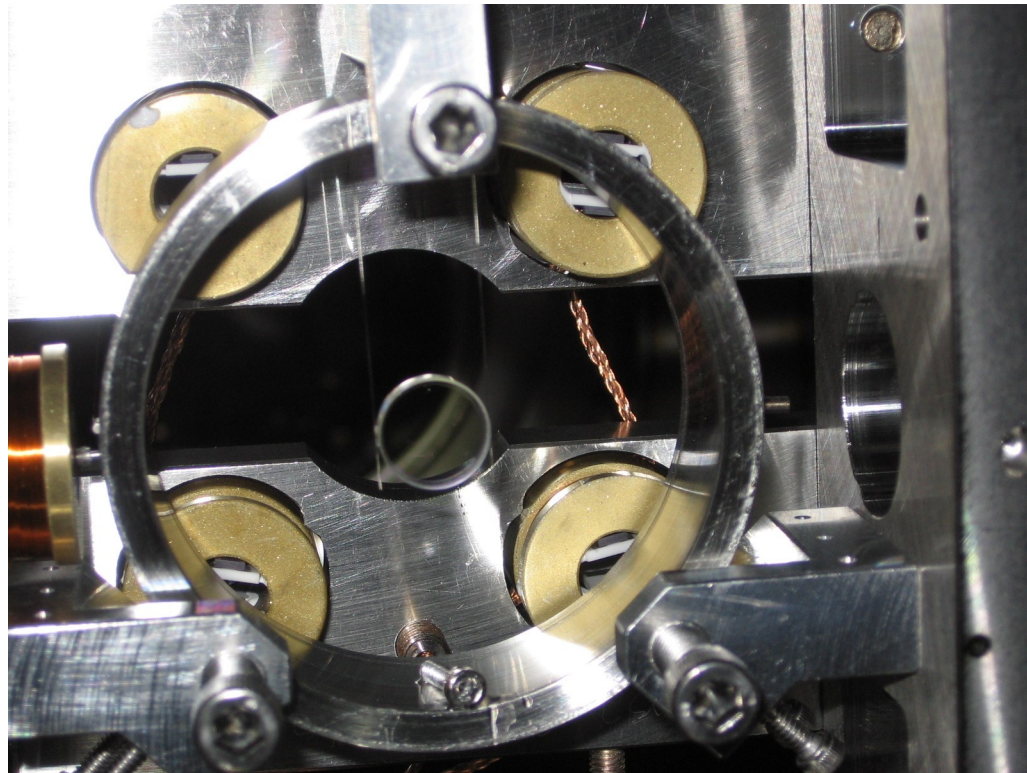

6 Hz natural frequency, quality factor  $\sim 10000$  ?  
Stainless steel, glass, and Vacseal adhesive  
Commercial optical fiber (cladding scraped off)

Now

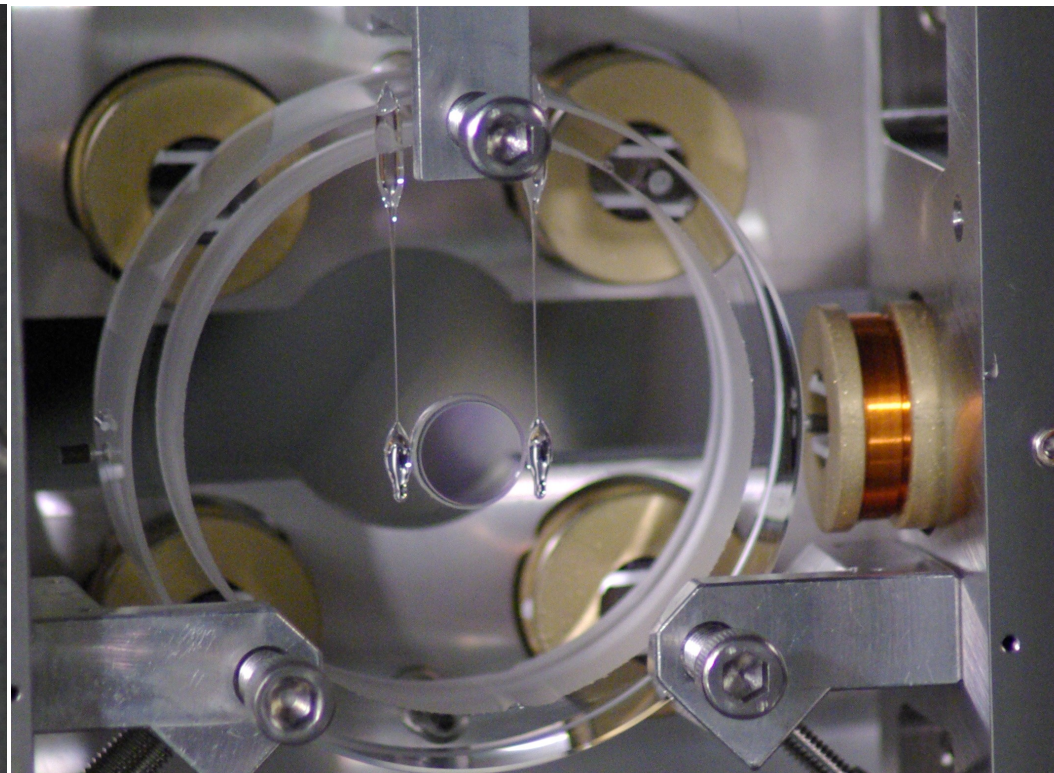

All glass -- still bonded with Vacseal  
Custom-tapered fibers (courtesy of advLIGO)  
Much refinement in fabrication and handling

Point scatterers on ETMs needed cleanup → ongoing vent to drag-wipe mini-mirrors in situ

# Ring, Ring, Ring, Ring...

ETMY ringdown measurement

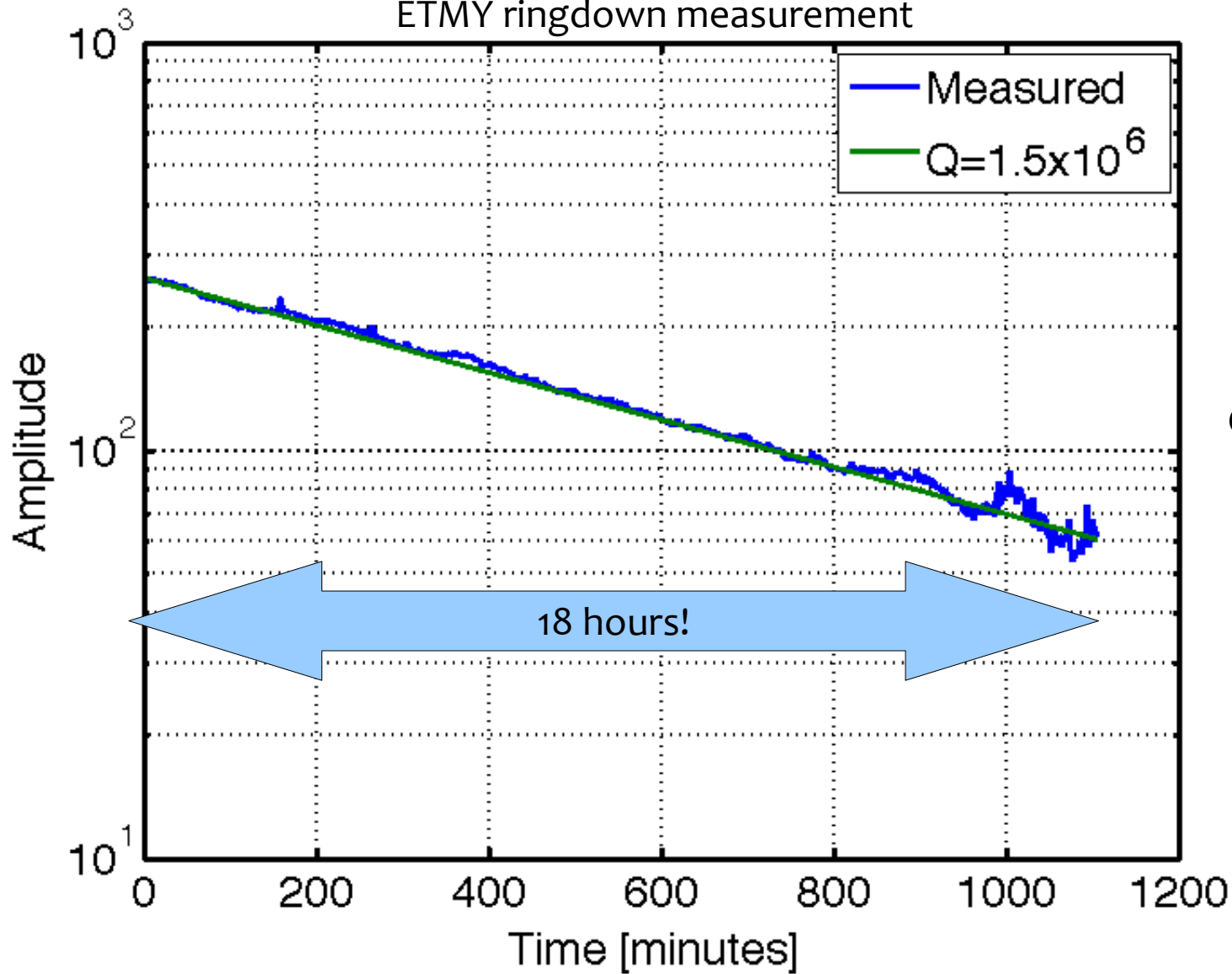

10 Hz natural frequency

Q surpasses requirement to observe quantum noise

Pitch, Yaw Qs all  $>10^5$

# Entering the quantum RP regime

- First goal: verification of back-action noise
  - Power dependence (a weak signature)
  - Inject a squeezed state to manipulate it
  - 40m squeezer is being reconstituted for this purpose
- Ponderomotively squeezed light
  - amplitude fluctuations drive mirror motion, which then imprints on the phase
  - detuned operation makes broadband squeezing below the OS frequency

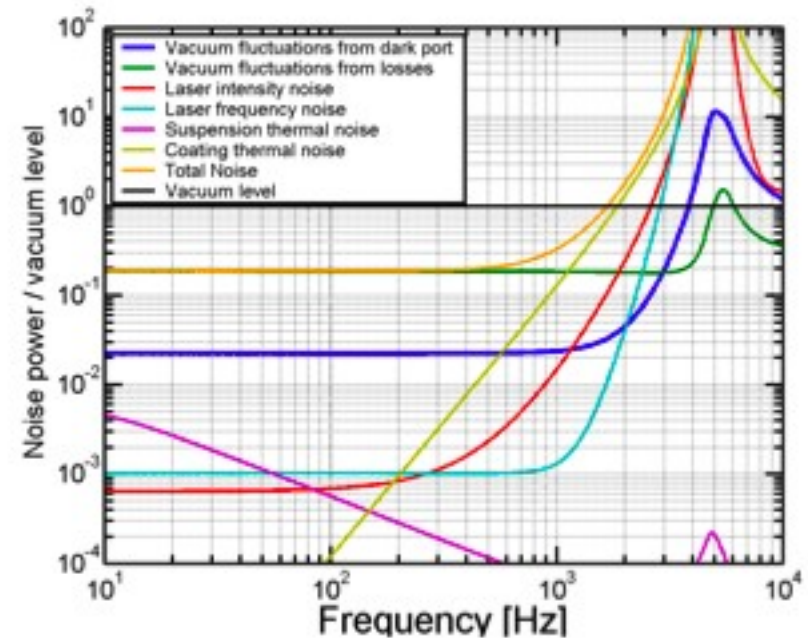

# Quadrature entanglement

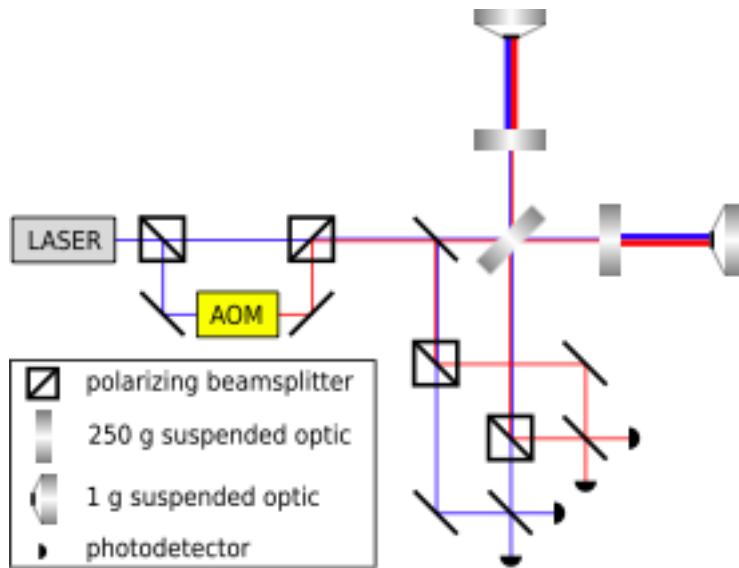

- Can form robust entanglement between carrier and subcarrier
  - joint squeezing of the two fields
- Exploits advantages of the optical trap configuration
  - high-power stability permits strong coupling via the mirror
  - optical entanglement is not overly sensitive to the mirror state
  - possibility to entangle optical fields of disparate wavelengths

[Wipf et al., New J. Phys 10 095017 (2008)]

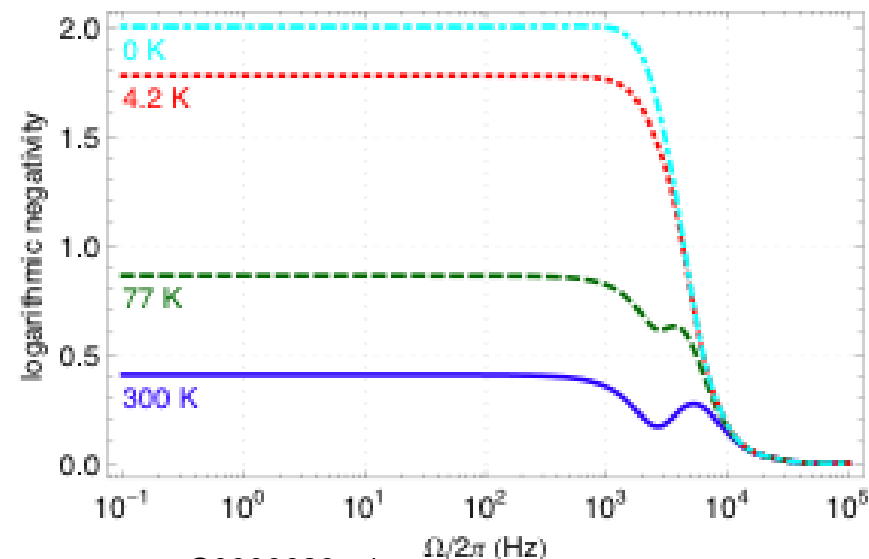

G0900629-v1

GWADW

# Summary

- Squeezers prepare for a test in LIGO, GEO
  - demonstrate readiness to manipulate quantum noise in advanced detectors
- Back-action regime is nearly upon us
  - rich dynamics – stiff optical springs and trapping
  - should yield observations of quantum radiation pressure, squeezing, and entanglement
- Quantum opportunity knocks
  - the SQL opens the door to ground state cooling and *very* macroscopic quantum objects

# Closing credits

- Tim Bodiya, Thomas Corbitt, Sheila Dwyer, Daniel Sigg, Nic Smith, Stan Whitcomb, Nergis Mavalvala (LIGO-MIT Quantum Measurement group)
- Rolf Bork, Alex Ivanov, Jay Heefner, Caltech 40m, many other LIGO Lab members
- Yanbei Chen and the MQM discussion group
- Fellow Squeezers at AEI and ANU