

REV.	DATE	DCN #	DRAWING TREE #
v6	09 MAY 2013	E1300364-x0	
v7	30 SEP 2013	E1300716-x0	

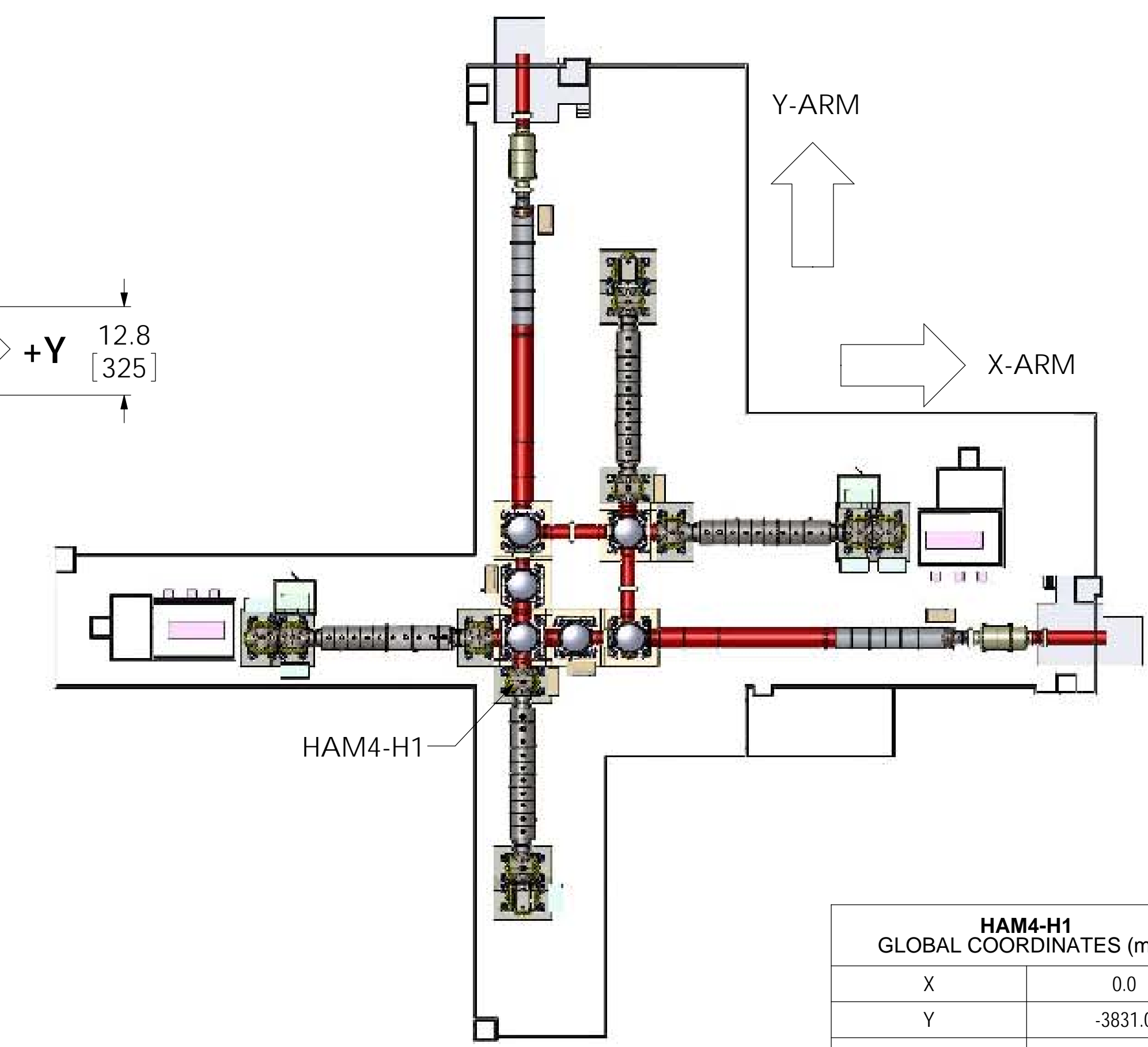

HAM4-H1 GLOBAL COORDINATES (mm)	
X	0.0
Y	-3831.0
Z	0.0

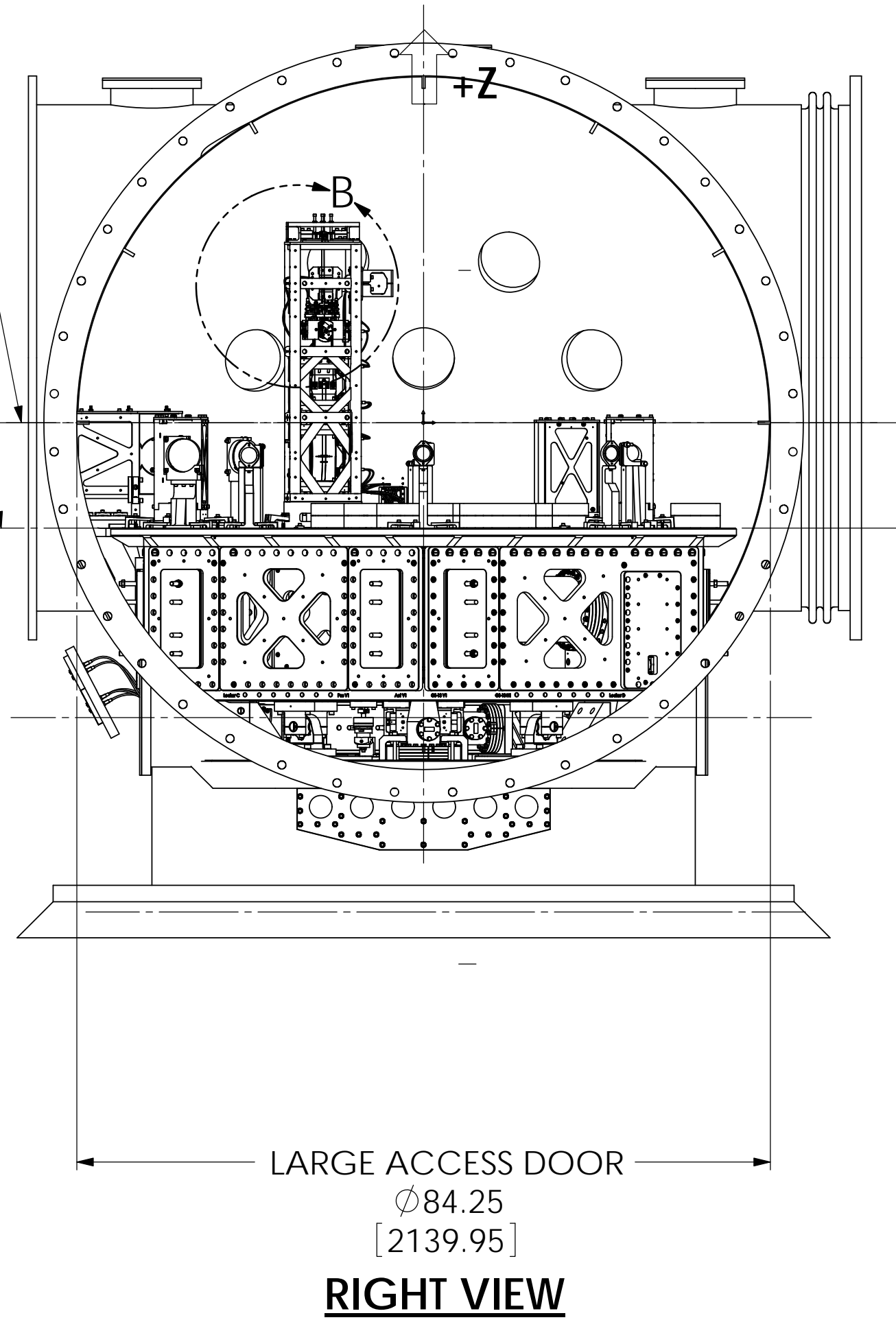
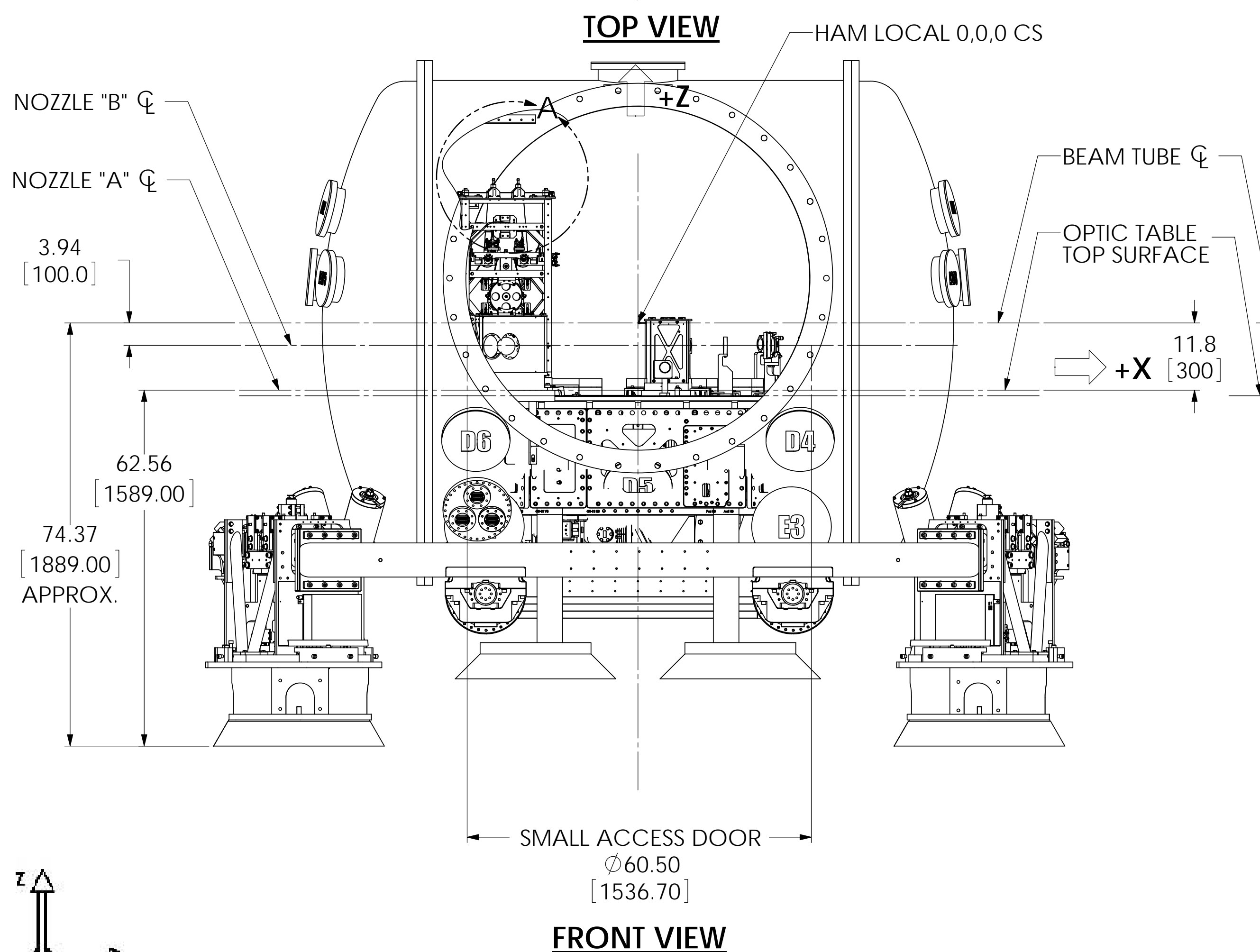
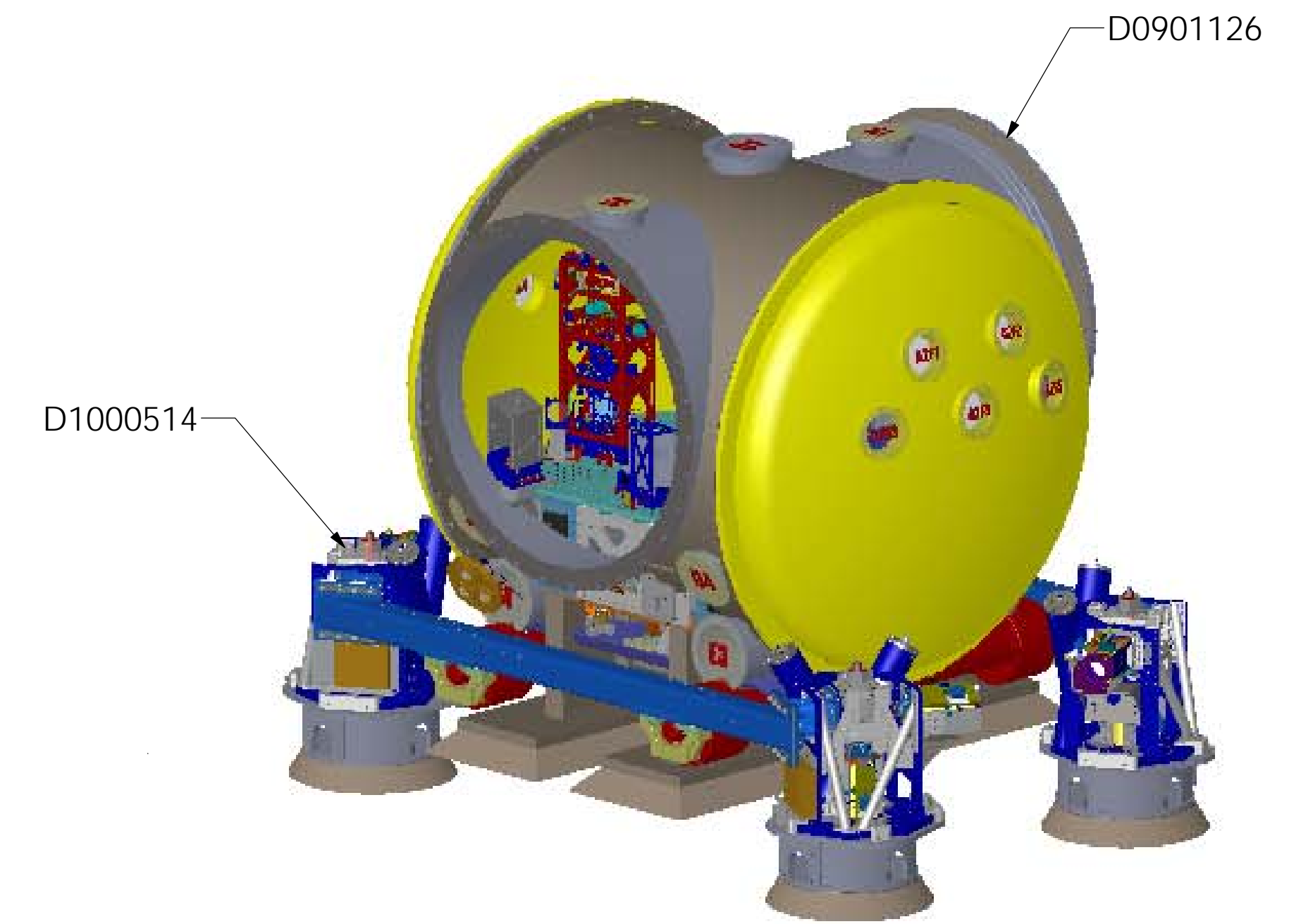
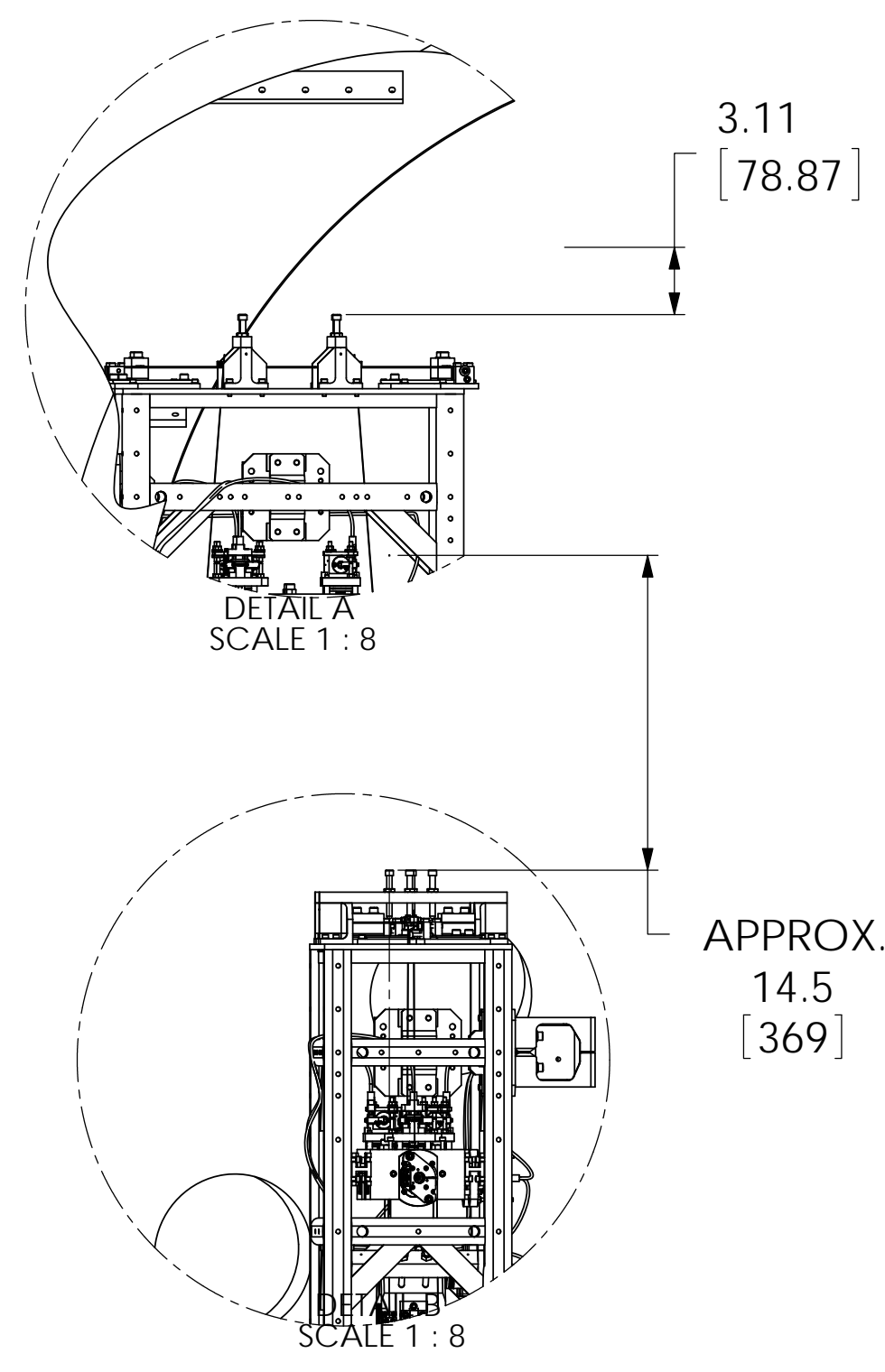
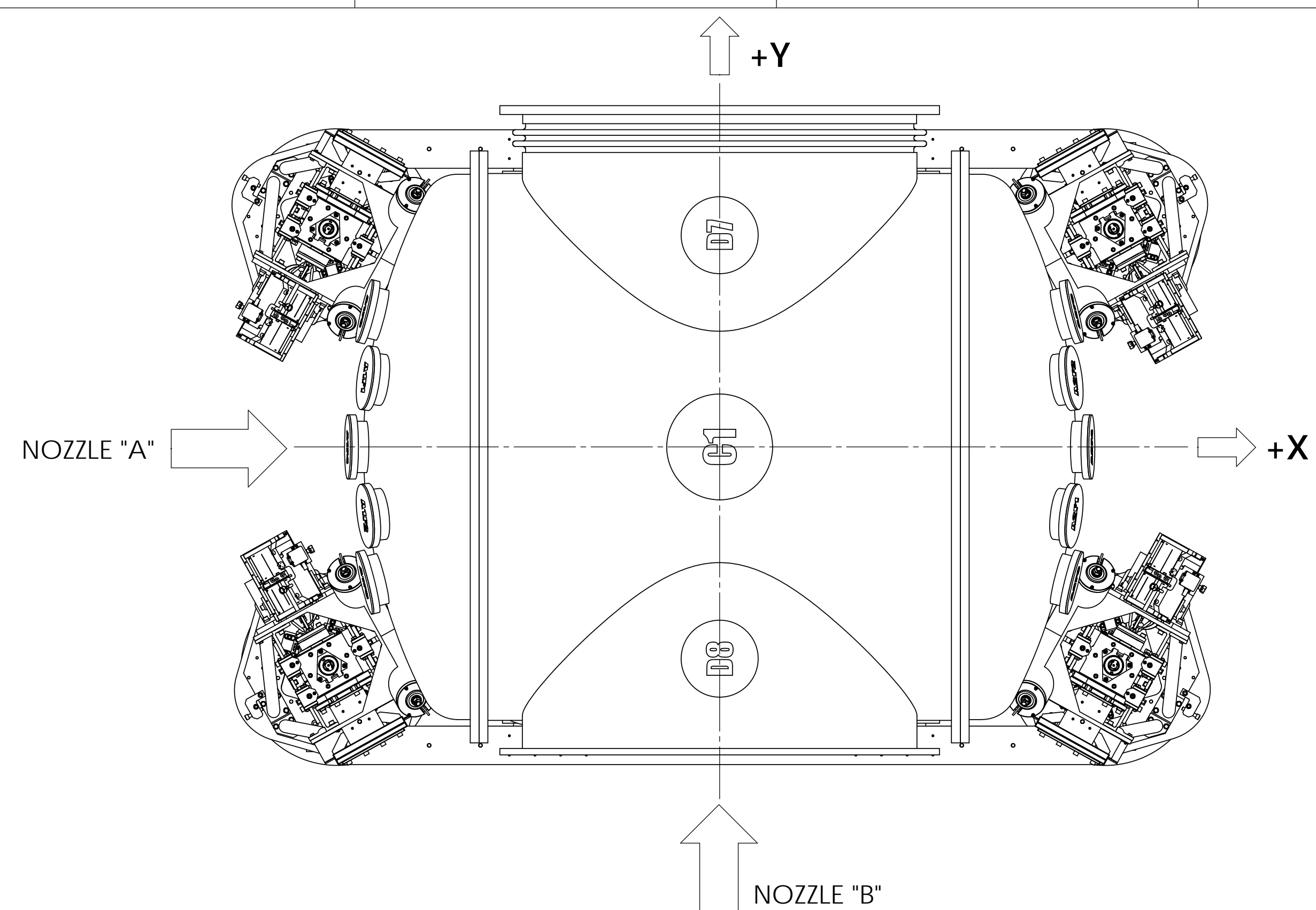
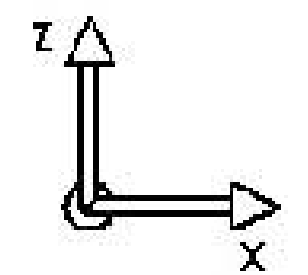

NOTES AND TOLERANCES: (UNLESS OTHERWISE SPECIFIED)

MATERIAL	FINISH	NEXT ASSY
N/A	N/A μinch	N/A

LIGO CALIFORNIA INSTITUTE OF TECHNOLOGY MASSACHUSETTS INSTITUTE OF TECHNOLOGY		PART NAME		SIZE		DWG. NO.		REV.	
ADVANCED LIGO		SUS		D		D0901125		v7	
DESIGNER		E.SANCHEZ		03 OCT 2012		SCALE: 1:16		PROJECTION:	
DRAFTER		SEE DCC		SEE DCC		SHEET 1 OF 4			
CHECKER		SEE DCC		SEE DCC					
APPROVAL		SEE DCC		SEE DCC					

D0901125-AdvLIGO Systems, HAM4-H1 Top Level Chamber Assembly, ALL PART PDM REV. X-046, DRAWING PDM REV. X-012

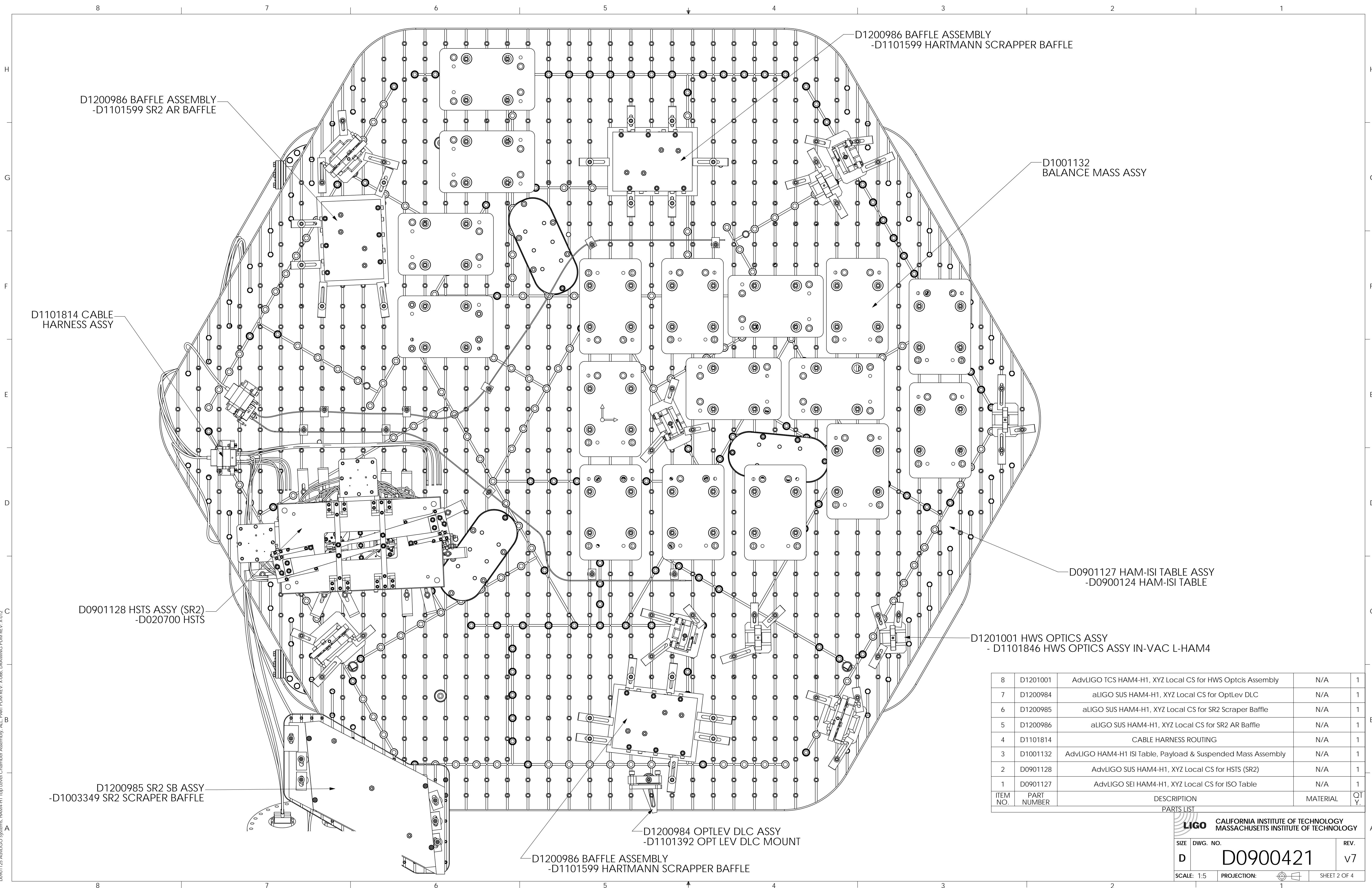

ITEM NO.	PART NUMBER	DESCRIPTION	MATERIAL	QTY.
8	D1201001	AdvLIGO TCS HAM4-H1, XYZ Local CS for HWS Optcis Assembly	N/A	1
7	D1200984	aLIGO SUS HAM4-H1, XYZ Local CS for OptLev DLC	N/A	1
6	D1200985	aLIGO SUS HAM4-H1, XYZ Local CS for SR2 Scraper Baffle	N/A	1
5	D1200986	aLIGO SUS HAM4-H1, XYZ Local CS for SR2 AR Baffle	N/A	1
4	D1101814	CABLE HARNESS ROUTING	N/A	1
3	D1001132	AdvLIGO HAM4-H1 ISI Table, Payload & Suspended Mass Assembly	N/A	1
2	D0901128	AdvLIGO SUS HAM4-H1, XYZ Local CS for HSTS (SR2)	N/A	1
1	D0901127	AdvLIGO SEI HAM4-H1, XYZ Local CS for ISO Table	N/A	1



**CALIFORNIA INSTITUTE OF TECHNOLOGY**  
**MASSACHUSETTS INSTITUTE OF TECHNOLOGY**

SIZE	DWG. NO.	REV.
D	D0900421	v7
SCALE: 1:5	PROJECTION:	SHEET 2 OF 4

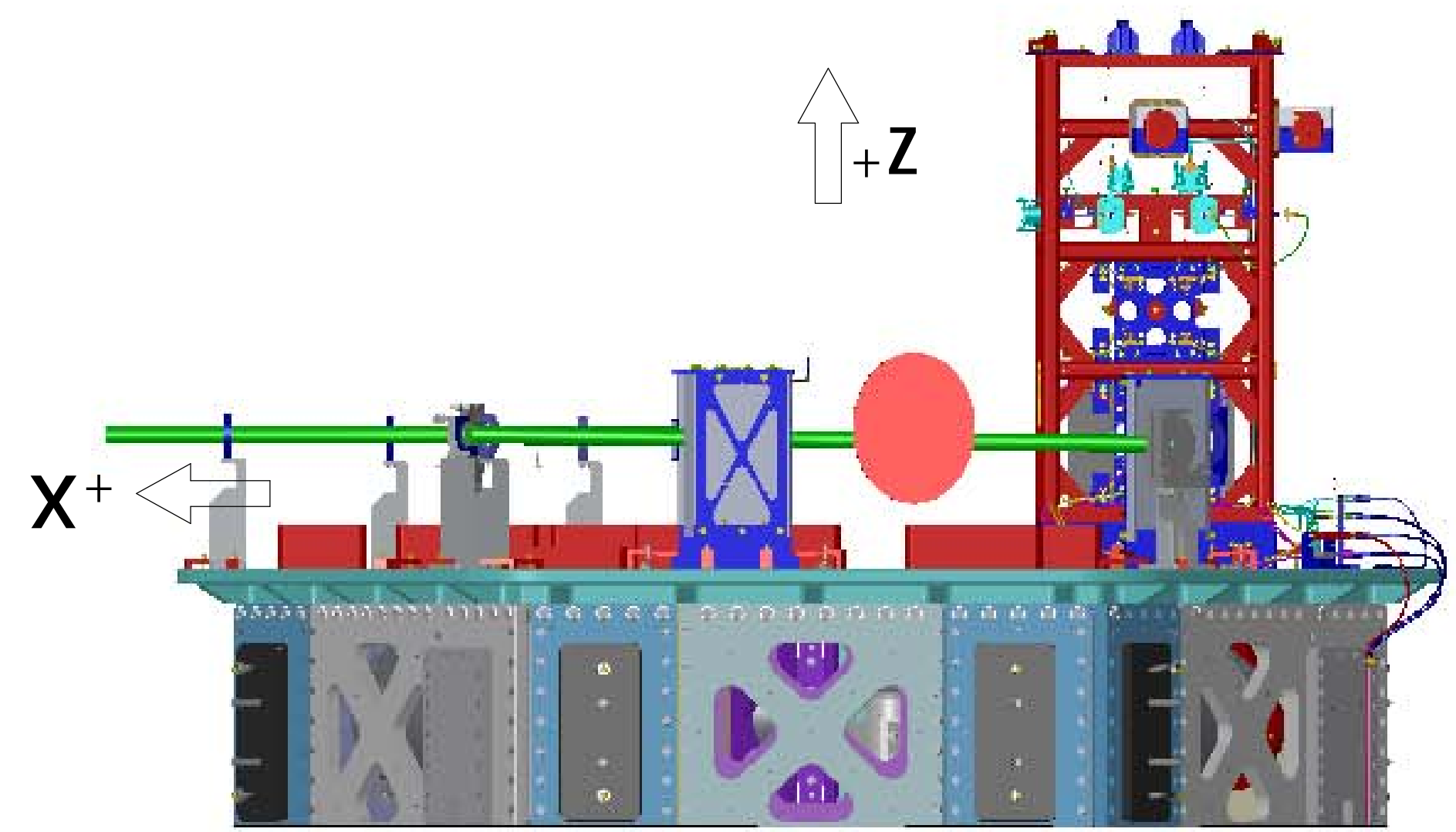
D0901127 AdvLIGO Systems: HAM4-H1 Top Level Chamber Assembly, ALL PART PDM REV. X-06, DRAWING PDM REV. X-012

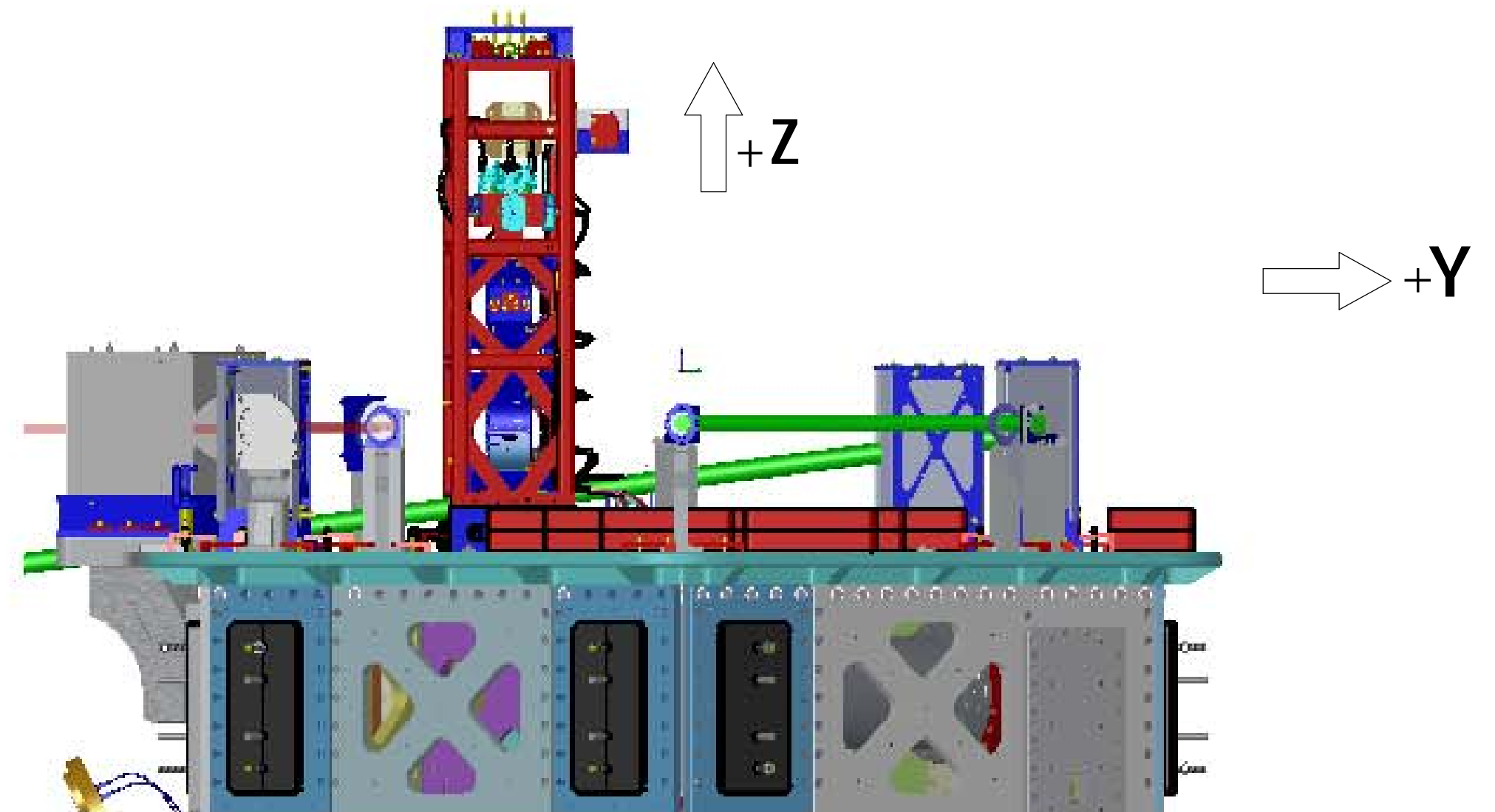

REAR VIEW  
(ROTATED 180 DEGREES CCW)



RIGHT SIDE VIEW  
(ROTATED 90 DEGREES CW)

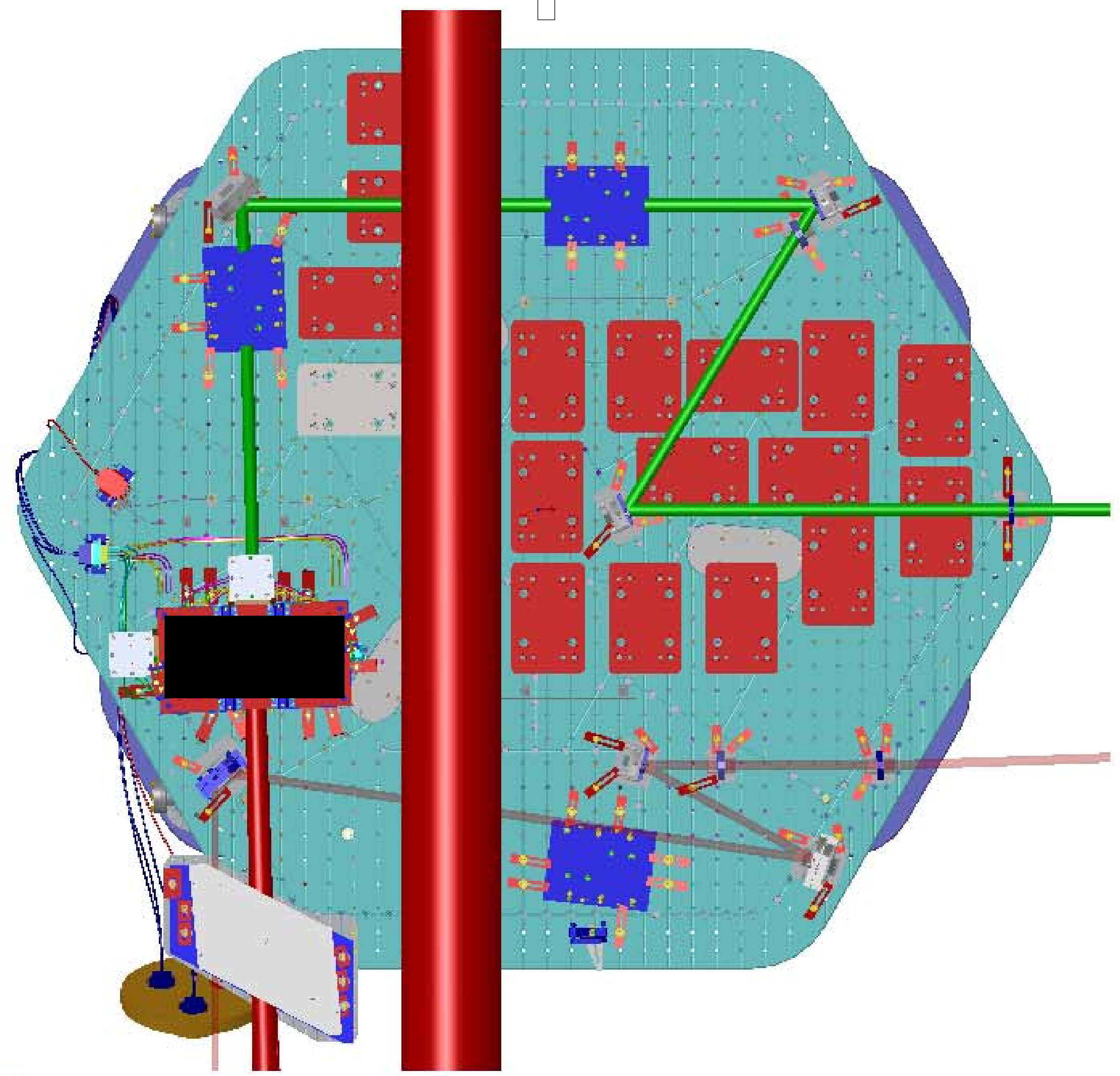

TOP VIEW

+X RIGHT

LEFT

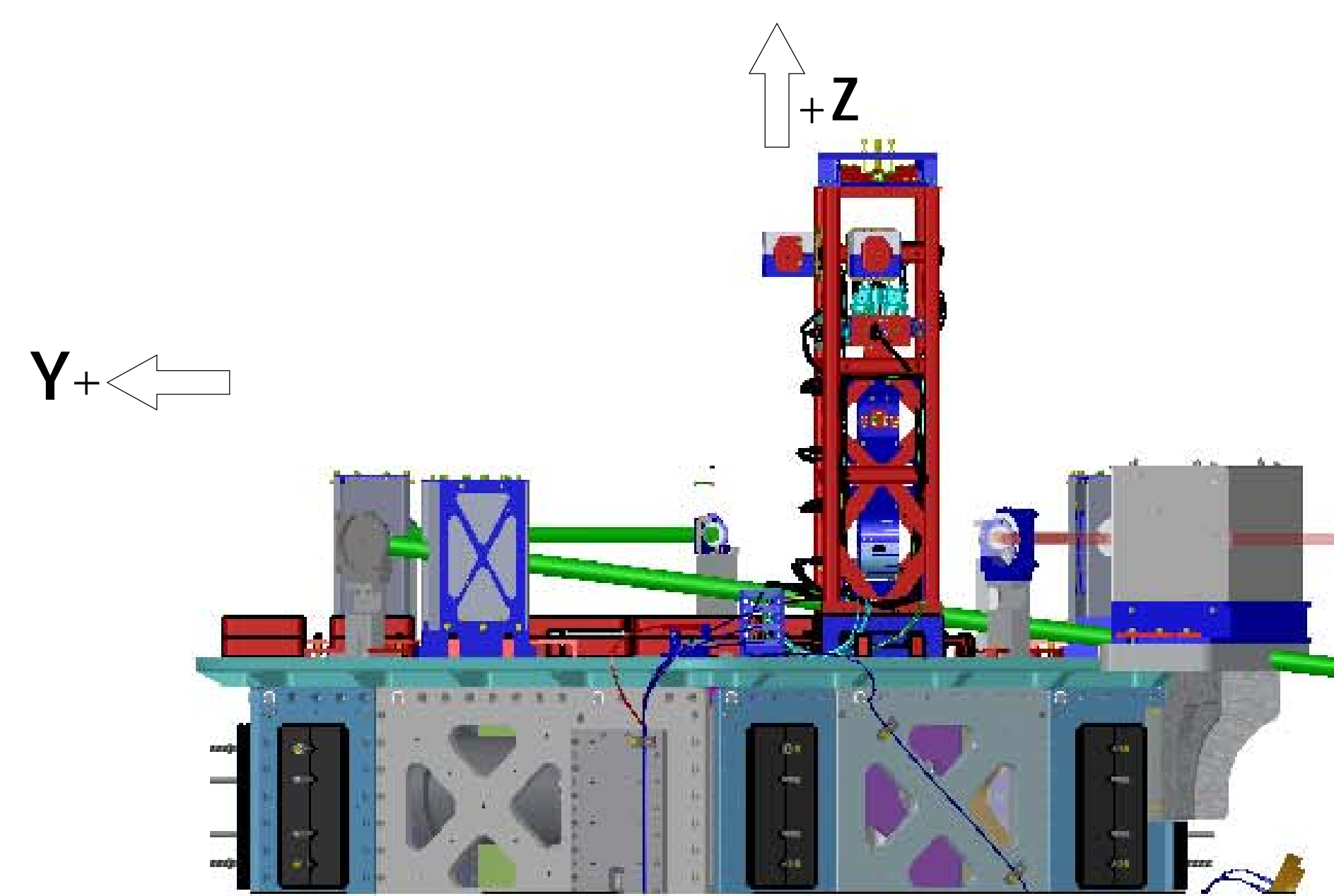

FRONT VIEW

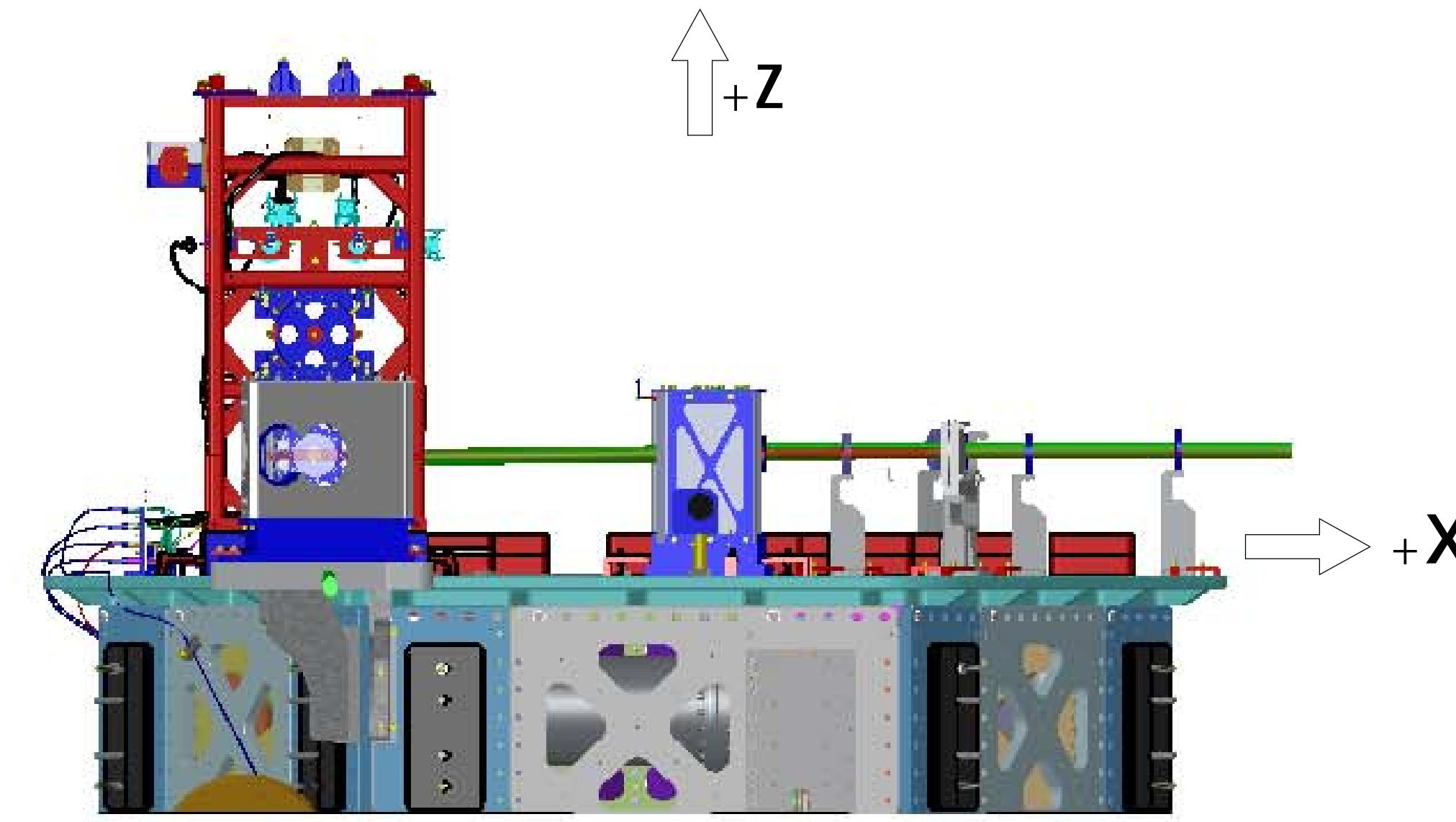

FRONT  
WHAM5

# LASER BEAMS - ORTHO VIEWS

<b>LIGO</b> CALIFORNIA INSTITUTE OF TECHNOLOGY MASSACHUSETTS INSTITUTE OF TECHNOLOGY		
SIZE	DWG. NO.	REV.
D	D0901125	v7
SCALE: 1:24	PROJECTION:	SHEET 3 OF 4

D0901125-ADM-LIGO Systems: HAMM-H1 Top Level Chamber Assembly, ALL PART PDM REV: X-066, DRAWING PDM REV: X-012

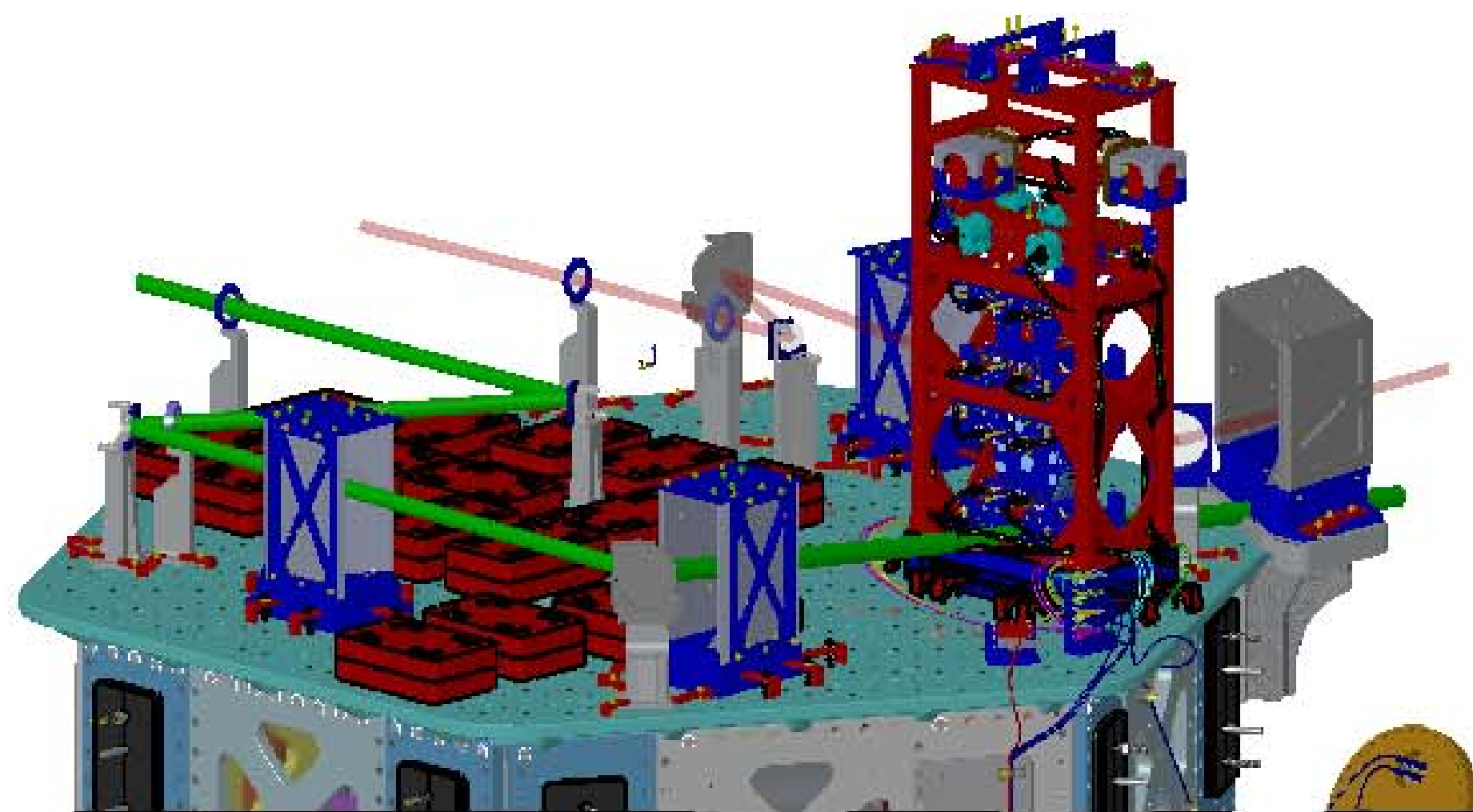

ISO REAR - LEFT

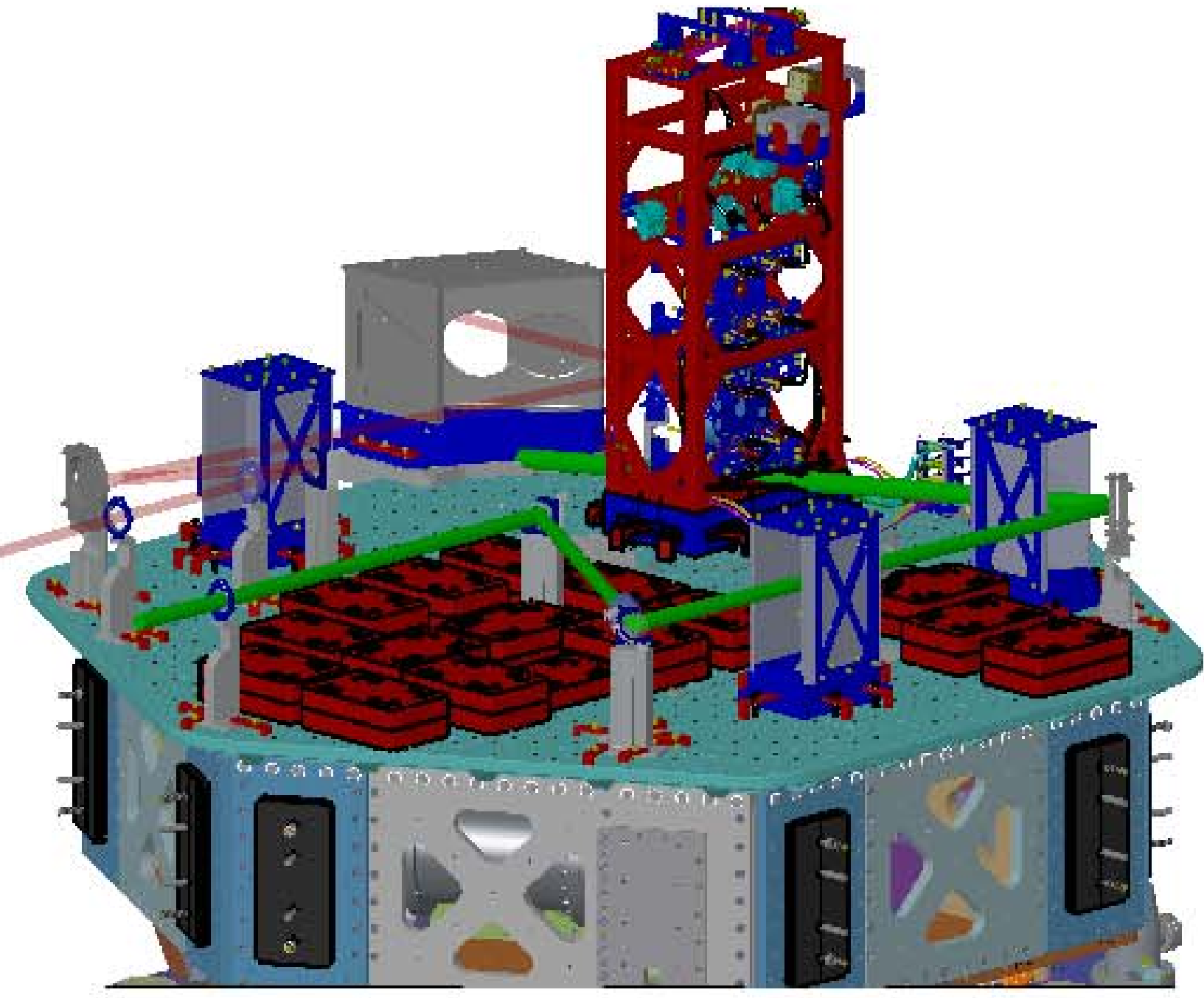

ISO REAR - RIGHT

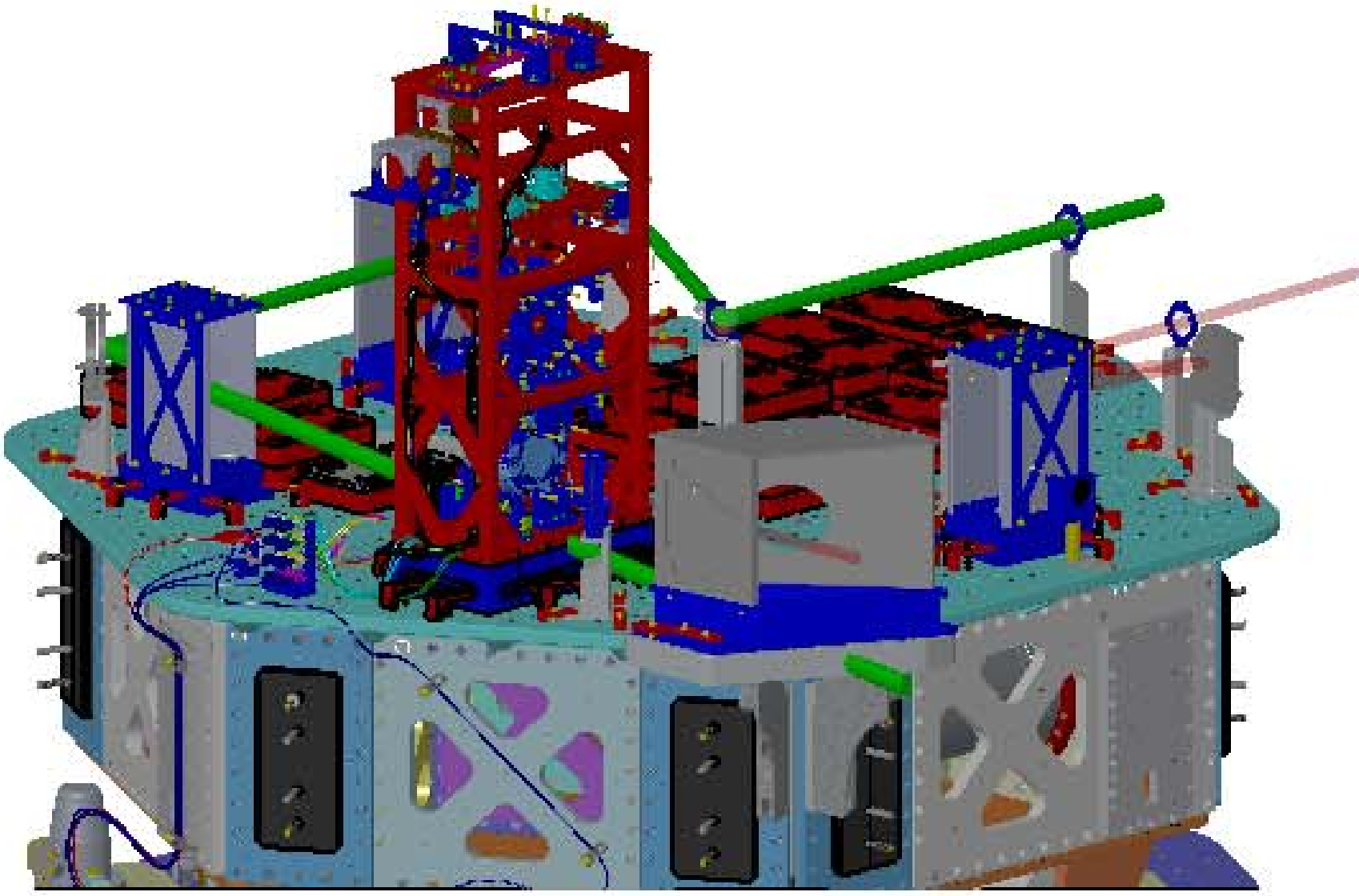

ISO FRONT - LEFT

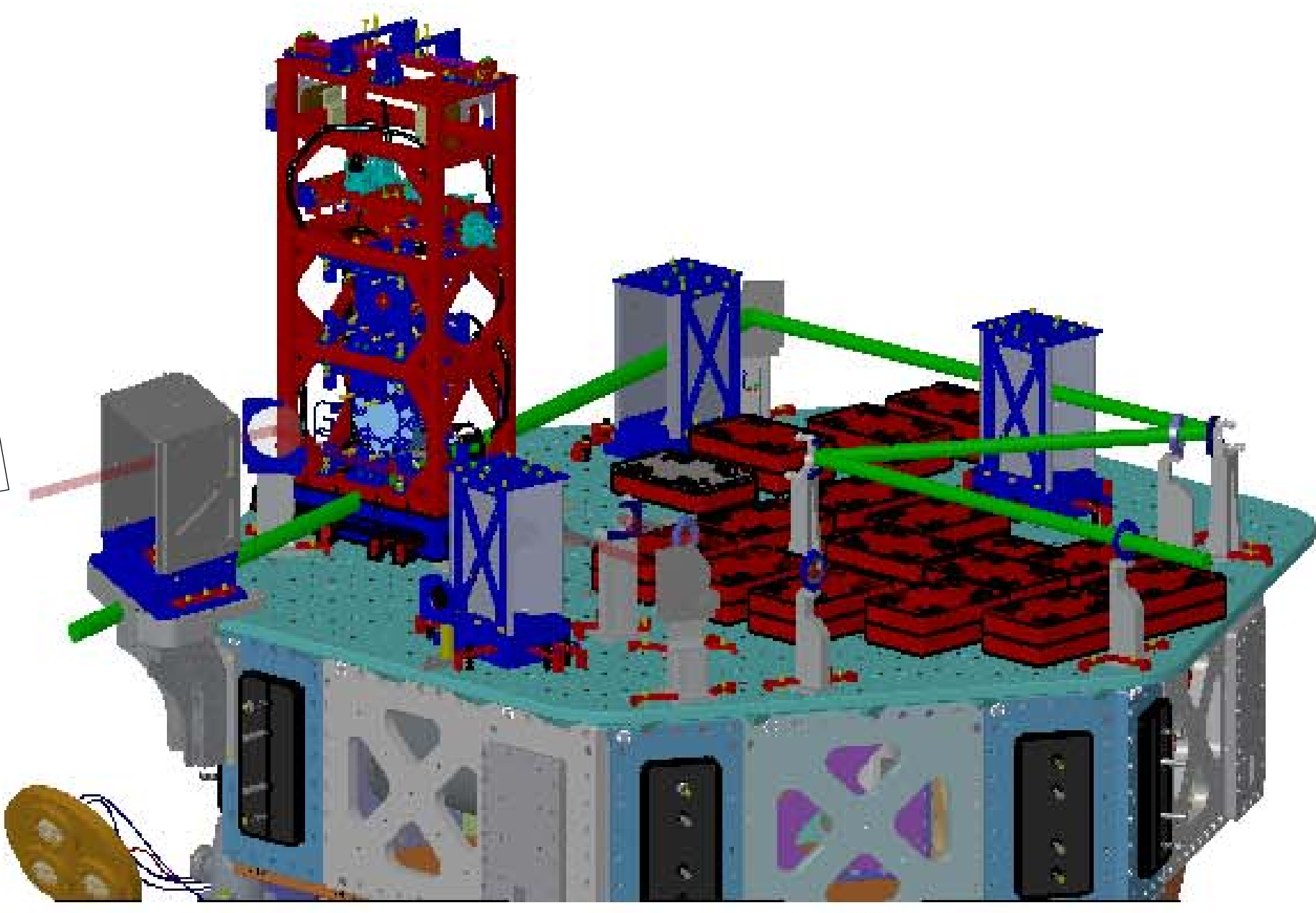

ISO FRONT - RIGHT

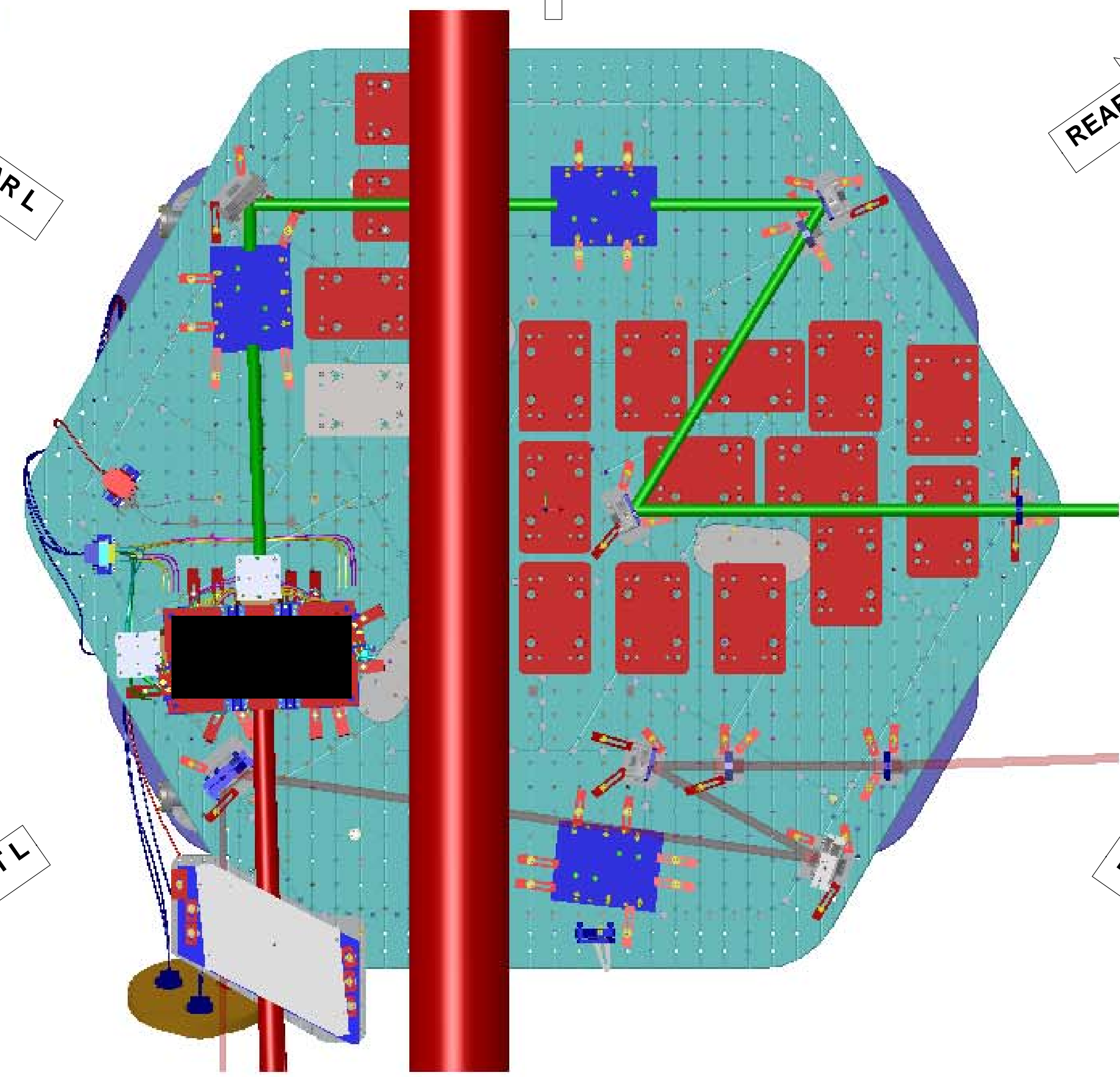

TOP VIEW

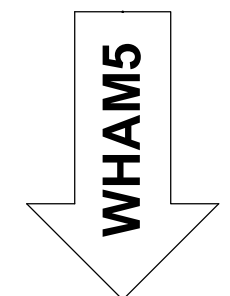
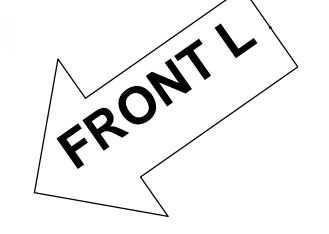
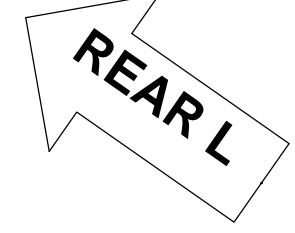
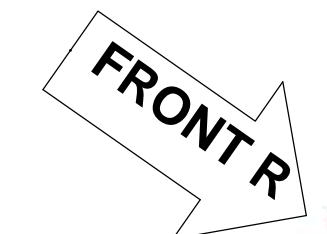
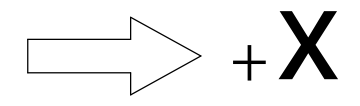
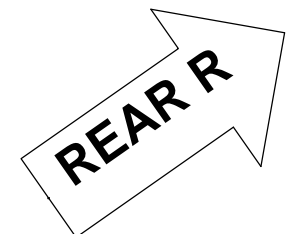
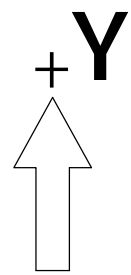
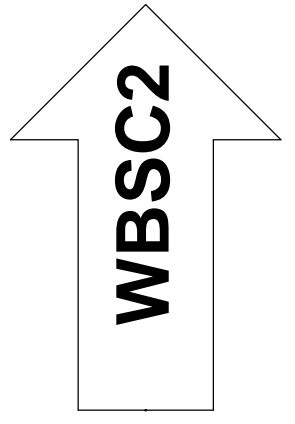

# LASER BEAMS - ISO VIEWS

<b>LIGO</b> CALIFORNIA INSTITUTE OF TECHNOLOGY MASSACHUSETTS INSTITUTE OF TECHNOLOGY		
SIZE	DWG. NO.	REV.
D	D0901125	v7
SCALE: 1:24	PROJECTION:	SHEET 4 OF 4

D0901125-ADM/LIGO Systems: HAMM-H1 Top Level Chamber Assembly, ALL PART PDM REV: X-06, DRAWING PDM REV: X-012