

REV.	DATE	DWG. #	DRAWING TREE #
v6	09 MAY 2013	E1300364-x0	
v7	30 SEP 2013	E1300716-x0	

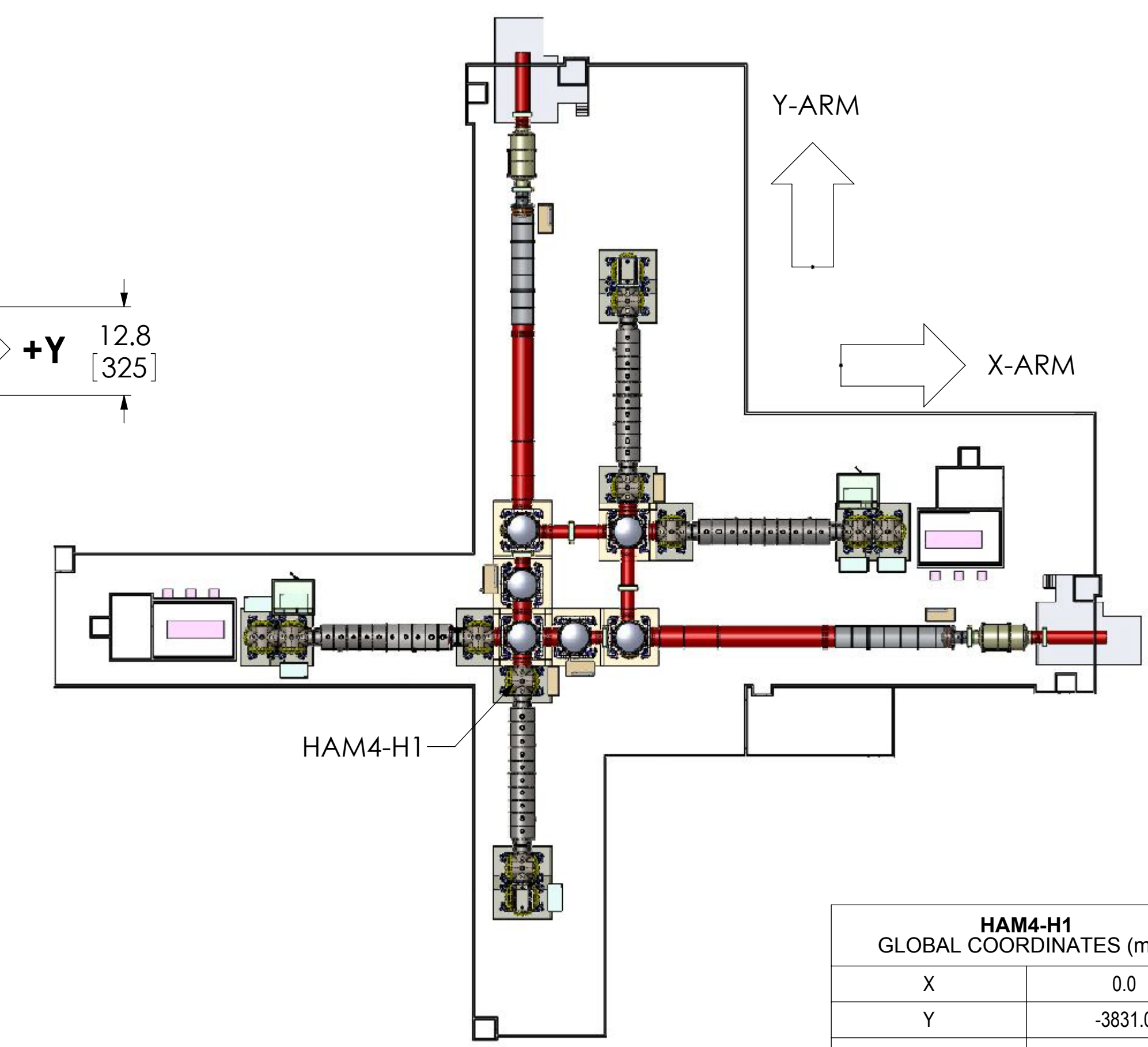

HAM4-H1 GLOBAL COORDINATES (mm)	
X	0.0
Y	-3831.0
Z	0.0

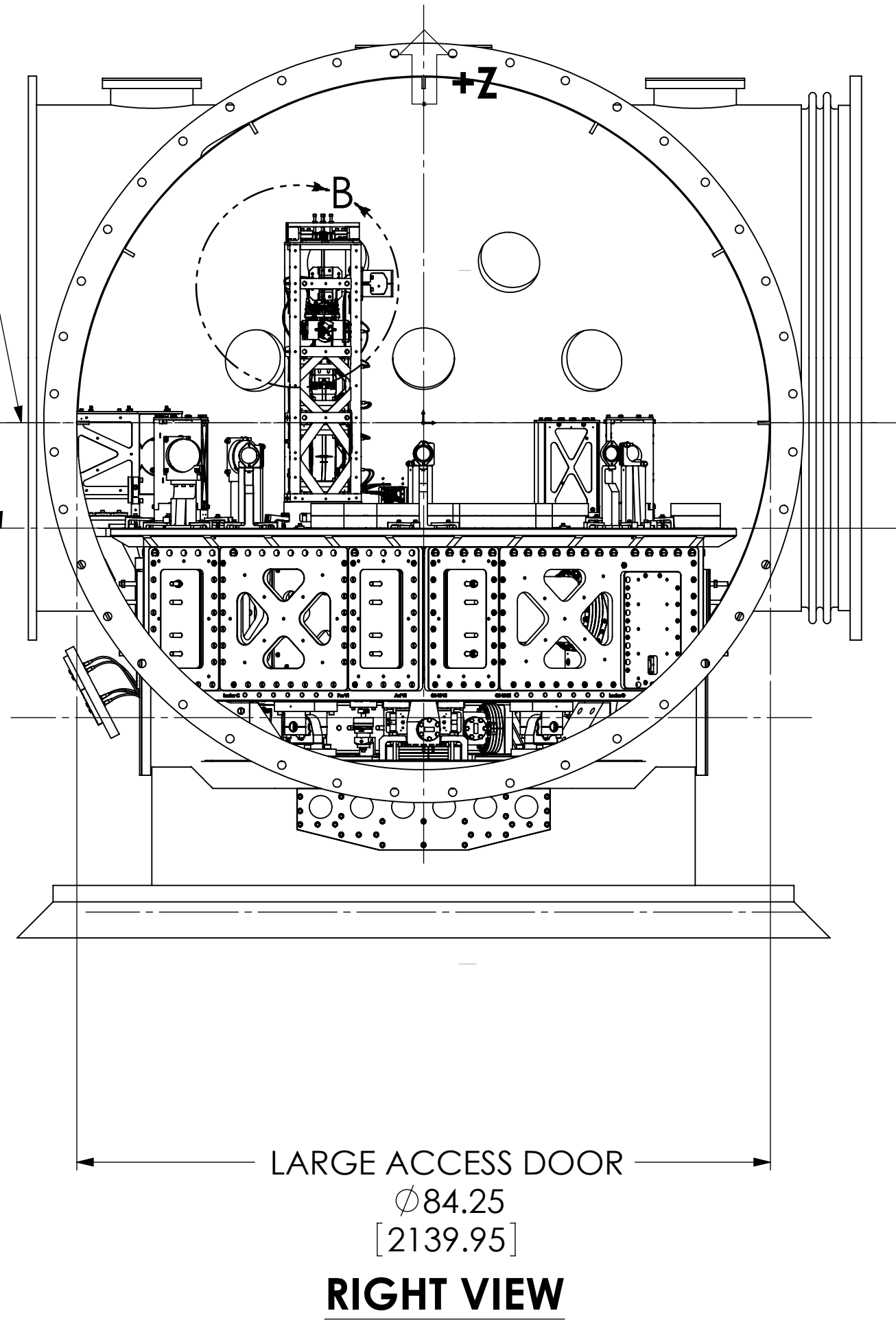
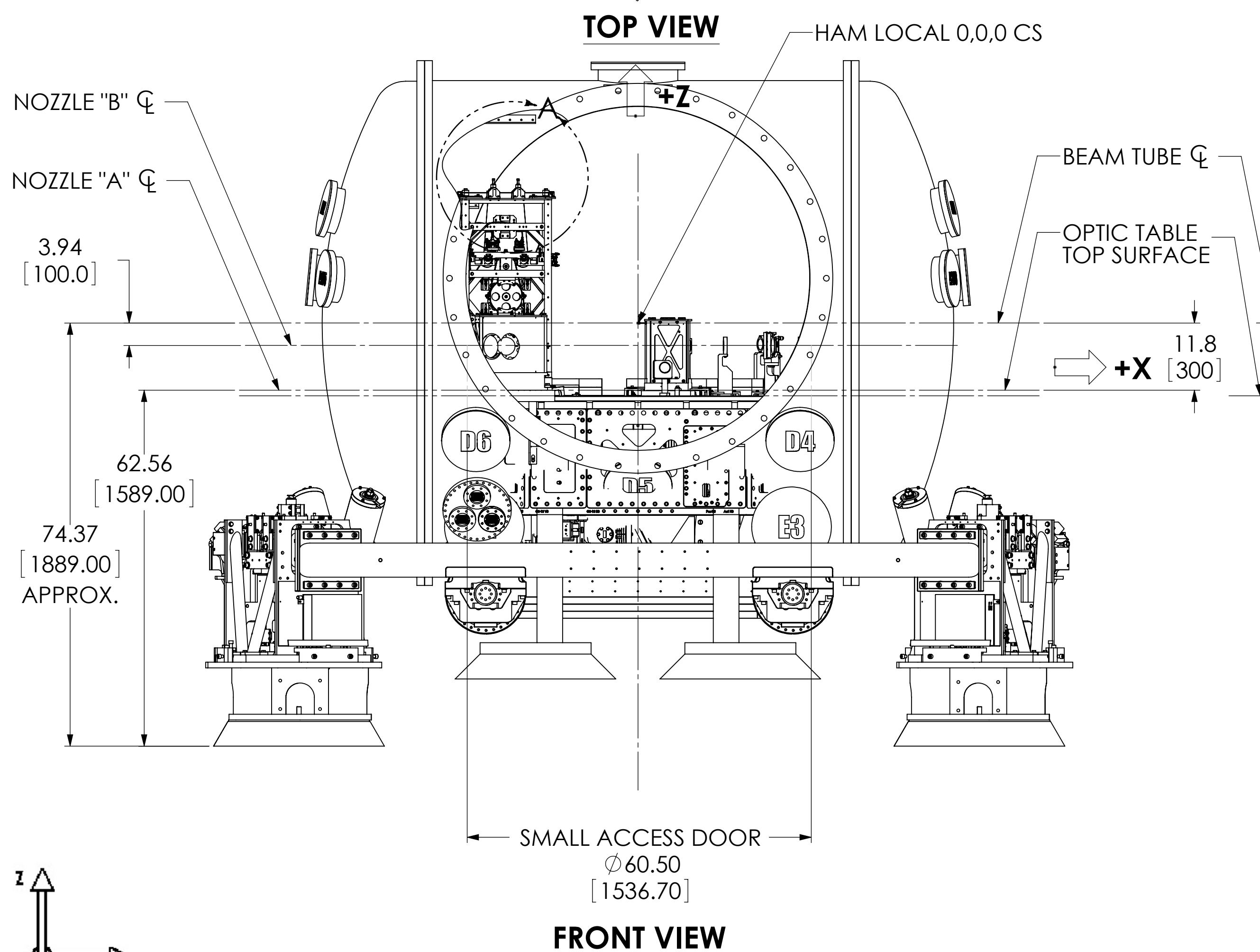
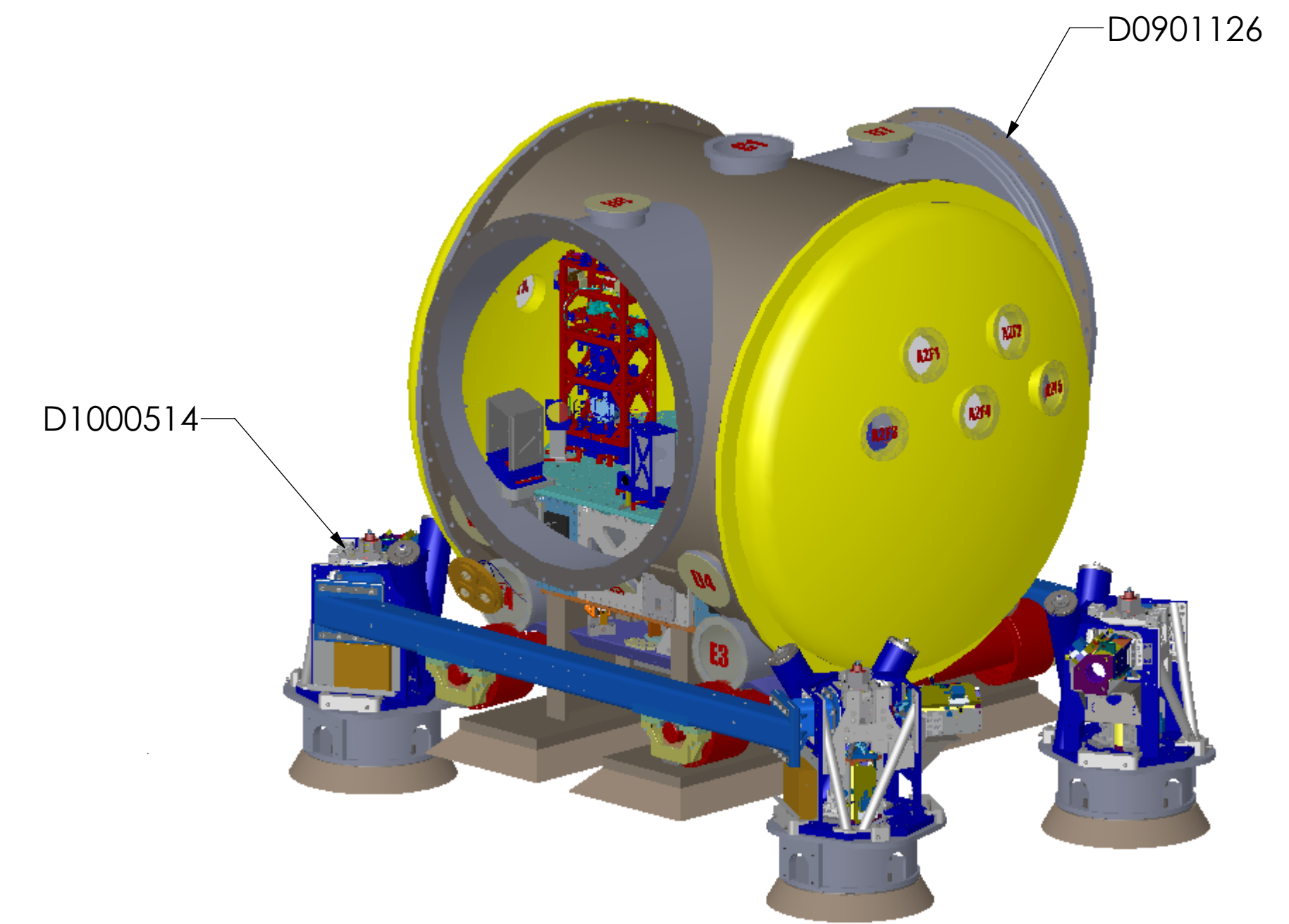
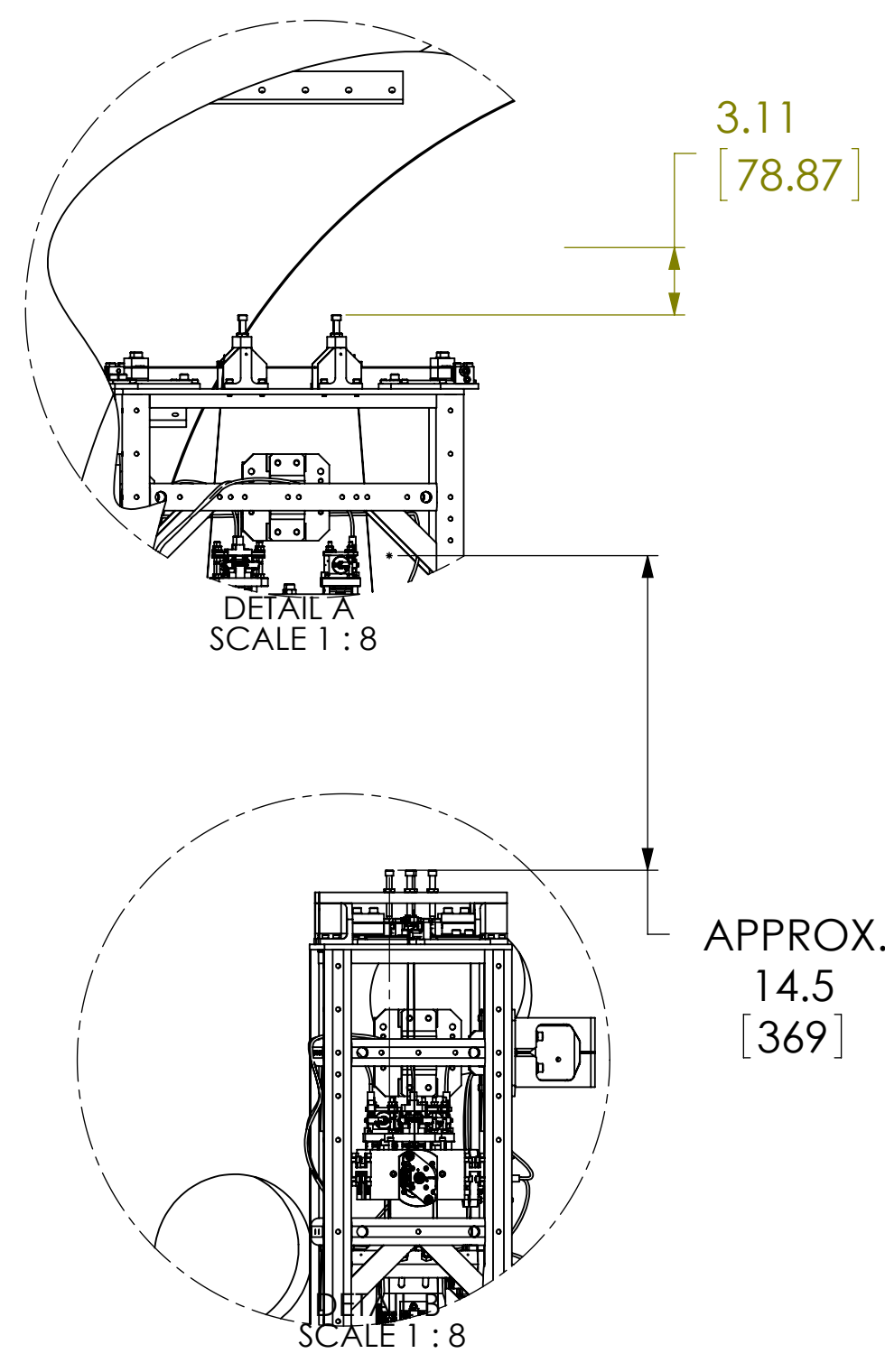
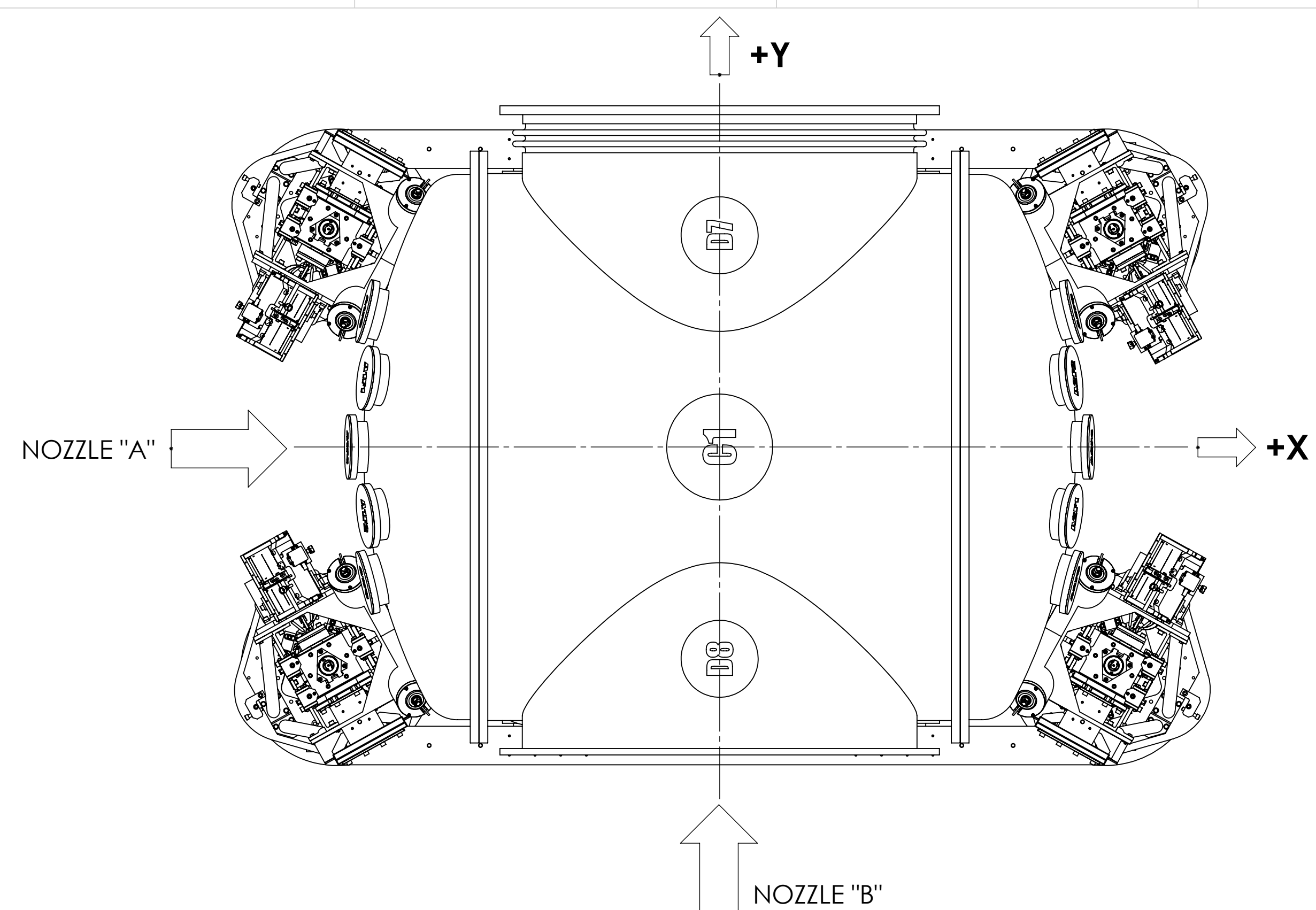

NOTES AND TOLERANCES: (UNLESS OTHERWISE SPECIFIED)

MATERIAL	FINISH	NEXT ASSY
N/A	N/A μinch	N/A

LIGO CALIFORNIA INSTITUTE OF TECHNOLOGY MASSACHUSETTS INSTITUTE OF TECHNOLOGY		PART NAME	
ADVANCED LIGO		AdvLIGO Systems, HAM4-H1 Top Level Chamber Assembly	
DESIGNER	E.SANCHEZ	SIZE	DWG. NO.
DRAFTER	03 OCT 2012	D	D0901125
CHECKER	SEE DCC	SCALE:	1:16
APPROVAL	SEE DCC	PROJECTION:	
		SHEET 1 OF 4	

D0901125 AdvLIGO Systems, HAM4-H1 Top Level Chamber Assembly, ALL PART PDM REV: X-066, DRAWING PDM REV: X-012

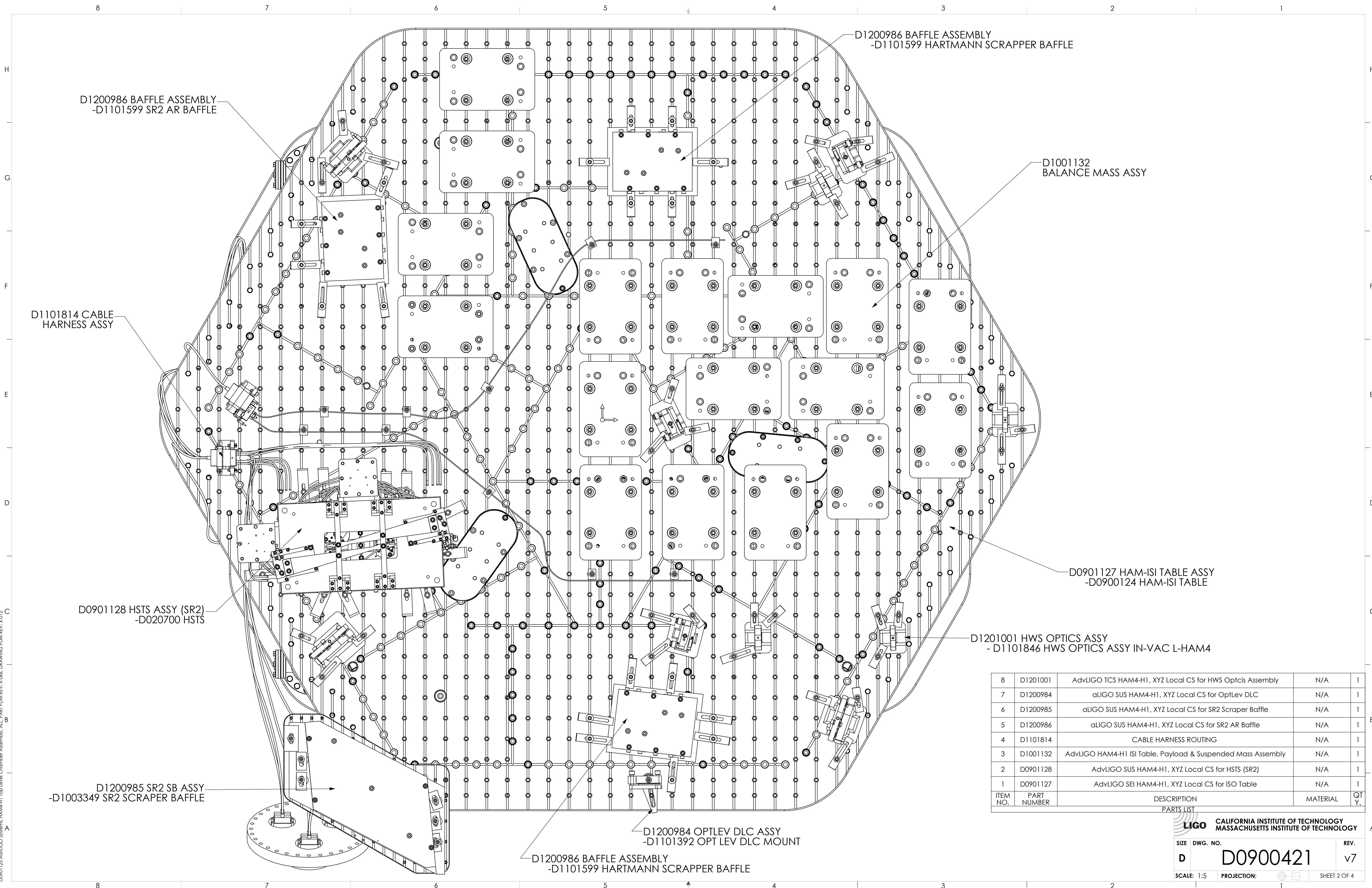

ITEM NO.	PART NUMBER	DESCRIPTION	MATERIAL	QTY.
8	D1201001	AdvLIGO TCS HAM4-H1, XYZ Local CS for HWS Optics Assembly	N/A	1
7	D1200984	aLIGO SUS HAM4-H1, XYZ Local CS for OptLev DLC	N/A	1
6	D1200985	aLIGO SUS HAM4-H1, XYZ Local CS for SR2 Scraper Baffle	N/A	1
5	D1200986	aLIGO SUS HAM4-H1, XYZ Local CS for SR2 AR Baffle	N/A	1
4	D1101814	CABLE HARNESS ROUTING	N/A	1
3	D1001132	AdvLIGO HAM4-H1 ISI Table, Payload & Suspended Mass Assembly	N/A	1
2	D0901128	AdvLIGO SUS HAM4-H1, XYZ Local CS for HSTS (SR2)	N/A	1
1	D0901127	AdvLIGO SEI HAM4-H1, XYZ Local CS for ISO Table	N/A	1

CALIFORNIA INSTITUTE OF TECHNOLOGY
MASSACHUSETTS INSTITUTE OF TECHNOLOGY

SIZE DWG. NO. **D0900421** REV. **v7**

SCALE: 1:5 PROJECTION:  SHEET 2 OF 4

D0901128 AdvLIGO Systems: HAM4-H1 Top Level Chamber Assembly, ALL PART PDM REV: X-066, DRAWING PDM REV: X-012

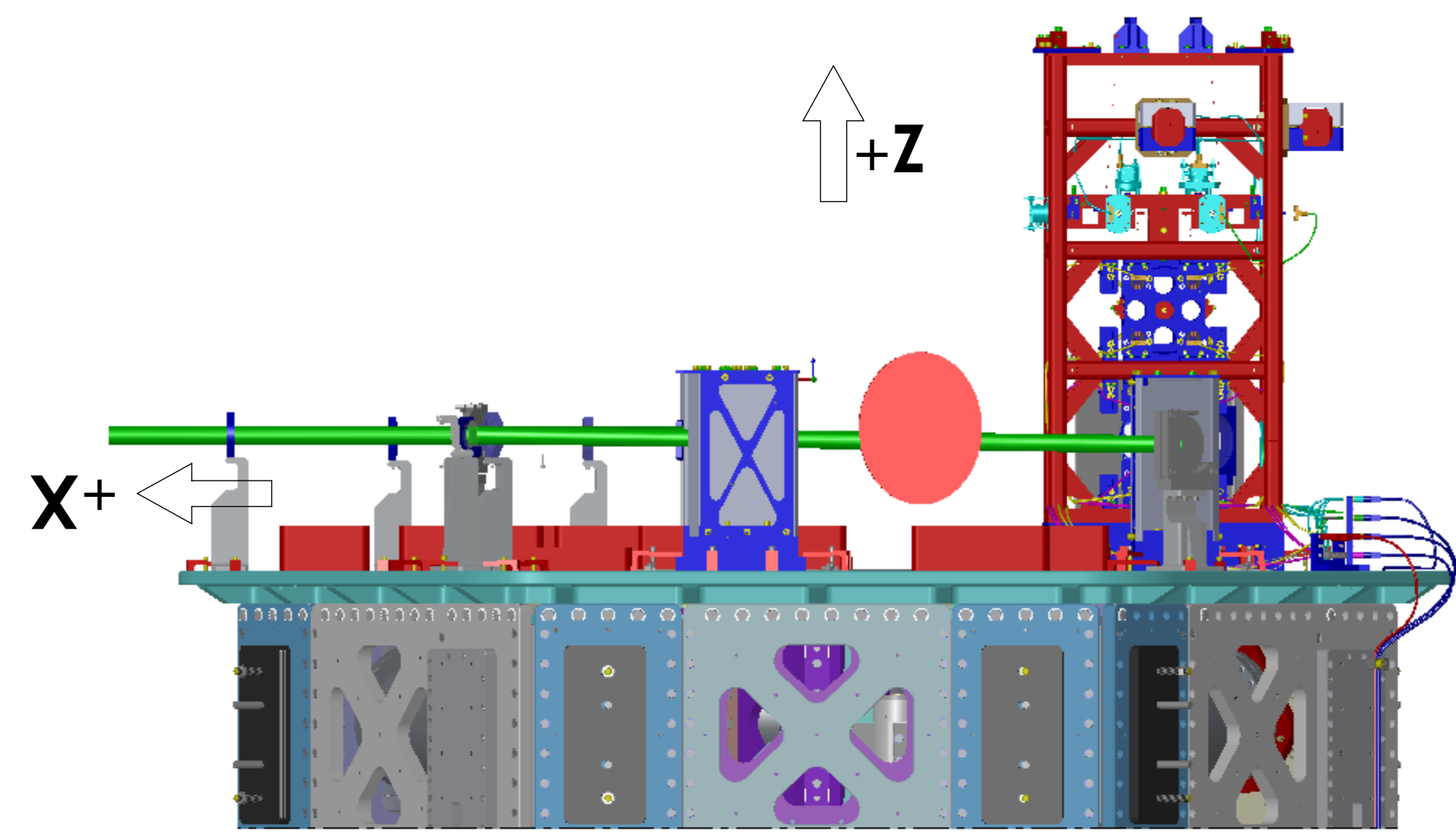

REAR VIEW
(ROTATED 180 DEGREES CCW)

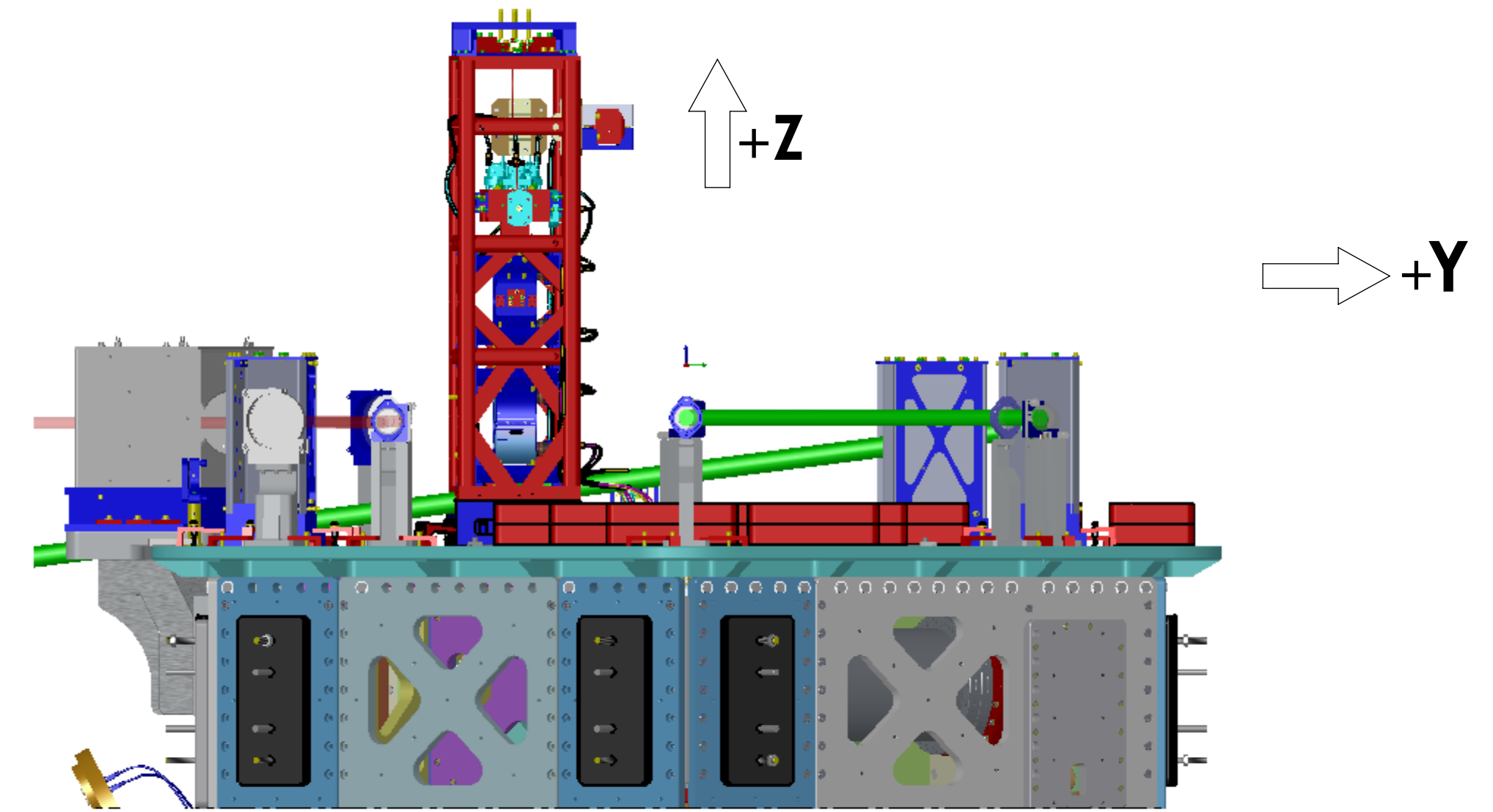

RIGHT SIDE VIEW
(ROTATED 90 DEGREES CW)

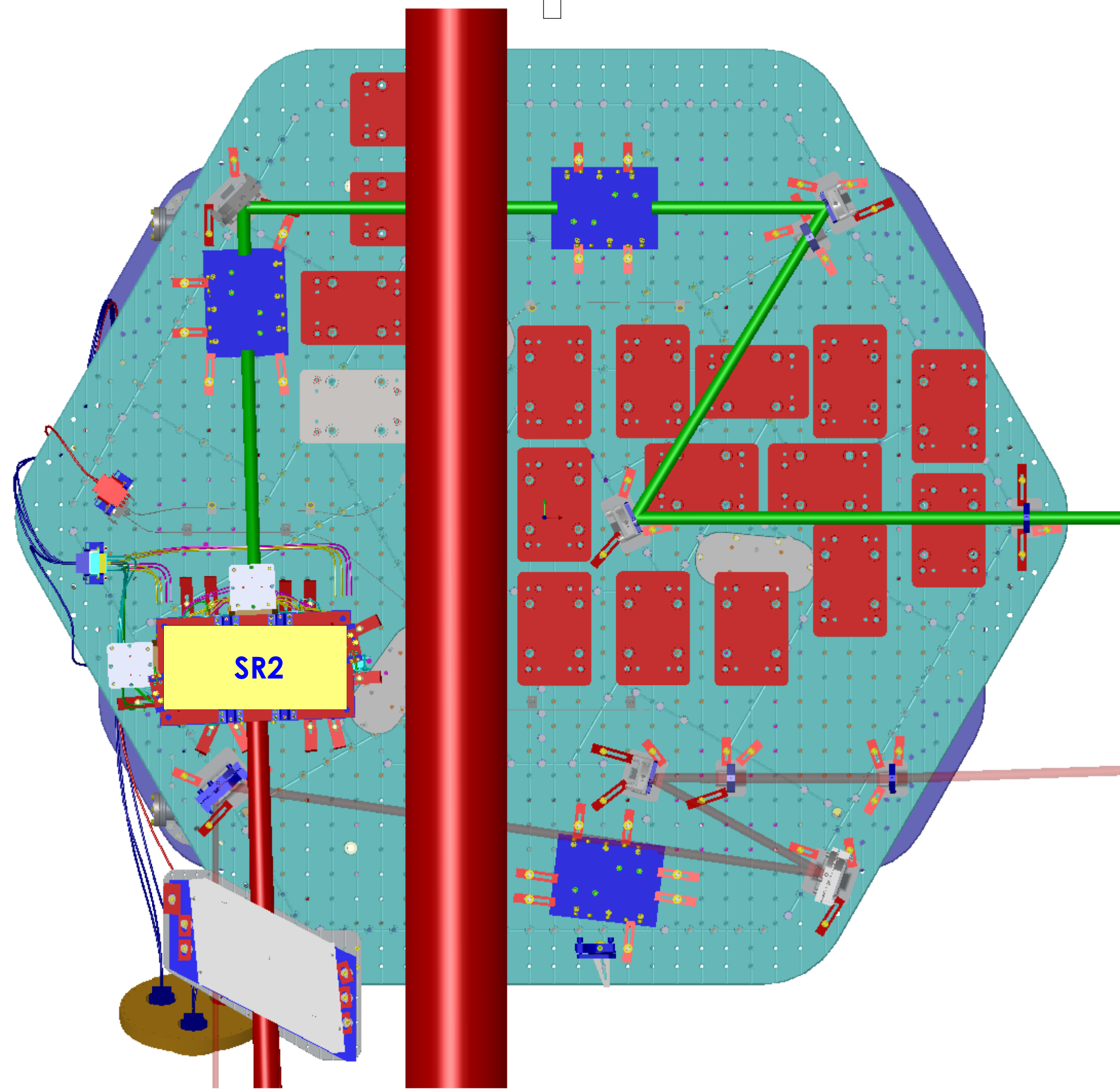

TOP VIEW

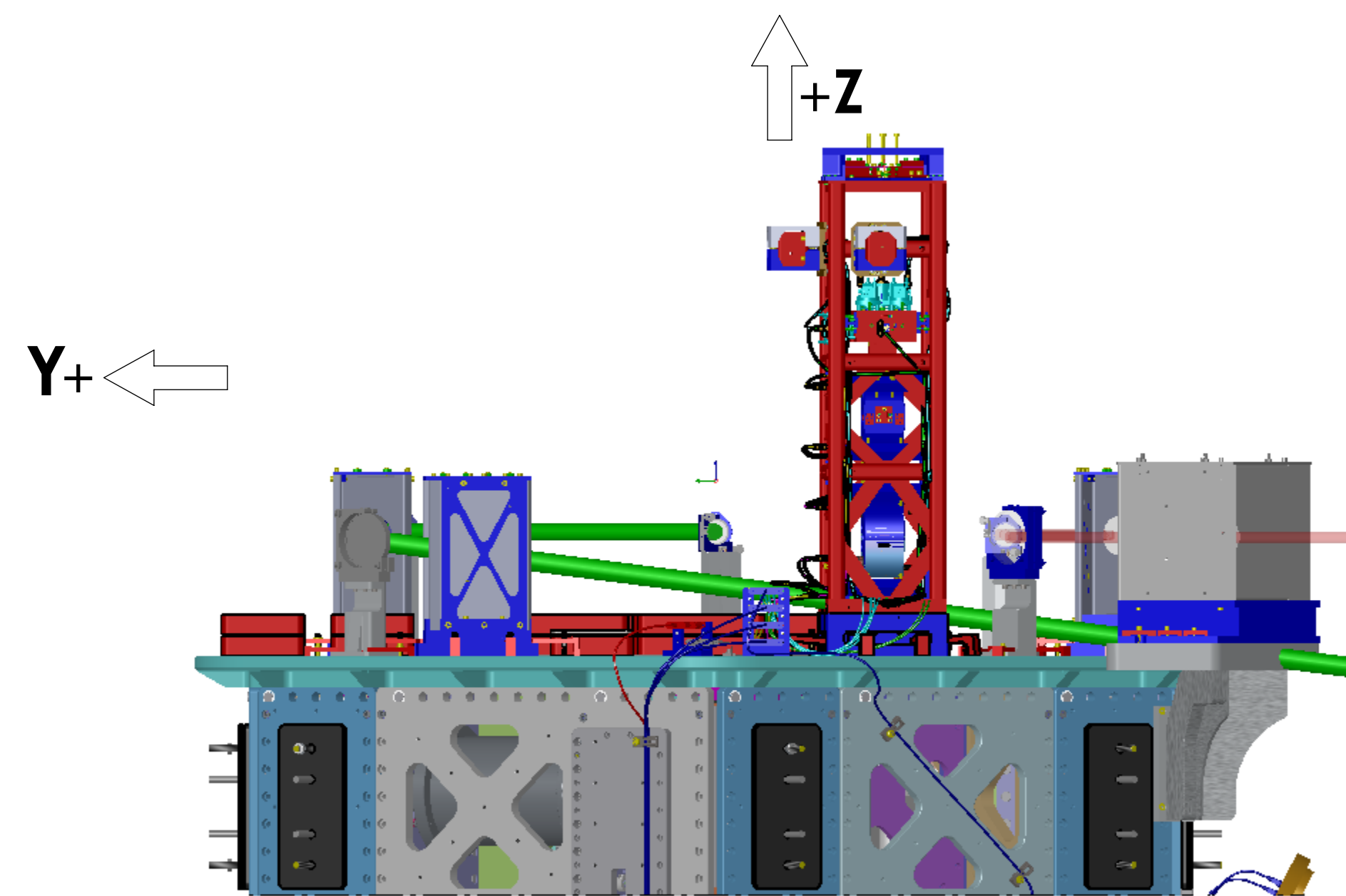
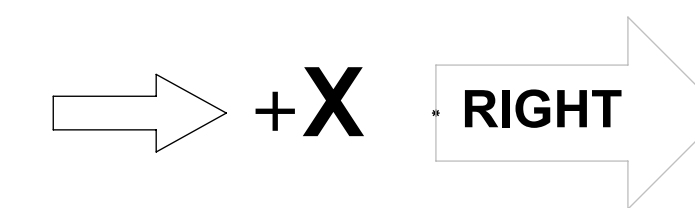

LEFT SIDE VIEW
(ROTATED 90 DEGREES CCW)

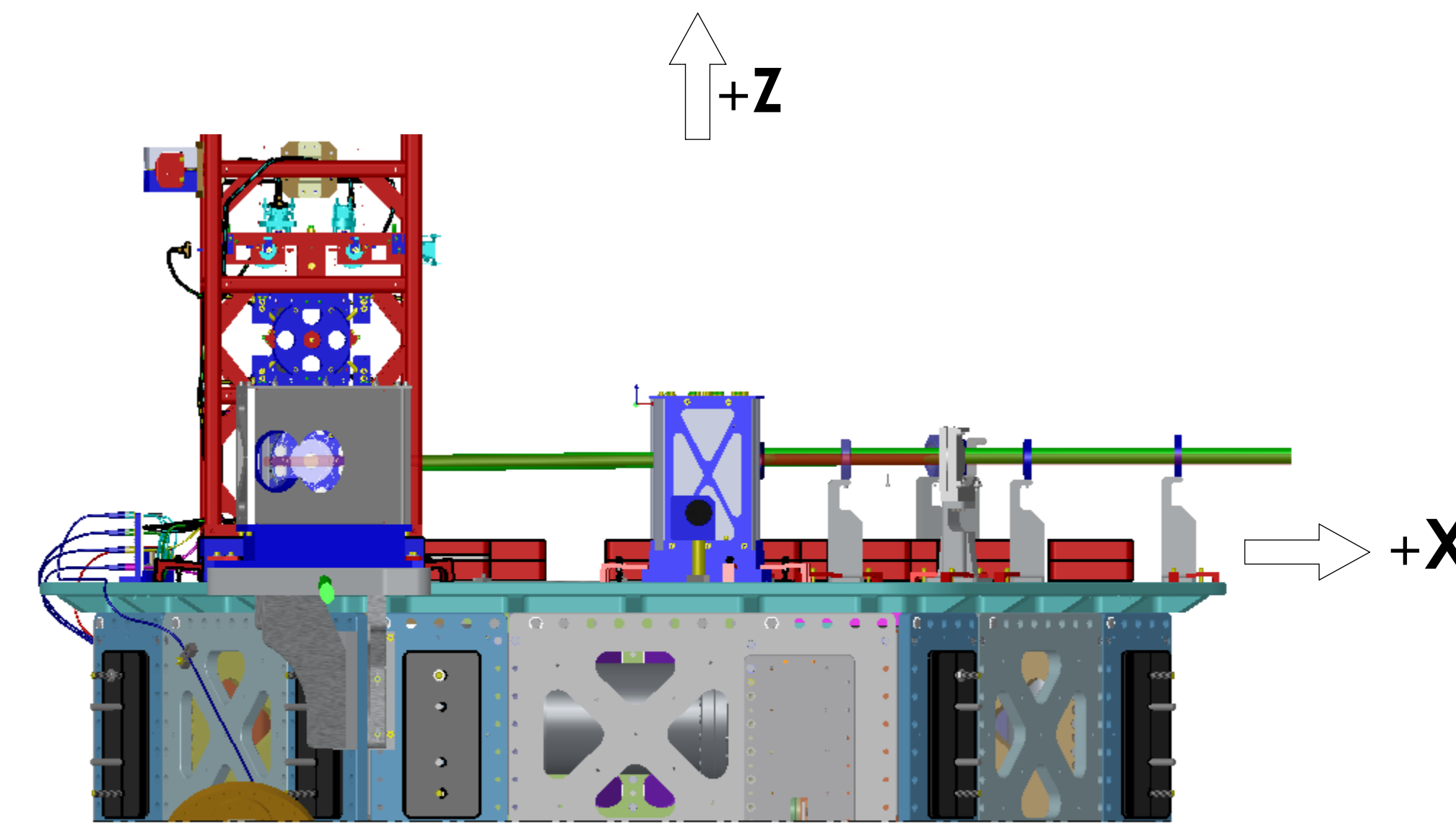

FRONT VIEW

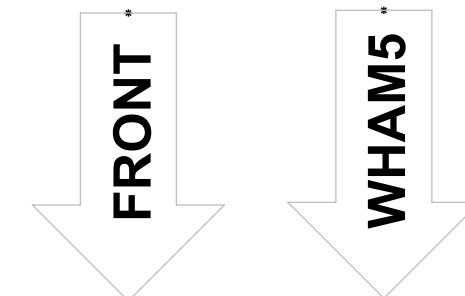

LASER BEAMS - ORTHO VIEWS

LIGO CALIFORNIA INSTITUTE OF TECHNOLOGY MASSACHUSETTS INSTITUTE OF TECHNOLOGY	
SIZE DWG. NO.	REV.
D D0901125	v7
SCALE: 1:24	PROJECTION: SHEET 3 OF 4

D0901125-Asst/LIGO Systems: HAM4-H1 Top Level Chamber Assembly, ALL PART PDM REV: X-066, DRAWING PDM REV: X-012

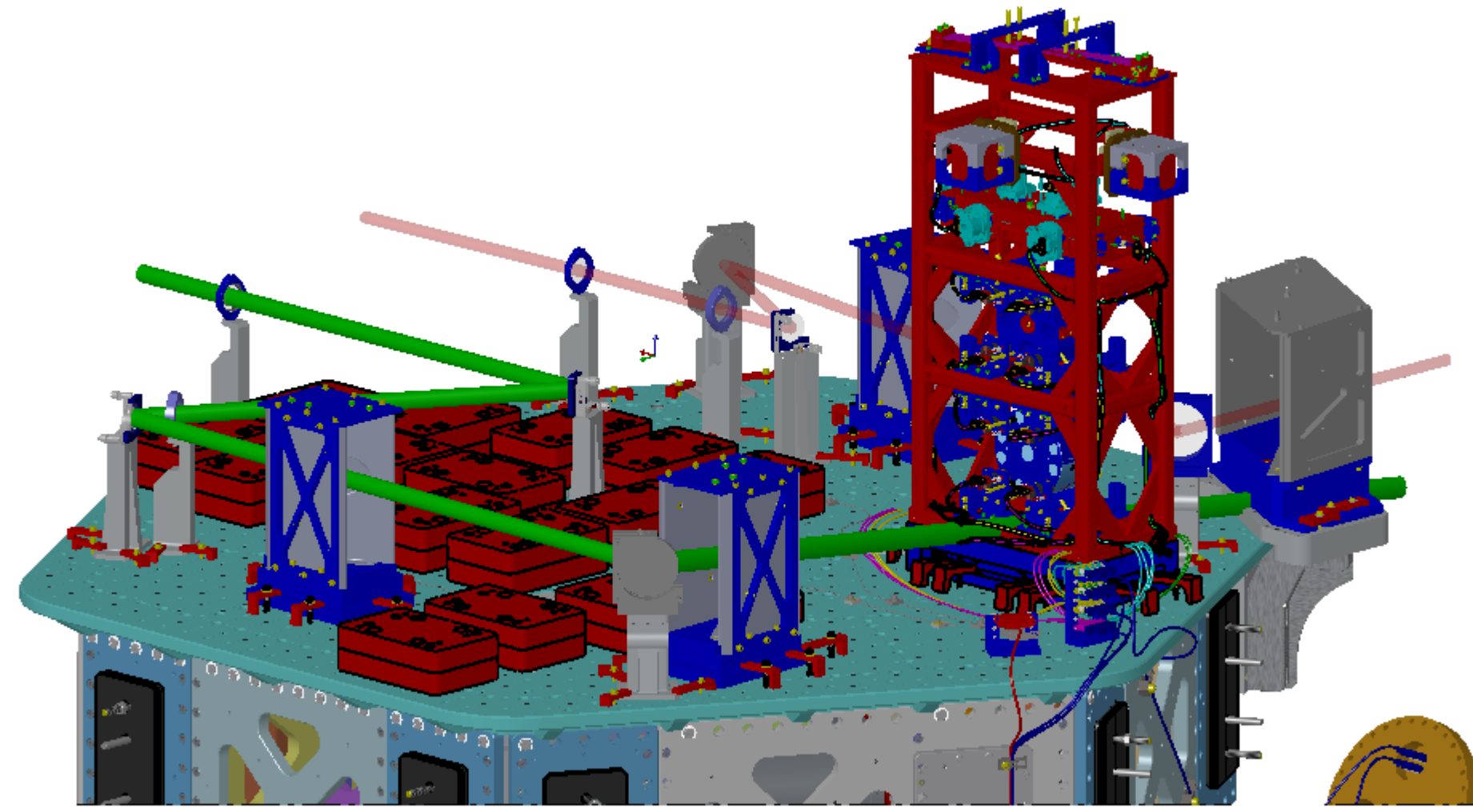

ISO REAR - LEFT

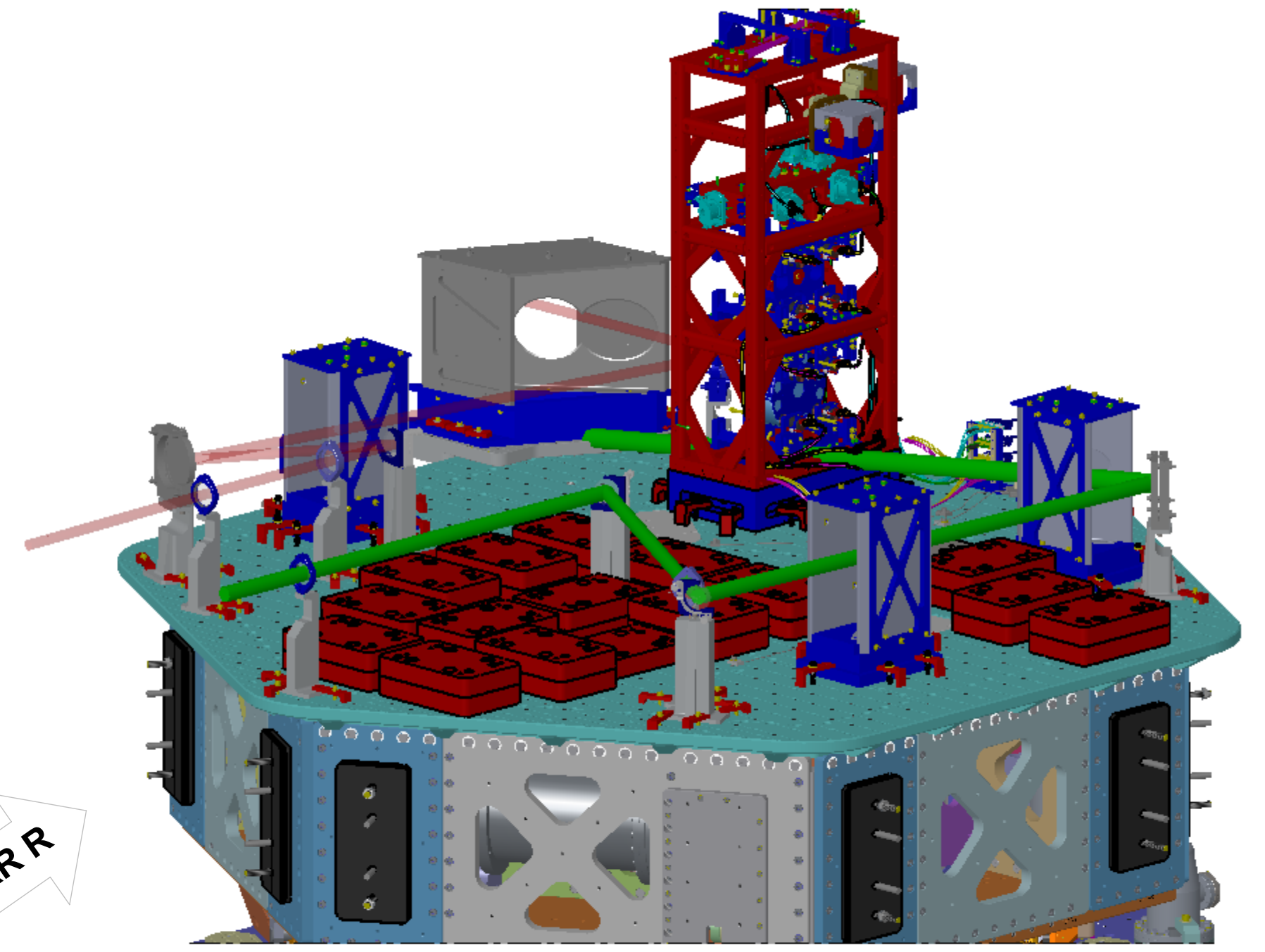

ISO REAR - RIGHT

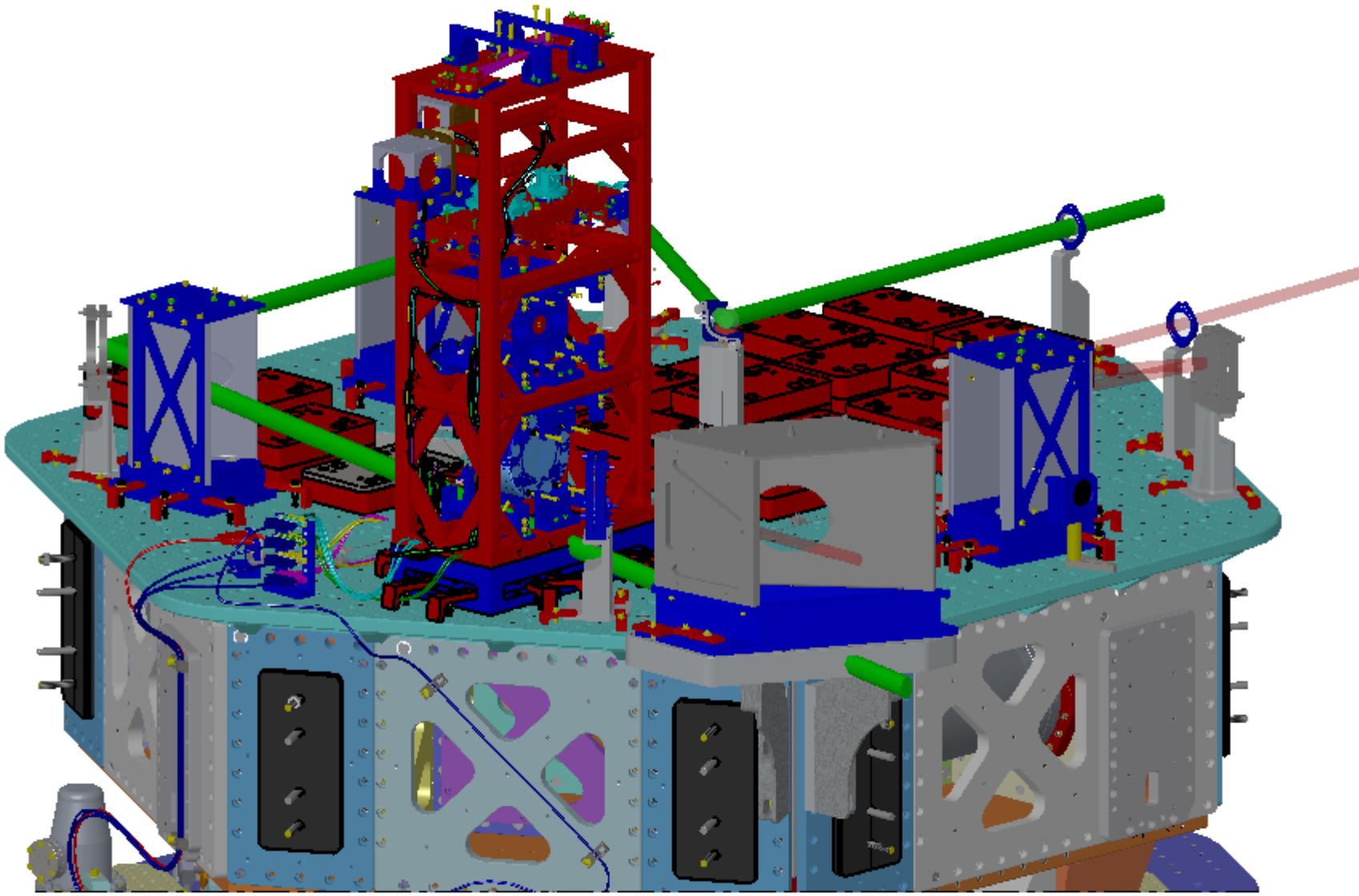

ISO FRONT - LEFT

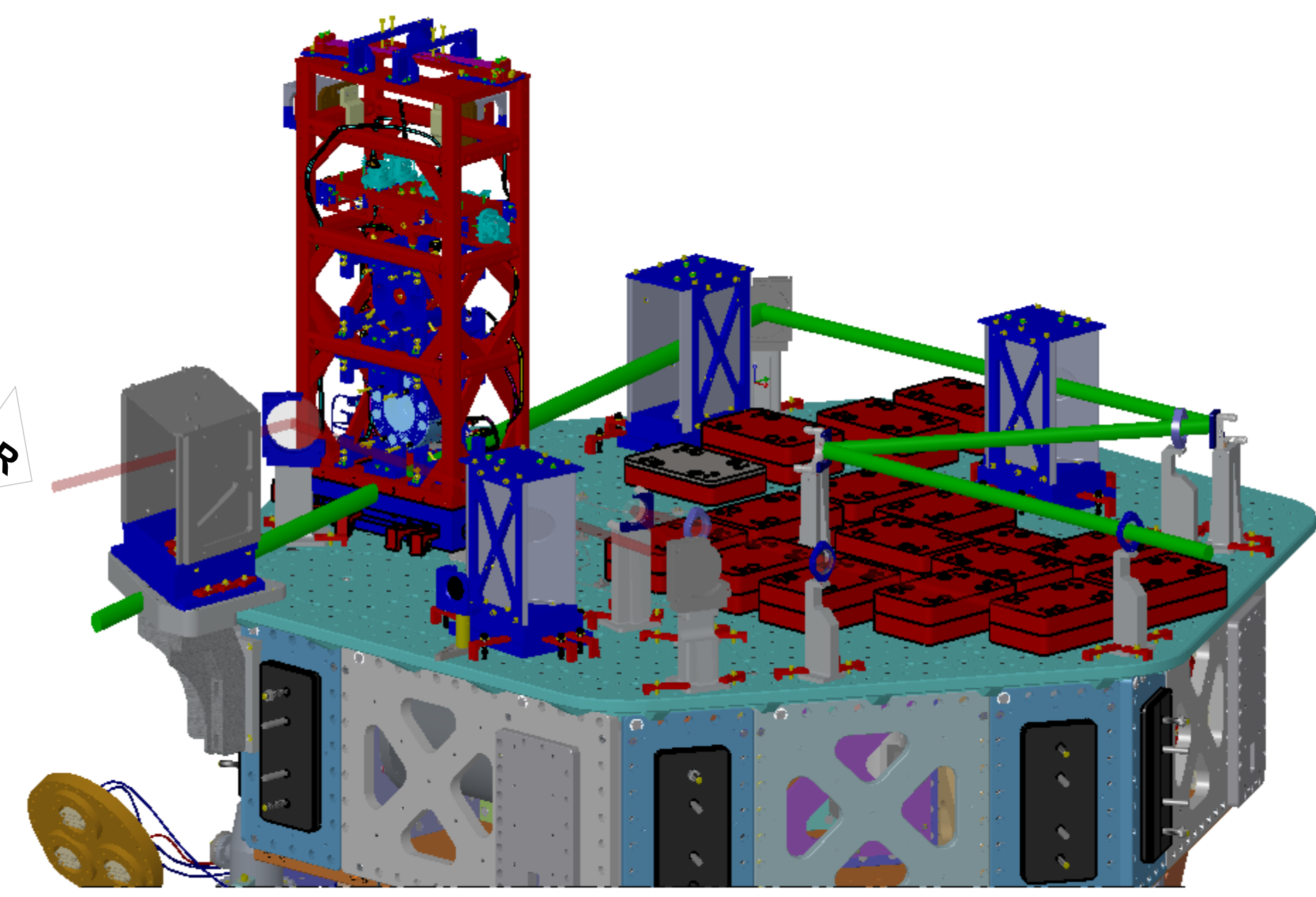

ISO FRONT - RIGHT

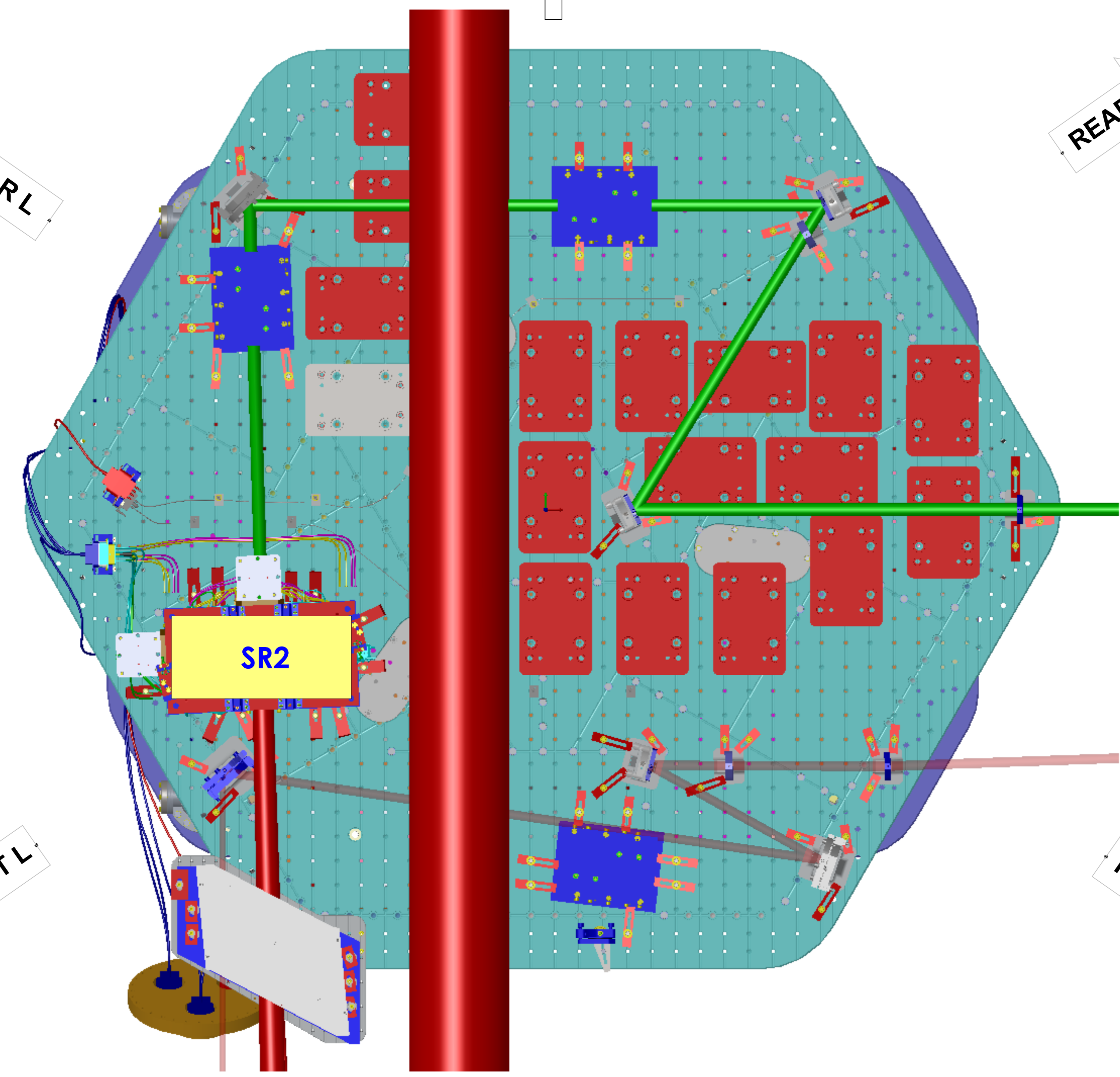

TOP VIEW

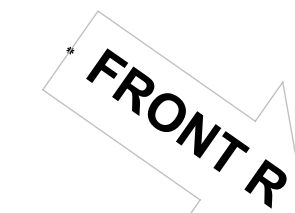
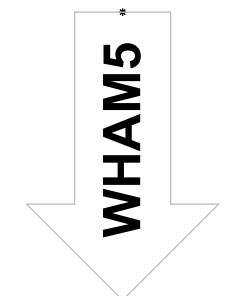
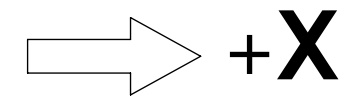
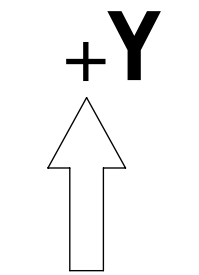
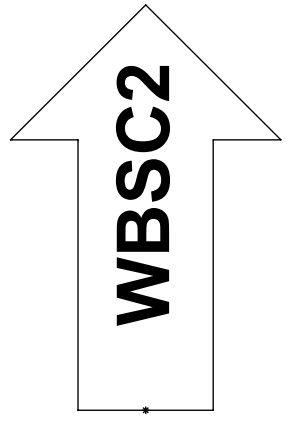

LASER BEAMS - ISO VIEWS

CALIFORNIA INSTITUTE OF TECHNOLOGY MASSACHUSETTS INSTITUTE OF TECHNOLOGY		REV.
SIZE	DWG. NO.	REV.
D	D0901125	v7
SCALE: 1:24	PROJECTION:	SHEET 4 OF 4

D0901125-Asst LIGO Systems: HAM4-H1 Top Level Chamber Assembly, ALL PART PDM REV: X-066, DRAWING PDM REV: X-012